

# TPS6280x 1.75V to 5.5V, 0.6A/1A, 2.3 $\mu$ A I<sub>Q</sub> Step-Down Converter

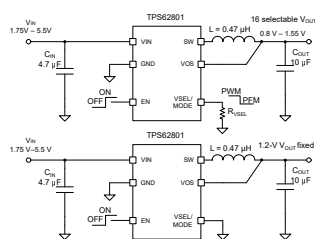
## 6-Pin, 0.35mm Pitch WCSP Package

### 1 Features

- 1.75V to 5.5V input voltage range
- 2.3 $\mu$ A operating quiescent current
- Up to 4MHz switching frequency
- 0.6A or 1A output current
- 1% output voltage accuracy
- Selectable power save and forced PWM mode
- R2D converter for flexible V<sub>OUT</sub> setting
- 16 selectable and one fixed output voltages
  - TPS62800 (4MHz): 0.4V to 0.775V
  - TPS62801 (4MHz): 0.8V to 1.55V
  - TPS62802 (4MHz): 1.8V to 3.3V
  - TPS62806 (1.5MHz): 0.4V to 0.775V
  - TPS62807 (1.5MHz): 0.8V to 1.55V
  - TPS62808 (1.5MHz): 1.8V to 3.3V
- Smart enable pin
- Optimized pinout to support 0201 components
- DCS-Control topology
- Output discharge
- 100% duty cycle operation
- Tiny 6-pin, 0.35mm pitch WCSP package
- Supports < 0.6mm design height
- Supports < 5mm<sup>2</sup> design size
- Create a custom design using the:
  - TPS62800 [WEBENCH® Power Designer](#)
  - TPS62801 [WEBENCH® Power Designer](#)
  - TPS62802 [WEBENCH® Power Designer](#)
  - TPS62806 [WEBENCH® Power Designer](#)
  - TPS62807 [WEBENCH® Power Designer](#)
  - TPS62808 [WEBENCH® Power Designer](#)

### 2 Applications

- [Wearable electronics](#), IoT applications
- 2× AA battery-powered applications
- [Smartphones](#)



Typical Application

### 3 Description

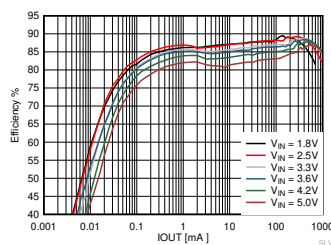
The TPS6280x device family is a step-down converter with 2.3 $\mu$ A typical quiescent current featuring the highest efficiency and smallest design size. TI's DCS-Control topology enables the device to operate with tiny inductors and capacitors with a switching frequency up to 4MHz. At light load conditions, the device seamlessly enters power save mode to reduce switching cycles and maintain high efficiency.

Connecting the VSEL/MODE pin to GND selects a fixed output voltage. With only one external resistor connected to VSEL/MODE pin, 16 internally set output voltages can be selected. An integrated R2D (resistor-to-digital) converter reads out the external resistor and sets the output voltage. The same device part number can be used for different applications and voltage rails just by changing a single resistor. Furthermore, the internally set output voltage provides better accuracy compared to a traditional external resistor divider network. After the device has started up, the DC/DC converter enters forced PWM mode by applying a high level at the VSEL/MODE pin. In this operating mode, the device runs at a typical 4MHz or 1.5MHz switching frequency, enabling lowest output voltage ripple and highest efficiency. The TPS6280x device series comes in a tiny 6-pin WCSP package with 0.35mm pitch.

#### Device Information

PART NUMBER <sup>(3)</sup>	PACKAGE <sup>(1)</sup>	PACKAGE SIZE <sup>(2)</sup>
TPS62800	YKA (DSBGA, 6)	1.05 mm × 0.70 mm
TPS62801		
TPS62802		
TPS62806		
TPS62807		

- (1) For more information, see [Section 11](#).
- (2) The package size (length × width) is a nominal value and includes pins, where applicable.
- (3) See the [Device Comparison Table](#).



Efficiency Versus I<sub>OUT</sub> at 1.2V<sub>OUT</sub>



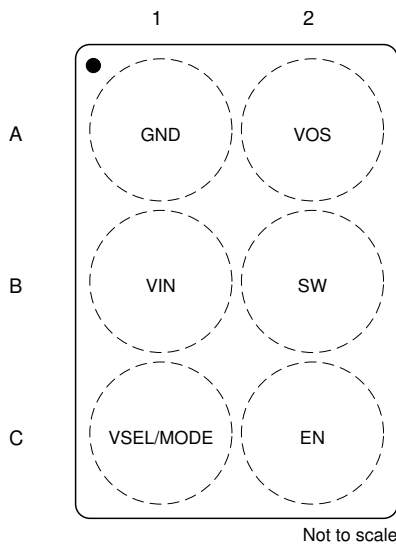
## Table of Contents

<b>1 Features</b> .....	1	<b>8 Application and Implementation</b> .....	15
<b>2 Applications</b> .....	1	8.1 Application Information.....	15
<b>3 Description</b> .....	1	8.2 Typical Application.....	15
<b>4 Device Comparison Table</b> .....	3	8.3 System Examples.....	27
<b>5 Pin Configuration and Functions</b> .....	3	8.4 Power Supply Recommendations.....	28
<b>6 Specifications</b> .....	5	8.5 Layout.....	28
6.1 Absolute Maximum Ratings.....	5	<b>9 Device and Documentation Support</b> .....	30
6.2 ESD Ratings.....	5	9.1 Device Support.....	30
6.3 Recommended Operating Conditions.....	5	9.2 Receiving Notification of Documentation Updates....	30
6.4 Thermal Information.....	6	9.3 Support Resources.....	30
6.5 Electrical Characteristics.....	6	9.4 Trademarks.....	30
6.6 Typical Characteristics.....	8	9.5 Electrostatic Discharge Caution.....	31
<b>7 Detailed Description</b> .....	10	9.6 Glossary.....	31
7.1 Overview.....	10	<b>10 Revision History</b> .....	31
7.2 Functional Block Diagram.....	10	<b>11 Mechanical, Packaging, and Orderable Information</b> .....	31
7.3 Feature Description.....	10	11.1 Mechanical Data.....	32
7.4 Device Functional Modes.....	13		

## 4 Device Comparison Table

Device	Function VSEL/MODE	Fixed V <sub>OUT</sub>	Selectable Output Voltages with R <sub>VSEL</sub>	f <sub>sw</sub> [MHz]	I <sub>OUT</sub> [A]	Soft Start, t <sub>SS</sub>	Output Discharge
TPS62800	VSEL + MODE	0.7 V (VSEL / MODE = GND)	0.4 V–0.775 V in 25-mV steps	4	1	125 μs	Yes
TPS62801	VSEL + MODE	1.20 V (VSEL / MODE = GND)	0.8 V–1.55 V in 50-mV steps	4	1	125 μs	Yes
TPS62802	VSEL + MODE	1.8 V (VSEL / MODE = GND)	1.8 V–3.3 V in 100-mV steps	4	1	400 μs	Yes
TPS62806	VSEL + MODE	0.7 V (VSEL / MODE = GND)	0.4 V–0.775 V in 25-mV steps	1.5	0.6	125 μs	Yes
TPS62807	VSEL + MODE	1.20 V (VSEL / MODE = GND)	0.8 V–1.55 V in 50-mV steps	1.5	0.6	125 μs	Yes
TPS62808	VSEL + MODE	1.8 V (VSEL / MODE = GND)	1.8 V–3.3 V in 100-mV steps	1.5	0.6	125 μs	Yes

## 5 Pin Configuration and Functions



**Figure 5-1. 6-Pin DSBGA YKA Package (Top View)**

**Table 5-1. Pin Functions**

Pin		TYPE	Description
Name	NO.		
GND	A1	PWR	GND supply pin. Connect this pin close to the GND terminal of the input and output capacitor.
VIN	B1	PWR	V <sub>IN</sub> power supply pin. Connect the input capacitor close to this pin for best noise and voltage spike suppression. A ceramic capacitor is required.
VSEL/MODE	C1	IN	Connecting a resistor to GND selects a pre-defined output voltage. After the device has started up, the R2D converter is disabled and the pin operates as an input. Applying a high level selects forced PWM mode operation and a low level power save mode operation.
VOS	A2	IN	Output voltage sense pin for the internal feedback divider network and regulation loop. This pin also discharges V <sub>OUT</sub> by an internal MOSFET when the converter is disabled. Connect this pin directly to the output capacitor with a short trace.
SW	B2	OUT	The switch pin is connected to the internal MOSFET switches. Connect the inductor to this terminal.
EN	C2	IN	A high level enables the devices, and a low level turns the device off. The pin features an internal pull-down resistor, which is disabled after the device has started up.

**Table 5-2. Output Voltage Setting (VSEL/MODE Pin)**

VSEL	Output Voltage Setting $V_{OUT}$ [V]			$R_{VSEL}$ Resistance [k $\Omega$ ], E96 Resistor Series, 1% Accuracy, Temperature Coefficient Better or Equal than $\pm 200$ ppm/ $^{\circ}$ C
	TPS62800 TPS62806	TPS62801 TPS62807	TPS62802 TPS62808	
0	0.700	1.2	1.8	Connected to GND (no resistor needed)
1	0.400	0.8	1.8	10.0
2	0.425	0.85	1.9	12.1
3	0.450	0.9	2.0	15.4
4	0.475	0.95	2.1	18.7
5	0.500	1.0	2.2	23.7
6	0.525	1.05	2.3	28.7
7	0.550	1.1	2.4	36.5
8	0.575	1.15	2.5	44.2
9	0.600	1.2	2.6	56.2
10	0.625	1.25	2.7	68.1
11	0.650	1.3	2.8	86.6
12	0.675	1.35	2.9	105.0
13	0.700	1.4	3.0	133.0
14	0.725	1.45	3.1	162.0
15	0.750	1.5	3.2	205.0
16	0.775	1.55	3.3	249.0 or larger

## 6 Specifications

### 6.1 Absolute Maximum Ratings

		MIN <sup>(1)</sup>	MAX <sup>(1)</sup>	UNIT
Pin voltage <sup>(2)</sup>	V <sub>IN</sub>	-0.3	6	V
	SW	-0.3	V <sub>IN</sub> + 0.3 V	V
	SW (AC), less than 10 ns while switching	-2.5	9	V
	EN, VSEL/MODE	-0.3	6	V
	VOS	-0.3	5	V
Operating junction temperature, T <sub>J</sub>		-40	150	°C
Storage temperature, T <sub>stg</sub>		-65	150	°C

- (1) Stresses beyond those listed under *absolute maximum ratings* may cause permanent damage to the device. These are stress ratings only and functional operation of the device at these or any other conditions beyond those indicated under *recommended operating conditions* is not implied. Exposure to absolute–maximum–rated conditions for extended periods may affect device reliability.
- (2) All voltage values are with respect to network ground terminal GND.

### 6.2 ESD Ratings

			VALUE	UNIT
V <sub>(ESD)</sub>	Electrostatic discharge	Human body model (HBM), per ANSI/ESDA/JEDEC JS-001, all pins <sup>(1)</sup>	±2000	V
		Charged device model (CDM), per JEDEC specification JESD22-C101, all pins <sup>(2)</sup>	±500	

- (1) JEDEC document JEP155 states that 500-V HBM allows safe manufacturing with a standard ESD control process. The human body model is a 100-pF capacitor discharged through a 1.5-kΩ resistor into each pin.
- (2) JEDEC document JEP157 states that 250-V CDM allows safe manufacturing with a standard ESD control process.

### 6.3 Recommended Operating Conditions

		MIN	NOM	MAX	UNIT
V <sub>IN</sub>	Supply voltage, V <sub>IN</sub>	1.75		5.5	V
I <sub>OUT</sub>	Output current, V <sub>IN</sub> ≥ 2.3 V, TPS62800, TPS62801, TPS62802			1	A
I <sub>OUT</sub>	Output current, V <sub>IN</sub> < 2.3 V, TPS62800, TPS62801, TPS62802			0.7	A
I <sub>OUT</sub>	Output current, TPS62806, TPS62807, TPS62808			0.6	A
L	Effective inductance, TPS62800, TPS62801, TPS62802	0.33	0.47	0.82	μH
C <sub>OUT</sub>	Effective output capacitance, TPS62800, TPS62801, TPS62802	2		26	μF
L	Effective inductance, TPS62806, TPS62807, TPS62808	0.7	1.0	1.2	μH
C <sub>OUT</sub>	Effective output capacitance, TPS62806, TPS62807, TPS62808	3		26	μF
C <sub>IN</sub>	Effective input capacitance	0.5	4.7		μF
C <sub>VSEL/MODE</sub>	External parasitic capacitance at the VSEL/MODE pin			30	pF
R <sub>VSEL</sub>	Resistance range for external resistor at VSEL/MODE pin (E96 1% resistor values)	10		249	kΩ
	External resistor tolerance E96 series at VSEL/MODE pin			1%	
	E96 resistor series temperature coefficient (TCR)	-200		+200	ppm/°C
T <sub>J</sub>	Operating junction temperature range	-40		125	°C

## 6.4 Thermal Information

THERMAL METRIC <sup>(1)</sup>		YKA (DSBGA)	UNIT
		6 PINS	
R <sub>θJA</sub>	Junction-to-ambient thermal resistance	147.7	°C/W
R <sub>θJC(top)</sub>	Junction-to-case (top) thermal resistance	1.7	°C/W
R <sub>θJB</sub>	Junction-to-board thermal resistance	47.5	°C/W
ψ <sub>JT</sub>	Junction-to-top characterization parameter	0.5	°C/W
ψ <sub>JB</sub>	Junction-to-board characterization parameter	47.6	°C/W
R <sub>θJC(bot)</sub>	Junction-to-case (bottom) thermal resistance	—	°C/W

(1) For more information about traditional and new thermal metrics, see the [Semiconductor and IC Package Thermal Metrics](#) application report.

## 6.5 Electrical Characteristics

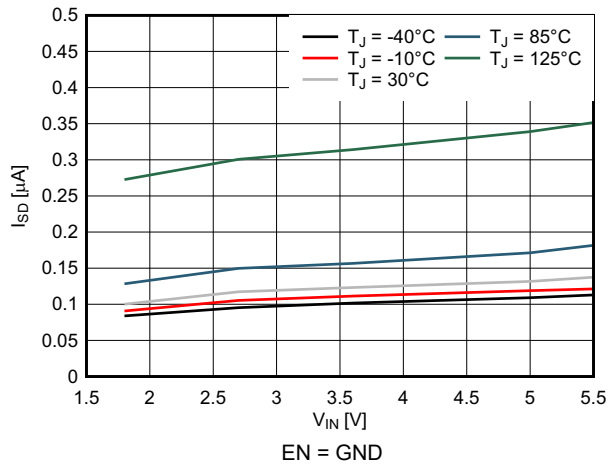
V<sub>IN</sub> = 3.6 V, T<sub>J</sub> = –40°C to 125°C typical values are at T<sub>J</sub> = 25°C (unless otherwise noted)

PARAMETER		TEST CONDITIONS	MIN	TYP	MAX	UNIT
<b>SUPPLY</b>						
I <sub>Q</sub>	Operating quiescent current (power save mode)	EN = V <sub>IN</sub> , I <sub>OUT</sub> = 0 μA, V <sub>OUT</sub> = 1.2 V, device not switching, T <sub>J</sub> = –40°C to +85°C		2.3	4	μA
		EN = V <sub>IN</sub> , I <sub>OUT</sub> = 0 μA, V <sub>OUT</sub> = 1.2 V, device switching		2.5		μA
	Operating quiescent current (PWM mode)	EN = V <sub>IN</sub> , VSEL/MODE = V <sub>IN</sub> (after power up), device switching, I <sub>OUT</sub> = 0 mA, V <sub>OUT</sub> = 1.2 V		8		mA
I <sub>SD</sub>	Shutdown current	EN = GND, shutdown current into V <sub>IN</sub> , VSEL/MODE = GND, T <sub>J</sub> = –40°C to +85°C		120	250	nA
V <sub>TH_UVLO+</sub>	Undervoltage lockout threshold	Rising V <sub>IN</sub>		1.65	1.75	V
V <sub>TH_UVLO–</sub>		Falling V <sub>IN</sub>		1.56	1.7	V
<b>INPUT EN</b>						
V <sub>IH TH</sub>	High level input voltage		0.8			V
V <sub>IL TH</sub>	Low level input voltage				0.4	V
I <sub>IN</sub>	Input bias current	T <sub>J</sub> = –40°C to +85°C, EN = high		10	25	nA
R <sub>PD</sub>	Internal pulldown resistance	EN = low		500		kΩ
<b>INPUT VSEL/MODE</b>						
V <sub>IH TH</sub>	High level input voltage (digital input)		0.8			V
V <sub>IL TH</sub>	Low level input voltage (digital input)				0.4	V
I <sub>IN</sub>	Input bias current	EN = high		10	25	nA
<b>POWER SWITCHES</b>						
I <sub>LKG_SW</sub>	Leakage current into the SW pin	V <sub>SW</sub> = 1.2 V, T <sub>J</sub> = –40°C to +85°C		10	25	nA
R <sub>DS(ON)</sub>	High side MOSFET on-resistance	I <sub>OUT</sub> = 500 mA		120	170	mΩ
	Low side MOSFET on-resistance	I <sub>OUT</sub> = 500 mA		80	115	mΩ
I <sub>LIMF</sub>	High-side MOSFET switch current limit	TPS62806, TPS62807, TPS62808	0.95	1.1	1.2	A
I <sub>LIMF</sub>	Low-side MOSFET switch current limit	TPS62806, TPS62807, TPS62808	0.85	1	1.1	A
I <sub>LIMF</sub>	High-side MOSFET switch current limit	TPS62800, TPS62801	1.3	1.45	1.55	A
		TPS62802	1.4	1.55	1.65	A
I <sub>LIMF</sub>	Low-side MOSFET switch current limit	TPS62800, TPS62801	1.2	1.35	1.45	A
		TPS62802	1.3	1.45	1.55	A
<b>OUTPUT VOLTAGE DISCHARGE</b>						

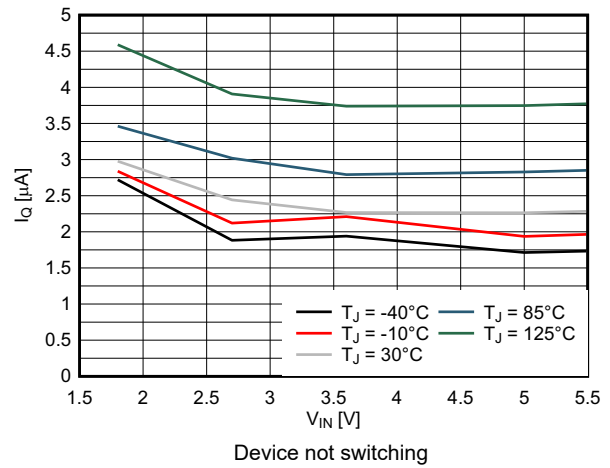
$V_{IN} = 3.6\text{ V}$ ,  $T_J = -40^\circ\text{C}$  to  $125^\circ\text{C}$  typical values are at  $T_J = 25^\circ\text{C}$  (unless otherwise noted)

PARAMETER		TEST CONDITIONS	MIN	TYP	MAX	UNIT
$R_{DSCH\_VOS}$	MOSFET on-resistance	EN = GND, $I_{VOS} = -10\text{ mA}$ into the VOS pin $T_J = -40^\circ\text{C}$ to $+85^\circ\text{C}$		7	11	$\Omega$
$I_{IN\_VOS}$	Bias current into the VOS pin	EN = $V_{IN}$ , $V_{OUT} = 1.2\text{ V}$ (internal 12-M $\Omega$ resistor divider), $T_J = -40^\circ\text{C}$ to $+85^\circ\text{C}$		100	400	nA
<b>THERMAL PROTECTION</b>						
$T_{SD}$	Thermal shutdown temperature	Rising junction temperature, PWM mode		160		$^\circ\text{C}$
	Thermal shutdown hysteresis			20		$^\circ\text{C}$
<b>OUTPUT</b>						
$V_{OUT}$	Output voltage range	TPS62800, TPS62806, 25-mV steps	0.4		0.775	V
$V_{OUT}$	Output voltage range	TPS62801, TPS62807, 50-mV steps	0.8		1.55	V
$V_{OUT}$	Output voltage range	TPS62802, TPS62808, 100-mV steps	1.8		3.3	V
$V_{OUT}$	Output voltage accuracy	Power save mode		0%		
$V_{OUT}$	Output voltage accuracy	PWM mode, $I_{OUT} = 0\text{ mA}$ , $T_J = 25^\circ\text{C}$ to $+85^\circ\text{C}$	-1%	0%	1%	
$V_{OUT}$	Output voltage accuracy	PWM mode, $I_{OUT} = 0\text{ mA}$ , $T_J = -40^\circ\text{C}$ to $+125^\circ\text{C}$	-2%	0%	1.7%	
$f_{SW}$	Switching frequency	$V_{IN} = 3.6\text{ V}$ , $V_{OUT} = 1.2\text{ V}$ , PWM operation		4		MHz
$f_{SW}$	Switching frequency	TPS62806 $V_{IN} = 3.6\text{ V}$ , $V_{OUT} = 0.7\text{ V}$ , PWM operation		1.5		MHz
$f_{SW}$	Switching frequency	TPS62807 $V_{IN} = 3.6\text{ V}$ , $V_{OUT} = 1.2\text{ V}$ , PWM operation		1.5		MHz
$f_{SW}$	Switching frequency	TPS62808 $V_{IN} = 3.6\text{ V}$ , $V_{OUT} = 1.8\text{ V}$ , PWM operation		1.5		MHz
$t_{Startup\_delay}$	Regulator start-up delay time	From transition EN = low to high until device starts switching, VSEL = 16		500	1100	$\mu\text{s}$
$t_{SS}$	Soft-start time	TPS62801, from $V_{OUT} = 0\text{ V}$ to 0.95% of $V_{OUT}$ nominal		125	170	$\mu\text{s}$
$t_{SS}$	Soft-start time	TPS62800, TPS62806, TPS62807, TPS62808 from $V_{OUT} = 0\text{ V}$ to 0.95% of $V_{OUT}$ nominal		125	210	$\mu\text{s}$
$t_{SS}$	Soft-start time	TPS62802, from $V_{OUT} = 0\text{ V}$ to 0.95% of $V_{OUT}$ nominal		400	500	$\mu\text{s}$

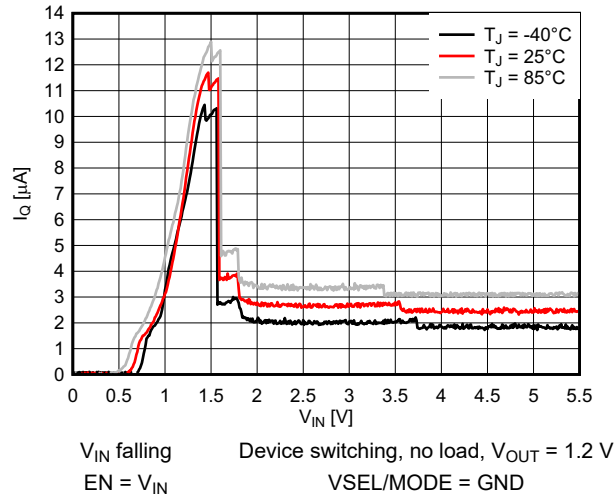
## 6.6 Typical Characteristics



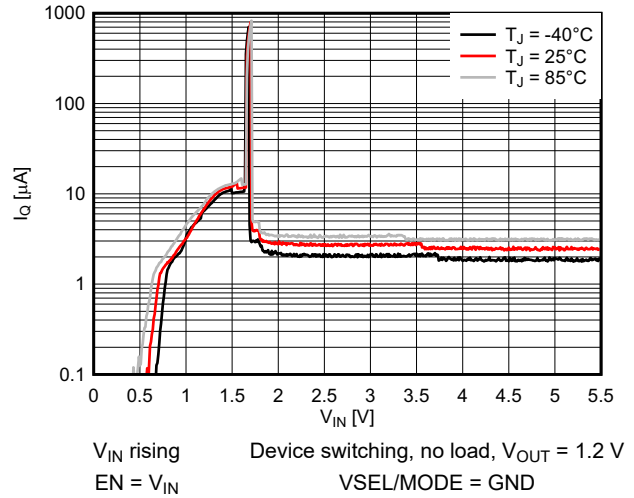
**Figure 6-1. Shutdown Current,  $I_{SD}$**



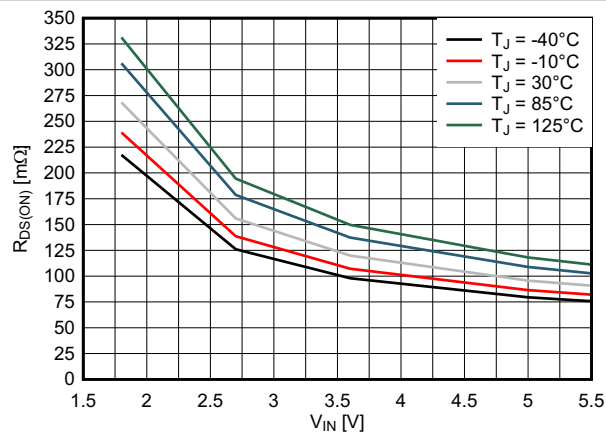
**Figure 6-2. Quiescent Current,  $I_Q$**



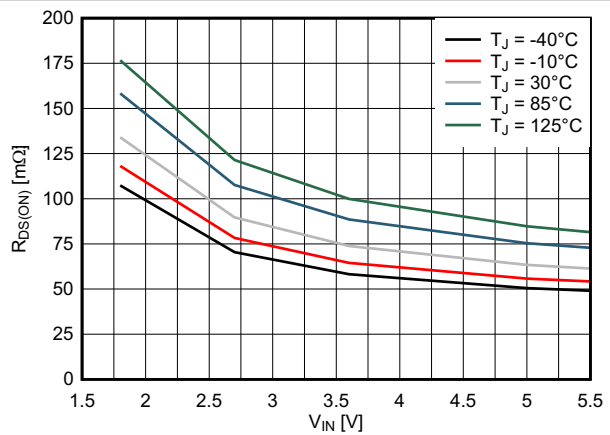
**Figure 6-3. Operating Quiescent Current,  $I_Q$**



**Figure 6-4. Operating Quiescent Current,  $I_Q$**

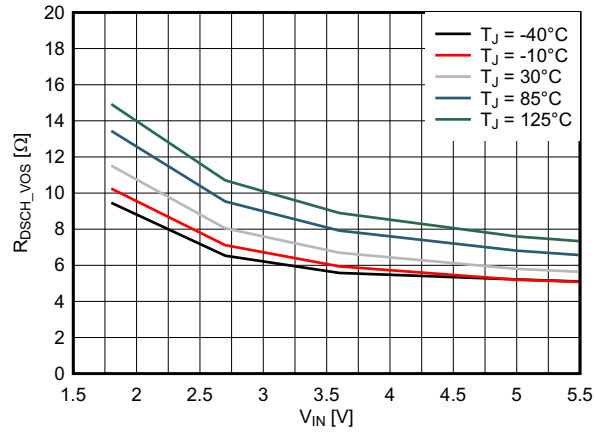


**Figure 6-5. High-Side Switch Drain Source Resistance,  $R_{DS(ON)}$**



**Figure 6-6. Low-Side Switch Drain Source Resistance,  $R_{DS(ON)}$**





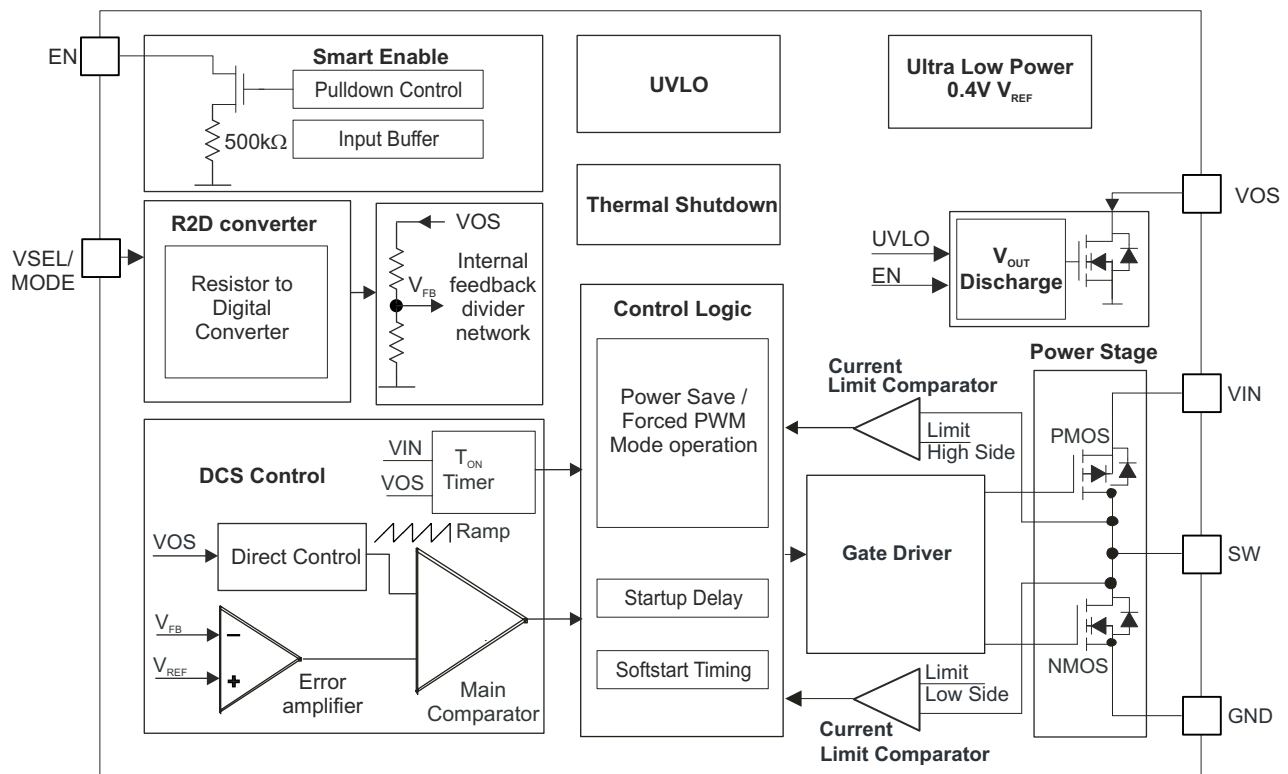
**Figure 6-7. VOS Discharge Switch Drain Source Resistance, R<sub>Dsch\_vos</sub>**

## 7 Detailed Description

### 7.1 Overview

The TPS6280x is a high frequency synchronous step-down converter with ultra-low quiescent current consumption. Using TI's DCS-Control topology, the device extends the high efficiency operation area down to microamperes of load current during power save mode operation. TI's DCS-Control (Direct Control with Seamless Transition into power save mode) is an advanced regulation topology, which combines the advantages of hysteretic and voltage mode control. Characteristics of DCS-Control are excellent AC load regulation and transient response, low output ripple voltage, and a seamless transition between PFM and PWM mode operation. DCS-Control includes an AC loop, which senses the output voltage (VOS pin) and directly feeds the information to a fast comparator. This comparator sets the switching frequency, which is constant for steady state operating conditions, and provides immediate response to dynamic load changes. In order to achieve accurate DC load regulation, a voltage feedback loop is used. The internally compensated regulation network achieves fast and stable operation with small external components and low-ESR capacitors.

### 7.2 Functional Block Diagram



### 7.3 Feature Description

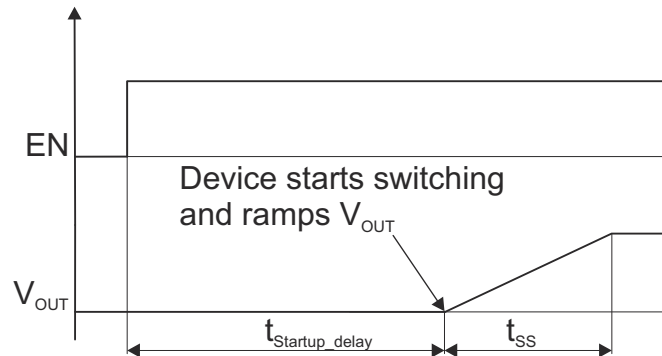
#### 7.3.1 Smart Enable and Shutdown (EN)

An internal 500-kΩ resistor pulls the EN pin to GND and avoids the pin to be floating, which prevents an uncontrolled start-up of the device in case the EN pin cannot be driven to low level safely. With EN low, the device is in shutdown mode. The device is turned on with EN set to a high level. The pulldown control circuit disconnects the pulldown resistor on the EN pin after the internal control logic and the reference have been powered up. With EN set to a low level, the device enters shutdown mode and the pulldown resistor is activated again. The voltage level on EN pin must always remain less than or equal to the voltage level on the VIN. Also, the EN pin level must rise monotonically from the VIL to the VIH level and must not bounce back and forth between the VIL and VIH levels.

### 7.3.2 Soft Start

After the device has been enabled with EN high, it initializes and powers up the internal circuits, which occurs during the regulator start-up delay time,  $t_{\text{Startup\_delay}}$ . After  $t_{\text{Startup\_delay}}$  expires, the internal soft-start circuitry ramps up the output voltage within the soft-start time,  $t_{\text{SS}}$ . See [Figure 7-1](#).

The start-up delay time,  $t_{\text{Startup\_delay}}$ , varies depending on the selected VSEL value.  $t_{\text{Startup\_delay}}$  is shortest with VSEL = 0 and longest with VSEL = 16. See [Figure 8-42](#) to [Figure 8-46](#).



**Figure 7-1. Device Start-Up**

### 7.3.3 VSEL/MODE Pin

This pin has two functions: output voltage selection during start-up of the converter and operating mode selection. See [Section 4](#).

#### 7.3.3.1 Output Voltage Selection (R2D Converter)

The output voltage is set with a single external resistor connected between the VSEL/MODE pin and GND. After the device has been enabled and the control logic as well as the internal reference have been powered up, a R2D (resistor-to-digital) conversion is started to detect the external resistor  $R_{\text{VSEL}}$  within the regulator start-up delay time,  $t_{\text{Startup\_delay}}$ . An internal current source applies current through the external resistor and an internal ADC reads back the resulting voltage level. Depending on the level, an internal feedback divider network is selected to set the correct output voltage. After this R2D conversion is finished, the current source is turned off to avoid current flow through the external resistor.

After power up, the pin is configured as an input for mode selection. Therefore, the output voltage is set only once. If the mode selection function is used in combination with the VSEL function, make sure that there is no additional current path or capacitance greater than 30 pF total to GND during R2D conversion. Otherwise, the additional current to GND is interpreted as a lower resistor value and a false output voltage is set. [Table 5-2](#) lists the correct resistor values for  $R_{\text{VSEL}}$  to set the appropriate output voltages. The R2D converter is designed to operate with resistor values out of the E96 table and requires 1% resistor value accuracy. The external resistor,  $R_{\text{VSEL}}$ , is not a part of the regulator feedback loop and has therefore no impact on the output voltage accuracy. Make sure that there is no other leakage path than the  $R_{\text{VSEL}}$  resistor at the VSEL/MODE pin during an undervoltage lockout event. Otherwise, a false output voltage is set.

Connecting VSEL/MODE to GND selects a pre-defined output voltage.

- TPS62800 = 0.7 V
- TPS62801 = 1.2 V
- TPS62802 = 1.8 V
- TPS62806 = 0.7 V
- TPS62807 = 1.2 V
- TPS62808 = 1.8 V

In this case, no external resistor is needed, which enables a smaller solution size.

### 7.3.3.2 Mode Selection — Power Save Mode and Forced PWM Operation

A low level at this pin selects power save mode operation, and a high level selects forced PWM operation. The mode can be changed during operation after the device has been powered up. The mode selection function is only available after the R2D converter has read out the external resistor.

### 7.3.4 Undervoltage Lockout (UVLO)

To avoid misoperation of the device at low input voltages, an undervoltage lockout (UVLO) comparator monitors the supply voltage. The UVLO comparator shuts down the device at an input voltage of 1.7 V (maximum) with falling  $V_{IN}$ . The device starts at an input voltage of 1.75 V (maximum) rising  $V_{IN}$ . After the device re-enters operation out of an undervoltage lockout condition, it behaves like being enabled. The internal control logic is powered up and the external resistor at the VSEL/MODE pin is read out.

### 7.3.5 Switch Current Limit and Short Circuit Protection

The TPS6280x integrates a current limit on the high-side and low-side MOSFETs to protect the device against overload or short circuit conditions. The current in the switches is monitored cycle by cycle. If the high-side MOSFET current limit,  $I_{LIMF}$ , trips, the high-side MOSFET is turned off and the low-side MOSFET is turned on to ramp down the inductor current. After the inductor current through the low-side switch decreases below the low-side MOSFET current limit,  $I_{LIMF}$ , the low-side MOSFET is turned off and the high-side MOSFET turns on again.

### 7.3.6 Thermal Shutdown

The junction temperature ( $T_J$ ) of the device is monitored by an internal temperature sensor. If  $T_J$  exceeds the thermal shutdown temperature,  $T_{SD}$ , of 160°C (typical), the device enters thermal shutdown. Both the high-side and low-side power FETs are turned off. When  $T_J$  decreases below the hysteresis amount of typically 20°C, the converter resumes operation, beginning with a soft start to the originally set  $V_{OUT}$  (there is no R2D conversion of  $R_{VSEL}$ ). The thermal shutdown is not active in power save mode.

### 7.3.7 Output Voltage Discharge

The purpose of the output discharge function is to make sure of a defined down-ramp of the output voltage when the device is disabled and to keep the output voltage close to 0 V. The output discharge feature is only active once the device has been enabled at least once since the supply voltage was applied. The output discharge function is not active if the device is disabled and the supply voltage is applied the first time.

The internal discharge resistor is connected to the VOS pin. The discharge function is enabled as soon as the device is disabled. The minimum supply voltage required to keep the discharge function active is  $V_{IN} > V_{TH\_UVLO}$ .

## 7.4 Device Functional Modes

### 7.4.1 Power Save Mode Operation

The DCS-Control topology supports power save mode operation. At light loads, the device operates in PFM (pulse frequency modulation) mode that generates a single switching pulse to ramp up the inductor current and recharge the output capacitor, followed by a sleep period where most of the internal circuits are shut down to achieve lowest operating quiescent current. During this time, the load current is supported by the output capacitor. The duration of the sleep period depends on the load current and the inductor peak current. During the sleep periods, the current consumption is reduced to typically 2.3  $\mu\text{A}$ . This low quiescent current consumption is achieved by an ultra-low power voltage reference, an integrated high impedance feedback divider network, and an optimized power save mode operation.

In PFM mode, the switching frequency varies linearly with the load current. At medium and high load conditions, the device automatically enters PWM (pulse width modulation) mode and operates in continuous conduction mode with a nominal switch frequency,  $f_{\text{sw}}$ , of typically 4 MHz or 1.5 MHz. The switching frequency in PWM mode is controlled and depends on  $V_{\text{IN}}$  and  $V_{\text{OUT}}$ . The boundary between PWM and PFM mode is when the inductor current becomes discontinuous.

If the load current decreases, the converter seamlessly enters PFM mode to maintain high efficiency down to very light loads. Because DCS-Control supports both operation modes within one single building block, the transition from PWM to PFM mode is seamless with minimum output voltage ripple.

### 7.4.2 Forced PWM Mode Operation

After the device has powered up and ramped up  $V_{\text{OUT}}$ , the VSEL/MODE pin acts as an input. With a high level on VSEL/MODE pin, the device enters forced PWM mode and operates with a constant switching frequency over the entire load range, even at very light loads. This action reduces or eliminates interference with RF and noise sensitive circuits, but lowers efficiency at light loads.

### 7.4.3 100% Mode Operation

The duty cycle of the buck converter operating in PWM mode is given as  $D = V_{\text{OUT}} / V_{\text{IN}}$ . The duty cycle increases as the input voltage comes close to the output voltage. In 100% duty cycle mode, the device keeps the high-side switch on continuously. The high-side switch stays turned on as long as the output voltage is below the internal set point, which allows the conversion of small input to output voltage differences.

### 7.4.4 Optimized Transient Performance from PWM-to-PFM Mode Operation

For most converters, the load transient response in PWM mode is improved compared to PFM mode, because the converter reacts faster on the load step and actively sinks energy on the load release. Compare [Figure 8-33](#) to [Figure 8-32](#). As an additional feature, the TPS6280x automatically enters PWM mode for 16 cycles after a heavy load release to bring the output voltage back to the regulation level faster. After 16 cycles of PWM mode, the device automatically returns to PFM mode (if VSEL/MODE is driven low). See [Figure 7-2](#). Without this optimization, the output voltage overshoot would be higher and would look like the  $V_{\text{OUT}}$ ' trace. This feature is only active after the load is high enough and the converter operates in PWM mode.

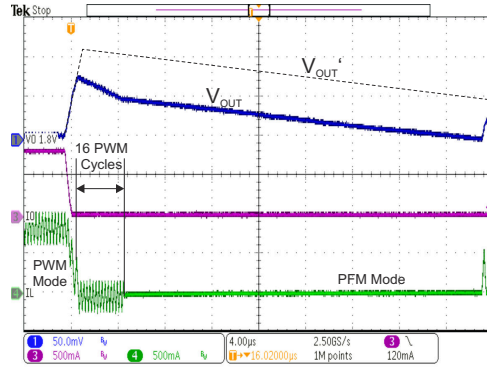


Figure 7-2. Optimized Transient Performance from PWM-to-PFM Mode

## 8 Application and Implementation

### Note

Information in the following applications sections is not part of the TI component specification, and TI does not warrant its accuracy or completeness. TI's customers are responsible for determining suitability of components for their purposes, as well as validating and testing their design implementation to confirm system functionality.

### 8.1 Application Information

The following section discusses the design of the external components to complete the power supply design for several input and output voltage options by using typical applications as a reference.

### 8.2 Typical Application

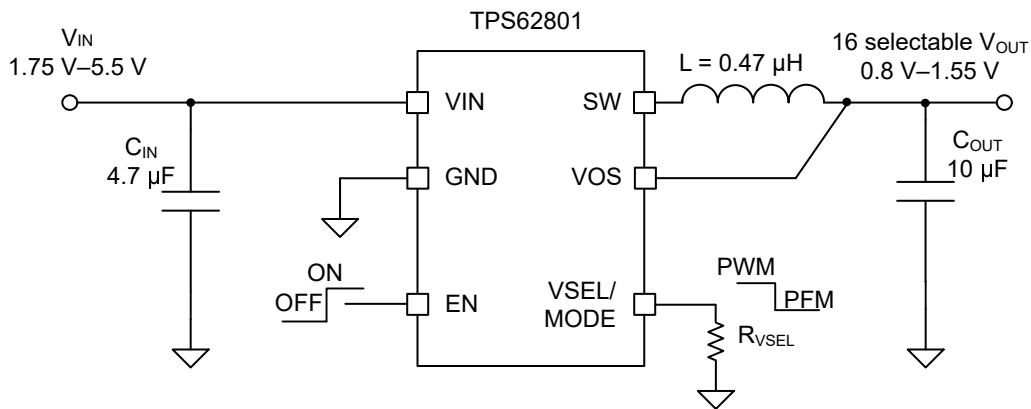


Figure 8-1. TPS62801 Adjustable  $V_{OUT}$  Application Circuit

Additional circuits are shown in [Section 8.3](#).

#### 8.2.1 Design Requirements

[Table 8-1](#) shows the list of components for the application circuit and the characteristic application curves

Table 8-1. Components for Application Characteristic Curves

Reference	Description	Value	Size [L × W × T]	Manufacturer <sup>(1)</sup>
TPS62801 / 2	Step down converter		1.05 mm × 0.70 mm × 0.4 mm maximum	Texas Instruments
$C_{IN}$	Ceramic capacitor, GRM155R60J475ME47D	4.7 µF	0402 (1 mm × 0.5 mm × 0.6 mm maximum)	Murata
$C_{OUT}$	Ceramic capacitor, GRM155R60J106ME15D	10 µF	0402 (1 mm × 0.5 mm × 0.65 mm maximum)	Murata
L	Inductor DFE18SANR47MG0L	0.47 µH	0603 (1.6 mm × 0.8 mm × 1.0 mm maximum)	Murata

(1) See the *Third-party Products Disclaimer*.

## 8.2.2 Detailed Design Procedure

### 8.2.2.1 Custom Design With WEBENCH® Tools

[Click here](#) to create a custom design using the TPS62800 device with the WEBENCH® Power Designer.

[Click here](#) to create a custom design using the TPS62801 device with the WEBENCH® Power Designer.

[Click here](#) to create a custom design using the TPS62802 device with the WEBENCH® Power Designer.

[Click here](#) to create a custom design using the TPS62806 device with the WEBENCH® Power Designer.

[Click here](#) to create a custom design using the TPS62807 device with the WEBENCH® Power Designer.

[Click here](#) to create a custom design using the TPS62808 device with the WEBENCH® Power Designer.

1. Start by entering the input voltage ( $V_{IN}$ ), output voltage ( $V_{OUT}$ ), and output current ( $I_{OUT}$ ) requirements.
2. Optimize the design for key parameters such as efficiency, footprint, and cost using the optimizer dial.
3. Compare the generated design with other possible solutions from Texas Instruments.

The WEBENCH Power Designer provides a customized schematic along with a list of materials with real-time pricing and component availability.

In most cases, these actions are available:

- Run electrical simulations to see important waveforms and circuit performance
- Run thermal simulations to understand board thermal performance
- Export customized schematic and layout into popular CAD formats
- Print PDF reports for the design, and share the design with colleagues

Get more information about WEBENCH tools at [www.ti.com/WEBENCH](http://www.ti.com/WEBENCH).

### 8.2.2.2 Inductor Selection

The inductor value affects the peak-to-peak ripple current, the PWM-to-PFM transition point, the output voltage ripple, and the efficiency. The selected inductor has to be rated for the DC resistance and saturation current. The inductor ripple current ( $\Delta I_L$ ) decreases with higher inductance and increases with higher  $V_{IN}$  or  $V_{OUT}$  and can be estimated according to [Equation 1](#).

[Equation 2](#) calculates the maximum inductor current under static load conditions. The saturation current of the inductor must be rated higher than the maximum inductor current, as calculated with [Equation 2](#), which is recommended because during a heavy load transient the inductor current rises above the calculated value. A more conservative way is to select the inductor saturation current according to the high-side MOSFET switch current limit,  $I_{LIMF}$ .

$$\Delta I_L = V_{out} \times \frac{1 - \frac{V_{out}}{V_{in}}}{L \times f} \quad (1)$$

$$I_{Lmax} = I_{outmax} + \frac{\Delta I_L}{2} \quad (2)$$

where

- $f$  = switching frequency
- $L$  = inductor value
- $\Delta I_L$  = peak-to-peak inductor ripple current
- $I_{Lmax}$  = maximum inductor current



Table 8-2 shows a list of possible inductors.

**Table 8-2. List of Possible Inductors**

Inductance [ $\mu\text{H}$ ]	Inductor Series	Size Imperial (Metric)	Dimensions L × W × T	Supplier <sup>(1)</sup>
0.47	DFE18SAN_G0	0603 (1608)	1.6 mm × 0.8 mm × 1.0 mm maximum	Murata
0.47	HTEB16080F	0603 (1608)	1.6 mm × 0.8 mm × 0.6 mm maximum	Cyntec
0.47	HTET1005FE	0402 (1005)	1.0 mm × 0.5 mm × 0.65 mm maximum	Cyntec
0.47	TFM160808ALC	0603 (1608)	1.6 mm × 0.8 mm × 0.8 mm maximum	TDK
1.0	DFE201610E	0806 (201610)	2.0 mm × 1.6 mm × 1.0 mm maximum	Murata

(1) See the *Third-party Products Disclaimer*.

### 8.2.2.3 Output Capacitor Selection

The DCS-Control scheme of the TPS6280x allows the use of tiny ceramic capacitors. Ceramic capacitors with low-ESR values have the lowest output voltage ripple and are recommended. The output capacitor requires either an X7R or X5R dielectric. At light load currents, the converter operates in power save mode and the output voltage ripple is dependent on the output capacitor value. A larger output capacitors can be used reducing the output voltage ripple.

The inductor and output capacitor together provide a low-pass filter. To simplify this process, Table 8-3 outlines possible inductor and capacitor value combinations.

**Table 8-3. Recommended LC Output Filter Combinations**

Device	Nominal Inductor Value [ $\mu\text{H}$ ]	Nominal Output Capacitor Value [ $\mu\text{F}$ ]			
		4.7 $\mu\text{F}$	10 $\mu\text{F}$	2 × 10 $\mu\text{F}$	22 $\mu\text{F}$
TPS62800, TPS62801	0.47 <sup>(1)</sup>	√	√ <sup>(3)</sup>	√	√
TPS62802	0.47 <sup>(1)</sup>		√ <sup>(3)</sup>	√	√
TPS62806, TPS62807, TPS62808	1.0 <sup>(2)</sup>	√	√ <sup>(3)</sup>	√	√

- (1) An effective inductance range of 0.33  $\mu\text{H}$  to 0.82  $\mu\text{H}$  is recommended. An effective capacitance range of 2  $\mu\text{F}$  to 26  $\mu\text{F}$  is recommended.
- (2) An effective inductance range of 0.7  $\mu\text{H}$  to 1.2  $\mu\text{H}$  is recommended. An effective capacitance range of 3  $\mu\text{F}$  to 26  $\mu\text{F}$  is recommended.
- (3) Typical application configuration. Other check marks indicate alternative filter combinations.

### 8.2.2.4 Input Capacitor Selection

Because the buck converter has a pulsating input current, a low-ESR ceramic input capacitor is required for best input voltage filtering to minimize input voltage spikes. For most applications, a 4.7- $\mu\text{F}$  input capacitor is sufficient. When operating from a high impedance source, like a coin cell, a larger input buffer capacitor  $\geq 10 \mu\text{F}$  is recommended to avoid voltage drops during start-up and load transients. The input capacitor can be increased without any limit for better input voltage filtering. The leakage current of the input capacitor adds to the overall current consumption.

Table 8-4 shows a selection of input and output capacitors.

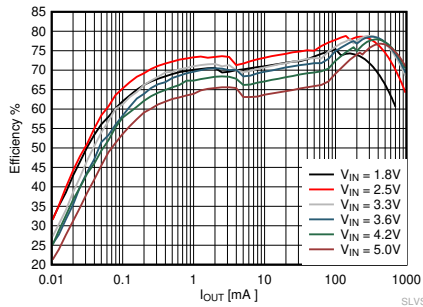
**Table 8-4. List of Possible Capacitors**

Capacitance [ $\mu$ F]	Capacitor Part Number	Size Imperial (Metric)	Dimensions L $\times$ W $\times$ T	Supplier <sup>(1)</sup>
4.7	GRM155R60J475ME47D	0402 (1005)	1.0 mm $\times$ 0.5 mm $\times$ 0.6 mm maximum	Murata
4.7	GRM035R60J475ME15	0201 (0603)	0.6 mm $\times$ 0.3 mm $\times$ 0.55 mm maximum	Murata
10	GRM155R60J106ME15D	0402 (1005)	1.0 mm $\times$ 0.5 mm $\times$ 0.65 mm maximum	Murata

(1) See the *Third-party Products Disclaimer*.

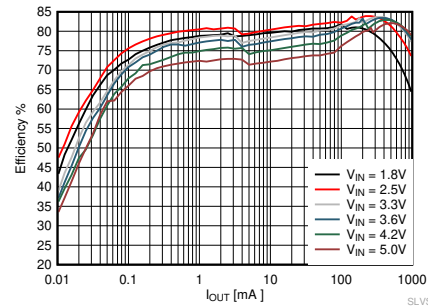
### 8.2.3 Application Curves

The conditions for the below application curves are  $V_{IN} = 3.6\text{ V}$ ,  $V_{OUT} = 1.2\text{ V}$ , and the components listed in Table 8-1, unless otherwise noted.



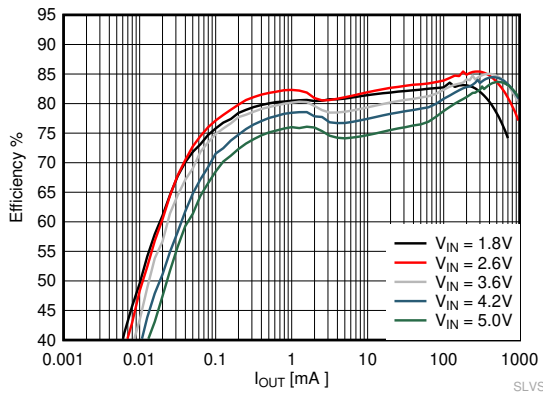
TPS62800  $R_{VSEL} = 10\text{ k}\Omega$  to GND

**Figure 8-2. Efficiency Power Save Mode**  
 **$V_{OUT} = 0.4\text{ V}$**



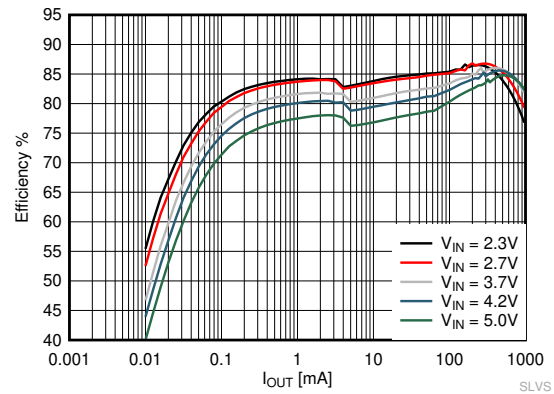
TPS62800  $VSEL/MODE = GND$

**Figure 8-3. Efficiency Power Save Mode**  
 **$V_{OUT} = 0.7\text{ V}$**



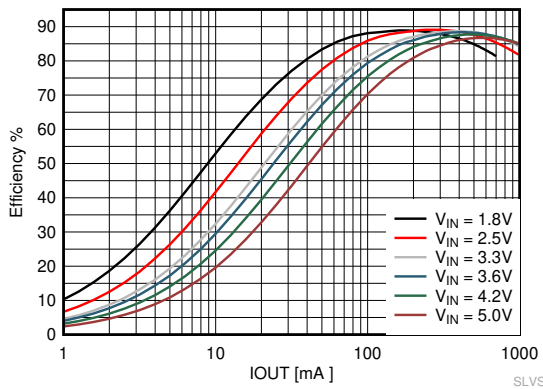
TPS62801  $R_{VSEL} = 10\text{ k}\Omega$  to GND

**Figure 8-4. Efficiency Power Save Mode**  
 **$V_{OUT} = 0.8\text{ V}$**



TPS62801  $R_{VSEL} = 15.4\text{ k}\Omega$  to GND

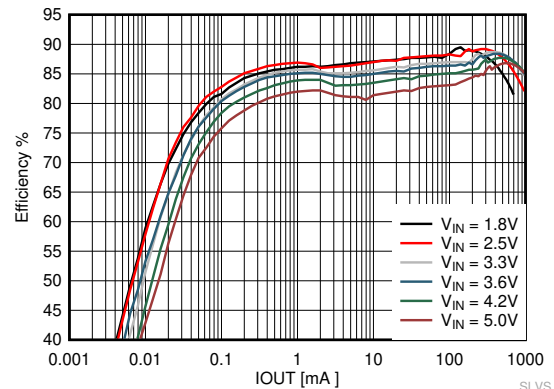
**Figure 8-5. Efficiency Power Save Mode**  
 **$V_{OUT} = 0.9\text{ V}$**



TPS62801  $R_{VSEL} = 56.2\text{ k}\Omega$

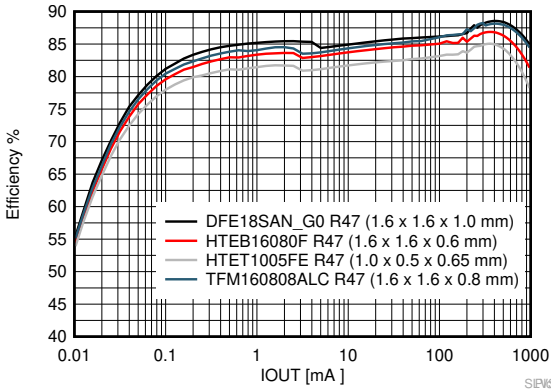
$VSEL/MODE$  pin = high after start-up

**Figure 8-6. Efficiency Forced PWM Mode**  
 **$V_{OUT} = 1.2\text{ V}$**



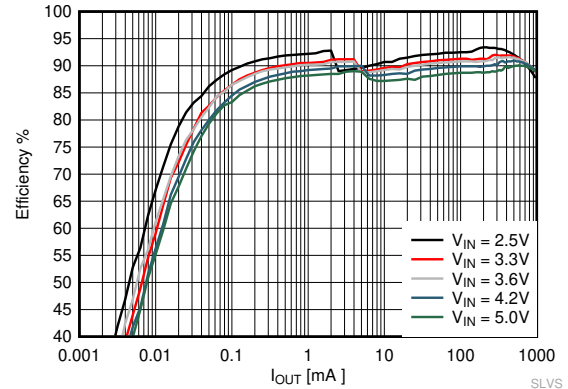
TPS62801  $VSEL/MODE = GND$

**Figure 8-7. Efficiency Power Save Mode**  
 **$V_{OUT} = 1.2\text{ V}$**



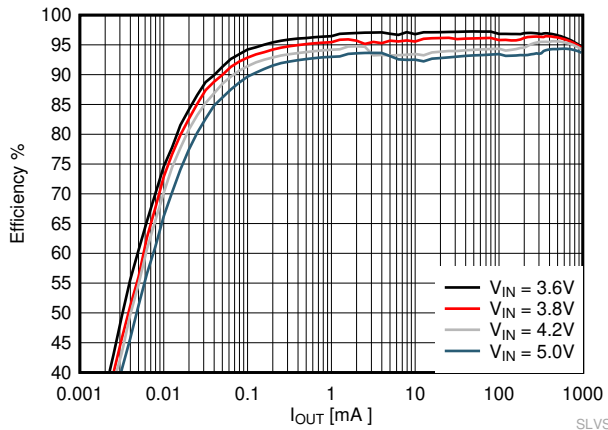
TPS62801 VSEL/MODE = GND,  $V_{OUT} = 1.2\text{ V}$

**Figure 8-8. Inductor Comparison**



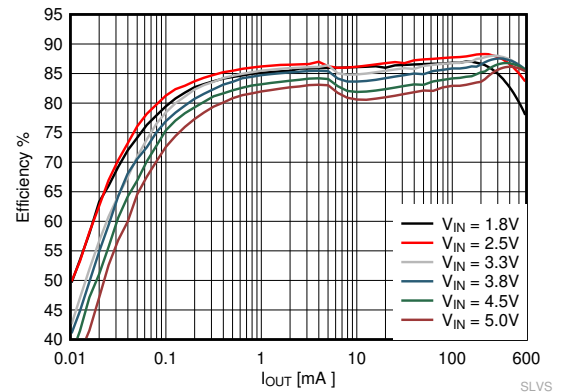
TPS62802 VSEL/MODE = GND

**Figure 8-9. Efficiency Power Save Mode  
 $V_{OUT} = 1.8\text{ V}$**



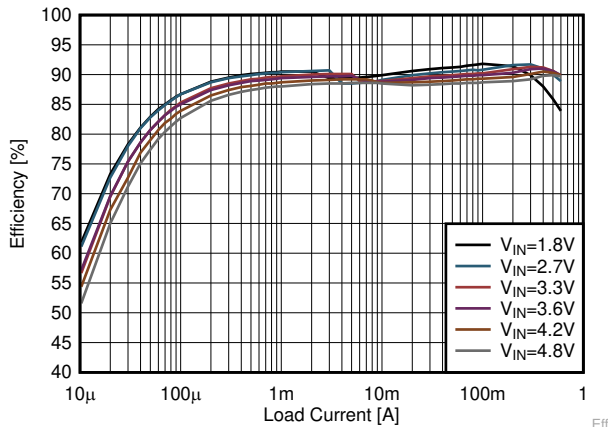
TPS62802  $3.3\text{ V } V_{OUT}$ , VSEL/MODE = 249 k

**Figure 8-10. Efficiency Power Save Mode  
 $V_{OUT} = 3.3\text{ V}$**



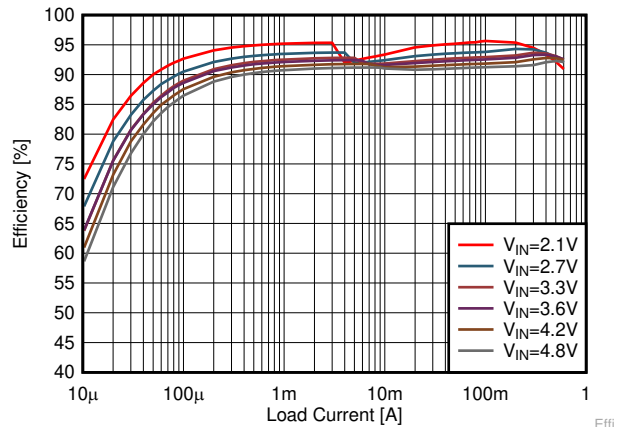
TPS62806  $V_{OUT} = 0.7\text{ V}$ , VSEL/MODE = GND  
 $L = 1\text{-}\mu\text{H DFE201610E}$

**Figure 8-11. Efficiency Power Save Mode  
 $V_{OUT} = 0.7\text{ V}$**



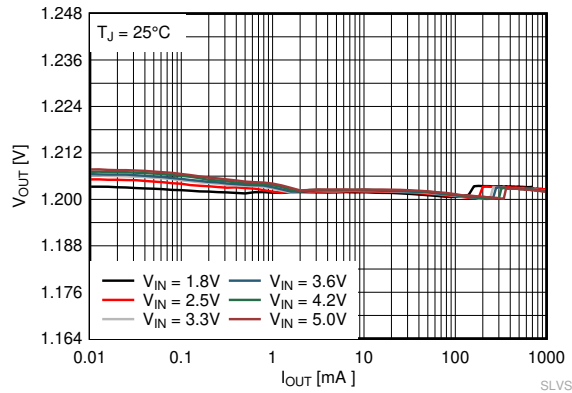
TPS62807  $V_{OUT} = 1.2\text{ V}$ , VSEL/MODE = GND  
 $L = 1\text{-}\mu\text{H DFE201610E}$

**Figure 8-12. Efficiency Power Save Mode  
 $V_{OUT} = 1.2\text{ V}$**



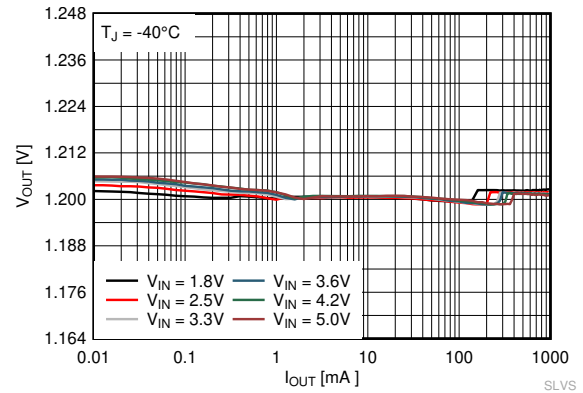
TPS62808  $V_{OUT} = 1.8\text{ V}$ , VSEL/MODE = GND  
 $L = 1\text{-}\mu\text{H DFE201610E}$

**Figure 8-13. Efficiency Power Save Mode  
 $V_{OUT} = 1.8\text{ V}$**



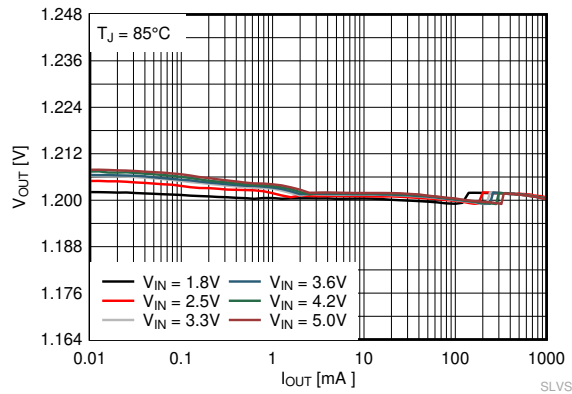
TPS62801 VSEL/MODE = GND  
V<sub>OUT</sub> = 1.2 V PFM/PWM mode T<sub>J</sub> = 25°C

Figure 8-14. Output Voltage vs Output Current



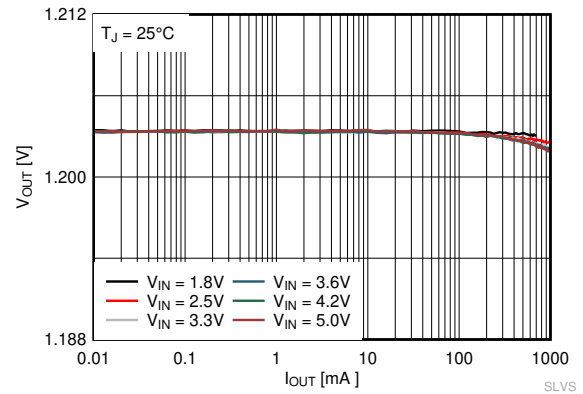
TPS62801 VSEL/MODE = GND  
V<sub>OUT</sub> = 1.2 V PFM/PWM mode T<sub>J</sub> = -40°C

Figure 8-15. Output Voltage vs Output Current



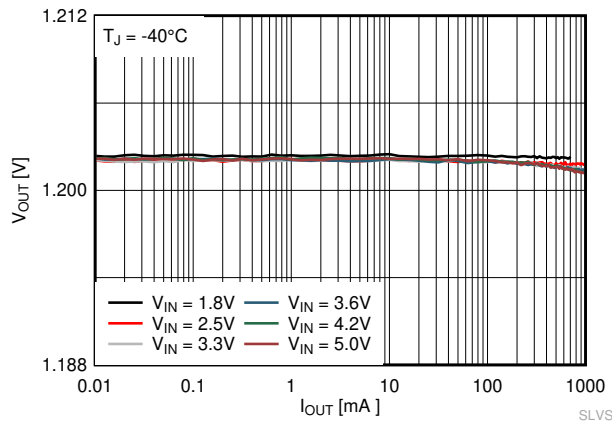
TPS62801 VSEL/MODE = GND  
V<sub>OUT</sub> = 1.2 V PFM/PWM mode T<sub>J</sub> = 85°C

Figure 8-16. Output Voltage vs Output Current



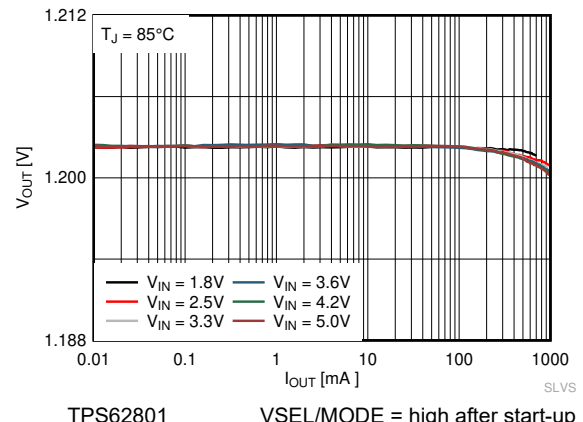
TPS62801 VSEL/MODE = high after start-up  
V<sub>OUT</sub> = 1.2 V Forced PWM mode T<sub>J</sub> = 25°C

Figure 8-17. Output Voltage vs Output Current



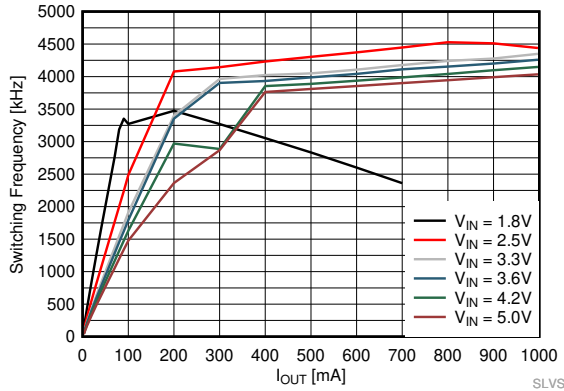
TPS62801 VSEL/MODE = high after start-up  
V<sub>OUT</sub> = 1.2 V Forced PWM mode T<sub>J</sub> = -40°C

Figure 8-18. Output Voltage vs Output Current



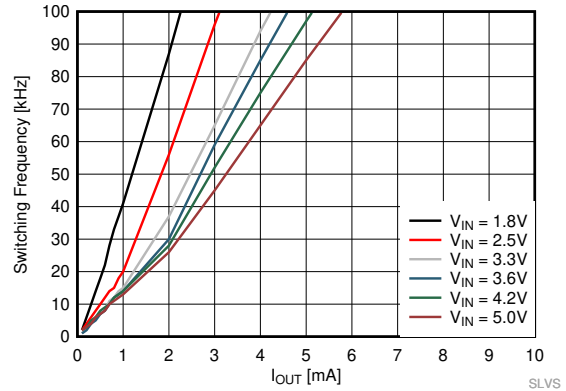
TPS62801 VSEL/MODE = high after start-up  
V<sub>OUT</sub> = 1.2 V Forced PWM mode T<sub>J</sub> = 85°C

Figure 8-19. Output Voltage vs Output Current



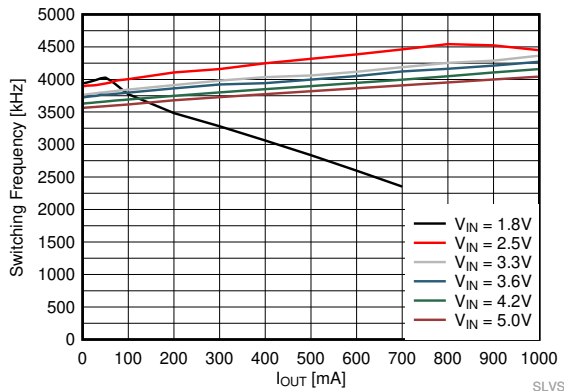
TPS62801 VSEL/MODE = GND  
 $V_{OUT} = 1.2\text{ V}$  PFM/PWM mode  $T_J = 25^\circ\text{C}$

**Figure 8-20. Switching Frequency vs Output Current**



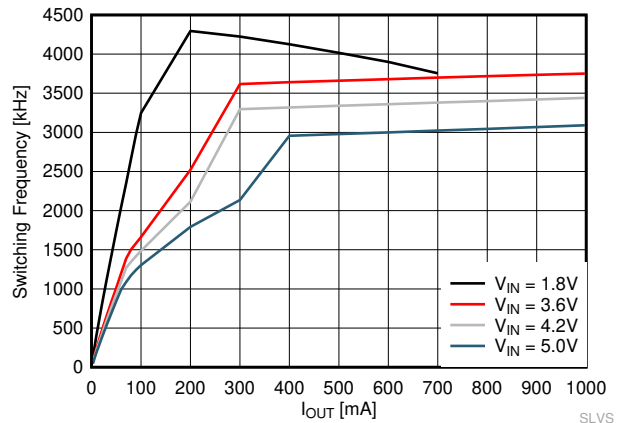
TPS62801 VSEL/MODE = GND  
 $V_{OUT} = 1.2\text{ V}$  PFM/PWM mode  $T_J = 25^\circ\text{C}$

**Figure 8-21. Switching Frequency (Zoom In)**



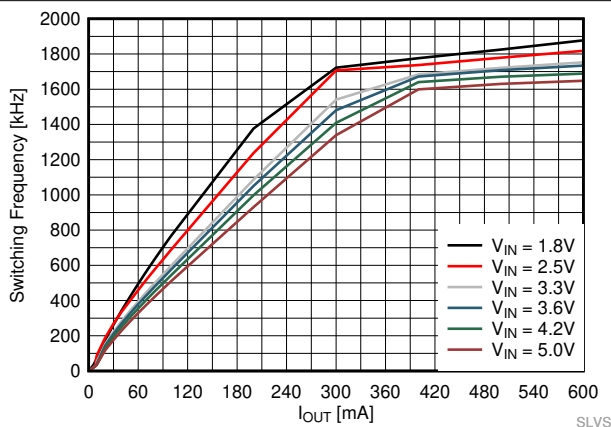
TPS62801 VSEL/MODE = high after start-up  
 $V_{OUT} = 1.2\text{ V}$  Forced PWM Mode  $T_J = 25^\circ\text{C}$

**Figure 8-22. Switching Frequency vs Output Current**



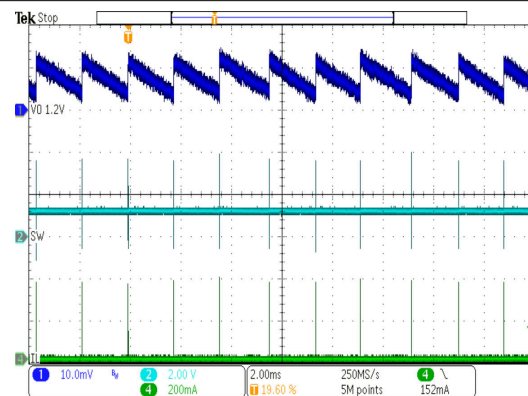
TPS62801 VSEL/MODE = 10 k $\Omega$  to GND  
 $V_{OUT} = 0.8\text{ V}$  PFM/PWM mode  $T_J = 25^\circ\text{C}$

**Figure 8-23. Switching Frequency vs Output Current**



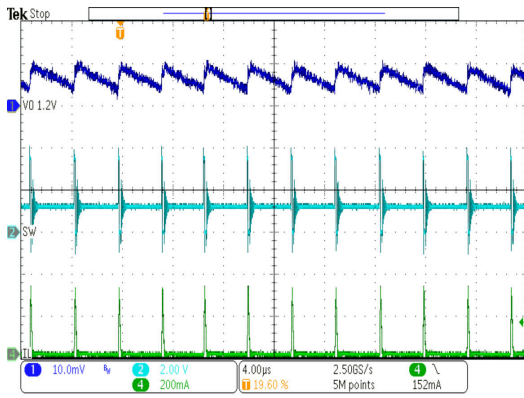
TPS62806 VSEL/MODE = GND  $L = 1\ \mu\text{H}$   
 $V_{OUT} = 0.7\text{ V}$  PFM/PWM mode  $T_J = 25^\circ\text{C}$

**Figure 8-24. Switching Frequency vs Output Current**



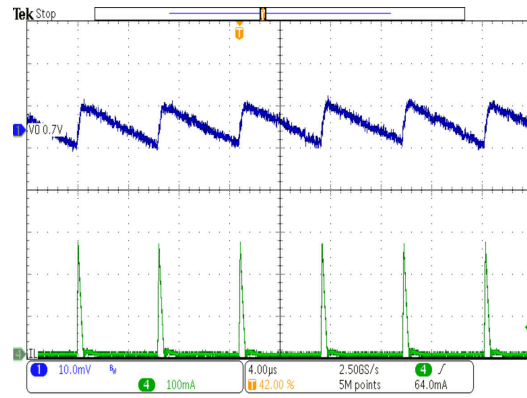
TPS62801  $V_{OUT} = 1.2\text{ V}$  VSEL/MODE = GND  
 $I_{OUT} = 25\ \mu\text{A}$  PFM mode

**Figure 8-25. Typical Operation Power Save Mode**



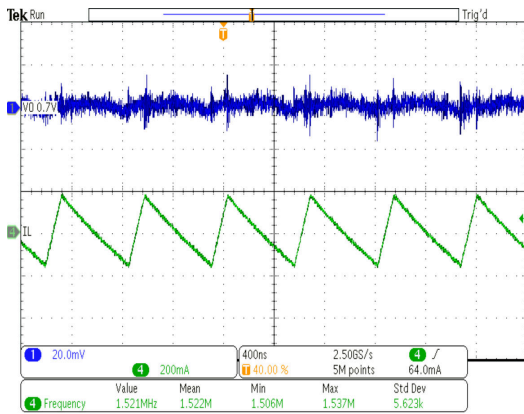
TPS62801  $V_{OUT} = 1.2\text{ V}$   $VSEL/MODE = GND$   
 $I_{OUT} = 10\text{ mA}$  PFM mode

**Figure 8-26. Typical Operation Power Save Mode**



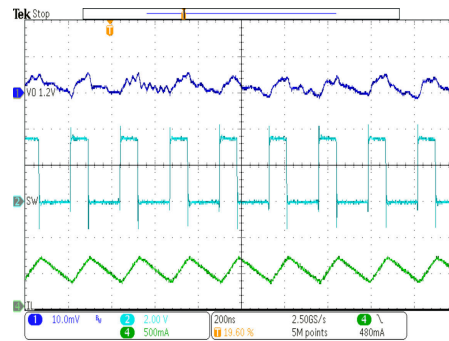
$V_{OUT} = 0.7\text{ V}$   $I_{OUT} = 10\text{ mA}$   $VSEL/MODE = GND$   
 $V_{IN} = 3.8\text{ V}$  PFM Mode, L = 1- $\mu\text{H}$  DFE201610E

**Figure 8-27. TPS62806 Typical Operation Power Save Mode**



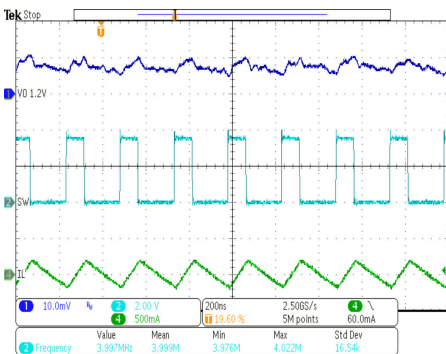
$V_{OUT} = 0.7\text{ V}$   $I_{OUT} = 0\text{ mA}$   $VSEL/MODE = V_{IN}$   
(after start-up)  
 $V_{IN} = 3.8\text{ V}$  PFM Mode, L = 1- $\mu\text{H}$  DFE201610E

**Figure 8-28. TPS62806 Typical Forced PWM Mode Operation (1.5 MHz)**



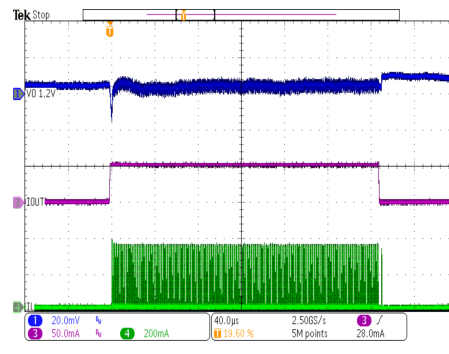
PWM mode  $V_{OUT} = 1.2\text{ V}$   $VSEL/MODE = GND$   
 $I_{OUT} = 500\text{ mA}$

**Figure 8-29. TPS62801 Typical Operation PWM Mode**



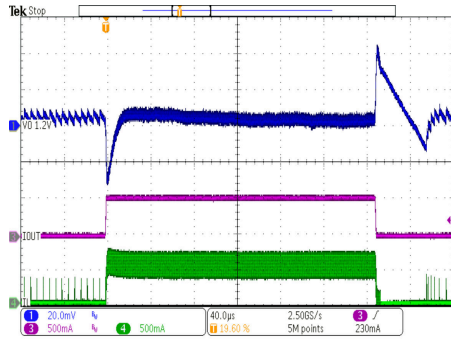
Forced PWM mode  $V_{OUT} = 1.2\text{ V}$   $I_{OUT} = 0\text{ mA}$   
 $VSEL/MODE = V_{IN}$  (after start-up)

**Figure 8-30. TPS62801 Typical Operation Forced PWM Mode**



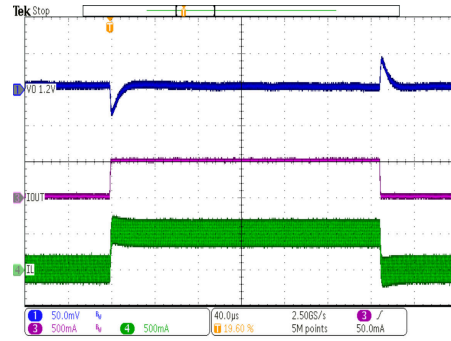
TPS62801  $V_{OUT} = 1.2\text{ V}$   $VSEL/MODE = GND$   
rise / fall time < 1  $I_{OUT} = 0\text{ mA to } 50\text{ mA}$ , PFM Mode  $\mu\text{s}$

**Figure 8-31. Load Transient Power Save Mode**



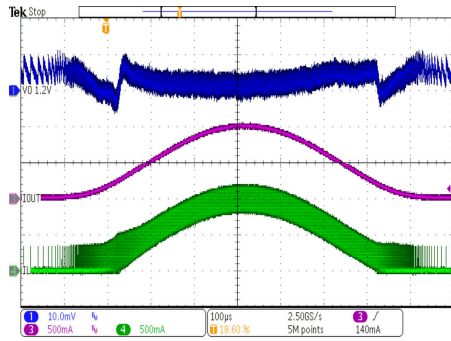
TPS62801  $V_{OUT} = 1.2\text{ V}$   $VSEL/MODE = \text{GND}$   
 rise / fall time  $< 1\ \mu\text{s}$  PFM / PWM mode  
 $I_{OUT} = 5\text{ mA to } 500\text{ mA}$

**Figure 8-32. Load Transient Power Save Mode**



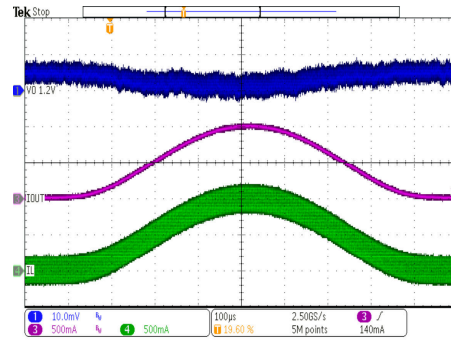
Forced  $V_{OUT} = 1.2\text{ V}$   $VSEL/MODE = \text{VIN}$   
 PWM mode (after start-up)  
 rise / fall time  $< 1\ \mu\text{s}$   $I_{OUT} = 5\text{ mA to } 500\text{ mA}$

**Figure 8-33. TPS62801 Load Transient Forced PWM Mode**



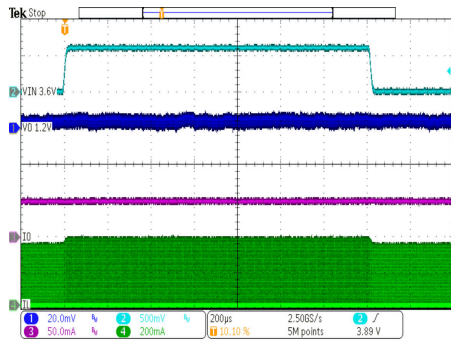
TPS62801  $V_{OUT} = 1.2\text{ V}$   $VSEL/MODE = \text{GND}$   
 $I_{OUT} = 1\text{ mA to } 1\text{ A } 1\text{ kHz}$  PFM/PWM mode

**Figure 8-34. AC Load Sweep Power Save Mode**



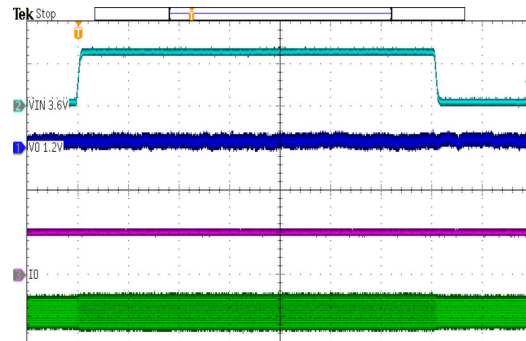
TPS62801  $V_{OUT} = 1.2\text{ V}$   $VSEL/MODE = \text{VIN}$   
 $I_{OUT} = 1\text{ mA to } 1\text{ A } 1\text{ kHz}$  (after start-up)  
 Forced PWM mode

**Figure 8-35. AC Load Sweep Forced PWM Mode**



TPS62801  $V_{OUT} = 1.2\text{ V}$   $V_{IN} = 3.6\text{ V to } 4.2\text{ V}$   
 rise / fall time =  $10\ \mu\text{s}$   $I_{OUT} = 50\text{ mA}$

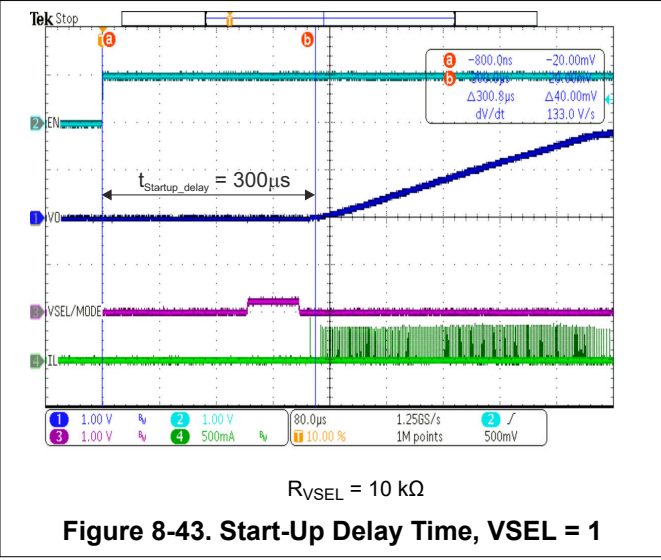
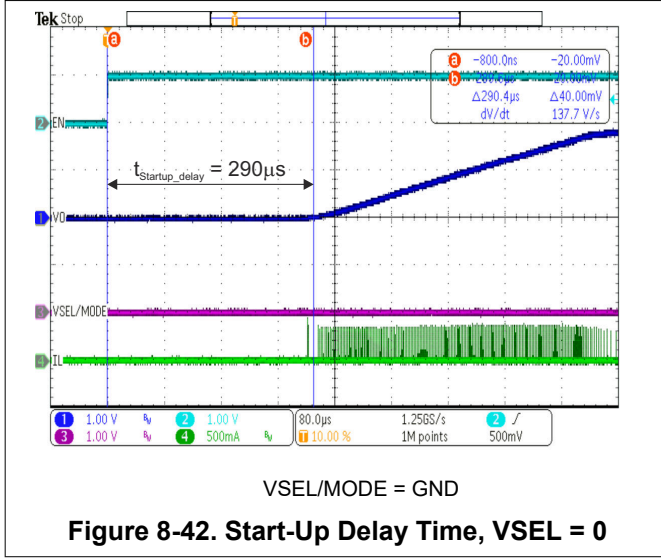
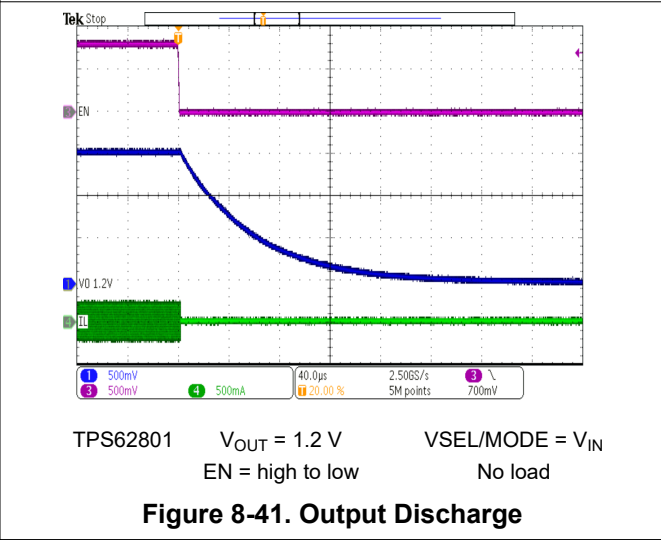
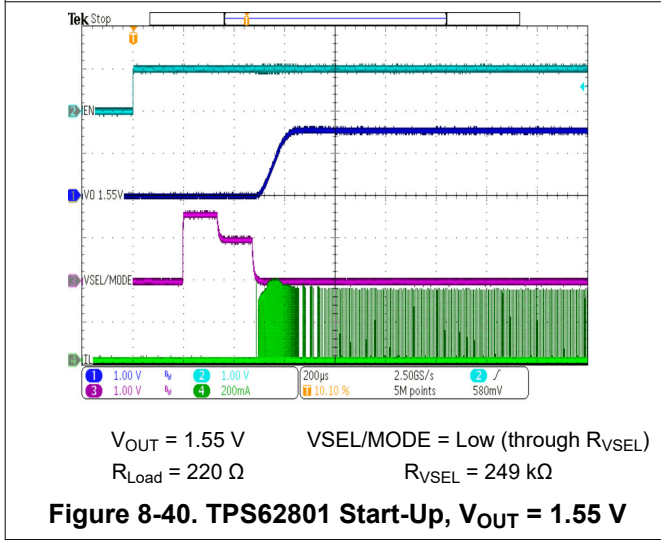
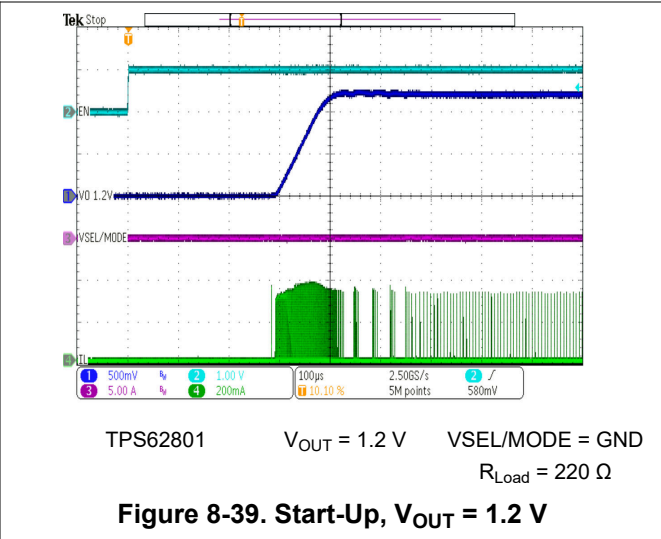
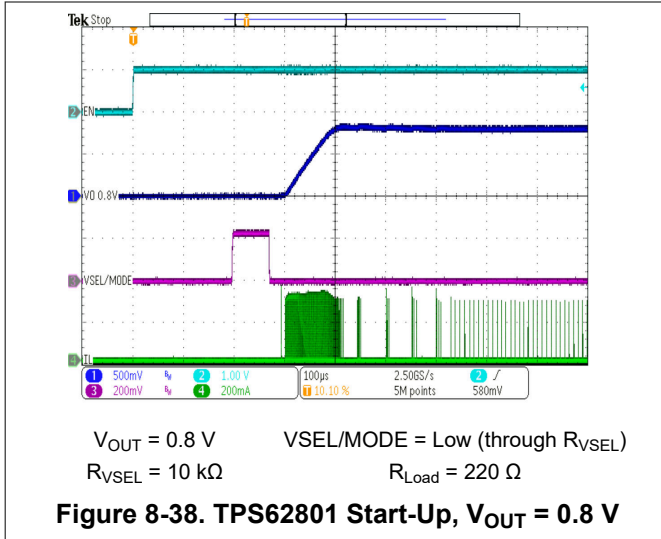
**Figure 8-36. Line Transient PFM Mode**

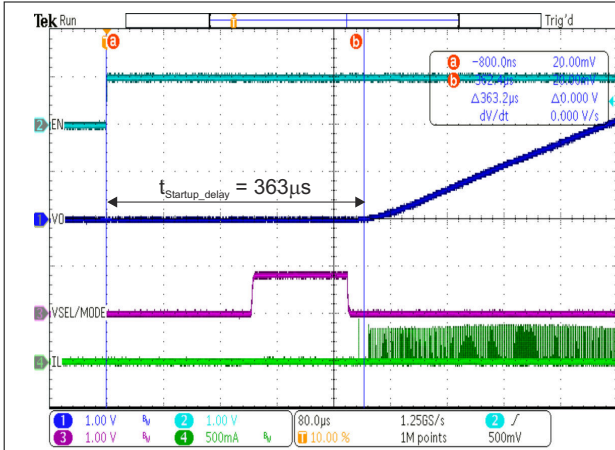


TPS62801  $V_{OUT} = 1.2\text{ V}$   $V_{IN} = 3.6\text{ V to } 4.2\text{ V}$   
 rise / fall time =  $10\ \mu\text{s}$   $I_{OUT} = 500\text{ mA}$

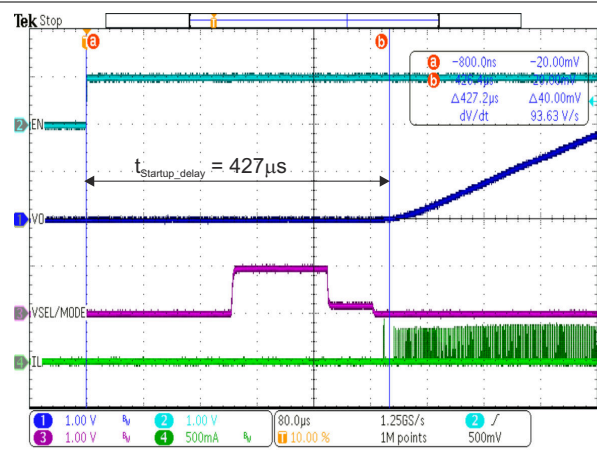
**Figure 8-37. Line Transient PWM Mode**



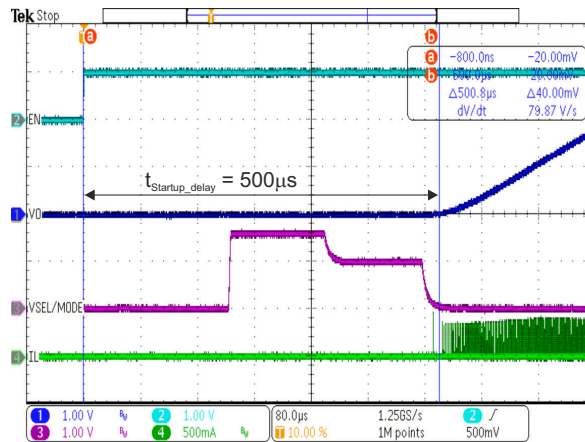




**Figure 8-44. Start-Up Delay Time, VSEL = 7**



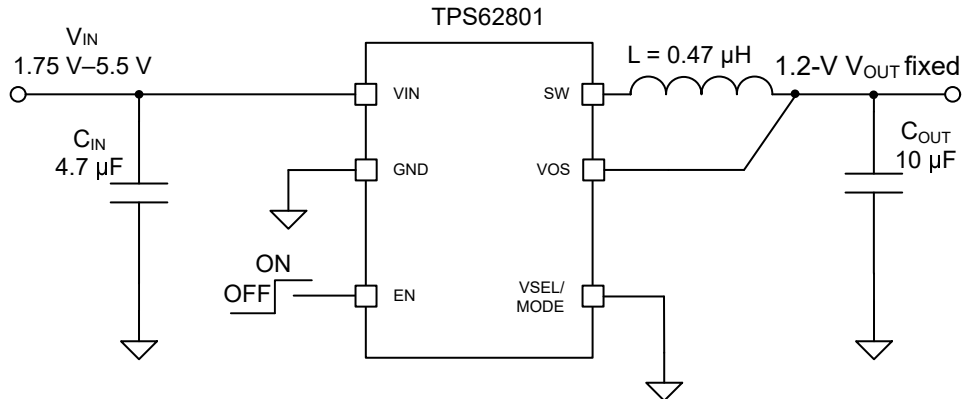
**Figure 8-45. Start-Up Delay Time, VSEL = 8**



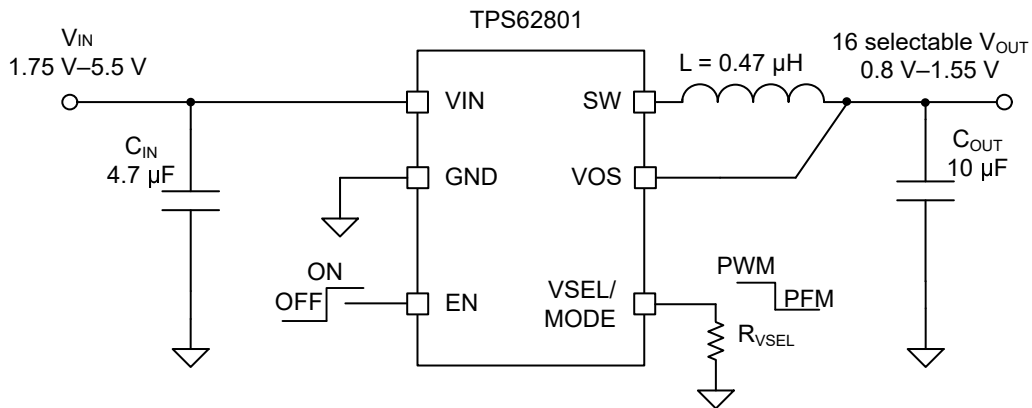
**Figure 8-46. Start-Up Delay Time, VSEL = 16**

### 8.3 System Examples

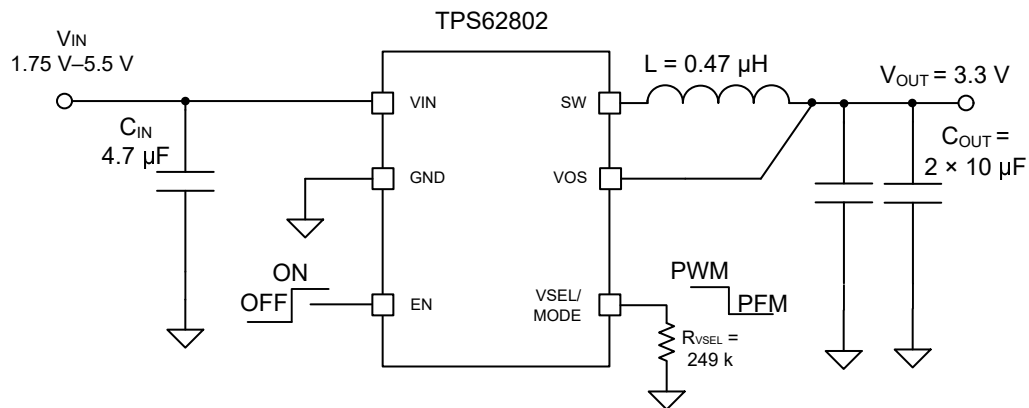
This section shows additional circuits for various output voltages.



**Figure 8-47. TPS62801 VSEL Connected to GND for 1.2-V Fixed  $V_{OUT}$**



**Figure 8-48. TPS62801 Adjustable  $V_{OUT}$  Application Circuit**



**Figure 8-49. TPS62802 Adjustable 3.3-V  $V_{OUT}$  Application Circuit**

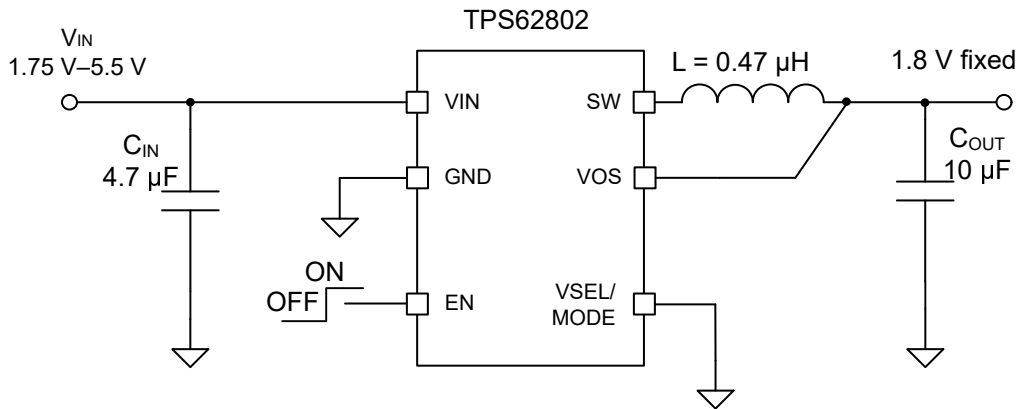


Figure 8-50. TPS62802 VSEL Connected to GND for 1.8-V Fixed  $V_{OUT}$

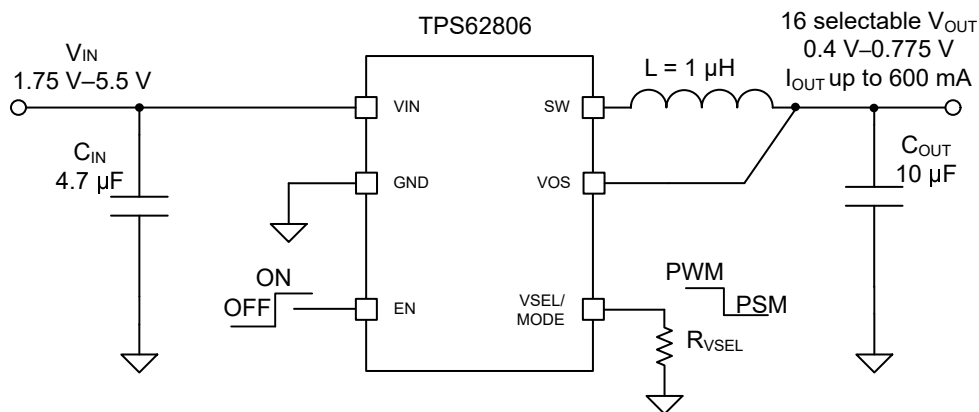


Figure 8-51. TPS62806 Adjustable  $V_{OUT}$  Application Circuit

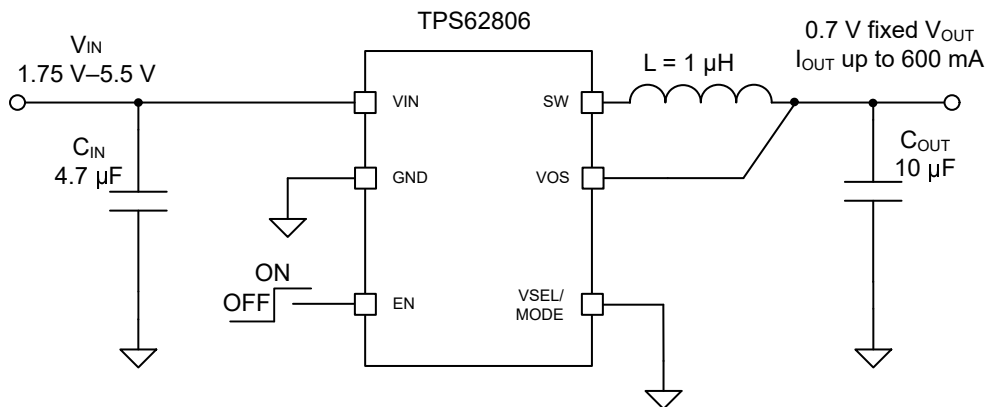


Figure 8-52. TPS62806 VSEL Connected to GND for 0.7-V Fixed  $V_{OUT}$

## 8.4 Power Supply Recommendations

The power supply must provide a current rating according to the supply voltage, output voltage, and output current of the TPS6280x.

## 8.5 Layout

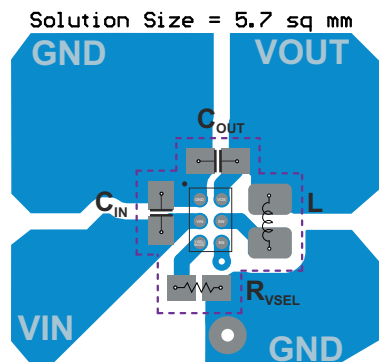
### 8.5.1 Layout Guidelines

The pinout of TPS6280x has been optimized to enable a single top layer PCB routing of the IC and the critical passive components such as  $C_{IN}$ ,  $C_{OUT}$ , and  $L$ . Furthermore, this pinout allows the user to connect tiny

components such as 0201 (0603) size capacitors and a 0402 (1005) size inductor. A solution size smaller than 5 mm<sup>2</sup> can be achieved with a fixed output voltage.

- As for all switching power supplies, the layout is an important step in the design. Take care in board layout to get the specified performance.
- It is critical to provide a low inductance, low impedance ground path. Therefore, use wide and short traces for the main current paths.
- The input capacitor must be placed as close as possible to the VIN and GND pins of the IC. This is the most critical component placement.
- The VOS line is a sensitive, high impedance line and must be connected to the output capacitor and routed away from noisy components and traces (for example, SW line) or other noise sources.

### 8.5.2 Layout Example



**Figure 8-53. PCB Layout Example**

## 9 Device and Documentation Support

### 9.1 Device Support

#### 9.1.1 Third-Party Products Disclaimer

TI'S PUBLICATION OF INFORMATION REGARDING THIRD-PARTY PRODUCTS OR SERVICES DOES NOT CONSTITUTE AN ENDORSEMENT REGARDING THE SUITABILITY OF SUCH PRODUCTS OR SERVICES OR A WARRANTY, REPRESENTATION OR ENDORSEMENT OF SUCH PRODUCTS OR SERVICES, EITHER ALONE OR IN COMBINATION WITH ANY TI PRODUCT OR SERVICE.

#### 9.1.2 Development Support

##### 9.1.2.1 Custom Design With WEBENCH® Tools

[Click here](#) to create a custom design using the TPS62800 device with the WEBENCH® Power Designer.

[Click here](#) to create a custom design using the TPS62801 device with the WEBENCH® Power Designer.

[Click here](#) to create a custom design using the TPS62802 device with the WEBENCH® Power Designer.

[Click here](#) to create a custom design using the TPS62806 device with the WEBENCH® Power Designer.

[Click here](#) to create a custom design using the TPS62807 device with the WEBENCH® Power Designer.

[Click here](#) to create a custom design using the TPS62808 device with the WEBENCH® Power Designer.

1. Start by entering the input voltage ( $V_{IN}$ ), output voltage ( $V_{OUT}$ ), and output current ( $I_{OUT}$ ) requirements.
2. Optimize the design for key parameters such as efficiency, footprint, and cost using the optimizer dial.
3. Compare the generated design with other possible solutions from Texas Instruments.

The WEBENCH Power Designer provides a customized schematic along with a list of materials with real-time pricing and component availability.

In most cases, these actions are available:

- Run electrical simulations to see important waveforms and circuit performance
- Run thermal simulations to understand board thermal performance
- Export customized schematic and layout into popular CAD formats
- Print PDF reports for the design, and share the design with colleagues

Get more information about WEBENCH tools at [www.ti.com/WEBENCH](http://www.ti.com/WEBENCH).

### 9.2 Receiving Notification of Documentation Updates

To receive notification of documentation updates, navigate to the device product folder on [ti.com](http://ti.com). Click on *Notifications* to register and receive a weekly digest of any product information that has changed. For change details, review the revision history included in any revised document.

### 9.3 Support Resources

[TI E2E™ support forums](#) are an engineer's go-to source for fast, verified answers and design help — straight from the experts. Search existing answers or ask your own question to get the quick design help you need.

Linked content is provided "AS IS" by the respective contributors. They do not constitute TI specifications and do not necessarily reflect TI's views; see TI's [Terms of Use](#).

### 9.4 Trademarks

TI E2E™ is a trademark of Texas Instruments.

WEBENCH® is a registered trademark of Texas Instruments.

All trademarks are the property of their respective owners.

## 9.5 Electrostatic Discharge Caution



This integrated circuit can be damaged by ESD. Texas Instruments recommends that all integrated circuits be handled with appropriate precautions. Failure to observe proper handling and installation procedures can cause damage.

ESD damage can range from subtle performance degradation to complete device failure. Precision integrated circuits may be more susceptible to damage because very small parametric changes could cause the device not to meet its published specifications.

## 9.6 Glossary

[TI Glossary](#) This glossary lists and explains terms, acronyms, and definitions.

## 10 Revision History

NOTE: Page numbers for previous revisions may differ from page numbers in the current version.

<b>Changes from Revision F (June 2022) to Revision G (June 2024)</b>	<b>Page</b>
• Deleted the trademark symbol from DCS-Control .....	<a href="#">1</a>
• Updated the description of the EN PIN .....	<a href="#">10</a>


<b>Changes from Revision E (July 2018) to Revision F (June 2022)</b>	<b>Page</b>
• Updated the numbering format for tables, figures, and cross-references throughout the document. ....	<a href="#">1</a>
• Updated the minimum input voltage to 1.75 V.....	<a href="#">1</a>
• Updated max rising UVLO spec.....	<a href="#">6</a>

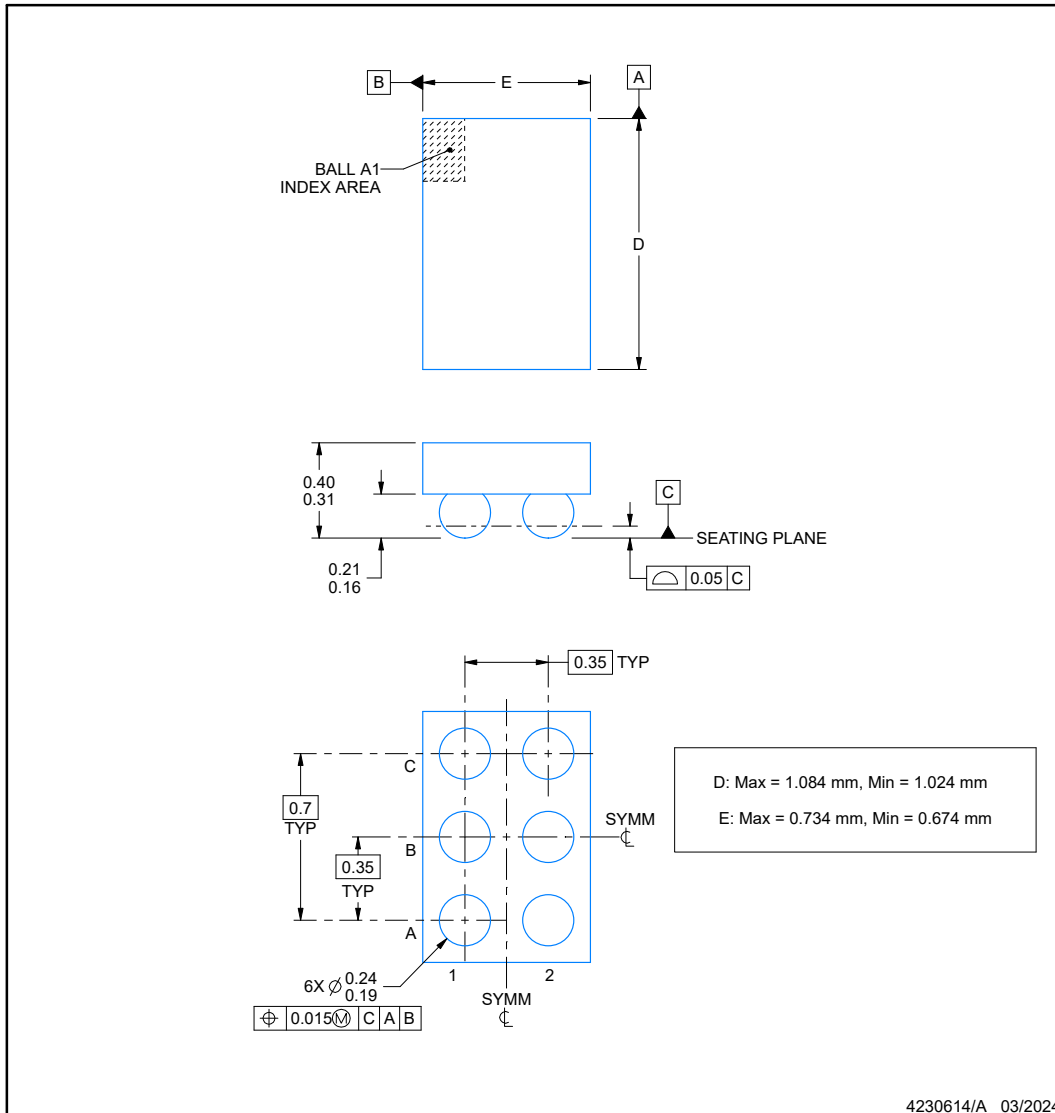
<b>Changes from Revision D (July 2018) to Revision E (January 2019)</b>	<b>Page</b>
• Added devices TPS62807 and TPS62808 throughout data sheet.....	<a href="#">1</a>

## 11 Mechanical, Packaging, and Orderable Information

The following pages include mechanical, packaging, and orderable information. This information is the most current data available for the designated devices. This data is subject to change without notice and revision of this document. For browser-based versions of this data sheet, refer to the left-hand navigation.

## 11.1 Mechanical Data

**YKA0006-C01**  **PACKAGE OUTLINE**  
**DSBGA - 0.4 mm max height**  
 DIE SIZE BALL GRID ARRAY



NOTES:

1. All linear dimensions are in millimeters. Any dimensions in parenthesis are for reference only. Dimensioning and tolerancing per ASME Y14.5M.
2. This drawing is subject to change without notice.
3. NanoFree™ package configuration.

NanoFree is a trademark of Texas Instruments.

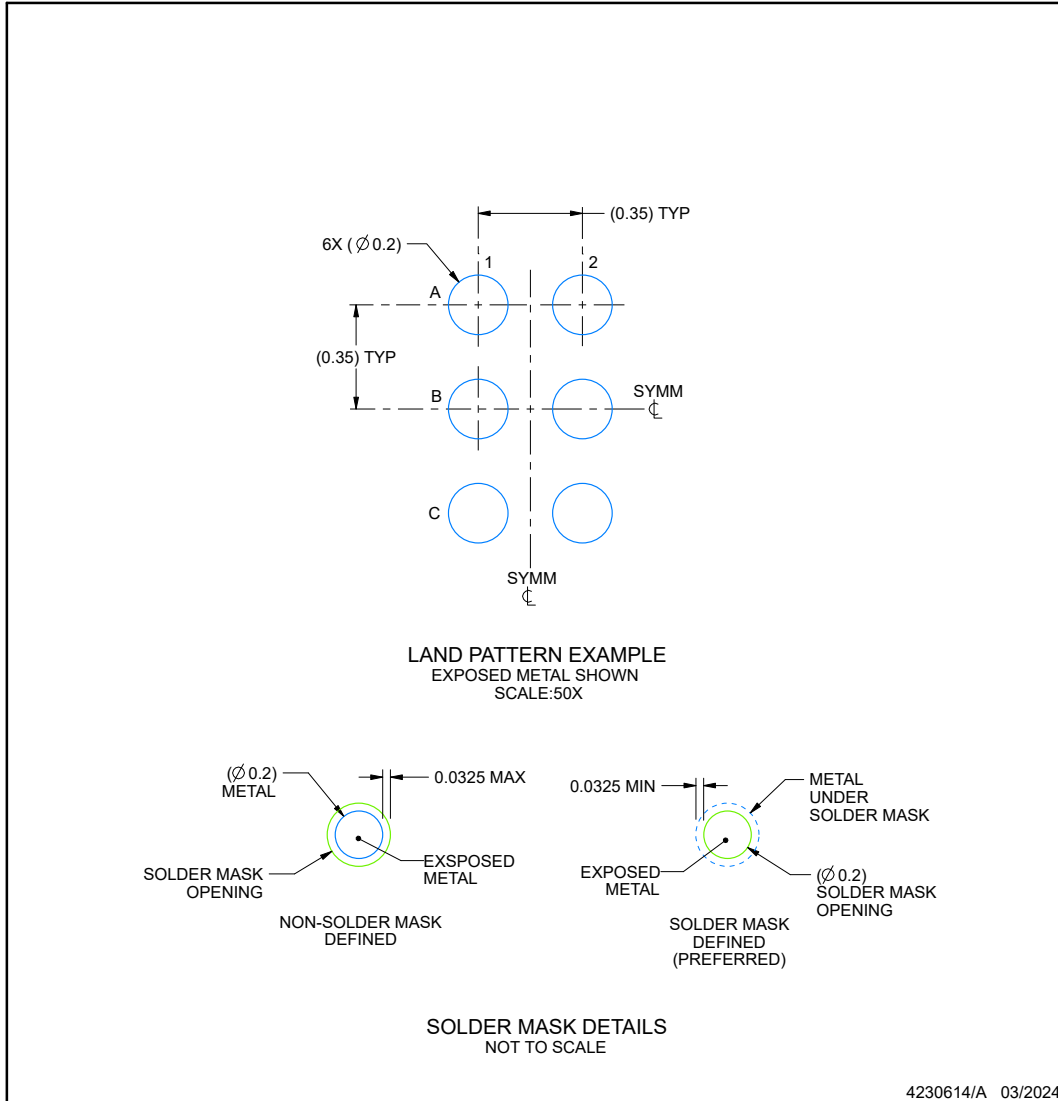


**EXAMPLE BOARD LAYOUT**

**YKA0006-C01**

**DSBGA - 0.4 mm max height**

DIE SIZE BALL GRID ARRAY



NOTES: (continued)

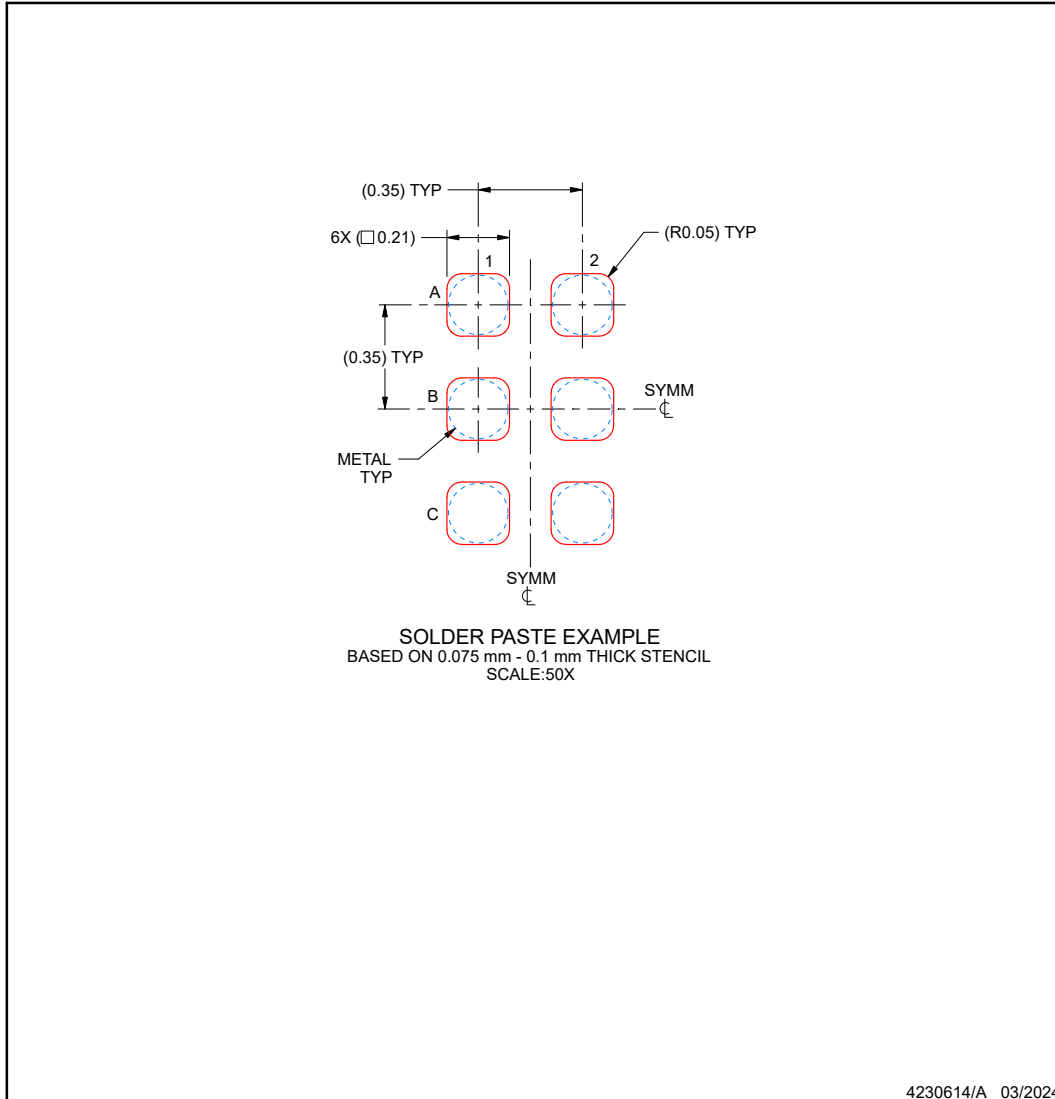
- Final dimensions may vary due to manufacturing tolerance considerations and also routing constraints. For more information, see Texas Instruments literature number SNVA009 ([www.ti.com/lit/snva009](http://www.ti.com/lit/snva009)).

## EXAMPLE STENCIL DESIGN

YKA0006-C01

DSBGA - 0.4 mm max height

DIE SIZE BALL GRID ARRAY



NOTES: (continued)

5. Laser cutting apertures with trapezoidal walls and rounded corners may offer better paste release.

**PACKAGING INFORMATION**

Orderable Device	Status (1)	Package Type	Package Drawing	Pins	Package Qty	Eco Plan (2)	Lead finish/ Ball material (6)	MSL Peak Temp (3)	Op Temp (°C)	Device Marking (4/5)	Samples
TPS62800YKAR	ACTIVE	DSBGA	YKA	6	3000	RoHS & Green	SNAGCU	Level-1-260C-UNLIM	-40 to 125	-	Samples
TPS62801YKAR	ACTIVE	DSBGA	YKA	6	3000	RoHS & Green	SNAGCU	Level-1-260C-UNLIM	-40 to 125	+	Samples
TPS62801YKAT	ACTIVE	DSBGA	YKA	6	250	RoHS & Green	SNAGCU	Level-1-260C-UNLIM	-40 to 125	+	Samples
TPS62802YKAR	ACTIVE	DSBGA	YKA	6	3000	RoHS & Green	SAC396   SNAGCU	Level-1-260C-UNLIM	-40 to 125	X	Samples
TPS62802YKAT	ACTIVE	DSBGA	YKA	6	250	RoHS & Green	SNAGCU	Level-1-260C-UNLIM	-40 to 125	X	Samples
TPS62806YKAR	ACTIVE	DSBGA	YKA	6	3000	RoHS & Green	SNAGCU	Level-1-260C-UNLIM	-40 to 125	J	Samples
TPS62806YKAT	ACTIVE	DSBGA	YKA	6	250	RoHS & Green	SNAGCU	Level-1-260C-UNLIM	-40 to 125	J	Samples
TPS62807YKAR	ACTIVE	DSBGA	YKA	6	3000	RoHS & Green	SAC396   SNAGCU	Level-1-260C-UNLIM	-40 to 125	L	Samples
TPS62807YKAT	ACTIVE	DSBGA	YKA	6	250	RoHS & Green	SNAGCU	Level-1-260C-UNLIM	-40 to 125	L	Samples
TPS62808YKAR	ACTIVE	DSBGA	YKA	6	3000	RoHS & Green	SNAGCU	Level-1-260C-UNLIM	-40 to 125	V	Samples

(1) The marketing status values are defined as follows:

**ACTIVE:** Product device recommended for new designs.

**LIFEBUY:** TI has announced that the device will be discontinued, and a lifetime-buy period is in effect.

**NRND:** Not recommended for new designs. Device is in production to support existing customers, but TI does not recommend using this part in a new design.

**PREVIEW:** Device has been announced but is not in production. Samples may or may not be available.

**OBSOLETE:** TI has discontinued the production of the device.

(2) **RoHS:** TI defines "RoHS" to mean semiconductor products that are compliant with the current EU RoHS requirements for all 10 RoHS substances, including the requirement that RoHS substance do not exceed 0.1% by weight in homogeneous materials. Where designed to be soldered at high temperatures, "RoHS" products are suitable for use in specified lead-free processes. TI may reference these types of products as "Pb-Free".

**RoHS Exempt:** TI defines "RoHS Exempt" to mean products that contain lead but are compliant with EU RoHS pursuant to a specific EU RoHS exemption.

**Green:** TI defines "Green" to mean the content of Chlorine (Cl) and Bromine (Br) based flame retardants meet JS709B low halogen requirements of <=1000ppm threshold. Antimony trioxide based flame retardants must also meet the <=1000ppm threshold requirement.

(3) MSL, Peak Temp. - The Moisture Sensitivity Level rating according to the JEDEC industry standard classifications, and peak solder temperature.

(4) There may be additional marking, which relates to the logo, the lot trace code information, or the environmental category on the device.

<sup>(5)</sup> Multiple Device Markings will be inside parentheses. Only one Device Marking contained in parentheses and separated by a "~" will appear on a device. If a line is indented then it is a continuation of the previous line and the two combined represent the entire Device Marking for that device.

<sup>(6)</sup> Lead finish/Ball material - Orderable Devices may have multiple material finish options. Finish options are separated by a vertical ruled line. Lead finish/Ball material values may wrap to two lines if the finish value exceeds the maximum column width.

**Important Information and Disclaimer:**The information provided on this page represents TI's knowledge and belief as of the date that it is provided. TI bases its knowledge and belief on information provided by third parties, and makes no representation or warranty as to the accuracy of such information. Efforts are underway to better integrate information from third parties. TI has taken and continues to take reasonable steps to provide representative and accurate information but may not have conducted destructive testing or chemical analysis on incoming materials and chemicals. TI and TI suppliers consider certain information to be proprietary, and thus CAS numbers and other limited information may not be available for release.

In no event shall TI's liability arising out of such information exceed the total purchase price of the TI part(s) at issue in this document sold by TI to Customer on an annual basis.

**TAPE AND REEL INFORMATION**

**QUADRANT ASSIGNMENTS FOR PIN 1 ORIENTATION IN TAPE**


\*All dimensions are nominal

Device	Package Type	Package Drawing	Pins	SPQ	Reel Diameter (mm)	Reel Width W1 (mm)	A0 (mm)	B0 (mm)	K0 (mm)	P1 (mm)	W (mm)	Pin1 Quadrant
TPS62800YKAR	DSBGA	YKA	6	3000	180.0	8.4	0.81	1.16	0.46	4.0	8.0	Q1
TPS62801YKAR	DSBGA	YKA	6	3000	180.0	8.4	0.81	1.16	0.46	4.0	8.0	Q1
TPS62801YKAT	DSBGA	YKA	6	250	180.0	8.4	0.81	1.16	0.46	4.0	8.0	Q1
TPS62802YKAR	DSBGA	YKA	6	3000	180.0	8.4	0.81	1.16	0.46	4.0	8.0	Q1
TPS62802YKAT	DSBGA	YKA	6	250	180.0	8.4	0.81	1.16	0.46	4.0	8.0	Q1
TPS62806YKAR	DSBGA	YKA	6	3000	180.0	8.4	0.81	1.16	0.46	4.0	8.0	Q1
TPS62806YKAT	DSBGA	YKA	6	250	180.0	8.4	0.81	1.16	0.46	4.0	8.0	Q1
TPS62807YKAR	DSBGA	YKA	6	3000	180.0	8.4	0.81	1.16	0.46	4.0	8.0	Q1
TPS62807YKAR	DSBGA	YKA	6	3000	178.0	8.4	0.81	1.16	0.46	4.0	8.0	Q1
TPS62807YKAT	DSBGA	YKA	6	250	180.0	8.4	0.81	1.16	0.46	4.0	8.0	Q1
TPS62808YKAR	DSBGA	YKA	6	3000	180.0	8.4	0.81	1.16	0.46	4.0	8.0	Q1

**TAPE AND REEL BOX DIMENSIONS**


\*All dimensions are nominal

Device	Package Type	Package Drawing	Pins	SPQ	Length (mm)	Width (mm)	Height (mm)
TPS62800YKAR	DSBGA	YKA	6	3000	182.0	182.0	20.0
TPS62801YKAR	DSBGA	YKA	6	3000	182.0	182.0	20.0
TPS62801YKAT	DSBGA	YKA	6	250	182.0	182.0	20.0
TPS62802YKAR	DSBGA	YKA	6	3000	182.0	182.0	20.0
TPS62802YKAT	DSBGA	YKA	6	250	182.0	182.0	20.0
TPS62806YKAR	DSBGA	YKA	6	3000	182.0	182.0	20.0
TPS62806YKAT	DSBGA	YKA	6	250	182.0	182.0	20.0
TPS62807YKAR	DSBGA	YKA	6	3000	182.0	182.0	20.0
TPS62807YKAR	DSBGA	YKA	6	3000	220.0	220.0	35.0
TPS62807YKAT	DSBGA	YKA	6	250	182.0	182.0	20.0
TPS62808YKAR	DSBGA	YKA	6	3000	182.0	182.0	20.0

## IMPORTANT NOTICE AND DISCLAIMER

TI PROVIDES TECHNICAL AND RELIABILITY DATA (INCLUDING DATA SHEETS), DESIGN RESOURCES (INCLUDING REFERENCE DESIGNS), APPLICATION OR OTHER DESIGN ADVICE, WEB TOOLS, SAFETY INFORMATION, AND OTHER RESOURCES "AS IS" AND WITH ALL FAULTS, AND DISCLAIMS ALL WARRANTIES, EXPRESS AND IMPLIED, INCLUDING WITHOUT LIMITATION ANY IMPLIED WARRANTIES OF MERCHANTABILITY, FITNESS FOR A PARTICULAR PURPOSE OR NON-INFRINGEMENT OF THIRD PARTY INTELLECTUAL PROPERTY RIGHTS.

These resources are intended for skilled developers designing with TI products. You are solely responsible for (1) selecting the appropriate TI products for your application, (2) designing, validating and testing your application, and (3) ensuring your application meets applicable standards, and any other safety, security, regulatory or other requirements.

These resources are subject to change without notice. TI grants you permission to use these resources only for development of an application that uses the TI products described in the resource. Other reproduction and display of these resources is prohibited. No license is granted to any other TI intellectual property right or to any third party intellectual property right. TI disclaims responsibility for, and you will fully indemnify TI and its representatives against, any claims, damages, costs, losses, and liabilities arising out of your use of these resources.

TI's products are provided subject to [TI's Terms of Sale](#) or other applicable terms available either on [ti.com](https://www.ti.com) or provided in conjunction with such TI products. TI's provision of these resources does not expand or otherwise alter TI's applicable warranties or warranty disclaimers for TI products.

TI objects to and rejects any additional or different terms you may have proposed.

Mailing Address: Texas Instruments, Post Office Box 655303, Dallas, Texas 75265

Copyright © 2025, Texas Instruments Incorporated