

UCC57102Z-Q1 High-Speed, Low-Side Gate Driver With DESAT Protection For Automotive Applications

1 Features

- Qualified for automotive applications
- AEC-Q100 qualified
 - Device temperature grade 1
- Typical 3A sink 3A source output currents
- DESAT protection with programmable delay
- Soft turn-off when fault happens
- Absolute maximum VDD voltage: 30V
- Input and enable pins capable of withstanding up to -5V
- Tight UVLO thresholds for bias flexibility
- Typical 26ns propagation delay
- Self-protect driver with thermal shutdown function
- Wide bias voltage range
- Available in 5mm × 4mm SOIC-8 package
- Operating junction temperature range of -40°C to 150°C

2 Applications

- HEV/EV PTC heaters
- Traction inverters
- Residential EV chargers
- Motor drives
- HVAC compressors

3 Description

The UCC57102Z-Q1 is a single channel, high-performance low-side IGBT/SiC gate driver for high power automotive applications such as PTC heaters, traction inverter active discharge circuit, and other auxiliary subsystems. It offers protection features including Under-voltage-lock-out (UVLO), Desaturation protection (DESAT), FAULT report, and thermal shutdown protection. The UCC57102Z-Q1 has a typical peak drive strength of 3A and it can handle -5V on its inputs, which improves robustness in systems with moderate ground bouncing. The inputs are independent of supply voltage and can be connected to most controller outputs for maximum control flexibility. The wide voltage range of the bias supply provided in the UCC57102Z-Q1 accommodates bipolar voltage. An accurate 5V output LDO is also available with the UCC57102Z-Q1 .

Package Information

PART NUMBER	PACKAGE ⁽¹⁾	PACKAGE SIZE ⁽²⁾	BODY SIZE (NOM)
UCC57102Z-Q1	D (SOIC 8)	4.9mm × 6.0mm	4.90mm × 3.91mm

- (1) For all available packages, see [Section 12](#).
- (2) The package size (length × width) is a nominal value and includes pins, where applicable.

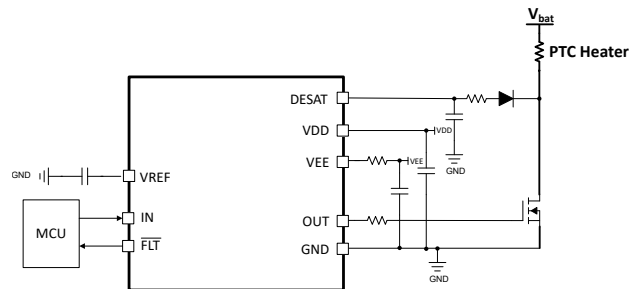

Simplified Application Diagram



Table of Contents

1 Features	1	7 Applications and Implementation	17
2 Applications	1	7.1 Application Information.....	17
3 Description	1	7.2 Typical Application.....	18
4 Pin Configuration and Functions	3	8 Power Supply Recommendations	20
5 Specifications	4	9 Layout	21
5.1 Absolute Maximum Ratings.....	4	9.1 Layout Guidelines.....	21
5.2 ESD Ratings.....	4	9.2 Layout Example.....	21
5.3 Recommended Operating Conditions.....	4	10 Device and Documentation Support	22
5.4 Thermal Information.....	4	10.1 Third-Party Products Disclaimer.....	22
5.5 Electrical Characteristics.....	5	10.2 Receiving Notification of Documentation Updates..	22
5.6 Switching Characteristics.....	6	10.3 Support Resources.....	22
5.7 Timing Diagrams.....	7	10.4 Trademarks.....	22
5.8 Typical Characteristics.....	9	10.5 Electrostatic Discharge Caution.....	22
6 Detailed Description	13	10.6 Glossary.....	22
6.1 Overview.....	13	11 Revision History	22
6.2 Functional Block Diagram.....	13	12 Mechanical, Packaging, and Orderable Information	22
6.3 Feature Description.....	13		
6.4 Device Functional Modes.....	16		

4 Pin Configuration and Functions

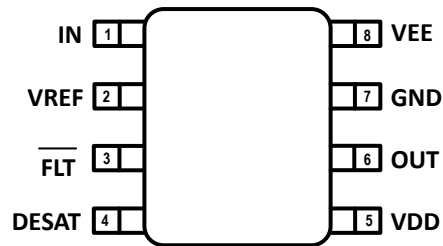

Figure 4-1. UCC57102Z-Q1 D Package SOIC-8 Top View

Table 4-1. Pin Functions

PIN		TYPE ⁽¹⁾	DESCRIPTION
NAME	NO.		
IN	1	I	Non-inverting PWM input
VREF	2	O	5V Reference generated within the driver
FLT	3	O	Active low fault reporting
DESAT	4	I	Input for detecting the desaturation fault
VDD	5	P	Driver bias supply
OUT	6	O	Output of the driver
GND	7	G	Driver ground
VEE	8	P	Driver negative bias supply with respect to GND

(1) I/O = Digital input/output, IA = Analog input, AO= Analog output, P = Power connection

5 Specifications

5.1 Absolute Maximum Ratings

All the voltages are with respect to GND. Over operating free-air temperature range (unless otherwise noted)⁽¹⁾

		MIN	MAX	UNIT
VDD-GND	Positive power supply	-0.3	30	V
VDD-VEE	Differential Power Supply	-0.3	30	V
VEE-GND	Negative Power Supply	-18	0.3	V
OUT	Output signal DC voltage	GND/VEE-0.3	VDD+0.3	V
	Output signal transient voltage for 200-ns	GND/VEE-2	VDD+3	V
V _{DESAT}	Desat voltage	-0.3	VDD+0.3	V
V _{IN}	IN signal DC voltage	-5	30	V
V _{EN}	EN signal DC voltage (W Version)	-5	30	V
I _{FLT}	FLT current sink		20	mA
V _{FLT}	External pull-up	-0.3	VDD+0.3	V
T _J	Junction temperature	-40	150	°C
T _{stg}	Storage temperature	-65	150	°C

- (1) Stresses beyond those listed under *Absolute Maximum Rating* may cause permanent damage to the device. These are stress ratings only, which do not imply functional operation of the device at these or any other conditions beyond those indicated under *Recommended Operating Condition*. Exposure to absolute-maximum-rated conditions for extended periods may affect device reliability.

5.2 ESD Ratings

			VALUE	UNIT
V _(ESD)	Electrostatic discharge	Human body model (HBM), per AEC Q100-002 ⁽¹⁾	±2000	V
		Charged device model (CDM), per AEC Q100-011	±1000	V

- (1) AEC Q100-002 indicates that HBM stressing shall be in accordance with the ANSI/ESDA/JEDEC JS-001 specification.

5.3 Recommended Operating Conditions

All voltages are with reference to GND. Over operating free-air temperature range (unless otherwise noted)

		MIN	NOM	MAX	UNIT
VDD-GND	Positive Power Supply	14.5		26	V
VDD-VEE	Differential Power Supply			26	V
VEE-GND	Negative Power Supply	-15		0	V
V _{OUT}	Output Voltage	GND/VEE		VDD	V
V _{IN}	IN signal DC voltage	-2		26	V
V _{EN}	EN signal DC voltage (W Version)	-2		26	V
T _J	Junction temperature	-40		150	°C

5.4 Thermal Information

THERMAL METRIC ⁽¹⁾		UCC57102Z-Q1	
		D (SOIC)	
		8 PINS	
			UNIT
R _{θJA}	Junction-to-ambient thermal resistance	132.7	°C/W
R _{θJC(top)}	Junction-to-case (top) thermal resistance	74.9	°C/W

5.4 Thermal Information (continued)

THERMAL METRIC ⁽¹⁾		UCC57102Z-Q1	
		D (SOIC)	
		8 PINS	
			UNIT
$R_{\theta JB}$	Junction-to-board thermal resistance	76.3	°C/W
Ψ_{JT}	Junction-to-top characterization parameter	25.6	°C/W
Ψ_{JB}	Junction-to-board characterization parameter	75.4	°C/W
$R_{\theta JC(bot)}$	Junction-to-case (bottom) thermal resistance	n/a	°C/W

(1) For more information about traditional and new thermal metrics, see the [Semiconductor and IC Package Thermal Metrics](#) application report.

5.5 Electrical Characteristics

VDD = 15 V, VEE = 0 V, 1- μ F capacitor from VDD to GND, 1- μ F capacitor from VEE to GND, T_J = -40°C to +150°C, CL = 0 pF, unless otherwise noted.

PARAMETER		TEST CONDITIONS	MIN	TYP	MAX	UNIT
SUPPLY CURRENTS						
I _{VDDQ}	VDD quiescent supply current	V _{IN} = 3.3V, EN = 5V, VDD = 6.5V			1.4	mA
I _{VDD}	VDD static supply current	V _{IN} = 3.3 V, EN = 5V		1.1	1.5	mA
I _{VDD}	VDD static supply current	V _{IN} = 0 V, EN = 5V		0.8	1.2	mA
I _{VEEQ}	VEE static supply current	V _{IN} = 0 V, EN = 5V, VEE = -10V			1.1	mA
I _{VDDO}	VDD dynamic operating current	f _{SW} = 1 MHz, EN = 5V, VDD=15 V, C _L =1.8nF			35	mA
I _{DIS}	VDD disable current	V _{IN} = 3.3 V, EN = 0 V		0.8	1.1	mA
VDD UNDERVOLTAGE THRESHOLDS AND DELAY						
t _{UVLO2FLT}	Propagation delay from UVLO shutdown to FLT			8.4		us
V _{VDD_ON}	VDD UVLO Rising Threshold	12.5-V UVLO Option	12.8	13.5	14.2	V
V _{VDD_OFF}	VDD UVLO Falling Threshold	12.5-V UVLO Option	11.8	12.5	13.2	V
V _{VDD_HYS}	VDD UVLO Threshold Hysteresis	12.5-V UVLO Option		1.0		V
VREF						
V _{REF}	Voltage Reference	I _{REF} =10mA		5		V
I _{REF}	Reference output current				20	mA
IN, EN						
V _{INH}	Input High Threshold Voltage		1.8	2.2	2.6	V
V _{INL}	Input Low Threshold Voltage		0.8	1.2	1.6	V
V _{IN_HYS}	Input-threshold Hysteresis			1.0		V
R _{IND}	IN Pin Pull Down Resistance	IN=EN= 3.3V		120		k Ω
V _{ENH}	Enable High Threshold Voltage		1.8	2.2	2.6	V
V _{ENL}	Enable Low Threshold Voltage		0.8	1.2	1.6	V
V _{EN_HYS}	Enable Threshold Hysteresis			1		V
R _{ENU}	EN Pin Pull Up Resistance	EN = 0V		400		k Ω
V _{FLTth}	FLT threshold voltage	I _{FLT-sink} = 15mA		0.43	1	V
DESAT DETECTION						
I _{CHG}	Blanking capacitor charge current	V _{DESAT} = 3.25V	200	250	316	μ A
I _{DCHG}	DESAT pin discharge current	V _{DESAT} = 8V		-20		mA
V _{DESATTH}	DESAT Detection Threshold		6.0	6.5	7.0	V
V _{DESLO}	DESAT voltage when OUT=L, referenced to GND				100	mV

5.5 Electrical Characteristics (continued)

VDD = 15 V, VEE = 0 V, 1- μ F capacitor from VDD to GND, 1- μ F capacitor from VEE to GND, T_J = -40°C to +150°C, C_L = 0 pF, unless otherwise noted.

PARAMETER		TEST CONDITIONS	MIN	TYP	MAX	UNIT
t _{DESLEB} ⁽¹⁾	Leading edge blanking time			160		ns
t _{DESFIL} ⁽¹⁾	DESAT deglitch filter			100	150	ns
t _{DES2OUT} ⁽¹⁾	DESAT propagation delay to 90% of OUT	V _{DESAT} > V _{DESATTH}		140	250	ns
t _{MUTE} ⁽¹⁾	DESAT mute time	Output mute time after DESAT fault triggered	15	25	35	us
t _{DES2FLT} ⁽¹⁾	DESAT propagation delay to $\overline{\text{FLT}}$ low	V _{DESATTH} to 90% of $\overline{\text{FLT}}$		135	250	ns
SOFT TURN OFF						
R _{STO}	Internal Soft turn-off Pulldown Resistance	DESAT triggered, V _{OUT} =5V		35		Ω
OVERTEMPERATURE PROTECTION						
T _{SD} ⁽¹⁾	Overtemperature threshold			180		C
T _{HYS} ⁽¹⁾	Overtemperature protection hysteresis			30		C
t _{OTP2FLT} ⁽¹⁾	Propagation delay from overtemperature shutdown to $\overline{\text{FLT}}$	Over temperature shutdown to 90% of $\overline{\text{FLT}}$		8		us
OUTPUT DRIVER STAGE						
I _{SRCPK} ⁽¹⁾	Peak Output Source Current	C _{VDD} = 10 μ F, C _L = 0.1 μ F, f = 1 kHz		-3		A
I _{SNKPK} ⁽¹⁾	Peak Output Sink Current	C _{VDD} = 10 μ F, C _L = 0.1 μ F, f = 1 kHz		3		A
R _{OH}	Pull up resistance	I _{OUT} = -500mA		5		Ω
R _{OL}	Pull down resistance	I _{OUT} = 500mA		1		Ω

(1) Parameters are not tested in production.

5.6 Switching Characteristics

VDD = 15 V, VEE = 0 V, 1- μ F capacitor from VDD to GND, 1- μ F capacitor from VEE to GND, T_J = -40°C to +150°C, C_L = 0 pF, unless otherwise noted. ⁽¹⁾

PARAMETER		TEST CONDITIONS	MIN	TYP	MAX	UNIT
t _{RA} , t _{RB}	Output Rise Time	C _L =1.8nF, 10% to 90%, Vin = 0 to 3.3V		8	18	ns
t _{FA} , t _{FB}	Output Fall Time	C _L =1.8nF, 90% to 10%, Vin = 0 to 3.3V		14	32	ns
t _{D2}	Propagation Delay – Input falling to output falling	C _L =1.8nF, from 1V falling on Vin to 90% of output fall, Vin=0 - 3.3V, Fsw=500kHz, 50% duty cycle		28	50	ns
t _{D1}	Propagation Delay – Input rising to output rising	C _L =1.8nF, from 2V rising on Vin to 10% of output rise, Vin=0 - 3.3V, Fsw=500kHz, 50% duty cycle		26	50	ns
t _{PWmin}	Minimum Input Pulse Width That Passes to Output	C _L =1.8nF, Vin=0 - 3.3V, Fsw=500kHz, Vo > 2V		9	15	ns
t _{PWD}	Pulse Width Distortion	Input Pulse Width = 100ns, 500kHz t _{D2} - t _{D1} , C _L =1.8nF	-10		10	ns

(1) Switching parameters are not tested in production.

5.7 Timing Diagrams

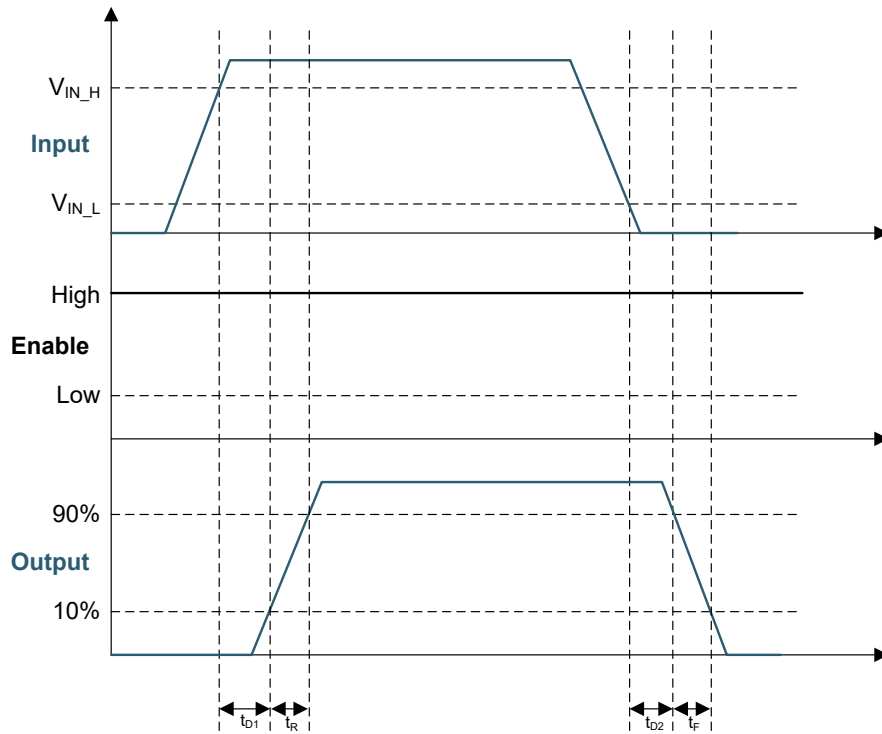

Figure 5-1. Single Input Version, IN = PWM

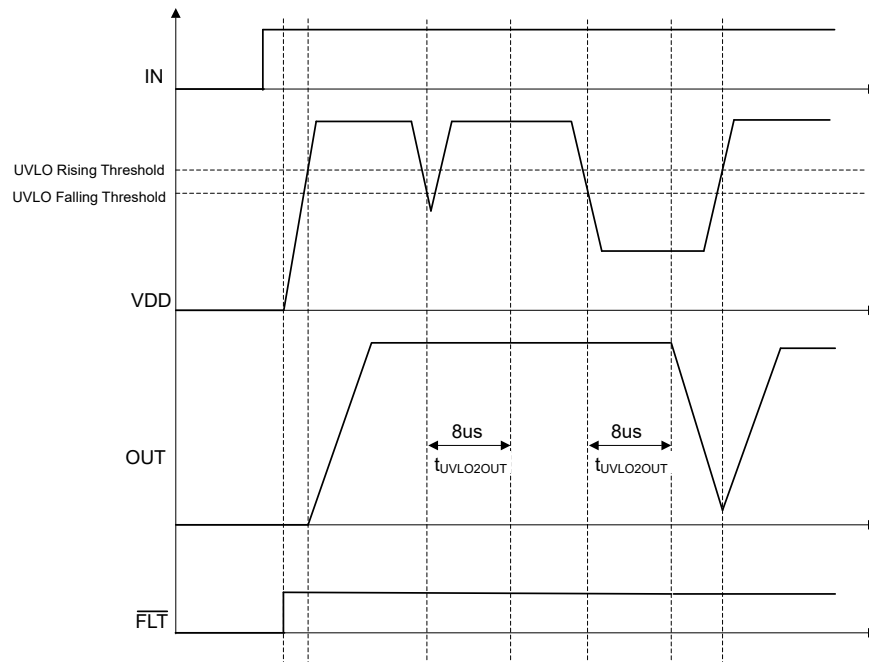

Figure 5-2. UVLO Protection Timing Diagram

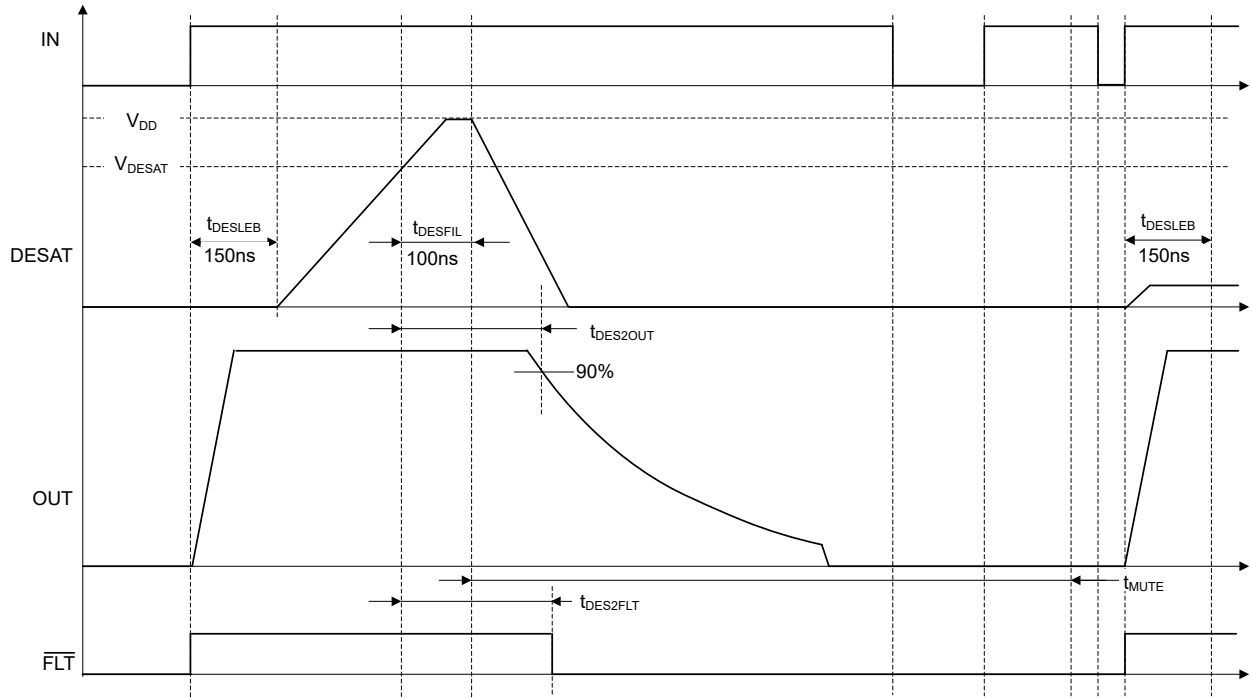

Figure 5-3. DESAT Protection Timing Diagram

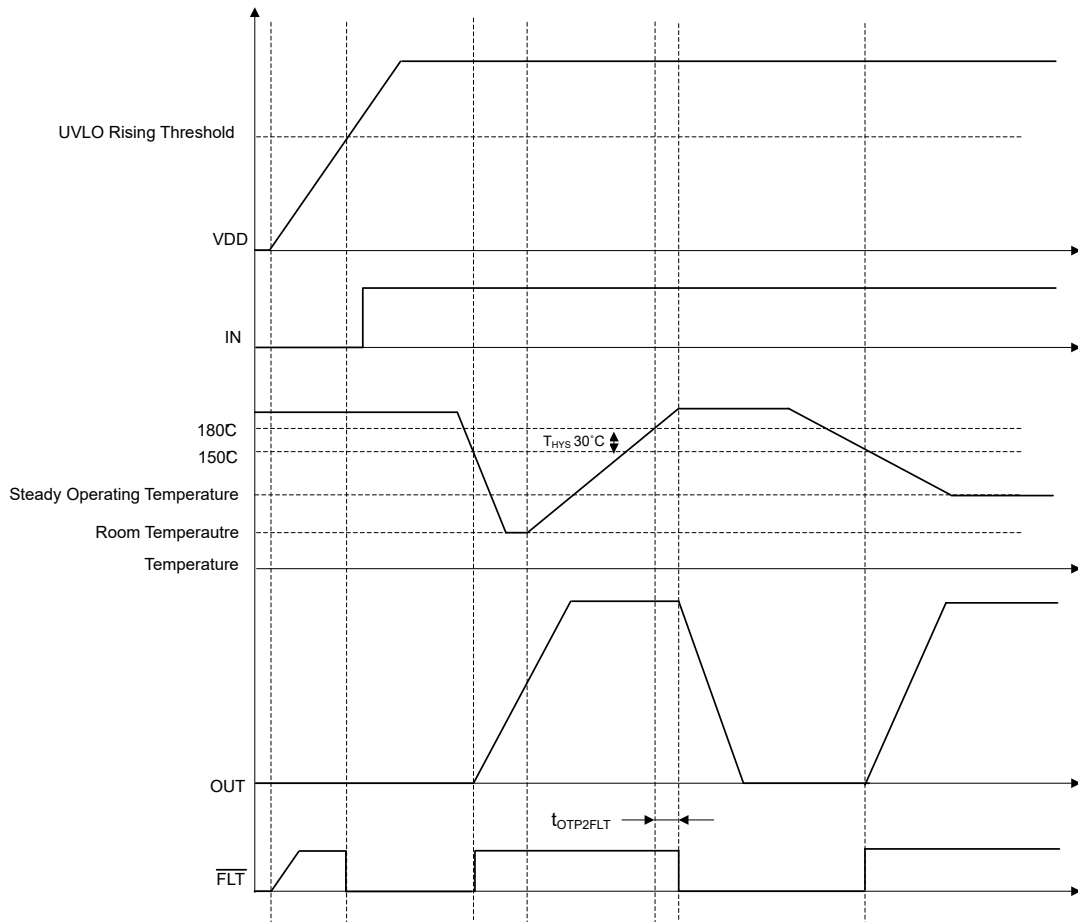

Figure 5-4. Thermal Shutdown Protection Timing Diagram

5.8 Typical Characteristics

Unless otherwise specified, VDD=15V, VEE=0V, IN=3.3V, EN=5V, T_J = 25 °C, No load

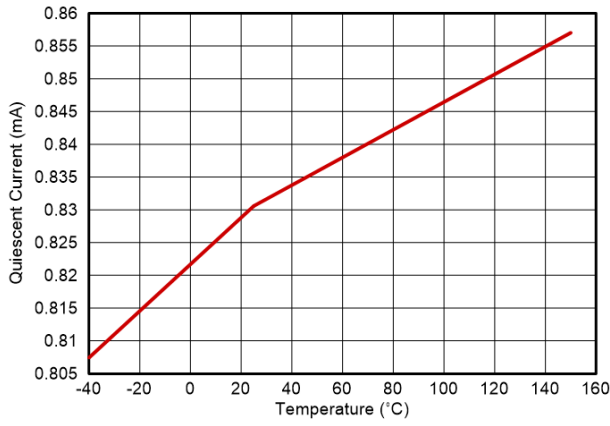

Figure 5-5. Quiescent Current

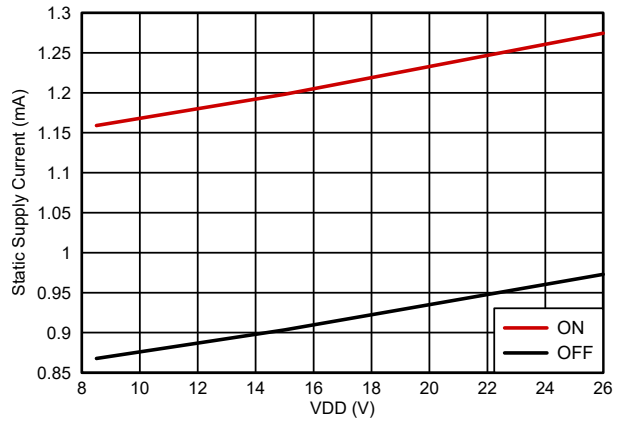

Figure 5-6. Operating Static Supply Current

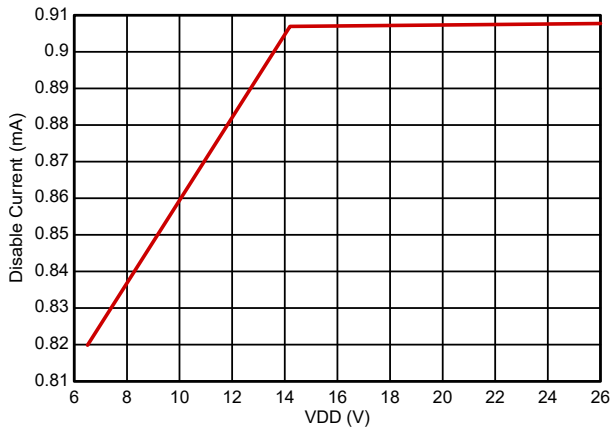

Figure 5-7. Disable Current

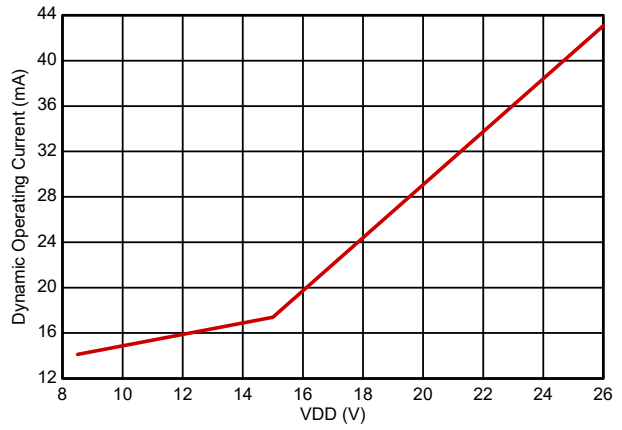

Figure 5-8. Operating Supply Current

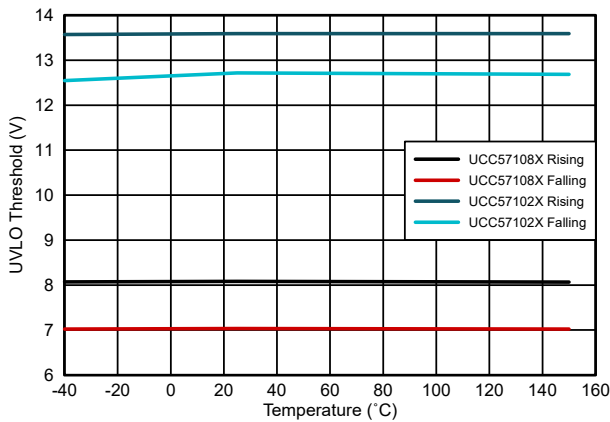

Figure 5-9. UVLO Threshold

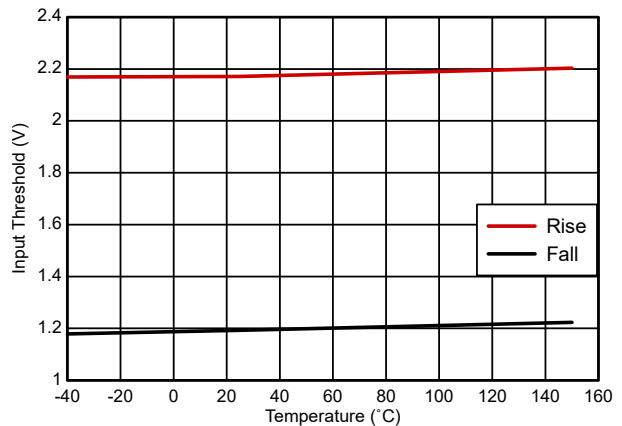

Figure 5-10. Input Threshold

5.8 Typical Characteristics (continued)

Unless otherwise specified, VDD=15V, VEE=0V, IN=3.3V, EN=5V, T_J = 25 °C, No load

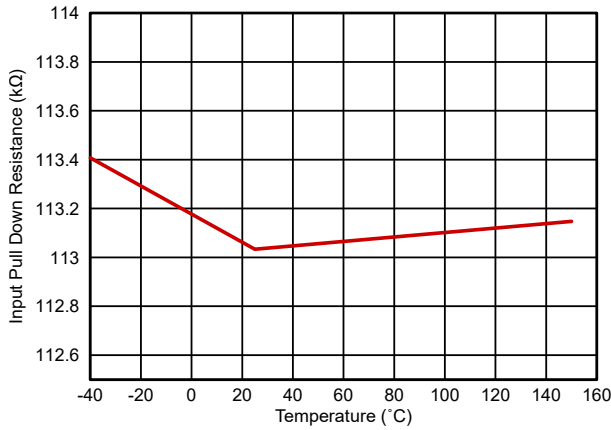

Figure 5-11. Input Pulldown Resistance

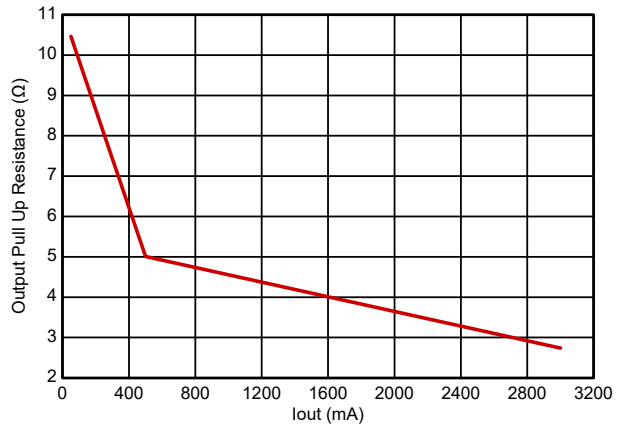

Figure 5-12. Output Pullup Resistance vs VDD

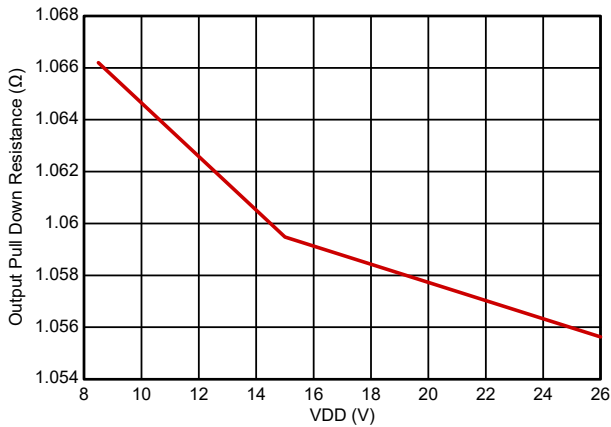

Figure 5-13. Output Pulldown Resistance

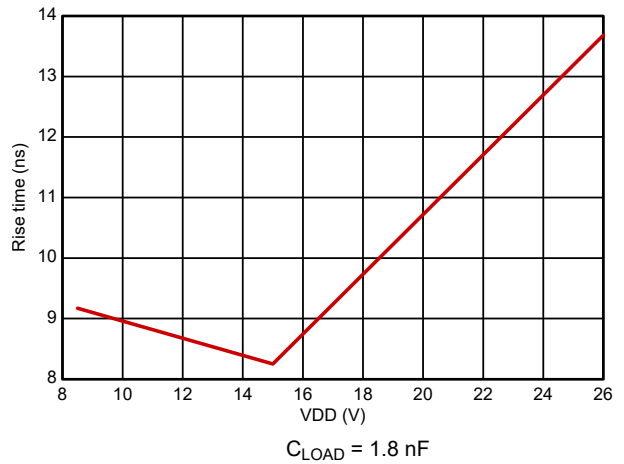

Figure 5-14. Output Rise Time

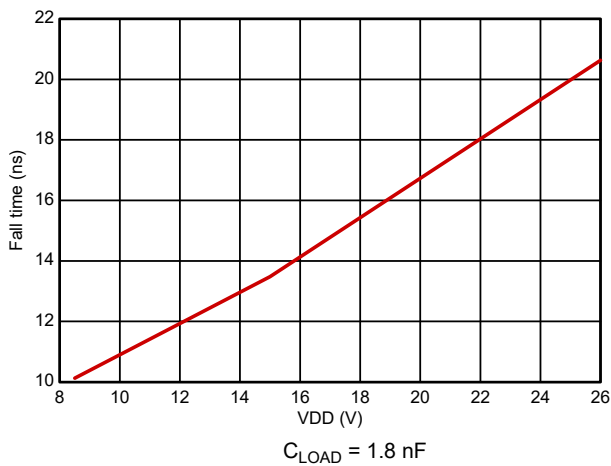

Figure 5-15. Output Fall Time

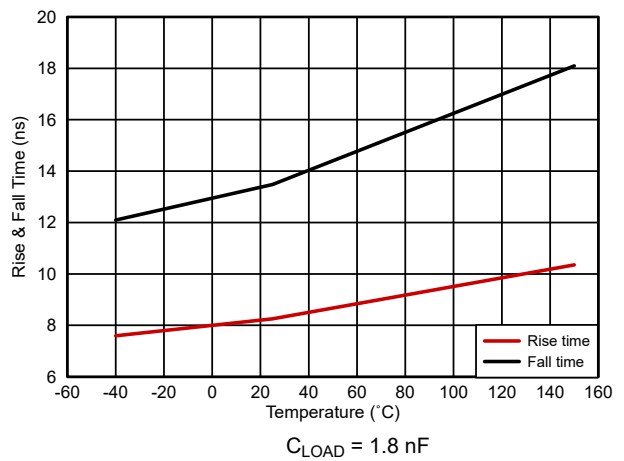

Figure 5-16. Output Rise and Fall Time

5.8 Typical Characteristics (continued)

Unless otherwise specified, VDD=15V, VEE=0V, IN=3.3V, EN=5V, T_J = 25 °C, No load

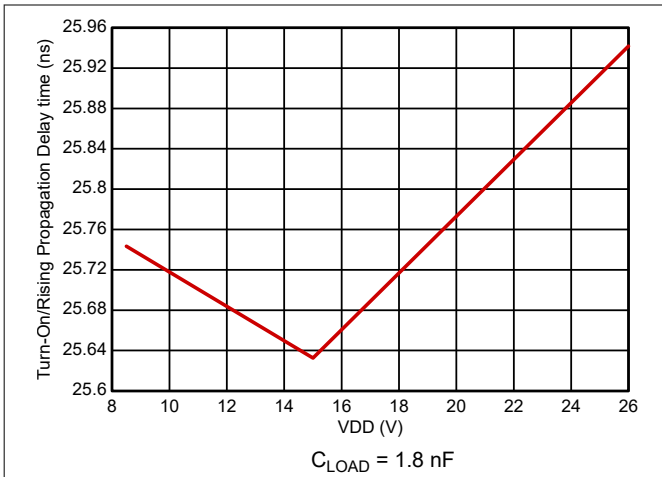

Figure 5-17. Input to Output Rising (Turnon) Propagation Delay

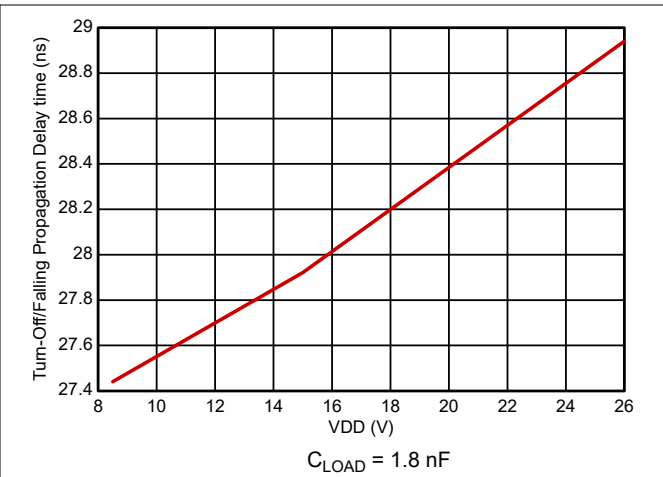

Figure 5-18. Input to Output Falling (Turnoff) Propagation Delay

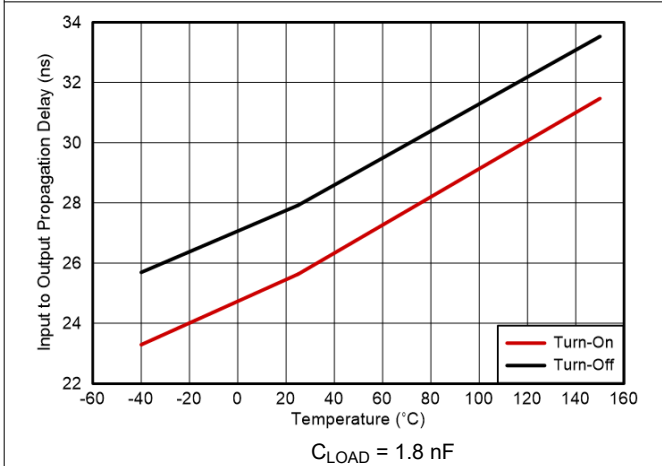

Figure 5-19. Input Propagation Delay

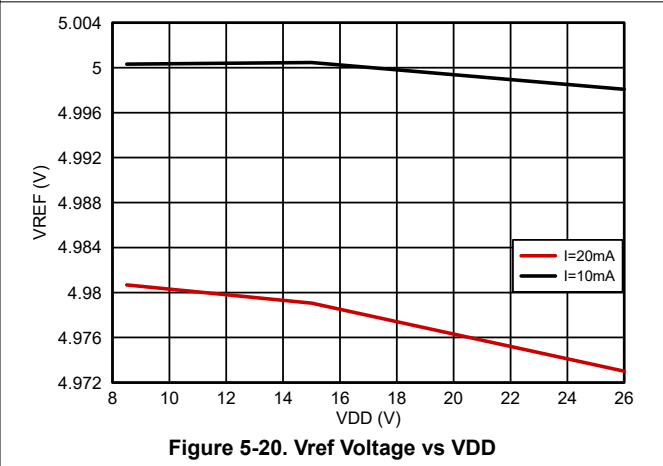

Figure 5-20. Vref Voltage vs VDD

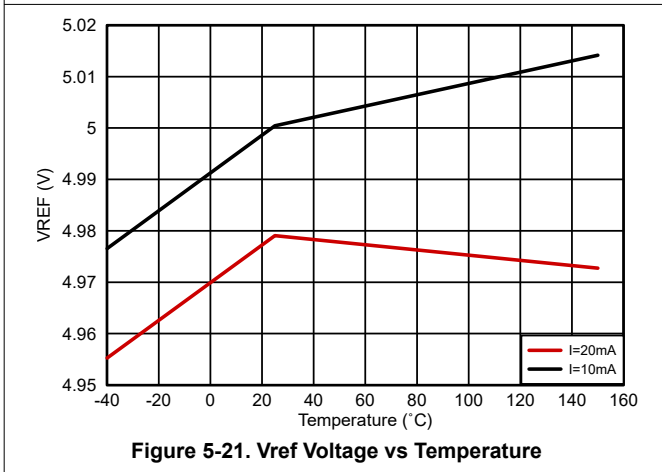

Figure 5-21. Vref Voltage vs Temperature

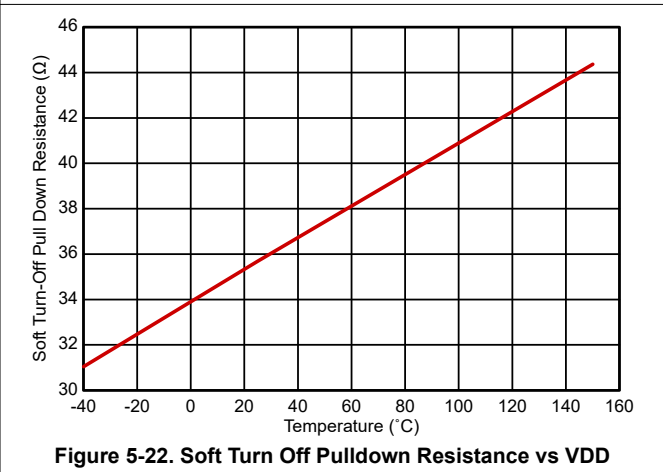

Figure 5-22. Soft Turn Off Pulldown Resistance vs VDD

5.8 Typical Characteristics (continued)

Unless otherwise specified, VDD=15V, VEE=0V, IN=3.3V, EN=5V, T_J = 25 °C, No load

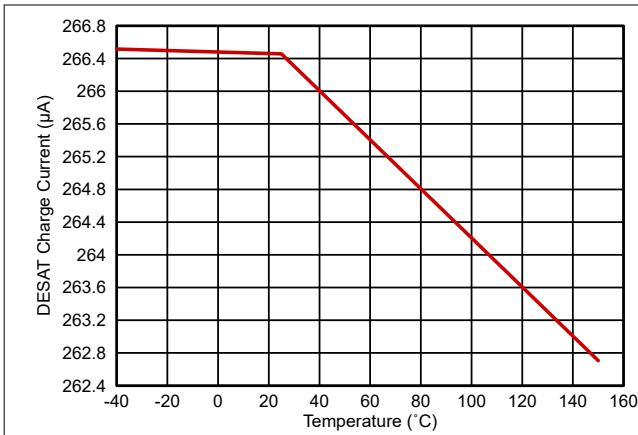

Figure 5-23. DESAT Charge Current vs Temperature

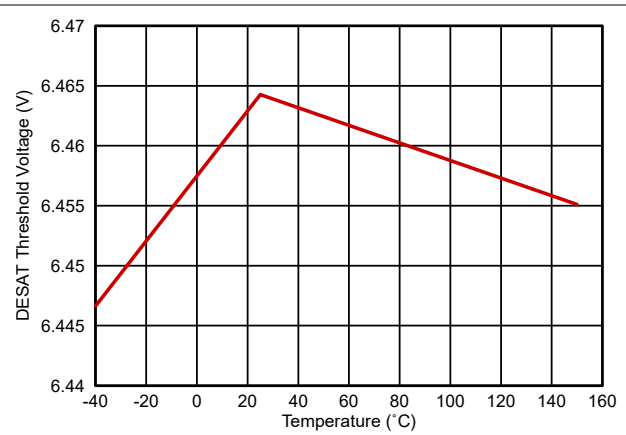

Figure 5-24. DESAT Threshold vs Temperature

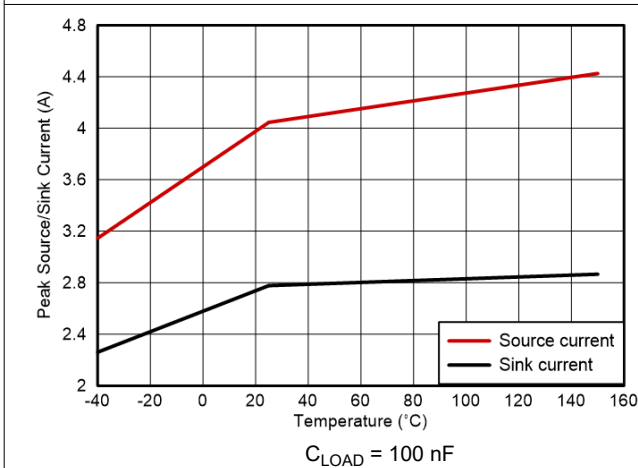

Figure 5-25. Peak Source and Sink Current

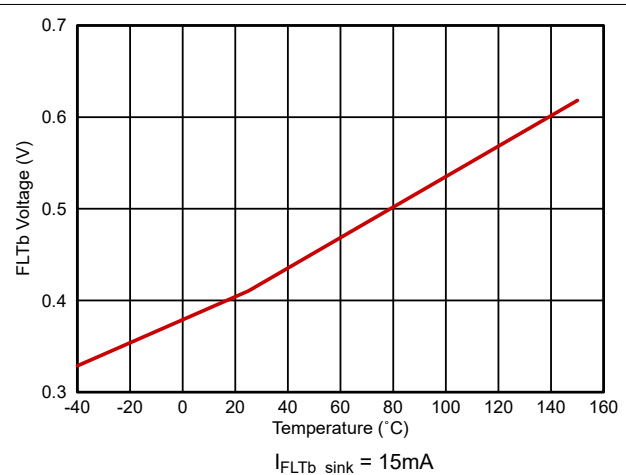

Figure 5-26. FLTb vs Temperature

6 Detailed Description

6.1 Overview

The UCC57102Z-Q1 device is a single-channel, high-speed, gate driver capable of effectively driving MOSFET, SiC MOSFET, and IGBT power switches with 3-A source and 3-A sink (symmetrical drive) peak current. The driver has a good transient handling capability on its output due to reverse currents, as well as rail-to-rail drive capability and small propagation delay, typically 26ns. The device has the state-of-art DESAT detection time and fault reporting function to the low voltage side DSP/MCU. Soft turn off is triggered when the DESAT fault is detected, minimizing the short circuit energy while reducing the overshoot voltage on the switch.

The input threshold of the UCC57102Z-Q1 is compatible to TTL low-voltage logic, which is fixed and independent of VDD supply voltage. The driver can also work with CMOS based controllers as long as the threshold requirement is met. The 1-V typical hysteresis offers excellent noise immunity.

In the UCC57102Z-Q1 the driver has an EN pin with fixed TTL compatible threshold. EN is internally pulled up. Pulling EN low disables the driver, while leaving EN open provides normal operation. The and UCC57102Z-Q1 offer an additional 5V output (VREF) that source up to 20mA function.

6.2 Functional Block Diagram

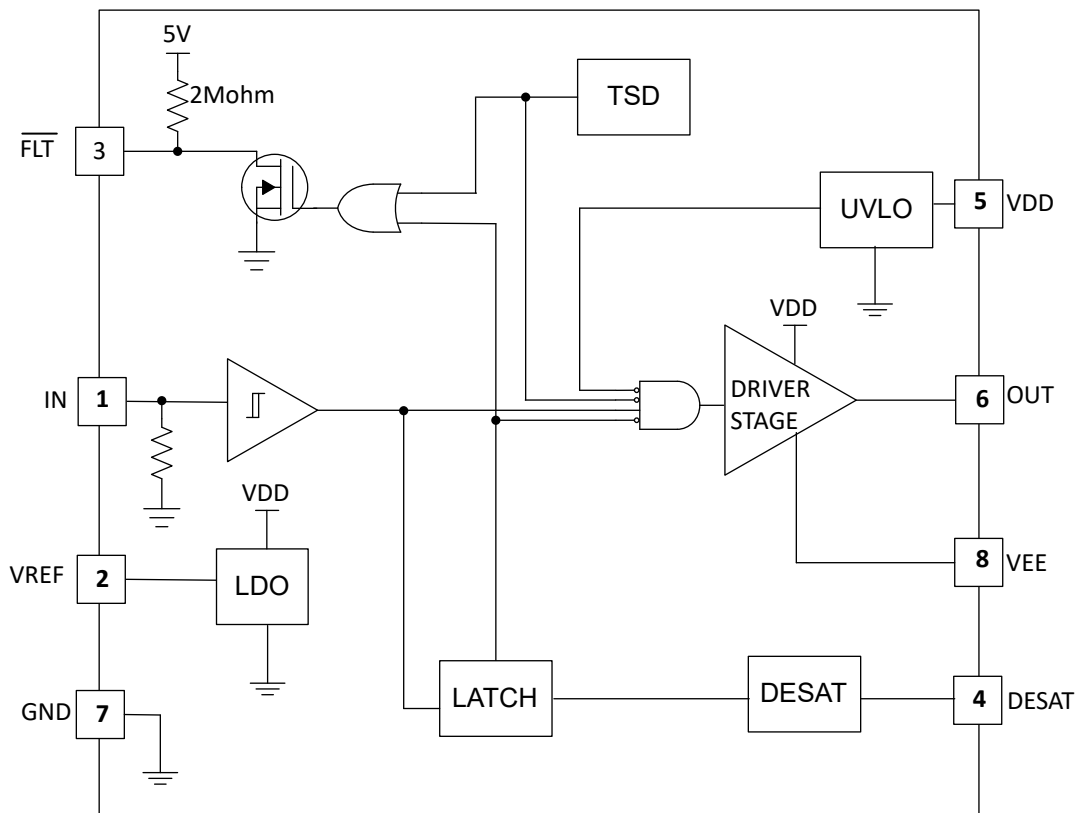

Figure 6-1. UCC57102Z-Q1 Simplified Functional Block Diagram

6.3 Feature Description

6.3.1 Input Stage

The inputs of the UCC57102Z-Q1 device are compatible with TTL based threshold logic and the inputs are independent of the VDD supply voltage. With typical high threshold of 2.2 V and typical low threshold of 1.2 V, the logic level thresholds can be conveniently driven with PWM control signals derived from 3.3-V or 5-V logic. Wider hysteresis (typically 1 V) offers enhanced noise immunity compared to traditional TTL logic implementations, where the hysteresis is typically less than 0.5 V. This device also features tight control of

the input pin threshold voltage levels which eases system design considerations and ensures stable operation across temperature. The very low input capacitance, typically less than 8 pF, on these pins reduces loading and increases switching speed.

The device features an important protection function wherein, whenever the input pin is in a floating condition, the output is held in the low state. This is achieved with internal pullup or pulldown resistors on the input pins as shown in the simplified functional block diagrams. In some applications, due to difference in bias supply sequencing, different ICs power-up at different times. This may cause output of the controller to be in tri-state. This output of the controller is connected to the input of the driver IC. If the driver IC does not have a pulldown resistor then the output of the driver may go high erroneously and damage the switching power device.

The input stage of the driver should preferably be driven by a signal with a short rise or fall time. Caution must be exercised whenever the driver is used with slowly varying input signals, especially in situations where the device is located on a separate daughter board or PCB layout has long input connection traces:

- High dI/dt current from the driver output coupled with board layout parasitics can cause ground bounce. Because the device features just one GND pin which may be referenced to the power ground, this may interfere with the differential voltage between input pins and GND and trigger an unintended change of output state. Because of a fast 26-ns propagation delay, this can ultimately result in high-frequency oscillations, which increases power dissipation and poses risk of damage.
- 1-V Input threshold hysteresis boosts noise immunity compared to most other industry standard drivers.

An external resistance is highly recommended between the output of the driver and the power device instead of adding delays on the input signal. This also limits the rise or fall times to the power device which reduces EMI. The external resistor has the additional benefit of reducing part of the gate charge related power dissipation in the gate driver device package and transferring it into the external resistor itself.

Finally, because of the unique input structure that allows negative voltage capability on the input and enable pins, caution must be used in the following applications:

- Input or enable pins are switched to amplitude > 15 V.
- Input or enable pins are switched at $dV/dt > 2$ V/ns.

If both of these conditions occur, add a series 150- Ω resistor for the pin(s) being switched to limit the current through the input structure.

6.3.2 Driver Stage

The device has a ± 3 -A peak drive strength and is suitable for driving IGBT/SiC. The driver features an important safety function wherein, when the input pins are in a floating condition, the output is held in the LOW state. The driver has rail-to-rail output by implementing an NMOS pull-up with intrinsic bootstrap gate drive. Under DC conditions, a PMOS is used to keep OUT tied to VDD as shown in the following figure. The low pullup impedance of the NMOS results in strong drive strength during the turn-on transient, which shortens the charging time of the input capacitance of the power semiconductor and reduces the turn on switching loss.

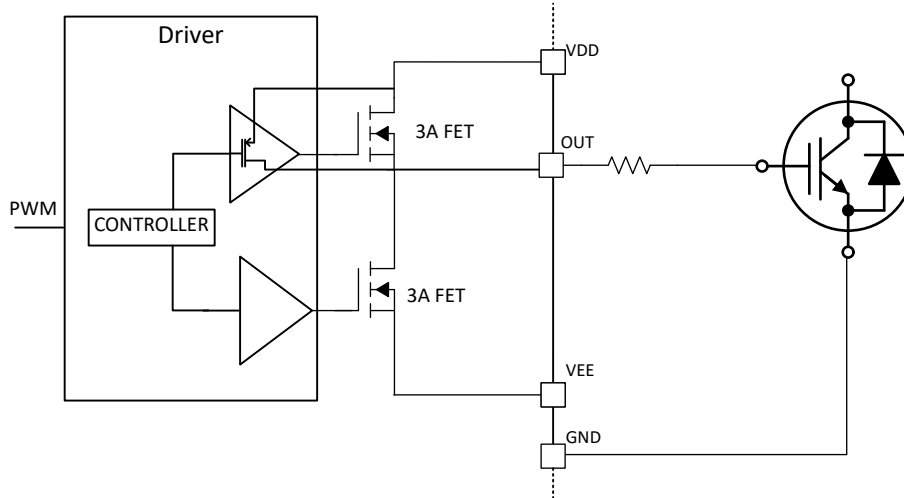

Figure 6-2. Gate Driver Output Stage

6.3.3 Desaturation (DESAT) Protection

The UCC57102Z-Q1 implements a fast overcurrent and short circuit protection feature to protect the MOSFET/IGBT from catastrophic breakdown during a fault. The DESAT pin has a typical 6.5 V threshold with respect to GND, the source or emitter of the power semiconductor. When the input is in a floating condition or the output is held in the LOW state, the DESAT pin is pulled down by an internal MOSFET and held in the LOW state, which prevents the overcurrent and short circuit fault from false triggering. The internal current source of the DESAT pin is activated only during the driver ON state, which means the overcurrent and short circuit protection feature only works when the power semiconductor is in the ON state. The internal pulldown MOSFET helps to discharge the voltage of the DESAT pin when the power semiconductor is turned off. The device features a 150-ns internal leading edge blanking time after OUT switches to the HIGH state. Also, the OUT stay low for 25 μ s T_{mute} time after the DESAT is triggered. The \overline{FLT} will resume high at the first IN raising edge once the T_{mute} time expired. The UCC57102Z-Q1 internal current source is activated to charge the external blanking capacitor after the internal leading edge blanking time. The typical value of the internal current source is 250 μ A. More details about the DESAT circuit design can be found in [Applications and Benefits of UCC5710x-Q1](#).

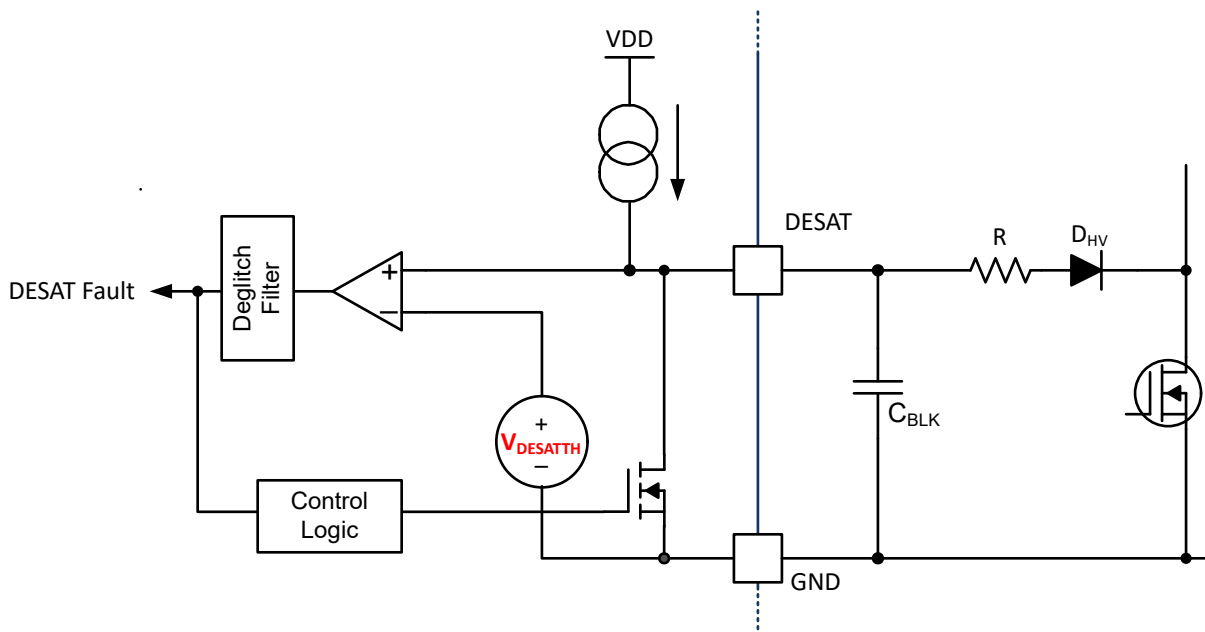

Figure 6-3. DESAT Protection

6.3.4 Fault (\overline{FLT})

The \overline{FLT} pin of the UCC57102Z-Q1 can report a fault signal to the DSP/MCU when a fault is detected through the DESAT pin and internal TSD. The \overline{FLT} pin is pulled down to GND after the fault is detected and is held low until the fault is cleared. It can be pull up to external voltage rail up to VDD level with the consideration that the maximum sink current on the \overline{FLT} is 20mA. Also a 100pF capacitor between \overline{FLT} and GND is recommended.

6.3.5 VREF

The UCC57102Z-Q1 device provides the 5V bias integrated in to the gate driver. This output is capable of sourcing up to 20mA. for voltage sensing modulators, current-sensing modulators or other external comparator interface. A 100nF bypass capacitor is required on the VREF pin even it is bias any external functions. The detail performance for VREF pin can be found in the [Typical Characteristics](#).

6.3.6 Thermal Shutdown

The UCC57102Z-Q1 device provides the thermal shutdown function that can protect the driver when the internal temperature goes above threshold. When the it excess the overtemperature threshold, the \overline{FLT} will be pulled low after the 8us propagation delay. The device will active again once the temperature falls below the threshold. More information can be found in the [Section 5.7](#)

6.4 Device Functional Modes

The UCC57102Z-Q1 device operates in normal mode and UVLO mode (see [Section 7.2.2.1](#) for information on UVLO operation). In normal mode, the output state is dependent on the states of the device and the input pins.

The UCC57102Z-Q1 features a single, noninverting input, but also contains enable and disable functionality through the EN pin. Setting the EN pin to logic HIGH enables the noninverting input to output on the IN pin.

Table 6-1. UCC57102Z-Q1 Truth Table

IN	DESAT	INTERNAL TSD	\overline{FLT}	OUT
H	L	L	Open drain	H
L	L	L	Open drain	L
H	H	L	L	L
X	X	H	L	L

7 Applications and Implementation

Note

Information in the following applications sections is not part of the TI component specification, and TI does not warrant its accuracy or completeness. TI's customers are responsible for determining suitability of components for their purposes, as well as validating and testing their design implementation to confirm system functionality.

7.1 Application Information

High-current gate driver devices are required in switching power applications for a variety of reasons. To enable fast switching of power devices and reduce associated switching power losses, a powerful gate driver can be employed between the PWM output of controllers or signal isolation devices and the gates of the power semiconductor devices. Further, gate drivers are indispensable when sometimes it is just not feasible to have the PWM controller directly drive the gates of the switching devices. The situation is often encountered because the PWM signal from a digital controller or signal isolation device is often a 3.3-V or 5-V logic signal which is not capable of effectively turning on a power switch. Level-shifting circuitry is needed to boost the logic-level signal to the gate-drive voltage in order to fully turn on the power device and minimize conduction losses. Traditional buffer drive circuits based on NPN/PNP bipolar (or P- N-channel MOSFET) transistors in a totem-pole arrangement, being emitter follower configurations, prove inadequate for this because they lack level-shifting capability and low-drive voltage protection. Gate drivers effectively combine both the level-shifting, buffer drive, and UVLO functions. Gate drivers also find other needs such as minimizing the effect of switching noise by locating the high-current driver physically close to the power switch, driving gate-drive transformers and controlling floating power device gates, reducing power dissipation and thermal stress in controllers by moving gate charge power losses into itself.

The UCC57102Z-Q1 is very flexible in this role with a strong drive current capability and wide recommended supply voltage range of UVLO to 26 V. This allows the driver to be used in 5-V bias logic level very high frequency MOSFET applications, 12-V MOSFET applications, 20-V and -5-V (relative to source) SiC FET applications, 15-V and -8-V (relative to emitter) IGBT applications and many others.

These requirements, coupled with the need for low propagation delays and availability in compact, and low-inductance packages with good thermal capability, make gate driver devices such as the UCC57102Z-Q1 extremely important components in switching power combining benefits of high-performance, low cost, low component count, board space reduction and simplified system design.

7.2 Typical Application

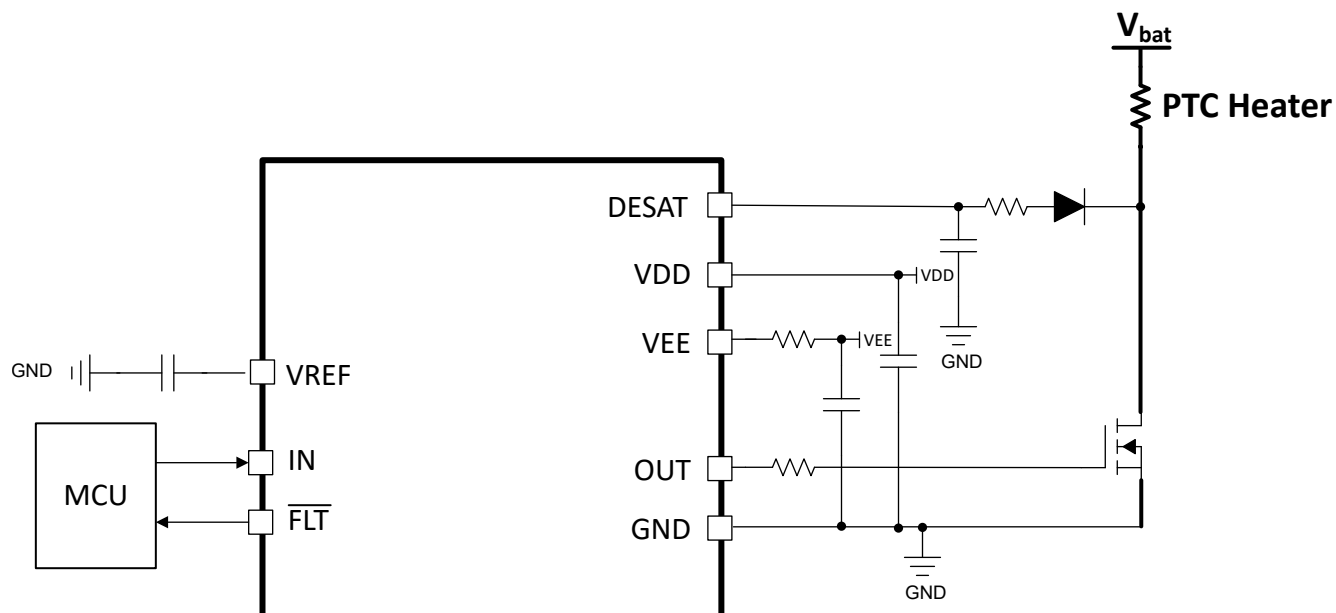

Figure 7-1. UCC57102Z-Q1 Used in a PTC Heater Application

7.2.1 Design Requirements

When selecting the gate driver device for an end application, some design considerations must be evaluated in order to make the most appropriate selection. Following are some of the design parameters that should be used when selecting the gate driver device for an end application: input-to-output configuration, the input threshold type, bias supply voltage levels, peak source and sink currents, availability of independent enable and disable functions, propagation delay, power dissipation, and package type. Example design parameters and requirements are listed in [Table 7-1](#).

Table 7-1. Design Parameters

DESIGN PARAMETER	EXAMPLE VALUE
Input to output logic	Noninverting
Input threshold type	TTL
Bias supply voltage levels	+18 V
Negative output low voltage	N/A
$dV_{DS}/dt^{(1)}$	100 V/ns
Enable function	Yes
Disable function	N/A
Propagation delay	<30 ns
Power dissipation	<1 W
Package type	SON-8 or SOIC-8

(1) dV_{DS}/dt is a typical requirement for a given design. This value can be used to find the peak source/sink currents needed as shown in .

7.2.2 Detailed Design Procedure

7.2.2.1 VDD Undervoltage Lockout

The UCC57102Z-Q1 device offers an undervoltage lockout threshold of 8 V and the UCC57102Z-Q1 provides an undervoltage lockout threshold of 12V. The device's hysteresis range helps to avoid any chattering due to the presence of noise on the bias supply. 1V of typical UVLO hysteresis is expected. There is no significant driver

output turnon delay due to the UVLO feature, and 4 μs of UVLO delay is expected. The UVLO turn-off delay is also minimized as much as possible. The UVLO delay is designed to minimize chattering that may occur due to very fast transients that may appear on VDD. When the bias supply is below UVLO thresholds, the outputs are held actively low irrespective of the state of the input pins and enable pin. The device accepts a wide range of slew rates on its VDD pin, and VDD noise within the hysteresis range does not affect the output state of the driver (neither ON nor OFF).

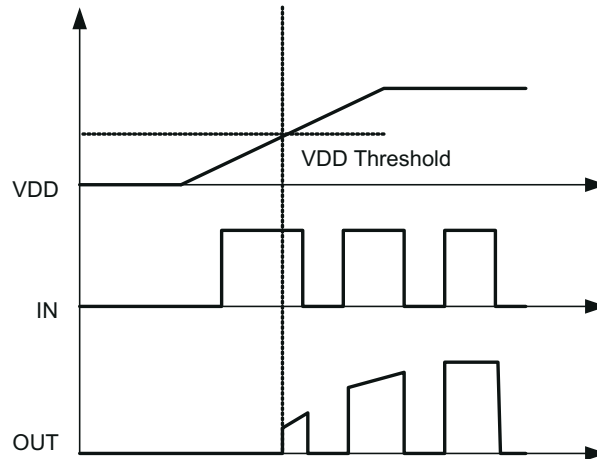

Figure 7-2. Power Up

7.2.3 Application Curves

The figures below show the typical switching characteristics of the UCC57102Z-Q1 device with a 1nF capacitor load.

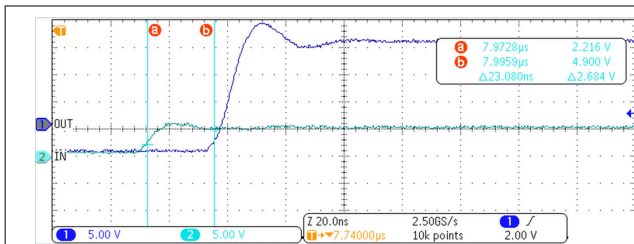

Figure 7-3. UCC57102Z-Q1 Rising (Turn-On) Propagation Delay

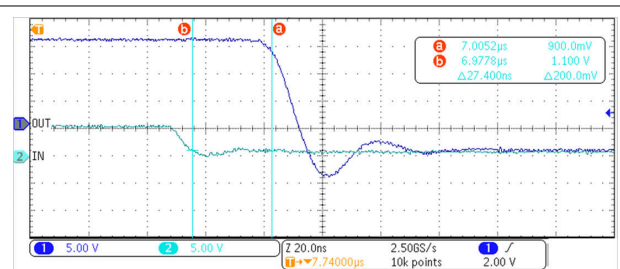

Figure 7-4. UCC57102Z-Q1 Falling (Turn-Off) Propagation Delay

8 Power Supply Recommendations

The bias supply voltage range for which the UCC57102Z-Q1 device is recommended to operate is from UVLO to 26 V. The lower end of this range is governed by the internal UVLO protection feature on the VDD pin supply circuit blocks. Whenever the driver is in UVLO condition when the VDD pin voltage is below the $V_{(ON)}$ supply start threshold, this feature holds the output low, regardless of the status of the inputs. The upper end of this range is driven by the 26-V recommended maximum voltage rating of the VDD pin of the device. The absolute maximum voltage for the VDD pin is 30 V.

The UVLO protection feature also involves a hysteresis function. This means that when the VDD pin bias voltage has exceeded the threshold voltage and the device begins to operate, and if the voltage drops, then the device continues to deliver normal functionality unless the voltage drop exceeds the hysteresis specification. Therefore, ensuring that, while operating at or near the UVLO range, the voltage ripple on the auxiliary power supply output is smaller than the hysteresis specification of the device is important to avoid triggering device shutdown.

During system shutdown, device operation continues until the VDD pin voltage has dropped below the VDD UVLO falling threshold which must be accounted for while evaluating system shutdown timing design requirements. Likewise, at system start-up, the device does not begin operation until the VDD pin voltage has exceeded the VDD UVLO rising threshold. The quiescent current consumed by the internal circuit blocks of the device is supplied through the VDD pin. Although this fact is well known, recognizing that the charge for source current pulses delivered by the OUT pin is also supplied through the same VDD pin is important. As a result, every time a current is sourced out of the output pin (OUT), a corresponding current pulse is delivered into the device through the VDD pin. Thus ensuring that local bypass capacitors are provided between the VDD and GND pins and located as close to the device as possible for the purpose of decoupling is important. A low-ESR, ceramic surface-mount capacitor is needed. TI recommends having two capacitors; a 100-nF ceramic surface-mount capacitor placed less than 1mm from the VDD pin of the device and another ceramic surface-mount capacitor of a few microfarads added in parallel.

The UCC57102Z-Q1 is a high current gate driver. If the gate driver is placed far from a switching power device such as a MOSFET then that may create a large inductive loop. A large inductive loop may cause excessive ringing on any and all pins of the gate driver. This may result in stress exceeding device recommended ratings. Therefore, it is recommended to place the gate driver as close to the switching power device as possible. It is also advisable to use an external gate resistor to damp any ringing due to high switching currents and board parasitic elements.

9 Layout

9.1 Layout Guidelines

Proper PCB layout is extremely important in a high-current, fast-switching circuit to provide appropriate device operation and design robustness. The UCC57102Z-Q1 gate driver incorporates short propagation delays and powerful output stages capable of delivering large current peaks with very fast rise and fall times at the gate of a power switch to facilitate voltage transitions very quickly. Very high di/dt can cause unacceptable ringing if the trace lengths and impedances are not well controlled. The following circuit layout guidelines are recommended when designing with these high-speed drivers.

- Place the driver device as close as possible to power device to minimize the length of high-current traces between the driver output pins and the gate of the power switch device.
- Place the bypass capacitors between the VDD pin and the GND pin and as close to the driver pins as possible to minimize the trace length for improved noise filtering. TI recommends having two capacitors; a 100-nF ceramic surface-mount capacitor placed less than 1mm from the VDD pin of the device and another ceramic surface-mount capacitor of a few microfarads added in parallel. These capacitors support high peak current being drawn from VDD during turnon of the power switch. The use of low inductance surface-mount components such as chip capacitors is highly recommended.
- The turnon and turn-off current loop paths (driver device, power switch, and VDD bypass capacitor) should be minimized as much as possible in order to keep stray inductance to a minimum. High di/dt is established in these loops at two instances – during turnon and turn-off transients, which induces significant voltage transients on the output pins of the driver device and gate of the power switch.
- Wherever possible, parallel the source and return traces of a current loop, taking advantage of flux cancellation
- Separate power traces and signal traces, such as output and input signals.
- To minimize switch node transients and ringing, adding some gate resistance and/or snubbers on the power devices may be necessary. These measures may also reduce EMI.
- Star-point grounding is a good way to minimize noise coupling from one current loop to another. The GND of the driver should be connected to the other circuit nodes such as the source of the power switch, the ground of the PWM controller, and so forth, at a single point. The connected paths should be as short as possible to reduce inductance and be as wide as possible to reduce resistance.
- Use a ground plane to provide noise shielding. Fast rise and fall times at the OUT pin may corrupt the input signals during transitions. The ground plane must not be a conduction path for any current loop. Instead the ground plane should be connected to the star-point with one trace to establish the ground potential. In addition to noise shielding, the ground plane can help in power dissipation as well.

9.2 Layout Example

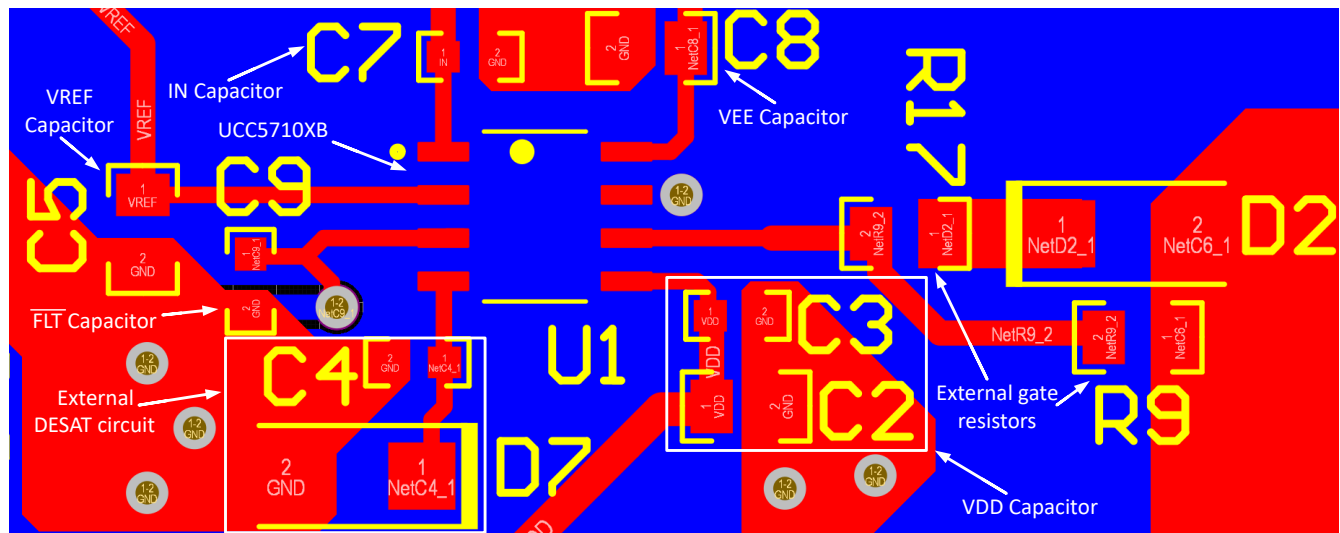

Figure 9-1. Layout Example: UCC57102Z

10 Device and Documentation Support

10.1 Third-Party Products Disclaimer

TI'S PUBLICATION OF INFORMATION REGARDING THIRD-PARTY PRODUCTS OR SERVICES DOES NOT CONSTITUTE AN ENDORSEMENT REGARDING THE SUITABILITY OF SUCH PRODUCTS OR SERVICES OR A WARRANTY, REPRESENTATION OR ENDORSEMENT OF SUCH PRODUCTS OR SERVICES, EITHER ALONE OR IN COMBINATION WITH ANY TI PRODUCT OR SERVICE.

10.2 Receiving Notification of Documentation Updates

To receive notification of documentation updates, navigate to the device product folder on ti.com. Click on *Notifications* to register and receive a weekly digest of any product information that has changed. For change details, review the revision history included in any revised document.

10.3 Support Resources

TI E2E™ [support forums](#) are an engineer's go-to source for fast, verified answers and design help — straight from the experts. Search existing answers or ask your own question to get the quick design help you need.

Linked content is provided "AS IS" by the respective contributors. They do not constitute TI specifications and do not necessarily reflect TI's views; see TI's [Terms of Use](#).

10.4 Trademarks

TI E2E™ is a trademark of Texas Instruments.
All trademarks are the property of their respective owners.

10.5 Electrostatic Discharge Caution



This integrated circuit can be damaged by ESD. Texas Instruments recommends that all integrated circuits be handled with appropriate precautions. Failure to observe proper handling and installation procedures can cause damage.

ESD damage can range from subtle performance degradation to complete device failure. Precision integrated circuits may be more susceptible to damage because very small parametric changes could cause the device not to meet its published specifications.

10.6 Glossary

[TI Glossary](#) This glossary lists and explains terms, acronyms, and definitions.

11 Revision History

NOTE: Page numbers for previous revisions may differ from page numbers in the current version.

DATE	REVISION	NOTES
December 2024	*	Initial Release

12 Mechanical, Packaging, and Orderable Information

The following pages include mechanical, packaging, and orderable information. This information is the most current data available for the designated devices. This data is subject to change without notice and revision of this document. For browser-based versions of this data sheet, refer to the left-hand navigation.

PACKAGING INFORMATION

Orderable Device	Status (1)	Package Type	Package Drawing	Pins	Package Qty	Eco Plan (2)	Lead finish/ Ball material (6)	MSL Peak Temp (3)	Op Temp (°C)	Device Marking (4/5)	Samples
UCC57102ZQDRQ1	ACTIVE	SOIC	D	8	2500	RoHS & Green	NIPDAU	Level-1-260C-UNLIM	-40 to 125	U102ZQ	Samples

(1) The marketing status values are defined as follows:

ACTIVE: Product device recommended for new designs.

LIFEBUY: TI has announced that the device will be discontinued, and a lifetime-buy period is in effect.

NRND: Not recommended for new designs. Device is in production to support existing customers, but TI does not recommend using this part in a new design.

PREVIEW: Device has been announced but is not in production. Samples may or may not be available.

OBSELETE: TI has discontinued the production of the device.

(2) **RoHS:** TI defines "RoHS" to mean semiconductor products that are compliant with the current EU RoHS requirements for all 10 RoHS substances, including the requirement that RoHS substance do not exceed 0.1% by weight in homogeneous materials. Where designed to be soldered at high temperatures, "RoHS" products are suitable for use in specified lead-free processes. TI may reference these types of products as "Pb-Free".

RoHS Exempt: TI defines "RoHS Exempt" to mean products that contain lead but are compliant with EU RoHS pursuant to a specific EU RoHS exemption.

Green: TI defines "Green" to mean the content of Chlorine (Cl) and Bromine (Br) based flame retardants meet JS709B low halogen requirements of <=1000ppm threshold. Antimony trioxide based flame retardants must also meet the <=1000ppm threshold requirement.

(3) MSL, Peak Temp. - The Moisture Sensitivity Level rating according to the JEDEC industry standard classifications, and peak solder temperature.

(4) There may be additional marking, which relates to the logo, the lot trace code information, or the environmental category on the device.

(5) Multiple Device Markings will be inside parentheses. Only one Device Marking contained in parentheses and separated by a "-" will appear on a device. If a line is indented then it is a continuation of the previous line and the two combined represent the entire Device Marking for that device.

(6) Lead finish/Ball material - Orderable Devices may have multiple material finish options. Finish options are separated by a vertical ruled line. Lead finish/Ball material values may wrap to two lines if the finish value exceeds the maximum column width.

Important Information and Disclaimer:The information provided on this page represents TI's knowledge and belief as of the date that it is provided. TI bases its knowledge and belief on information provided by third parties, and makes no representation or warranty as to the accuracy of such information. Efforts are underway to better integrate information from third parties. TI has taken and continues to take reasonable steps to provide representative and accurate information but may not have conducted destructive testing or chemical analysis on incoming materials and chemicals. TI and TI suppliers consider certain information to be proprietary, and thus CAS numbers and other limited information may not be available for release.

In no event shall TI's liability arising out of such information exceed the total purchase price of the TI part(s) at issue in this document sold by TI to Customer on an annual basis.

TAPE AND REEL INFORMATION

QUADRANT ASSIGNMENTS FOR PIN 1 ORIENTATION IN TAPE

*All dimensions are nominal

Device	Package Type	Package Drawing	Pins	SPQ	Reel Diameter (mm)	Reel Width W1 (mm)	A0 (mm)	B0 (mm)	K0 (mm)	P1 (mm)	W (mm)	Pin1 Quadrant
UCC57102ZQDRQ1	SOIC	D	8	2500	330.0	12.5	6.4	5.2	2.1	8.0	12.0	Q1

TAPE AND REEL BOX DIMENSIONS

*All dimensions are nominal

Device	Package Type	Package Drawing	Pins	SPQ	Length (mm)	Width (mm)	Height (mm)
UCC57102ZQDRQ1	SOIC	D	8	2500	340.5	338.1	20.6



D0008A

PACKAGE OUTLINE

SOIC - 1.75 mm max height

SMALL OUTLINE INTEGRATED CIRCUIT



NOTES:

1. Linear dimensions are in inches [millimeters]. Dimensions in parenthesis are for reference only. Controlling dimensions are in inches. Dimensioning and tolerancing per ASME Y14.5M.
2. This drawing is subject to change without notice.
3. This dimension does not include mold flash, protrusions, or gate burrs. Mold flash, protrusions, or gate burrs shall not exceed $.006$ [0.15] per side.
4. This dimension does not include interlead flash.
5. Reference JEDEC registration MS-012, variation AA.

EXAMPLE BOARD LAYOUT

D0008A

SOIC - 1.75 mm max height

SMALL OUTLINE INTEGRATED CIRCUIT



LAND PATTERN EXAMPLE
 EXPOSED METAL SHOWN
 SCALE:8X



SOLDER MASK DETAILS

4214825/C 02/2019

NOTES: (continued)

- 6. Publication IPC-7351 may have alternate designs.
- 7. Solder mask tolerances between and around signal pads can vary based on board fabrication site.

EXAMPLE STENCIL DESIGN

D0008A

SOIC - 1.75 mm max height

SMALL OUTLINE INTEGRATED CIRCUIT



SOLDER PASTE EXAMPLE
BASED ON .005 INCH [0.125 MM] THICK STENCIL
SCALE:8X

4214825/C 02/2019

NOTES: (continued)

8. Laser cutting apertures with trapezoidal walls and rounded corners may offer better paste release. IPC-7525 may have alternate design recommendations.
9. Board assembly site may have different recommendations for stencil design.

IMPORTANT NOTICE AND DISCLAIMER

TI PROVIDES TECHNICAL AND RELIABILITY DATA (INCLUDING DATA SHEETS), DESIGN RESOURCES (INCLUDING REFERENCE DESIGNS), APPLICATION OR OTHER DESIGN ADVICE, WEB TOOLS, SAFETY INFORMATION, AND OTHER RESOURCES "AS IS" AND WITH ALL FAULTS, AND DISCLAIMS ALL WARRANTIES, EXPRESS AND IMPLIED, INCLUDING WITHOUT LIMITATION ANY IMPLIED WARRANTIES OF MERCHANTABILITY, FITNESS FOR A PARTICULAR PURPOSE OR NON-INFRINGEMENT OF THIRD PARTY INTELLECTUAL PROPERTY RIGHTS.

These resources are intended for skilled developers designing with TI products. You are solely responsible for (1) selecting the appropriate TI products for your application, (2) designing, validating and testing your application, and (3) ensuring your application meets applicable standards, and any other safety, security, regulatory or other requirements.

These resources are subject to change without notice. TI grants you permission to use these resources only for development of an application that uses the TI products described in the resource. Other reproduction and display of these resources is prohibited. No license is granted to any other TI intellectual property right or to any third party intellectual property right. TI disclaims responsibility for, and you will fully indemnify TI and its representatives against, any claims, damages, costs, losses, and liabilities arising out of your use of these resources.

TI's products are provided subject to [TI's Terms of Sale](#) or other applicable terms available either on [ti.com](https://www.ti.com) or provided in conjunction with such TI products. TI's provision of these resources does not expand or otherwise alter TI's applicable warranties or warranty disclaimers for TI products.

TI objects to and rejects any additional or different terms you may have proposed.

Mailing Address: Texas Instruments, Post Office Box 655303, Dallas, Texas 75265
Copyright © 2024, Texas Instruments Incorporated