

ADS5474 ADX Evaluation Board for Interleaving

Contents

1	Overview	3
	1.1 Purpose	3
	1.2 EVM Basic Functions.....	3
	1.3 Power Requirements	3
	1.4 ADS-ADX EVM Operational Procedure.....	3
2	Circuit and Operational Description	4
	2.1 Schematic Diagram.....	4
	2.2 Power.....	4
	2.3 Clock Input.....	4
	2.4 Analog Input	4
	2.5 DIP Switches	5
	2.6 Onboard Status Output	5
	2.7 Digital Outputs.....	6
3	Installation	6
4	View	8
5	Capturing Data	9
	5.1 Setup	9
	5.2 Connect to Board	9
	5.3 Capture Single Batch	10
	5.4 Continuous Capture.....	10
6	Import and Export of Data.....	10
	6.1 Import Data.....	10
	6.2 Export Data	10
7	Data Analysis	10
	7.1 Analysis Settings	10
	7.2 Analysis Window Output	11
8	Plot Tools.....	12
9	Keyboard Commands.....	12
10	MATLAB Interface.....	13
11	Results.....	13
12	Troubleshooting	15
13	SP Devices Intellectual Property	15
14	Printed-Circuit Board Layout, Bill of Materials, and Schematic	16
	14.1 Printed-Circuit Board Layout.....	16
	14.2 Bill of Materials	20
	14.3 Schematic	22

List of Figures

1	Board Layout	4
2	100-MHz.....	13
3	230-MHz.....	13
4	491.5-MHz.....	14
5	ADS5474-ADX.....	14
6	Layer 1.....	16

7	Layer 2.....	17
8	Layer 3.....	17
9	Layer 4.....	18
10	Layer 5.....	18
11	Layer 6.....	19
12	Layer 7.....	19
13	Layer 8.....	20
14	Front End Schematic	22
15	FPGA I/O Schematic.....	23
16	USB and Logic Analyzer Connectors.....	24
17	FPGA System Schematic	25
18	Power Supply Schematic.....	26

List of Tables

1	DIP Switches Functional Descriptions	5
2	DIP Switches Modes	5
3	LED Functions.....	5
4	Bill of Materials	20

1 Overview

This user's guide gives a general overview of the ADS-ADX Evaluation Board for interleaving (later called ADS-ADX EVM). It provides a description of the features and functions to consider when using the module.

1.1 Purpose

The ADS-ADX EVM provides a platform for evaluating two interleaved ADS5474 analog-to-digital converters (ADC) with a combined sampling rate of 800 MSPS. The ADS5474 is a 14-bit, 400-MSPS ADC which is pinout compatible with the ADS5463, a 12-bit, 500-MSPS ADC. For a more in-depth theoretical description of ADC interleaving, consult the white paper *Frequency-Response Mismatch Errors and Digital Correction in Time-Interleaved ADCs* – available at www.spdevices.com. For system design with this technology, consult the SP Devices application note *Recommended Analog Front-End Design for ADX with ADS5474/ADS5463*. The ADS-ADX EVM contains an ADC interleaving IP core from SP Devices. For commercial information and available platforms, contact SP Devices.

1.2 EVM Basic Functions

One analog input into the EVM is provided via the SMA connector. The input is AC-coupled, and the user supplies a single-ended input signal, which is converted into a differential signal at the input. The ADS-ADX EVM provides an SMA connector for input of the ADC clock. The external clocking interface is to be clocked with a 50% duty cycle clock, at half of the sampling rate of the interleaved system sampling rate.

The interleaving and digital post-correction (ADX IP-core) is implemented in real time using the Virtex-5 FPGA on the board.

Digital output from the EVM is provided both by two Soft Touch Probe (support for Agilent E5405A and Tektronix P6908 probes) connectors for logic analyzers and by a USB connector for connecting a personal computer. The USB interface samples the data into internal FPGA memory, which has a maximum depth of 65,536 samples.

1.3 Power Requirements

The ADS-ADX EVM is powered through the 6-Vdc power supply adapter that is supplied. Power consumption during operation is approximately 12 W for the board.

1.4 ADS-ADX EVM Operational Procedure

1. Verify the DIP switch settings to reflect your intended setup ([Section 2.5](#) and [Table 2](#))
2. Connect the supply power to the EVM, from the supplied mains adapter.
3. Press the reset button.
4. Use a 50- Ω function generator with an output swing of ± 1 V at the clocking speed of half the full system, with a duty cycle of 50% ($\pm 3\%$).
5. Connect a 50- Ω function generator with a 55-MHz, 0-V offset, 700-mV amplitude sine wave to the input of the ADC channel.
6. The digital output pattern on the Soft Touch Probe connector now represents a sine wave and can be monitored with a logic analyzer.
7. Or connect a USB cable between the board and your computer, start the program ADCaptureLab (installation: see section *Software*), and collect the data. The plots provided are a time-series plot and an FFT of the signal.

2 Circuit and Operational Description

2.1 Schematic Diagram

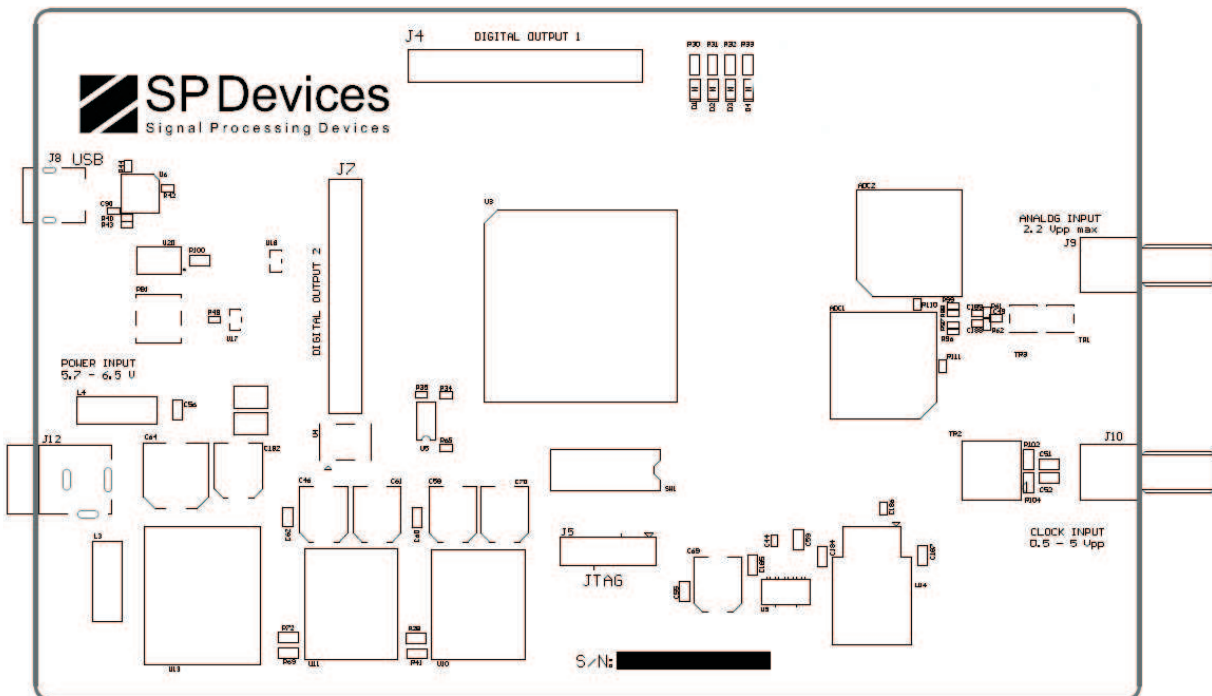

Figure 1. Board Layout

2.2 Power

Power is supplied via the 6-Vdc external power supply which is then distributed onboard using several voltage regulators.

2.3 Clock Input

A single-ended sinusoidal clock with a 50% ($\pm 3\%$) duty cycle must be applied to the SMA clock input, J10. The output swing of the clock must be ± 1 V. The clock frequency must not exceed 400 MSPS for the ADS5474. The single-ended clock input is converted into a differential signal by using a transformer. The 0° phase output of the transformer is used to clock ADC1 whereas the 180° phase output is used to clock ADC2.

2.4 Analog Input

A single-ended analog input must be applied to the SMA analog input, J9. The amplitude of the signal must not exceed 2.2-Vpp differential at the input of the ADCs. The analog input is converted into a differential signal by using a transformer and is fed to both ADCs. When providing an analog input, consider the following guidelines for correct operation of the ADX IP core when enabled.

1. The analog input must be less than 85% of the Nyquist band. The Nyquist band refers to one-half of the combined interleaved sampling rate of the analog input signal.
2. On initial power up, the analog input must be greater than 7.5% of the Nyquist band for correct estimation to occur. After estimation has occurred, one can put analog input signals representing less than 7.5% of the Nyquist band.
3. For single-tone analysis only, users cannot input a tone of $FS/4$ and have adequate correction of the interleaved tone. In this case, the interleaved spur falls on top of the wanted single tone, which cannot be distinguished by the ADX algorithm. FS refers to the combined sampling rate of the analog input.

2.5 DIP Switches

The DIP switch ramp on the board has the following control possibilities:

Table 1. DIP Switches Functional Descriptions

DIPs [XXXXXX] [123456]	Functional Description
1	Reserved. Set to zero.
2	Reserved. Set to zero.
3	Reserved. Set to zero.
4	Nyquist band selector [0 = first Nyquist band, 1 = second Nyquist band]
5	Switch for raw or post-processed interleaved output. [0 = raw interleaved data, 1 = post-processed data]
6	ADC power down. [0 = ADC Power down, 1 = ADC Power on].

Table 2. DIP Switches Modes

DIPs [XXXXXX] [123456]	Example of Configurations (X is undefined. 0 is down, towards the numbers of the DIP ramp)
[000X01]	The output from the ADS-ADX EVM is raw interleaved data.
[000011]	The output from the ADS-ADX EVM is the post-processed interleaved data. The signal is reconstructed for the first Nyquist band.
[000111]	The output from the ADS-ADX EVM is the post-processed interleaved data. The signal is reconstructed for the second Nyquist band.

2.6 Onboard Status Output

2.6.1 LEDs

Four LEDs are on the board. A more thorough description on the signal requirements for estimation is available in the data sheet for the ADX IP-core.

Table 3. LED Functions

LED	Color	Description
D4	Green	On – Channel mismatch has been estimated and outputs are valid to specification. Off – Channel mismatch is not estimated, output may be outside specification. Blink (together with D2) – Clock is not stable or not connected
D3	Green	On – A valid calibration signal is available and the post-processing tracks the channel mismatch. Off – A valid calibration signal is not available and the post-processing is locked to last estimated channel mismatch. Blink (together with D1) – Clock is not stable or not connected
D2	Red	On – License checked and is OK. Off – License not yet checked. Slow blink – License time expired. Reset manually to renew. Fast blink – License error.
D1	Red	On – New available dataset is stored in internal memory. Off – No new dataset is available. (This LED will blink when in continuous acquisition mode).

2.7 Digital Outputs

2.7.1 Soft Touch Probe Connector

On the board are two soft touch probe connectors that output the data, as configured by the DIP switches.

2.7.2 USB Connector

The onboard USB1.1 chip communicates with the FPGA. Transfer speed is 3 megabaud.

3 Installation

To install the software, run the *ADCaptureLab-setup.exe* file and follow the instructions for installation.

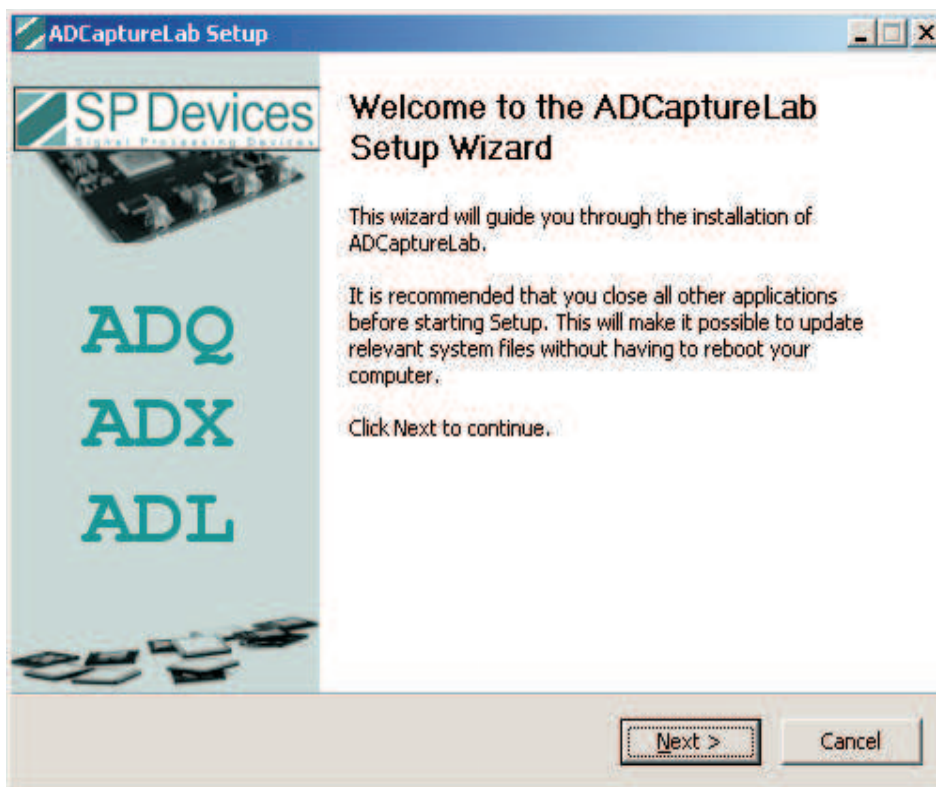

Before continuing, you need to close any other application running to avoid the need of rebooting the system.

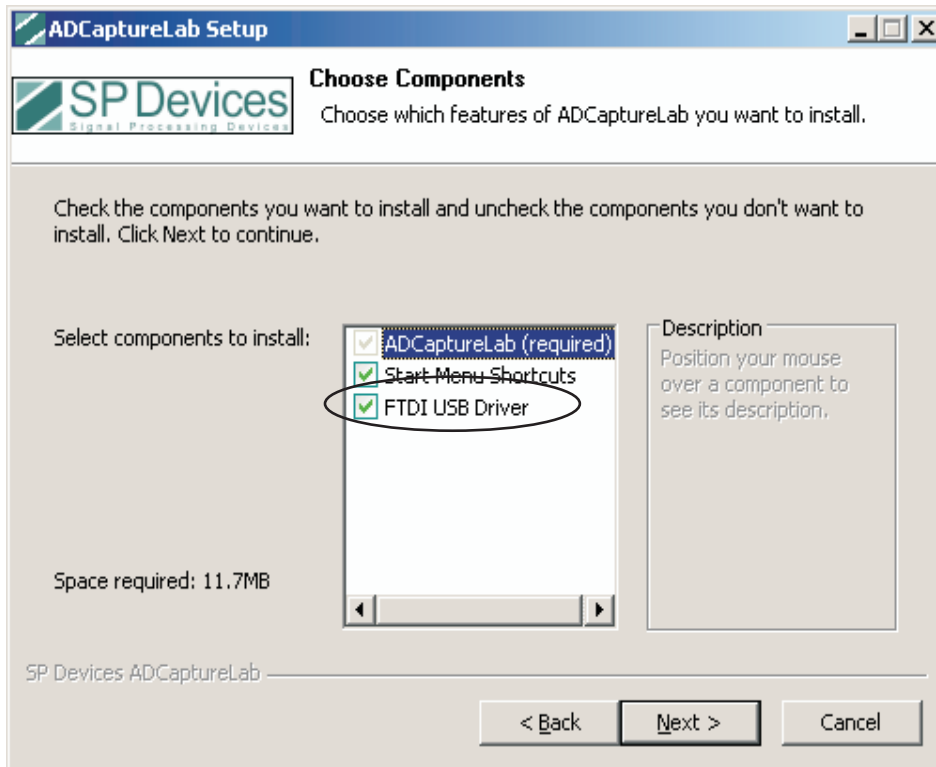

If you choose to install FTDI USB drivers from the installation program, the drivers are pre-installed on your hard disk, but are not activated until you connect a powered ADS-ADX EVM to the computer for the first time.

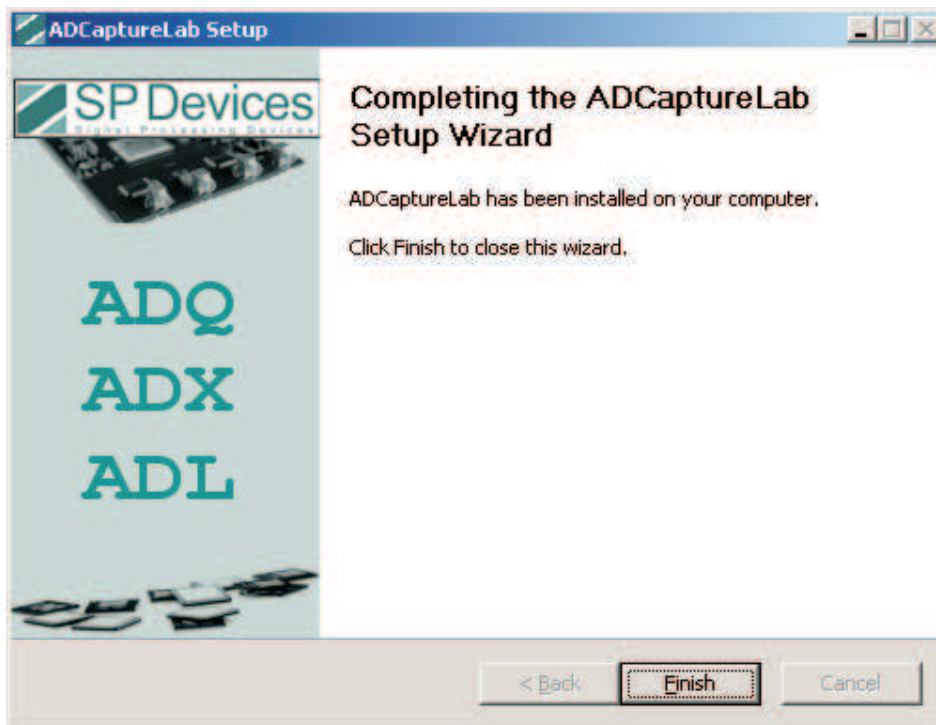

4 View

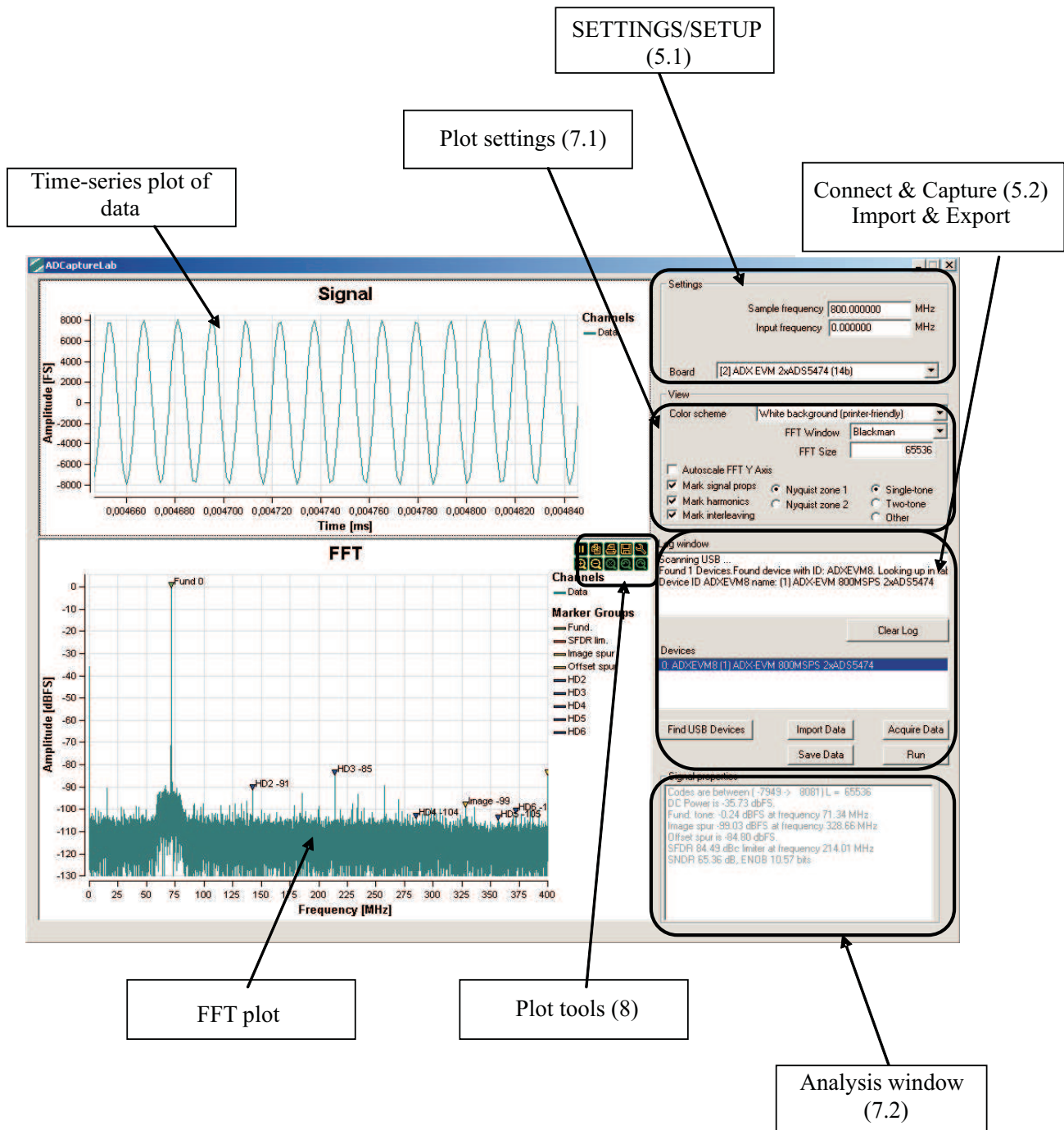

5 Capturing Data

5.1 Setup

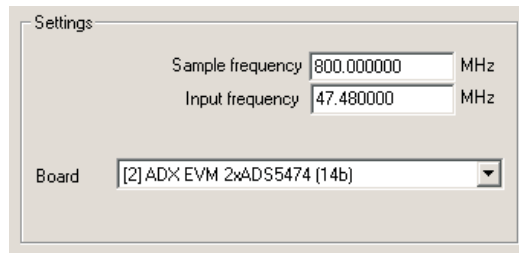

Setting	Description
Sample frequency	Set the sampling frequency for the system.
Input frequency	Set the input frequency. Only used for tagging when exporting data.
Board	Available choices: <ul style="list-style-type: none"> [1] ADX-EVM 2xADS5463 (12b) [2] ADX-EVM 2xADS5474 (14b)

5.2 Connect to Board

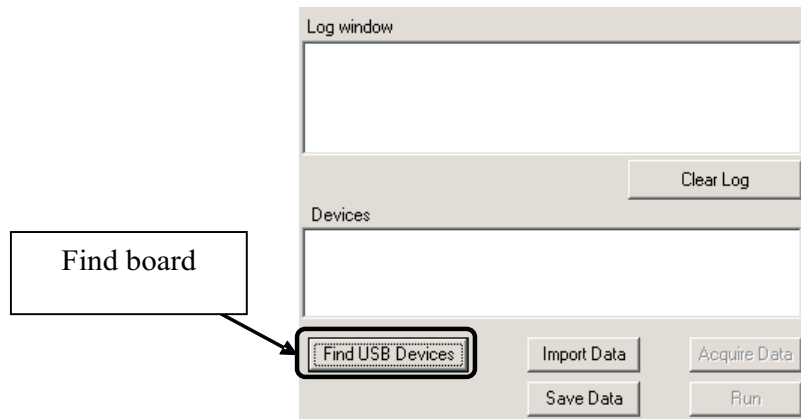

1. To find a board – push the button labeled *Find USB Devices*. The boards connected to the computer then show up in the *Devices* box. Status information on the enumeration of devices shows in *Log window*.
2. Select a compatible device board from the *Devices* list. The buttons *Acquire data* and *Run* are then activated.

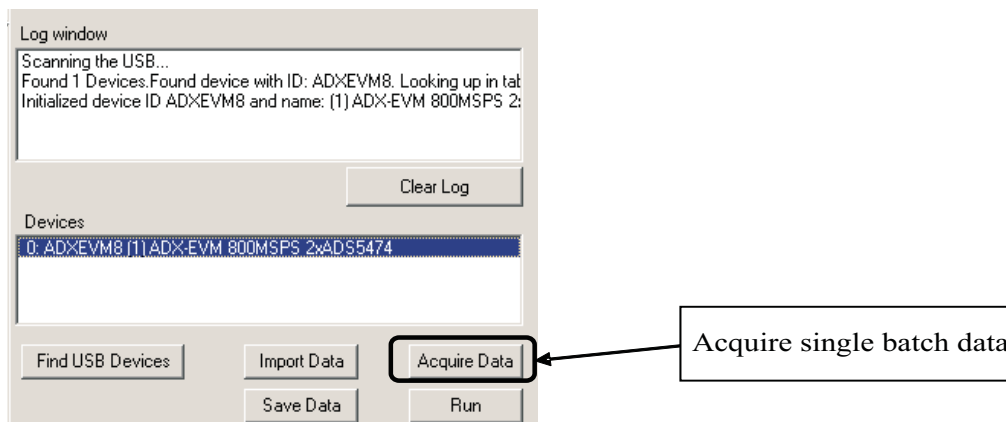

5.3 Capture Single Batch

To capture a single batch from the board, press *Acquire Data*.

5.4 Continuous Capture

To capture continuously, pressing the *Run*. button changes name to *Stop*, and pressing it stops the capturing. If plots are in *Play* mode (see [Section 7](#)), plots are updated continuously as new data arrives from the board.

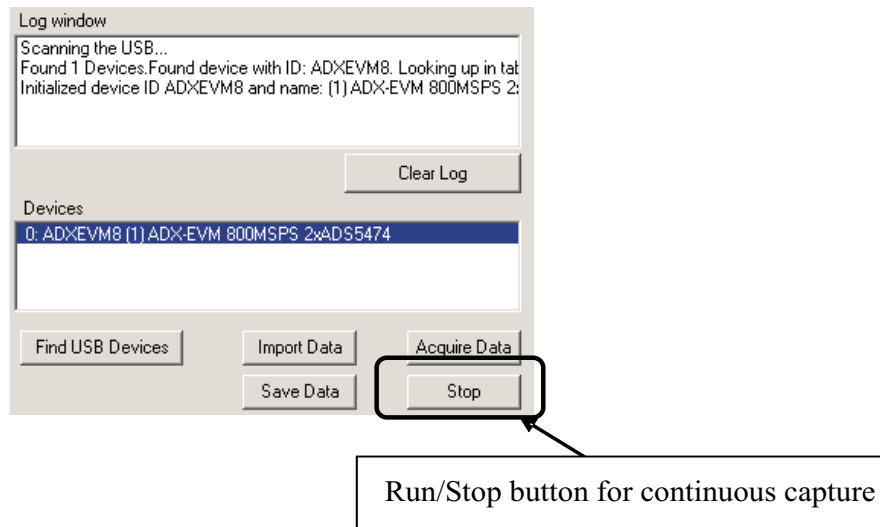

6 Import and Export of Data

6.1 Import Data

Select a file (file on text file format supported) in dialog box, and press *Open*. File contents are loaded into the plot windows (unless they are in *Pause* mode). To import, you can also drag and drop the file to the ADCaptureLab main window directly.

6.2 Export Data

Select filename in dialog box, and press *Save*. Data can be exported on a text file format with a header, or a pure ASCII file for use with MATLAB™, for example.

7 Data Analysis

7.1 Analysis Settings

7.1.1 Type of Analysis

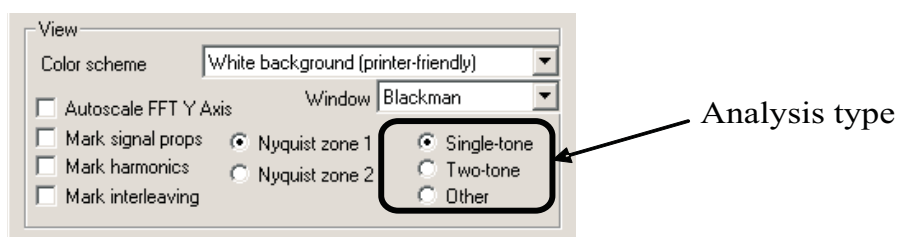

Analysis Type	Description
Single-tone test	Supports analysis of code range, fundamental, harmonics, SFDR, SNDR (ENOB), interleaving errors (image and offset spur).
Two-tone test	Supports analysis of code range, fundamentals, SFDR, SNDR (ENOB), interleaving errors.
Other tests	Supports analysis of code range only.

7.1.2 Nyquist Zone Settings

Nyquist Zone ⁽¹⁾	Description
Nyquist zone 1	Input signal frequencies in Nyquist zone 1. { $0.0 < f_{in} < f_s/2$ }. f_s refers to the combined interleaved sampling rate of the analog input signal.
Nyquist zone 2	Input signal frequencies in Nyquist zone 2. { $f_s/2 < f_{in} < f_s$ }. f_s refers to the combined interleaved sampling rate of the analog input signal.

⁽¹⁾ Check that board is configured for the Nyquist zone selected, when evaluating performance

7.1.3 View Settings

Setting	Description
Color scheme	Sets the color scheme of the plot routines. Available modes are: <ul style="list-style-type: none"> White background (printer-friendly) Black background
Window	Windowing function used for FFT and for analysis functions. Available: <ul style="list-style-type: none"> Blackman Hamming Rectangular
Autoscale FFT Y-Axis	When enabled, autoscales the y-axis of the FFT plot. If disabled, y-axis is locked between 0 and -130 dBFS.
Mark signal props	When enabled, fundamental tone(s) and SFDR limiter are marked in FFT.
Mark harmonics	When enabled, harmonics (second–seventh) are marked in FFT. Supported for single-tone tests only.
Mark interleaving	When enabled, interleaving errors are marked in FFT. Supported for single-tone tests and two-tone tests only.

7.2 Analysis Window Output

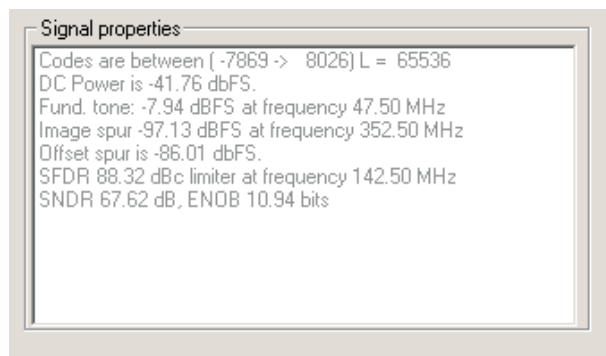

Analysis Item	Valid for Analysis Type(s)	Description
Codes	All	Code range read in batch and length of batch read.
DC Power	All	DC power in dBFS.
Fundamental tone(s)	Single-tone Two-tone	Identified fundamental tones (power and frequency)
Power maximum	Other	Identified power maximum (power and frequency)

Analysis Item	Valid for Analysis Type(s)	Description
Image spur(s)	Single-tone Two-tone	Interleaving image spurs caused by gain mismatch and aperture time delay mismatch of the channels (power and frequency)
Offset spur	Single-tone Two-tone	Interleaving offset spur caused by offset mismatch of the channels (power)
SFDR	Single-tone Two-tone	Spurious-Free Dynamic Range. Power relation between fundamental tone and largest distortion. For a two-tone test, this is calculated as the relation between the largest fundamental tone and the largest distortion. Frequency position of limiting component is calculated.
SNDR	Single-tone Two-tone	Signal-to-Noise and Distortion Ratio. Power relation between fundamental tone and noise and distortion.
ENOB	Single-tone Two-tone	Effective Number Of Bits. Based directly on the SNDR value.

8 Plot Tools

If the mouse cursor is placed in the upper right side of any of the plot windows, a plot toolbar shows.

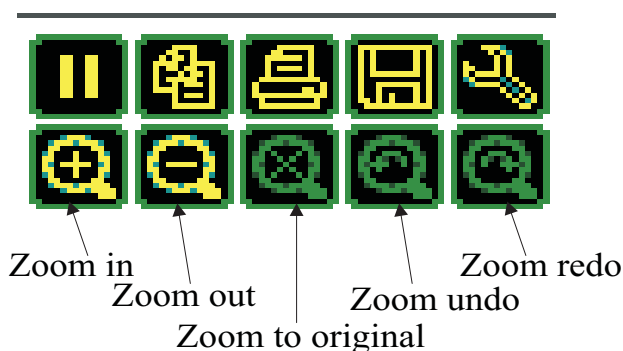

Plot tool	Description
Play/Pause	To put plot in Play/Pause mode. In play mode, plot displays new data as it arrives either by acquiring or by importing from file. In pause mode, plot does not update.
Copy	Copies plot window to clipboard
Print	Prints plot window to printer
Save	Exports plot window to bitmap or jpeg image file.
Edit cursors and markers	Edits the cursors and markers of the plot window
Zoom in	Zooms in
Zoom out	Zooms out
Zoom to original	Zooms to the original setting
Zoom undo	Returns to last zoom setting
Zoom redo	Returns to zoom setting before undo press

9 Keyboard Commands

Key	Description
F1	Show version information for ADCaptureLab software
F2	Show version information for FPGA firmware and FPGA firmware status
F5	Refresh plots

10 MATLAB Interface

Also supplied is a simple MATLAB interface to the evaluation board. It consists of an engine communicating with the board and returning the data vector on call. The calling syntax is:

```
Initialize:    acquiredata('find')
Acquire data: data = acquiredata('acquire')
```

11 Results

The following typical results were taken from the ADS-ADX evaluation module, using a filtered Agilent 8644B clock source, which provided each ADC a 400-MHz sampling clock. When using the onboard ADX interleaving technology, this results in a combined 800-MSPS sampling rate of the analog input signal. Another filtered Agilent 8644B was used to provide a -1-dBFS single tone into the EVM. The results are displayed in Figure 2 through Figure 5.

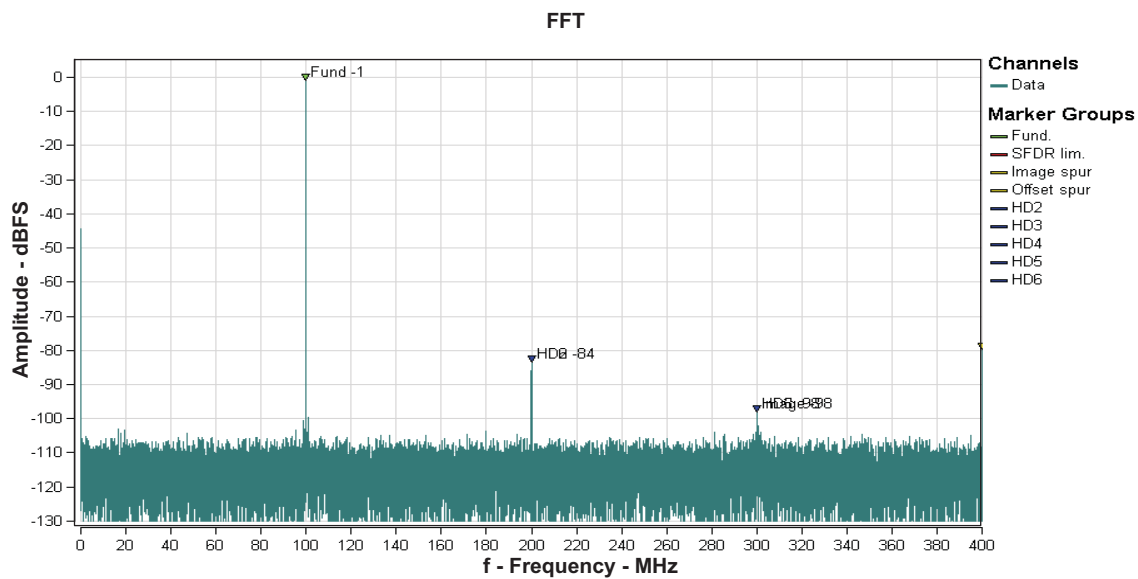

Figure 2. 100-MHz

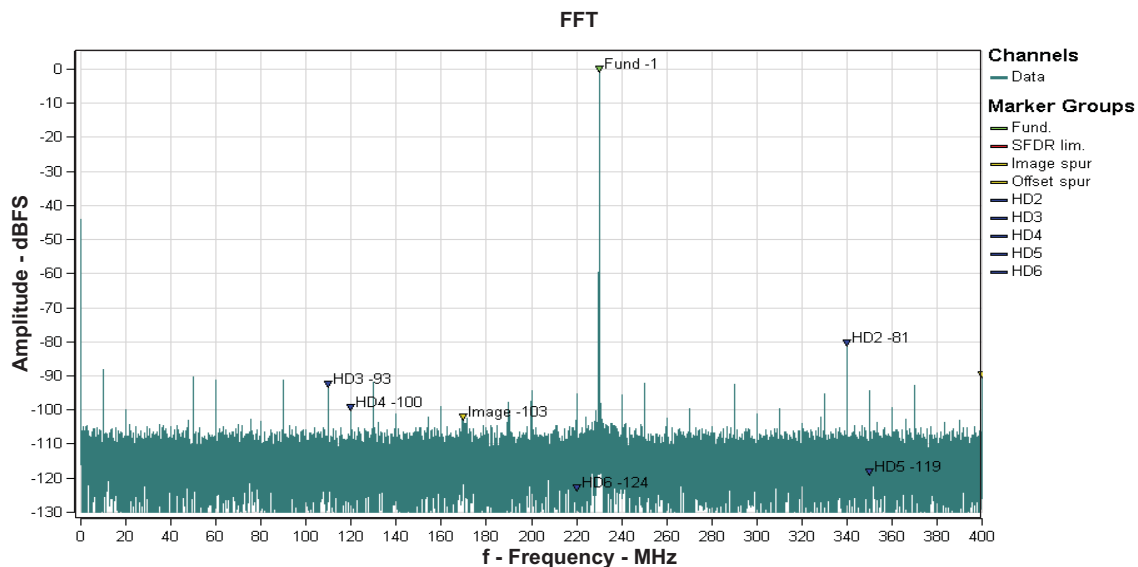

Figure 3. 230-MHz

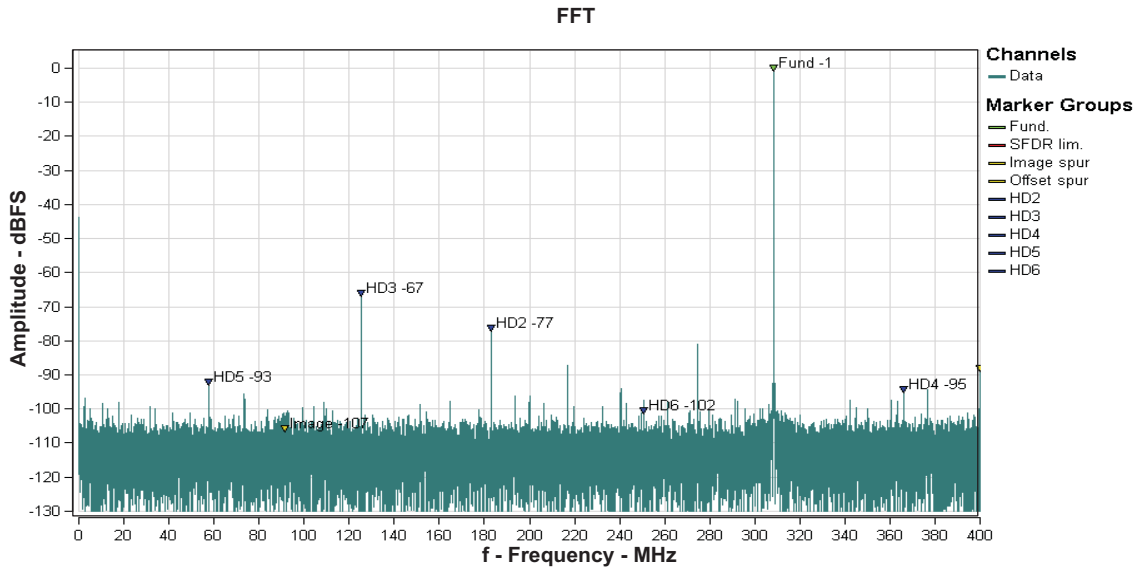

Figure 4. 491.5-MHz

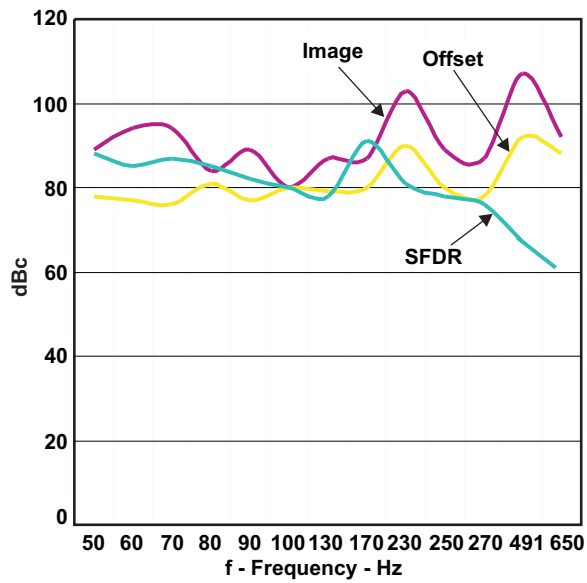
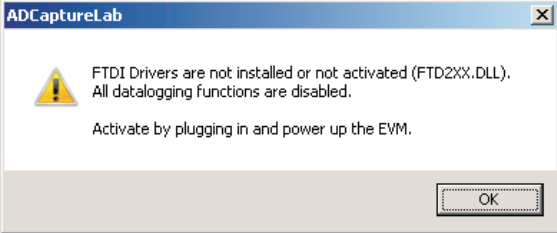
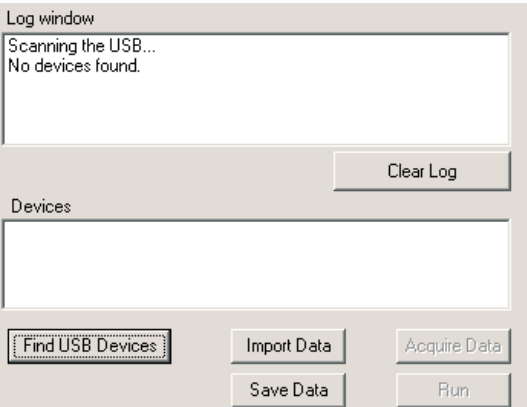



Figure 5. ADS5474-ADX

12 Troubleshooting

Problem	Remedy
<p>GUI warns for not installed or activated FTDI Drivers when starting the application.</p> 	<p>If you did not select to pre-install FTDI Drivers during installation, install FTDI Drivers separately or re-install the ADCaptureLab application and select to pre-install FTDI drivers.</p> <p>If you have pre-installed the FTDI Drivers, you need to activate the driver by plugging in a compatible powered board to the computer over the USB.</p>
<p>No devices are found when scanning the USB by pressing <i>Find USB Devices</i></p> 	<p>Check if a compatible board is plugged in via USB.</p> <p>Check if board is powered.</p> <p>Try to push the onboard reset button. Press <i>Find USB Devices</i> again.</p> <p>Try to turn the power off and on again. Press <i>Find USB Devices</i> again.</p> <p>Restart the software, and try again.</p>
<p>Board is connected and found in list, but when trying to acquire board does not respond correctly.</p>	<p>Check if board is powered.</p> <p>Check that correct board format is selected in Setup Settings (5.1).</p> <p>Try to push the onboard reset button. Press <i>Find USB Devices</i> again, select board and retry.</p> <p>Try to turn the power off and on again. Press <i>Find USB Devices</i> again, select board and retry.</p>
<p>Time series plot or FFT does not update when acquiring or importing data</p>	<p>The plot which is not updating may be in <i>Pause</i> mode. Put the mouse cursor in the top right of the plot window in question to enable the toolbar. If the play symbol is visible (see inset), push it to set the plot in <i>Play</i> mode.</p> 

13 SP Devices Intellectual Property

This evaluation board/kit contains intellectual property belonging to SP Devices, (SP Devices IP). SP Devices retains all ownership rights in SP Devices IP and no license is granted under any patent right or other intellectual property right of SP Devices except for use for engineering development, demonstration, or evaluation purposes.

14 Printed-Circuit Board Layout, Bill of Materials, and Schematic

14.1 Printed-Circuit Board Layout

The following illustrations show the eight layers of the ADX evaluation board.

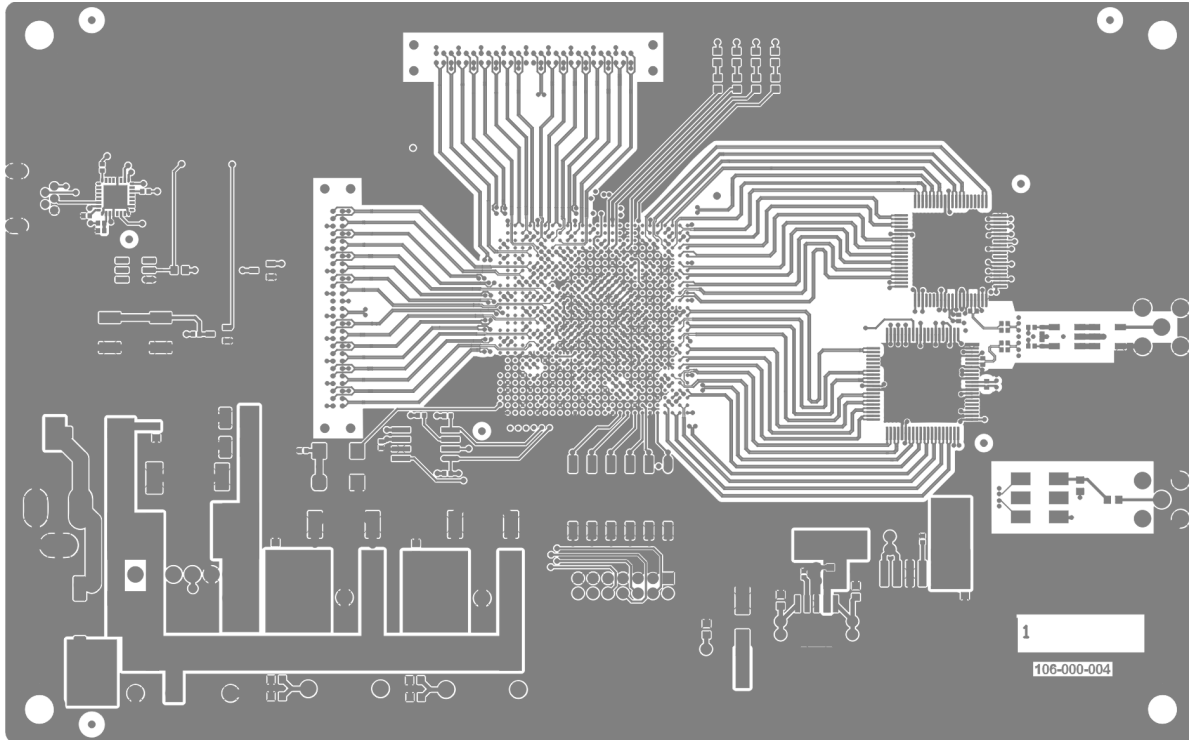

Figure 6. Layer 1

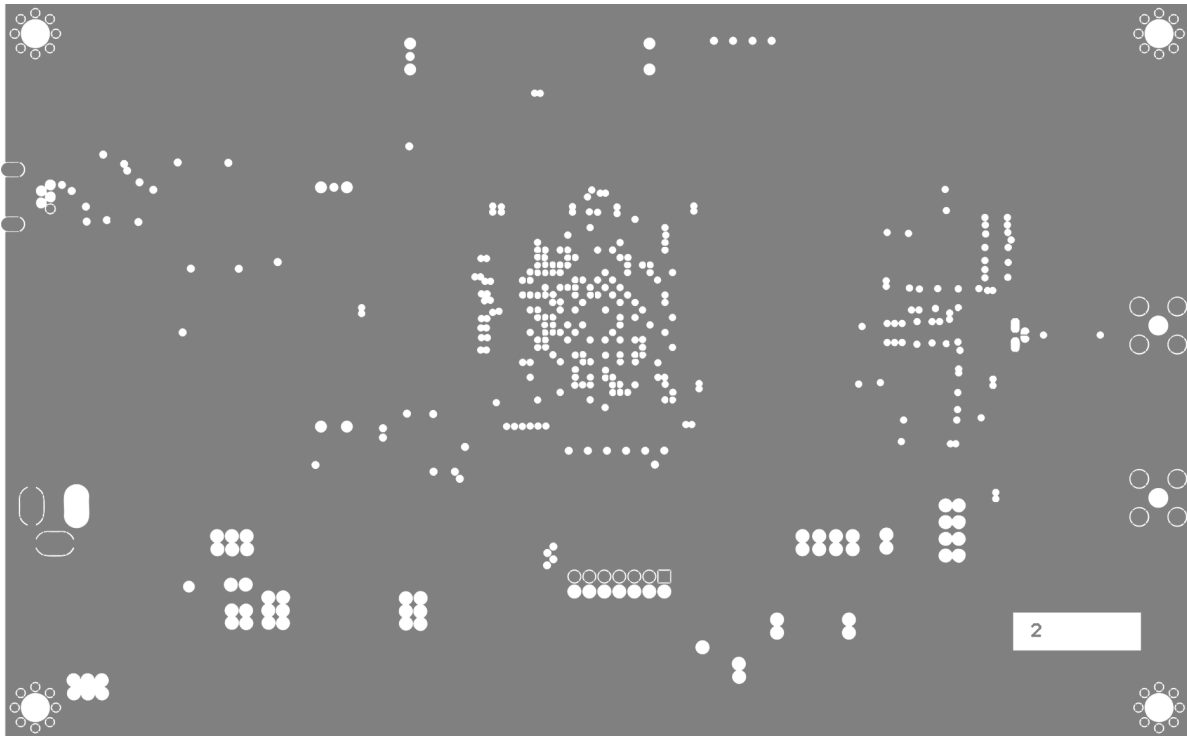

Figure 7. Layer 2

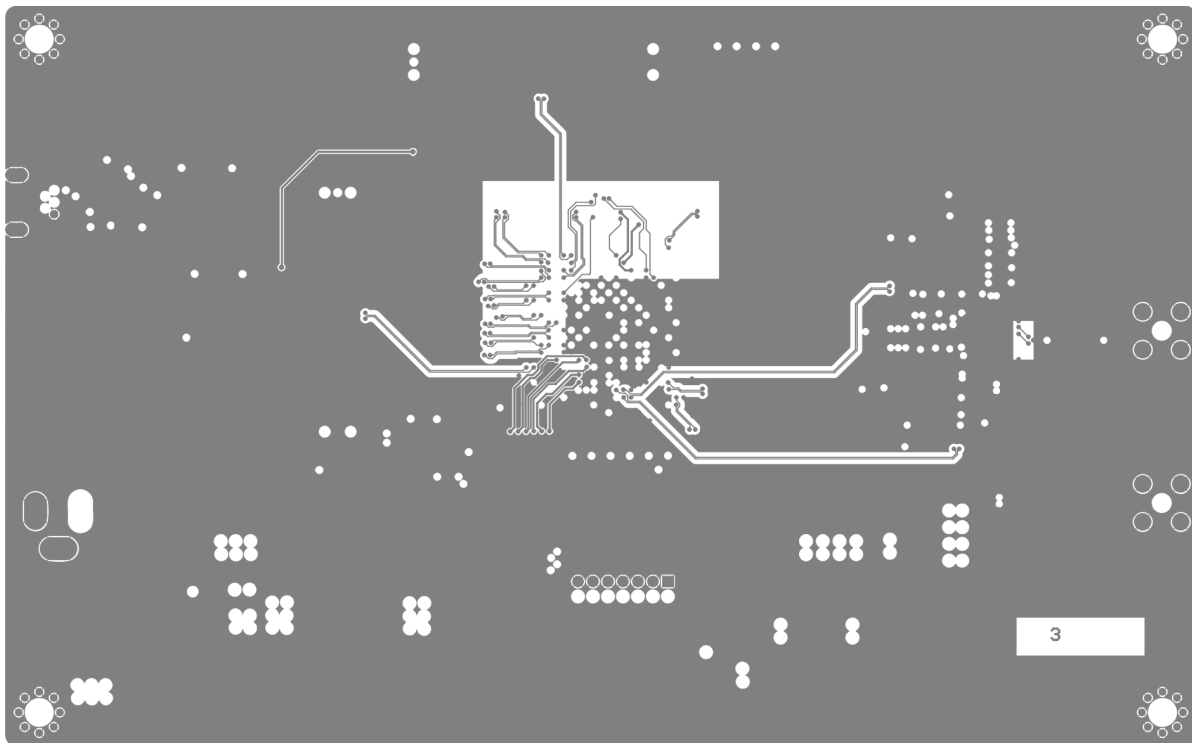

Figure 8. Layer 3

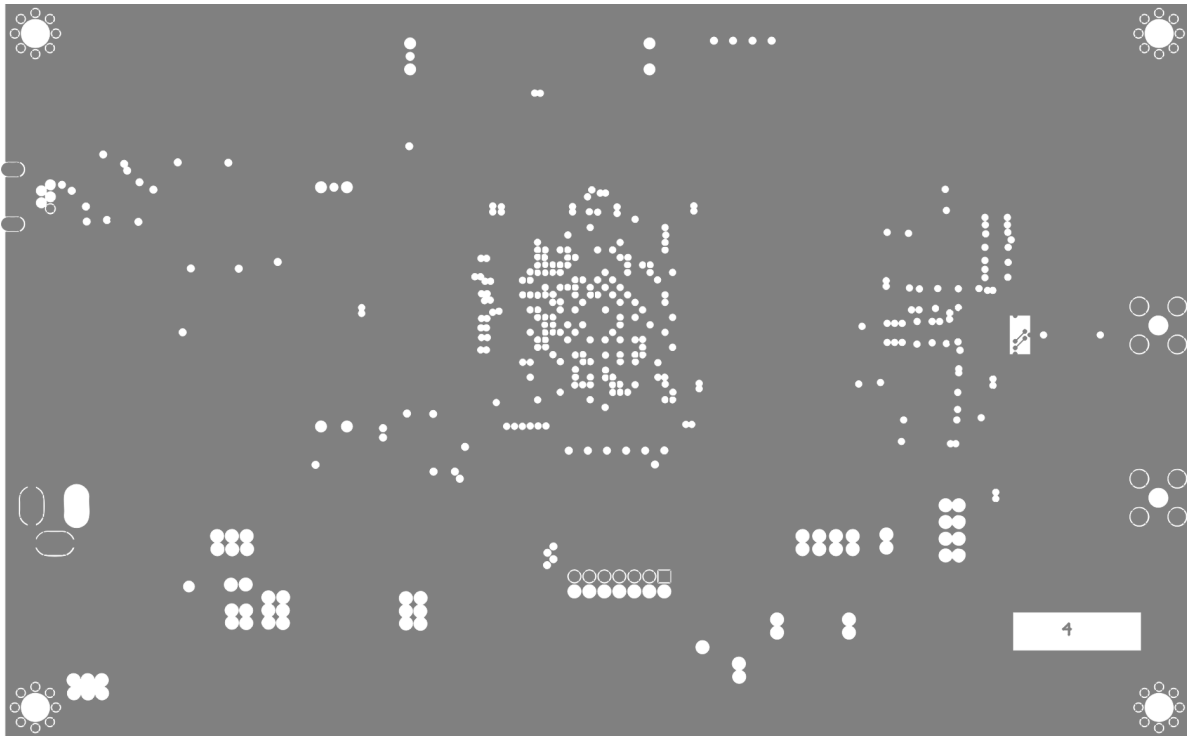

Figure 9. Layer 4

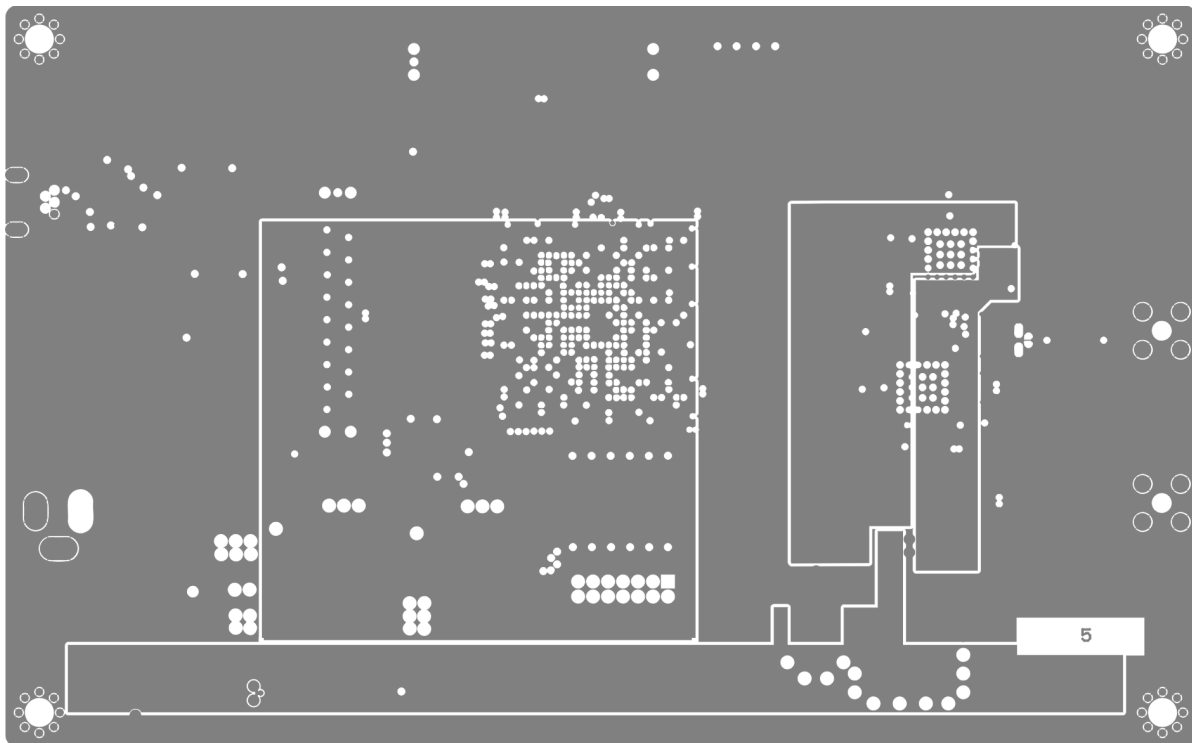

Figure 10. Layer 5

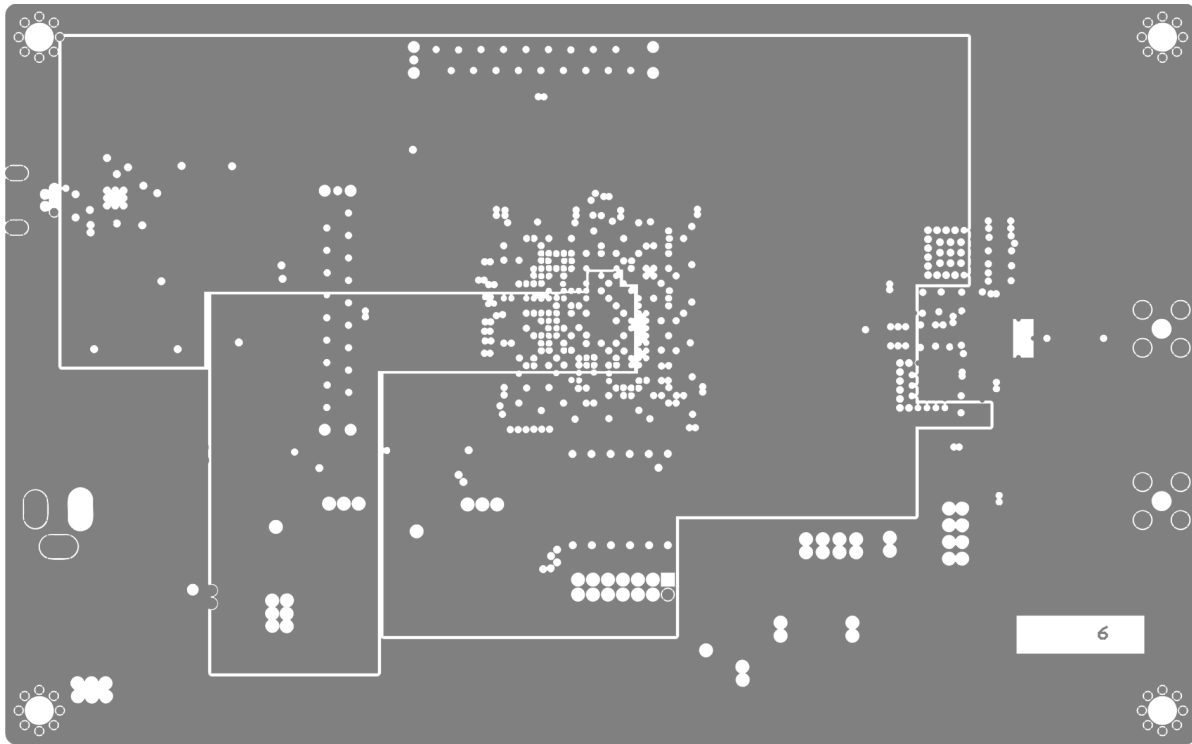

Figure 11. Layer 6

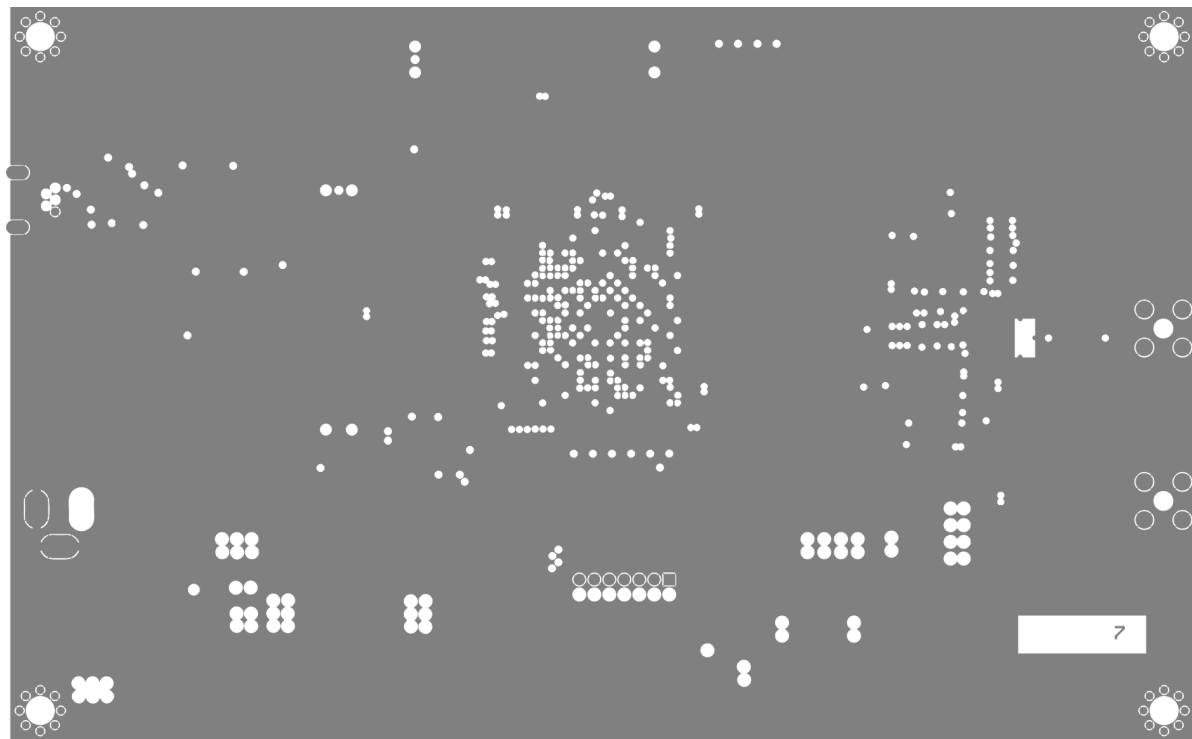
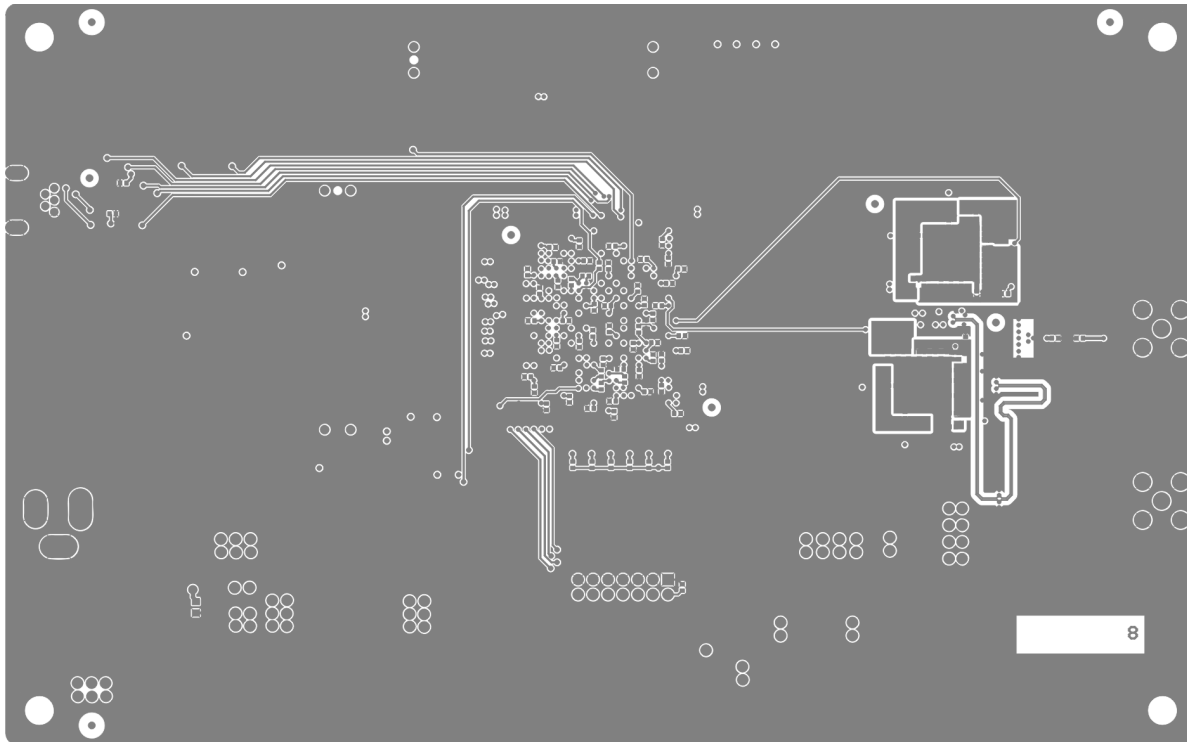

Figure 12. Layer 7

Figure 13. Layer 8

14.2 Bill of Materials

Table 4. Bill of Materials

Qty	Internal No.	Rev	Description	Package	Manufacturer	Manufacturer Part No.	Designators
4	100-000-025		Resistor, 10 Ω , 0402, 1%, 0.063W	0402			R96–R99
2	100-000-033		Resistor, 22 Ω , 0402, 1%, 0.063W	0402			R42, R44
2	100-000-039		Resistor, 39 Ω , 0402, 1%, 0.063W	0402			R61, R62
1	100-000-041		Resistor, 47 Ω , 0402, 1%, 0.063W	0402			R120
2	100-000-049		Resistor, 100 Ω , 0402, 1%, 0.063W	0402			R110, R111
1	100-000-061		Resistor, 330 Ω , 0402, 1%, 0.063W	0402			R123
1	100-000-073		Resistor, 1 k Ω , 0402, 1%, 0.063W	0402			R49
17	100-000-089		Resistor, 4.7 k Ω , 0402, 1%, 0.063W	0402			R22–R27, R34–R37, R39, R40, R65, R121, R122, R124, R125
1	100-000-097		Resistor, 10 k Ω , 0402, 1%, 0.063W	0402			R43
0	100-001-043		Resistor, 56 Ω , 0603, 1%, 0.1W	0603			
4	100-001-047		Resistor, 82 Ω , 0603, 1%, 0.1W	0603			R30–R33
1	100-001-069		Resistor, 680 Ω , 0603, 1%, 0.1W	0603			R100
1	100-001-083		Resistor, 2.7 k Ω , 0603, 1%, 0.1W	0603			R28
1	100-001-091		Resistor, 5.6 k Ω , 0603, 1%, 0.1W	0603			R41
1	100-001-093		Resistor, 6.8 k Ω , 0603, 1%, 0.1W	0603			R69
1	100-001-095		Resistor, 8.2 k Ω , 0603, 1%, 0.1W	0603			R72
1	100-001-103		Resistor, 18 k Ω , 0603, 1%, 0.1W	0603			R93
2	101-000-000		Capacitor, 1 pF \pm 0.25pF, 0402, C0G, 50V	0402			C13, C14
2	101-001-019		Capacitor, 10 nF, 10%, 0402, X7R, 25V	0402			C44, C186
84	101-001-022		Capacitor, 100 nF, 10%, 0402, X7R, 16V	0402			C1–C12, C22–C33, C49, C50, C53, C54, C73–C85, C87–C92, C103, C123–C125, C135–C152, C154–C157, C160–C162, C190–C197

Table 4. Bill of Materials (continued)

Qty	Internal No.	Rev	Description	Package	Manufacturer	Manufacturer Part No.	Designators
2	101-001-101		Capacitor, 1 μ F, 20%, 0402, X5R, 6.3V	0402			C188, C189
2	101-003-003		Capacitor, 100 nF, 10%, 0603, X7R, 16V	0603			C184, C185
1	101-003-004		Capacitor, 220 nF, 10%, 0603, X7R, 16V	0603			C51
2	101-003-006		Capacitor, 1 μ F, 10%, 0603, X5R, 25V	0603			C59, C187
4	101-003-007		Capacitor, 2.2 μ F, 10%, 0603, X5R, 16V	0603			C55, C56, C60, C62
2	101-005-000		Capacitor, 100 μ F, 20%, 1210, X5R, 6.3V	1210	Taiyo Yuden	JMK325BJ107MY-T	C66, C183
5	101-100-000		Electrolytic capacitor, 100 μ F, 0.39 Ω , 20%, 25V, C6, 105°, CE-KX	C6	Sanyo	16CE100KX	C46, C58, C61, C69, C70
1	101-100-001		Electrolytic capacitor, 100 μ F, 0.3 Ω , 20%, 25V, C8, 105°, CE-KX	C8	Sanyo	25CE100KX	C182
1	101-100-002		Electrolytic capacitor, 330 μ F, 0.15 Ω , 20%, 25V, E10, 105°, CE-KX	E10	Sanyo	25CE330KX	C64
2	102-002-001		Ferrite bead	SMD	FerroxCube		L3, L4
1	102-300-000		0.4–800 MHz transformer, 1:1 impedance ratio	CD542	Mini Circuits	ADT1-1WT+	TR2
2	102-300-002		1:1 transformer (TycoElectronics)	SM-22	Tyco/Macom	ETC1-1-13	TR1, TR3
2	103-002-000		Green LED, 16mcd, 0603	0603	Everlight	EL19-21SYGC	D3, D4
2	103-002-001		Red LED, 19mcd, 0603	0603	Everlight	EL19-21SDRC	D1, D2
1	103-004-001		XC5VSX50T-1FFG665C, Virtex 5 FPGA	BGA FF665	Xilinx	XC5VSX50T-1FFG665C	U3
1	103-005-000		AT45DB321D, 32 Mbit FPGA config memory	SO8W	Atmel	AT45DB321D-SU	U5
1	103-005-002		DS2432, 1-kbit protected 1-wire EEPROM with SHA-1 engine	TSOC8	Maxim	DS2432	U20
2	103-010-014		PTH08080W, 2.2A DC/DC module, 4.5-18V in, 0.9-5.5V out	SMD	Texas Instruments	PTH08080WAZ	U10, U11
1	103-010-016		REG104GA-3.3G4, 3.3V LDO, 1A max, 480mV drop	SOT223-6	Texas Instruments	REG104GA-3.3	U9
1	103-010-017		REG104FA-5, 5V LDO, 1A max, 580mV drop	DDPAK-5	Texas Instruments	REG104FA-5	U14
1	103-010-018		PTH08T230WAZ, 6A DC/DC module, 4.5-14V in, 0.7-5.5V out	SMD	Texas Instruments	PTH08T230WAZ	U13
2	103-012-002		ADS5474, 14-bit 400 MSPS ADC	PPQFP80	Texas Instruments	ADS5474IPFP	ADC1, ADC2
1	103-014-005		CFPS-32, 50 MHz crystal oscillator 2.5V	SMD7x5	C-MAC	CFPS-32IB 50.0MHz	U4
1	103-015-000		FT232RQ, USB 1.1 serial port	QFN32	FTDI chip	FT232RQ	U6
2	103-016-000		LM809M3-3-08, 3.3V reset circuit	SOT23-3	National Semiconductor	LM809M3-3.08	U17, U18
0	104-000-001		Pinless connector for Agilent logic analyzers	SMD	Agilent	E5405A	
2	104-001-000		SMA connector, 90-degree angle	PTH	Johnson Components	142-0701-551	J9, J10
1	104-001-002		USB type B mini, pth	PTH			J8
1	104-001-005		Power connector 2.0 mm pin , hole mounted	PTH	CLIFF ELECTRONIC COMPONENTS	DC10A	J12
1	104-001-006		Pin header, 2x7, 2.0 mm spacing	PTH	Molex		J5
0	105-001-000		Fiducial, 3 mm				
0	105-001-001		Fiducial, 2 mm				
0	105-001-002		Mounting hole, 3,5 mm				
0	105-001-003		SP Devices logo				
0	105-001-005		TI logo				
1	106-000-004	B	PCB, ADS54xx-ADS-ADX EVM				PCB1
1	107-000-000		SMD Pushbutton, Alps SKHUAD		ALPS		PB1
1	107-000-001		DIP-switch, 6PST		Taiway	DM-06	SW1

14.3 Schematic

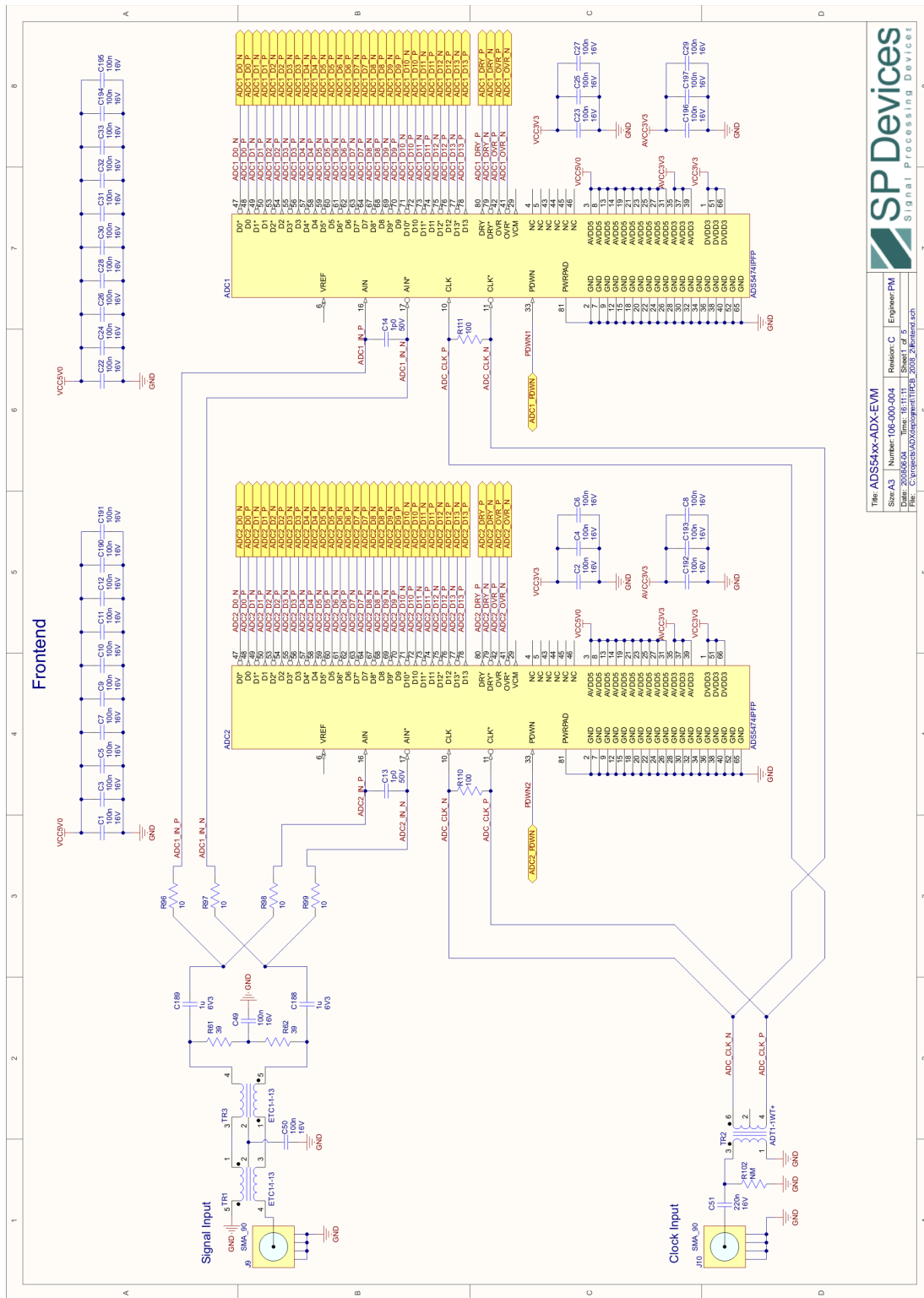

The ADS54xx-ADX-EVM
 Size: A3 | Number: 106-000-004 | Revision: C | Engineer: PM
 Date: 03/20/2008 | File: C:\projects\ADS54xx\pmw\1103_2008_2\front_end.sch

SP Devices
 Signal Processing Devices

Figure 14. Front End Schematic

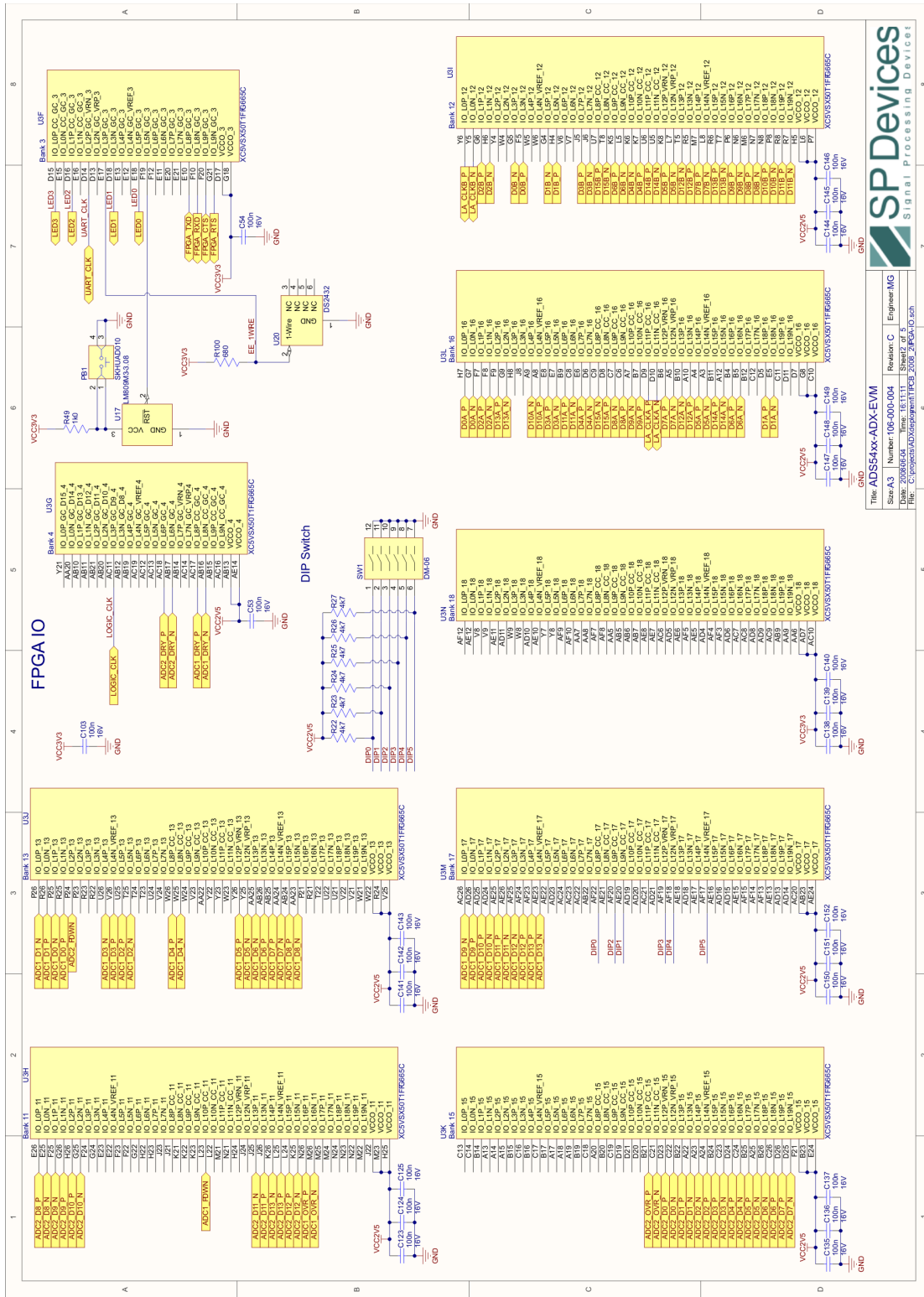

The: ADS54xx-ADX-EVM
 Size: A3
 Date: 2008.04
 Rev: C
 Time: 16:11:11
 Sheet: 2 of 3
 File: C:\projects\ADS54xx\Param\PCB_Pkg_2_Pkg10.sch
 Engineer: MG

Figure 15. FPGA I/O Schematic

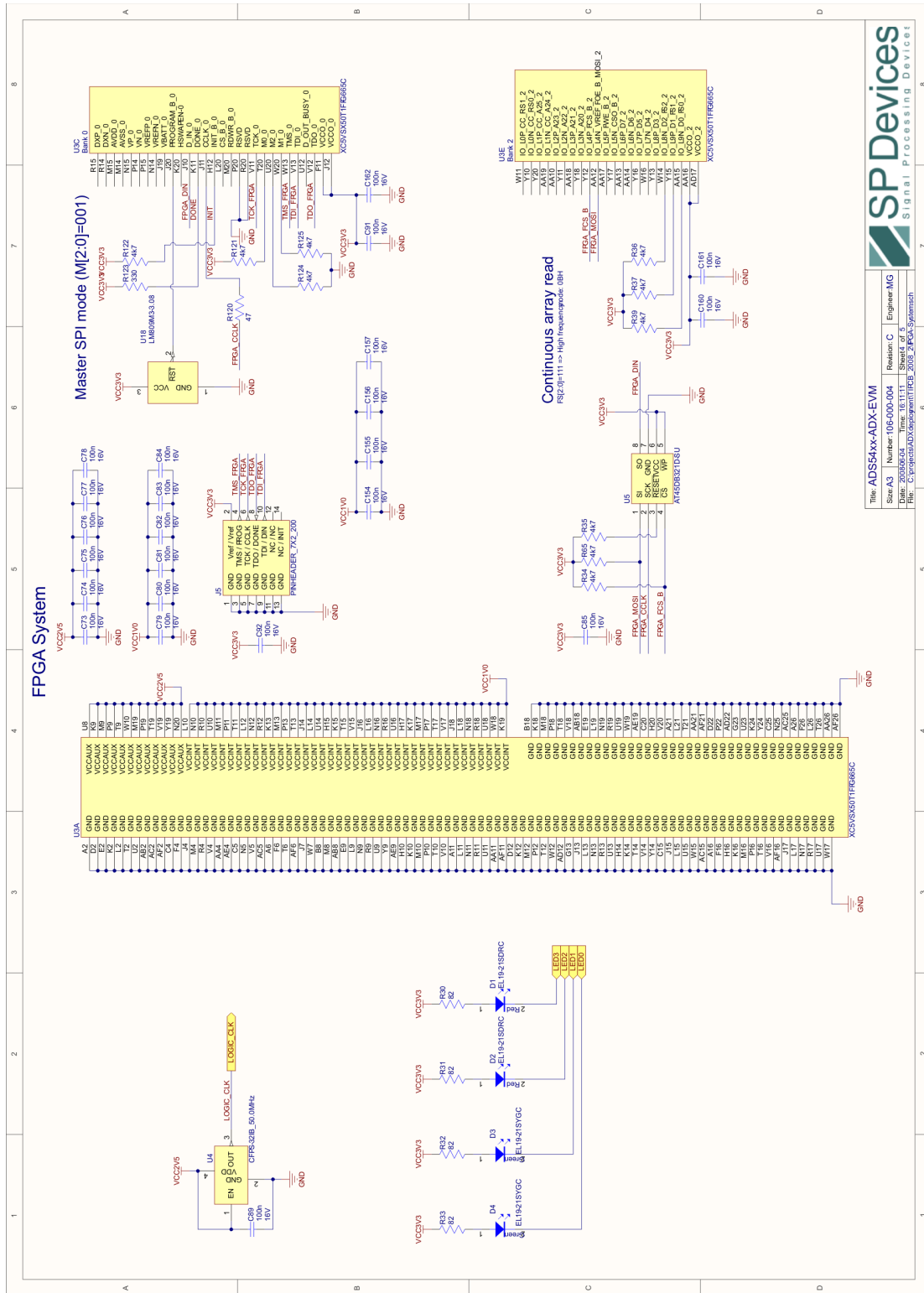

SP Devices
Signal Processing Device

File: ADS54xx-ADX-EVM
Size: A3
Number: 106-00-004
Revision: C
Date: 20080604
Time: 16:11:11
Sheet: 3 of 5
Rev: C:\projects\ADS54xx-ADX-EVM\System

Engineer: MG

Figure 17. FPGA System Schematic

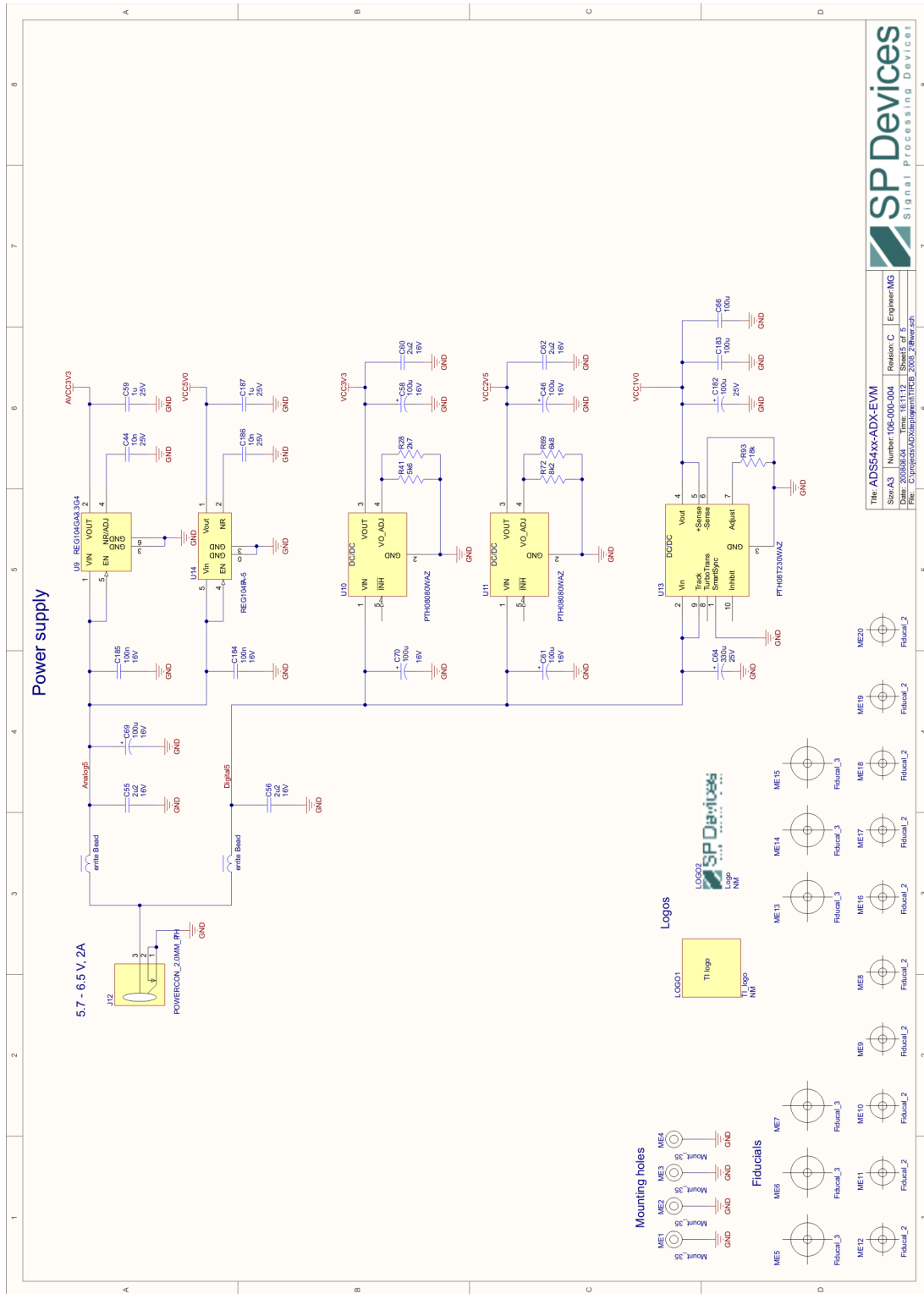

Figure 18. Power Supply Schematic

EVALUATION BOARD/KIT IMPORTANT NOTICE

Texas Instruments (TI) provides the enclosed product(s) under the following conditions:

This evaluation board/kit is intended for use for **ENGINEERING DEVELOPMENT, DEMONSTRATION, OR EVALUATION PURPOSES ONLY** and is not considered by TI to be a finished end-product fit for general consumer use. Persons handling the product(s) must have electronics training and observe good engineering practice standards. As such, the goods being provided are not intended to be complete in terms of required design-, marketing-, and/or manufacturing-related protective considerations, including product safety and environmental measures typically found in end products that incorporate such semiconductor components or circuit boards. This evaluation board/kit does not fall within the scope of the European Union directives regarding electromagnetic compatibility, restricted substances (RoHS), recycling (WEEE), FCC, CE or UL, and therefore may not meet the technical requirements of these directives or other related directives.

Should this evaluation board/kit not meet the specifications indicated in the User's Guide, the board/kit may be returned within 30 days from the date of delivery for a full refund. **THE FOREGOING WARRANTY IS THE EXCLUSIVE WARRANTY MADE BY SELLER TO BUYER AND IS IN LIEU OF ALL OTHER WARRANTIES, EXPRESSED, IMPLIED, OR STATUTORY, INCLUDING ANY WARRANTY OF MERCHANTABILITY OR FITNESS FOR ANY PARTICULAR PURPOSE.**

The user assumes all responsibility and liability for proper and safe handling of the goods. Further, the user indemnifies TI from all claims arising from the handling or use of the goods. Due to the open construction of the product, it is the user's responsibility to take any and all appropriate precautions with regard to electrostatic discharge.

EXCEPT TO THE EXTENT OF THE INDEMNITY SET FORTH ABOVE, NEITHER PARTY SHALL BE LIABLE TO THE OTHER FOR ANY INDIRECT, SPECIAL, INCIDENTAL, OR CONSEQUENTIAL DAMAGES.

TI currently deals with a variety of customers for products, and therefore our arrangement with the user **is not exclusive.**

TI assumes **no liability for applications assistance, customer product design, software performance, or infringement of patents or services described herein.**

Please read the User's Guide and, specifically, the Warnings and Restrictions notice in the User's Guide prior to handling the product. This notice contains important safety information about temperatures and voltages. For additional information on TI's environmental and/or safety programs, please contact the TI application engineer or visit www.ti.com/esh.

No license is granted under any patent right or other intellectual property right of TI covering or relating to any machine, process, or combination in which such TI products or services might be or are used.

FCC Warning

This evaluation board/kit is intended for use for **ENGINEERING DEVELOPMENT, DEMONSTRATION, OR EVALUATION PURPOSES ONLY** and is not considered by TI to be a finished end-product fit for general consumer use. It generates, uses, and can radiate radio frequency energy and has not been tested for compliance with the limits of computing devices pursuant to part 15 of FCC rules, which are designed to provide reasonable protection against radio frequency interference. Operation of this equipment in other environments may cause interference with radio communications, in which case the user at his own expense will be required to take whatever measures may be required to correct this interference.

EVM WARNINGS AND RESTRICTIONS

It is important to operate this EVM within the input voltage range of 5.7 V to 6.5 V and the output voltage range of 5.7 V to 6.5 V.

Exceeding the specified input range may cause unexpected operation and/or irreversible damage to the EVM. If there are questions concerning the input range, please contact a TI field representative prior to connecting the input power.

Applying loads outside of the specified output range may result in unintended operation and/or possible permanent damage to the EVM. Please consult the EVM User's Guide prior to connecting any load to the EVM output. If there is uncertainty as to the load specification, please contact a TI field representative.

During normal operation, some circuit components may have case temperatures greater than 25°C. The EVM is designed to operate properly with certain components above 50°C as long as the input and output ranges are maintained. These components include but are not limited to linear regulators, switching transistors, pass transistors, and current sense resistors. These types of devices can be identified using the EVM schematic located in the EVM User's Guide. When placing measurement probes near these devices during operation, please be aware that these devices may be very warm to the touch.

Mailing Address: Texas Instruments, Post Office Box 655303, Dallas, Texas 75265
Copyright © 2008, Texas Instruments Incorporated

IMPORTANT NOTICE

Texas Instruments Incorporated and its subsidiaries (TI) reserve the right to make corrections, modifications, enhancements, improvements, and other changes to its products and services at any time and to discontinue any product or service without notice. Customers should obtain the latest relevant information before placing orders and should verify that such information is current and complete. All products are sold subject to TI's terms and conditions of sale supplied at the time of order acknowledgment.

TI warrants performance of its hardware products to the specifications applicable at the time of sale in accordance with TI's standard warranty. Testing and other quality control techniques are used to the extent TI deems necessary to support this warranty. Except where mandated by government requirements, testing of all parameters of each product is not necessarily performed.

TI assumes no liability for applications assistance or customer product design. Customers are responsible for their products and applications using TI components. To minimize the risks associated with customer products and applications, customers should provide adequate design and operating safeguards.

TI does not warrant or represent that any license, either express or implied, is granted under any TI patent right, copyright, mask work right, or other TI intellectual property right relating to any combination, machine, or process in which TI products or services are used. Information published by TI regarding third-party products or services does not constitute a license from TI to use such products or services or a warranty or endorsement thereof. Use of such information may require a license from a third party under the patents or other intellectual property of the third party, or a license from TI under the patents or other intellectual property of TI.

Reproduction of TI information in TI data books or data sheets is permissible only if reproduction is without alteration and is accompanied by all associated warranties, conditions, limitations, and notices. Reproduction of this information with alteration is an unfair and deceptive business practice. TI is not responsible or liable for such altered documentation. Information of third parties may be subject to additional restrictions.

Resale of TI products or services with statements different from or beyond the parameters stated by TI for that product or service voids all express and any implied warranties for the associated TI product or service and is an unfair and deceptive business practice. TI is not responsible or liable for any such statements.

TI products are not authorized for use in safety-critical applications (such as life support) where a failure of the TI product would reasonably be expected to cause severe personal injury or death, unless officers of the parties have executed an agreement specifically governing such use. Buyers represent that they have all necessary expertise in the safety and regulatory ramifications of their applications, and acknowledge and agree that they are solely responsible for all legal, regulatory and safety-related requirements concerning their products and any use of TI products in such safety-critical applications, notwithstanding any applications-related information or support that may be provided by TI. Further, Buyers must fully indemnify TI and its representatives against any damages arising out of the use of TI products in such safety-critical applications.

TI products are neither designed nor intended for use in military/aerospace applications or environments unless the TI products are specifically designated by TI as military-grade or "enhanced plastic." Only products designated by TI as military-grade meet military specifications. Buyers acknowledge and agree that any such use of TI products which TI has not designated as military-grade is solely at the Buyer's risk, and that they are solely responsible for compliance with all legal and regulatory requirements in connection with such use.

TI products are neither designed nor intended for use in automotive applications or environments unless the specific TI products are designated by TI as compliant with ISO/TS 16949 requirements. Buyers acknowledge and agree that, if they use any non-designated products in automotive applications, TI will not be responsible for any failure to meet such requirements.

Following are URLs where you can obtain information on other Texas Instruments products and application solutions:

Products

Amplifiers	amplifier.ti.com
Data Converters	dataconverter.ti.com
DSP	dsp.ti.com
Clocks and Timers	www.ti.com/clocks
Interface	interface.ti.com
Logic	logic.ti.com
Power Mgmt	power.ti.com
Microcontrollers	microcontroller.ti.com
RFID	www.ti-rfid.com
RF/IF and ZigBee® Solutions	www.ti.com/lprf

Applications

Audio	www.ti.com/audio
Automotive	www.ti.com/automotive
Broadband	www.ti.com/broadband
Digital Control	www.ti.com/digitalcontrol
Medical	www.ti.com/medical
Military	www.ti.com/military
Optical Networking	www.ti.com/opticalnetwork
Security	www.ti.com/security
Telephony	www.ti.com/telephony
Video & Imaging	www.ti.com/video
Wireless	www.ti.com/wireless

Mailing Address: Texas Instruments, Post Office Box 655303, Dallas, Texas 75265
Copyright © 2008, Texas Instruments Incorporated