

LP8866EVM User's Guide

The Texas Instruments LP8866EVM evaluation module helps designers to evaluate the operation and performance of the LP8866-Q1 device. This document includes a hardware setup instructions, software instructions, a complete schematic diagram, printed-circuit board (PCB) layout, and bill of materials (BOM) of the LP8866EVM.

Contents

1	Introduction	2
2	Test Setup	2
3	LP8866EVM Board Layout	10
4	LP8866EVM Schematic	11
5	LP8866EVM Bill of Materials	12
6	LED Load Board	15

List of Figures

1	LP8866EVM Kit	3
2	LP8866EVM Hardware Setup	4
3	LP8866/4 Family GUI Landing Page	5
4	LP8866EVM GUI Home Page	5
5	LP8866EVM LED Control Page	6
6	LP8866EVM Monitor Faults Page	7
7	LP8866EVM Diagnostics Page	8
8	LP8866EVM Register Map Page	9
9	LP8866EVM Layout - Top	10
10	LP8866EVM Layout - Bottom	10
11	LP8866EVM Schematic	11
12	LP886X-LEDLOAD-EVM Schematic	15

List of Tables

1	LP8866EVM Bill of Materials	12
2	LP886X-LEDLOAD-EVM Bill of Materials	15

Trademarks

All trademarks are the property of their respective owners.

1 Introduction

The LP8866EVM helps designers to evaluate the characteristics, operation, and use of the LP8866-Q1 device, a high-performance LED driver for automotive lighting. The LP8866-Q1 device is a high-efficiency LED driver with boost controller. The six 200-mA high-precision current sinks support phase shifting that is automatically adjusted based on the number of channels in use. LED brightness can be controlled globally through the I²C interface or PWM input.

1.1 Features

The EVM has the following features:

- Up to 48-V V_{out} boost controller
- Six high-precision current sinks
- Supports built-in phase-shift PWM dimming, hybrid dimming, current dimming and direct PWM dimming mode
- LED brightness controlled globally through I2C interface or PWM input
- Extensive fault diagnostics

1.2 Applications

Backlight for:

- Automotive infotainment
- Automotive instrument clusters
- Smart mirrors
- Heads-Up Displays (HUD)
- Central Information Displays (CID)
- Audio-Video Navigation (AVN)

2 Test Setup

This section describes how to properly connect and setup the LP8866EVM.

2.1 The LP8866EVM Kit

The LP8866EVM kit contains (see [Figure 1](#)):

- USB2ANY
 - Ribbon cable
 - USB cable
- LP8866EVM
- LP886X-LEDLOAD-EVM

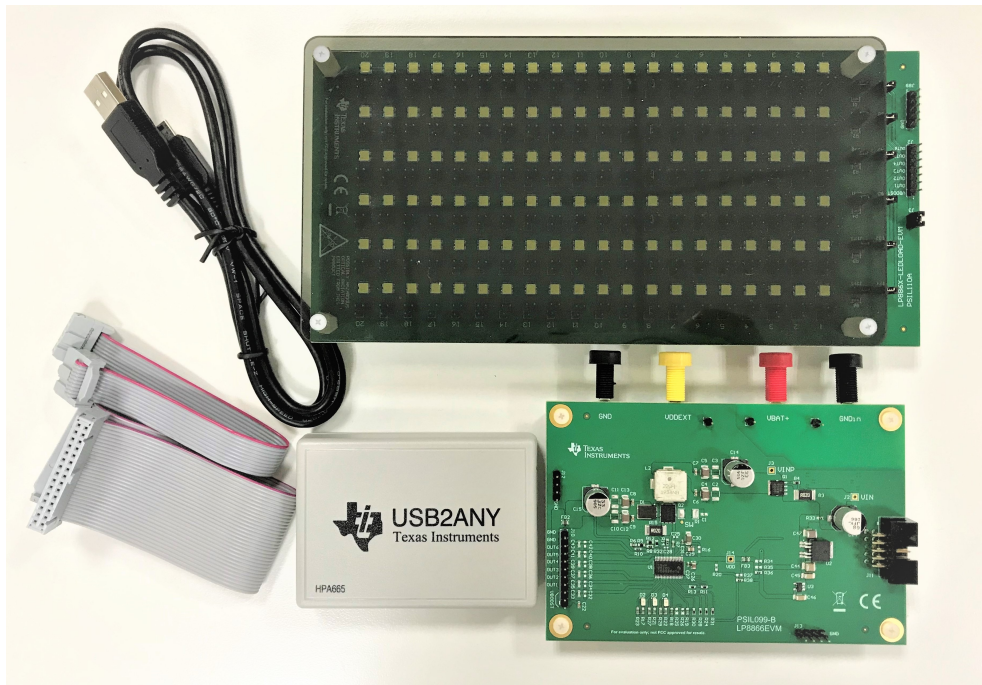

Figure 1. LP8866EVM Kit

2.2 System/Equipment Requirements

- DC power supply: 24 V or higher, 6 A or higher
- LED cable: 7-position ribbon cable
- PC to run GUI software
- GUI software

2.3 Hardware Setup

Figure 2 shows the hardware setup of the LP8866EVM.

- Connect a 12-V external power supply between the power input terminals VBAT+ and GNDin on the LP8866EVM.
- Connect the USB2ANY module to the PC with the USB cable.
- Connect the USB2ANY module to the LP8866EVM with the provided ribbon cable.
- Connect the LP8866EVM to the LP886X-LEDLOAD-EVM with a 7-position ribbon cable.

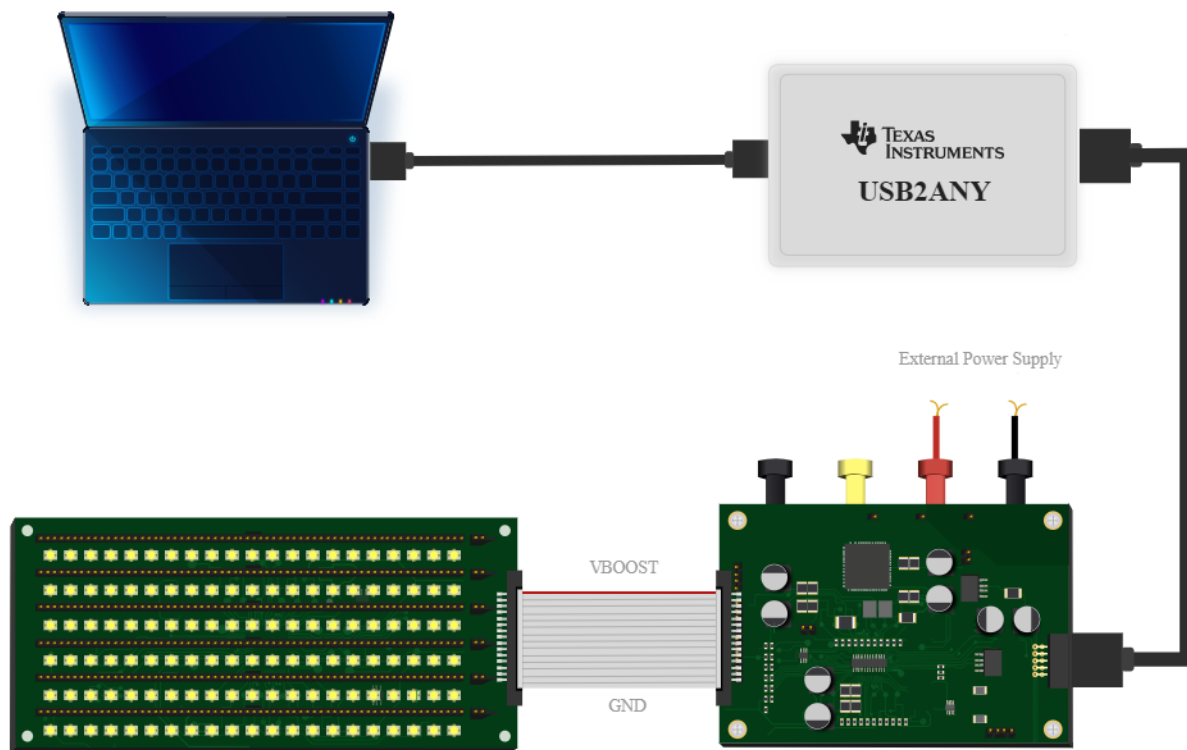

Figure 2. LP8866EVM Hardware Setup

2.4 Software Installation

Download the GUI software from the [LP8866EVM tools folder](#). Follow the instructions to finish the GUI installation. Once installed, a shortcut to the GUI is found on the desktop and also in the start-up menu under the Texas Instruments folder.

2.5 Quick Start-Up Procedure

1. After the hardware is connected successfully, run the GUI software. Turn on the 12-V external power supply. Select the right device variant of the EVM, which is LP8866, as shown in [Figure 3](#).

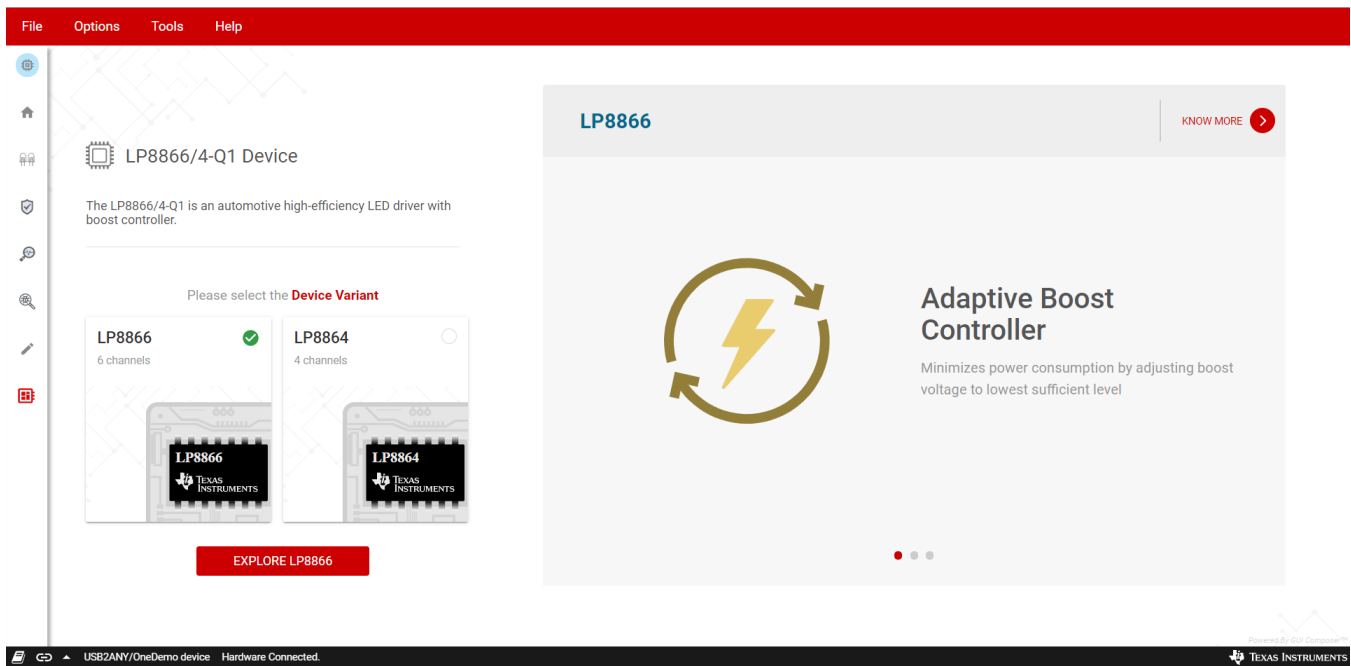

Figure 3. LP8866/4 Family GUI Landing Page

2. Check the connection status button on the bottom left corner of the GUI. The button should be like the one shown in [Figure 3](#). There should be a "Hardware connected" message on the status bar next to the button. If it shows "Hardware not Connected", click the button to connect to hardware manually. This button can be used to connect or disconnect the GUI to the hardware during the evaluation.
3. Click "EXPLORE LP8866" to go to the LP8866EVM GUI home page (see [Figure 4](#)).

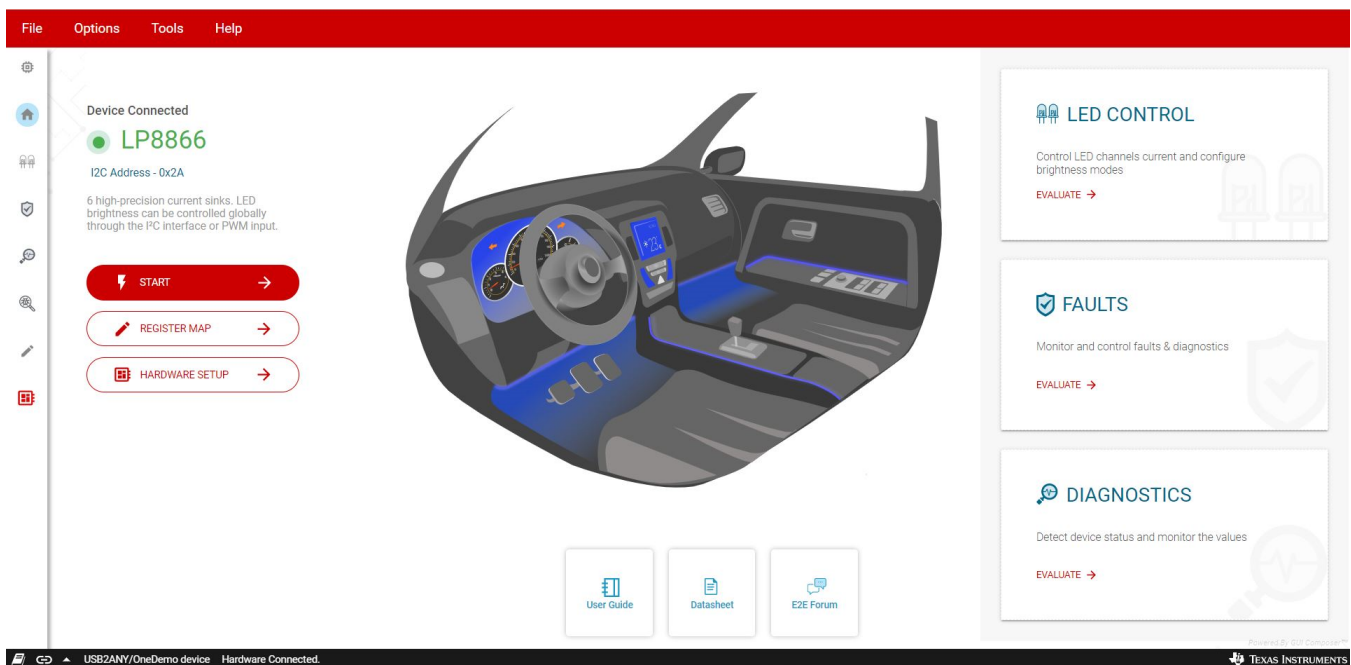

Figure 4. LP8866EVM GUI Home Page

4. Click "Start" to go to the LED Control page (see [Figure 5](#)). On the LED Control page, the user can control all the register based control functions of the device, like brightness control, current control, sloper control, dither control, boost synchronization configuration and spread spectrum configuration.

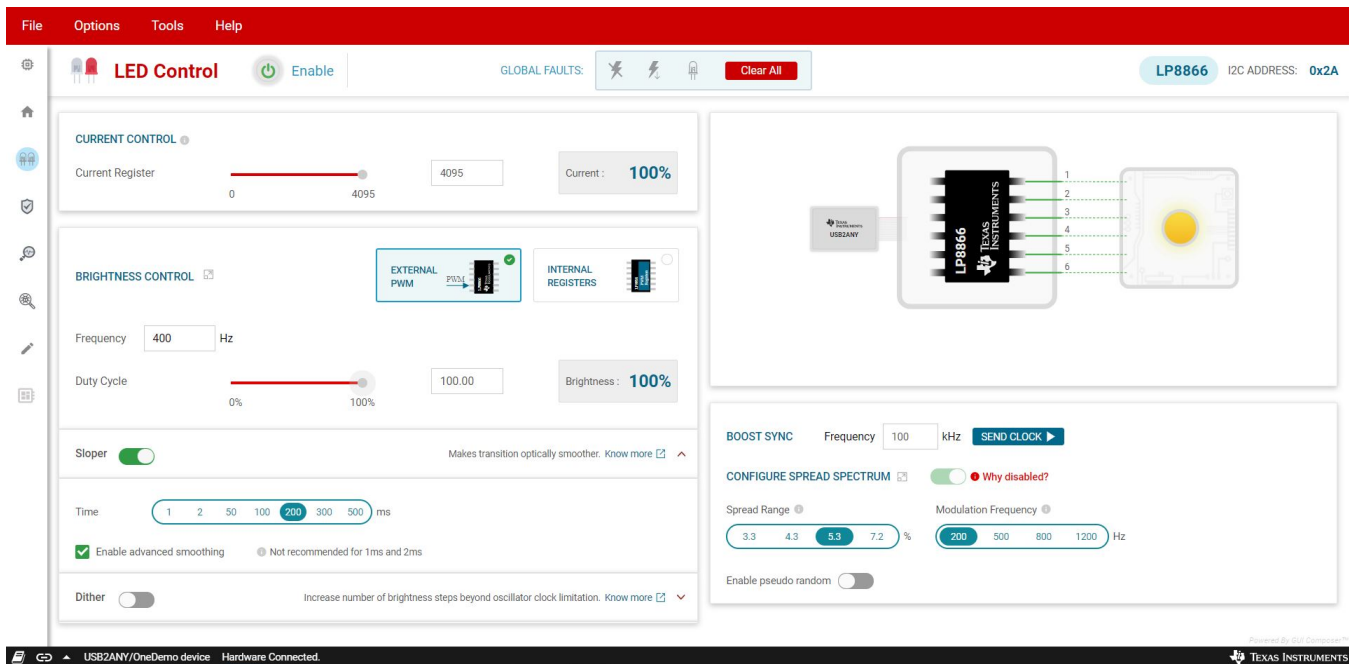

Figure 5. LP8866EVM LED Control Page

2.6 Additional GUI Functions

In the selection tab on the left-hand side, the user can switch between LED Control, Monitor Faults, Diagnostics and Register Map tabs. This section introduces GUI functions provided in the Monitor Faults, Diagnostics and Register Map tabs.

2.6.1 Monitor Faults Page

From the Monitor Faults page (see [Figure 6](#)), the user has access to LP8866-Q1 fault status bits. Faults can be cleared by software by clicking the "Clear All" button. Fault interrupt can be enabled or disabled globally by toggling the "Interrupt All" button. Besides that, each fault interrupt and each fault status can be controlled individually.

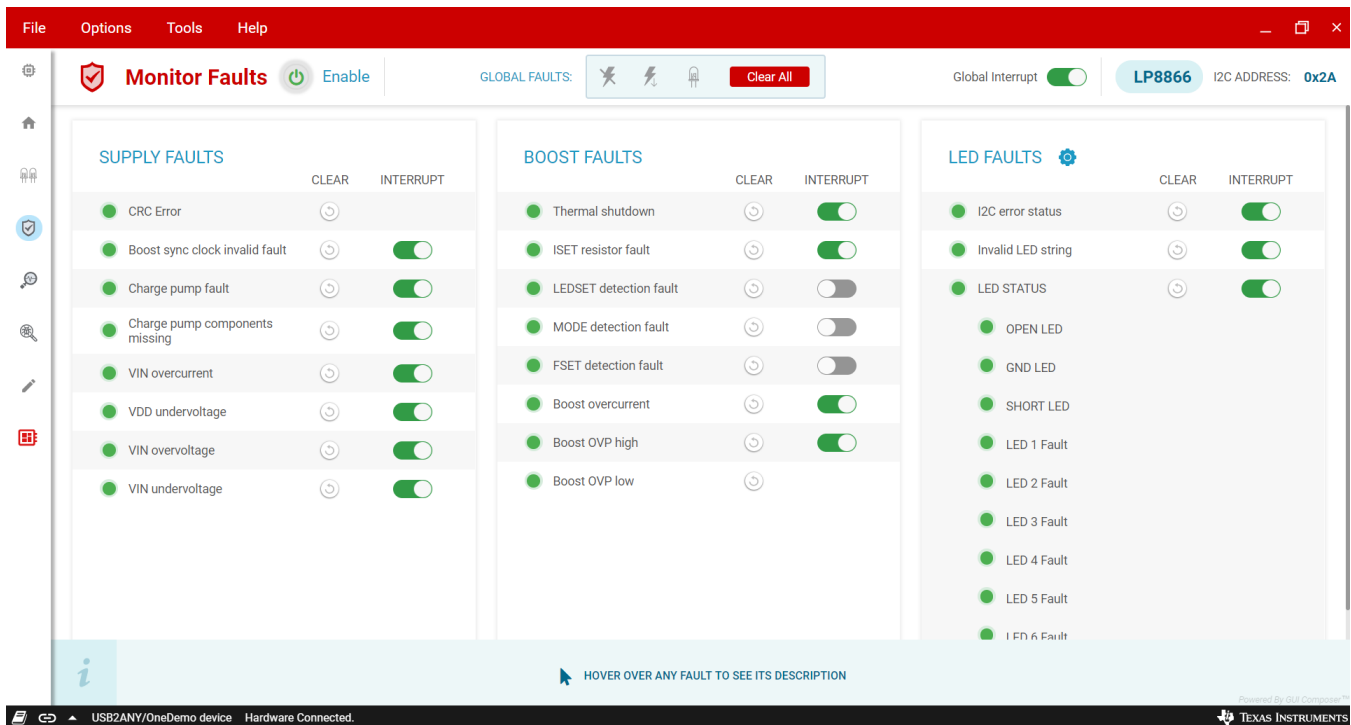

Figure 6. LP8866EVM Monitor Faults Page

2.6.2 Diagnostics Page

From the Diagnostics page (see [Figure 7](#)), the user can read back the following diagnostics register values and corresponding device status.

- **FSM_LIVE_STATUS**: current status of the functional state machine
- **PWM_INPUT_STATUS**: 16-bit value for detected duty cycle of PWM input signal
- **PWM_OUTPUT_STATUS**: 16-bit value for configured duty cycle of PWM output signal
- **LED_CURRENT_STATUS**: 12-bit current DAC code that brightness path is driving to OUT1-6 output
- **VBOOST_STATUS**: 11-bit boost voltage code that adaptive voltage control loop sending to analog boost block
- **AUTO_PWM_FREQ_SEL**: LED PWM frequency value from PWM_SEL resistor detection
- **AUTO_LED_STRING_CFG**: LED string configuration from LED_SET resistor detection
- **AUTO_BOOST_FREQ_SEL**: boost switching frequency value from PWM_FSET resistor detection
- **MODE_SEL**: LED dimming mode value from MODE resistor detection

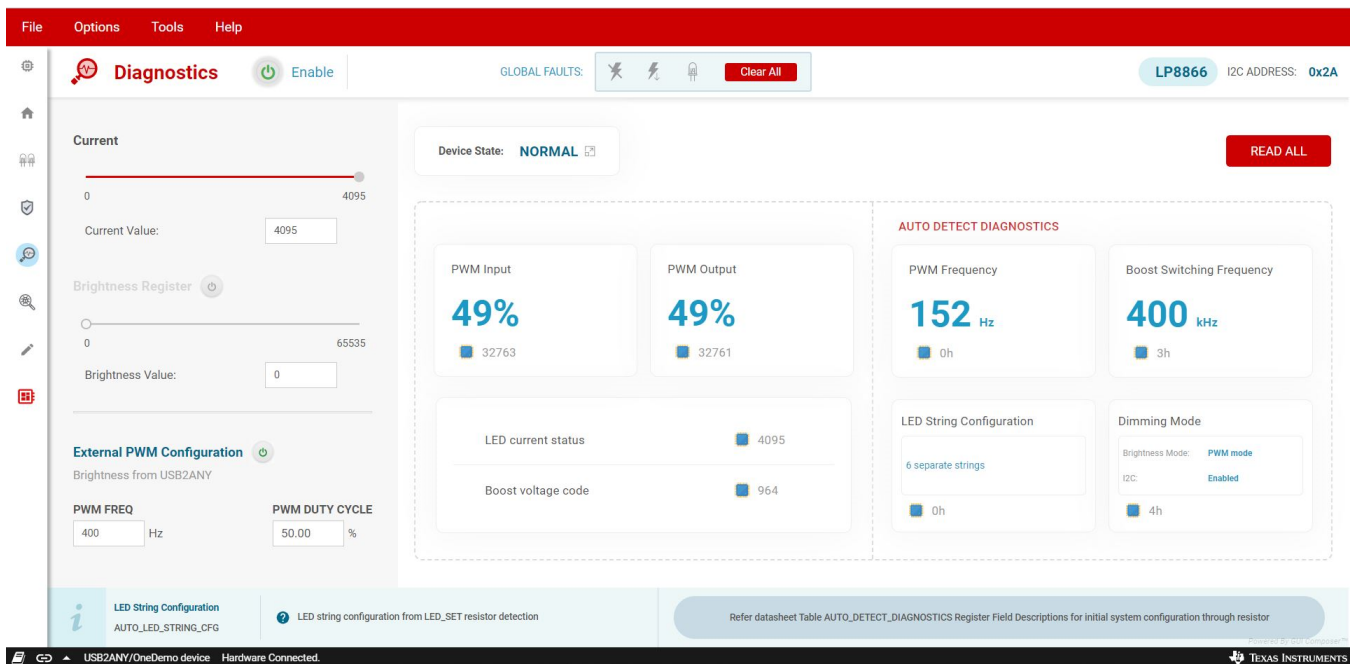

Figure 7. LP8866EVM Diagnostics Page

2.6.3 Register Map Page

Figure 8 shows the registers map page. All the registers are available on this page. When "Auto Read" is set to other than "Off", all the registers will be read automatically and periodically according to the interval time the user selects. Otherwise the user will need to click "READ REGISTER" to read the selected register or to click "READ ALL REGISTERS" to read all registers.

Clicking on the row of a register automatically updates the corresponding field view on the right side of the page. The register value can be updated by modifying the hexadecimal value in the "Value" column or by double-clicking the corresponding bit in the "Bits" column. The modified value is effective immediately if "Immediate Write" is selected. When "Deferred Write" is selected, the modified value won't take effect until the user clicks "WRITE REGISTER" button. All registers' value can be updated together by clicking "WRITE ALL REGISTERS".

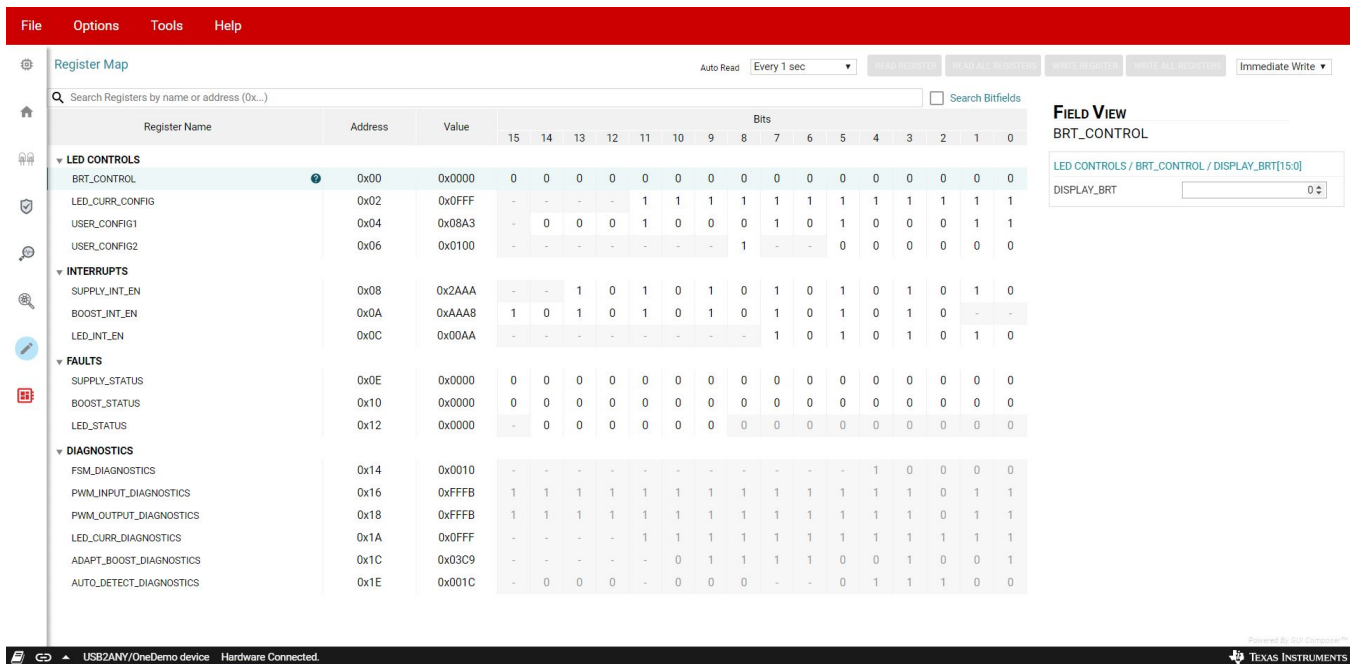

Figure 8. LP8866EVM Register Map Page

2.7 Instructions for Standalone Evaluation

The LP8866EVM can be used for standalone evaluation (without GUI software and PC connection). To support standalone mode, it must be modified from its default settings as described below:

1. Mount R20 to pull up EN input.
2. Change pullup and pulldown resistors to select spread spectrum enable (R18) or disable (R25) option.
3. Mount R19 to pull up PWM input for 100% brightness. If brightness needs to be changed from 100%, connect external PWM source at PWM pin.

The minimum procedures for turning on the LEDs after modifications above are as follows:

1. Connect a 12-V external power supply between the power input terminals VBAT+ and GNDin on the LP8866EVM.
2. Connect LP886X-LEDLAOD-EVM board (6 strings, 8 LEDs per string) to J10 on the LP8866EVM.
3. Turn on the external power supply.

3 LP8866EVM Board Layout

Figure 9 and Figure 10 illustrate the EVM board layout.

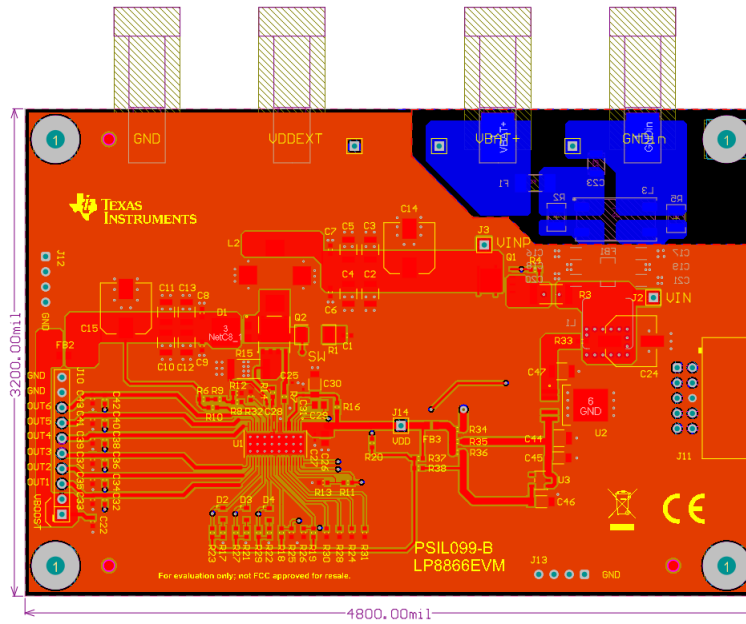

Figure 9. LP8866EVM Layout - Top

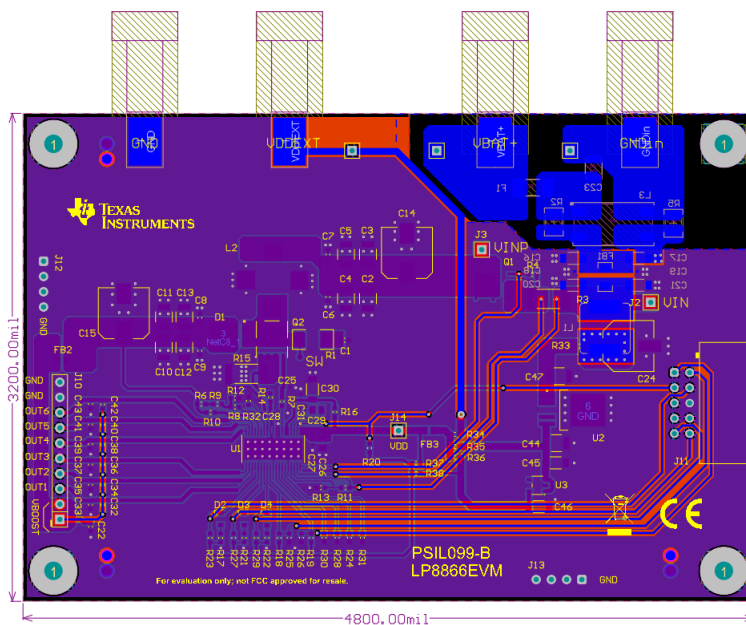

Figure 10. LP8866EVM Layout - Bottom

4 LP8866EVM Schematic

Figure 11 shows the LP8866EVM schematic.

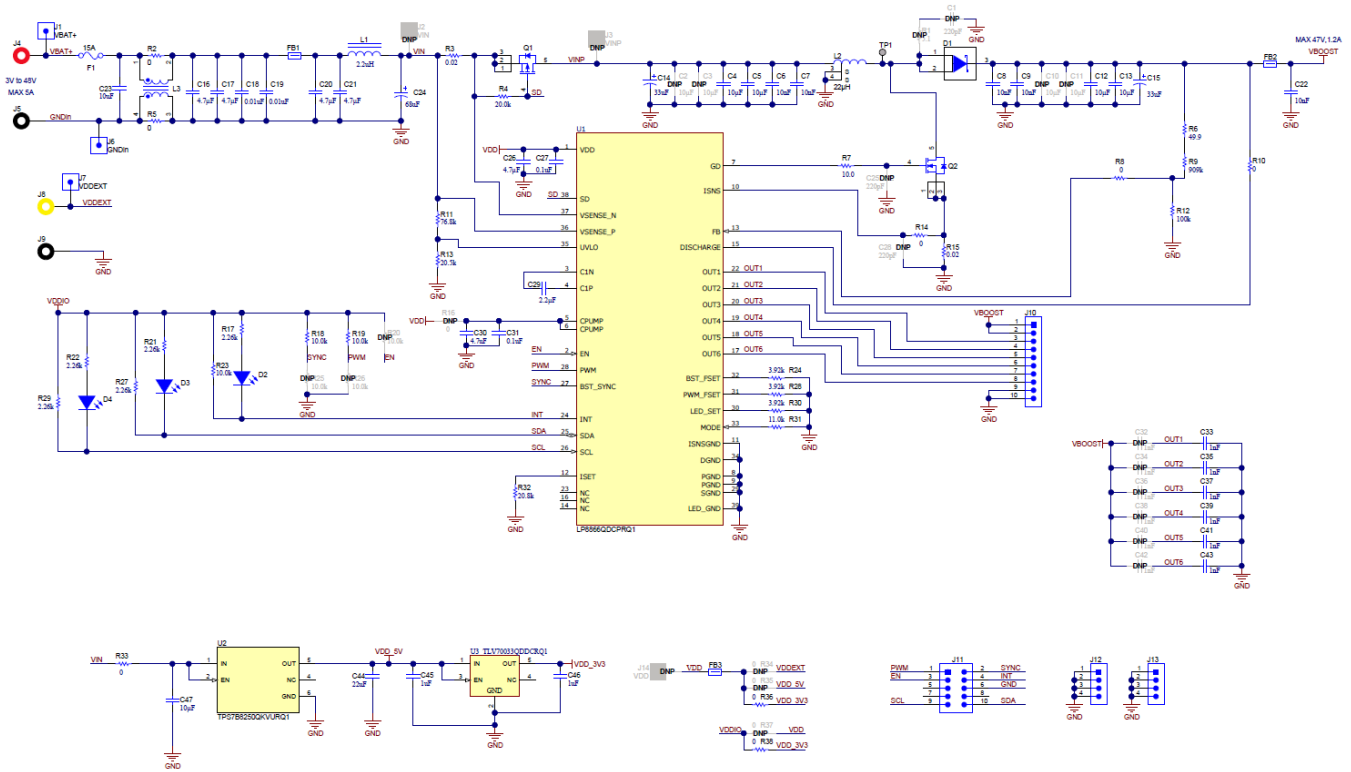

Figure 11. LP8866EVM Schematic

5 LP8866EVM Bill of Materials

Table 1 lists the bill of materials for the LP8866EVM.

Table 1. LP8866EVM Bill of Materials

Designator	QTY	Value	Part Number	Manufacturer	Description	Package Reference
!PCB1	1		PSIL099		Printed Circuit Board	
C4, C5, C12, C13, C47	5	10uF	CGA6P1X7R1N106M250AC	TDK	CAP, CERM, 10 µF, 75 V,+/- 20%, X7R, AEC-Q200 Grade 1, 1210	1210
C6, C7, C8, C9, C22	5	0.01uF	GCM188R72A103KA37J	MuRata	CAP, CERM, 0.01 µF, 100 V,+/- 10%, X7R, AEC-Q200 Grade 1, 0603	0603
C14, C15	2	33uF	EEHZC1J330P	Panasonic	CAP, Polymer Hybrid, 33 uF, 63 V, +/- 20%, 40 ohm, 8x10 SMD	8x10
C16, C17, C20, C21	4	4.7uF	CGA5L3X7R1H475K160AE	TDK	CAP, CERM, 4.7 µF, 50 V,+/- 10%, X7R, AEC-Q200 Grade 1, 1206	1206
C18, C19	2	0.01uF	GCM155R71H103KA55D	MuRata	CAP, CERM, 0.01 uF, 50 V, +/- 10%, COG/NPO, 0402	0402
C23	1	10uF	UMK325AB7106KMHT	Taiyo Yuden	CAP, CERM, 10 uF, 50 V, +/- 10%, X7R, AEC-Q200 Grade 1, 1210	1210
C24	1	68uF	EEE-FK1J680UP	Panasonic	CAP, AL, 68 uF, 63 V, +/- 20%, 0.65 ohm, AEC-Q200 Grade 2, SMD	SMT Radial F
C26	1	4.7uF	GCM21BR71C475KA73L	MuRata	CAP, CERM, 4.7 uF, 16 V, +/- 10%, X7R, AEC-Q200 Grade 1, 0805	0805
C27, C31	2	0.1uF	C0402C104K4RACAUTO	Kemet	CAP, CERM, 0.1 uF, 16 V, +/- 10%, X7R, AEC-Q200 Grade 1, 0402	0402
C29	1	2.2uF	CGA4J3X7R1H225K125AB	TDK	CAP, CERM, 2.2 uF, 50 V, +/- 10%, X7R, AEC-Q200 Grade 1, 0805	0805
C30	1	4.7uF	GCM31CR71C475KA37L	MuRata	CAP, CERM, 4.7 uF, 16 V, +/- 10%, X7R, AEC-Q200 Grade 1, 1206	1206
C33, C35, C37, C39, C41, C43	6	1000pF	CGA3E2X7R2A102K080AA	TDK	CAP, CERM, 1000 pF, 100 V, +/- 10%, X7R, AEC-Q200 Grade 1, 0603	0603
C44	1	22uF	CGA6P1X7R1C226M250AC	TDK	CAP, CERM, 22 uF, 16 V, +/- 20%, X7R, AEC-Q200 Grade 1, 1210	1210
C45, C46	2	1uF	CGA5L2X7R1E105M160AA	TDK	CAP, CERM, 1 uF, 25 V, +/- 20%, X7R, AEC-Q200 Grade 1, 1206_190	1206_190
D1	1	100V	FSV10100V	Fairchild Semiconductor	Diode, Schottky, 100 V, 10 A, AEC-Q101, TO-277A	TO-277A
D2, D3, D4	3	Super Red	VLMS20J2L1-GS08	Vishay-Semiconductor	LED, Super Red, SMD	2.2x1.3x1.4mm
F1	1		0679L9150-01	Bel Fuse	FUSE BRD MNT 15A 125VAC/VDC	2410
FB1	1	50 ohm	BLM31SN500SZ1L	MuRata	Ferrite Bead, 50 ohm @ 100 MHz, 12 A, 1206	1206
FB2, FB3	2	560 ohm	782853561	Würth Elektronik	Ferrite Bead, 560 ohm @ 100 MHz, 1.5 A, 0805	0805
H1, H2, H3, H4	4		NY PMS 440 0025 PH	B&F Fastener Supply	Machine Screw, Round, #4-40 x 1/4, Nylon, Philips panhead	Screw

Table 1. LP8866EVM Bill of Materials (continued)

Designator	QTY	Value	Part Number	Manufacturer	Description	Package Reference
H5, H6, H7, H8	4		1902C	Keystone		Standoff
H9	1		PSIL110		PSIL110, LP886X-LEDLOAD-EVM, CDDS#: 6631820	
H10	1		USB2ANY		USB2ANY, CDDS#: 6542513	
J1, J6, J7	3		TSW-101-07-G-S	Samtec	Header, 100mil, 1pos, Gold, TH	Testpoint
J4	1		6091	Keystone	Standard Banana Jack, Insulated, Red	6091
J5, J9	2		6092	Keystone	Standard Banana Jack, Insulated, Black	6092
J8	1		108-0907-001	Cinch Connectivity	BANANA JACK, 15A, Insulated, Nylon, Yellow	940x438x438mil
J10	1		TSW-110-07-G-S	Samtec	Header, 100mil, 10x1, Gold, TH	10x1 Header
J11	1		SBH11-PBPC-D05-RA-BK	Sullins Connector Solutions	Header(shrouded), 2.54mm, 5x2, Gold, R/A, TH	Header, 2.54mm, 5x2, R/A, TH
J12, J13	2		TSW-104-07-G-S	Samtec	Header, 100mil, 4x1, Gold, TH	4x1 Header
L1	1	2.2uH	IHLP3232DZER2R2M01	Vishay-Dale	Inductor, Shielded, Powdered Iron, 2.2 uH, 10.5 A, 0.0137 ohm, SMD	322x158x322mil
L2	1	22uH	IHLE4040DDER220M5A	Vishay-Dale	Inductor, Shielded, 22 uH, 4.1 A, 0.07544 ohm, AEC-Q200 Grade 0, SMD	Shielded Inductor
L3	1	9uH	PLT10HH501100PNL	MuRata	Coupled inductor, 9 uH, 10A, 0.0036 ohm, SMD	12.9x6.6mm
Q1	1	-60V	SQJ459EP-T1_GE3	Vishay-Semiconductor	MOSFET, P-CH, -60 V, -52 A, AEC-Q101, PowerPAK_SO-8L	PowerPAK_SO-8L
Q2	1	60V	NVMFS5C673NLWFAFT1G	ON Semiconductor	MOSFET, N-CH, 60 V, 50 A, SO-8FL	SO-8FL
R2, R5	2	0	CRCW12100000Z0EAHP	Vishay-Dale	RES, 0, 1%, 0.75 W, AEC-Q200 Grade 0, 1210	1210
R3, R15	2	0.02	CRA2512-FZ-R020ELF	Bourns	RES, 0.02, 1%, 3 W, 2512	2512
R4	1	20.0k	ERJ-3EKF2002V	Panasonic	RES, 20.0 k, 1%, 0.1 W, AEC-Q200 Grade 0, 0603	0603
R6	1	49.9	CRCW060349R9FKEA	Vishay-Dale	RES, 49.9, 1%, 0.1 W, AEC-Q200 Grade 0, 0603	0603
R7	1	10.0	CRCW060310R0FKEA	Vishay-Dale	RES, 10.0, 1%, 0.1 W, AEC-Q200 Grade 0, 0603	0603
R8, R10, R14, R33, R36, R38	6	0	RMCF0603ZT0R00	Stackpole Electronics Inc	RES, 0, 1%, 0.1 W, AEC-Q200 Grade 0, 0603	0603
R9	1	909k	CRCW0603909KFKEA	Vishay-Dale	RES, 909 k, 1%, 0.1 W, AEC-Q200 Grade 0, 0603	0603
R11	1	76.8k	CRCW060376K8FKEA	Vishay-Dale	RES, 76.8 k, 1%, 0.1 W, AEC-Q200 Grade 0, 0603	0603
R12	1	100k	CRCW0603100KFKEA	Vishay-Dale	RES, 100 k, 1%, 0.1 W, AEC-Q200 Grade 0, 0603	0603
R13	1	20.5k	CRCW060320K5FKEA	Vishay-Dale	RES, 20.5 k, 1%, 0.1 W, AEC-Q200 Grade 0, 0603	0603
R17, R21, R22, R27, R29	5	2.26k	CRCW06032K26FKEA	Vishay-Dale	RES, 2.26 k, 1%, 0.1 W, AEC-Q200 Grade 0, 0603	0603
R18, R19, R23	3	10.0k	RMCF0603FT10K0	Stackpole Electronics Inc	RES, 10.0 k, 1%, 0.1 W, AEC-Q200 Grade 0, 0603	0603

Table 1. LP8866EVM Bill of Materials (continued)

Designator	QTY	Value	Part Number	Manufacturer	Description	Package Reference
R24, R28, R30	3	3.92k	CRCW06033K92FKEA	Vishay-Dale	RES, 3.92 k, 1%, 0.1 W, AEC-Q200 Grade 0, 0603	0603
R31	1	11.0k	RMCF0603FT11K0	Stackpole Electronics Inc	RES, 11.0 k, 1%, 0.1 W, AEC-Q200 Grade 0, 0603	0603
R32	1	20.8k	RT0603BRD0720K8L	Yageo America	RES, 20.8 k, 0.1%, 0.1 W, 0603	0603
U1	1		LP8866QDCPRQ1	Texas Instruments	Automotive Display LED-backlight with Six 200-mA Channels	HTSSOP38
U2	1		TPS7B8250QKVURQ1	Texas Instruments	Automotive 300-mA high-voltage ultra-low-Iq low-dropout (LDO) regulator, KVVU0005A (TO-252-5)	KVVU0005A
U3	1		TLV70033QDDCRQ1	Texas Instruments	Single Output Automotive LDO, 200 mA, Fixed 3.3 V Output, 2 to 5.5 V Input, with Low IQ, 5-pin SOT (DDC), -40 to 125 degC, Green (RoHS & no Sb/Br)	DDC0005A
C1	0	220pF	GRM188R72A221KA01D	MuRata	CAP, CERM, 220 pF, 100 V, +/- 10%, X7R, 0603	0603
C2, C3, C10, C11	0	10uF	CGA6P1X7R1N106M250AC	TDK	CAP, CERM, 10 µF, 75 V, +/- 20%, X7R, AEC-Q200 Grade 1, 1210	1210
C25, C28	0	220pF	CGA2B2X7R1H221K050BA	TDK	CAP, CERM, 220 pF, 50 V, +/- 10%, X7R, AEC-Q200 Grade 1, 0402	0402
C32, C34, C36, C38, C40, C42	0	1000pF	CGA3E2X7R2A102K080AA	TDK	CAP, CERM, 1000 pF, 100 V, +/- 10%, X7R, AEC-Q200 Grade 1, 0603	0603
FID1, FID2, FID3, FID4, FID5, FID6	0		N/A	N/A	Fiducial mark. There is nothing to buy or mount.	N/A
J2, J3, J14	0		TSW-101-07-G-S	Samtec	Header, 100mil, 1pos, Gold, TH	Testpoint
R1	0	5.1	CRCW20105R10JNEF	Vishay-Dale	RES, 5.1, 5%, 0.75 W, AEC-Q200 Grade 0, 2010	2010
R16, R34, R35, R37	0	0	RMCF0603ZT0R00	Stackpole Electronics Inc	RES, 0, 1%, 0.1 W, AEC-Q200 Grade 0, 0603	0603
R20, R25, R26	0	10.0k	RMCF0603FT10K0	Stackpole Electronics Inc	RES, 10.0 k, 1%, 0.1 W, AEC-Q200 Grade 0, 0603	0603

6 LED Load Board

An LED load board LP886X-LEDLOAD-EVM is included in the EVM kit. The LED board is intended to be used as the load for LED driver and can be configured for up to 6 strings and up to 20 LEDs in the string (Number of LEDs in use is defined by jumpers). The initial setting on the board is 8 LEDs in series per string. Cree XLamp ML-C LEDs with maximum current of 350 mA (for parallel use) and maximum forward voltage of 3.4 V at 100 mA (3.2-V typical) are used on the board.

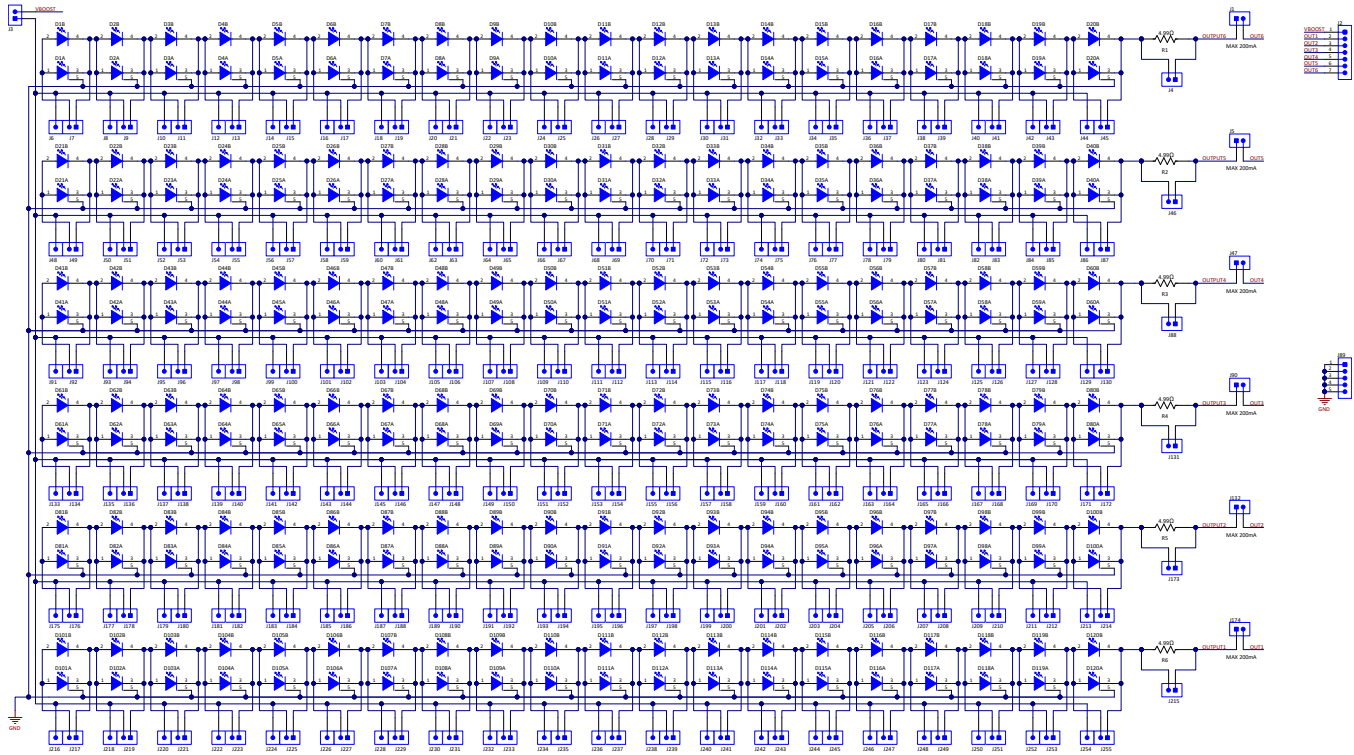

Figure 12. LP886X-LEDLOAD-EVM Schematic

Table 2. LP886X-LEDLOAD-EVM Bill of Materials

Designator	QTY	Part Number	Manufacturer	Description	Package Reference
!PCB1	1	PSIL110		Printed Circuit Board	
D1...D120	120	MLCAWT-A1-0000-000XE1	Cree Inc.	LED XLAMP COOL WHITE 6500K 4SMD	SMD4
H1, H2, H3, H4	4	NY PMS 440 0038 PH	B&F Fastener Supply		
H5, H6, H7, H8	4	1902C	Keystone		Standoff
H9, H10, H11, H12	4	4802	Keystone		
H13	1	MCH050		Gray smoked plexiglass, 0.125" THK. Must comply with REACH directive. Must meet or exceed UL94-V0	7.53" X 4" X 0.125"
J7, J9...J43, J45; J49, J51...J85, J87; J92, J94...J128, J130; J134, J136...J170, J172; J176, J178...J212, J214; J217, J219...J253, J255; J1, J3, J4, J5, J46, J47, J88, J90, J131, J132, J173, J174, J215	133	TSW-102-07-G-S	Samtec	Header, 100mil, 2x1, Gold, TH	2x1 Header
J2	1	TSW-107-07-G-S	Samtec	Header, 100mil, 7x1, Gold, TH	7x1 Header

Table 2. LP886X-LEDLOAD-EVM Bill of Materials (continued)

Designator	QTY	Part Number	Manufacturer	Description	Package Reference
J6, J8...J42, J44; J48, J50...J84, J86; J91, J93...J127, J129; J133, J135...J169, J171; J175, J177...J211, J213; J216, J218...J252, J254	120	TSW-101-07-G-S	Samtec	Header, 100mil, 1pos, Gold, TH	Testpoint
J89	1	TSW-105-07-G-S	Samtec	Header, 100mil, 5x1, Gold, TH	5x1 Header
R1, R2, R3, R4, R5, R6	6	CRCW12064R99FKEA HP	Vishay Dale	Res Thick Film 1206 4.99 Ohm 1% 0.75W(3/4W) ±100ppm/C Pad SMD Automotive T/R	1206
SH-J1...SH-J19	19	SPC02SYAN	Sullins Connector Solutions	Shunt, 100mil, Flash Gold, Black	Closed Top 100mil Shunt
FID1, FID2, FID3	0	N/A	N/A	Fiducial mark. There is nothing to buy or mount.	N/A

Revision History

NOTE: Page numbers for previous revisions may differ from page numbers in the current version.

Changes from Original (December 2019) to A Revision	Page
• Changed resistors and connectors in Section 2.7	9
• Changed LP8866EVM schematic in Figure 11	11
• Changed LP8866EVM bill of materials in Table 1	12

STANDARD TERMS FOR EVALUATION MODULES

1. *Delivery:* TI delivers TI evaluation boards, kits, or modules, including any accompanying demonstration software, components, and/or documentation which may be provided together or separately (collectively, an "EVM" or "EVMs") to the User ("User") in accordance with the terms set forth herein. User's acceptance of the EVM is expressly subject to the following terms.
 - 1.1 EVMs are intended solely for product or software developers for use in a research and development setting to facilitate feasibility evaluation, experimentation, or scientific analysis of TI semiconductors products. EVMs have no direct function and are not finished products. EVMs shall not be directly or indirectly assembled as a part or subassembly in any finished product. For clarification, any software or software tools provided with the EVM ("Software") shall not be subject to the terms and conditions set forth herein but rather shall be subject to the applicable terms that accompany such Software
 - 1.2 EVMs are not intended for consumer or household use. EVMs may not be sold, sublicensed, leased, rented, loaned, assigned, or otherwise distributed for commercial purposes by Users, in whole or in part, or used in any finished product or production system.
2. *Limited Warranty and Related Remedies/Disclaimers:*
 - 2.1 These terms do not apply to Software. The warranty, if any, for Software is covered in the applicable Software License Agreement.
 - 2.2 TI warrants that the TI EVM will conform to TI's published specifications for ninety (90) days after the date TI delivers such EVM to User. Notwithstanding the foregoing, TI shall not be liable for a nonconforming EVM if (a) the nonconformity was caused by neglect, misuse or mistreatment by an entity other than TI, including improper installation or testing, or for any EVMs that have been altered or modified in any way by an entity other than TI, (b) the nonconformity resulted from User's design, specifications or instructions for such EVMs or improper system design, or (c) User has not paid on time. Testing and other quality control techniques are used to the extent TI deems necessary. TI does not test all parameters of each EVM. User's claims against TI under this Section 2 are void if User fails to notify TI of any apparent defects in the EVMs within ten (10) business days after delivery, or of any hidden defects with ten (10) business days after the defect has been detected.
 - 2.3 TI's sole liability shall be at its option to repair or replace EVMs that fail to conform to the warranty set forth above, or credit User's account for such EVM. TI's liability under this warranty shall be limited to EVMs that are returned during the warranty period to the address designated by TI and that are determined by TI not to conform to such warranty. If TI elects to repair or replace such EVM, TI shall have a reasonable time to repair such EVM or provide replacements. Repaired EVMs shall be warranted for the remainder of the original warranty period. Replaced EVMs shall be warranted for a new full ninety (90) day warranty period.

WARNING

Evaluation Kits are intended solely for use by technically qualified, professional electronics experts who are familiar with the dangers and application risks associated with handling electrical mechanical components, systems, and subsystems.

User shall operate the Evaluation Kit within TI's recommended guidelines and any applicable legal or environmental requirements as well as reasonable and customary safeguards. Failure to set up and/or operate the Evaluation Kit within TI's recommended guidelines may result in personal injury or death or property damage. Proper set up entails following TI's instructions for electrical ratings of interface circuits such as input, output and electrical loads.

NOTE:

EXPOSURE TO ELECTROSTATIC DISCHARGE (ESD) MAY CAUSE DEGRADATION OR FAILURE OF THE EVALUATION KIT; TI RECOMMENDS STORAGE OF THE EVALUATION KIT IN A PROTECTIVE ESD BAG.

3 Regulatory Notices:

3.1 United States

3.1.1 Notice applicable to EVMs not FCC-Approved:

FCC NOTICE: This kit is designed to allow product developers to evaluate electronic components, circuitry, or software associated with the kit to determine whether to incorporate such items in a finished product and software developers to write software applications for use with the end product. This kit is not a finished product and when assembled may not be resold or otherwise marketed unless all required FCC equipment authorizations are first obtained. Operation is subject to the condition that this product not cause harmful interference to licensed radio stations and that this product accept harmful interference. Unless the assembled kit is designed to operate under part 15, part 18 or part 95 of this chapter, the operator of the kit must operate under the authority of an FCC license holder or must secure an experimental authorization under part 5 of this chapter.

3.1.2 For EVMs annotated as FCC – FEDERAL COMMUNICATIONS COMMISSION Part 15 Compliant:

CAUTION

This device complies with part 15 of the FCC Rules. Operation is subject to the following two conditions: (1) This device may not cause harmful interference, and (2) this device must accept any interference received, including interference that may cause undesired operation.

Changes or modifications not expressly approved by the party responsible for compliance could void the user's authority to operate the equipment.

FCC Interference Statement for Class A EVM devices

NOTE: This equipment has been tested and found to comply with the limits for a Class A digital device, pursuant to part 15 of the FCC Rules. These limits are designed to provide reasonable protection against harmful interference when the equipment is operated in a commercial environment. This equipment generates, uses, and can radiate radio frequency energy and, if not installed and used in accordance with the instruction manual, may cause harmful interference to radio communications. Operation of this equipment in a residential area is likely to cause harmful interference in which case the user will be required to correct the interference at his own expense.

FCC Interference Statement for Class B EVM devices

NOTE: This equipment has been tested and found to comply with the limits for a Class B digital device, pursuant to part 15 of the FCC Rules. These limits are designed to provide reasonable protection against harmful interference in a residential installation. This equipment generates, uses and can radiate radio frequency energy and, if not installed and used in accordance with the instructions, may cause harmful interference to radio communications. However, there is no guarantee that interference will not occur in a particular installation. If this equipment does cause harmful interference to radio or television reception, which can be determined by turning the equipment off and on, the user is encouraged to try to correct the interference by one or more of the following measures:

- Reorient or relocate the receiving antenna.
- Increase the separation between the equipment and receiver.
- Connect the equipment into an outlet on a circuit different from that to which the receiver is connected.
- Consult the dealer or an experienced radio/TV technician for help.

3.2 Canada

3.2.1 For EVMs issued with an Industry Canada Certificate of Conformance to RSS-210 or RSS-247

Concerning EVMs Including Radio Transmitters:

This device complies with Industry Canada license-exempt RSSs. Operation is subject to the following two conditions:

(1) this device may not cause interference, and (2) this device must accept any interference, including interference that may cause undesired operation of the device.

Concernant les EVMs avec appareils radio:

Le présent appareil est conforme aux CNR d'Industrie Canada applicables aux appareils radio exempts de licence. L'exploitation est autorisée aux deux conditions suivantes: (1) l'appareil ne doit pas produire de brouillage, et (2) l'utilisateur de l'appareil doit accepter tout brouillage radioélectrique subi, même si le brouillage est susceptible d'en compromettre le fonctionnement.

Concerning EVMs Including Detachable Antennas:

Under Industry Canada regulations, this radio transmitter may only operate using an antenna of a type and maximum (or lesser) gain approved for the transmitter by Industry Canada. To reduce potential radio interference to other users, the antenna type and its gain should be so chosen that the equivalent isotropically radiated power (e.i.r.p.) is not more than that necessary for successful communication. This radio transmitter has been approved by Industry Canada to operate with the antenna types listed in the user guide with the maximum permissible gain and required antenna impedance for each antenna type indicated. Antenna types not included in this list, having a gain greater than the maximum gain indicated for that type, are strictly prohibited for use with this device.

Concernant les EVMs avec antennes détachables

Conformément à la réglementation d'Industrie Canada, le présent émetteur radio peut fonctionner avec une antenne d'un type et d'un gain maximal (ou inférieur) approuvé pour l'émetteur par Industrie Canada. Dans le but de réduire les risques de brouillage radioélectrique à l'intention des autres utilisateurs, il faut choisir le type d'antenne et son gain de sorte que la puissance isotrope rayonnée équivalente (p.i.r.e.) ne dépasse pas l'intensité nécessaire à l'établissement d'une communication satisfaisante. Le présent émetteur radio a été approuvé par Industrie Canada pour fonctionner avec les types d'antenne énumérés dans le manuel d'usage et ayant un gain admissible maximal et l'impédance requise pour chaque type d'antenne. Les types d'antenne non inclus dans cette liste, ou dont le gain est supérieur au gain maximal indiqué, sont strictement interdits pour l'exploitation de l'émetteur.

3.3 Japan

3.3.1 *Notice for EVMs delivered in Japan:* Please see http://www.tij.co.jp/lstds/ti_ja/general/eStore/notice_01.page 日本国内に輸入される評価用キット、ボードについては、次のところをご覧ください。
http://www.tij.co.jp/lstds/ti_ja/general/eStore/notice_01.page

3.3.2 *Notice for Users of EVMs Considered "Radio Frequency Products" in Japan:* EVMs entering Japan may not be certified by TI as conforming to Technical Regulations of Radio Law of Japan.

If User uses EVMs in Japan, not certified to Technical Regulations of Radio Law of Japan, User is required to follow the instructions set forth by Radio Law of Japan, which includes, but is not limited to, the instructions below with respect to EVMs (which for the avoidance of doubt are stated strictly for convenience and should be verified by User):

1. Use EVMs in a shielded room or any other test facility as defined in the notification #173 issued by Ministry of Internal Affairs and Communications on March 28, 2006, based on Sub-section 1.1 of Article 6 of the Ministry's Rule for Enforcement of Radio Law of Japan,
2. Use EVMs only after User obtains the license of Test Radio Station as provided in Radio Law of Japan with respect to EVMs, or
3. Use of EVMs only after User obtains the Technical Regulations Conformity Certification as provided in Radio Law of Japan with respect to EVMs. Also, do not transfer EVMs, unless User gives the same notice above to the transferee. Please note that if User does not follow the instructions above, User will be subject to penalties of Radio Law of Japan.

【無線電波を送信する製品の開発キットをお使いになる際の注意事項】 開発キットの中には技術基準適合証明を受けていないものがあります。技術適合証明を受けていないものご使用に際しては、電波法遵守のため、以下のいずれかの措置を取っていただく必要がありますのでご注意ください。

1. 電波法施行規則第6条第1項第1号に基づく平成18年3月28日総務省告示第173号で定められた電波暗室等の試験設備でご使用いただく。
2. 実験局の免許を取得後ご使用いただく。
3. 技術基準適合証明を取得後ご使用いただく。

なお、本製品は、上記の「ご使用にあたっての注意」を譲渡先、移転先に通知しない限り、譲渡、移転できないものとします。

上記を遵守頂けない場合は、電波法の罰則が適用される可能性があることをご留意ください。日本テキサス・インスツルメンツ株式会社
東京都新宿区西新宿 6 丁目 2 4 番 1 号
西新宿三井ビル

3.3.3 *Notice for EVMs for Power Line Communication:* Please see http://www.tij.co.jp/lstds/ti_ja/general/eStore/notice_02.page 電力線搬送波通信についての開発キットをお使いになる際の注意事項については、次のところをご覧ください。
http://www.tij.co.jp/lstds/ti_ja/general/eStore/notice_02.page

3.4 European Union

3.4.1 *For EVMs subject to EU Directive 2014/30/EU (Electromagnetic Compatibility Directive):*

This is a class A product intended for use in environments other than domestic environments that are connected to a low-voltage power-supply network that supplies buildings used for domestic purposes. In a domestic environment this product may cause radio interference in which case the user may be required to take adequate measures.

-
- 4 *EVM Use Restrictions and Warnings:*
 - 4.1 EVMS ARE NOT FOR USE IN FUNCTIONAL SAFETY AND/OR SAFETY CRITICAL EVALUATIONS, INCLUDING BUT NOT LIMITED TO EVALUATIONS OF LIFE SUPPORT APPLICATIONS.
 - 4.2 User must read and apply the user guide and other available documentation provided by TI regarding the EVM prior to handling or using the EVM, including without limitation any warning or restriction notices. The notices contain important safety information related to, for example, temperatures and voltages.
 - 4.3 *Safety-Related Warnings and Restrictions:*
 - 4.3.1 User shall operate the EVM within TI's recommended specifications and environmental considerations stated in the user guide, other available documentation provided by TI, and any other applicable requirements and employ reasonable and customary safeguards. Exceeding the specified performance ratings and specifications (including but not limited to input and output voltage, current, power, and environmental ranges) for the EVM may cause personal injury or death, or property damage. If there are questions concerning performance ratings and specifications, User should contact a TI field representative prior to connecting interface electronics including input power and intended loads. Any loads applied outside of the specified output range may also result in unintended and/or inaccurate operation and/or possible permanent damage to the EVM and/or interface electronics. Please consult the EVM user guide prior to connecting any load to the EVM output. If there is uncertainty as to the load specification, please contact a TI field representative. During normal operation, even with the inputs and outputs kept within the specified allowable ranges, some circuit components may have elevated case temperatures. These components include but are not limited to linear regulators, switching transistors, pass transistors, current sense resistors, and heat sinks, which can be identified using the information in the associated documentation. When working with the EVM, please be aware that the EVM may become very warm.
 - 4.3.2 EVMs are intended solely for use by technically qualified, professional electronics experts who are familiar with the dangers and application risks associated with handling electrical mechanical components, systems, and subsystems. User assumes all responsibility and liability for proper and safe handling and use of the EVM by User or its employees, affiliates, contractors or designees. User assumes all responsibility and liability to ensure that any interfaces (electronic and/or mechanical) between the EVM and any human body are designed with suitable isolation and means to safely limit accessible leakage currents to minimize the risk of electrical shock hazard. User assumes all responsibility and liability for any improper or unsafe handling or use of the EVM by User or its employees, affiliates, contractors or designees.
 - 4.4 User assumes all responsibility and liability to determine whether the EVM is subject to any applicable international, federal, state, or local laws and regulations related to User's handling and use of the EVM and, if applicable, User assumes all responsibility and liability for compliance in all respects with such laws and regulations. User assumes all responsibility and liability for proper disposal and recycling of the EVM consistent with all applicable international, federal, state, and local requirements.
 5. *Accuracy of Information:* To the extent TI provides information on the availability and function of EVMs, TI attempts to be as accurate as possible. However, TI does not warrant the accuracy of EVM descriptions, EVM availability or other information on its websites as accurate, complete, reliable, current, or error-free.
 6. *Disclaimers:*
 - 6.1 EXCEPT AS SET FORTH ABOVE, EVMS AND ANY MATERIALS PROVIDED WITH THE EVM (INCLUDING, BUT NOT LIMITED TO, REFERENCE DESIGNS AND THE DESIGN OF THE EVM ITSELF) ARE PROVIDED "AS IS" AND "WITH ALL FAULTS." TI DISCLAIMS ALL OTHER WARRANTIES, EXPRESS OR IMPLIED, REGARDING SUCH ITEMS, INCLUDING BUT NOT LIMITED TO ANY EPIDEMIC FAILURE WARRANTY OR IMPLIED WARRANTIES OF MERCHANTABILITY OR FITNESS FOR A PARTICULAR PURPOSE OR NON-INFRINGEMENT OF ANY THIRD PARTY PATENTS, COPYRIGHTS, TRADE SECRETS OR OTHER INTELLECTUAL PROPERTY RIGHTS.
 - 6.2 EXCEPT FOR THE LIMITED RIGHT TO USE THE EVM SET FORTH HEREIN, NOTHING IN THESE TERMS SHALL BE CONSTRUED AS GRANTING OR CONFERRING ANY RIGHTS BY LICENSE, PATENT, OR ANY OTHER INDUSTRIAL OR INTELLECTUAL PROPERTY RIGHT OF TI, ITS SUPPLIERS/LICENSORS OR ANY OTHER THIRD PARTY, TO USE THE EVM IN ANY FINISHED END-USER OR READY-TO-USE FINAL PRODUCT, OR FOR ANY INVENTION, DISCOVERY OR IMPROVEMENT, REGARDLESS OF WHEN MADE, CONCEIVED OR ACQUIRED.
 7. *USER'S INDEMNITY OBLIGATIONS AND REPRESENTATIONS.* USER WILL DEFEND, INDEMNIFY AND HOLD TI, ITS LICENSORS AND THEIR REPRESENTATIVES HARMLESS FROM AND AGAINST ANY AND ALL CLAIMS, DAMAGES, LOSSES, EXPENSES, COSTS AND LIABILITIES (COLLECTIVELY, "CLAIMS") ARISING OUT OF OR IN CONNECTION WITH ANY HANDLING OR USE OF THE EVM THAT IS NOT IN ACCORDANCE WITH THESE TERMS. THIS OBLIGATION SHALL APPLY WHETHER CLAIMS ARISE UNDER STATUTE, REGULATION, OR THE LAW OF TORT, CONTRACT OR ANY OTHER LEGAL THEORY, AND EVEN IF THE EVM FAILS TO PERFORM AS DESCRIBED OR EXPECTED.
-

8. *Limitations on Damages and Liability:*

8.1 *General Limitations.* IN NO EVENT SHALL TI BE LIABLE FOR ANY SPECIAL, COLLATERAL, INDIRECT, PUNITIVE, INCIDENTAL, CONSEQUENTIAL, OR EXEMPLARY DAMAGES IN CONNECTION WITH OR ARISING OUT OF THESE TERMS OR THE USE OF THE EVMS , REGARDLESS OF WHETHER TI HAS BEEN ADVISED OF THE POSSIBILITY OF SUCH DAMAGES. EXCLUDED DAMAGES INCLUDE, BUT ARE NOT LIMITED TO, COST OF REMOVAL OR REINSTALLATION, ANCILLARY COSTS TO THE PROCUREMENT OF SUBSTITUTE GOODS OR SERVICES, RETESTING, OUTSIDE COMPUTER TIME, LABOR COSTS, LOSS OF GOODWILL, LOSS OF PROFITS, LOSS OF SAVINGS, LOSS OF USE, LOSS OF DATA, OR BUSINESS INTERRUPTION. NO CLAIM, SUIT OR ACTION SHALL BE BROUGHT AGAINST TI MORE THAN TWELVE (12) MONTHS AFTER THE EVENT THAT GAVE RISE TO THE CAUSE OF ACTION HAS OCCURRED.

8.2 *Specific Limitations.* IN NO EVENT SHALL TI'S AGGREGATE LIABILITY FROM ANY USE OF AN EVM PROVIDED HEREUNDER, INCLUDING FROM ANY WARRANTY, INDEMNITY OR OTHER OBLIGATION ARISING OUT OF OR IN CONNECTION WITH THESE TERMS, , EXCEED THE TOTAL AMOUNT PAID TO TI BY USER FOR THE PARTICULAR EVM(S) AT ISSUE DURING THE PRIOR TWELVE (12) MONTHS WITH RESPECT TO WHICH LOSSES OR DAMAGES ARE CLAIMED. THE EXISTENCE OF MORE THAN ONE CLAIM SHALL NOT ENLARGE OR EXTEND THIS LIMIT.

9. *Return Policy.* Except as otherwise provided, TI does not offer any refunds, returns, or exchanges. Furthermore, no return of EVM(s) will be accepted if the package has been opened and no return of the EVM(s) will be accepted if they are damaged or otherwise not in a resalable condition. If User feels it has been incorrectly charged for the EVM(s) it ordered or that delivery violates the applicable order, User should contact TI. All refunds will be made in full within thirty (30) working days from the return of the components(s), excluding any postage or packaging costs.

10. *Governing Law:* These terms and conditions shall be governed by and interpreted in accordance with the laws of the State of Texas, without reference to conflict-of-laws principles. User agrees that non-exclusive jurisdiction for any dispute arising out of or relating to these terms and conditions lies within courts located in the State of Texas and consents to venue in Dallas County, Texas. Notwithstanding the foregoing, any judgment may be enforced in any United States or foreign court, and TI may seek injunctive relief in any United States or foreign court.

Mailing Address: Texas Instruments, Post Office Box 655303, Dallas, Texas 75265
Copyright © 2019, Texas Instruments Incorporated

IMPORTANT NOTICE AND DISCLAIMER

TI PROVIDES TECHNICAL AND RELIABILITY DATA (INCLUDING DATASHEETS), DESIGN RESOURCES (INCLUDING REFERENCE DESIGNS), APPLICATION OR OTHER DESIGN ADVICE, WEB TOOLS, SAFETY INFORMATION, AND OTHER RESOURCES "AS IS" AND WITH ALL FAULTS, AND DISCLAIMS ALL WARRANTIES, EXPRESS AND IMPLIED, INCLUDING WITHOUT LIMITATION ANY IMPLIED WARRANTIES OF MERCHANTABILITY, FITNESS FOR A PARTICULAR PURPOSE OR NON-INFRINGEMENT OF THIRD PARTY INTELLECTUAL PROPERTY RIGHTS.

These resources are intended for skilled developers designing with TI products. You are solely responsible for (1) selecting the appropriate TI products for your application, (2) designing, validating and testing your application, and (3) ensuring your application meets applicable standards, and any other safety, security, or other requirements. These resources are subject to change without notice. TI grants you permission to use these resources only for development of an application that uses the TI products described in the resource. Other reproduction and display of these resources is prohibited. No license is granted to any other TI intellectual property right or to any third party intellectual property right. TI disclaims responsibility for, and you will fully indemnify TI and its representatives against, any claims, damages, costs, losses, and liabilities arising out of your use of these resources.

TI's products are provided subject to TI's Terms of Sale (www.ti.com/legal/termsofsale.html) or other applicable terms available either on ti.com or provided in conjunction with such TI products. TI's provision of these resources does not expand or otherwise alter TI's applicable warranties or warranty disclaimers for TI products.

Mailing Address: Texas Instruments, Post Office Box 655303, Dallas, Texas 75265
Copyright © 2020, Texas Instruments Incorporated