

## Test Report: PMP21842

# 12-V/500-W resonant converter reference design with HV GaN FET



### Description

This high-frequency resonant converter reference design regulates a 12-V output from a 380-V to 400-V input voltage range using a resonant tank with 500 kHz resonant frequency. A peak efficiency of 96.0% (bias supply included) is achieved with this design using our high-voltage GaN device along with UCD3138A and UCD7138 to optimize the dead time and synchronous rectifier (SR) conduction.

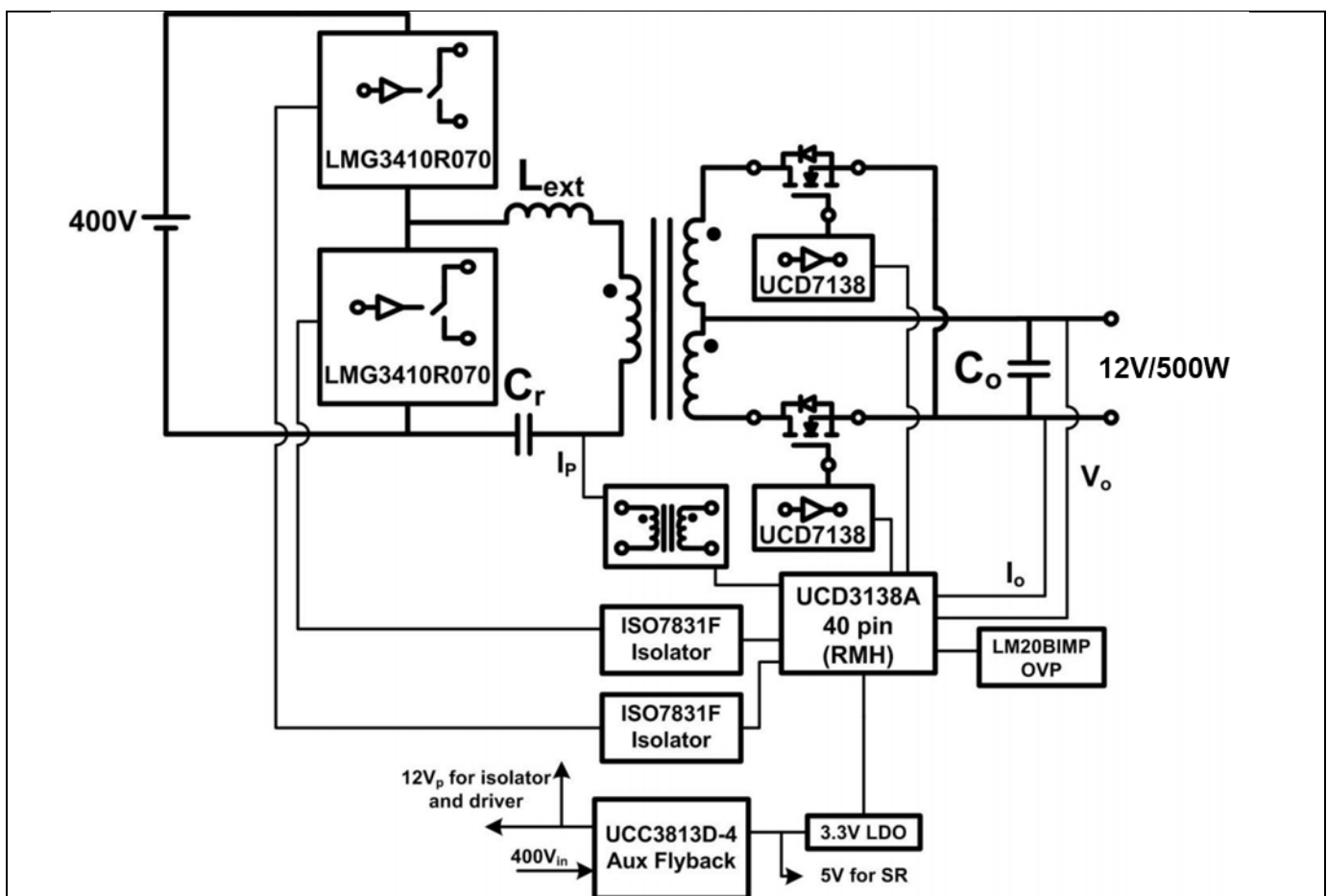

An IMPORTANT NOTICE at the end of this TI reference design addresses authorized use, intellectual property matters and other important disclaimers and information.

## 1 System Specification

### 1.1 Board Dimension:

2.5" x 4" x 1.4"

### 1.2 Input Characteristics

Minimum	Nominal	Maximum	
380	390	400	<b>VDC</b>

### 1.3 Output Characteristics

The power supply unit should be able to supply 12V+/-5% with 500W maximum output power.

## 2 Testing and Results

### 2.1 Board Photos

The photographs below show the top and bottom view of the PMP21842 Rev A board. Notice that PMP21842 circuit was built on PMP21309 RevA PCB.

#### 2.1.1 Top Side

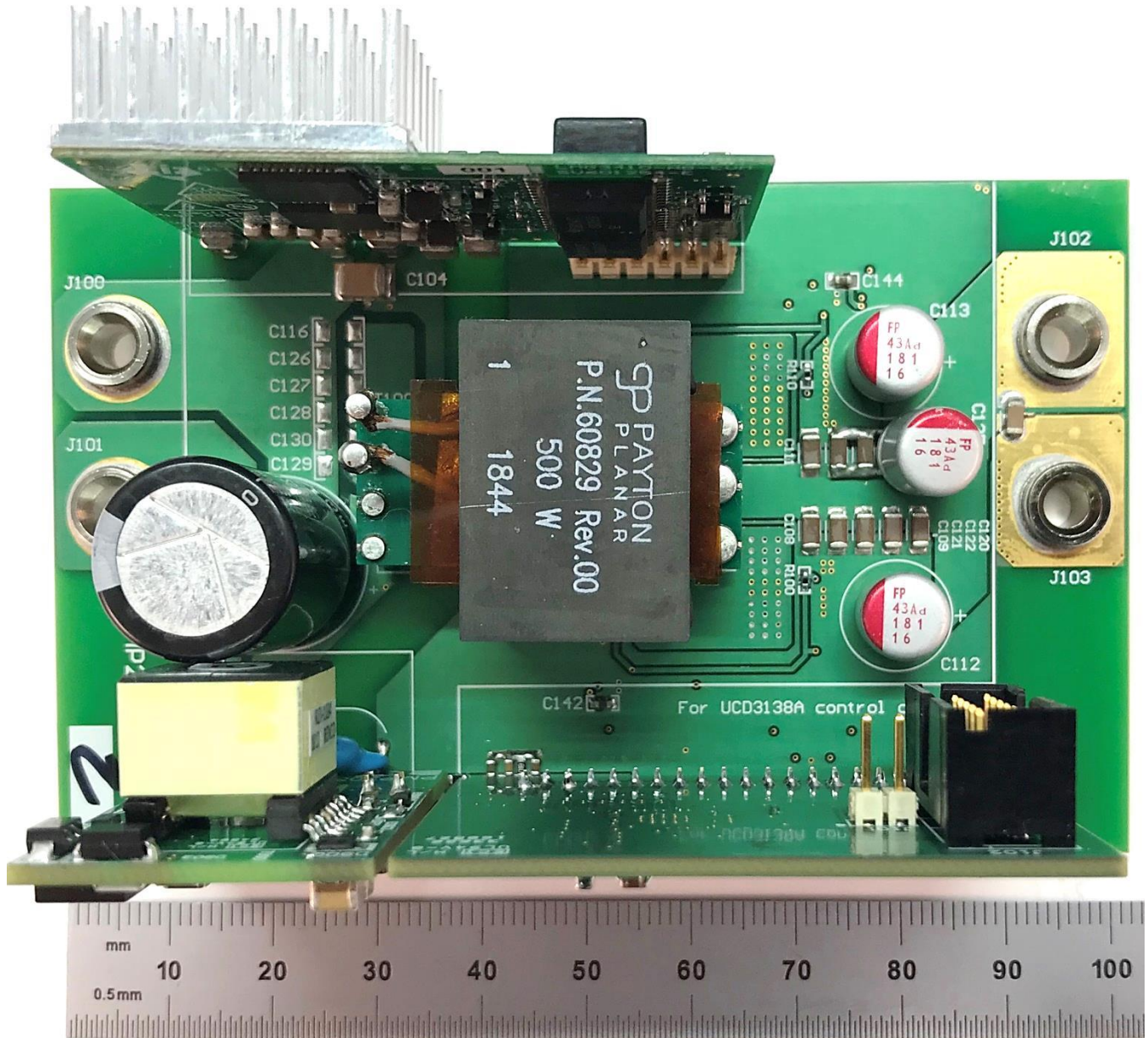

## 2.1.2 Bottom Side

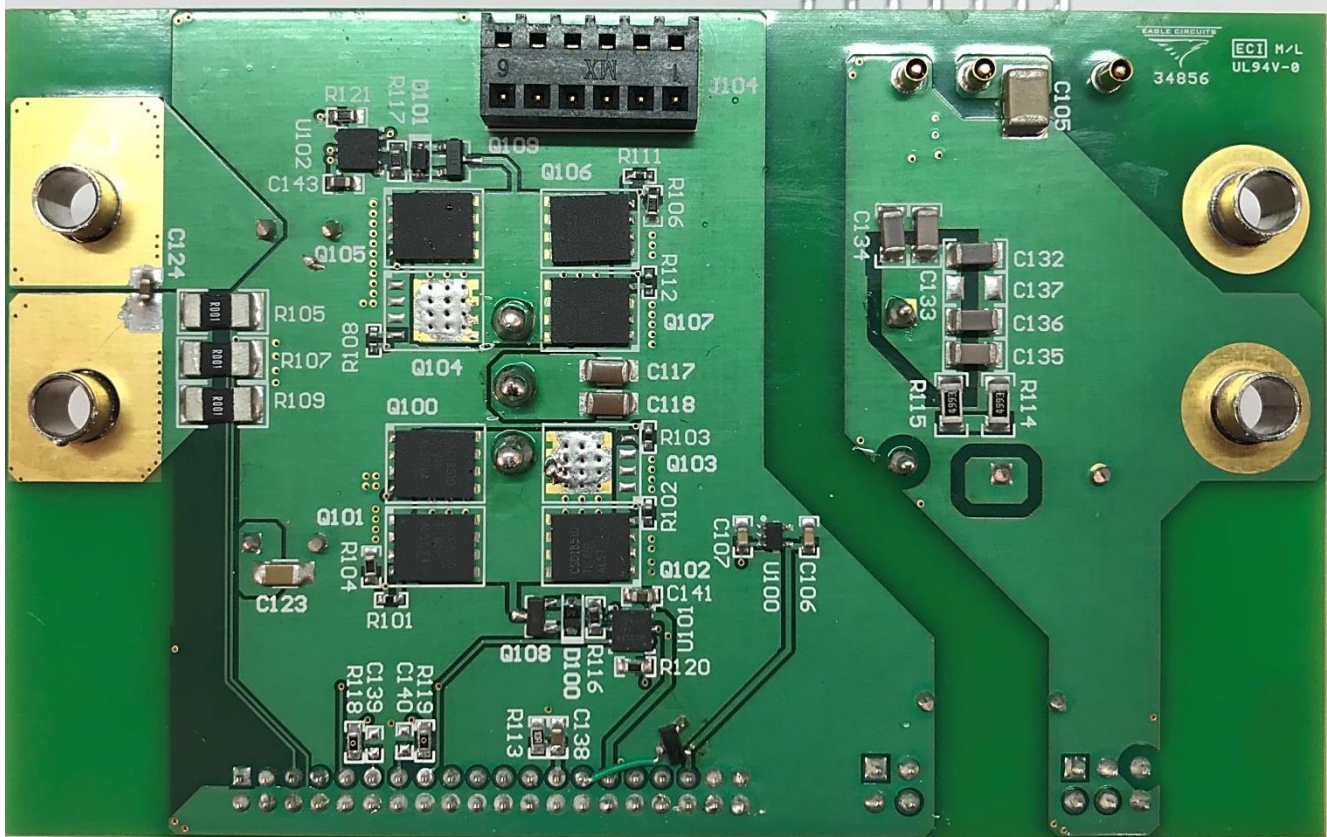



## 2.2 Efficiency Data

The efficiency curves are shown in the tables and graphs below with the set up shown in the figure below. A 12V fan (NMB Technologies Model # 3610VL-04W-B50) is applied to provide air cooling to the board from the output side.

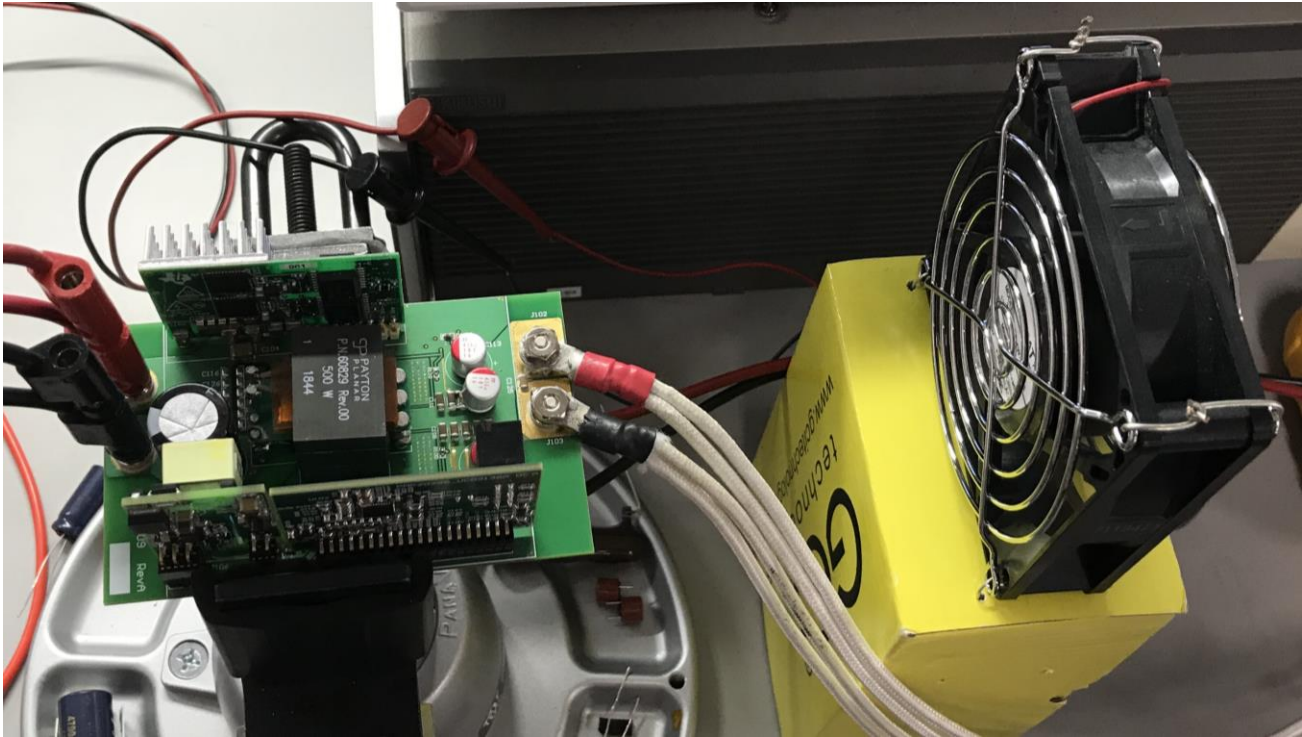

2.2.1 Efficiency Curves (bias supply – PMP20306 included)

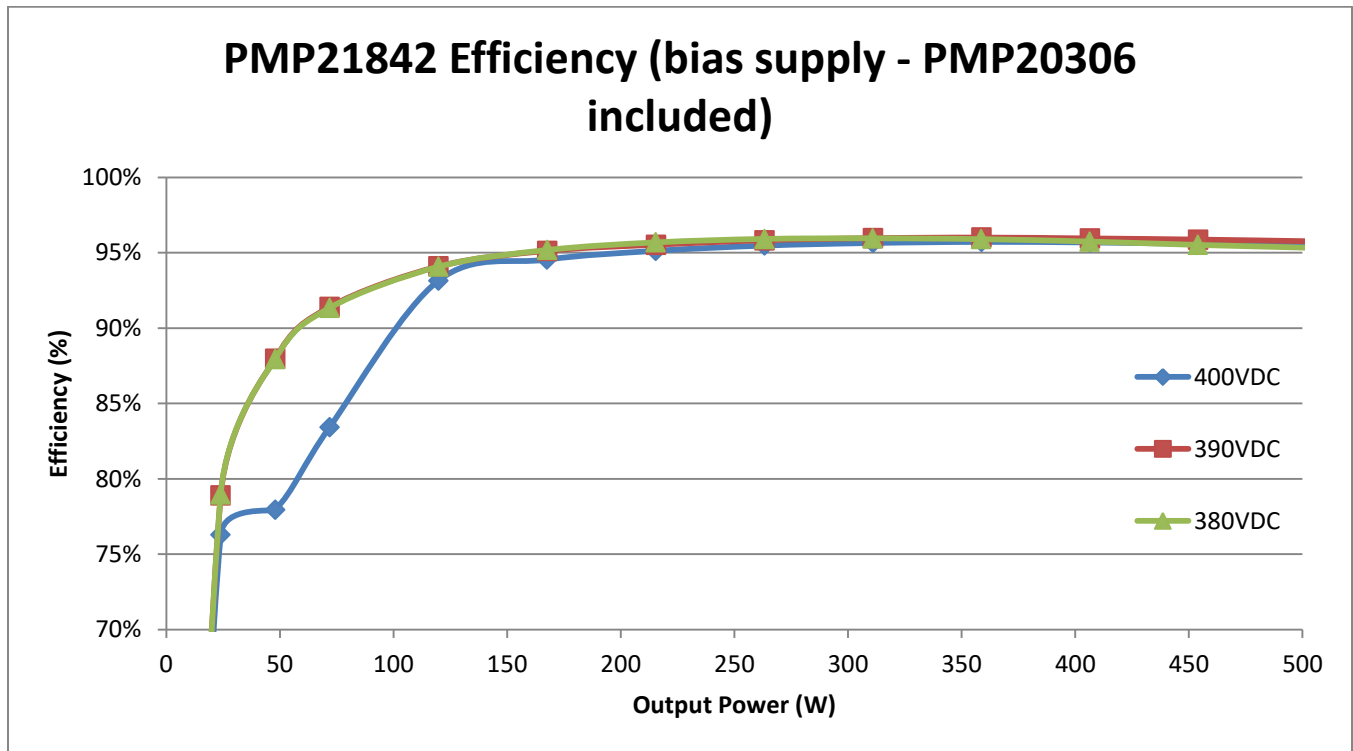

## 2.2.2 Efficiency Curves (bias supply – PMP20306 included)

Vin (V)	Iin (A)	Pin (W)	Vout (V)	Iout (A)	Pout (W)	Losses (W)	Eff (%)
399.96	1.3138	525.4674	11.947	42.0080	501.8699	23.5976	95.51%
399.97	1.1880	475.1644	11.951	38.0059	454.2085	20.9559	95.59%
399.97	1.0622	424.8481	11.955	34.0033	406.5092	18.3390	95.68%
399.98	0.9371	374.8213	11.959	30.0007	358.7778	16.0435	95.72%
399.99	0.8130	325.1919	11.963	26.0000	311.0384	14.1535	95.65%
399.99	0.6894	275.7531	11.967	22.0004	263.2789	12.4742	95.48%
400.00	0.5663	226.5200	11.972	17.9988	215.4815	11.0385	95.13%
400.01	0.4433	177.3244	11.975	14.0002	167.6520	9.6724	94.55%
400.01	0.3215	128.6032	11.979	10.0006	119.7966	8.8066	93.15%
400.02	0.2155	86.20431	11.983	6.0019	71.9212	14.2831	83.43%
400.02	0.1538	61.52308	11.985	4.0016	47.9594	13.5636	77.95%
400.03	0.0786	31.44236	11.987	2.0013	23.9897	7.4526	76.30%
400.03	0.0044	1.760132	11.989	0	0	1.7601	0.00%
389.98	1.3437	524.0161	11.945	42.0120	501.8337	22.1824	95.77%
389.98	1.2148	473.7477	11.949	38.0119	454.2043	19.5434	95.87%
389.99	1.0865	423.7241	11.954	34.0108	406.5650	17.1592	95.95%
389.99	0.9584	373.7664	11.958	30.0087	358.8436	14.9228	96.01%
389.99	0.8313	324.1987	11.963	26.0070	311.1222	13.0764	95.97%
390.00	0.7047	274.8330	11.968	22.0064	263.3728	11.4602	95.83%
390.01	0.5785	225.6208	11.972	18.0038	215.5414	10.0793	95.53%
390.02	0.4520	176.2890	11.975	14.0042	167.7000	8.5890	95.13%
390.02	0.3265	127.3415	11.979	10.0026	119.8206	7.5209	94.09%
390.02	0.2018	78.7060	11.983	6.0034	71.9392	6.7669	91.40%
390.03	0.1398	54.5262	11.985	4.0021	47.9655	6.5607	87.97%
390.03	0.0779	30.3833	11.987	1.9998	23.9717	6.4116	78.90%
390.03	0.0175	6.8255	11.989	0	0	6.8255	0.00%
379.97	1.3845	526.0685	11.940	42.0055	501.5459	24.5226	95.34%
379.98	1.2508	475.2790	11.945	38.0064	453.9865	21.2925	95.52%
379.98	1.1170	424.4377	11.950	34.0058	406.3691	18.0686	95.74%
379.99	0.9843	374.0242	11.955	30.0042	358.6997	15.3245	95.90%
380.00	0.8529	324.1020	11.960	26.0035	311.0023	13.0997	95.96%
380.01	0.7223	274.4812	11.965	22.0039	263.2769	11.2044	95.92%
380.01	0.5926	225.1939	11.970	18.0018	215.4815	9.7125	95.69%
380.02	0.4636	176.1773	11.975	14.0032	167.6880	8.4892	95.18%
380.03	0.3351	127.3481	11.979	10.0011	119.8026	7.5455	94.07%
380.03	0.2072	78.7422	11.983	6.0024	71.9272	6.8150	91.35%
380.03	0.1435	54.5343	11.985	4.0016	47.9594	6.5749	87.94%
380.04	0.0799	30.3652	11.987	2.0003	23.9777	6.3875	78.96%
380.04	0.0171	6.4987	11.989	0	0	6.4987	0.00%

### 2.3 Thermal Images

The thermal images below show a top view and bottom view of the board. The board is placed vertically during the test, where the input and output connectors are at the bottom side. The ambient temperature was 25°C with forced air flow (The same set up as efficiency measurement). The output was loaded with 12V/42A.

#### 2.3.1 390V<sub>DC</sub> Input, Top View

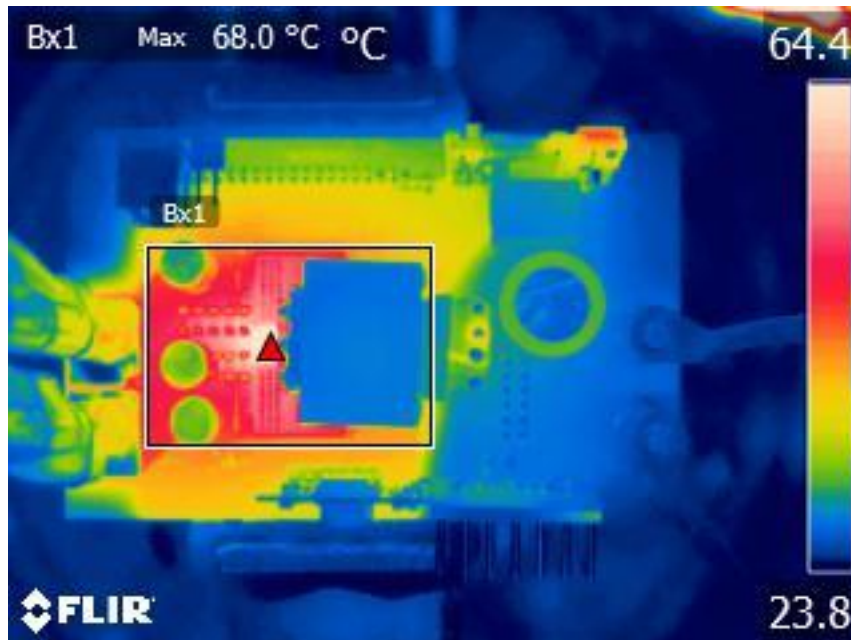

#### 2.3.2 390V<sub>DC</sub> Input, Bottom View

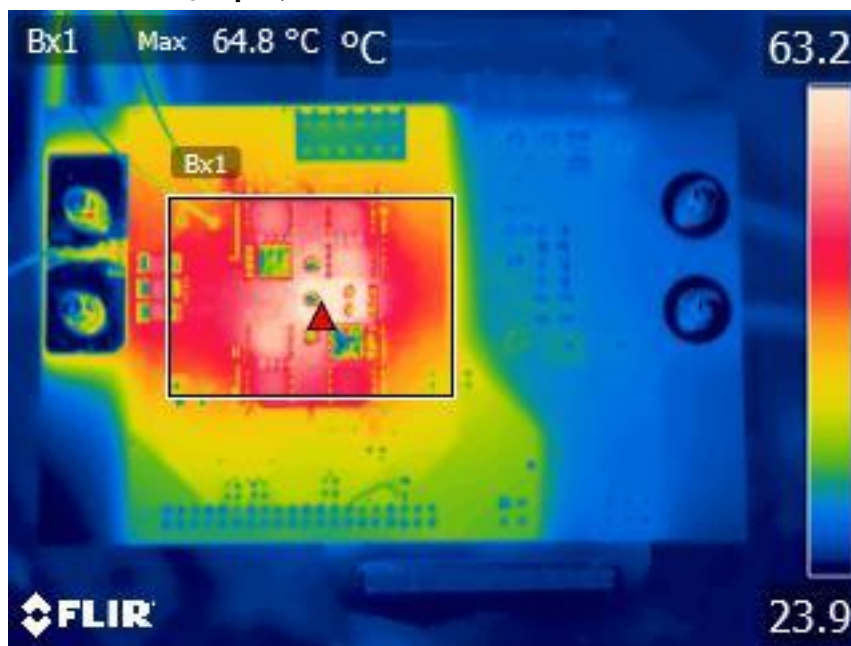



### 2.3.3 390V<sub>DC</sub> Input, Side View

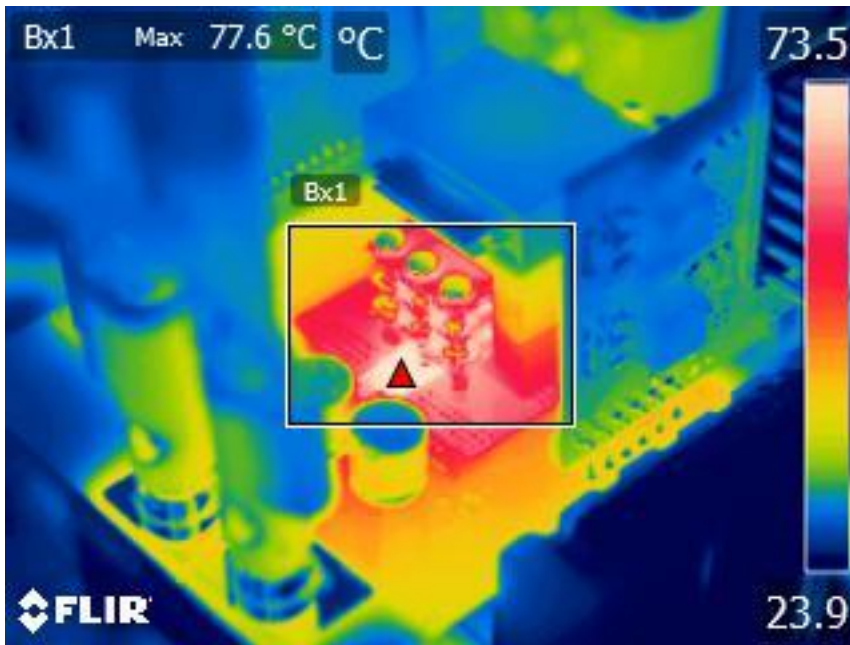

## 2.4 Start Up Waveforms

The voltages at startup are shown in the images below with 390VDC input where C1 is input voltage, C2 is output voltage, and C4 is output current.

### 2.4.1 No Load



### 2.4.2 12V/42A

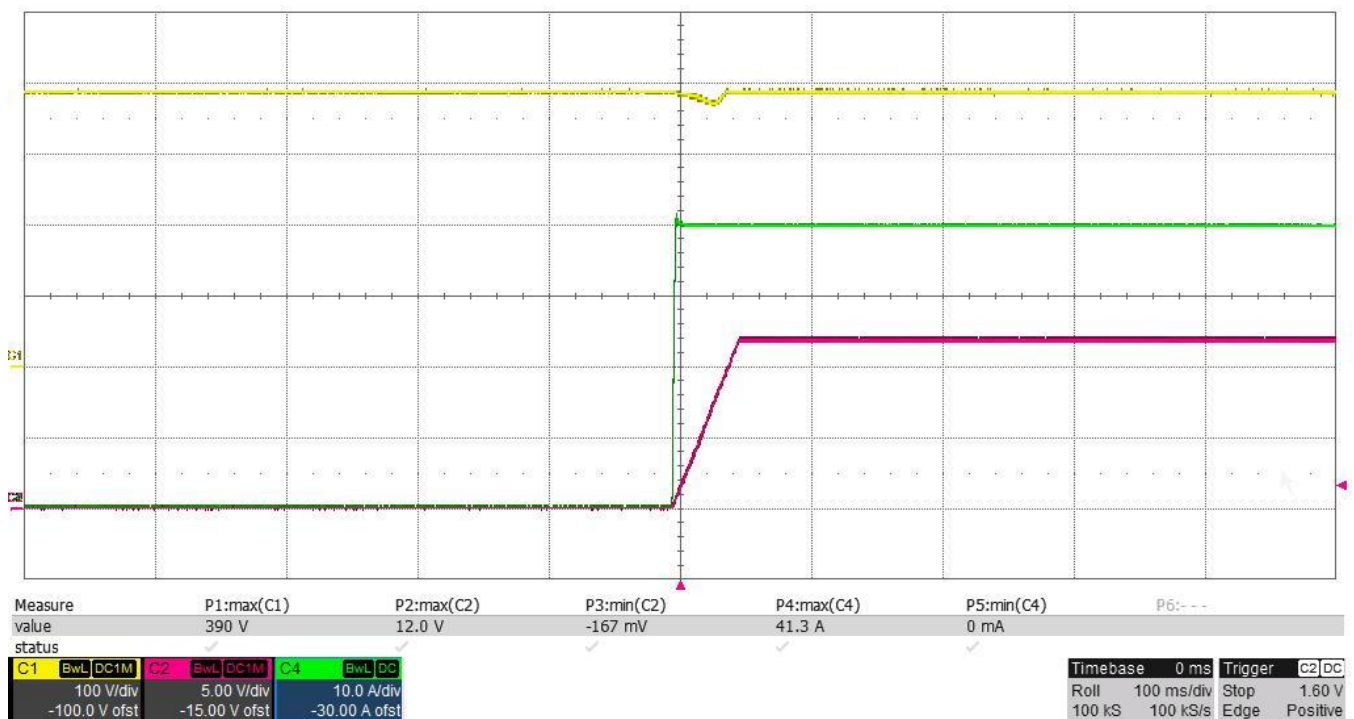

## 2.5 Turn Off

The voltage at turn off transient at 42A load is shown in the images below with 390VDC input where C1 is input voltage, C2 is output voltage, and C4 is output current.

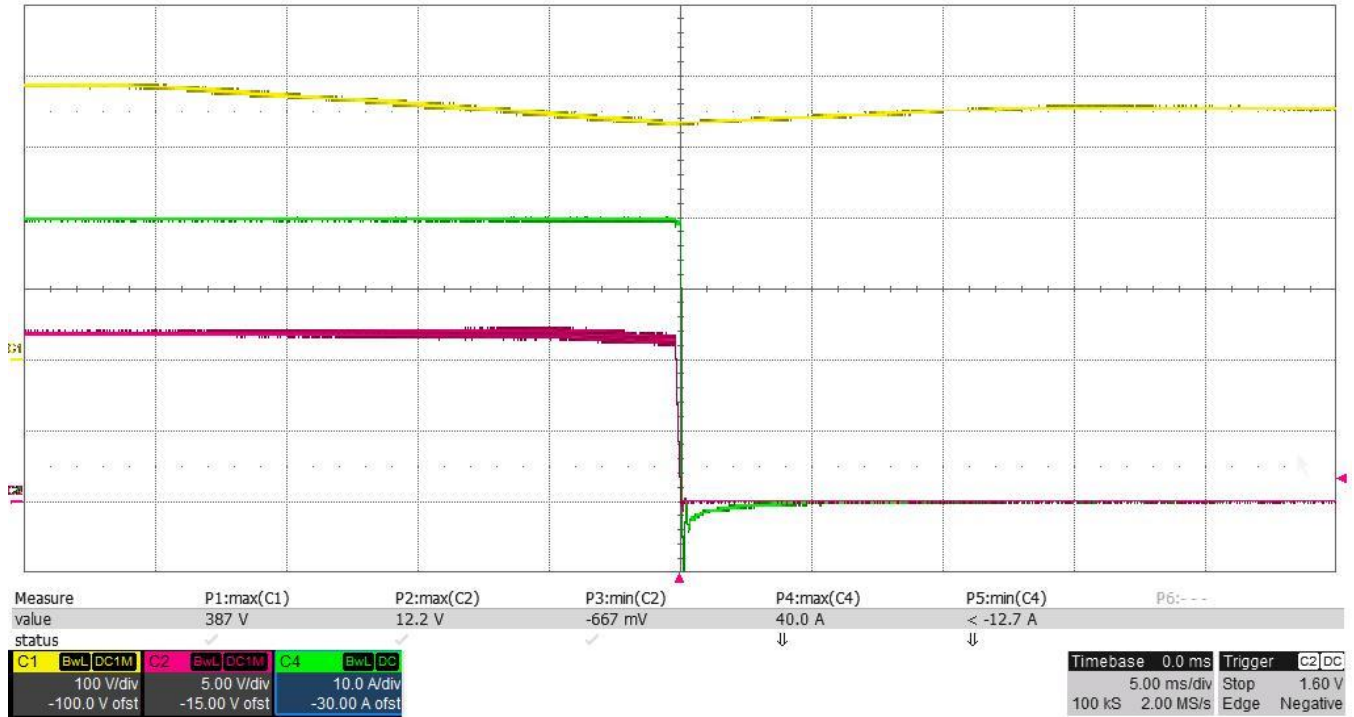

## 2.6 Output Ripple Voltages

Ripple voltages are shown in the images below, where C1 is the input voltage and C2 is output voltage in AC level.

### 2.6.1 380V<sub>DC</sub> Input, No Load

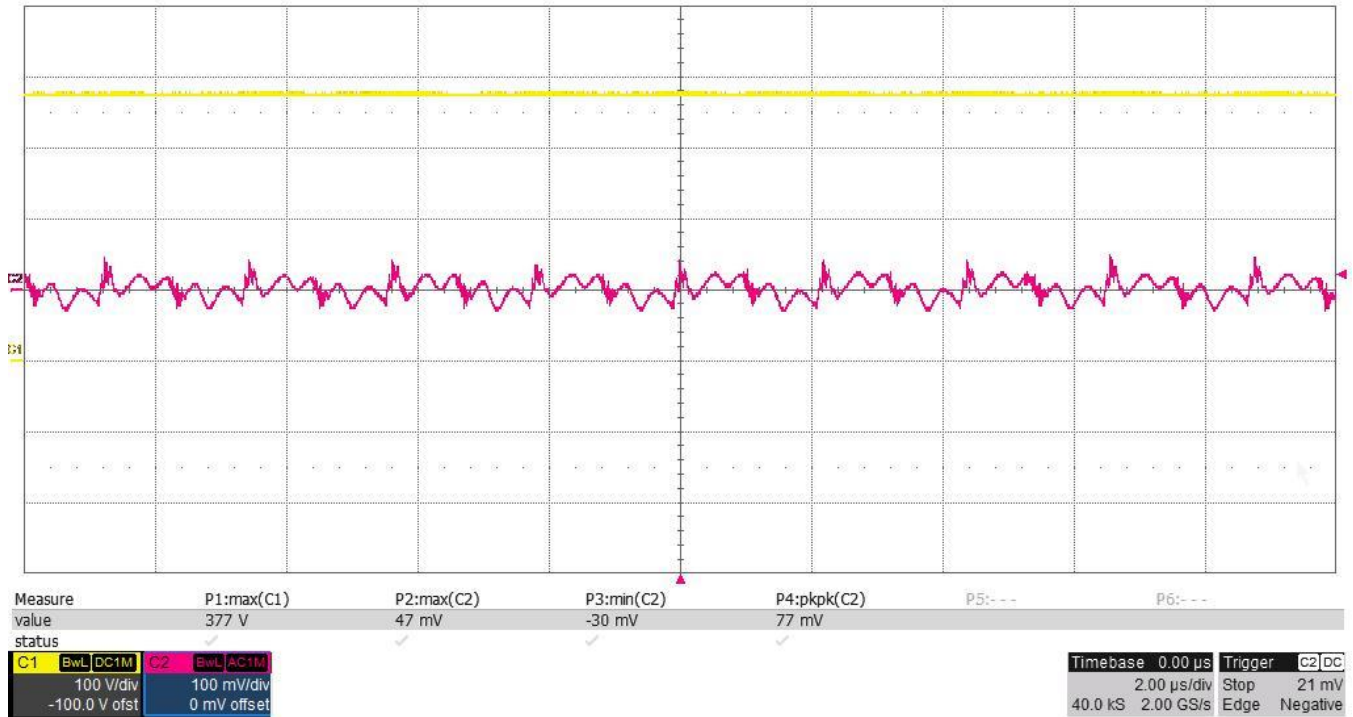

### 2.6.2 380V<sub>DC</sub> Input, 42A Load

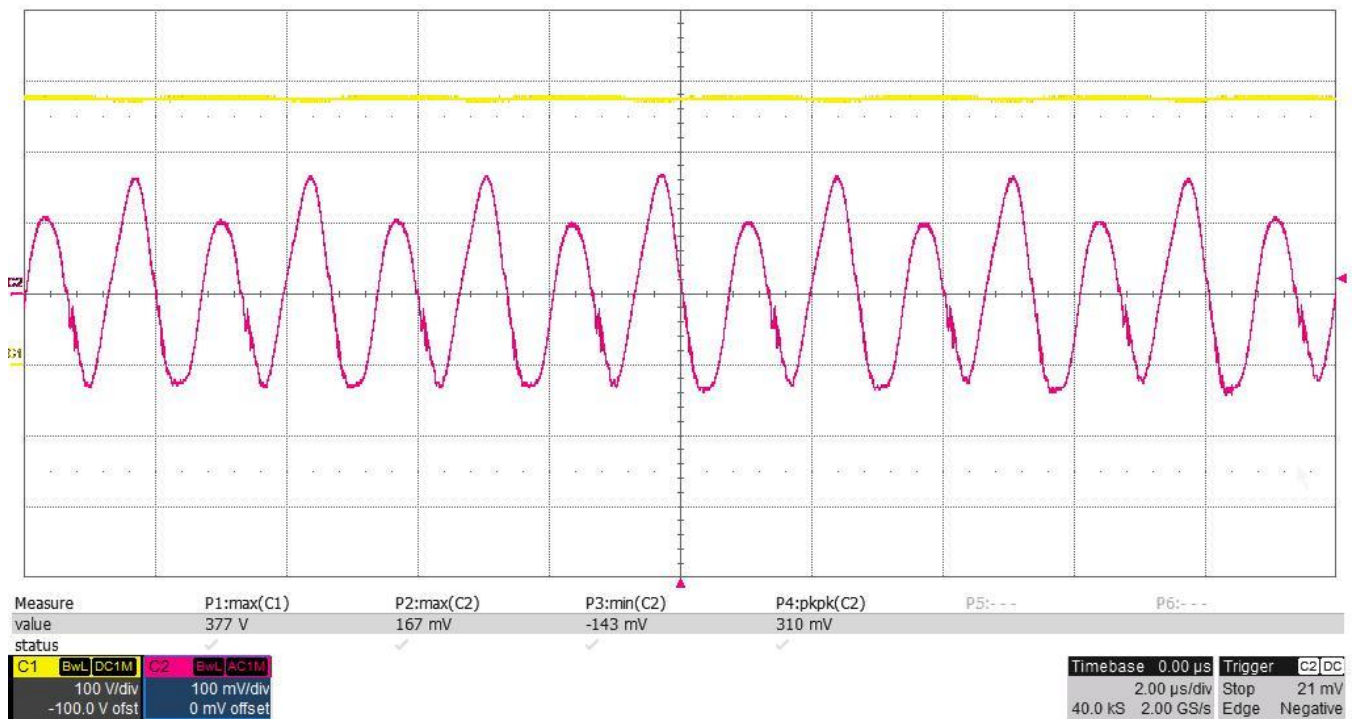



### 2.6.3 390V<sub>DC</sub> Input, No Load

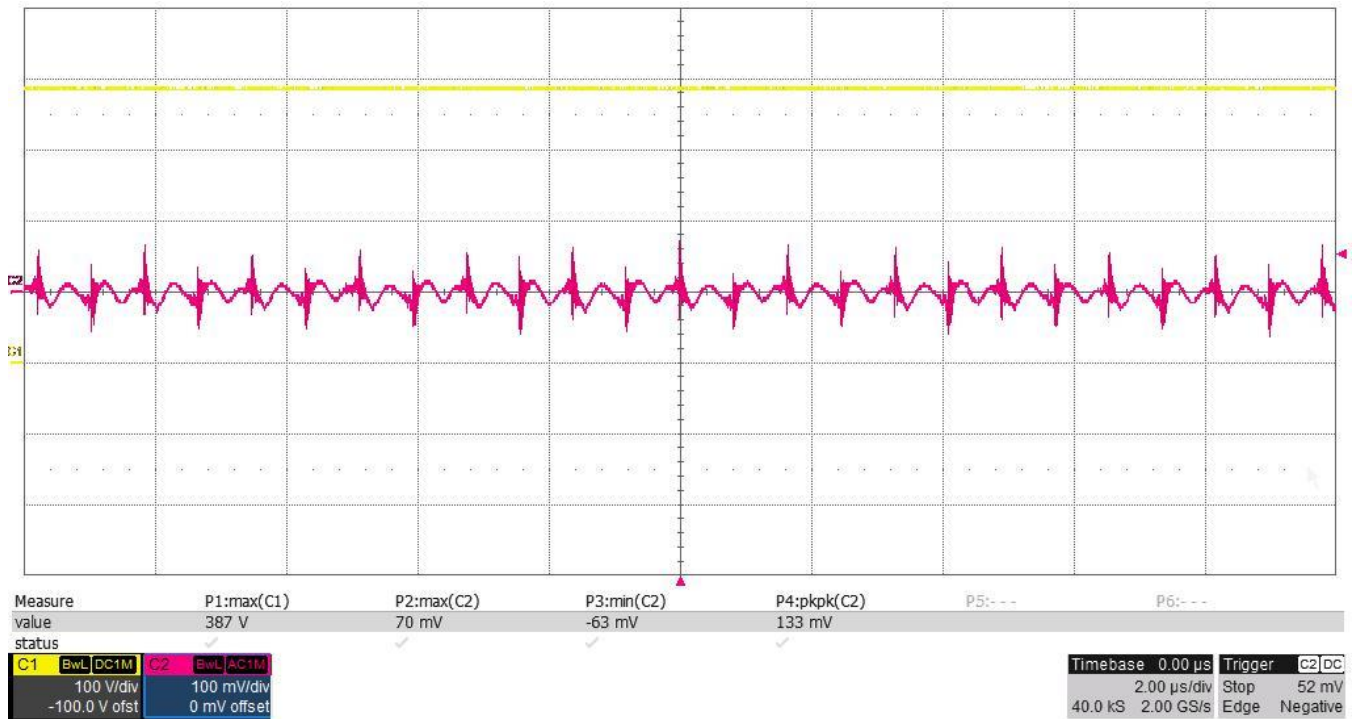

### 2.6.4 390V<sub>DC</sub> Input, 42A Load

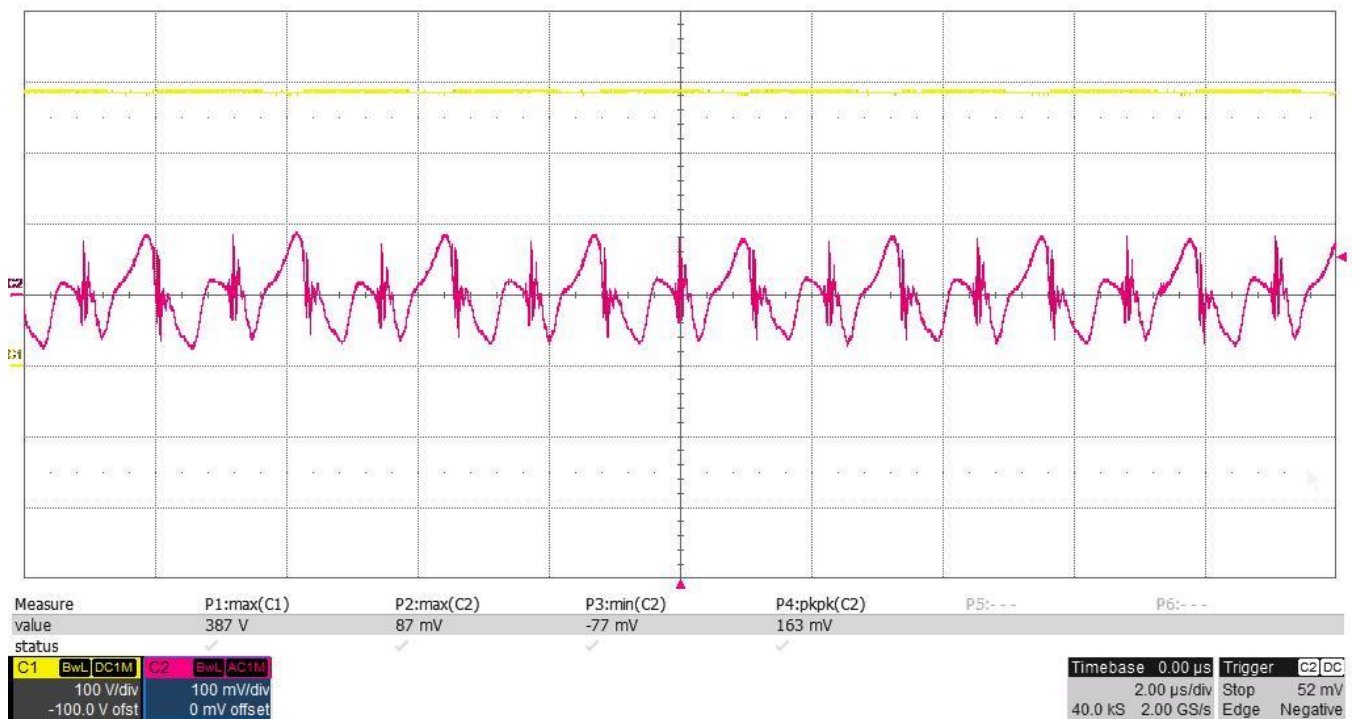

### 2.6.5 400V<sub>DC</sub> Input, No Load

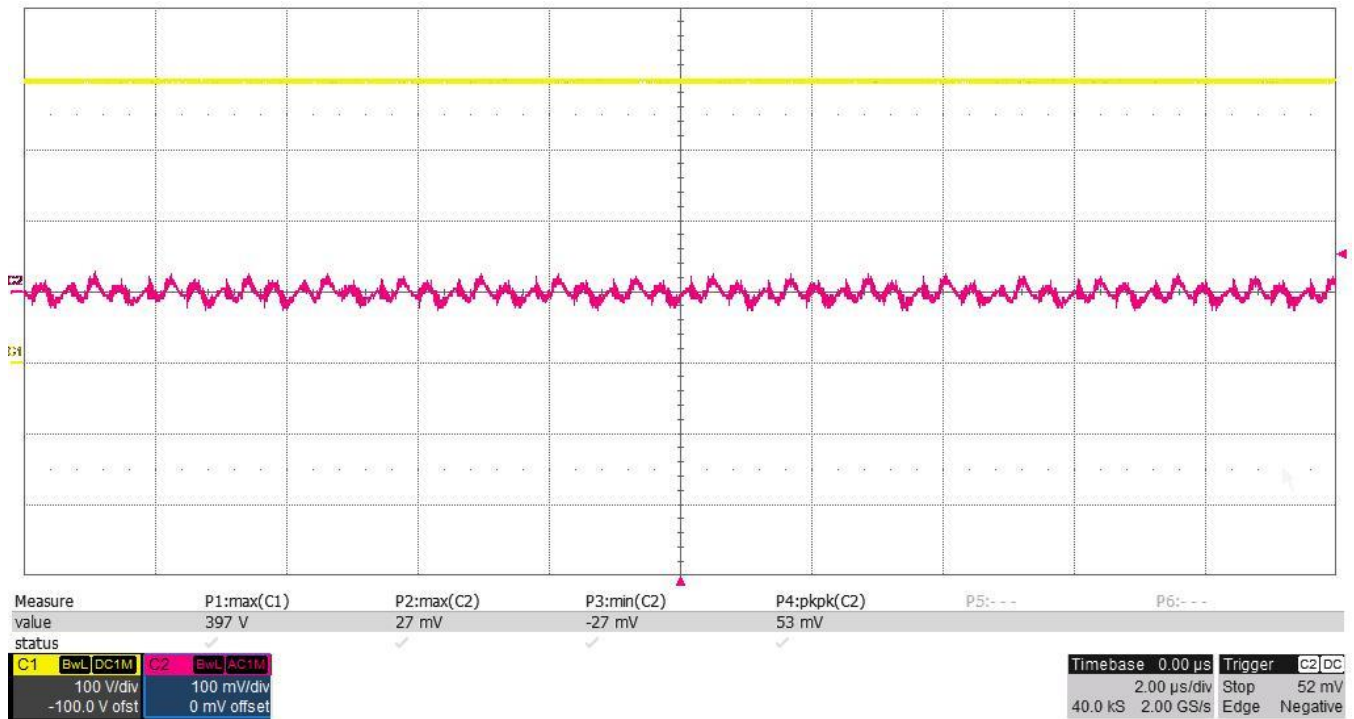

### 2.6.6 400V<sub>DC</sub> Input, 42A Load

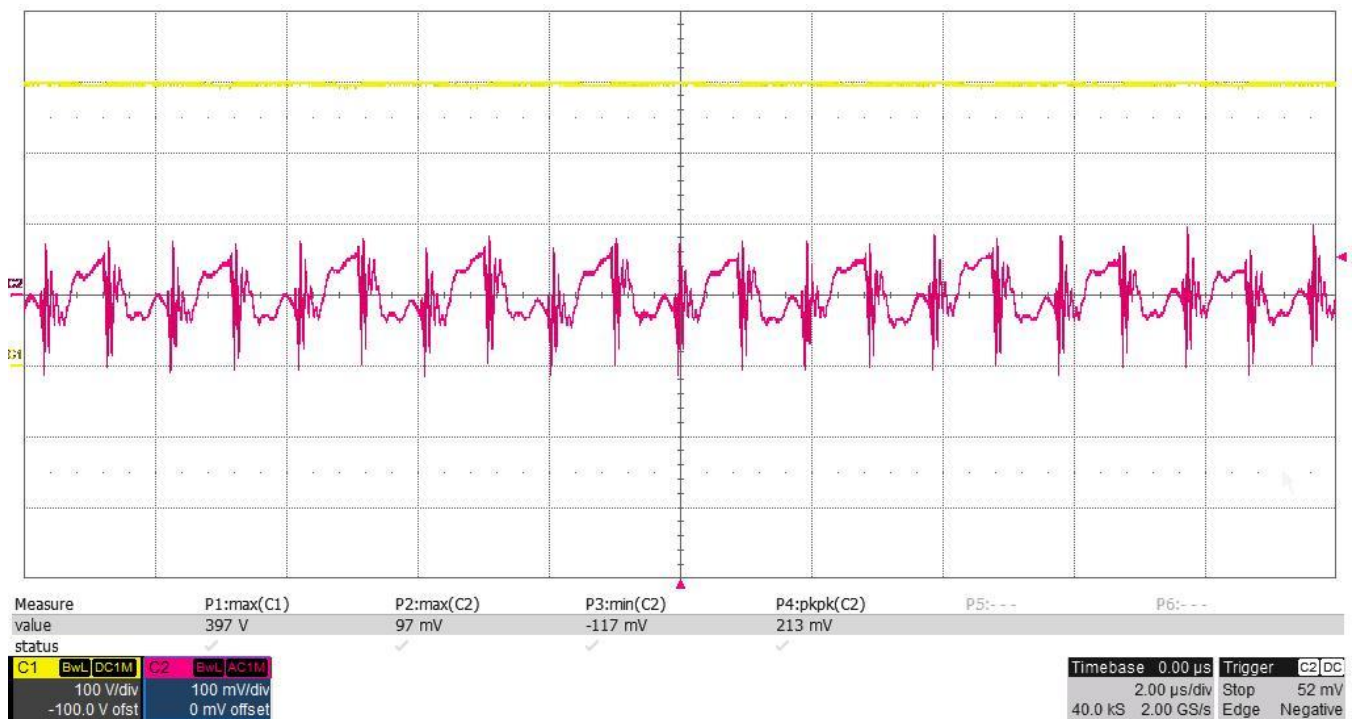

## 2.7 Load Response

Load response is tested at 390V input with 20A to 42A load transient, where C1 is the input voltage, C2 is output voltage in AC level and C4 is output current.

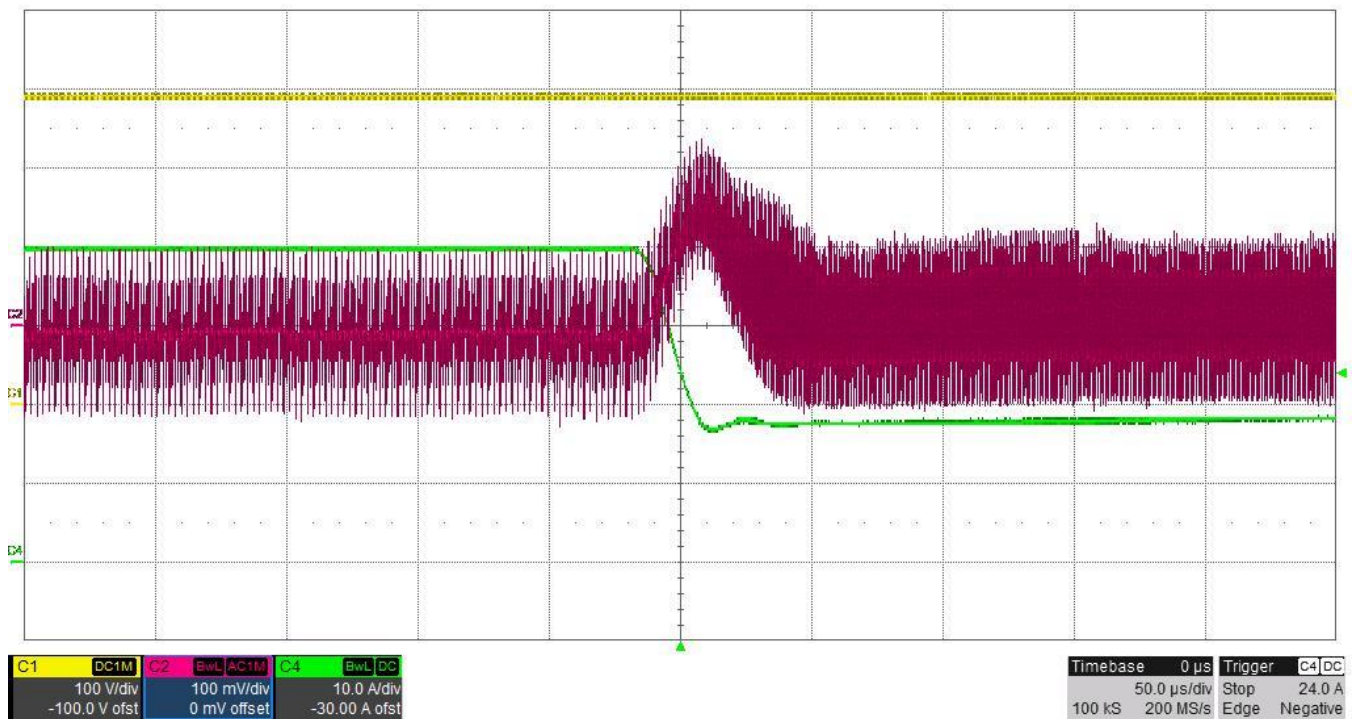
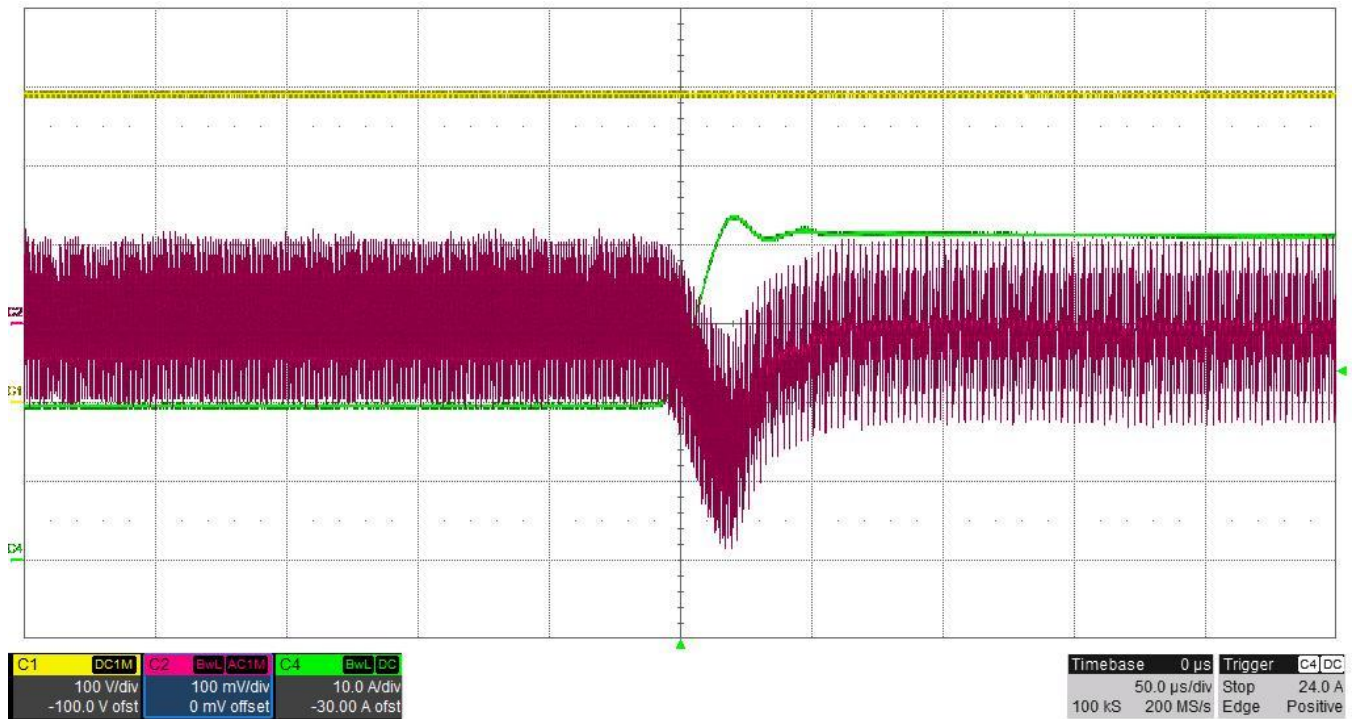

## 2.8 Synchronous Rectifier Conduction

### 2.8.1 Q103 $V_{DS}$ @ 380V<sub>IN</sub> and 12V/42A

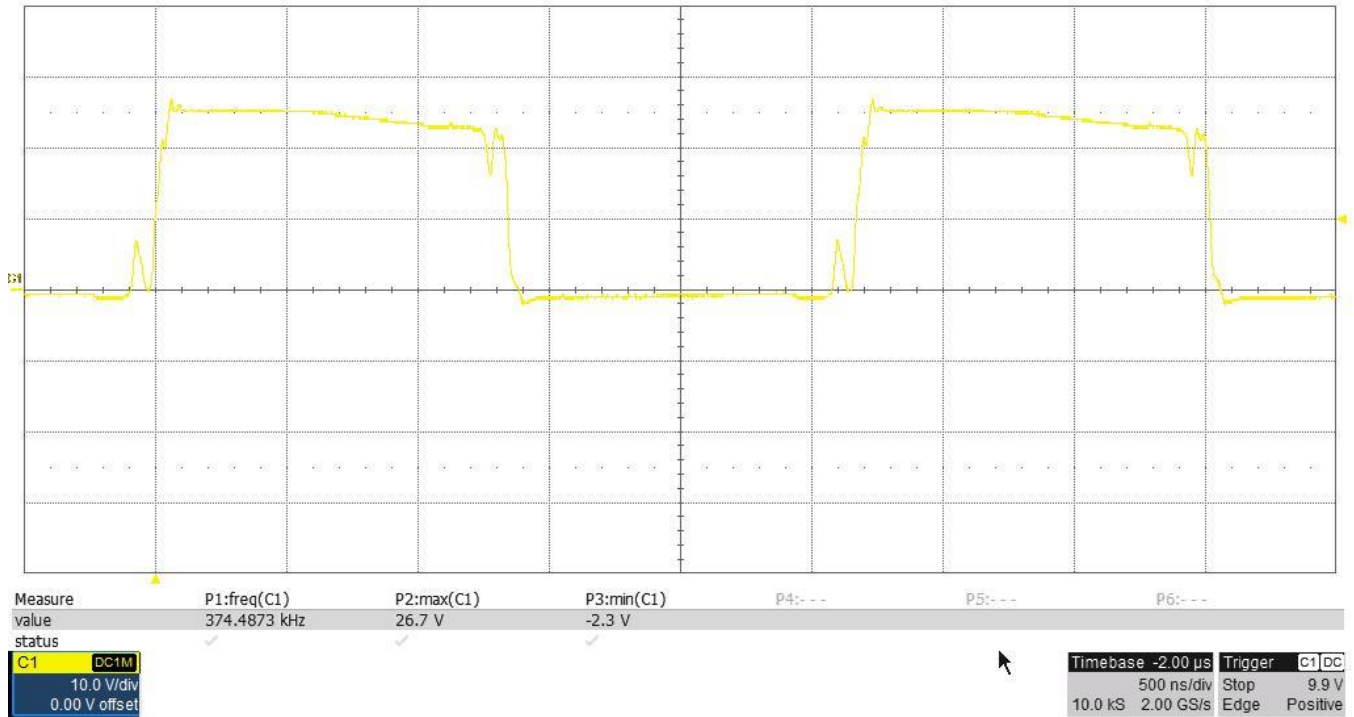

### 2.8.2 Q103 $V_{DS}$ @ 390V<sub>IN</sub> and 12V/42A

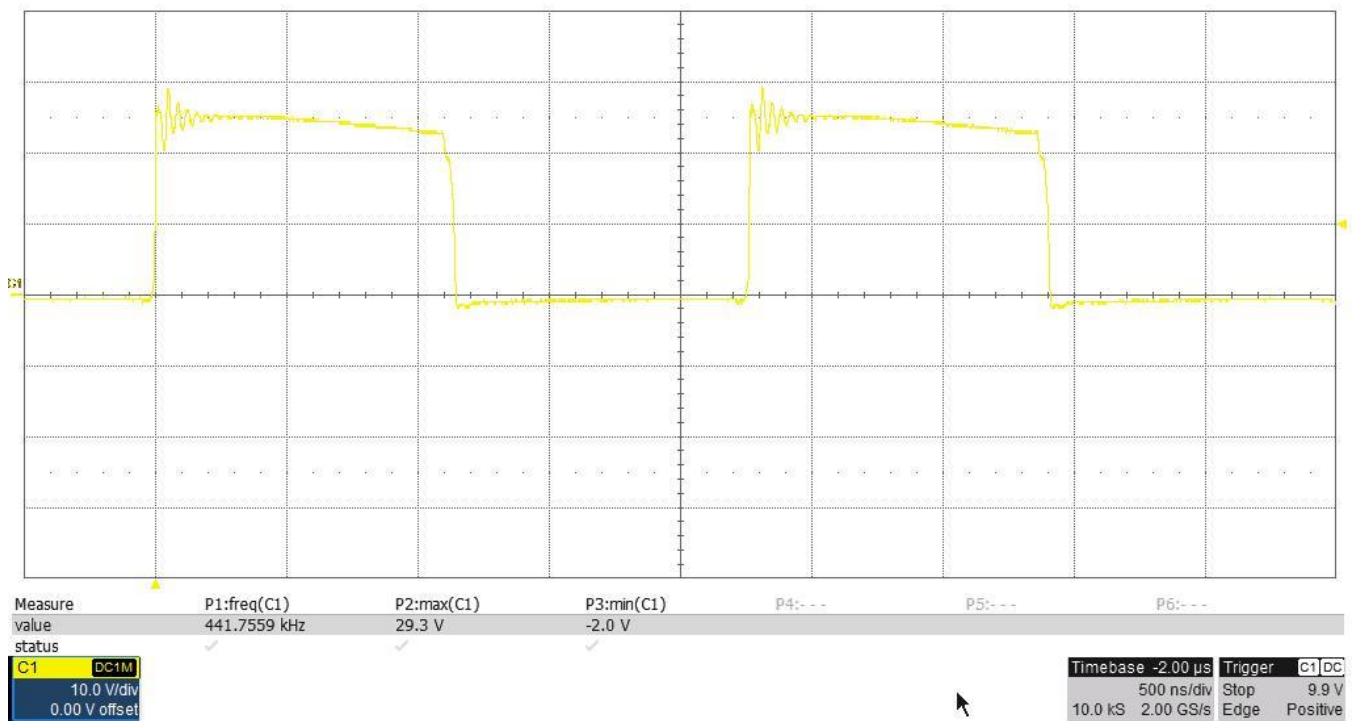



### 2.8.3 Q103 V<sub>DS</sub> @ 400V<sub>IN</sub> and 12V/42A

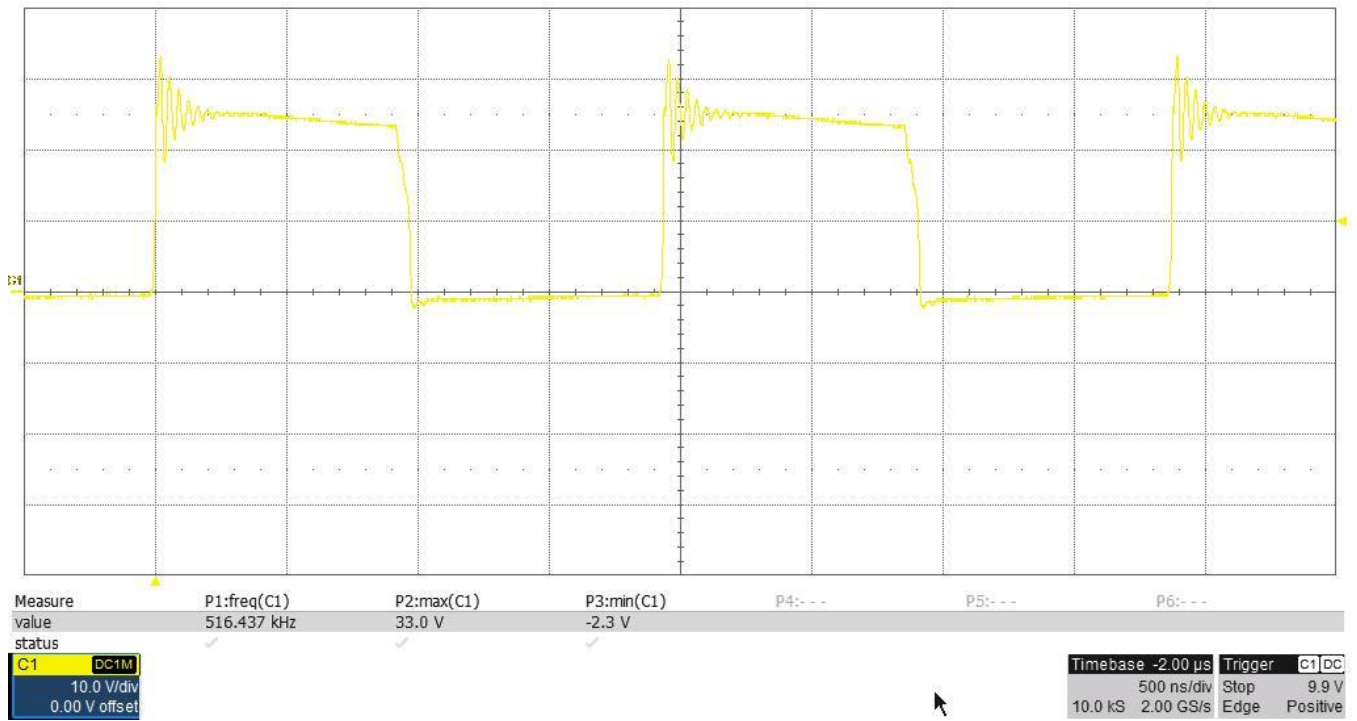

## IMPORTANT NOTICE AND DISCLAIMER

TI PROVIDES TECHNICAL AND RELIABILITY DATA (INCLUDING DATASHEETS), DESIGN RESOURCES (INCLUDING REFERENCE DESIGNS), APPLICATION OR OTHER DESIGN ADVICE, WEB TOOLS, SAFETY INFORMATION, AND OTHER RESOURCES "AS IS" AND WITH ALL FAULTS, AND DISCLAIMS ALL WARRANTIES, EXPRESS AND IMPLIED, INCLUDING WITHOUT LIMITATION ANY IMPLIED WARRANTIES OF MERCHANTABILITY, FITNESS FOR A PARTICULAR PURPOSE OR NON-INFRINGEMENT OF THIRD PARTY INTELLECTUAL PROPERTY RIGHTS.

These resources are intended for skilled developers designing with TI products. You are solely responsible for (1) selecting the appropriate TI products for your application, (2) designing, validating and testing your application, and (3) ensuring your application meets applicable standards, and any other safety, security, or other requirements. These resources are subject to change without notice. TI grants you permission to use these resources only for development of an application that uses the TI products described in the resource. Other reproduction and display of these resources is prohibited. No license is granted to any other TI intellectual property right or to any third party intellectual property right. TI disclaims responsibility for, and you will fully indemnify TI and its representatives against, any claims, damages, costs, losses, and liabilities arising out of your use of these resources.

TI's products are provided subject to TI's Terms of Sale (<https://www.ti.com/legal/termsofsale.html>) or other applicable terms available either on [ti.com](https://www.ti.com) or provided in conjunction with such TI products. TI's provision of these resources does not expand or otherwise alter TI's applicable warranties or warranty disclaimers for TI products.

Mailing Address: Texas Instruments, Post Office Box 655303, Dallas, Texas 75265  
Copyright © 2021, Texas Instruments Incorporated