

Test Report: PMP41081

1-kW, 12-V, HHC LLC Reference Design Using C2000™ Real-Time MCU



Description

This reference design is a 1-kW, 400-V to 12-V half-bridge resonant DC-DC platform, used to evaluate the load transient performance of hybrid-hysteretic control (HHC) with an F280039C controller. HHC is a method which combines direct frequency control (DFC) and charge control, and is charge control with an added frequency compensation ramp. With an additional inner loop, HHC can highly improve the load transient response performance of the inductor-inductor-capacitor (LLC) stage.

Additionally, this platform includes an interface for the LMG3422 half-bridge EVM on the primary side, so the power board can be configured to evaluate GaN performance in the LLC stage by some modifications of cutting off the MOSFET bridge.

Features

- HHC controlled half-bridge LLC platform using F280039C
- Converting 400 V to 12 V with 1-kW ability
- Better load transient response than the Common Redundant Power Supply (CRPS) standard
- Monotonic soft-start with any load conditions
- Small output voltage ripple

Applications

- [Server PSU with 12-V output](#)
- [Merchant telecom rectifiers](#)
- [Industrial AC-DC](#)

Resources

PMP41081	Design Folder
TMS320F280039C	Product Folder
UCC28740	Product Folder
TPSM863252	Product Folder



[Ask our TI E2E™ support experts](#)



Top of Board

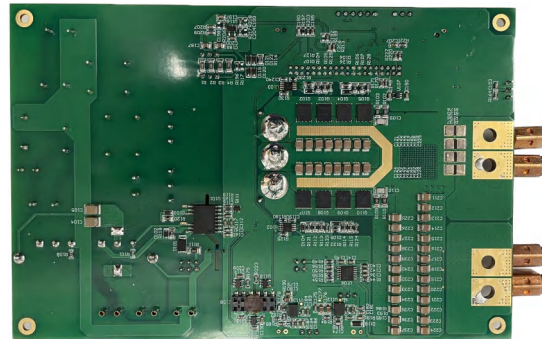

Bottom of Board

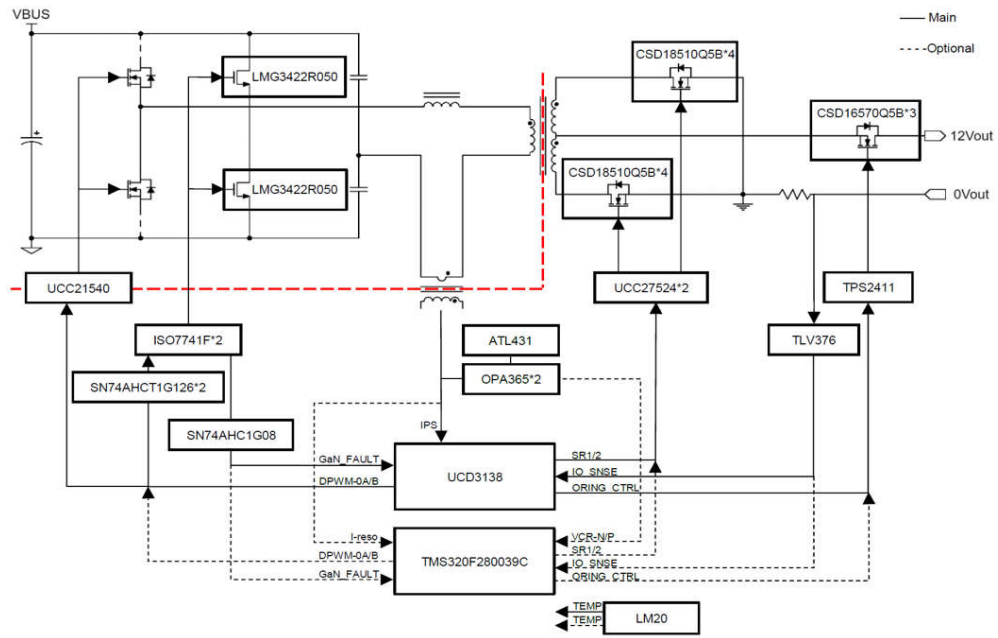

Block Diagram

1 Test Prerequisites

1.1 Voltage and Current Requirements

Table 1-1. Voltage and Current Requirements

Parameter	Specifications
Input voltage	340 V to 420 V
Output voltage	12 V
Output current	0 A to 84 A
Resonant frequency	100 kHz
Loading transient response	±5%
Ripple and noise	120 mVpp

1.2 Required Equipment

- Software: Code Composer Studio™ and DigitalPower SDK
- C2000 daughter card: TMDSCNCD280039C
- DC source: Chroma 62150H-1000S
- Electronic load: Chroma 63203A-600-210
- Oscilloscope: Tektronix MDO3024
- Frequency response analyzer: Bode 100

1.3 Considerations

WARNING

Do not touch the board or the electrical circuits while the board is energized because of high voltages capable of causing an electrical shock hazard. Make sure the high voltage is fully discharged before handling the board.

1.4 Dimensions

Length × Width × Height: 175 mm × 116 mm × 42 mm.

1.5 Test Setup

The following steps are used for the test setup:

1. Flash the PMP41081 code into the F280039C control card, and switch all S2 to position '1'
2. Insert the F280039C control card and the auxiliary power board into the base board
3. Connect the input DC source and output electronic load
4. Consider using an extra cooling fan to minimize the temperature of the power board
5. Switch the 'S101' to the 'ON' side, on the base board
6. Power on the DC source with 400 V, the 12-V output automatically starts up within 20 s

Figure 1-1 illustrates the test setup.

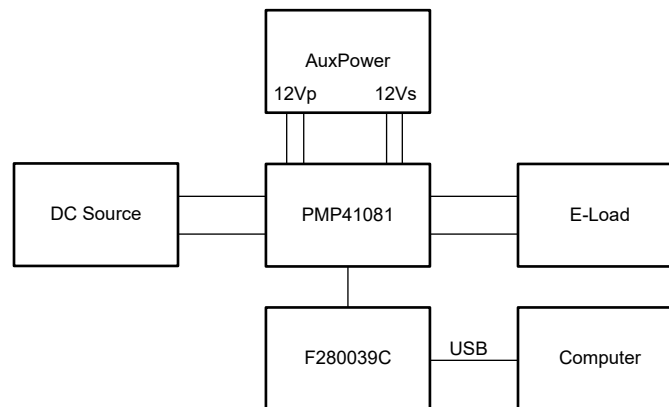

Figure 1-1. Test Setup

2 Testing and Results

2.1 Bode Plots

The bode plots are shown in the following figures.

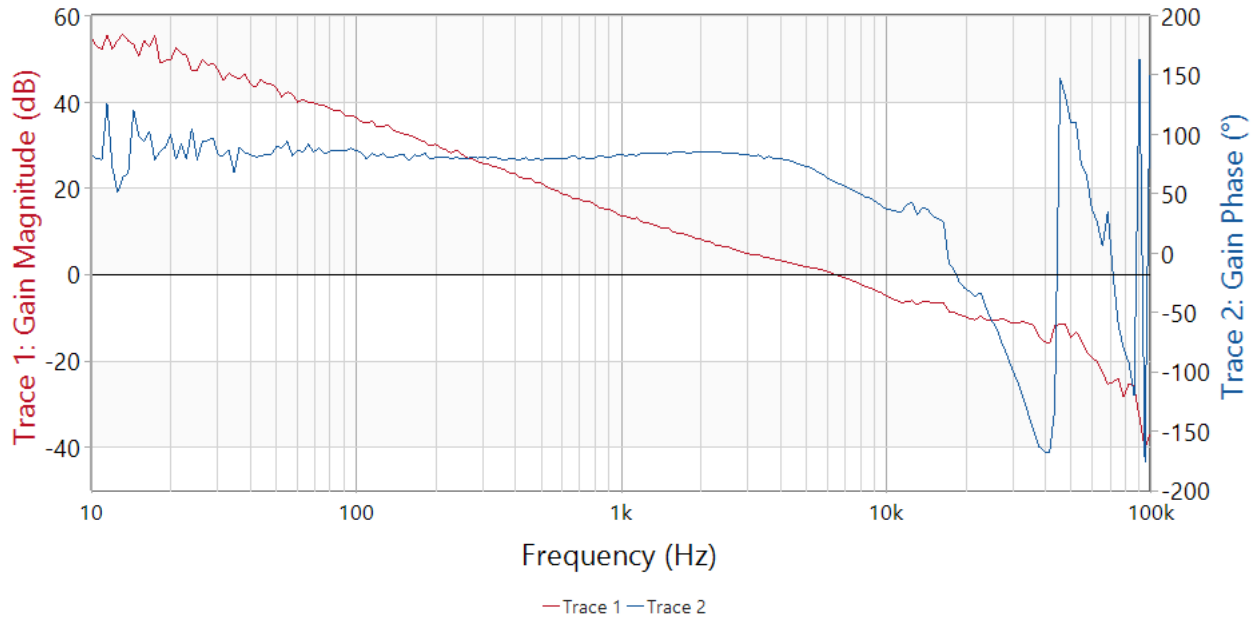

Figure 2-1. Bode Plot, 400 V_{IN}, 4-A Load

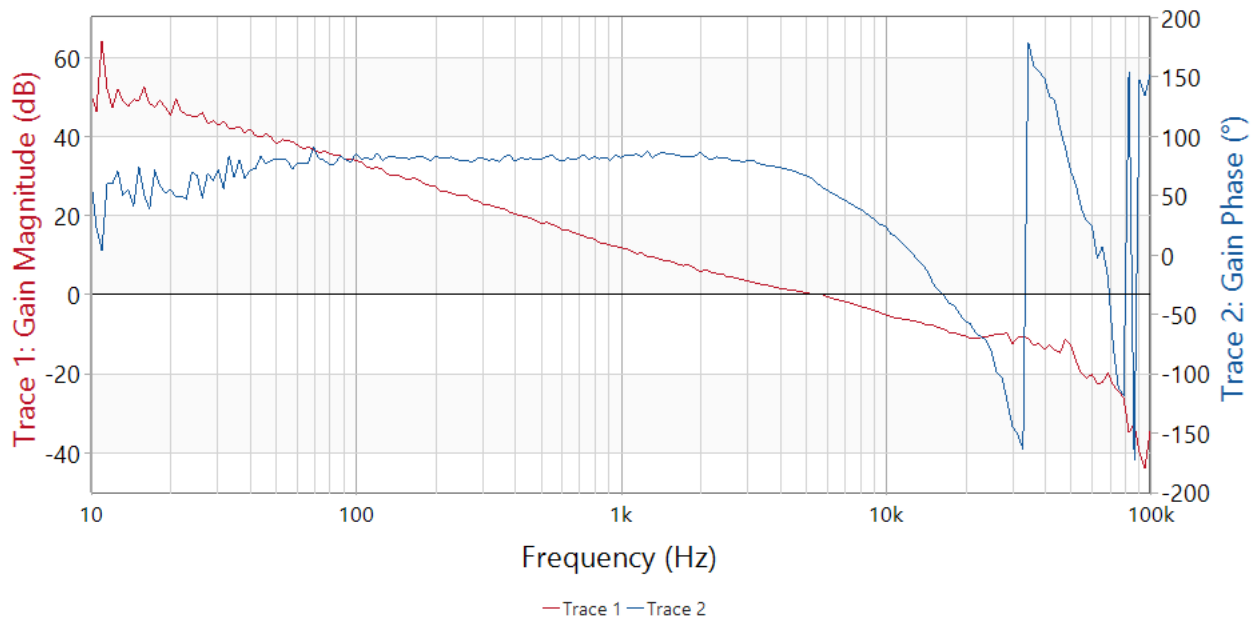

Figure 2-2. Bode Plot, 400 V_{IN}, 42-A Load

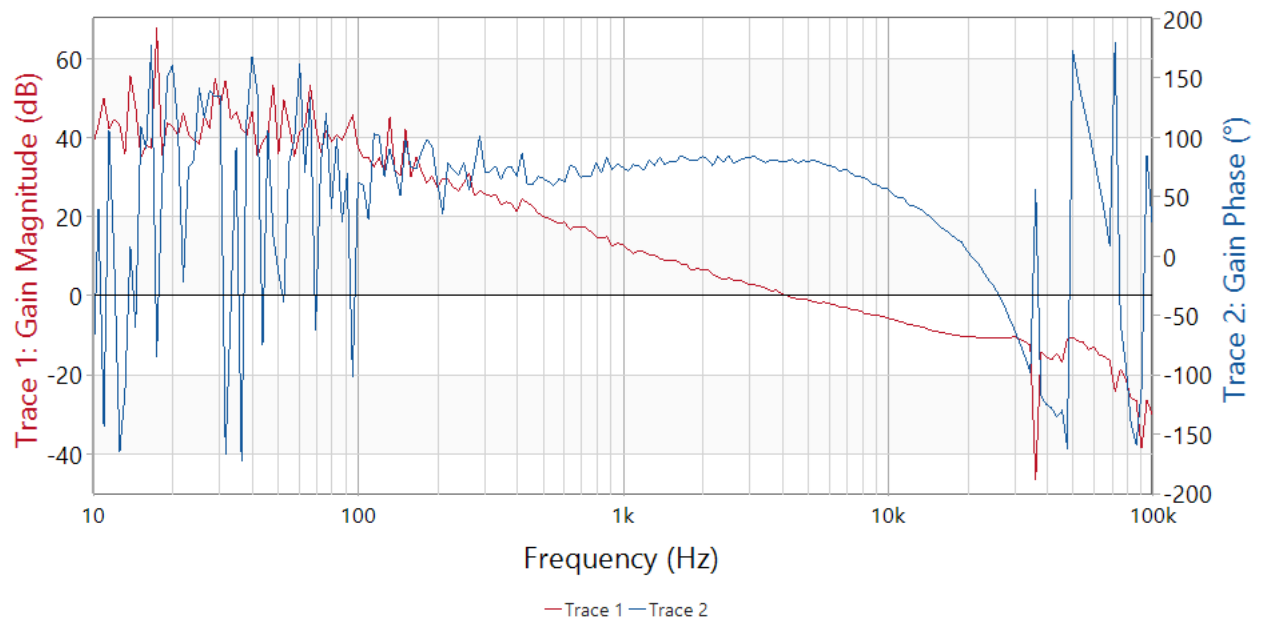

Figure 2-3. Bode Plot, 400 V_{IN}, 84-A Load

2.2 Thermal Images

Figure 2-4 shows the thermal image of 400-VDC input with 84-A load.

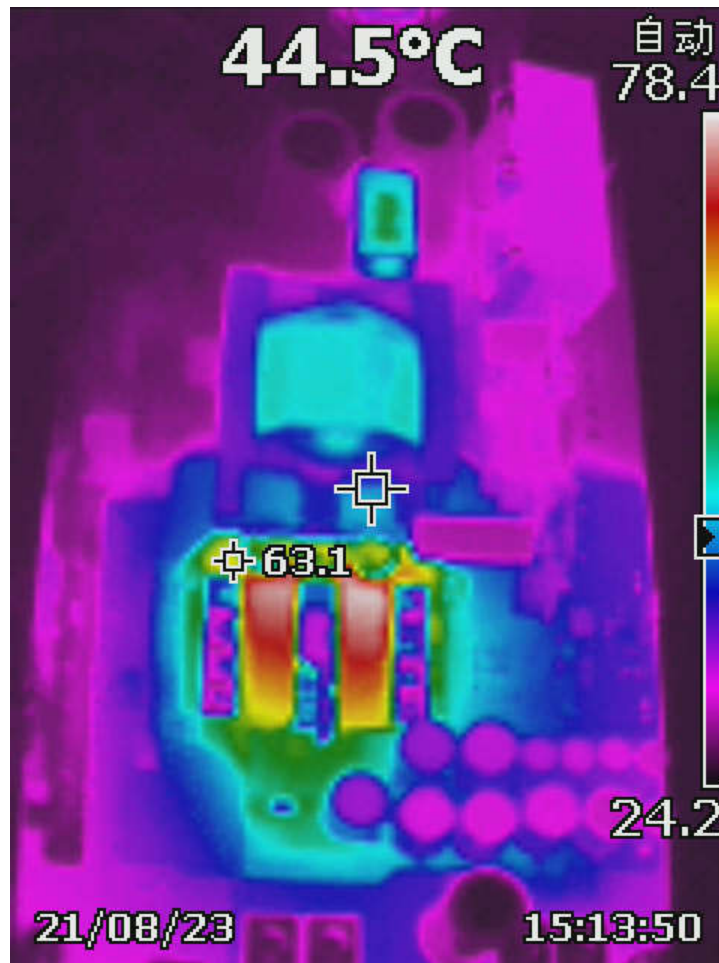

Figure 2-4. Thermal Image: 400-VDC Input With 84-A Load

3 Waveforms

3.1 Load Transient Response

This design follows the M-CRPS standard and has tested 5% to 105%, and 20% to 80% load transient response. The test waveforms are shown in the following figures.

In **Figure 3-1** and **Figure 3-2**, channel 1 in dark blue is V_{sw} of the primary leg; channel 2 in light blue is the PWM of the primary high side; channel 3 in purple is the output voltage AC portion; channel 4 in green is the primary current.

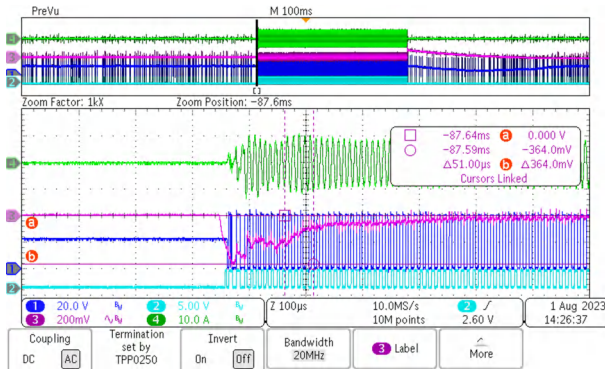

Figure 3-1. Load Transient: 380 V_{IN}, Load Step: 0 A to 84 A, 2.5 A/µs

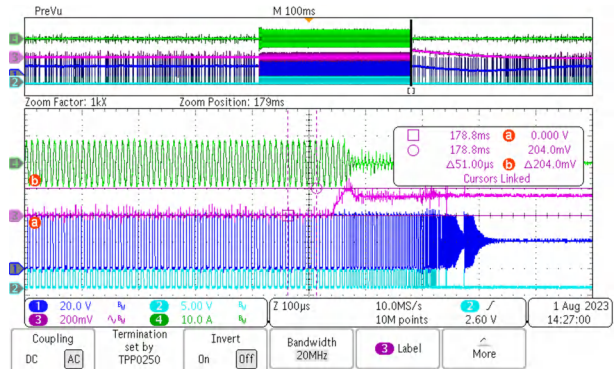

Figure 3-2. Load Transient: 380 V_{IN}, Load Step: 84 A to 0 A, 2.5 A/µs

In the following waveforms, channel 1 in dark blue is load current; channel 3 in purple is the AC portion of output voltage; channel 4 in green is primary current.

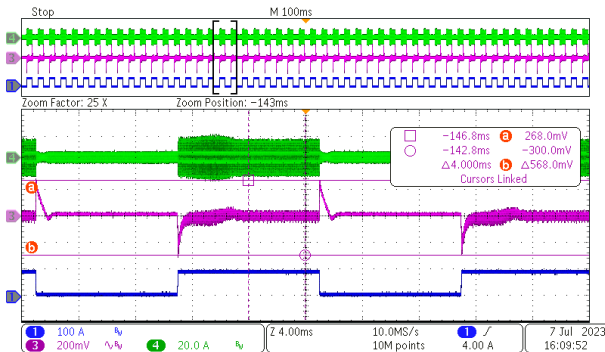

Figure 3-3. Load Transient: 380 V_{IN}, Load Step: 4 A 10 ms and 88 A 10 ms, 2.5 A/µs

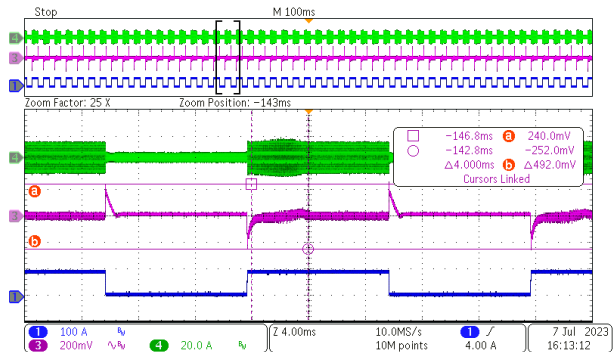

Figure 3-4. Load Transient: 400 V_{IN}, Load Step: 4 A 10 ms and 88 A 10 ms, 2.5 A/µs

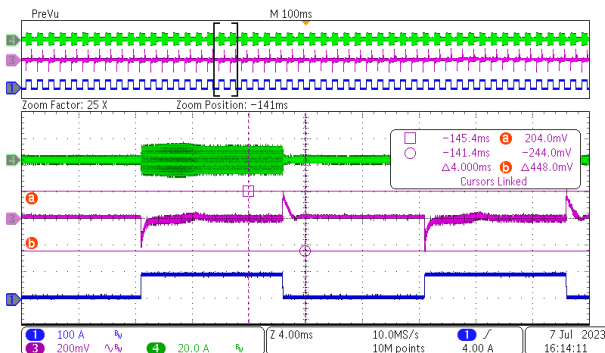

Figure 3-5. Load Transient: 410 V_{IN}, Load Step: 4 A 10 ms and 88 A 10 ms, 2.5 A/µs

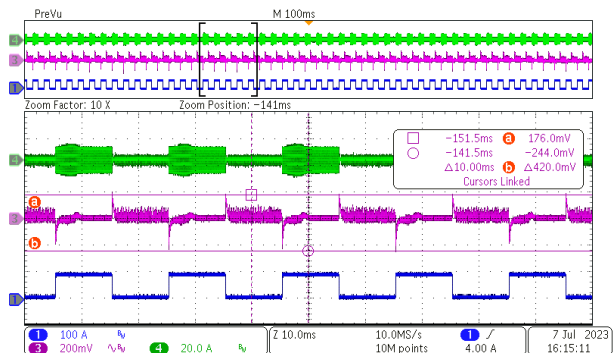

Figure 3-6. Load Transient: 420 V_{IN}, Load Step: 4 A 10 ms and 88 A 10 ms, 2.5 A/µs

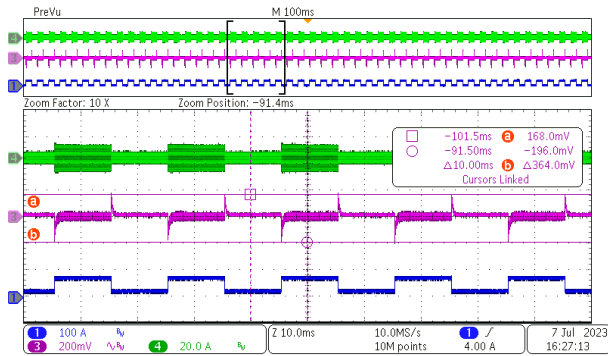

Figure 3-7. Load Transient: 380 V_{IN}, Load Step: 17 A 10 ms and 67 A 10 ms, 2.5 A/μs

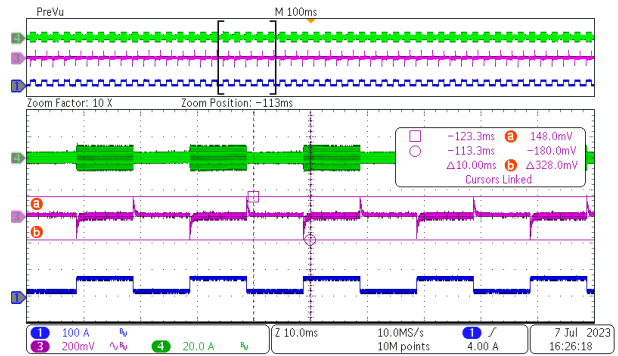

Figure 3-8. Load Transient: 400 V_{IN}, Load Step: 17 A 10 ms and 67 A 10 ms, 2.5 A/μs

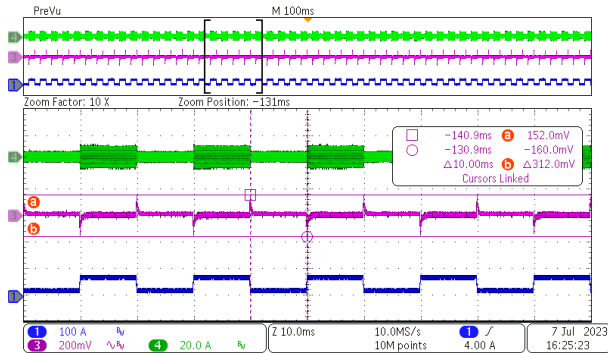

Figure 3-9. Load Transient: 410 V_{IN}, Load Step: 17 A 10 ms and 67 A 10 ms, 2.5 A/μs

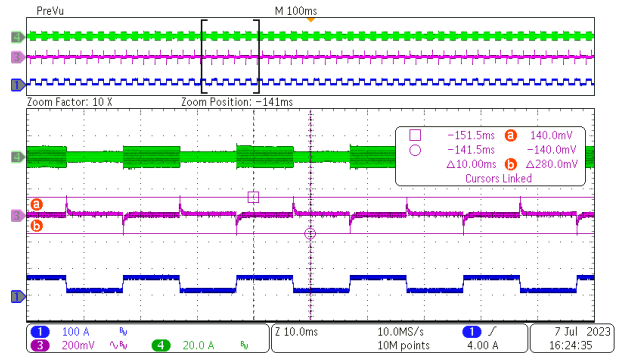

Figure 3-10. Load Transient: 420 V_{IN}, Load Step: 17 A 10 ms and 67 A 10 ms, 2.5 A/μs

3.2 Start-Up Sequence

Soft start behavior is shown in the following figures.

In the following waveforms, channel 1 in dark blue is load current; channel 3 in purple is output voltage; channel 4 in green is primary current.

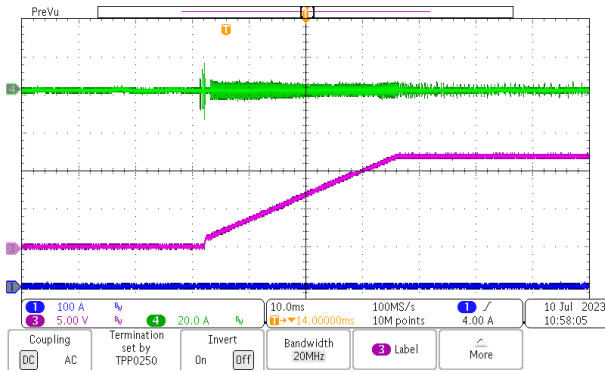

Figure 3-11. Soft Start With 400-VDC Input, 0-A Load

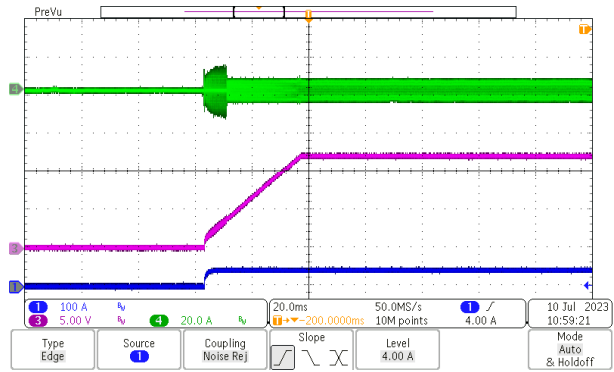

Figure 3-12. Soft Start With 400-VDC Input, 42-A Load

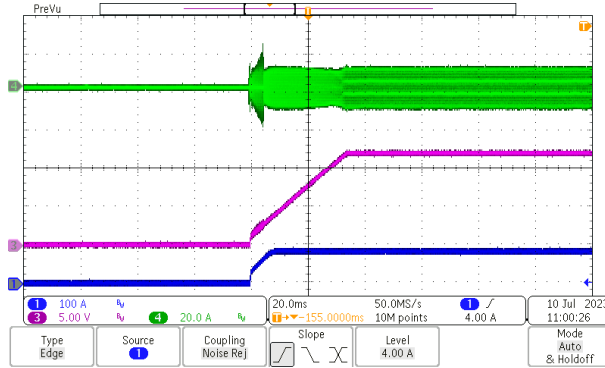

Figure 3-13. Soft Start With 400-VDC Input, 84-A Load

3.3 Output Voltage Ripple

Output voltage ripple is shown in the following figures.

In the following waveforms, channel 1 in dark blue is load current; channel 2 in light blue is input voltage; channel 3 in purple is AC portion of output voltage; channel 4 in green is the primary current.

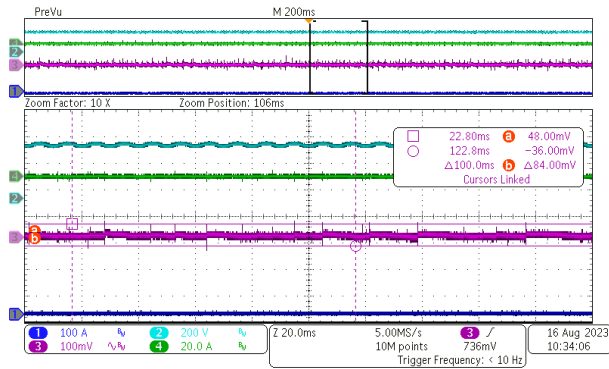

Figure 3-14. Output Voltage Ripple With 400 VDC, ±20-VAC Input, 0-A Load

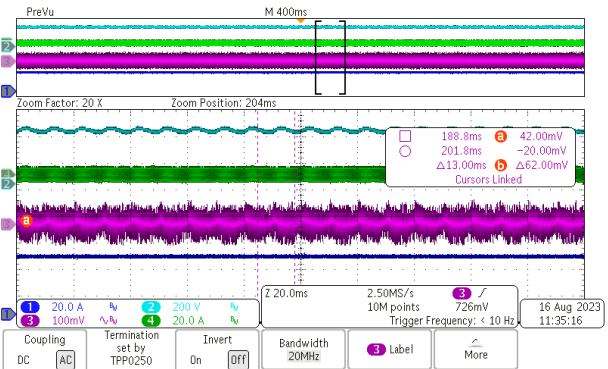

Figure 3-15. Output Voltage Ripple With 400 VDC, ±10-VAC Input, 42-A Load

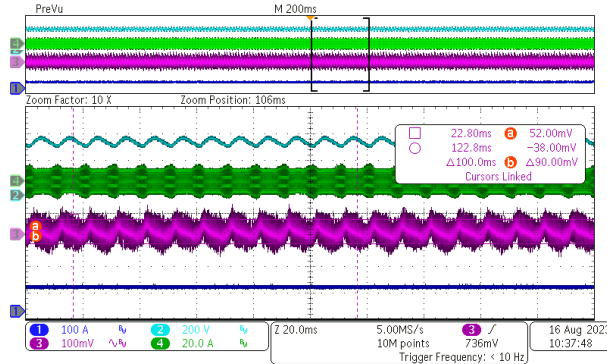

Figure 3-16. Output Voltage Ripple With 400 VDC, ±20-VAC Input, 84-A Load

Trademarks

TI E2E™ and Code Composer Studio™ are trademarks of Texas Instruments. All trademarks are the property of their respective owners.

IMPORTANT NOTICE AND DISCLAIMER

TI PROVIDES TECHNICAL AND RELIABILITY DATA (INCLUDING DATA SHEETS), DESIGN RESOURCES (INCLUDING REFERENCE DESIGNS), APPLICATION OR OTHER DESIGN ADVICE, WEB TOOLS, SAFETY INFORMATION, AND OTHER RESOURCES "AS IS" AND WITH ALL FAULTS, AND DISCLAIMS ALL WARRANTIES, EXPRESS AND IMPLIED, INCLUDING WITHOUT LIMITATION ANY IMPLIED WARRANTIES OF MERCHANTABILITY, FITNESS FOR A PARTICULAR PURPOSE OR NON-INFRINGEMENT OF THIRD PARTY INTELLECTUAL PROPERTY RIGHTS.

These resources are intended for skilled developers designing with TI products. You are solely responsible for (1) selecting the appropriate TI products for your application, (2) designing, validating and testing your application, and (3) ensuring your application meets applicable standards, and any other safety, security, regulatory or other requirements.

These resources are subject to change without notice. TI grants you permission to use these resources only for development of an application that uses the TI products described in the resource. Other reproduction and display of these resources is prohibited. No license is granted to any other TI intellectual property right or to any third party intellectual property right. TI disclaims responsibility for, and you will fully indemnify TI and its representatives against, any claims, damages, costs, losses, and liabilities arising out of your use of these resources.

TI's products are provided subject to [TI's Terms of Sale](#) or other applicable terms available either on [ti.com](https://www.ti.com) or provided in conjunction with such TI products. TI's provision of these resources does not expand or otherwise alter TI's applicable warranties or warranty disclaimers for TI products.

TI objects to and rejects any additional or different terms you may have proposed.

Mailing Address: Texas Instruments, Post Office Box 655303, Dallas, Texas 75265
Copyright © 2024, Texas Instruments Incorporated