

# Fundamentals of EMI Requirements for an Isolated DC/DC Converter



## **Robert Martinez**

Senior Systems Design Engineer  
High Voltage Power, High Voltage Controllers

## **Zhemín (Jimmy) Zhang**

Systems Engineer  
High Voltage Power, High Voltage Controllers

# Understanding how to manage and reduce emissions is crucial to the performance of your design.

## At a glance

This paper examines the fundamentals of electromagnetic interference (EMI) emissions, highlighting requirements and industry standards as they relate to implementation in an isolated DC/DC converter.



### 1 Various types of emissions

Both radiated emissions and conducted emissions have limits based on frequency range and targeted equipment.



### 2 Common causes of EMI

There are several ways to classify EMI problems, including EMI caused by isolation transformers.



### 3 How to mitigate EMI

One of the most common ways to manage EMI is to mitigate it at the source through better switch-control schemes.

EMI can cause problems to neighboring electrical circuitry if not managed and properly reduced below the sensitivity level of nearby circuitry. Industry standards from bodies such as Comité International Spécial des Perturbations Radioélectriques (CISPR), the International Electrotechnical Commission, Comité Européen de Normalisation Électrotechnique, the Federal Communications Commission and the United States Military Standard help regulate and alleviate EMI so that circuits can “play nice” with each other. The CISPR 32 standard dictates the maximum conducted emissions and maximum radiated emissions for industrial equipment. CISPR 32 replaces and combines the popular CISPR 22 and CISPR 13 specifications.

CISPR 32 defines two classes of equipment, associated with the type of end-user environment. Class B requirements are intended to offer adequate protection to broadcast services within residential environments. Equipment intended primarily for residential environments must meet the Class B limits; all broadcast receiver equipment is considered Class B. Class A requirements are for all non-Class B equipment; Class A-compliant equipment complies with more relaxed class limits [1, 2].

## Radiated emissions

Radiated emissions are tested in a Faraday shield chamber 10 m long, although 3-m chambers are available as well. These 3-m chambers have higher limits to account for the higher emissions strength scale difference.

Inside the chamber, an antenna detects and measures the emissions in horizontal and vertical positions at 1-m and 4-m heights at each test frequency, as shown in **Figure 1**. The equipment under test (EUT) is placed on a table that rotates 360 degrees. We recorded and plotted the highest quasi-peak and average measurement values of the sweeps.

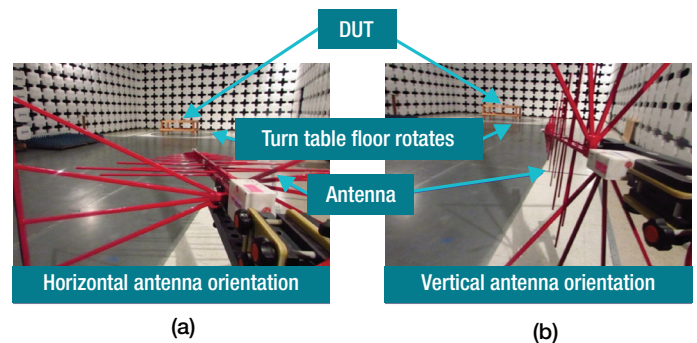

**Figure 1.** A 10-m radiated emissions chamber with the EUT on a rotating table: horizontal antenna orientation (a); vertical antenna orientation (b).

The quasi-peak value is similar to a root-mean-square value in that it is lower than the peak value and above the average value. The quasi-peak value is higher because the peak event occurs more often within the same time frame.

**Figure 2** shows the difference between peak, quasi-peak and average values.

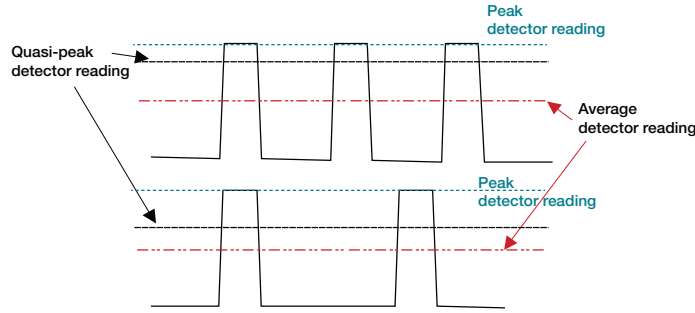

**Figure 2.** Peak, quasi-peak and average values of two detected signals from the antenna. Peak and average values are the same in both waveforms, while the quasi-peak is lower in the bottom waveform.

The highest internal frequency of the EUT determines the highest measured frequency for radiated emissions, as shown in **Table 1**.

Highest internal frequency (F <sub>x</sub> ) <sup>1</sup>	Highest measured frequency
F <sub>x</sub> ≤ 108 MHz	1 GHz
108 MHz < F <sub>x</sub> ≤ 1 GHz	2 GHz
500 MHz < F <sub>x</sub> ≤ 1 GHz	5 GHz
F <sub>x</sub> > 1 GHz	5 times F <sub>x</sub> up to a maximum of 6 GHz

<sup>1</sup>For FM and TV broadcast receivers, F<sub>x</sub> is determined from the highest frequency generated or used, excluding the local oscillator and tuned frequencies.

**Table 1.** Required highest frequency for radiated measurements in the CISPR 32 standard.

The CISPR 32 radiated emission limits depend on the targeted equipment classification, the measurement frequency range and the size of the chamber used in the measurements.

In CISPR 32, radiated emissions limits are defined within the frequency range of 30 MHz to 1 GHz for all EUT, and up to 6 GHz when F<sub>x</sub> is greater than 1 GHz. **Tables 2 and 3** list the radiated emissions limits in decibels (microvolts/meter) for Class A and Class B limits, respectively. **Figures 3 and 4** plot Class A and Class B limits for 10- and 3-m chambers [4, 11].

The bandwidth setting in the tables represents the resolution bandwidth (RBW) of the spectrum analyzer. The narrower

RBW provides finer frequency resolution while sweeping the complete frequency span, and differentiates harmonic components that have frequencies closer together. The trade-off is a longer sweep time. The RBW for the radiated emission test is 120 kHz, and the RBW for the conducted emission test is 9 kHz.

Typically, switch-mode power supplies have a clock below 1 GHz, so higher-frequency limits would not apply unless the equipment being used has a clock >1 GHz, such as in a PC. For simplicity, we limited the plots to a maximum of 1 GHz, as applied to DC/DC converters.

Frequency range (MHz)	Measurement		Class A limits (dB [μV/m])
	Distance <sup>1</sup> (m)	Detector type/ bandwidth	
30-230	10	Quasi peak/ 120 kHz	40
230-1,000			47
30-230	3	Quasi peak/ 120 kHz	50
230-1,000			57

<sup>1</sup>Apply only 10- or 3-m limits across the entire frequency range.

**Table 2.** Requirements for radiated emissions at frequencies up to 1 GHz for CISPR 32 Class A equipment.

Frequency range (MHz)	Measurement		Class B limits (dB [μV/m])
	Distance <sup>1</sup> (m)	Detector type/ bandwidth	
30-230	10	Quasi peak/ 120 kHz	30
230-1,000			37
30-230	3	Quasi peak/ 120 kHz	40
230-1,000			47

<sup>1</sup>Apply only 10- or 3-m limits across the entire frequency range.

**Table 3.** Requirements for radiated emissions at frequencies up to 1 GHz for CISPR 32 Class B equipment.

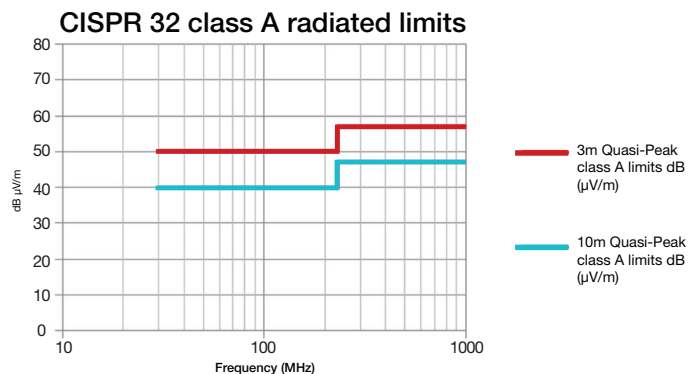

**Figure 3.** Graphical representation of the limits for radiated emissions of Class A equipment for 3- and 10-m chambers as defined in Table 2.

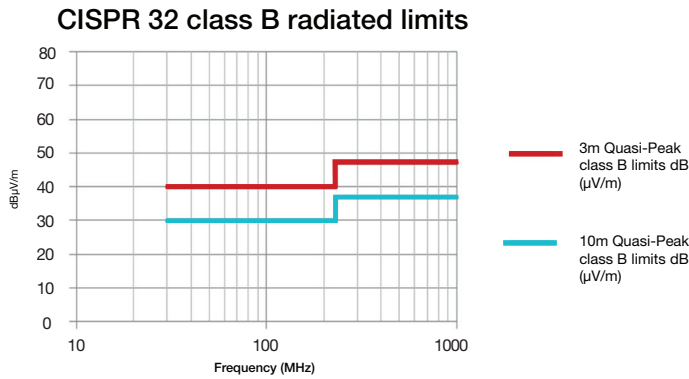

**Figure 4.** Graphical representation of the limits for radiated emissions of Class B equipment for 3- and 10-m chambers as defined in Table 3.

## Conducted emissions

**Figure 5** illustrates the arrangement of a conducted emissions test [1]. The EUT is placed on a nonconductive table that stands on a horizontal ground plane and is next to a vertical ground plane.

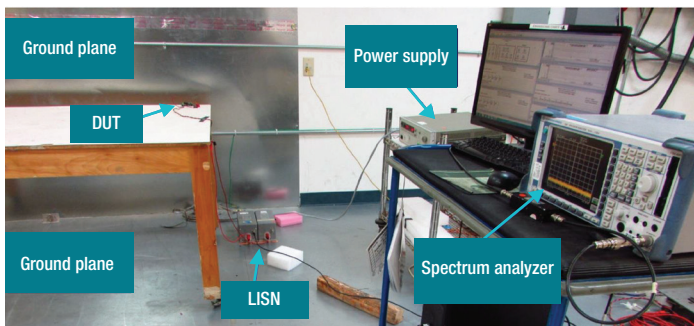

**Figure 5.** Example test arrangement for tabletop equipment (conducted emissions measurement) [1].

Conducted emissions EMI testing requires a line impedance stabilization network (LISN). A LISN is a low-pass filter typically placed between the input power supply and the EUT. Figure 6 shows the typical 50- $\mu$ H LISN used in testing. The power source connects to the LINE side of the LISN. On the EUT side, a spectrum analyzer runs a frequency sweep connected to one of the LISN 50- $\Omega$  outputs, while a 50- $\Omega$  terminator is connected to the other 50- $\Omega$  output of the LISN. Another frequency sweep runs, but with the 50- $\Omega$  terminator and 50- $\Omega$  output connection to the spectrum analyzer swapped.

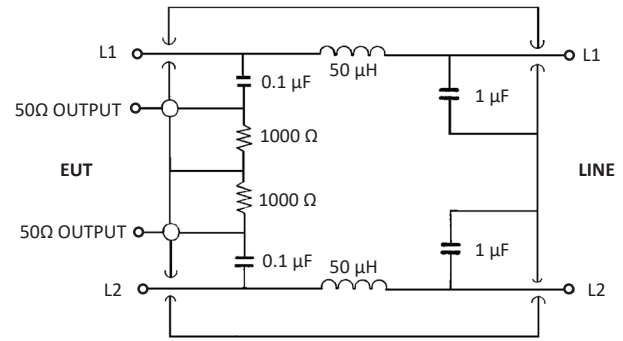

**Figure 6.** Typical 50- $\mu$ H LISN used for CISPR 32 conducted emissions measurements [5].

The CISPR 32 conducted emissions limits are defined within the frequency range of 150 kHz to 30 MHz.

**Table 4** and **Figure 7** list and illustrate, respectively, the requirements for Class A equipment for conducted emissions [4, 12].

Frequency range (MHz)	Coupling device	Detector type/bandwidth	Class A limits <sup>1,2</sup> (dB [μV])
0.15-0.5	LISN	Quasi peak/9 kHz	76-66
0.5-5			66
5-30			70
0.15-0.5	LISN	Average/9 kHz	66-56
0.5-5			56
5-30			60

<sup>1</sup>The lower limit applies at the transition frequency.

<sup>2</sup>The limit decreases linearly with the logarithm of the frequency in the range of 0.15 MHz to 0.50 MHz.

**Table 4.** Requirements for conducted emissions from the AC mains power ports of Class A equipment.

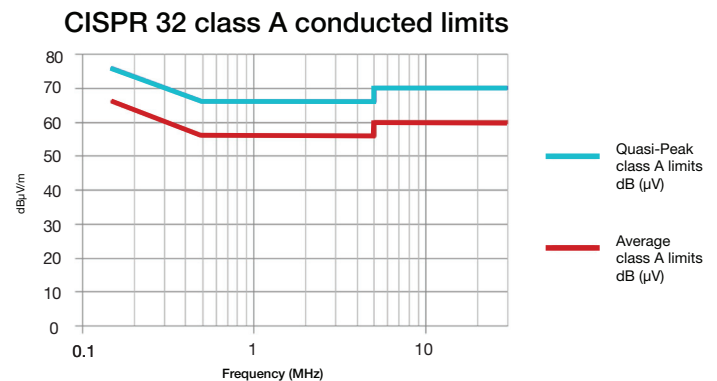

**Figure 7.** Graphical representation of the limits for conducted emissions from the AC mains power ports of Class A equipment defined in Table 4.

**Table 5** and **Figure 8** list and illustrate, respectively, the requirements for Class B equipment for conducted emissions [4, 12].

Frequency range (MHz)	Coupling device	Detector type/bandwidth	Class B limits <sup>1, 2</sup> (dB [ $\mu$ V])
0.15-0.5	LISN	Quasi peak/9 kHz	66-56
0.5-5			56
5-30			60
0.15-0.5	LISN	Average/9 kHz	56-46
0.5-5			46
5-30			50

<sup>1</sup>The lower limit applies at the transition frequencies.  
<sup>2</sup>The limit decreases linearly with the logarithm of the frequency in the range of 0.15 MHz to 0.50 MHz.

**Table 5.** Requirements for conducted emissions from the AC mains power ports of Class B equipment.

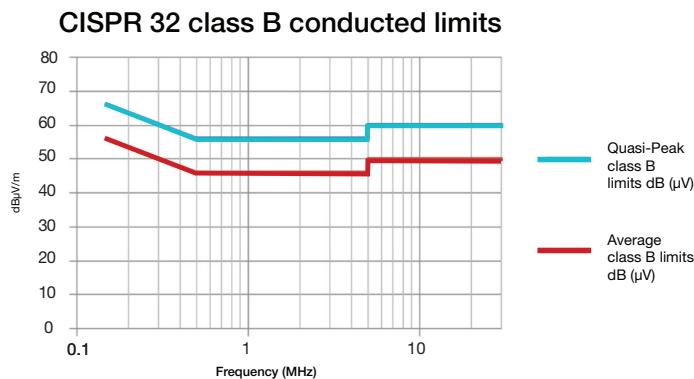

**Figure 8.** Graphical representation of the limits for conducted emissions from the AC mains power ports of Class B equipment defined in Table 5.

## Common causes of EMI

It's possible to classify EMI problems into the “noise source-noise path-victim” model shown in **Figure 9**. In a switch-mode power supply, the noise source often refers to noise generated from switching operations. When the powered device turns on and off, the external current from the power loop charges or discharges the parasitic capacitors. The voltage (dv/dt) or current (di/dt) slew rates will be high when the switching speed is very fast. The common-mode noise current flows through the parasitic capacitor between the drain of the power metal-oxide semiconductor field-effect transistor or collector of the insulated gate bipolar transistor and the heat sink. The return path can be earth ground and back to the power stage, which is an example of a conductive EMI path [6].

The noise path can also refer to radiative coupling paths between signal traces or power-supply conductors. The power/ground plane often works as an unwanted patch antenna at the resonance frequencies. Integrated chips are usually too small to radiate significantly themselves. In order to radiate fields strong enough to cause an interference problem, energy must couple from the integrated circuit package to larger structures that act as antennas such as printed circuit board (PCB) planes, heat sinks or cables.

The victim is an antenna for a radiative emission. The LISN is a victim for conductive emissions, which is used with an EMI receiver for measuring noise.

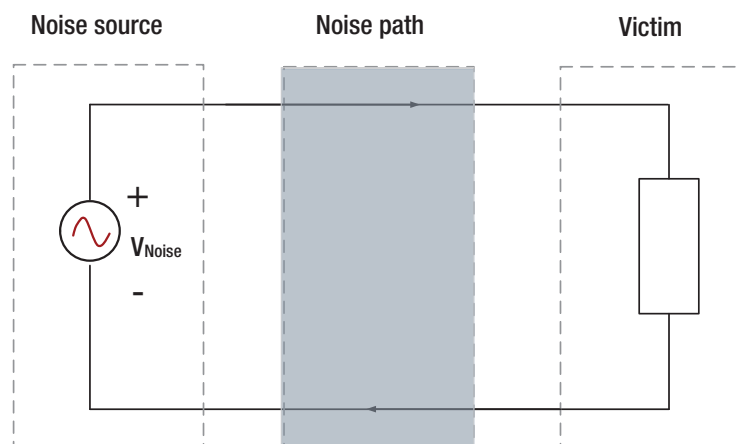

**Figure 9.** EMI emissions model.

## EMI caused by isolation transformers

An isolated power converter transfers energy across an isolation barrier. The input and output planes form a natural dipole antenna. As shown in **Figure 10**, common-mode current flows through parasitic capacitance between the transformer's primary and secondary windings, and returns

from the parasitic capacitance between the two arms of the input-to-output dipole.

The size of the PCB plane determines the dipole antenna size; the transformer's area and distance between windings determine the interwinding capacitance. This common-mode current generates radiated EMI noise. The amount of radiated energy will increase, as the current is larger.

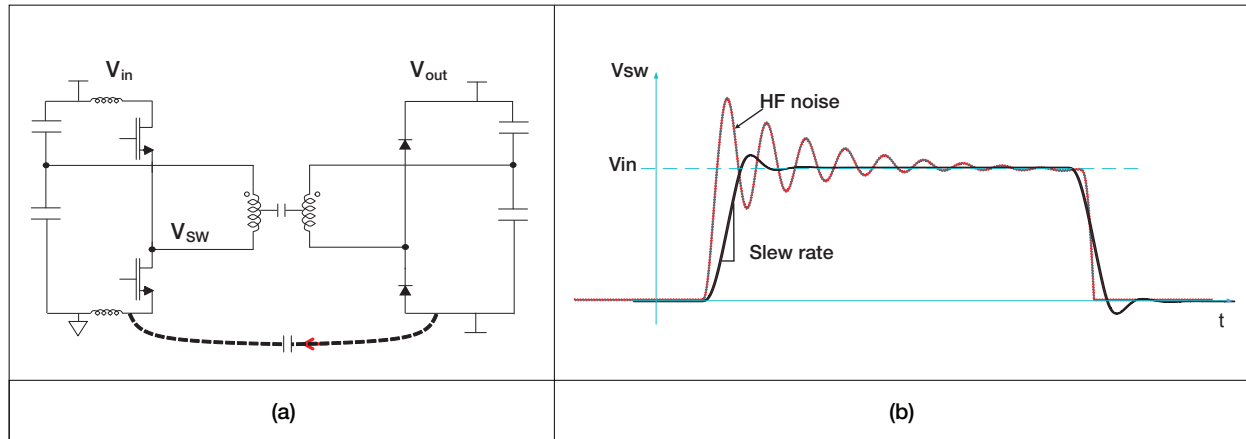

**Figure 10.** Common-mode current flow for an isolated DC/DC converter (a); switch-node waveform (b).

## EMI mitigation methods

One of the most common ways to manage EMI is to mitigate it at the source through better switch-control schemes. For example, a larger gate impedance can slow down the switch speed, reducing the slew rate of the switch-node voltage (VSW). The turning point of the high-frequency pole will be lower, so you can attenuate the common-mode noise. At the end of the turnoff time, loop inductance resonating with parasitic capacitors causes high-frequency ringing on the VSW. To reduce overshoot and protect the device, you can choose a resistor-capacitor diode or other snubber circuitries. The soft-switch transition technique is another popular method to control  $dv/dt$  and eliminate high-frequency noise from the switch node.

The selection of switching frequency plays an important role in minimizing EMI filter requirements, with a reduced switching frequency resulting in lower EMI noise at the expense of large-sized passive components. A common compromise is to set the switching frequency to around 70 kHz so that the first- and second- harmonic components of the switching current are below the lower frequency limit (150 kHz) of CISPR-conducted EMI standards. Otherwise,

you can increase the switching frequency a lot – to hundreds of kilohertz or megahertz – which helps reduce the filter size by targeting a high crossover frequency. This method is usually combined with a soft-switching approach.

Spread-spectrum modulation is another way to mitigate EMI. The basic concept is to introduce a controlled variation of the frequency within just a few percent of the nominal value. What this does is spread out the EMI across a wider range of frequencies instead of concentrating it at the nominal frequency. The key point is to modulate the clock under the tolerance of the circuit without disrupting other control or communication circuitry.

The modulation profile refers to the shape of the curve describing the frequency variation. A conventional modulation profile includes both sinusoidal and triangular waveforms. Another random carrier-frequency modulation, which changes the switching frequency randomly while maintaining the duty cycle at the desired value, claims further benefits than standard profiles.

The major design trade-offs of transformers for isolated power supplies are to balance the inductance, coupling and parasitic capacitance. To meet common-mode transient

immunity requirements and reduce EMI noise, you need to limit the value of the interwinding capacitance.

## Isolated DC/DC bias supply devices

The Texas Instruments [UCC12050](#) is part of a family of isolated DC/DC converters and modules and is the first device with TI's integrated transformer technology. The product is simple to use, only requiring input and output capacitors. It is rated for 5 V with a +10% input and delivers an isolated 3.3-V, 3.7-V, 5-V or 5.4-V output with over 500-mW capability. The UCC12050 has reinforced isolation, and its sister product, the [UCC12040](#), is rated for basic isolation [7, 8]. **Figure 11** shows the evaluation module for the UCC12050 [9].

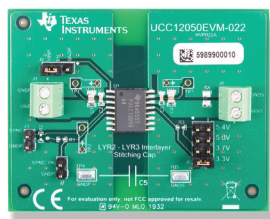

**Figure 11.** Evaluation module for the Texas Instruments UCC12050.

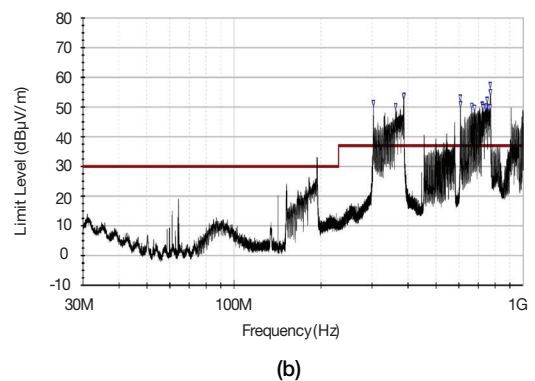
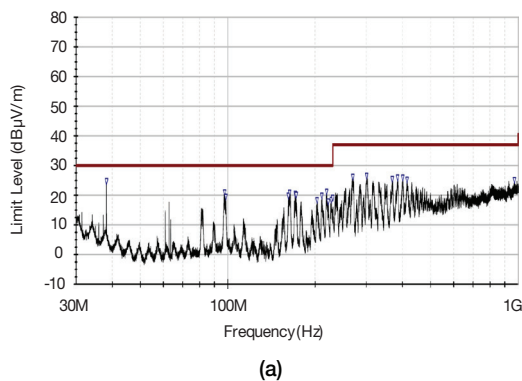

**Figure 12.** CISPR Class B radiated emissions at 30 MHz to 1 GHz for the UCC12050 (a); and a competing device (b).

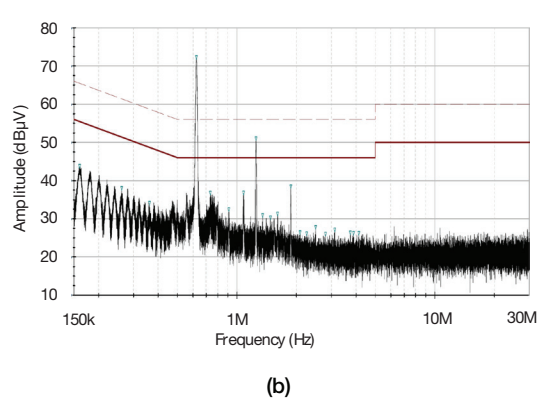
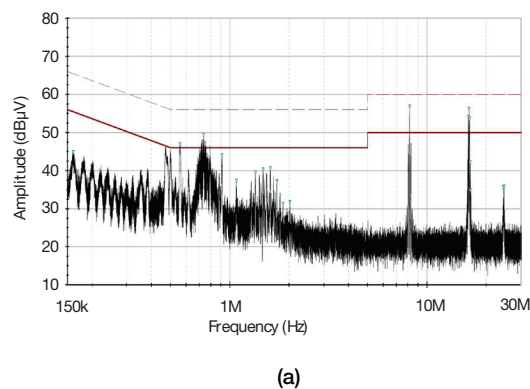

**Figure 13.** Class B conducted emissions at 150 kHz to 30 MHz for the UCC12050 (a); and a competing device (b).

The UCC12050 and UCC12040 are optimized for low EMI by leveraging spread-spectrum modulation and low primary-to-secondary capacitance. **Figure 12** illustrates the radiated emissions performance versus a competitive device. The testing is CISPR 32 at a 10-m distance with a horizontal antenna. Both devices are set up for an apples-to-apples comparison at a 5-V input and 5-V output at 500 mW – with a two-layer PCB, no ferrite beads, no low-dropout regulators and no primary-to-secondary ground-plane overlap. TI's UCC12050 delivers 5 dB $\mu$ V/m of margin to the Class B quasi-peak limit and its peaks are >25 dB $\mu$ V/m lower than the competing device.

With the same operating conditions, the UCC12050 outperforms the competition in CISPR 32 Class B conducted emissions. **Figure 13** shows the two devices relative to the dotted quasi-peak and solid average limits. With additional improvements using two small-input 0603 ferrite beads (1,500  $\Omega$  at 100 MHz), it is possible to reduce conducted emissions further. **Figure 14** shows this data.

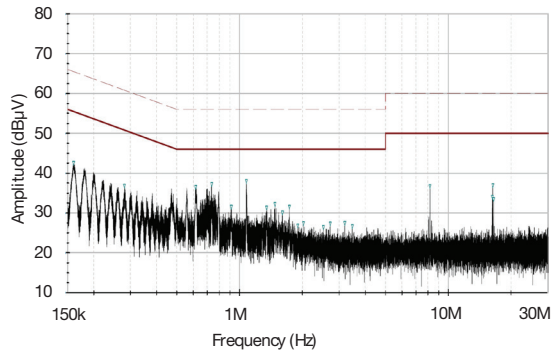

(a)

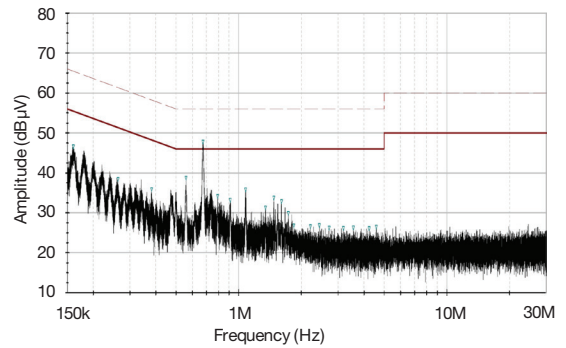

(b)

**Figure 14.** The UCC12050 (a); and a competing device (b) with a  $1,500 \Omega$  at 100 MHz input ferrite bead.

Likewise, it is possible to make additional improvements in layout by implementing a stitch capacitor within two inner layers. **Figure 15** shows an example of a stitch capacitor added with two inner layers overlapping the ground planes underneath the device. We recommend careful monitoring of dimensions to maintain the proper isolation level [10]. Monitoring primarily helps high-frequency common-mode decoupling to further reduce radiated emissions and can achieve  $>9 \text{ dB}\mu\text{V}/\text{m}$  margin for the Class B quasi-peak limit.

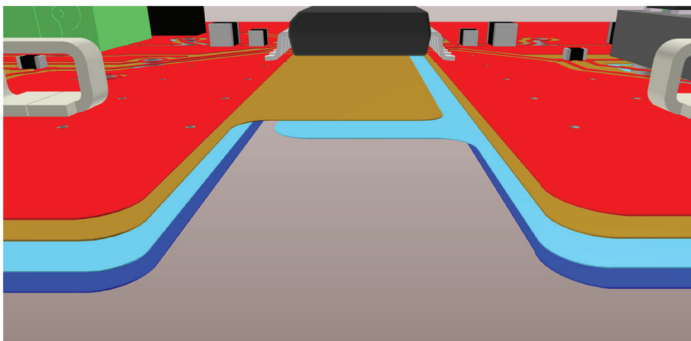

**Figure 15.** Optional stitch capacitors between inner layers for further reduction of radiated emissions on the Texas Instruments [UCC12050 evaluation module](#).

**Figure 16** shows the radiated emissions data using a stitch capacitor with two inner layers and no ferrite beads.

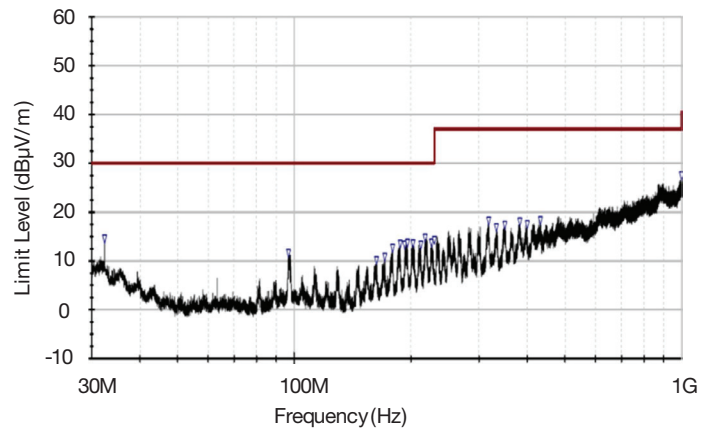

**Figure 16.** CISPR Class B radiated emissions at 30 MHz to 1 GHz for the UCC12050 with a stitch capacitor and no ferrite beads.



## Conclusion

You can reduce the risk and headaches of qualifying an isolated DC/DC power converter by considering how to control EMI in the early stages of your design. It is possible to manage EMI by knowing the threshold limits, then looking into the causes of and ways to mitigate emissions in order to keep the values below industry standards. TI designed the highly integrated UCC12050 isolated DC/DC module with EMI control in mind, meeting radiated and conducted emissions per the CISPR 32 standard and without requiring ferrite beads, saving board space and cost.

## References

1. National Technical Systems, "PR102554 Texas Instruments CE Mark Report Rev. 1," Electromagnetic Compatibility (EMC) Requirements EN55032 Test Report for UCC12050, CISPR 32 Radiated and Conducted Emissions Certification Report, September 2019.
2. Daniel Hoolihan, [www.interferencetechnology.com](http://www.interferencetechnology.com).
3. Gurney, Dorine. ["EMI emissions testing: peak, quasi-peak and average measurements,"](#) EDN, July 10, 2018.
4. International Electrotechnical Commission (IEC), "EN 55032/CISPR 32, Electromagnetic Compatibility of Multimedia Equipment – Emission Requirements," Ed. 2.0 2015-03.
5. Fischer Custom Communications, "Standard 50-Ω LISN for CISPR 16," data sheet, 2015.
6. Mainali, Krishna, and Ramesh Oruganti. ["Conducted EMI Mitigation Techniques for Switch-Mode Power Converters: A Survey,"](#) IEEE Transactions on Power Electronics 25, no. 9 (September 2010): 2344-2356.
7. ["UCC12050 High-Efficiency, Low-EMI, 5-kVRMS Reinforced Isolation DC-DC Converter,"](#) Texas Instruments data sheet SNVSB38C, April 2020.
8. ["UCC12040 High-Efficiency, Low-EMI, 3-kVRMS Basic Isolation DC-DC Converter,"](#) Texas Instruments data sheet SNVSB05A, April 2020.
9. ["UCC12050EVM-022 User's Guide,"](#) Texas Instruments user guide SLUUBD5, September 2019.
10. "Low-Emission Designs with ISOW7841 Integrated Signal and Power Isolator," Texas Instruments application report SLLA368C, February 2019.
11. Hegarty, Timothy, ["An overview of radiated EMI specifications for power supplies,"](#) Texas Instruments white paper SLYY142, July 2018.
12. Hegarty, Timothy, ["An overview of conducted EMI specifications for power supplies,"](#) Texas Instruments white paper SLYY136, February 2018.

**Important Notice:** The products and services of Texas Instruments Incorporated and its subsidiaries described herein are sold subject to TI's standard terms and conditions of sale. Customers are advised to obtain the most current and complete information about TI products and services before placing orders. TI assumes no liability for applications assistance, customer's applications or product designs, software performance, or infringement of patents. The publication of information regarding any other company's products or services does not constitute TI's approval, warranty or endorsement thereof.

All trademarks are the property of their respective owners.

## IMPORTANT NOTICE AND DISCLAIMER

TI PROVIDES TECHNICAL AND RELIABILITY DATA (INCLUDING DATASHEETS), DESIGN RESOURCES (INCLUDING REFERENCE DESIGNS), APPLICATION OR OTHER DESIGN ADVICE, WEB TOOLS, SAFETY INFORMATION, AND OTHER RESOURCES "AS IS" AND WITH ALL FAULTS, AND DISCLAIMS ALL WARRANTIES, EXPRESS AND IMPLIED, INCLUDING WITHOUT LIMITATION ANY IMPLIED WARRANTIES OF MERCHANTABILITY, FITNESS FOR A PARTICULAR PURPOSE OR NON-INFRINGEMENT OF THIRD PARTY INTELLECTUAL PROPERTY RIGHTS.

These resources are intended for skilled developers designing with TI products. You are solely responsible for (1) selecting the appropriate TI products for your application, (2) designing, validating and testing your application, and (3) ensuring your application meets applicable standards, and any other safety, security, or other requirements. These resources are subject to change without notice. TI grants you permission to use these resources only for development of an application that uses the TI products described in the resource. Other reproduction and display of these resources is prohibited. No license is granted to any other TI intellectual property right or to any third party intellectual property right. TI disclaims responsibility for, and you will fully indemnify TI and its representatives against, any claims, damages, costs, losses, and liabilities arising out of your use of these resources.

TI's products are provided subject to TI's Terms of Sale (<https://www.ti.com/legal/termsofsale.html>) or other applicable terms available either on [ti.com](https://www.ti.com) or provided in conjunction with such TI products. TI's provision of these resources does not expand or otherwise alter TI's applicable warranties or warranty disclaimers for TI products.

Mailing Address: Texas Instruments, Post Office Box 655303, Dallas, Texas 75265  
Copyright © 2021, Texas Instruments Incorporated