

Bulk Capacitor Sizing for DC Motor Drive Applications



Clark Kinnaird

ABSTRACT

Appropriate local bulk capacitance is an important factor in motor drive system design. Having more bulk capacitance is generally beneficial, while the disadvantages are increased cost and physical size. This application note discusses general guidelines for selecting the amount of capacitance needed in a motor drive system.

Table of Contents

1 Introduction	2
2 Background and Theory	3
2.1 Factors Affecting Bulk Capacitor Sizing.....	3
2.2 Pulse Width Modulation.....	4
2.3 Estimating Motor Current Variation.....	5
2.4 General Guideline Calculations Assuming Ideal Capacitors.....	5
3 Real-World Results	7
3.1 Example Measurements.....	7
3.2 Revised Practical General Guidelines.....	10
3.3 Other Considerations.....	11
4 Summary	12
5 References	12

Trademarks

All trademarks are the property of their respective owners.

1 Introduction

Direct current (DC) motors are found in a wide variety of applications in automotive, industrial, and consumer products. When switched on or off, including during pulse-width modulation (PWM) operation, the motor current can change significantly. These current changes can create issues such as supply voltage variations and electromagnetic interference for nearby electronics.

It is common to include large *bulk* capacitors as part of the motor driver design. These bulk capacitors act as a local reservoir of electrical charge to smooth out the motor current variation. [Figure 1-1](#) shows a typical evaluation board with the two large electrolytic capacitors on the right side of the board acting as bulk capacitors for the DC motor driver.

Designers look for guidance on the appropriate values of bulk capacitance. In the following discussion, we can look for methods to select a proper value of capacitance based on knowledge of the motor and driver parameters. The nomenclature is based on brushed DC motors, but the same principals apply to other types, including brushless DC (BLDC) and stepper motors.

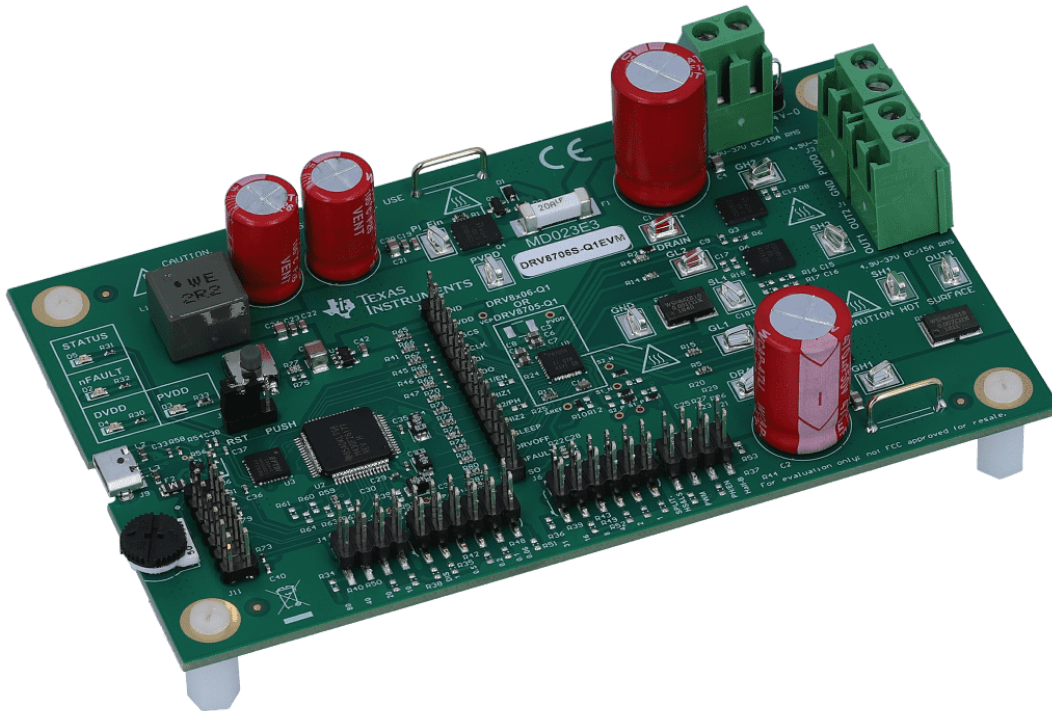

Figure 1-1. Typical Motor Driver Board Showing Large Bulk Capacitors

2 Background and Theory

Experienced engineers often use general guidelines about bulk capacitance to select the capacitor values. One such guideline says to use at least 1 to 4 μ F of capacitance for each Watt of motor power. For example, a motor which draws 10 Amps from a 12V supply has a power of 120 Watts, leading to bulk capacitance of 120 to 480 μ F, using this general guideline. We dig a little deeper and see what further discussion supports those estimates.

To improve a motor drive design with regards to bulk capacitance, we first refresh our understanding of the fundamentals behind the relevant current and voltage relationships. Before moving on to specific practical cases, we look at the mathematics that describe a simplified designed for situation.

2.1 Factors Affecting Bulk Capacitor Sizing

The amount of bulk capacitance needed depends on a variety of factors including:

- The highest current required by the motor system
- The power supply's type, capacitance, and ability to source current
- The amount of inductance between the power supply and motor system
- Method of operation, whether continuous or using pulse width modulation
- The acceptable supply voltage ripple
- Type of motor (brushed DC, brushless DC, stepper) and motor characteristics
- The motor startup and braking methods

In a ideal DC motor system, there is no impedance between the motor drive circuit and the power source, which can be modeled as an ideal constant voltage source. In this ideal for case, there is not any variation in the motor supply voltage. However, in a real practical system, the inductance between the power supply and motor drive system limits the rate at which current from the power supply can change. There can also be filtering inductance on the driver board or in the power distribution network. This inductance between the power supply, often a 12V battery in automotive systems, and the motor drive voltage V_M , is modeled as a lumped inductance on the positive and ground connections labeled *Parasitic Wire Inductance* shown in [Figure 2-1](#).

If the local bulk capacitance is too small, the system responds to excessive current demands or dumps from the motor with a change in motor supply voltage. When adequate bulk capacitance is used, large variations in current can be quickly accommodated, and the motor supply voltage remains stable.

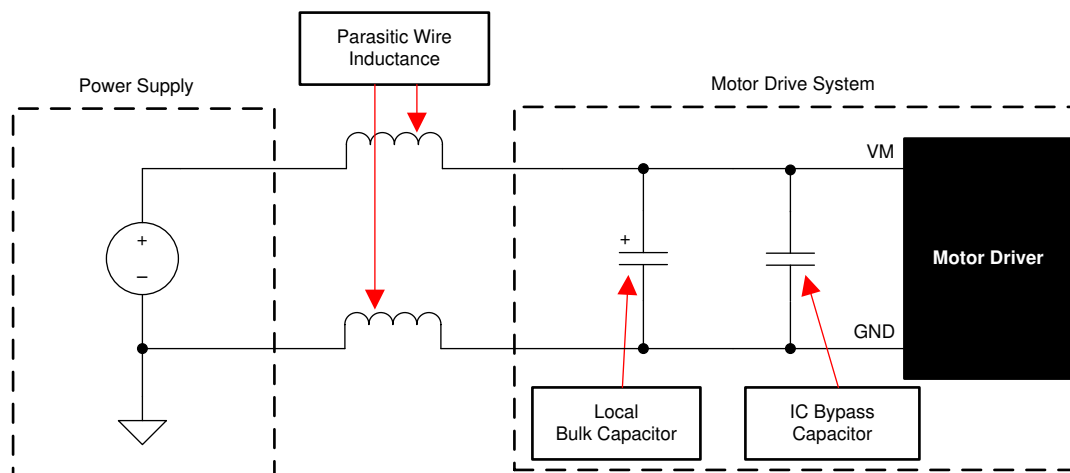

Figure 2-1. Motor Drive Model From DRV8718-Q1 Data Sheet

The motor driver data sheet can provide a recommended *minimum* value, but system level testing is required to determine the appropriately sized bulk capacitor. Table 2-1 shows an example of the recommendations in a TI motor driver data sheet. Here both C_{PVDD1} and C_{PVDD2} are connected in parallel from the motor supply voltage (VM or PVDD) to Ground (GND).

Table 2-1. Recommended External Components

COMPONENT	PIN 1	PIN 2	RECOMMENDED
C_{PVDD1}	PVDD	GND	0.1 μ F, low ESR ceramic capacitor, PVDD-rated.
C_{PVDD2}	PVDD	GND	Local bulk capacitance greater than or equal to 10 μ F, PVDD-rated.
$C_{DVDD}^{(1)}$	DVDD	GND	1.0 μ F, 6.3V, low ESR ceramic capacitor
$C_{AREF}^{(1)}$	AREF ⁽³⁾	GND	0.1 μ F, 6.3-, low ESR ceramic capacitor
C_{VCP}	VCP	PVDD	1 μ F 16V, low ESR ceramic capacitor
C_{FLY1}	CP1H	CP1L	0.1 μ F, PVDD-rated, low ESR ceramic capacitor
C_{FLY2}	CP2H	CP2L	0.1 μ F, PVDD + 16V, low ESR ceramic capacitor
R_{nFLT}	VCC ⁽²⁾	nFLT	Pullup resistor, $I_{OD} \leq 5$ mA

- (1) A local bypass capacitor is recommended to reduce noise on the external low voltage power supply. If another bypass capacitor is within close proximity of the device for the external low voltage power supply and noise on the power supply is minimal, removing this component is optional.
- (2) VCC is not a pin on the device, but the external low voltage power supply.
- (3) On the DRV8714-Q1 RHA package, the AREF pin is not present and the AREF power supply is derived from the DVDD pin.

2.2 Pulse Width Modulation

If pulse-width modulation (PWM) is used to control the effective motor voltage, the bulk capacitance on the motor supply becomes even more important. Otherwise the current variation during PWM operation can cause voltage ripple which can propagate throughout the system, causing electromagnetic interference with other components. Figure 2-2 shows typical waveforms in a motor drive system with PWM at 20kHz. The red trace marked *MOTOR CURRENT* shows the effect of rising current as the motor is activated, with ripple current corresponding to the PWM frequency.

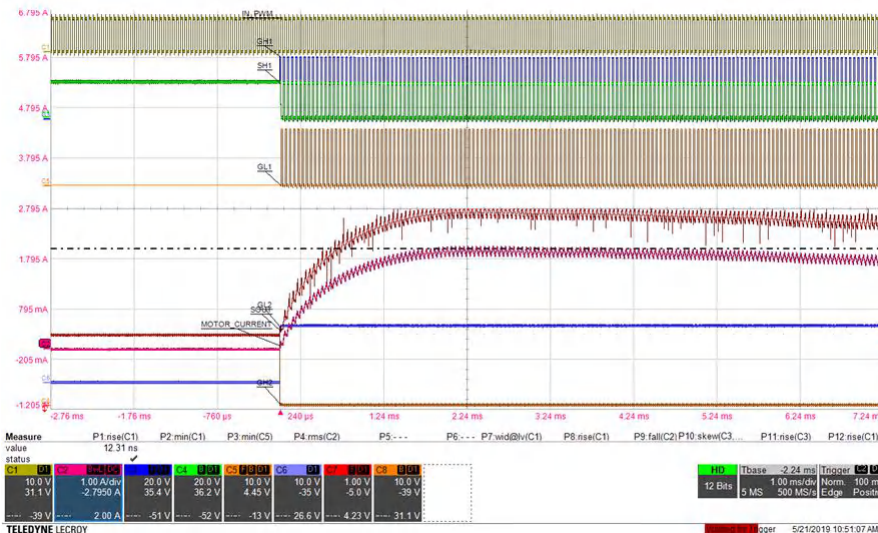
Figure 2-2. Typical Waveforms in a PWM Motor Drive, From DRV8718-Q1 Data Sheet

In this example, the scale is 1A per major division of the current trace, so the variation in motor current is on the order of 200mA due to the PWM switching. This is approximately 10% of the peak motor current of about 2 amps.

2.3 Estimating Motor Current Variation

During PWM operation, the motor current varies around an average value, with the current increasing during the *on* portion of the PWM period, and decreasing during the *off* portion. Modeling the motor winding as an inductance L_m in series with a resistance R_m , the increasing current is:

$$i_{inc}(t) = i_{min} + [i_f - i_{min}] \times (1 - e^{-t/\tau}) \quad (1)$$

Where i_f is the final steady-state current at 100% duty cycle, typically $PVDD/R_m$ and i_{min} is the current at the beginning of the PWM *on* portion, and tau is the motor electrical time constant, L_m/R_m .

Similarly for the decreasing current:

$$i_{dec}(t) = i_{max} + [0 - i_{max}] \times (1 - e^{-t/\tau}) = i_{max} \times e^{-t/\tau} \quad (2)$$

Where i_{max} is the current at the beginning of the PWM *off* portion.

The motor current variation in Equation 3 is the motor current variation over each PWM cycle. This is illustrated in Figure 2-3.

$$\Delta I_{motor} = i_{max} - i_{min} \quad (3)$$

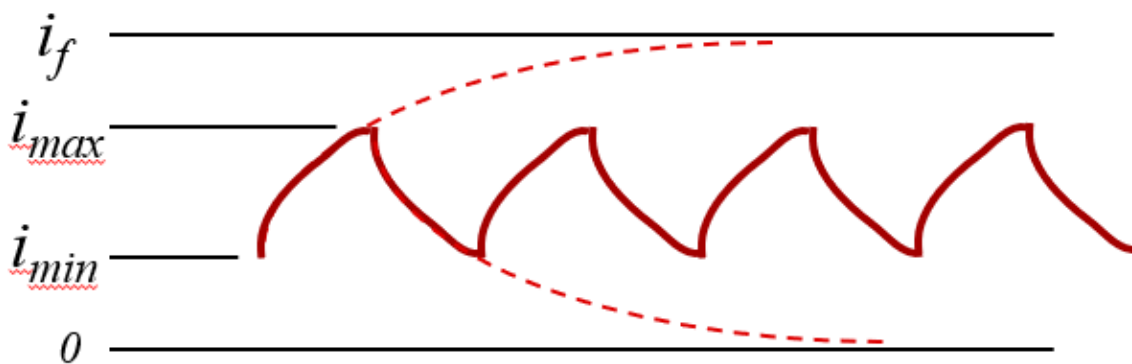

Figure 2-3. Motor Current Variation During PWM Operation, Ideal Capacitors

2.4 General Guideline Calculations Assuming Ideal Capacitors

As discussed previously, a large value of bulk capacitance is desired to provide a constant motor supply voltage during current transitions, such as motor start-up, changes in load torque, or PWM operation. But we can like having a working estimate of the needed capacitance so that we do not over-design the bulk capacitance, leading to high system cost and excessive board size. We can use a general guideline method to find an appropriate capacitor size based on the expected load current variation and allowable motor supply voltage variation.

An initial estimate of the appropriate bulk capacitance based on *ideal* capacitors is:

$$C_{BULK} > \Delta I_{MOTOR} \times T_{PWM} / \Delta V_{SUPPLY} \quad (4)$$

Where C_{BULK} is the bulk capacitance, ΔI_{MOTOR} is the expected variation in motor current, T_{PWM} is the pulse-width modulation period, and ΔV_{SUPPLY} is the allowable variation in the motor supply voltage.

This inequality is based on assumptions:

- Ideal capacitors with zero equivalent series resistance (ESR)
- A motor time constant L_m/R_m significantly longer than the PWM period

- Negligible change in supply current through the parasitic wire inductance
- The supply voltage variation induced by the varying motor current during PWM can be expected to be a maximum when the PWM duty cycle is 50%.

In an example, assume we have motor current variation during PWM of about $\Delta I_{\text{MOTOR}} = 200\text{mA}$; this is approximately what is shown in [Figure 2-2](#); a simplified sketch is shown in [Figure 2-4](#). For a typical PWM frequency of 20kHz, T_{PWM} is 50 microseconds.

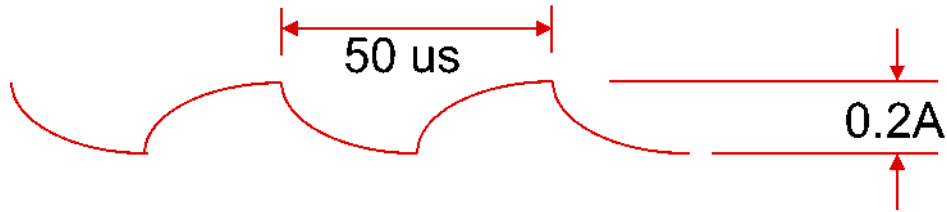

Figure 2-4. Simplified Example Motor Current Waveform During PWM

If we want to keep the motor supply voltage variation not more than $\Delta V_{\text{SUPPLY}} = 100\text{mV}$, we can estimate the required minimum bulk capacitance as:

$$C_{\text{BULK}} \geq 200\text{mA} \times 50\mu\text{s} / 0.1\text{V} = 10\mu\text{A} \cdot \text{s} / 0.1\text{V} = 100\mu\text{F} \quad (5)$$

This is an estimate, not a detailed analysis. We are neglecting several factors such as the effective series resistance (ESR) of the bulk capacitance, the non-infinite impedance of the inductance to the battery, the non-linear current variation shape, and so on. However, it gives a reasonable bulk capacitance value as a starting point for more rigorous system analysis.

In [Figure 2-5](#) the results for the ideal simulations are compared to what is predicted by the ideal capacitor equations. The simulated voltage ripple is somewhat smaller than the ideal estimate predicts, but overall the predictions and simulations are approximately in alignment, especially for higher values of bulk capacitance.

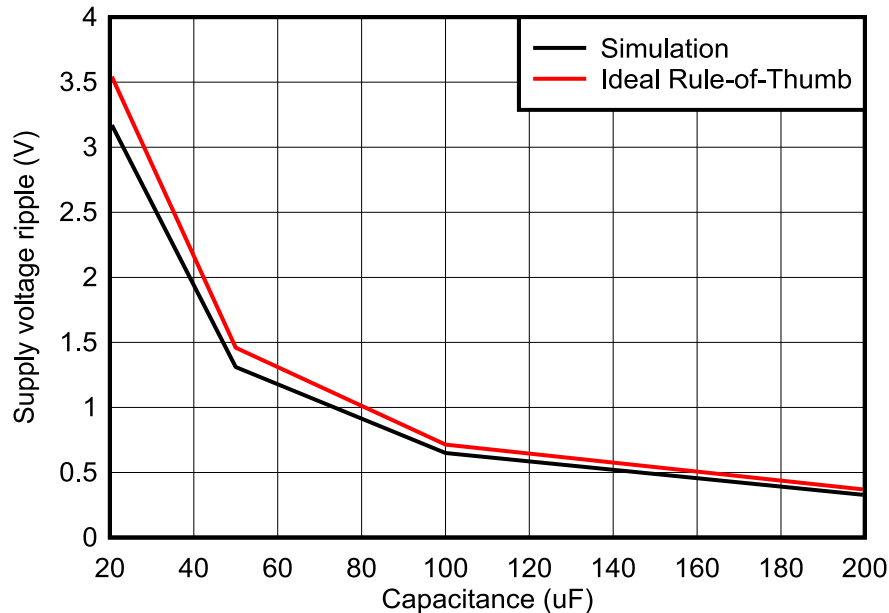

Figure 2-5. Comparison of Ideal Capacitor (ESR=0) General Guideline and Simulated Results

However, as we see in the following discussion, real-life measurements indicate the ideal results are off by as much as a factor of 3, which means the non-ideal capacitance ESR cannot be neglected.

3 Real-World Results

Laboratory measurements show that the calculations and general guideline discussed previously do not accurately match real-world results, due to the non-ideal characteristics of typical bulk capacitors.

3.1 Example Measurements

Using a DRV8718-Q1 EVM, we can measure examples of the effect of bulk capacitance. We used a 50% duty cycle PWM signal with a 12V supply, and a load of 3 Ohms in series with a 470uH inductor to simulate a typical DC motor circuit. The L/R time constant is 157 microseconds, about three times the PWM period.

Figure 3-1 shows the case where the bulk capacitance is 270uF. Using the estimate for ideal capacitors, we can expect about 80mV of variation in PVDD due to the capacitor charging and discharging during PWM. Neglecting the quick shift during each transition, the voltage ramp does have an amplitude of about 80mV, as indicated by the dashed cursors.

However, the total variation in PVDD in Figure 3-1 is about 160 mV, significantly more than predicted by the ideal capacitor estimate. There is a sharp shift in the voltage at the beginning of each transition, which is due to the non-ideal properties of the bulk capacitors. The equivalent series resistance (ESR) of electrolytic capacitors can account for this quick voltage shift.

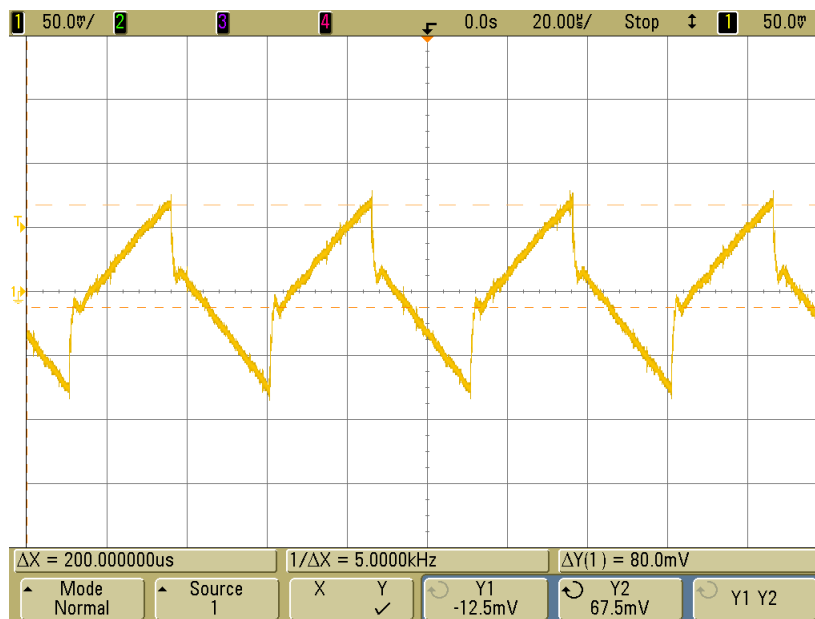

Figure 3-1. PVDD Variation With 270uF Bulk Capacitance, Measured Results During PWM

The variation on PVDD consists of mainly two components, the voltage due to the charging and discharging of the bulk capacitance, and the voltage across the non-ideal equivalent series resistance (ESR) of the capacitors.

The equivalent series resistance (ESR) of real capacitors is one measure of how non-ideal their characteristics are. Low ESR capacitors are typically more expensive, but can provide benefits in terms of reduced voltage ripple. This is a common topic in power supply design, for example, see the [Output Ripple Voltage for Buck Switching Regulator](#), application note.

With simulation, we can see what the ripple looks like with an ideal capacitor having zero ESR, and also model the real-world capacitor by adding a resistance in series to represent the ESR.

First let us look at how the current flows in the capacitor, and thus how the voltage varies across the ESR we model as part of the capacitor. During the 'on' part of the PWM cycle, the capacitor acts as a source of motor current, so the voltage drop across the ESR subtracts from the internal *ideal* voltage stored in the capacitor. Thus the voltage across the capacitor, including the ESR, is lower than the internally stored voltage. During the 'off' part of the PWM cycle, the capacitor acts as a current sink, charging up the internal voltage. During this

charging, the voltage across the capacitor, including the ESR is higher than the internally stored voltage. The motor and capacitor currents are shown in Figure 3-2.

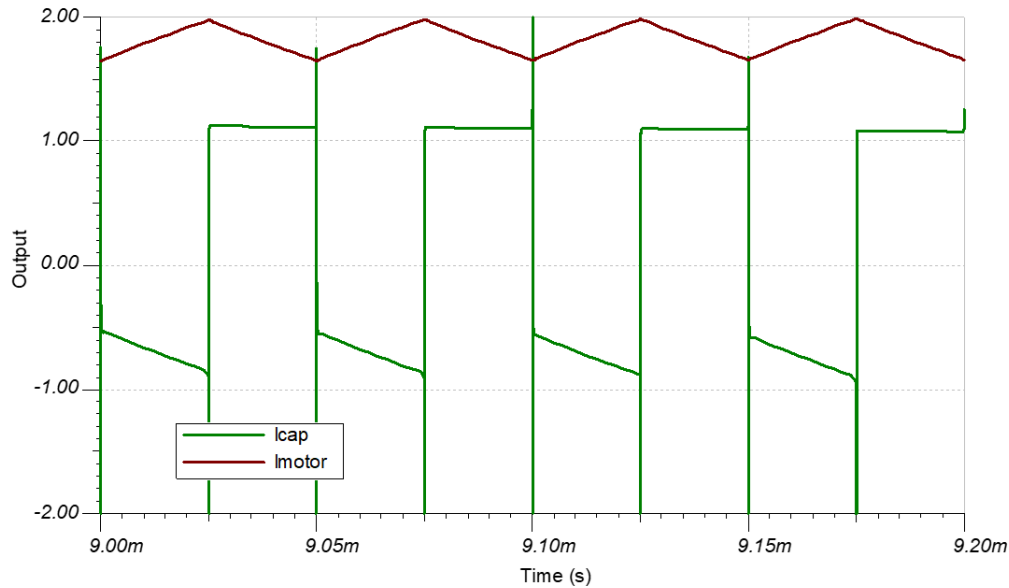

Figure 3-2. Motor Current (Red) and Capacitor Current (Green) During PWM

In Figure 3-3 a TINA simulation shows the voltage variation due to PWM of the MOSFET T1, with a bulk capacitance of 270uF and zero ESR, modeling an ideal capacitor. The voltage variation on PVDD is about 100mV. Figure 3-3 simulation largely agrees with the ideal capacitance equations.

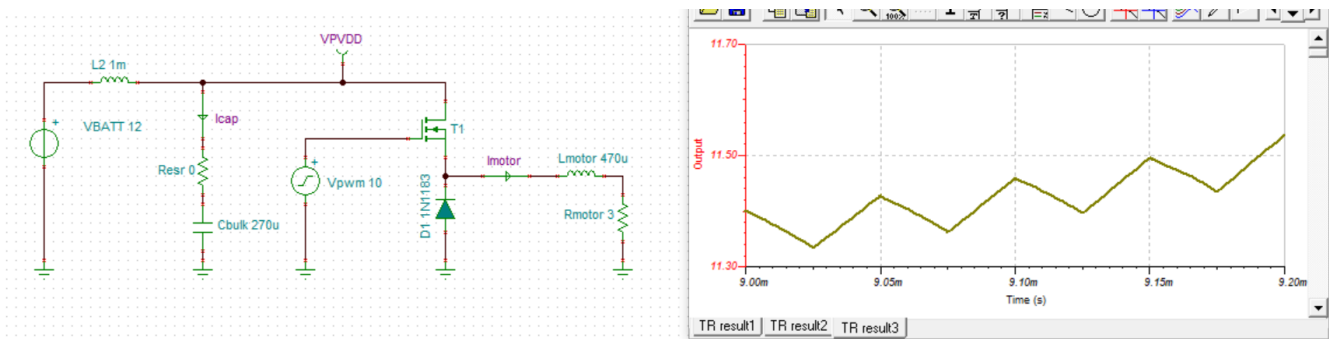

Figure 3-3. TINA Simulation with Zero ESR

When 50mΩ of ESR is modeled in Figure 3-4, the voltage variation increases to about 200mV, and the shape of the voltage ripple looks more like the real-world measured case.

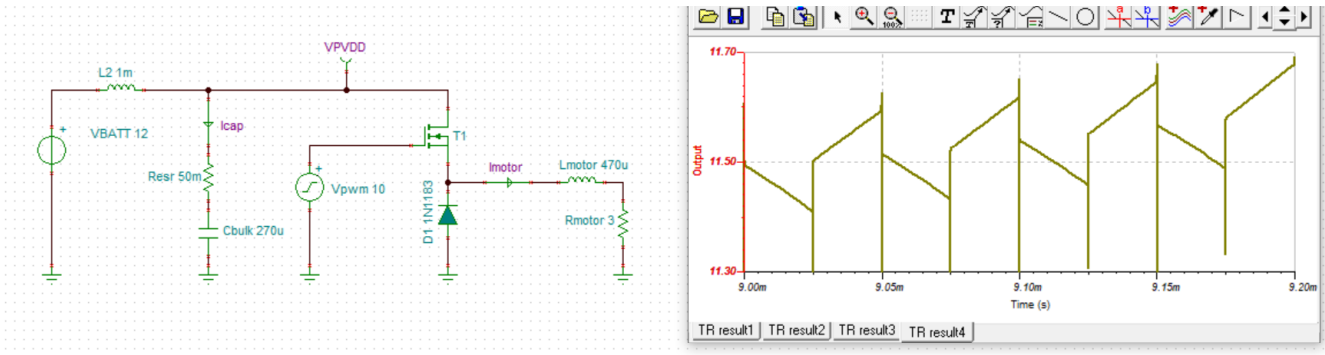

Figure 3-4. TINA Simulation With 50mΩ ESR

Note how adding ESR makes the waveform look more like the actual results.

Another real-world case is shown in Figure 3-5 where the bulk capacitance has been increased to 600uF by adding a 330uF capacitor in parallel with the 270uF of the previous case. The ideal capacitor estimate given previously can predict a voltage variation of about 36mV. The measured value is about 57mV; so while the voltage variation has been reduced by adding more bulk capacitance, it has not been reduced as much as predicted by the ideal estimate.

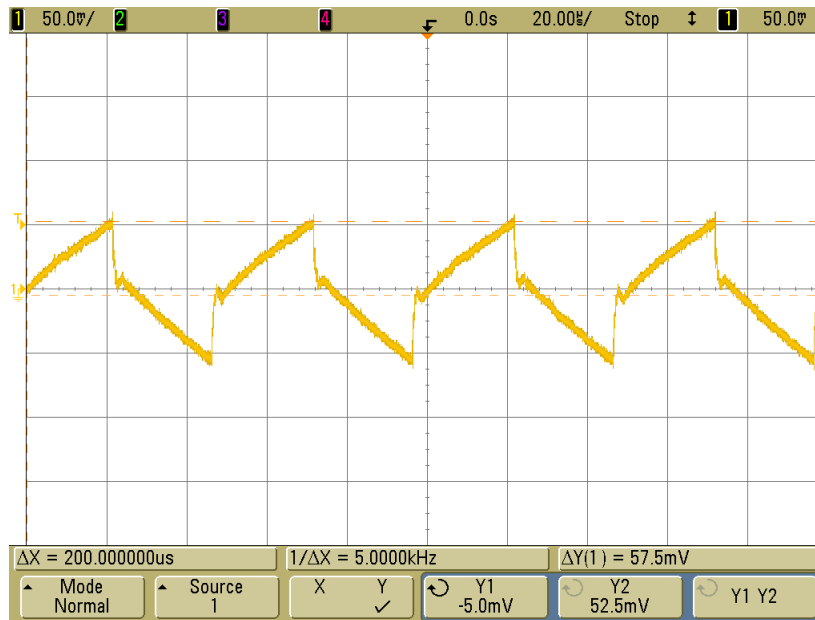

Figure 3-5. PVDD Variation With 600uF Bulk Capacitance

Figure 3-6 shows one more example, with the bulk capacitance reduced to 120uF. Now the voltage ripple increases to almost 500mV, and the shape is dominated by the charging and discharging of the capacitance, and the effect of the ESR is less evident.

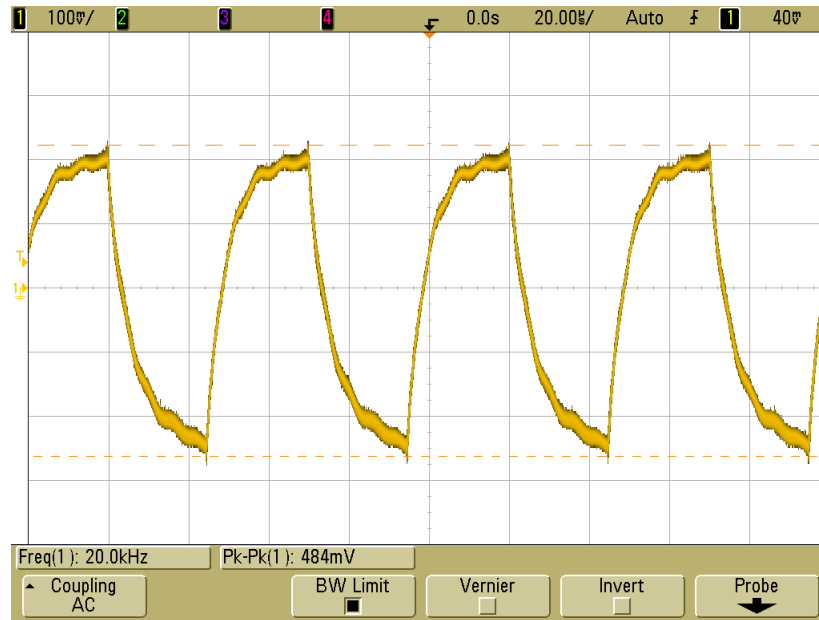

Figure 3-6. PVDD Variation With 120uF Bulk Capacitance

3.2 Revised Practical General Guidelines

Based on these real-world observations, we modify the *ideal* general guideline given previously to account for the non-ideal characteristics of the capacitor:

$$C_{BULK} > k \times \Delta I_{MOTOR} \times T_{PWM} / \Delta V_{SUPPLY} \quad (6)$$

Where:

C_{BULK} is the bulk capacitance

k is a scale factor to account for the ESR for typical capacitors in this type of application; based on the lab measurements above with DRV8718 EVM, k of about 3 is practical for these cases.

ΔI_{MOTOR} is the expected variation in motor current, $i_{max} - i_{min}$

T_{PWM} is the PWM period which is the reciprocal of the PWM frequency

ΔV_{SUPPLY} is the allowable variation in the motor supply voltage

[Figure 3-7](#) plots several data points and applies this general guideline, showing relatively good agreement.

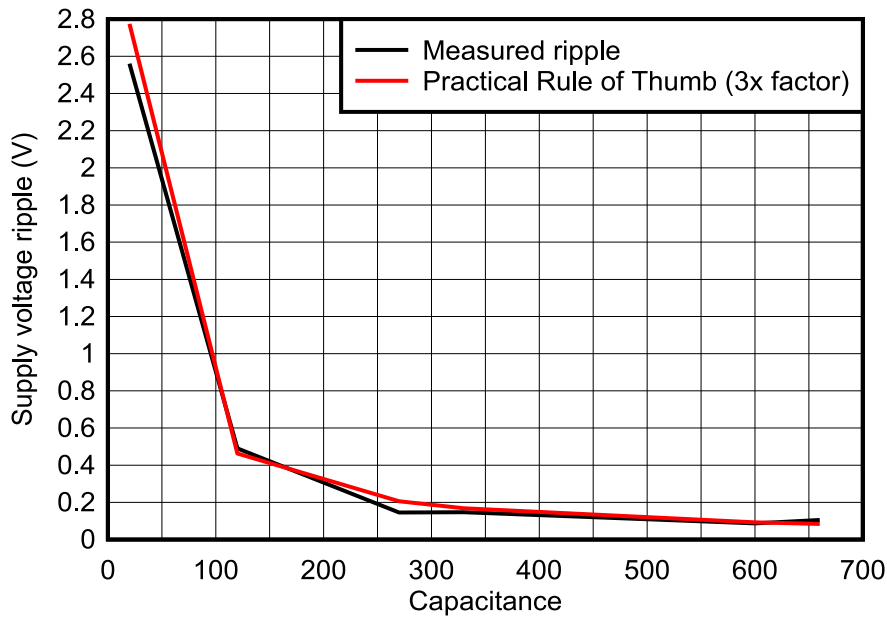

Figure 3-7. Measured Results and 3x General Guideline, Accounting for Real-World Non-Zero ESR Values of Electrolytic Capacitors

3.3 Other Considerations

The discussion has been simplified to allow rapid estimates of bulk capacitance. Several other factors affect the system performance and can be taken into account when selecting bulk capacitors for a motor drive design. These include:

Frequency response – Capacitor frequency response varies between types of capacitors and between capacitors with different values. Often, the recommendation is to provide more than one value of capacitor on the motor power supply. The larger value capacitors typically provide the best low-frequency response, while smaller value capacitors provide better high-frequency response.

Capacitor type – There is a wide variation of capacitor types; in general for the large values we discuss here, electrolytic capacitors are normally preferred. But even within electrolytic capacitors there are some chemistry enhancements which improve the durability and other characteristics of the component, including variation in ESR. For smaller values, ceramic capacitors can be preferred. Capacitor vendors have information on selection criteria for the vendors products.

PWM duty cycle – If the motor operates continuously without pulse-width modulation, many of the concerns with supply variation are less relevant. Conversely, if the duty cycle is about 50%, this is assumed to be the worst case conditions. Other cases, either very low duty cycle (for example, 10% on time) or very high duty cycle (for example, 90% on time) do not require the same level of bulk capacitance we have discussed.

4 Summary

In a real DC motor drive system, bulk capacitors are a common necessity. Although final system performance requires detailed analysis and practical testing, we can use rules-of-thumb and simple simulations to estimate the bulk capacitor sizing as a starting point.

5 References

- Texas Instruments, [Input and Output Capacitor Selection](#), application note.
- Texas Instruments, [Output Ripple Voltage for Buck Switching Regulator](#), application note.
- Texas Instruments, [Voltage Margin and Bulk Capacitance](#), training video.
- Electronics Stack Exchange, [Real World Brushed DC Motor Bulk Capacitance Calculations](#).

IMPORTANT NOTICE AND DISCLAIMER

TI PROVIDES TECHNICAL AND RELIABILITY DATA (INCLUDING DATA SHEETS), DESIGN RESOURCES (INCLUDING REFERENCE DESIGNS), APPLICATION OR OTHER DESIGN ADVICE, WEB TOOLS, SAFETY INFORMATION, AND OTHER RESOURCES "AS IS" AND WITH ALL FAULTS, AND DISCLAIMS ALL WARRANTIES, EXPRESS AND IMPLIED, INCLUDING WITHOUT LIMITATION ANY IMPLIED WARRANTIES OF MERCHANTABILITY, FITNESS FOR A PARTICULAR PURPOSE OR NON-INFRINGEMENT OF THIRD PARTY INTELLECTUAL PROPERTY RIGHTS.

These resources are intended for skilled developers designing with TI products. You are solely responsible for (1) selecting the appropriate TI products for your application, (2) designing, validating and testing your application, and (3) ensuring your application meets applicable standards, and any other safety, security, regulatory or other requirements.

These resources are subject to change without notice. TI grants you permission to use these resources only for development of an application that uses the TI products described in the resource. Other reproduction and display of these resources is prohibited. No license is granted to any other TI intellectual property right or to any third party intellectual property right. TI disclaims responsibility for, and you will fully indemnify TI and its representatives against, any claims, damages, costs, losses, and liabilities arising out of your use of these resources.

TI's products are provided subject to [TI's Terms of Sale](#) or other applicable terms available either on [ti.com](https://www.ti.com) or provided in conjunction with such TI products. TI's provision of these resources does not expand or otherwise alter TI's applicable warranties or warranty disclaimers for TI products.

TI objects to and rejects any additional or different terms you may have proposed.

Mailing Address: Texas Instruments, Post Office Box 655303, Dallas, Texas 75265
Copyright © 2024, Texas Instruments Incorporated