

TPS7H2221-SEP Radiation Tolerant 5.5-V, 1.25-A, 115-mΩ Load Switch

1 Features

- [Vendor item drawing available, VID V62/22609](#)
- [Total ionizing dose \(TID\) characterized to 30 krad\(Si\)](#)
 - TID RLAT (radiation lot acceptance testing) for every wafer lot to 20 krad(Si)
- [Single-event effects \(SEE\) characterized](#)
 - Single-event latch-up (SEL), single-event burnout (SEB) and single-event gate rupture (SEGR) immune to effective linear energy transfer (LET_{EFF}) of 43 MeV– cm²/mg.
 - Single-event transient (SET) and single-event functional interrupt (SEFI) characterized to LET_{EFF} of 43 MeV– cm²/mg.
- Input operating voltage range (V_{IN}): 1.6 to 5.5 V
- Recommended continuous current (I_{MAX}): 1.25 A
- On-resistance (R_{ON}):
 - 116 mΩ (typ.) at V_{IN} = 5 V
 - 115 mΩ (typ.) at V_{IN} = 3.3 V
 - 133 mΩ (typ.) at V_{IN} = 1.8 V
- Output short protection (I_{SC}): 3 A (typ.)
- Low power consumption:
 - ON state (I_Q): 8.3 μA (typ.)
 - OFF state (I_{SD}): 3 nA (typ.)
- Slow turn ON timing to limit inrush current (t_{ON}):
 - t_{ON} at 5 V = 1.68 ms at 3.61 mV/μs
 - t_{ON} at 3.3 V = 1.51 ms at 2.91 mV/μs
 - t_{ON} at 1.8 V = 1.32 ms at 2.15 mV/μs
- Adjustable output discharge and fall time:
 - Internal QOD resistance = 9.2 Ω (typ.) at V_{IN} = 3.3 V
- Space Enhanced Plastic (SEP)
 - Controlled baseline
 - Gold bondwire
 - NiPdAu lead finish
 - One assembly and test site
 - One fabrication site
 - Military (–55°C to 125°C) temperature range
 - Extended product life cycle
 - Extended product-change notification (PCN)
 - Product traceability
 - Enhance mold compound for low outgassing

2 Applications

- Space satellite power management and distribution
- Radiation tolerant power tree applications
- Enables switching power rails for controller power up and power down
- [Satellite electrical power systems \(EPS\)](#)

3 Description

The TPS7H2221-SEP device is a small, single channel load switch with controlled slew rate. The device contains an N-channel MOSFET that can operate over an input voltage range of 1.6 V to 5.5 V and can support a maximum continuous current of 1.25 A.

The switch ON state is controlled by a digital input that is capable of interfacing directly with low-voltage control signals. When power is first applied, a Smart Pull Down is used to keep the ON pin from floating until system sequencing is complete. Once the pin is deliberately driven high (V_{ON} > V_{IH}), the Smart Pull Down will be disconnected to prevent unnecessary power loss.

The TPS7H2221-SEP load switch is also self-protected, meaning that it protects against short circuit events on the output of the device.

The TPS7H2221-SEP is available in a standard SC-70 package characterized for operation over an ambient temperature range of –55°C to 125°C.

PART NUMBER ⁽¹⁾	GRADE	PACKAGE ⁽²⁾
TPS7H2221MDCKTSEP	20 krad(Si) RLAT, 30 krad(Si) characterized	SC-70 (6) 2.10 mm × 2.00 mm Mass = 6.9 mg
TPS7H2221EVM	Evaluation board	EVM

- (1) For all available packages, see the orderable addendum at the end of the data sheet.
- (2) Dimensions and mass are nominal values.

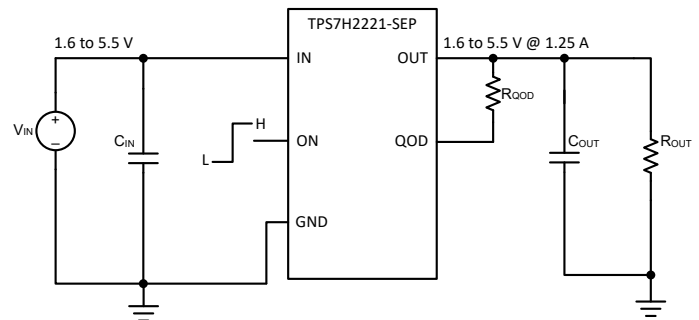

Typical Application Schematic



Table of Contents

1 Features	1	8.3 Feature Description.....	15
2 Applications	1	8.4 Device Functional Modes.....	16
3 Description	1	9 Application and Implementation	17
4 Revision History	2	9.1 Application Information.....	17
5 Pin Configuration and Functions	3	9.2 Typical Application	17
6 Specifications	4	9.3 Application Curves.....	19
6.1 Absolute Maximum Ratings.....	4	9.4 Power Supply Recommendations.....	20
6.2 ESD Ratings.....	4	9.5 Layout.....	20
6.3 Recommended Operating Conditions.....	4	10 Device and Documentation Support	21
6.4 Thermal Information.....	4	10.1 Related Documentation.....	21
6.5 Electrical Characteristics.....	4	10.2 Receiving Notification of Documentation Updates.....	21
6.6 Switching Characteristics.....	6	10.3 Support Resources.....	21
6.7 Derating Curves.....	6	10.4 Electrostatic Discharge Caution.....	21
6.8 Typical Characteristics	8	10.5 Glossary.....	21
7 Parameter Measurement Information	13	10.6 Export Control Notice.....	21
7.1 Test Circuit and Timing Waveforms Diagrams.....	13	10.7 Third-Party Products Disclaimer.....	21
8 Detailed Description	14	11 Mechanical, Packaging, and Orderable Information	22
8.1 Overview.....	14		
8.2 Functional Block Diagram.....	14		

4 Revision History

NOTE: Page numbers for previous revisions may differ from page numbers in the current version.

Changes from Revision * (August 2022) to Revision A (September 2022)	Page
• Updated marketing status from Advance Information to Initial Release.....	1
• Added links for VID data sheet, TID, SEE report. Updated the typical values for t_{ON} at different V_{IN} and $R_{PD,QOD}$	1
• Added $R_{PD,QOD}$ typical values for $V_{IN}= 1.8\text{ V}$, 3.3 V and 5 V	4
• Added t_{FALL} with $R_{OUT}=\text{Open}$, $C_{OUT}=10\text{ }\mu\text{F}$, $R_{QOD}=100\text{ }\Omega$, $R_{OUT}=\text{Open}$, $C_{OUT}=100\text{ }\mu\text{F}$ and $R_{QOD}=0\text{ }\Omega$	4
• Added links to related documentation.....	21

5 Pin Configuration and Functions

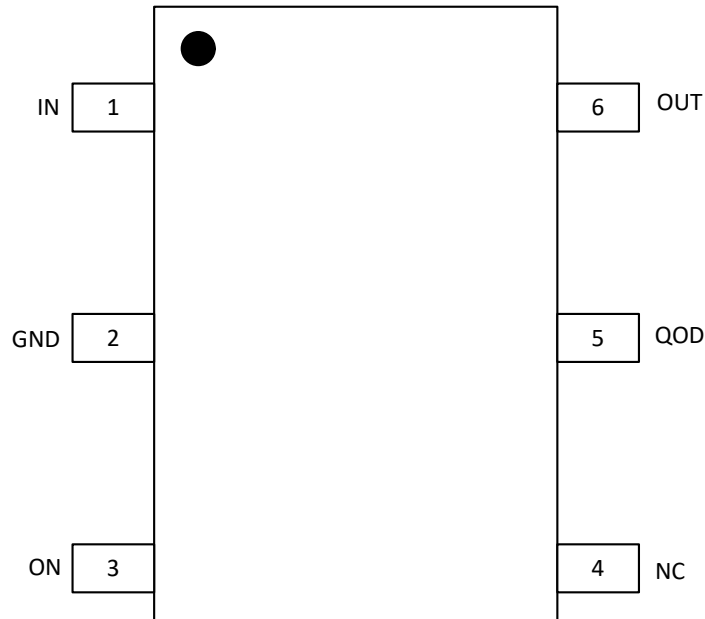

**Figure 5-1. DCK Package
6-Pin SC-70
(Top View)**

Table 5-1. Pin Functions

PIN		I/O ⁽¹⁾	DESCRIPTION
NO.	NAME		
1	IN	I	Switch input.
2	GND	—	Device ground.
3	ON	I	Active high switch control input. Do not leave floating.
4	NC	—	No connect. This pin is not internally connected. It is recommended to connect this pin to GND to prevent charge buildup; however, this pin can also be left open or tied to any voltage between GND and IN.
5	QOD	O	Quick Output Discharge pin. This pin can be utilized in one of three ways: <ul style="list-style-type: none"> Placing an external resistor between V_{OUT} and QOD Tying QOD directly to V_{OUT} and using the internal resistor value (R_{PD}) Disabling QOD by leaving pin floating See the Fall Time (t_{FALL}) and Quick Output Discharge (QOD) section for more information.
6	OUT	O	Switch output.

(1) I = Input, O = Output, — = Other

6 Specifications

6.1 Absolute Maximum Ratings

Over operating free-air temperature range (unless otherwise noted)⁽¹⁾

		MIN	MAX	UNIT
V _{IN}	Maximum Input Voltage Range (IN to GND)	-0.3	6	V
V _{OUT}	Maximum Output Voltage Range (OUT to GND)	-0.3	6	V
V _{ON}	Maximum ON Pin Voltage Range (ON to GND)	-0.3	6	V
V _{QOD}	Maximum QOD Pin Voltage Range (QOD to GND)	-0.3	6	V
I _{MAX}	Maximum Continuous Current		1.5	A
I _{PLS}	Maximum Pulsed Current (ts=2 ms, 2% Duty Cycle)		2.5	A
T _J	Junction temperature	-55	150	°C
T _{STG}	Storage temperature	-65	150	°C

- (1) Operation outside the Absolute Maximum Ratings may cause permanent device damage. Absolute Maximum Ratings do not imply functional operation of the device at these or any other conditions beyond those listed under Recommended Operating Conditions. If used outside the Recommended Operating Conditions but within the Absolute Maximum Ratings, the device may not be fully functional, and this may affect device reliability, functionality, performance, and shorten the device lifetime.

6.2 ESD Ratings

			VALUE	UNIT
V _(ESD)	Electrostatic discharge	Human body model (HBM), per ANSI/ESDA/JEDEC JS-001 ⁽¹⁾	±2000	V
		Charged device model (CDM), per per ANSI/ESDA/JEDEC JS-002 ⁽²⁾	±1000	

- (1) JEDEC document JEP155 states that 500-V HBM allows safe manufacturing with a standard ESD control process.
 (2) JEDEC document JEP157 states that 250-V CDM allows safe manufacturing with a standard ESD control process.

6.3 Recommended Operating Conditions

over operating free-air temperature range (unless otherwise noted)

		MIN	TYP	MAX	UNIT
V _{IN}	Input Voltage Range (IN to GND)	1.6		5.5	V
V _{OUT}	Output Voltage Range (OUT to GND)	0		5.5	
V _{ON}	ON Voltage Range (ON to GND)	0		5.5	
I _{MAX}	Maximum Continuous Current	0		1.25	A
T _J	Junction temperature	-55		125	°C

6.4 Thermal Information

THERMAL METRIC ⁽¹⁾		TPS7H2221-SEP	UNIT
		DCK (SC-70)	
		6 PINS	
R _{θJA}	Junction-to-ambient thermal resistance	237.7	°C/W
R _{θJC(top)}	Junction-to-case (top) thermal resistance	173.7	
R _{θJB}	Junction-to-board thermal resistance	93.9	
Ψ _{JT}	Junction-to-top characterization parameter	74.4	
Ψ _{JB}	Junction-to-board characterization parameter	93.6	

- (1) For more information about traditional and new thermal metrics, see the [Semiconductor and IC Package Thermal Metrics](#) application report.

6.5 Electrical Characteristics

Over $V_{IN} = 1.6$ to 5.5 -V, $V_{ON} \geq V_{IH}$, over the temperature range ($T_A = -55$ °C to 125 °C), unless otherwise specified. All voltage levels are reference to GND.

PARAMETER		TEST CONDITIONS		MIN	TYP	MAX	UNIT
Input Supply (VIN)							
$I_{Q, VIN}$	V_{IN} Quiescent Current	$V_{OUT} = \text{Open}$,	25 °C	8.3	15		μA
		$V_{OUT} = \text{Open}$,		8.7	20		
$I_{SD, VIN}$	V_{IN} Shutdown Current	$V_{ON} \leq V_{IL}$, $V_{OUT} = \text{GND}$	25 °C	3	20		nA
		$V_{ON} \leq V_{IL}$, $V_{OUT} = \text{GND}$			800		
ON-Resistance (RON)							
R_{ON}	ON-State Resistance	$V_{IN} = 5$ V, $I_{OUT} = -200$ mA	-55 °C	90	150		m Ω
			25 °C	116	150		
			125 °C	150	200		
		$V_{IN} = 3.3$ V, $I_{OUT} = -200$ mA	-55 °C	89	150		m Ω
			25 °C	115	150		
			125 °C	150	250		
		$V_{IN} = 1.8$ V, $I_{OUT} = -200$ mA	-55 °C	103	300		m Ω
			25 °C	133	300		
			125 °C	173	350		
Output Short Protection (ISC)							
I_{SC}	Short Circuit Current Limit	$V_{OUT} \leq V_{IN} - 1.5$ V		3			A
		$V_{OUT} \leq V_{SC}$		30	512	900	mA
V_{SC}	Output Short Detection Threshold	25 °C		0.22	0.36	0.57	V
T_{SD}	Thermal Shutdown	Rising		180			°C
		Falling		145			
Enable Pin (ON)							
I_{ON}	ON Pin Leakage	$V_{ON} \geq V_{IH}$				100	nA
$R_{PD, ON}$	Smart Pull Down Resistance	$V_{ON} \leq V_{IL}$				499	k Ω
$V_{IH, ON}$	ON Pin Input High (V_{IH} Rising)			1			V
$V_{IL, ON}$	ON Pin Input Low (V_{IL} Falling)					0.35	
Quick-output Discharge (QOD)							
$R_{PD, QOD}$	QOD Pin Internal Discharge Resistance	$V_{ON} \leq V_{IL}$	$V_{IN} = 1.8$ -V	45.4			Ω
			$V_{IN} = 3.3$ -V	8.5			
			$V_{IN} = 5$ -V	6			

6.6 Switching Characteristics

Unless otherwise noted, the typical characteristics in the following table apply to an input voltage of 3.3V, an ambient temperature of 25°C, $R_{QOD} = 0 \Omega$ and a load of $C_{OUT} = 0.1 \mu F$, $R_{OUT} = 100 \Omega$. See [Figure 7-2](#)

PARAMETER		TEST CONDITIONS		MIN	TYP	MAX	UNIT
t_{ON}	Turn ON Time	$V_{IN} = 5.0 V$			1680		μs
		$V_{IN} = 3.3 V$			1510		
		$V_{IN} = 1.8 V$			1320		
t_R	Output Rise Time	$V_{IN} = 5.0 V$			1120		μs
		$V_{IN} = 3.3 V$			915		
		$V_{IN} = 1.8 V$			674		
SR_{ON}	Turn ON Slew Rate	$V_{IN} = 5.0 V$			3.61		mV/ μs
		$V_{IN} = 3.3 V$			2.91		
		$V_{IN} = 1.8 V$			2.15		
t_{OFF}	Turn OFF Time	$V_{IN} = 1.8 V$ to $5.0V$		$R_{OUT} = 100\Omega$, $C_{OUT} = 0.1\mu F$	5.22		μs
t_{FALL}	Output Fall Time ⁽¹⁾	$R_{OUT} = \text{Open}$ ⁽²⁾			9.6		μs
				$C_{OUT} = 10\mu F$, $R_{QOD} = 0 \Omega$	0.35		ms
				$C_{OUT} = 10\mu F$, $R_{QOD} = 100 \Omega$	3.12		ms
				$C_{OUT} = 100\mu F$; $R_{QOD} = 0 \Omega$	4.3		ms

(1) Output may not discharge completely if QOD is not connected to V_{OUT}

(2) See the *Timing Application* section for information on how R_{OUT} and C_{OUT} affect Fall Time.

6.7 Derating Curves

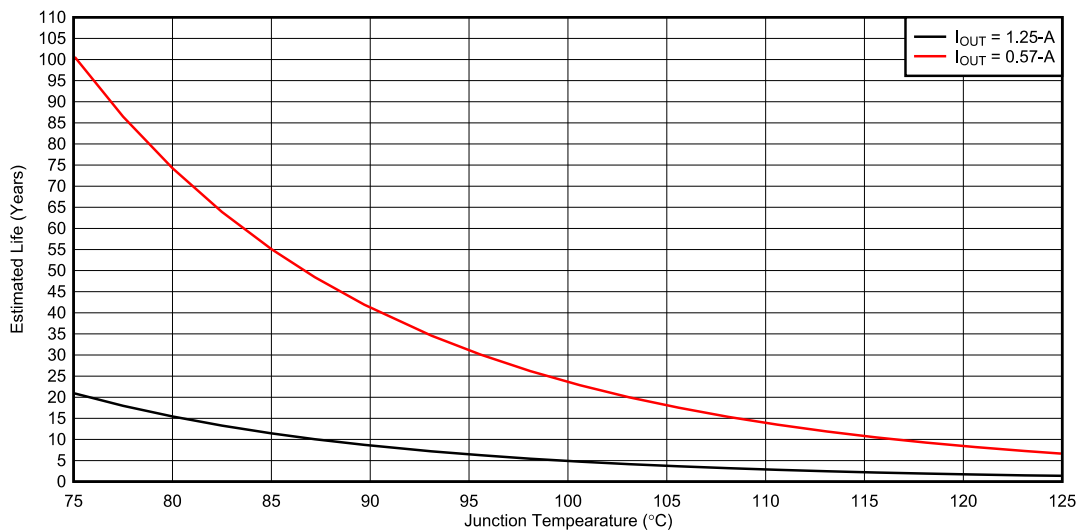

FIT = 50

Figure 6-1. Estimated Life Rating Due to Electromigration vs Junction Temperature at 50% Duty Cycle

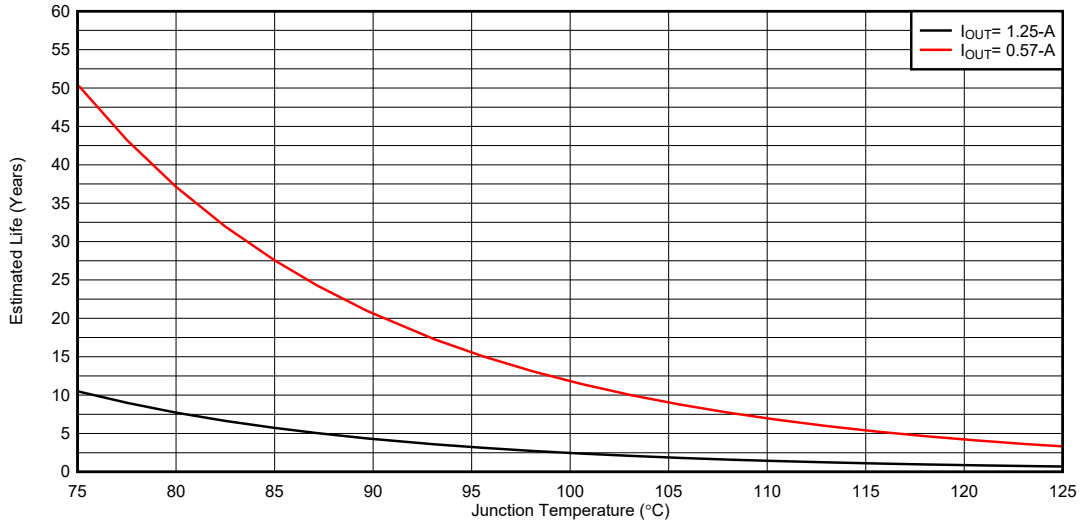

FIT=50

Figure 6-2. Estimated Life Rating Due to Electromigration vs Junction Temperature at 100% Duty Cycle

6.8 Typical Characteristics

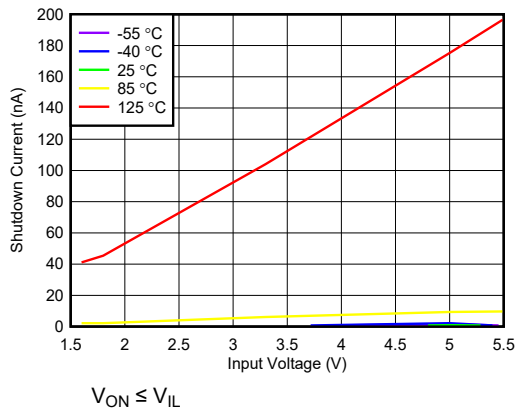

Figure 6-3. Shutdown Current vs Input Voltage

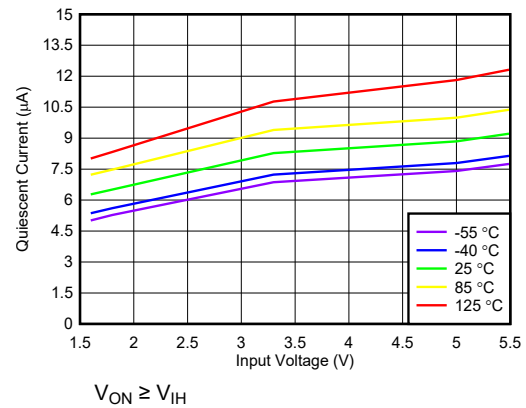

Figure 6-4. Quiescent Current vs Input Voltage

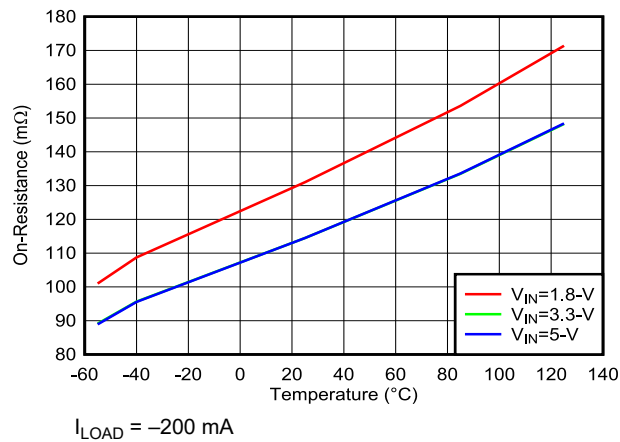

Figure 6-5. On-Resistance vs Junction Temperature

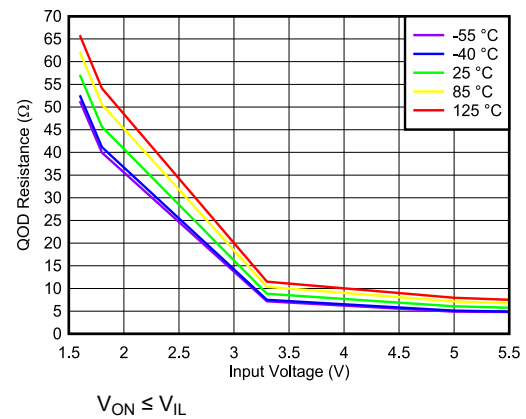

Figure 6-6. QOD Resistance vs Input Voltage

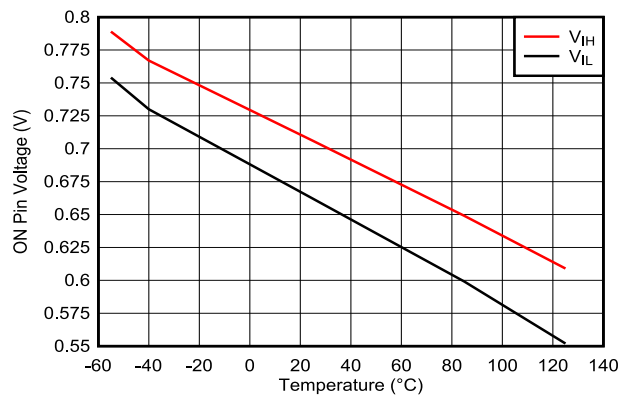

Figure 6-7. V_{IH}/V_{IL} vs Junction Temperature

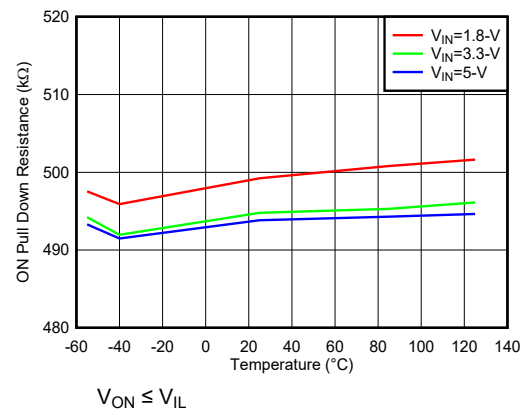
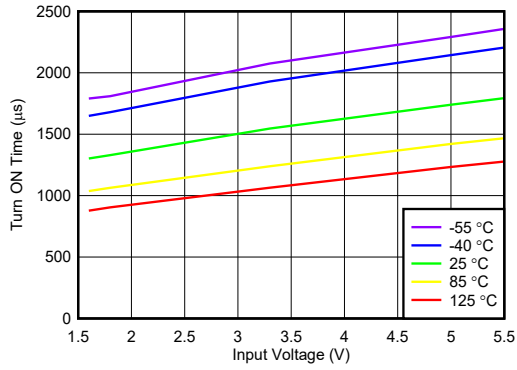
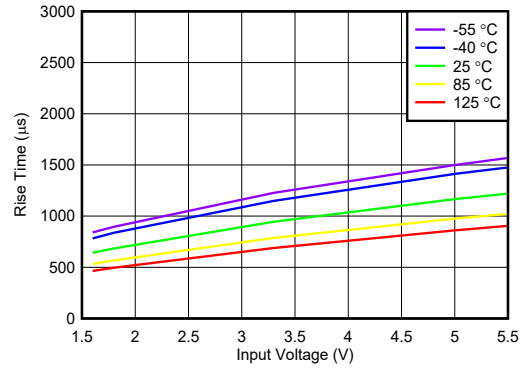

Figure 6-8. ON Pull Down Resistance vs Junction Temperature



$C_{OUT} = 0.1 \mu F$ $R_{OUT} = 100 \Omega$ $R_{QOD} = 0 \Omega$

Figure 6-9. Turn ON Time vs Input Voltage



$C_{OUT} = 0.1 \mu F$ $R_{OUT} = 100 \Omega$ $R_{QOD} = 0 \Omega$

Figure 6-10. Rise Time vs Input Voltage

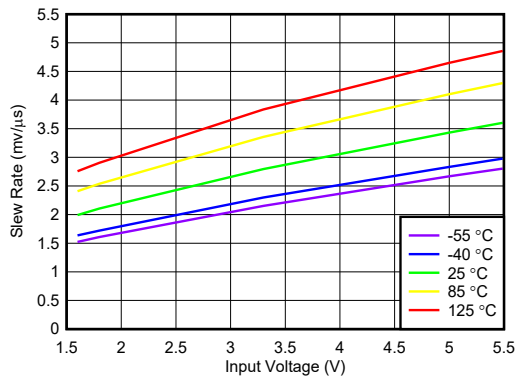

$C_{OUT} = 0.1 \mu F$ $R_{OUT} = 100 \Omega$ $R_{QOD} = 0 \Omega$

Figure 6-11. Output Slew Rate vs Input Voltage

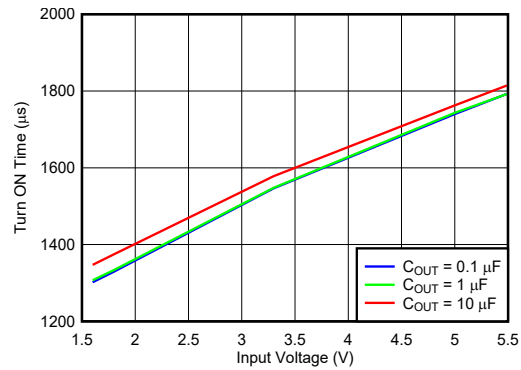

$R_{OUT} = 100 \Omega$ $T_J = 25^\circ C$ $R_{QOD} = 0 \Omega$

Figure 6-12. Turn ON Time vs Input Voltage Across Load Capacitance

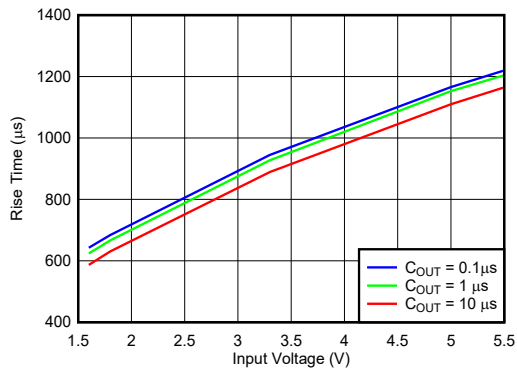

$R_{OUT} = 100 \Omega$ $T_J = 25^\circ C$ $R_{QOD} = 0 \Omega$

Figure 6-13. Rise Time vs Input Voltage Across Load Capacitance

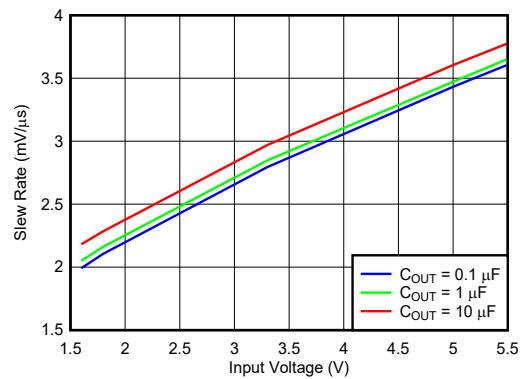

$R_{OUT} = 100 \Omega$ $T_J = 25^\circ C$ $R_{QOD} = 0 \Omega$

Figure 6-14. Slew Rate vs Input Voltage Across Load Capacitance

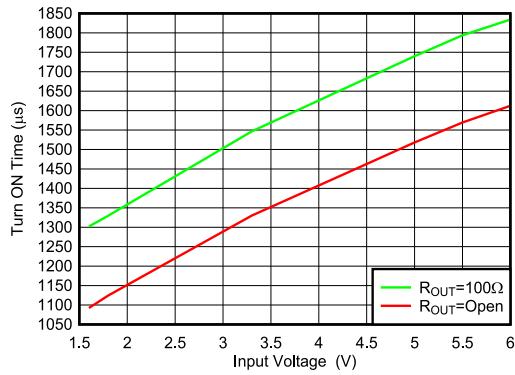

$C_{OUT} = 0.1 \mu F$ $T_J = 25^\circ C$ $R_{QOD} = 0 \Omega$

Figure 6-15. Turn ON Time vs Input Voltage Across Load Resistance

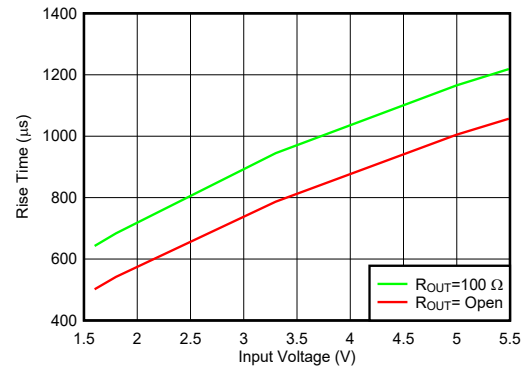

$C_{OUT} = 0.1 \mu F$ $T_J = 25^\circ C$ $R_{QOD} = 0 \Omega$

Figure 6-16. Rise Time vs Input Voltage Across Load Resistance

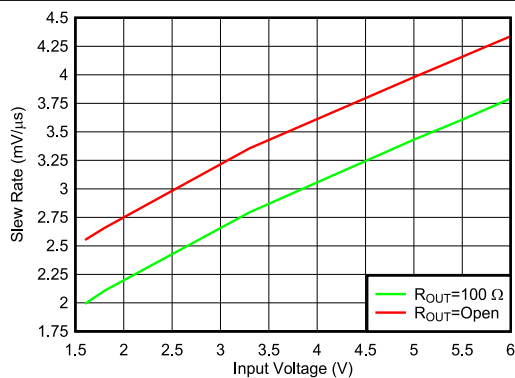

$C_{OUT} = 0.1 \mu F$ $T_J = 25^\circ C$ $R_{QOD} = 0 \Omega$

Figure 6-17. Output Slew Rate vs Input Voltage Across Load Resistance

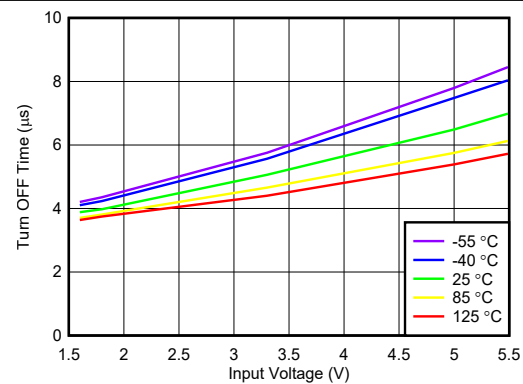

$C_{OUT} = 0.1 \mu F$ $R_{OUT} = 100 \Omega$ $R_{QOD} = 0 \Omega$

Figure 6-18. Turn OFF Time vs Input Voltage

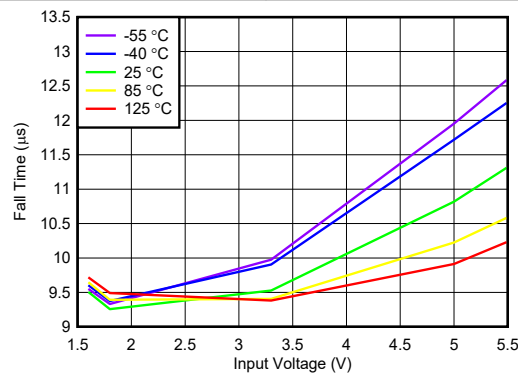

$C_{OUT} = 0.1 \mu F$

$R_{OUT} = 100 \Omega$

$R_{QOD} = 0 \Omega$

Figure 6-19. Fall Time vs Input Voltage

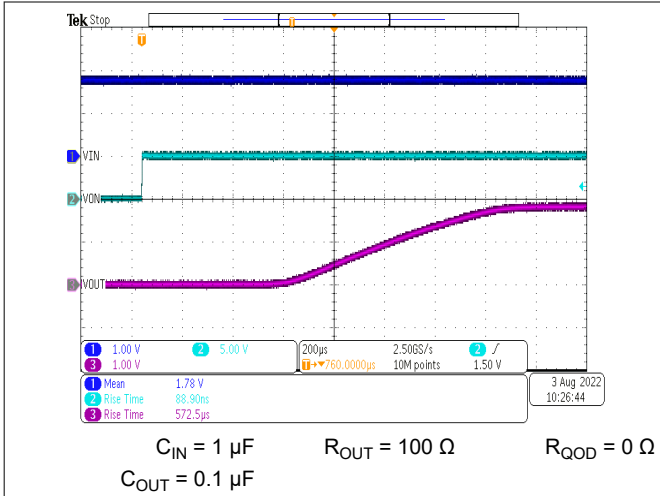

Figure 6-20. Rise Time with $V_{IN} = 1.8 V$

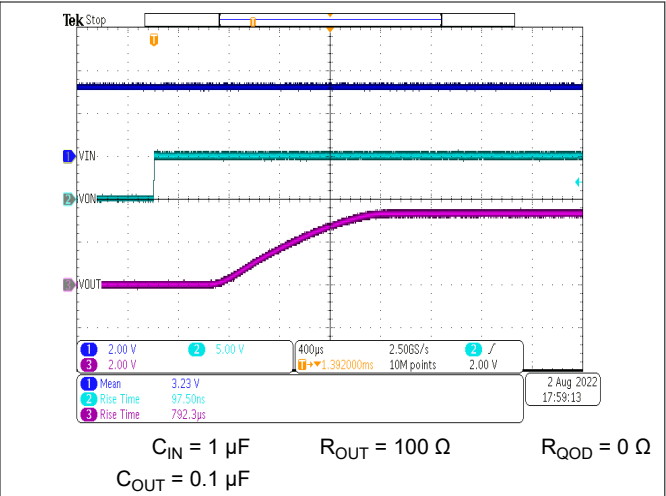

Figure 6-21. Rise Time with $V_{IN} = 3.3 V$

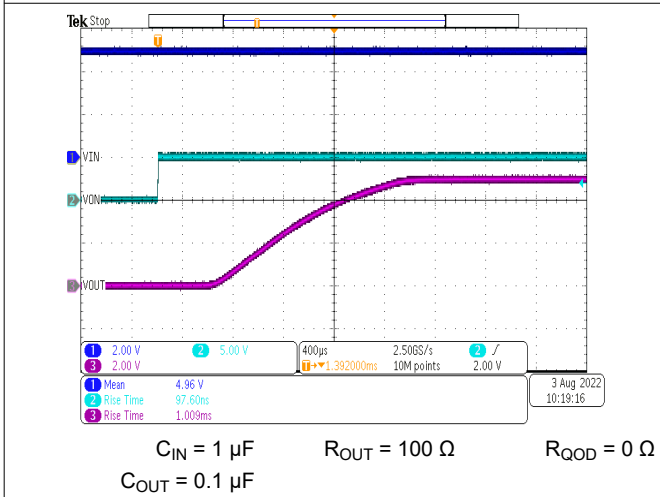

Figure 6-22. Rise Time with $V_{IN} = 5 V$

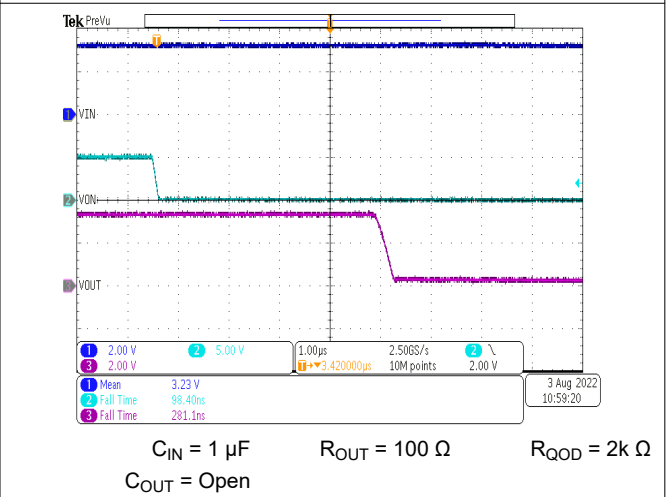

Figure 6-23. Turn Off with a Small Load Capacitance

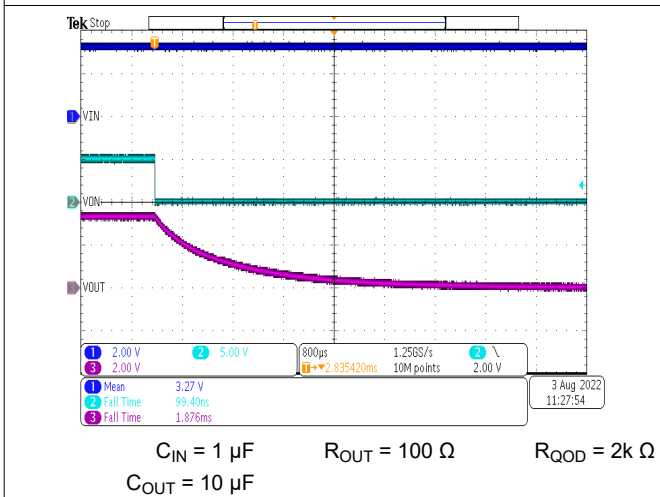

Figure 6-24. Turn Off with a Large Load Capacitance

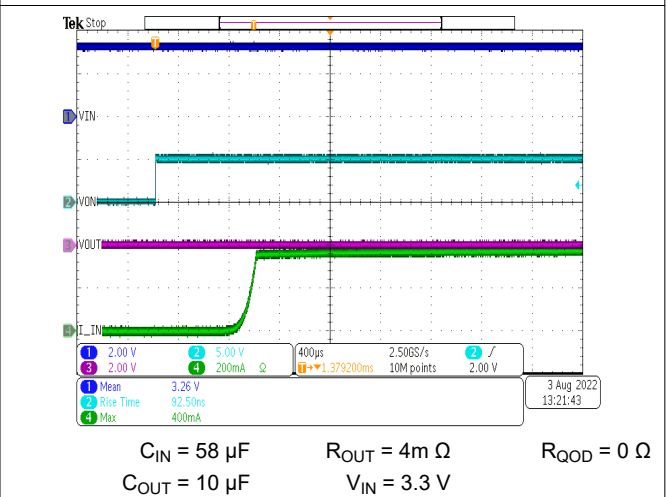
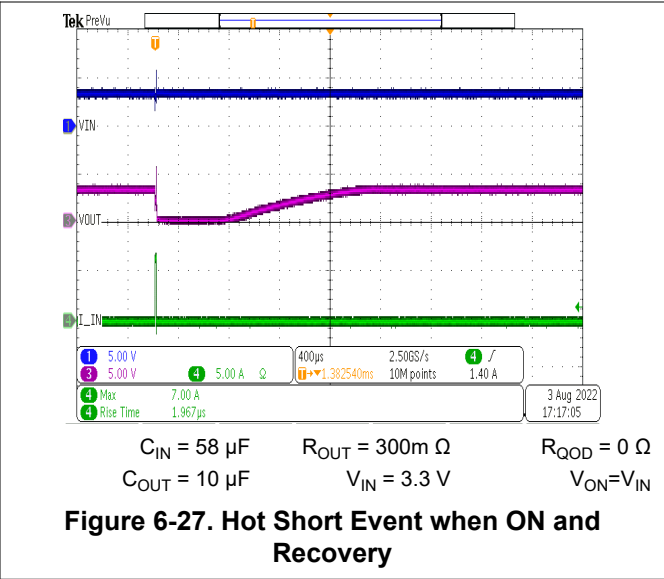
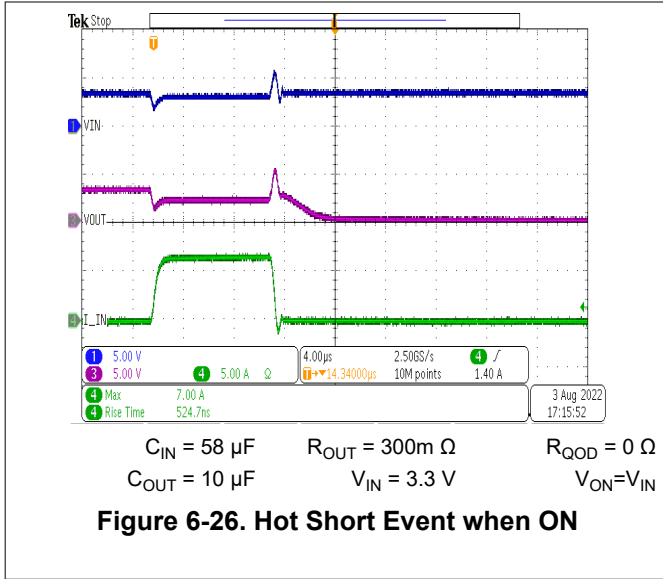
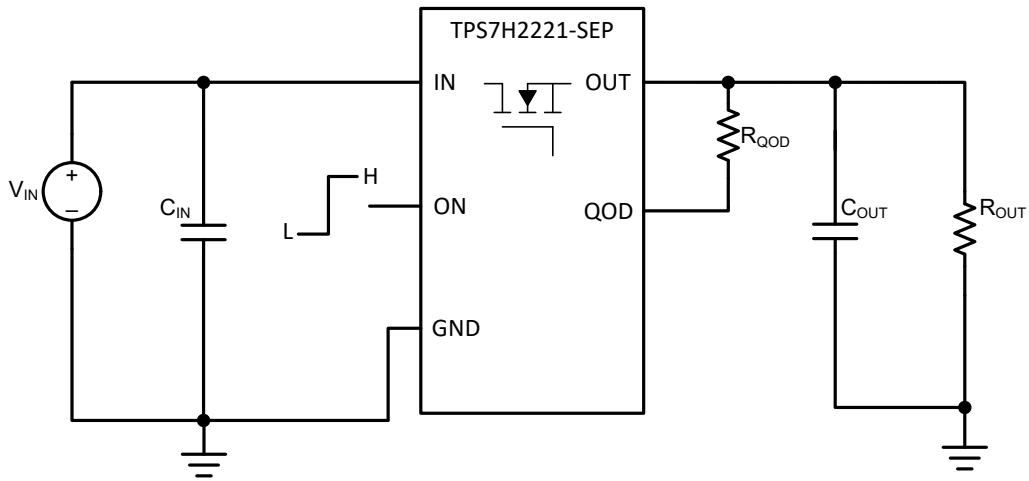

Figure 6-25. Turn On Into an Output Short



7 Parameter Measurement Information

7.1 Test Circuit and Timing Waveforms Diagrams



- A. Rise and fall times of the control signal are 100 ns.
- B. Turn-off times and fall times are dependent on the time constant at the load. For the TPS7H2221-SEP, the internal pull-down resistance QOD is enabled when the switch is disabled. When QOD is connected to OUT using a resistor (R_{QOD}), the time constant is $(R_{QOD} + R_{PD,QOD} || R_{OUT}) \times C_{OUT}$.

Figure 7-1. Test Circuit

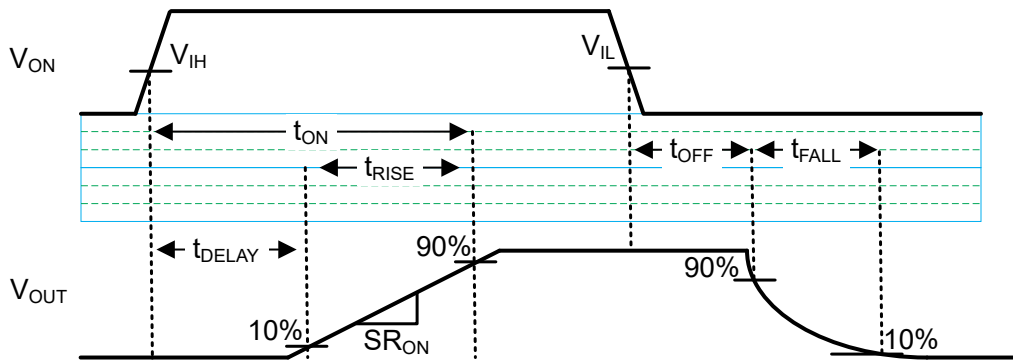

Figure 7-2. Timing Waveforms

8 Detailed Description

8.1 Overview

The TPS7H2221-SEP device is a 5.5-V, 1.25-A load switch in a 6-pin SOT-23 package. To reduce voltage drop for low voltage and high current rails, the device implements a low resistance N-channel MOSFET that reduces the drop out voltage across the device.

The TPS7H2221-SEP device has a slow slew rate, which helps reduce or eliminate power supply droop because of large inrush currents during power up. Furthermore, the device features a Quick-Output-Discharge (QOD) pin, which allows the configuration of the discharge rate of V_{OUT} once the switch is disabled. During shutdown, the device has very low leakage currents, thereby reducing unnecessary leakages for downstream devices during standby. Integrated control logic, driver, charge pump, and output discharge FET eliminates the need for any external components, which reduces solution size and bill of materials (BOM) count.

The TPS7H2221-SEP load switch is also self-protected, meaning that it will protect from short circuit events on the output of the device. It also has thermal shutdown to prevent thermal runaway.

8.2 Functional Block Diagram

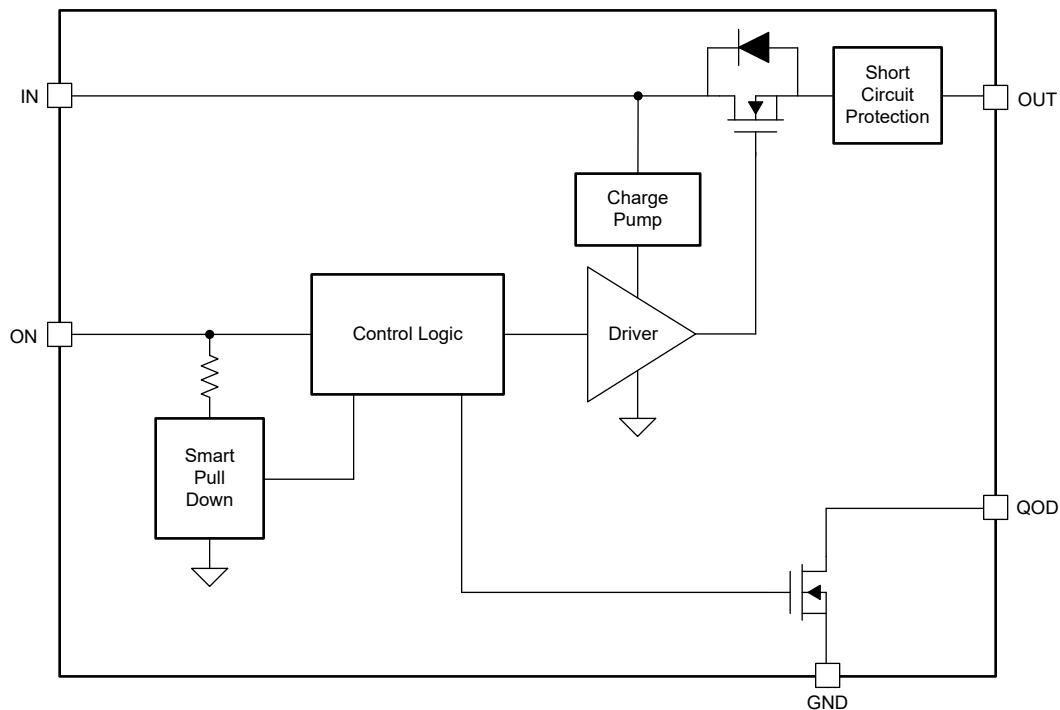

8.3 Feature Description

Table 8-1. Smart-ON Pull Down

VON	PULL DOWN
$\leq V_{IL,ON}$	Connected
$\geq V_{IH,ON}$	Disconnected

8.3.1 On and Off Control

The ON pin controls the state of the switch. The ON pin is compatible with standard CMOS logic threshold so it can be used in a wide variety of applications. When power is first applied to V_{IN} a Smart Pull Down is used to keep the ON pin from floating until the system sequencing is complete. Once the ON pin is deliberately driven high ($\geq V_{IH,ON}$), the Smart Pull Down is disconnected to prevent unnecessary power loss. See Table 8-1 to determine the state of the ON Pin Smart Pull Down state as function of ON pin voltage.

8.3.2 Output Short Circuit Protection (I_{SC})

The device will limit current to the output in case of output shorts. When a short occurs, the large V_{IN} to V_{OUT} voltage drop causes the switch to limit the output current (I_{SC}). When the output is below the hard short threshold (V_{SC}), a lower limit is used to minimize the power dissipation while the fault is present. The device will continue to limit the current until it reaches thermal shutdown temperature. At this time, the device will turn off until its temperature has lowered by the thermal hysteresis (35°C typical) before turning on again.

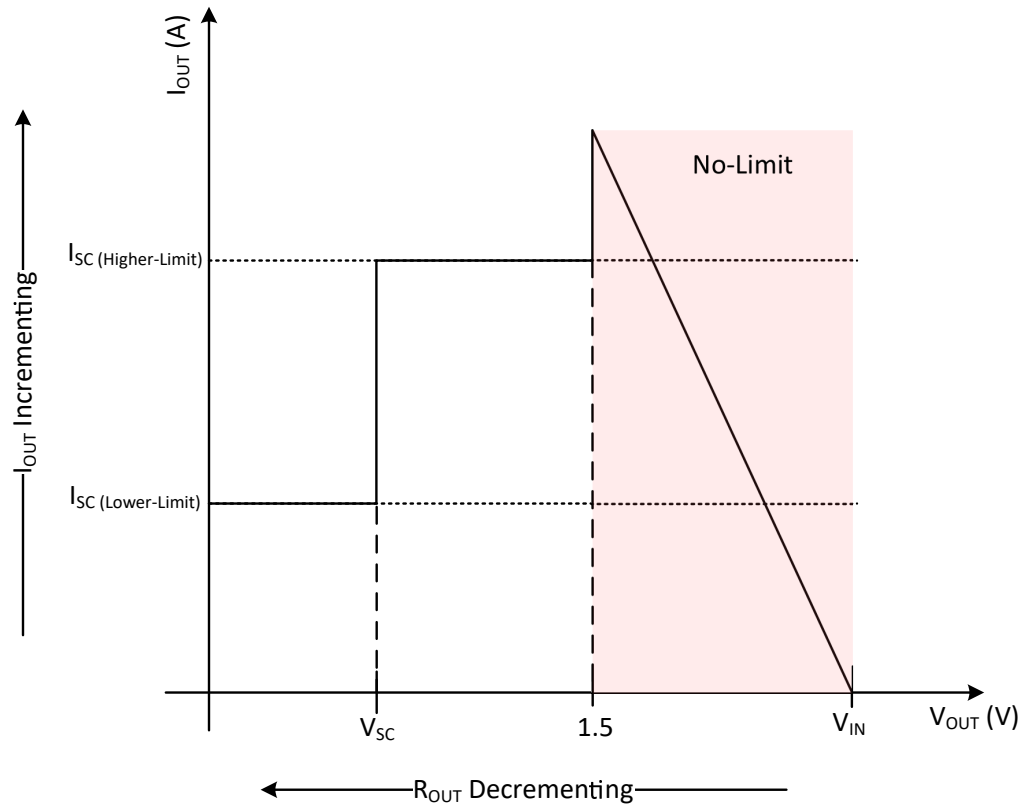

Figure 8-1. Output Short Circuit Current Limit

8.3.3 Fall Time (t_{FALL}) and Quick Output Discharge (QOD)

The TPS7H2221-SEP device includes a QOD pin that can be configured in one of three ways:

- QOD pin shorted to V_{OUT} pin. Using this method, after the switch becomes disabled the discharge rate is controlled with the value of the internal resistance QOD ($R_{PD,QOD}$).
- QOD pin connected to V_{OUT} pin using an external resistor R_{QOD} . After the switch becomes disabled, the discharge rate is controlled by the value of the total discharge resistance. To adjust the total discharge resistance, [Equation 1](#) can be used:

$$R_{DIS} = R_{PD,QOD} + R_{QOD} \quad (1)$$

where:

- R_{DIS} is the total output discharge resistance (Ω)
- $R_{PD,QOD}$ (6 Ω typ.) is the internal pulldown resistance (Ω)
- R_{QOD} is the external resistance placed between the V_{OUT} and QOD pins (Ω)
- QOD pin is unused and left floating. Using this method, there will be no quick output discharge functionality and the output will remain floating after the switch is disabled.

The fall times of the device depend on many factors including the total discharge resistance (R_{DIS}) and the output capacitance (C_{OUT}). To calculate the approximate fall time of V_{OUT} use [Equation 2](#).

$$t_{FALL} = 2.2 \times (R_{DIS} \parallel R_{OUT}) \times C_{OUT} \quad (2)$$

where:

- t_{FALL} is the output fall time from 90% to 10% (μ s)
- R_{DIS} is the total QOD + R_{QOD} resistance (Ω)
- R_{OUT} is the output load resistance (Ω)
- C_{OUT} is the output load capacitance (μ F)

8.3.3.1 QOD When System Power is Removed

The adjustable QOD can be used to control the power down sequencing of a system even when the system power supply is removed. When the power is removed, the input capacitor discharges at V_{IN} . Past a certain V_{IN} level, the strength of the R_{PD} will be reduced. If there is still remaining charge on the output capacitor, this will result in longer fall times. For further information regarding this condition, see the [Setting Fall Time for Shutdown Power Sequencing](#) section.

8.4 Device Functional Modes

[Table 8-2](#) describes the connection of the V_{OUT} pin depending on the logical state of the ON pin as well as the various QOD pin configurations.

Table 8-2. V_{OUT} Connection

ON	QOD CONFIGURATION	V_{OUT}
Low	QOD pin connected to VOUT with R_{QOD}	Pull-down with ($R_{PD,QOD} + R_{QOD}$)
Low	QOD pin tied to VOUT directly	Pull-down with ($R_{PD,QOD}$)
Low	QOD pin left open	Floating
High	N/A	V_{IN}

9 Application and Implementation

Note

Information in the following applications sections is not part of the TI component specification, and TI does not warrant its accuracy or completeness. TI's customers are responsible for determining suitability of components for their purposes. Customers should validate and test their design implementation to confirm system functionality.

9.1 Application Information

This section highlights some of the design considerations when implementing this device in various applications.

9.2 Typical Application

This typical application demonstrates how the TPS7H2221-SEP devices can be used to power downstream modules.

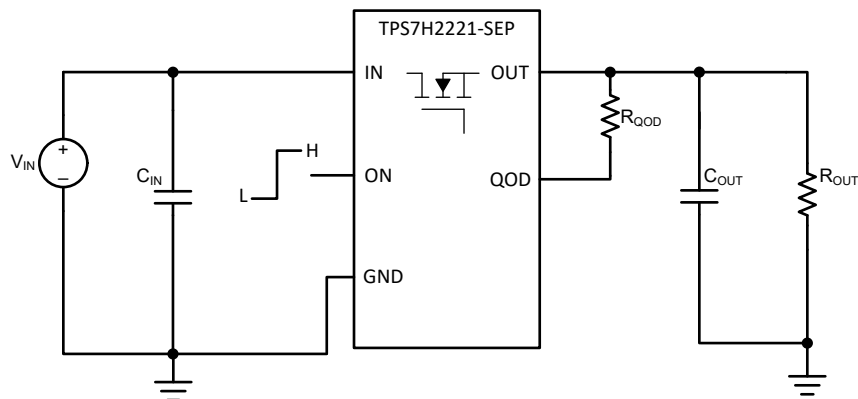

Figure 9-1. Typical Application Schematic

9.2.1 Design Requirements

For this design example, use the values listed in [Design Parameters](#) as the design parameters:

Table 9-1. Design Parameters

DESIGN PARAMETER	EXAMPLE VALUE
Input voltage (V_{IN})	3.3 V
Load current resistance (R_{OUT})	1 k Ω
Load capacitance (C_{OUT})	47 μ F
Minimum fall time (t_F)	40 ms
Maximum inrush current (I_{RUSH})	150 mA

9.2.2 Detailed Design Procedure

9.2.2.1 Limiting Inrush Current

Use [Equation 3](#) to find the maximum slew rate value to limit inrush current for a given capacitance:

$$(\text{Slew Rate}) = I_{\text{RUSH}} \div C_{\text{OUT}} \quad (3)$$

where

- I_{INRUSH} = maximum acceptable inrush current (mA)
- C_{OUT} = capacitance on V_{OUT} (μF)
- Slew Rate = Output Slew Rate during turn on (mV/ μs)

Based on [Equation 3](#), the required slew rate to limit the inrush current to 150 mA is 3.2 mV/ μs . The TPS7H2221-SEP has a slew rate of 2.3 mV/ μs , so the inrush current will be below 150 mA.

9.2.2.2 Setting Fall Time for Shutdown Power Sequencing

Microcontrollers and processors often have a specific shutdown sequence in which power must be removed. Using the adjustable Quick Output Discharge function of the TPS7H2221-SEP device, adding a load switch to each power rail can be used to manage the power down sequencing. To determine the QOD values for each load switch, first confirm the power down order of the device you wish to power sequence. Be sure to check if there are voltage or timing margins that must be maintained during power down.

Once the required fall time is determined, the maximum external discharge resistance (R_{DIS}) value can be found using [Equation 2](#):

$$t_{\text{FALL}(\text{min})} = 2.2 \times (R_{\text{DIS}} \parallel R_{\text{OUT}}) \times C_{\text{OUT}} \quad (4)$$

$$R_{\text{DIS}(\text{min})} = 630 \, \Omega \quad (5)$$

[Equation 1](#) can then be used to calculate the R_{QOD} resistance needed to achieve a particular discharge value:

$$R_{\text{DIS}} = \text{QOD} + R_{\text{QOD}} \quad (6)$$

$$R_{\text{QOD}} = 624 \, \Omega \quad (7)$$

To ensure a fall time greater than, choose an R_{QOD} value greater than 624 Ω .

9.2.2.3 Application Curves

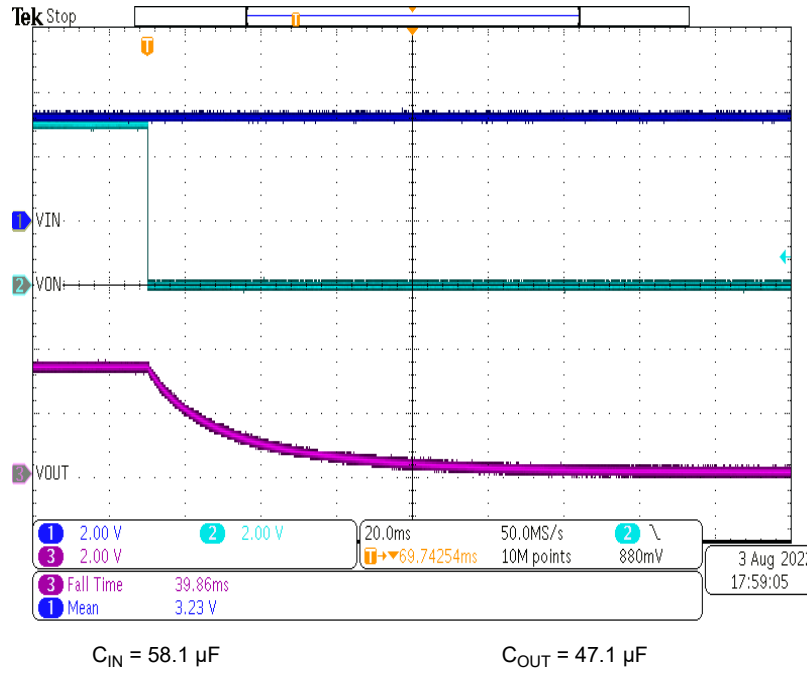

Figure 9-2. Fall Time ($R_{QOD} = 1 k\Omega$)

9.3 Application Curves

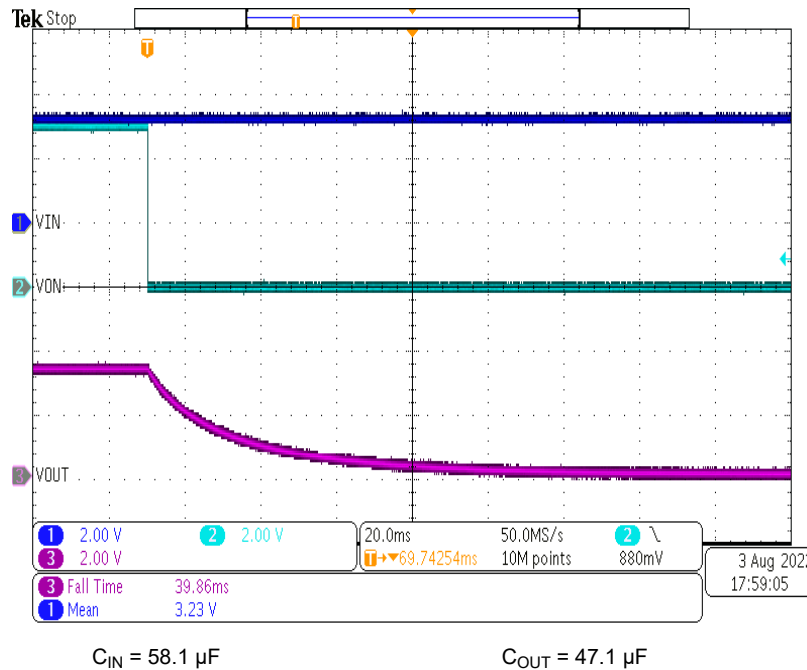

Figure 9-3. Fall Time ($R_{QOD} = 1 k\Omega$)

9.4 Power Supply Recommendations

The device is designed to operate with a V_{IN} range of 1.6 V to 5.5 V. The V_{IN} power supply must be well regulated. The power supply must be able to withstand all transient load current steps. In most situations, using an minimum input capacitance (C_{IN}) of 1 μ F is sufficient to prevent the supply voltage from dipping when the switch is turned on. In cases where the power supply is slow to respond to a large transient current or large load current step, additional bulk capacitance may be required on the input.

9.5 Layout

9.5.1 Layout Guidelines

For best performance, all traces must be as short as possible. To be most effective, the input and output capacitors must be placed close to the device to minimize the effects that parasitic trace inductances may have on normal operation. Using wide traces for IN, OUT, and GND helps minimize the parasitic electrical effects.

9.5.2 Layout Example

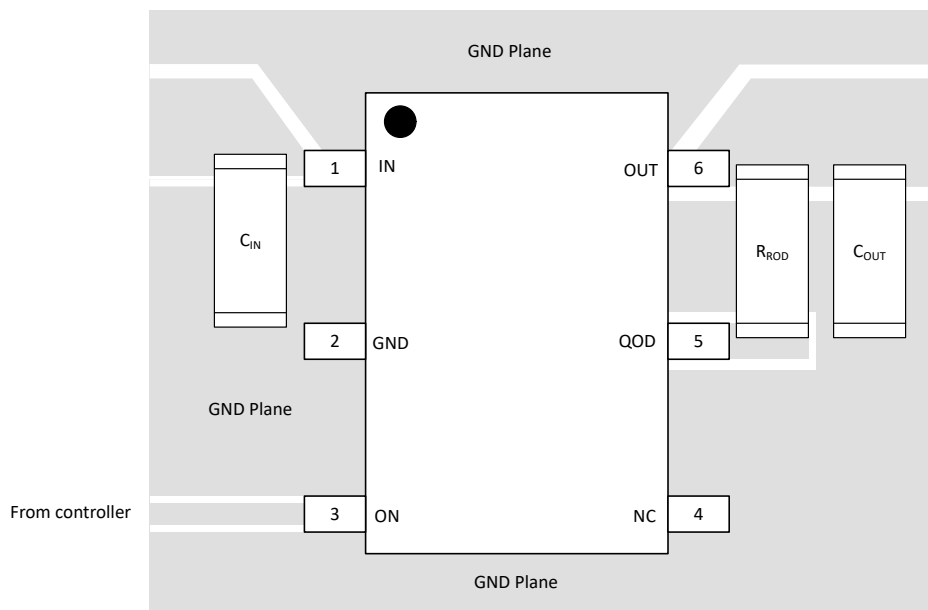

Figure 9-4. Recommended Board Layout

10 Device and Documentation Support

10.1 Related Documentation

For related documentation see the following:

- Texas Instruments, [TPS7H2221-SEP Total Ionizing Dose \(TID\)](#)
- Texas Instruments, [TPS7H2221-SEP Single-Event Effects \(SEE\) Test Report](#)
- Texas Instruments, [TPS7H2221-SEP Neutron Displacement Damage \(NDD\) Characterization](#)
- Texas Instruments, [TPS7H2221-SEP Evaluation Module \(EVM\)](#)
- Texas Instruments, [TPS7H2221-SEP PSpice Transient Model](#)
- Texas Instruments, [Basics of Load Switches](#)

10.2 Receiving Notification of Documentation Updates

To receive notification of documentation updates, navigate to the device product folder on [ti.com](#). Click on *Subscribe to updates* to register and receive a weekly digest of any product information that has changed. For change details, review the revision history included in any revised document.

10.3 Support Resources

[TI E2E™ support forums](#) are an engineer's go-to source for fast, verified answers and design help — straight from the experts. Search existing answers or ask your own question to get the quick design help you need.

Linked content is provided "AS IS" by the respective contributors. They do not constitute TI specifications and do not necessarily reflect TI's views; see TI's [Terms of Use](#).

10.4 Electrostatic Discharge Caution



This integrated circuit can be damaged by ESD. Texas Instruments recommends that all integrated circuits be handled with appropriate precautions. Failure to observe proper handling and installation procedures can cause damage.

ESD damage can range from subtle performance degradation to complete device failure. Precision integrated circuits may be more susceptible to damage because very small parametric changes could cause the device not to meet its published specifications.

10.5 Glossary

[TI Glossary](#) This glossary lists and explains terms, acronyms, and definitions.

10.6 Export Control Notice

Recipient agrees to not knowingly export or re-export, directly or indirectly, any product or technical data (as defined by the U.S., EU, and other Export Administration Regulations) including software, or any controlled product restricted by other applicable national regulations, received from disclosing party under nondisclosure obligations (if any), or any direct product of such technology, to any destination to which such export or re-export is restricted or prohibited by U.S. or other applicable laws, without obtaining prior authorization from U.S. Department of Commerce and other competent Government authorities to the extent required by those laws.

10.7 Third-Party Products Disclaimer

TI'S PUBLICATION OF INFORMATION REGARDING THIRD-PARTY PRODUCTS OR SERVICES DOES NOT CONSTITUTE AN ENDORSEMENT REGARDING THE SUITABILITY OF SUCH PRODUCTS OR SERVICES OR A WARRANTY, REPRESENTATION OR ENDORSEMENT OF SUCH PRODUCTS OR SERVICES, EITHER ALONE OR IN COMBINATION WITH ANY TI PRODUCT OR SERVICE.

11 Mechanical, Packaging, and Orderable Information

The following pages include mechanical, packaging, and orderable information. This information is the most current data available for the designated devices. This data is subject to change without notice and revision of this document. For browser-based versions of this data sheet, refer to the left-hand navigation.

PACKAGING INFORMATION

Orderable Device	Status (1)	Package Type	Package Drawing	Pins	Package Qty	Eco Plan (2)	Lead finish/ Ball material (6)	MSL Peak Temp (3)	Op Temp (°C)	Device Marking (4/5)	Samples
TPS7H2221MDCKTSEP	ACTIVE	SC70	DCK	6	250	RoHS & Green	NIPDAU	Level-1-260C-UNLIM	-55 to 125		Samples
V62/22609-01XE	ACTIVE	SC70	DCK	6	250	RoHS & Green	NIPDAU	Level-1-260C-UNLIM			Samples

(1) The marketing status values are defined as follows:

ACTIVE: Product device recommended for new designs.

LIFEBUY: TI has announced that the device will be discontinued, and a lifetime-buy period is in effect.

NRND: Not recommended for new designs. Device is in production to support existing customers, but TI does not recommend using this part in a new design.

PREVIEW: Device has been announced but is not in production. Samples may or may not be available.

OBSOLETE: TI has discontinued the production of the device.

(2) **RoHS:** TI defines "RoHS" to mean semiconductor products that are compliant with the current EU RoHS requirements for all 10 RoHS substances, including the requirement that RoHS substance do not exceed 0.1% by weight in homogeneous materials. Where designed to be soldered at high temperatures, "RoHS" products are suitable for use in specified lead-free processes. TI may reference these types of products as "Pb-Free".

RoHS Exempt: TI defines "RoHS Exempt" to mean products that contain lead but are compliant with EU RoHS pursuant to a specific EU RoHS exemption.

Green: TI defines "Green" to mean the content of Chlorine (Cl) and Bromine (Br) based flame retardants meet JS709B low halogen requirements of <=1000ppm threshold. Antimony trioxide based flame retardants must also meet the <=1000ppm threshold requirement.

(3) MSL, Peak Temp. - The Moisture Sensitivity Level rating according to the JEDEC industry standard classifications, and peak solder temperature.

(4) There may be additional marking, which relates to the logo, the lot trace code information, or the environmental category on the device.

(5) Multiple Device Markings will be inside parentheses. Only one Device Marking contained in parentheses and separated by a "~" will appear on a device. If a line is indented then it is a continuation of the previous line and the two combined represent the entire Device Marking for that device.

(6) Lead finish/Ball material - Orderable Devices may have multiple material finish options. Finish options are separated by a vertical ruled line. Lead finish/Ball material values may wrap to two lines if the finish value exceeds the maximum column width.

Important Information and Disclaimer:The information provided on this page represents TI's knowledge and belief as of the date that it is provided. TI bases its knowledge and belief on information provided by third parties, and makes no representation or warranty as to the accuracy of such information. Efforts are underway to better integrate information from third parties. TI has taken and continues to take reasonable steps to provide representative and accurate information but may not have conducted destructive testing or chemical analysis on incoming materials and chemicals. TI and TI suppliers consider certain information to be proprietary, and thus CAS numbers and other limited information may not be available for release.

In no event shall TI's liability arising out of such information exceed the total purchase price of the TI part(s) at issue in this document sold by TI to Customer on an annual basis.

TAPE AND REEL INFORMATION

QUADRANT ASSIGNMENTS FOR PIN 1 ORIENTATION IN TAPE

*All dimensions are nominal

Device	Package Type	Package Drawing	Pins	SPQ	Reel Diameter (mm)	Reel Width W1 (mm)	A0 (mm)	B0 (mm)	K0 (mm)	P1 (mm)	W (mm)	Pin1 Quadrant
TPS7H2221MDCKTSEP	SC70	DCK	6	250	180.0	8.4	2.47	2.3	1.25	4.0	8.0	Q3

TAPE AND REEL BOX DIMENSIONS

*All dimensions are nominal

Device	Package Type	Package Drawing	Pins	SPQ	Length (mm)	Width (mm)	Height (mm)
TPS7H2221MDCKTSEP	SC70	DCK	6	250	202.0	201.0	28.0

DCK0006A



PACKAGE OUTLINE

SOT - 1.1 max height

SMALL OUTLINE TRANSISTOR

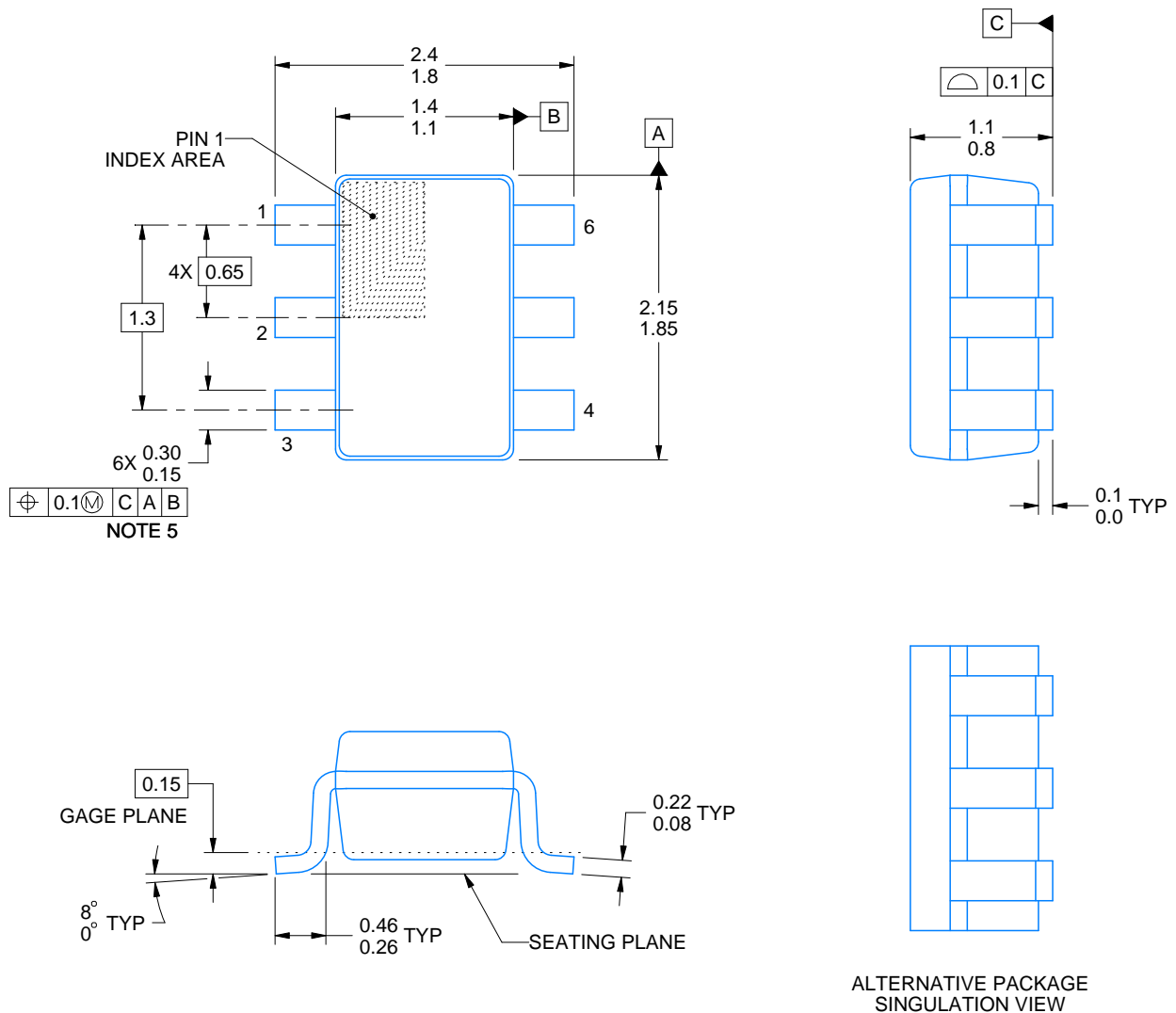

4214835/B 04/2024

NOTES:

1. All linear dimensions are in millimeters. Any dimensions in parenthesis are for reference only. Dimensioning and tolerancing per ASME Y14.5M.
2. This drawing is subject to change without notice.
3. Body dimensions do not include mold flash or protrusion. Mold flash and protrusion shall not exceed 0.15 per side.
4. Falls within JEDEC MO-203 variation AB.

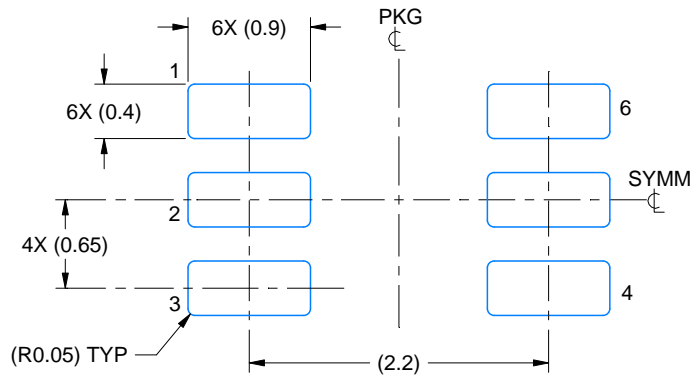

LAND PATTERN EXAMPLE
EXPOSED METAL SHOWN
SCALE:18X

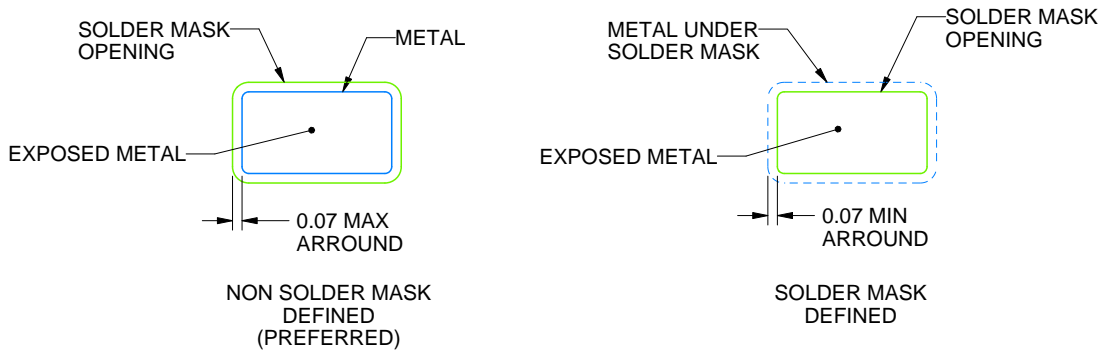

SOLDER MASK DETAILS

4214835/B 04/2024

NOTES: (continued)

5. Publication IPC-7351 may have alternate designs.
6. Solder mask tolerances between and around signal pads can vary based on board fabrication site.



SOLDER PASTE EXAMPLE
BASED ON 0.125 THICK STENCIL
SCALE:18X

4214835/B 04/2024

NOTES: (continued)

7. Laser cutting apertures with trapezoidal walls and rounded corners may offer better paste release. IPC-7525 may have alternate design recommendations.
8. Board assembly site may have different recommendations for stencil design.

IMPORTANT NOTICE AND DISCLAIMER

TI PROVIDES TECHNICAL AND RELIABILITY DATA (INCLUDING DATA SHEETS), DESIGN RESOURCES (INCLUDING REFERENCE DESIGNS), APPLICATION OR OTHER DESIGN ADVICE, WEB TOOLS, SAFETY INFORMATION, AND OTHER RESOURCES "AS IS" AND WITH ALL FAULTS, AND DISCLAIMS ALL WARRANTIES, EXPRESS AND IMPLIED, INCLUDING WITHOUT LIMITATION ANY IMPLIED WARRANTIES OF MERCHANTABILITY, FITNESS FOR A PARTICULAR PURPOSE OR NON-INFRINGEMENT OF THIRD PARTY INTELLECTUAL PROPERTY RIGHTS.

These resources are intended for skilled developers designing with TI products. You are solely responsible for (1) selecting the appropriate TI products for your application, (2) designing, validating and testing your application, and (3) ensuring your application meets applicable standards, and any other safety, security, regulatory or other requirements.

These resources are subject to change without notice. TI grants you permission to use these resources only for development of an application that uses the TI products described in the resource. Other reproduction and display of these resources is prohibited. No license is granted to any other TI intellectual property right or to any third party intellectual property right. TI disclaims responsibility for, and you will fully indemnify TI and its representatives against, any claims, damages, costs, losses, and liabilities arising out of your use of these resources.

TI's products are provided subject to [TI's Terms of Sale](#) or other applicable terms available either on [ti.com](https://www.ti.com) or provided in conjunction with such TI products. TI's provision of these resources does not expand or otherwise alter TI's applicable warranties or warranty disclaimers for TI products.

TI objects to and rejects any additional or different terms you may have proposed.

Mailing Address: Texas Instruments, Post Office Box 655303, Dallas, Texas 75265
Copyright © 2024, Texas Instruments Incorporated