

CC1312PSIP SimpleLink™ Sub-1-GHz Wireless System-in-Package

1 Features

Wireless microcontroller

- Powerful 48 MHz Arm® Cortex®-M4F processor
- 352KB flash program memory
- 256KB of ROM for protocols and library functions
- 8KB of cache SRAM
- 80KB of ultra-low leakage SRAM with parity for high-reliability operation
- Programmable radio includes support for 2-(G)FSK, 4-(G)FSK, MSK, OOK, IEEE 802.15.4 PHY and MAC
- Supports over-the-air upgrade (OTA)

Ultra-low power sensor controller

- Autonomous MCU with 4KB of SRAM
- Sample, store, and process sensor data
- Fast wake-up for low-power operation
- Software defined peripherals; capacitive touch, flow meter, LCD

Low power consumption

- MCU consumption:
 - 2.9 mA active mode, CoreMark®
 - 60 µA/MHz running CoreMark®
 - 0.9 µA standby mode, RTC, 80KB SRAM
 - 0.1 µA shutdown mode, wake-up on pin
- Ultra low-power sensor controller consumption:
 - 30 µA in 2 MHz mode
 - 808 µA in 24 MHz mode
- Radio Consumption:
 - 5.8 mA RX at 868 MHz
 - 28.7 mA TX at +14 dBm at 868 MHz
 - 62 mA TX at +19 dBm at 915 MHz
 - 86 mA TX at +20 dBm at 915 MHz

Wireless protocol support

- [Wi-SUN®](#)
- [mioty®](#)
- [Wireless M-Bus](#)
- [SimpleLink™ TI 15.4-stack](#)
- 6LoWPAN, [Proprietary systems](#)

High-performance radio

- –119 dBm for 2.5 kbps long-range mode
- –108 dBm at 50 kbps, 802.15.4, 868 MHz
- Output power up to +20 dBm with temperature and voltage compensation

Regulatory compliance

- Certified module for:
 - FCC CFR47 Part 15
 - ISED Certified (Canada)
- Suitable for systems targeting compliance with:
 - ETSI EN 300 220 Receiver Cat. 1.5 and 2, EN 303 131, EN 303 204
 - ARIB STD-T108

MCU peripherals

- Digital peripherals can be routed to 30 GPIOs
- Four 32-bit or eight 16-bit general-purpose timers
- 12-bit ADC, 200 kSamples/s, 8 channels
- 8-bit DAC, two comparators
- Programmable current source
- Two UART, two SSI, I²C, I²S
- Real-time clock (RTC)
- Integrated temperature and battery monitor

Security enablers

- AES 128- and 256-bit cryptographic accelerator
- ECC and RSA public key hardware accelerator
- SHA2 Accelerator (full suite up to SHA-512)
- True random number generator (TRNG)

Development tools and software

- [LP-CC1312PSIP Development Kit](#)
- [SimpleLink Low Power F2 SDK](#)
- [SmartRF™ Studio](#) for simple radio configuration
- [Sensor Controller Studio](#) for building low-power sensing applications
- [SysConfig](#) system configuration tool

Operating range

- 1.8 V to 3.8 V single supply voltage
- –40 to +105°C (+14 dBm PA)
- –40 to +95°C (+20 dBm PA)

All necessary components integrated

- 48-MHz crystal: RF accuracy ±10 ppm initial and over temperature
- 32-kHz crystal: RTC accuracy ±50 ppm initial and over temperature
- DC/DC converter components and decoupling
- Single-RF pin for RX/TX with 50 Ohm impedance.

Package

- 7-mm × 7-mm MOT (30 GPIOs)
- Pin-to-pin compatible with [CC2652RSIP](#) and [CC2652PSIP](#)
- RoHS-compliant package



2 Applications

- 868 and 902 to 928 MHz ISM and SRD systems ¹ with down to 4 kHz of receive bandwidth
- **Building automation**
 - Building security systems – [motion detector](#), [electronic smart lock](#), [door and window sensor](#), [garage door system](#), [gateway](#)
 - HVAC – [thermostat](#), [wireless environmental sensor](#), [HVAC system controller](#), [gateway](#)
 - Fire safety system – [smoke and heat detector](#), [fire alarm control panel \(FACP\)](#)
 - Video surveillance – [IP network camera](#)
 - Elevators and escalators – [elevator main control panel for elevators and escalators](#)
- **Grid infrastructure**
 - Smart meters – [water meter](#), [gas meter](#), [electricity meter](#), and [heat cost allocators](#)
 - Grid communications – [wireless communications](#) – long-range sensor applications
 - EV Charging infrastructure – [AC charging \(pile\) station](#)
 - Solar Energy - [Micro inverter](#)
 - Other alternative energy – [energy harvesting](#)
- **Industrial transport** – [asset tracking](#)
- **Factory automation and control**
- **Medical**
- **Communication equipment**
 - [Wired networking](#) – [wireless LAN or Wi-Fi access points](#), [edge router](#)

3 Description

The SimpleLink™ CC1312PSIP device is an RF certified System-in-Package (SiP) Sub-1 GHz wireless module supporting [Wi-SUN®](#), Wireless M-Bus, IEEE 802.15.4, IPv6-enabled smart objects (6LoWPAN), [mioty](#), proprietary systems, including the [TI 15.4-Stack](#). The CC1312PSIP microcontroller (MCU) is based on an Arm® Cortex® M4F main processor and optimized for low-power wireless communication and advanced sensing in [grid infrastructure](#), [building automation](#), [retail automation](#) and [medical applications](#).

The CC1312PSIP has a low sleep current of 0.9 µA with RTC and 80KB RAM retention. In addition to the main Cortex® M4F processor, the device also has an autonomous ultra-low power Sensor Controller CPU with fast wake-up capability. As an example, the sensor controller is capable of 1-Hz ADC sampling at average 1-µA system current.

The CC1312PSIP has [Low SER \(Soft Error Rate\) FIT \(Failure-in-time\)](#) for long operational lifetime. Always-on SRAM parity minimizes risk for corruption due to potential radiation events. Consistent with many customers' 10 to 15 years or longer life cycle requirements, TI has a [product life cycle policy](#) with a commitment to product longevity and continuity of supply including dual sourcing of key components in the SiP.

The CC1312PSIP device is part of the SimpleLink™ MCU platform, which consists of Wi-Fi®, [Bluetooth®](#) Low Energy, Thread, Zigbee, Wi-SUN®, Amazon Sidewalk, [mioty](#), Sub-1 GHz MCUs, and host MCUs. CC1312PSIP is part of a portfolio that includes pin-compatible 2.4-GHz SiPs for easy adaption of a wireless product to multiple communication standards. The common [SimpleLink Low Power F2 SDK](#) and [SysConfig](#) system configuration tool supports migration between devices in the portfolio. A comprehensive number of software stacks, application examples and SimpleLink™ Academy training sessions are included in the SDK. For more information, visit [wireless connectivity](#).

Device Information

PART NUMBER ⁽¹⁾	PACKAGE	BODY SIZE (NOM)
CC1312PSIPMOT	QFM	7.00 mm × 7.00 mm

- (1) For the most current part, package, and ordering information for all available devices, see the Package Option Addendum in [Section 13](#), or see the [TI website](#).

¹ See [RF Core](#) for additional details on supported protocol standards, modulation formats, and data rates.

4 Functional Block Diagram

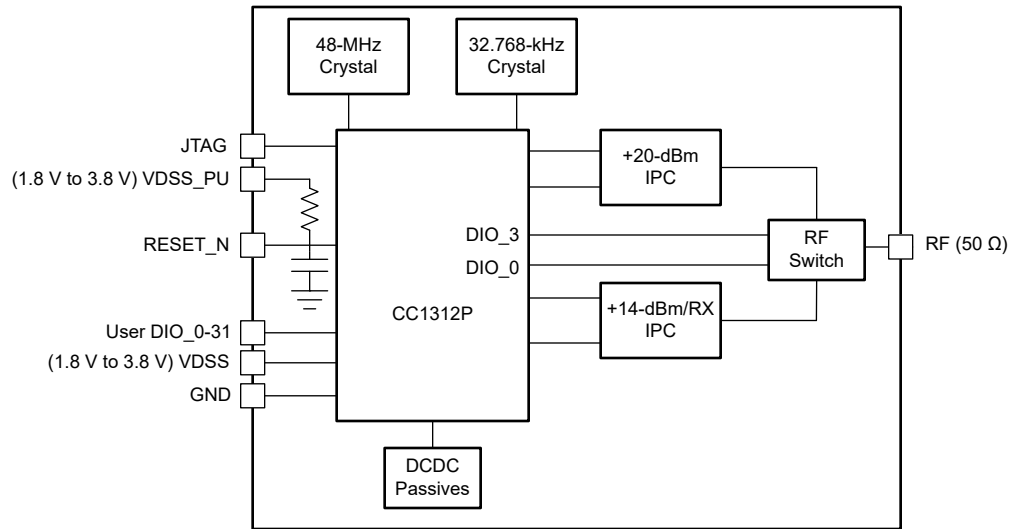

Figure 4-1. CC1312PSIP Block Diagram

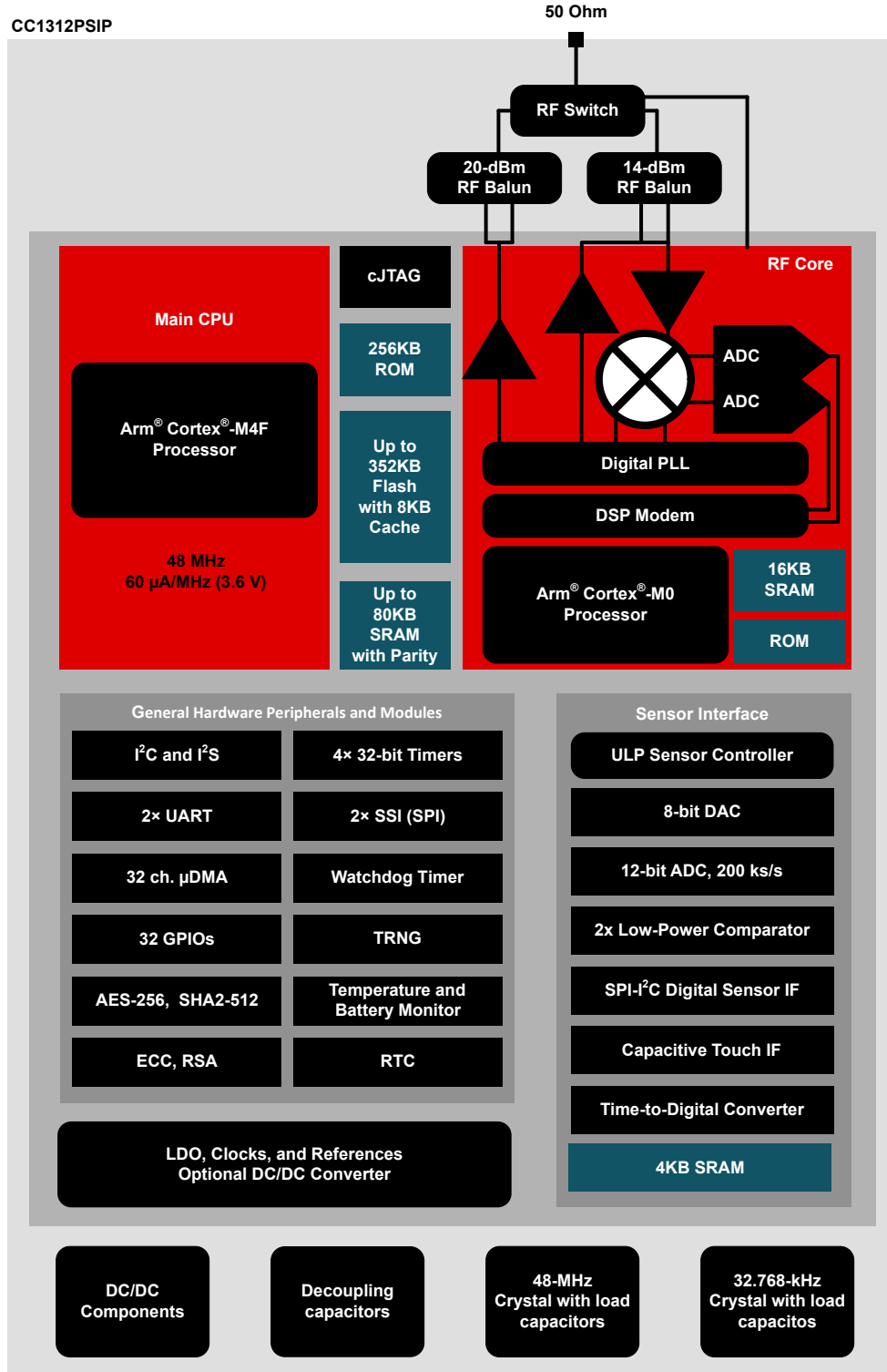

Figure 4-2. CC1312PSIP Hardware Overview

Table of Contents

1 Features	1	9.7 Timers.....	49
2 Applications	2	9.8 Serial Peripherals and I/O.....	50
3 Description	2	9.9 Battery and Temperature Monitor.....	50
4 Functional Block Diagram	3	9.10 μ DMA.....	50
5 Revision History	5	9.11 Debug.....	50
6 Device Comparison	6	9.12 Power Management.....	51
7 Pin Configuration and Functions	9	9.13 Clock Systems, production calibration and temperature compensation.....	52
7.1 Pin Diagram – MOT Package (Top View).....	9	9.14 Network Processor.....	53
7.2 Signal Descriptions – MOT Package.....	10	9.15 Device Certification and Qualification.....	54
7.3 Connections for Unused Pins and Modules.....	11	9.16 Module Markings.....	56
8 Specifications	12	9.17 End Product Labeling.....	56
8.1 Absolute Maximum Ratings.....	12	9.18 Manual Information to the End User.....	56
8.2 ESD Ratings.....	12	10 Application, Implementation, and Layout	57
8.3 Recommended Operating Conditions.....	12	10.1 Application Information.....	57
8.4 Power Supply and Modules.....	12	10.2 Device Connection and Layout Fundamentals.....	58
8.5 Power Consumption - Power Modes.....	13	10.3 PCB Layout Guidelines.....	58
8.6 Power Consumption - Radio Modes.....	14	10.4 Reference Designs.....	62
8.7 Nonvolatile (Flash) Memory Characteristics.....	14	11 Environmental Requirements and SMT Specifications	63
8.8 Thermal Resistance Characteristics.....	14	11.1 PCB Bending.....	63
8.9 RF Frequency Bands.....	15	11.2 Handling Environment.....	63
8.10 861 MHz to 1054 MHz - Receive (RX).....	16	11.3 Storage Condition.....	63
8.11 861 MHz to 1054 MHz - Transmit (TX).....	21	11.4 PCB Assembly Guide.....	63
8.12 861 MHz to 1054 MHz - PLL Phase Noise Wideband Mode.....	22	11.5 Baking Conditions.....	64
8.13 861 MHz to 1054 MHz - PLL Phase Noise Narrowband Mode.....	23	11.6 Soldering and Reflow Condition.....	65
8.14 Timing and Switching Characteristics.....	23	12 Device and Documentation Support	66
8.15 Peripheral Characteristics.....	27	12.1 Device Nomenclature.....	66
8.16 Typical Characteristics.....	35	12.2 Tools and Software.....	66
9 Detailed Description	44	12.3 Documentation Support.....	68
9.1 Overview.....	44	12.4 Support Resources.....	69
9.2 System CPU.....	44	12.5 Trademarks.....	69
9.3 Radio (RF Core).....	45	12.6 Electrostatic Discharge Caution.....	69
9.4 Memory.....	46	12.7 Glossary.....	69
9.5 Sensor Controller.....	47	13 Mechanical, Packaging, and Orderable Information	70
9.6 Cryptography.....	48		

5 Revision History

NOTE: Page numbers for previous revisions may differ from page numbers in the current version.

DATE	REVISION	NOTES
November 2023	*	Initial Release

6 Device Comparison

DEVICE, Wireless MCU	RADIO SUPPORT											FLASH (KB)	RAM + Cache (KB)	GPIO	PACKAGE SIZE					
	Sub-1 GHz Prop.	2.4GHz Prop.	Wireless M-Bus	mioty	Wi-SUN®	Sidewalk	Bluetooth® LE	ZigBee	Thread	Multiprotocol	+20 dBm PA				4 x 4 mm VQFN (24)	4 x 4 mm VQFN (32)	5 x 5 mm VQFN (32)	5 x 5 mm VQFN (40)	7 x 7 mm VQFN (48)	8 x 8mm VQFN (48)
CC1310	X		X	X								32-128	16-20 + 8	10-30		X	X		X	
CC1311R3	X		X	X								352	32 + 8	22-30				X	X	
CC1311P3	X		X	X							X	352	32 + 8	26					X	
CC1312R	X		X	X	X							352	80 + 8	30					X	
CC1312R7	X		X	X	X	X				X		704	144 + 8	30					X	
CC1352R	X	X	X	X	X		X	X	X	X		352	80 + 8	28					X	
CC1352P	X	X	X	X	X		X	X	X	X	X	352	80 + 8	26					X	
CC1352P7	X	X	X	X	X	X	X	X	X	X	X	704	144 + 8	26	X				X	
CC1314R10	X		X	X	X	X				X		1024	256 + 8	30-46					X	X
CC1354R10	X	X	X	X	X	X	X	X	X	X		1024	256 + 8	28-42					X	X
CC1354P10	X	X	X	X	X	X	X	X	X	X	X	1024	256 + 8	26-42					X	X
CC2340R2		X					X	X				256	28	12	X					
CC2340R5		X					X	X	X			512	36	12-26	X			X		
CC2340R5-Q1							X					512	36	19			X			
CC2640R2F							X					128	20 + 8	10-31		X	X		X	
CC2642R							X					352	80 + 8	31					X	
CC2642R-Q1							X					352	80 + 8	31					X	
CC2651R3		X					X	X				352	32 + 8	23-31				X	X	
CC2651P3		X					X	X			X	352	32 + 8	22-26				X	X	
CC2652R		X					X	X	X	X		352	80 + 8	31					X	
CC2652RB		X					X	X	X	X		352	80 + 8	31					X	
CC2652R7		X					X	X	X	X		704	144 + 8	31					X	
CC2652P		X					X	X	X	X	X	352	80 + 8	26					X	
CC2652P7		X					X	X	X	X	X	704	144 + 8	26					X	
CC2662R-Q1		X										352	80 + 8	31					X	
CC2674R10		X					X	X	X	X		1024	256 + 8	31-42					X	X

DEVICE, Wireless MCU	RADIO SUPPORT										FLASH (KB)	RAM + Cache (KB)	GPIO	PACKAGE SIZE						
	Sub-1 GHz Prop.	2.4GHz Prop.	Wireless M-Bus	mioty	Wi-SUN®	Sidewalk	Bluetooth® LE	ZigBee	Thread	Multiprotocol				+20 dBm PA	4 × 4 mm VQFN (24)	4 × 4 mm VQFN (32)	5 × 5 mm VQFN (32)	5 × 5 mm VQFN (40)	7 × 7 mm VQFN (48)	8 × 8mm VQFN (48)
CC2674P10		X					X	X	X	X	X	1024	256 + 8	26-42					X	X

DEVICE, Wireless System-in- Package	ANTENNA		RADIO SUPPORT									CERTIFICATIONS				FLASH (KB)	RAM + Cache (KB)	GPIO	PACKAGE SIZE	
	External	Integrated	Sub-1GHz Prop.	2.4 GHz Prop.	Wireless M-Bus	mioty	WI-SUN®	Bluetooth® LE	ZigBee	+10 dBm PA	+20 dBm PA	FCC/IC	CE	RER (UK)	Japan				7 x 7 QFM (73)	7 x 7 QFM (59)
CC2651R3SIP A	X	X		X				X	X			X	X	X		352	32 + 8	32		X
CC2652RSIP	X			X				X	X			X	X	X		352	80 + 8	32	X	
CC2652PSIP	X			X				X	X	X		X	X	X		352	80 + 8	30	X	
CC1312PSIP	X		X		X	X	X				X	X	X	X		352	80 + 8	30	X	

7 Pin Configuration and Functions

7.1 Pin Diagram – MOT Package (Top View)

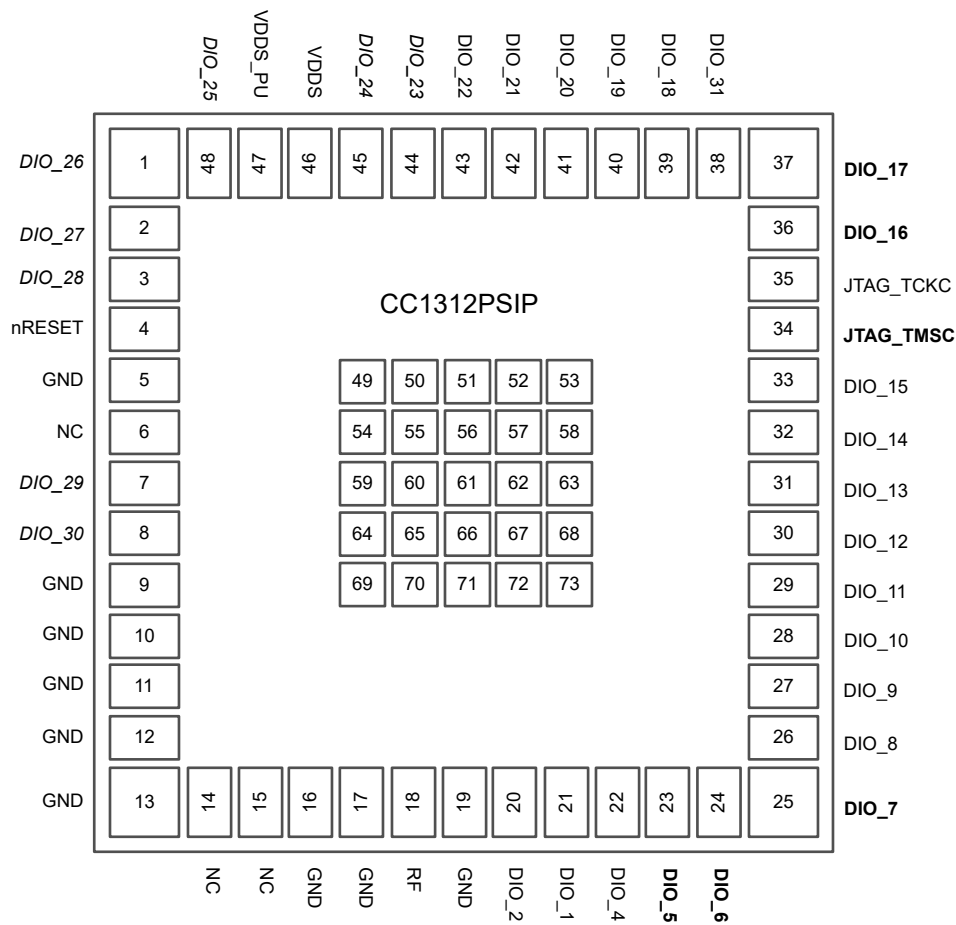

Figure 7-1. MOT (7-mm × 7-mm) Pinout, 0.5-mm Pitch (Top View)

The following I/O pins marked in [Figure 7-1](#) in **bold** have high-drive capabilities:

- Pin 23, DIO_5
- Pin 24, DIO_6
- Pin 25, DIO_7
- Pin 34, JTAG_TMSC
- Pin 36, DIO_16
- Pin 37, DIO_17

The following I/O pins marked in [Figure 7-1](#) in *italics* have analog capabilities:

- Pin 1, DIO_26
- Pin 2, DIO_27
- Pin 3, DIO_28
- Pin 7, DIO_29
- Pin 8, DIO_30
- Pin 44, DIO_23
- Pin 45, DIO_24
- Pin 48, DIO_25

7.2 Signal Descriptions – MOT Package

Table 7-1. Signal Descriptions – SIP Package

PIN		I/O	TYPE	DESCRIPTION
NAME	NO.			
NC	14	I/O	Digital	No Connect, this pin is internally connected to the RF switch
DIO_1	21	I/O	Digital	GPIO
DIO_10	28	I/O	Digital	GPIO
DIO_11	29	I/O	Digital	GPIO
DIO_12	30	I/O	Digital	GPIO
DIO_13	31	I/O	Digital	GPIO
DIO_14	32	I/O	Digital	GPIO
DIO_15	33	I/O	Digital	GPIO
DIO_16	36	I/O	Digital	GPIO, JTAG_TDO, high-drive capability
DIO_17	37	I/O	Digital	GPIO, JTAG_TDI, high-drive capability
DIO_18	39	I/O	Digital	GPIO
DIO_19	40	I/O	Digital	GPIO
DIO_2	20	I/O	Digital	GPIO
DIO_20	41	I/O	Digital	GPIO
DIO_21	42	I/O	Digital	GPIO
DIO_22	43	I/O	Digital	GPIO
DIO_23	44	I/O	Digital or Analog	GPIO, analog capability
DIO_24	45	I/O	Digital or Analog	GPIO, analog capability
DIO_25	48	I/O	Digital or Analog	GPIO, analog capability
DIO_26	1	I/O	Digital or Analog	GPIO, analog capability
DIO_27	2	I/O	Digital or Analog	GPIO, analog capability
DIO_28	3	I/O	Digital or Analog	GPIO, analog capability
DIO_29	7	I/O	Digital or Analog	GPIO, analog capability
NC	15	I/O	Digital	No Connect, this pin is internally connected to the RF switch
DIO_30	8	I/O	Digital or Analog	GPIO, analog capability
DIO_31	38	I/O	Digital	Supports only peripheral functionality. Does not support general purpose I/O functionality.
DIO_4	22	I/O	Digital	GPIO
DIO_5	23	I/O	Digital	GPIO, high-drive capability
DIO_6	24	I/O	Digital	GPIO, high-drive capability
DIO_7	25	I/O	Digital	GPIO, high-drive capability
DIO_8	26	I/O	Digital	GPIO
DIO_9	27	I/O	Digital	GPIO
GND	5	—	—	GND
GND	9	—	—	GND
GND	10	—	—	GND
GND	11	—	—	GND
GND	12	—	—	GND
GND	13	—	—	GND
GND	16	—	—	GND
GND	17	—	—	GND
GND	19	—	—	GND
GND	49-73	—	—	GND

Table 7-1. Signal Descriptions – SIP Package (continued)

PIN		I/O	TYPE	DESCRIPTION
NAME	NO.			
NC	6	—	—	No Connect
nRESET	4	I	Digital	Reset, active low. Internal pullup resistor and internal 100 nF to VDDS_PU
RF	18	—	RF	50 ohm RF port
JTAG_TCKC	35	I	Digital	JTAG_TCKC
JTAG_TMSC	34	I/O	Digital	JTAG_TMSC, high-drive capability
VDDS	46	—	Power	1.8-V to 3.8-V main SIP supply
VDDS_PU	47	—	Power	Power to reset internal pullup resistor

7.3 Connections for Unused Pins and Modules

Table 7-2. Connections for Unused Pins

FUNCTION	SIGNAL NAME	PIN NUMBER	ACCEPTABLE PRACTICE (1)	PREFERRED PRACTICE (1)
GPIO	DIO_n	1-3 7-8 20-33 36-45 48	NC or GND	NC
No Connects	NC	6, 14-15	NC	NC

(1) NC = No connect

8 Specifications

8.1 Absolute Maximum Ratings

over operating free-air temperature range (unless otherwise noted)⁽¹⁾ ⁽²⁾

		MIN	MAX	UNIT
V _{DDS} ⁽¹⁾	Supply voltage	-0.3	4.1	V
	Voltage on any digital pin ⁽³⁾	-0.3	V _{DDS} + 0.3, max 4.1	V
V _{in}	Voltage on ADC input	Voltage scaling enabled	V _{DDS}	V
		Voltage scaling disabled, internal reference	1.49	
		Voltage scaling disabled, V _{DDS} as reference	V _{DDS} / 2.9	
			10	dBm
T _{stg}	Storage temperature	-40	150	°C

- Operation outside the Absolute Maximum Ratings may cause permanent device damage. Absolute Maximum Ratings do not imply functional operation of the device at these or any other conditions beyond those listed under Recommended Operating Conditions. If used outside the Recommended Operating Conditions but within the Absolute Maximum Ratings, the device may not be fully functional, and this may affect device reliability, functionality, performance, and shorten the device lifetime
- All voltage values are with respect to ground, unless otherwise noted.
- Including analog capable DIOs.

8.2 ESD Ratings

				VALUE	UNIT
V _{ESD}	Electrostatic discharge	Human body model (HBM), per ANSI/ESDA/JEDEC JS-001 ⁽¹⁾	All pins	±1000	V
		Charged device model (CDM), per ANSI/ESDA/JEDEC JS-002 ⁽²⁾	All pins	±500	V

- JEDEC document JEP155 states that 500-V HBM allows safe manufacturing with a standard ESD control process.
- JEDEC document JEP157 states that 250-V CDM allows safe manufacturing with a standard ESD control process.

8.3 Recommended Operating Conditions

over operating free-air temperature range (unless otherwise noted)

		MIN	MAX	UNIT
Operating ambient temperature ⁽¹⁾ ⁽²⁾		-40	105	°C
Operating ambient temperature ⁽¹⁾ ⁽²⁾	Maximum operating temperature with transmit output power above +15 dBm (using the +20 dBm PA) ⁽²⁾	-40	95	°C
Operating supply voltage (V _{DDS})		1.8	3.8	V
Operating supply voltage (V _{DDS}), boost mode	V _{DDR} = 1.95 V +14 dBm RF output power	2.1	3.8	V
Rising supply voltage slew rate		0	100	mV/μs
Falling supply voltage slew rate		0	20	mV/μs

- Operation at or near maximum operating temperature for extended durations will result in a reduction in lifetime.
- For thermal resistance characteristics refer to [Section 8.8](#).

8.4 Power Supply and Modules

over operating free-air temperature range (unless otherwise noted)

PARAMETER		MIN	TYP	MAX	UNIT
V _{DDS} Power-on-Reset (POR) threshold		1.1 - 1.55			V
V _{DDS} Brown-out Detector (BOD) ⁽¹⁾	Rising threshold	1.77			V
V _{DDS} Brown-out Detector (BOD), before initial boot ⁽²⁾	Rising threshold	1.70			V
V _{DDS} Brown-out Detector (BOD) ⁽¹⁾	Falling threshold	1.75			V

- For boost mode (V_{DDR} = 1.95 V), TI drivers software initialization will trim V_{DDS} BOD limits to maximum (approximately 2.0 V)
- Brown-out Detector is trimmed at initial boot, value is kept until device is reset by a POR reset or the RESET_N pin

8.5 Power Consumption - Power Modes

When measured on the CC1312PSIP-EM reference design with $T_c = 25\text{ }^\circ\text{C}$, $V_{DD5} = 3.6\text{ V}$ with DC/DC enabled unless otherwise noted.

PARAMETER		TEST CONDITIONS	TYP	UNIT
Core Current Consumption				
I_{core}	Reset	Reset. RESET_N pin asserted or VDD5 below power-on-reset threshold ⁽⁴⁾	36	μA
	Shutdown	Shutdown. No clocks running, no retention	150	nA
	Standby without cache retention	RTC running, CPU, 80KB RAM and (partial) register retention. RCOSC_LF	0.9	μA
		RTC running, CPU, 80KB RAM and (partial) register retention. XOSC_LF	1.0	
	Standby with cache retention	RTC running, CPU, 80KB RAM and (partial) register retention. XOSC_LF	2.8	μA
		RTC running, CPU, 80KB RAM and (partial) register retention. XOSC_LF	2.9	
Idle	Supply Systems and RAM powered. RCOSC_HF	590	μA	
I_{core}	Active	MCU running CoreMark at 48 MHz. RCOSC_HF	2.89	mA
Peripheral Current Consumption				
I_{peri}	Peripheral power domain	Delta current with domain enabled	82	μA
	Serial power domain	Delta current with domain enabled	5.5	
	RF Core	Delta current with power domain enabled, clock enabled, RF core idle	179	
	μDMA	Delta current with clock enabled, module is idle	54	
	Timers	Delta current with clock enabled, module is idle ⁽³⁾	68	
	I2C	Delta current with clock enabled, module is idle	8.2	
	I2S	Delta current with clock enabled, module is idle	22	
	SSI	Delta current with clock enabled, module is idle ⁽²⁾	70	
	UART	Delta current with clock enabled, module is idle ⁽¹⁾	141	
	CRYPTO (AES)	Delta current with clock enabled, module is idle	21	
	PKA	Delta current with clock enabled, module is idle	71	
	TRNG	Delta current with clock enabled, module is idle	30	
Sensor Controller Engine Consumption				
I_{SCE}	Active mode	24 MHz, infinite loop	808	μA
	Low-power mode	2 MHz, infinite loop	30.1	

- (1) Only one UART running
- (2) Only one SSI running
- (3) Only one GPTimer running
- (4) CC1312PSIP integrates a 100 k Ω pull-up resistor on nRESET

8.6 Power Consumption - Radio Modes

When measured on the CC1312PSIP-EM reference design with $T_c = 25\text{ }^\circ\text{C}$, $V_{DD5} = 3.6\text{ V}$ with DC/DC enabled unless otherwise noted.

Using boost mode (increasing VDDR up to 1.95 V), will increase system current by 15% (does not apply to TX +14 dBm setting where this current is already included).

Relevant I_{core} and I_{peri} currents are included in below numbers.

PARAMETER	TEST CONDITIONS	TYP	UNIT
Radio receive current, 868 MHz		5.8	mA
Radio transmit current Regular PA	0 dBm output power setting 868 MHz	9.4	mA
	+10 dBm output power setting 868 MHz	17.3	mA
Radio transmit current Boost mode, regular PA	+14 dBm output power setting 868 MHz	28.7	mA
Radio transmit current High-power PA	Transmit (TX), +19 dBm output power setting 915 MHz, VDD5 = 3.3 V	62	mA
Radio transmit current High-power PA	Transmit (TX), +20 dBm output power setting 915 MHz, VDD5 = 3.3 V	86	mA

8.7 Nonvolatile (Flash) Memory Characteristics

Over operating free-air temperature range and $V_{DD5} = 3.0\text{ V}$ (unless otherwise noted)

PARAMETER	TEST CONDITIONS	MIN	TYP	MAX	UNIT
Flash sector size			8		KB
Supported flash erase cycles before failure, single-bank ⁽¹⁾ (5)		30			k Cycles
Supported flash erase cycles before failure, single sector ⁽²⁾		60			k Cycles
Maximum number of write operations per row before sector erase ⁽³⁾				83	Write Operations
Flash retention	105 °C	11.4			Years at 105 °C
Flash sector erase current	Average delta current		10.7		mA
Flash sector erase time ⁽⁴⁾	Zero cycles		10		ms
	30k cycles			4000	ms
Flash write current	Average delta current, 4 bytes at a time		6.2		mA
Flash write time ⁽⁴⁾	4 bytes at a time		21.6		µs

- (1) A full bank erase is counted as a single erase cycle on each sector.
- (2) Up to 4 customer-designated sectors can be individually erased an additional 30k times beyond the baseline bank limitation of 30k cycles
- (3) Each wordline is 2048 bits (or 256 bytes) wide. This limitation corresponds to sequential memory writes of 4 (3.1) bytes minimum per write over a whole wordline. If additional writes to the same wordline are required, a sector erase is required once the maximum number of write operations per row is reached.
- (4) This number is dependent on Flash aging and increases over time and erase cycles
- (5) Aborting flash during erase or program modes is not a safe operation.

8.8 Thermal Resistance Characteristics

THERMAL METRIC ⁽¹⁾		PACKAGE		
		MOT (SIP)		UNIT
		73 PINS		
$R_{\theta JA}$	Junction-to-ambient thermal resistance	48.7		$^\circ\text{C}/\text{W}^{(2)}$
$R_{\theta JC(top)}$	Junction-to-case (top) thermal resistance	12.4		$^\circ\text{C}/\text{W}^{(2)}$
$R_{\theta JB}$	Junction-to-board thermal resistance	32.2		$^\circ\text{C}/\text{W}^{(2)}$
Ψ_{JT}	Junction-to-top characterization parameter	0.40		$^\circ\text{C}/\text{W}^{(2)}$
Ψ_{JB}	Junction-to-board characterization parameter	32.0		$^\circ\text{C}/\text{W}^{(2)}$

- (1) For more information about traditional and new thermal metrics, see [Semiconductor and IC Package Thermal Metrics](#).

(2) °C/W = degrees Celsius per watt.

8.9 RF Frequency Bands

Over operating free-air temperature range (unless otherwise noted).

PARAMETER	MIN	TYP	MAX	UNIT
Frequency band	863		930	MHz

8.10 861 MHz to 1054 MHz - Receive (RX)

When measured on the CC1312PSIP-EM reference design with $T_c = 25\text{ }^\circ\text{C}$, $V_{DD5} = 3.0\text{ V}$ with DC/DC enabled and high power PA connected to V_{DD5} unless otherwise noted.

All measurements are performed at the antenna input. All measurements are performed conducted.

PARAMETER	TEST CONDITIONS	MIN	TYP	MAX	UNIT
General Parameters					
Digital channel filter programmable receive bandwidth		4		4000	kHz
Data rate step size			1.5		bps
Spurious emissions 25 MHz to 1 GHz	868 MHz		< -57		dBm
Spurious emissions 1 GHz to 13 GHz	Conducted emissions measured according to ETSI EN 300 220		< -47		dBm
802.15.4, 50 kbps, ± 25 kHz deviation, 2-GFSK, 100 kHz RX Bandwidth					
Sensitivity	BER = 10^{-2} , 868 MHz		-108		dBm
Saturation limit	BER = 10^{-2} , 868 MHz		10		dBm
Selectivity, ± 200 kHz	BER = 10^{-2} , 868 MHz ⁽¹⁾		44		dB
Selectivity, ± 400 kHz	BER = 10^{-2} , 868 MHz ⁽¹⁾		48		dB
Blocking, ± 1 MHz	BER = 10^{-2} , 868 MHz ⁽¹⁾		57		dB
Blocking, ± 2 MHz	BER = 10^{-2} , 868 MHz ⁽¹⁾		62		dB
Blocking, ± 5 MHz	BER = 10^{-2} , 868 MHz ⁽¹⁾		68		dB
Blocking, ± 10 MHz	BER = 10^{-2} , 868 MHz ⁽¹⁾		76		dB
Image rejection (image compensation enabled)	BER = 10^{-2} , 868 MHz ⁽¹⁾		39		dB
RSSI dynamic range	Starting from the sensitivity limit		95		dB
RSSI accuracy	Starting from the sensitivity limit across the given dynamic range		± 3		dB
802.15.4, 100 kbps, ± 25 kHz deviation, 2-GFSK, 137 kHz RX Bandwidth					
Sensitivity 100 kbps	868 MHz, 1% PER, 127 byte payload		-101		dBm
Selectivity, ± 200 kHz	868 MHz, 1% PER, 127 byte payload. Wanted signal at -96 dBm		38		dB
Selectivity, ± 400 kHz	868 MHz, 1% PER, 127 byte payload. Wanted signal at -96 dBm		45		dB
Co-channel rejection	868 MHz, 1% PER, 127 byte payload. Wanted signal at -79 dBm		-9		dB
802.15.4, 200 kbps, ± 50 kHz deviation, 2-GFSK, 311 kHz RX Bandwidth					
Sensitivity	BER = 10^{-2} , 868 MHz		-103		dBm
Sensitivity	BER = 10^{-2} , 915 MHz		-103		dBm
Selectivity, ± 400 kHz	BER = 10^{-2} , 915 MHz. Wanted signal 3 dB above sensitivity limit.		41		dB
Selectivity, ± 800 kHz	BER = 10^{-2} , 915 MHz. Wanted signal 3 dB above sensitivity limit.		47		dB
Blocking, ± 2 MHz	BER = 10^{-2} , 915 MHz. Wanted signal 3 dB above sensitivity limit.		55		dB
Blocking, ± 10 MHz	BER = 10^{-2} , 915 MHz. Wanted signal 3 dB above sensitivity limit.		67		dB
802.15.4, 500 kbps, ± 190 kHz deviation, 2-GFSK, 655 kHz RX Bandwidth					
Sensitivity 500 kbps	916 MHz, 1% PER, 127 byte payload		-90		dBm
Selectivity, ± 1 MHz	916 MHz, 1% PER, 127 byte payload. Wanted signal at -88 dBm		11		dB
Selectivity, ± 2 MHz	916 MHz, 1% PER, 127 byte payload. Wanted signal at -88 dBm		43		dB
Co-channel rejection	916 MHz, 1% PER, 127 byte payload. Wanted signal at -71 dBm		-9		dB
SimpleLink™ Long Range 2.5 kbps or 5 kbps (20 ksymbols/s, 2-GFSK, ± 5 kHz Deviation, FEC (Half Rate), DSSS = 1:2 or 1:4, 34 kHz RX Bandwidth)					
Sensitivity	2.5 kbps, BER = 10^{-2} , 868 MHz		-119		dBm
Sensitivity	5 kbps, BER = 10^{-2} , 868 MHz		-117		dBm
Saturation limit	2.5 kbps, BER = 10^{-2} , 868 MHz		10		dBm
Selectivity, ± 100 kHz	2.5 kbps, BER = 10^{-2} , 868 MHz ⁽¹⁾		49		dB
Selectivity, ± 200 kHz	2.5 kbps, BER = 10^{-2} , 868 MHz ⁽¹⁾		50		dB
Selectivity, ± 300 kHz	2.5 kbps, BER = 10^{-2} , 868 MHz ⁽¹⁾		51		dB
Blocking, ± 1 MHz	2.5 kbps, BER = 10^{-2} , 868 MHz ⁽¹⁾		63		dB
Blocking, ± 2 MHz	2.5 kbps, BER = 10^{-2} , 868 MHz ⁽¹⁾		68		dB
Blocking, ± 5 MHz	2.5 kbps, BER = 10^{-2} , 868 MHz ⁽¹⁾		78		dB
Blocking, ± 10 MHz	2.5 kbps, BER = 10^{-2} , 868 MHz ⁽¹⁾		87		dB

When measured on the CC1312PSIP-EM reference design with $T_c = 25\text{ }^\circ\text{C}$, $V_{DD5} = 3.0\text{ V}$ with DC/DC enabled and high power PA connected to V_{DD5} unless otherwise noted.

All measurements are performed at the antenna input. All measurements are performed conducted.

PARAMETER	TEST CONDITIONS	MIN	TYP	MAX	UNIT
Image rejection (image compensation enabled)	2.5 kbps, BER = 10^{-2} , 868 MHz ⁽¹⁾		45		dB
RSSI dynamic range	Starting from the sensitivity limit		97		dB
RSSI accuracy	Starting from the sensitivity limit across the given dynamic range		± 3		dB
Wireless M-Bus					
Receiver sensitivity, wM-BUS C-mode, 100 kbps $\pm 45\text{ kHz}$	Receiver Bandwidth 236 kHz, BER 1%		-104		dBm
Receiver sensitivity, wM-BUS T-mode, 100 kbps $\pm 50\text{ kHz}$	Receiver Bandwidth 236 kHz, BER 1%		-103		dBm
Receiver sensitivity, wM-BUS S2-mode, 32.768 kbps $\pm 50\text{ kHz}$	Receiver Bandwidth 196 kHz, BER 1%		-109		dBm
Receiver sensitivity, wM-BUS S1-mode, 32.768 kbps $\pm 50\text{ kHz}$	Receiver Bandwidth 311 kHz, BER 1%		-107		dBm
OOK, 4.8 kbps, 39 kHz RX Bandwidth					
Sensitivity	BER = 10^{-2} , 868 MHz		-112		dBm
Sensitivity	BER = 10^{-2} , 915 MHz		-112		dBm
Narrowband, 9.6 kbps $\pm 2.4\text{ kHz}$ deviation, 2-GFSK, 868 MHz, 17.1 kHz RX Bandwidth					
Sensitivity	1% BER		-115		dBm
Adjacent Channel Rejection	1% BER. Wanted signal 3 dB above the ETSI reference sensitivity limit (-104.6 dBm). Interferer $\pm 20\text{ kHz}$		39		dB
Alternate Channel Rejection	1% BER. Wanted signal 3 dB above the ETSI reference sensitivity limit (-104.6 dBm). Interferer $\pm 40\text{ kHz}$		40		dB
Blocking, $\pm 1\text{ MHz}$	1% BER. Wanted signal 3 dB above the ETSI reference sensitivity limit (-104.6 dBm).		65		dB
Blocking, $\pm 2\text{ MHz}$			69		dB
Blocking, $\pm 10\text{ MHz}$			85		dB
1 Mbps, $\pm 350\text{ kHz}$ deviation, 2-GFSK, 2.2 MHz RX Bandwidth					
Sensitivity	BER = 10^{-2} , 868 MHz		-94		dBm
Sensitivity	BER = 10^{-2} , 915 MHz		-93		dBm
Blocking, +2 MHz	BER = 10^{-2} , 915 MHz. Wanted signal 3 dB above sensitivity limit.		44		dB
Blocking, -2 MHz	BER = 10^{-2} , 915 MHz. Wanted signal 3 dB above sensitivity limit.		27		dB
Blocking, +10 MHz	BER = 10^{-2} , 915 MHz. Wanted signal 3 dB above sensitivity limit.		59		dB
Blocking, -10 MHz	BER = 10^{-2} , 915 MHz. Wanted signal 3 dB above sensitivity limit.		54		dB
Wi-SUN, 2-GFSK					
Sensitivity	50 kbps, $\pm 12.5\text{ kHz}$ deviation, 2-GFSK, 866.6 MHz, 68 kHz RX BW, 10% PER, 250 byte payload		-104		dBm
Selectivity, -100 kHz, 50 kbps, $\pm 12.5\text{ kHz}$ deviation, 2-GFSK, 866.6 MHz	50 kbps, $\pm 12.5\text{ kHz}$ deviation, 2-GFSK, 68 kHz RX Bandwidth, 866.6 MHz, 10% PER, 250 byte payload. Wanted signal 3 dB above sensitivity level		32		dB
Selectivity, +100 kHz, 50 kbps, $\pm 12.5\text{ kHz}$ deviation, 2-GFSK, 866.6 MHz			33		dB
Selectivity, $\pm 100\text{ kHz}$, 50 kbps, $\pm 12.5\text{ kHz}$ deviation, 2-GFSK, 866.6 MHz			30		dB
Selectivity, -200 kHz, 50 kbps, $\pm 12.5\text{ kHz}$ deviation, 2-GFSK, 866.6 MHz			36		dB
Selectivity, +200 kHz, 50 kbps, $\pm 12.5\text{ kHz}$ deviation, 2-GFSK, 866.6 MHz			38		dB
Selectivity, $\pm 200\text{ kHz}$, 50 kbps, $\pm 12.5\text{ kHz}$ deviation, 2-GFSK, 866.6 MHz			37		dB
Sensitivity	50 kbps, $\pm 25\text{ kHz}$ deviation, 2-GFSK, 98 kHz RX Bandwidth, 918.2 MHz, 10% PER, 250 byte payload		-104		dBm

When measured on the CC1312PSIP-EM reference design with $T_c = 25\text{ }^\circ\text{C}$, $V_{DD5} = 3.0\text{ V}$ with DC/DC enabled and high power PA connected to V_{DD5} unless otherwise noted.

All measurements are performed at the antenna input. All measurements are performed conducted.

PARAMETER	TEST CONDITIONS	MIN	TYP	MAX	UNIT
Selectivity, -200 kHz, 50 kbps, ± 25 kHz deviation, 2-GFSK, 918.2 MHz	50 kbps, ± 25 kHz deviation, 2-GFSK, 98 kHz RX Bandwidth, 918.2 MHz, 10% PER, 250 byte payload. Wanted signal 3 dB above sensitivity level		34		dB
Selectivity, +200 kHz, 50 kbps, ± 25 kHz deviation, 2-GFSK, 918.2 MHz			35		dB
Selectivity, ± 200 kHz, 50 kbps, ± 25 kHz deviation, 2-GFSK, 918.2 MHz			34		dB
Selectivity, -400 kHz, 50 kbps, ± 25 kHz deviation, 2-GFSK, 918.2 MHz			40		dB
Selectivity, +400 kHz, 50 kbps, ± 25 kHz deviation, 2-GFSK, 918.2 MHz			40		dB
Selectivity, ± 400 kHz, 50 kbps, ± 25 kHz deviation, 2-GFSK, 918.2 MHz			40		dB
Sensitivity	100 kbps, ± 25 kHz deviation, 2-GFSK, 866.6 MHz, 135 kHz RX BW, 10% PER, 250 byte payload		-102		dBm
Sensitivity	100 kbps, ± 25 kHz deviation, 2-GFSK, 918.2 MHz, 135 kHz RX BW, 10% PER, 250 byte payload		-101		dBm
Selectivity, -200 kHz, 100 kbps, ± 25 kHz deviation, 2-GFSK, 866.6 MHz	100 kbps, ± 25 kHz deviation, 2-GFSK, 135 kHz RX Bandwidth, 866.6 MHz, 10% PER, 250 byte payload. Wanted signal 3 dB above sensitivity level		37		dB
Selectivity, +200 kHz, 100 kbps, ± 25 kHz deviation, 2-GFSK, 866.6 MHz			38		dB
Selectivity, ± 200 kHz, 100 kbps, ± 25 kHz deviation, 2-GFSK, 866.6 MHz			37		dB
Selectivity, -400 kHz, 100 kbps, ± 25 kHz deviation, 2-GFSK, 866.6 MHz			45		dB
Selectivity, +400 kHz, 100 kbps, ± 25 kHz deviation, 2-GFSK, 866.6 MHz			45		dB
Selectivity, ± 400 kHz, 100 kbps, ± 25 kHz deviation, 2-GFSK, 866.6 MHz			45		dB
Sensitivity	100 kbps, ± 50 kHz deviation, 2-GFSK, 920.9 MHz, 196 kHz RX BW, 10% PER, 250 byte payload		-100		dBm
Selectivity, -400 kHz, 100 kbps, ± 50 kHz deviation, 2-GFSK, 920.9 MHz	100 kbps, ± 50 kHz deviation, 2-GFSK, 196 kHz RX Bandwidth, 920.9 MHz, 10% PER, 250 byte payload. Wanted signal 3 dB above sensitivity level		40		dB
Selectivity, +400 kHz, 100 kbps, ± 50 kHz deviation, 2-GFSK, 920.9 MHz			40		dB
Selectivity, ± 400 kHz, 100 kbps, ± 50 kHz deviation, 2-GFSK, 920.9 MHz			40		dB
Selectivity, -800 kHz, 100 kbps, ± 50 kHz deviation, 2-GFSK, 920.9 MHz			46		dB
Selectivity, +800 kHz, 100 kbps, ± 50 kHz deviation, 2-GFSK, 920.9 MHz			52		dB
Selectivity, ± 800 kHz, 100 kbps, ± 50 kHz deviation, 2-GFSK, 920.9 MHz			48		dB
Sensitivity	150 kbps, ± 37.5 kHz deviation, 2-GFSK, 918.4 MHz, 273 kHz RX BW, 10% PER, 250 byte payload		-96		dBm
Selectivity, -400 kHz, 150 kbps, ± 37.5 kHz deviation, 2-GFSK, 918.4 MHz	150 kbps, ± 37.5 kHz deviation, 2-GFSK, 273 kHz RX Bandwidth, 918.4 MHz, 10% PER, 250 byte payload. Wanted signal 3 dB above sensitivity level		41		dB
Selectivity, +400 kHz, 150 kbps, ± 37.5 kHz deviation, 2-GFSK, 918.4 MHz			42		dB
Selectivity, -800 kHz, 150 kbps, ± 37.5 kHz deviation, 2-GFSK, 918.4 MHz			46		dB
Selectivity, +800 kHz, 150 kbps, ± 37.5 kHz deviation, 2-GFSK, 918.4 MHz			49		dB
Sensitivity			-96		dBm

When measured on the CC1312PSIP-EM reference design with $T_c = 25\text{ }^\circ\text{C}$, $V_{DD5} = 3.0\text{ V}$ with DC/DC enabled and high power PA connected to V_{DD5} unless otherwise noted.

All measurements are performed at the antenna input. All measurements are performed conducted.

PARAMETER	TEST CONDITIONS	MIN	TYP	MAX	UNIT
Selectivity, -400 kHz, 150 kbps, ± 37.5 kHz deviation, 2-GFSK, 920.9 MHz	150 kbps, ± 37.5 kHz deviation, 2-GFSK, 273 kHz RX Bandwidth, 920.9 MHz, 10% PER, 250 byte payload. Wanted signal 3 dB above sensitivity level		40		dB
Selectivity, +400 kHz, 150 kbps, ± 37.5 kHz deviation, 2-GFSK, 920.9 MHz			42		dB
Selectivity, ± 400 kHz, 150 kbps, ± 37.5 kHz deviation, 2-GFSK, 920.9 MHz			40		dB
Selectivity, -800 kHz, 150 kbps, ± 37.5 kHz deviation, 2-GFSK, 920.9 MHz			46		dB
Selectivity, +800 kHz, 150 kbps, ± 37.5 kHz deviation, 2-GFSK, 920.9 MHz			49		dB
Selectivity, ± 800 kHz, 150 kbps, ± 37.5 kHz deviation, 2-GFSK, 920.9 MHz			46		dB
Sensitivity	200 kbps, ± 50 kHz deviation, 2-GFSK, 918.4 MHz, 273 kHz RX BW, 10% PER, 250 byte payload		-97		dBm
Selectivity, -400 kHz, 200 kbps, ± 50 kHz deviation, 2-GFSK, 918.4 MHz	200 kbps, ± 50 kHz deviation, 2-GFSK, 273 kHz RX Bandwidth, 918.4 MHz, 10% PER, 250 byte payload. Wanted signal 3 dB above sensitivity level		40		dB
Selectivity, +400 kHz, 200 kbps, ± 50 kHz deviation, 2-GFSK, 918.4 MHz			43		dB
Selectivity, ± 400 kHz, 200 kbps, ± 50 kHz deviation, 2-GFSK, 918.4 MHz			41		dB
Selectivity, -800 kHz, 200 kbps, ± 50 kHz deviation, 2-GFSK, 918.4 MHz			46		dB
Selectivity, +800 kHz, 200 kbps, ± 50 kHz deviation, 2-GFSK, 918.4 MHz			50		dB
Selectivity, ± 800 kHz, 200 kbps, ± 50 kHz deviation, 2-GFSK, 918.4 MHz			48		dB
Sensitivity	200 kbps, ± 100 kHz deviation, 2-GFSK, 920.8 MHz, 273 kHz RX BW, 10% PER, 250 byte payload		-96		dBm
Selectivity, -600 kHz, 200 kbps, ± 100 kHz deviation, 2-GFSK, 920.8 MHz	200 kbps, ± 100 kHz deviation, 2-GFSK, 273 kHz RX Bandwidth, 920.8 MHz, 10% PER, 250 byte payload. Wanted signal 3 dB above sensitivity level		43		dB
Selectivity, +600 kHz, 200 kbps, ± 100 kHz deviation, 2-GFSK, 920.8 MHz			47		dB
Selectivity, ± 600 kHz, 200 kbps, ± 100 kHz deviation, 2-GFSK, 920.8 MHz			44		dB
Selectivity, -1200 kHz, 200 kbps, ± 100 kHz deviation, 2-GFSK, 920.8 MHz			51		dB
Selectivity, +1200 kHz, 200 kbps, ± 100 kHz deviation, 2-GFSK, 920.8 MHz			54		dB
Selectivity, ± 1200 kHz, 200 kbps, ± 100 kHz deviation, 2-GFSK, 920.8 MHz			51		dB
Sensitivity	300 kbps, ± 75 kHz deviation, 2-GFSK, 917.6 MHz, 576 kHz RX BW, 10% PER, 250 byte payload		-94		dBm
Selectivity, -600 kHz, 300 kbps, ± 75 kHz deviation, 2-GFSK, 917.6 MHz	300 kbps, ± 75 kHz deviation, 2-GFSK, 576 kHz RX Bandwidth, 917.6 MHz, 10% PER, 250 byte payload. Wanted signal 3 dB above sensitivity level		27		dB
Selectivity, +600 kHz, 300 kbps, ± 75 kHz deviation, 2-GFSK, 917.6 MHz			45		dB
Selectivity, ± 600 kHz, 300 kbps, ± 75 kHz deviation, 2-GFSK, 917.6 MHz			35		dB
Selectivity, -1200 kHz, 300 kbps, ± 75 kHz deviation, 2-GFSK, 917.6 MHz			46		dB
Selectivity, +1200 kHz, 300 kbps, ± 75 kHz deviation, 2-GFSK, 920.8 MHz			50		dB
Selectivity, ± 1200 kHz, 300 kbps, ± 75 kHz deviation, 2-GFSK, 917.6 MHz			48		dB
WB-DSSS, 240/120/60/30 kbps (480 ksym/s, 2-GFSK, ± 195 kHz Deviation, FEC (Half Rate), DSSS = 1/2/4/8, 622 kHz RX BW)					
Sensitivity	240 kbps, DSSS = 1, BER = 10^{-2} , 915 MHz		-101		dBm
Sensitivity	120 kbps, DSSS = 2, BER = 10^{-2} , 915 MHz		-103		dBm

When measured on the CC1312PSIP-EM reference design with $T_c = 25\text{ }^\circ\text{C}$, $V_{\text{DDS}} = 3.0\text{ V}$ with DC/DC enabled and high power PA connected to V_{DDS} unless otherwise noted.

All measurements are performed at the antenna input. All measurements are performed conducted.

PARAMETER	TEST CONDITIONS	MIN	TYP	MAX	UNIT
Sensitivity	60 kbps, DSSS = 4, BER = 10^{-2} , 915 MHz		-105		dBm
Sensitivity	30 kbps, DSSS = 8, BER = 10^{-2} , 915 MHz		-106		dBm
Blocking ± 1 MHz	240 kbps, DSSS = 1, BER = 10^{-2} , 915 MHz		49		dB
Blocking ± 2 MHz	240 kbps, DSSS = 1, BER = 10^{-2} , 915 MHz		53		dB
Blocking ± 5 MHz	240 kbps, DSSS = 1, BER = 10^{-2} , 915 MHz		58		dB
Blocking ± 10 MHz	240 kbps, DSSS = 1, BER = 10^{-2} , 915 MHz		67		dB

(1) Wanted signal 3 dB above the reference sensitivity limit according to ETSI EN 300 220 v. 3.1.1

8.11 861 MHz to 1054 MHz - Transmit (TX)

Measured on the CC1312PSIP-EM reference design with $T_c = 25\text{ }^\circ\text{C}$, $V_{DD5} = 3.0\text{ V}$ with DC/DC enabled and high power PA connected to V_{DD5} using 2-GFSK, 50 kbps, $\pm 25\text{ kHz}$ deviation unless otherwise noted.

All measurements are performed at the antenna input. All measurements are performed conducted. ⁽¹⁾

PARAMETER		TEST CONDITIONS	MIN	TYP	MAX	UNIT
General parameters						
Max output power, boost mode Regular PA		VDDR = 1.95 V Minimum supply voltage (VDDS) for boost mode is 2.1 V 915 MHz		14		dBm
Max output power, Regular PA		868 MHz and 915 MHz		12.4		dBm
Max output power, High power PA		915 MHz VDDS = 3.3V		20		dBm
Output power programmable range Regular PA		868 MHz and 915 MHz		34		dB
Output power programmable range High power PA		868 MHz and 915 MHz VDDS = 3.3V		6		dB
Output power variation over temperature Regular PA		+10 dBm setting Over recommended temperature operating range		± 2		dB
Output power variation over temperature Boost mode, regular PA		+14 dBm setting Over recommended temperature operating range		± 1.5		dB
Spurious emissions and harmonics						
Spurious emissions (excluding harmonics) Regular PA ⁽¹⁾	30 MHz to 1 GHz	+14 dBm setting ETSI restricted bands		< -54		dBm
		+14 dBm setting ETSI outside restricted bands		< -36		dBm
	1 GHz to 12.75 GHz (outside ETSI restricted bands)	+14 dBm setting measured in 1 MHz bandwidth (ETSI)		< -30		dBm
Spurious emissions out- of-band Regular PA, 915 MHz ⁽¹⁾	30 MHz to 88 MHz (within FCC restricted bands)	+14 dBm setting		< -56		dBm
	88 MHz to 216 MHz (within FCC restricted bands)	+14 dBm setting		< -52		dBm
	216 MHz to 960 MHz (within FCC restricted bands)	+14 dBm setting		< -50		dBm
	960 MHz to 2390 MHz and above 2483.5 MHz (within FCC restricted band)	+14 dBm setting		< -42		dBm
	1 GHz to 12.75 GHz (outside FCC restricted bands)	+14 dBm setting		< -40		dBm
Spurious emissions out- of-band High power PA, 915 MHz ⁽¹⁾	30 MHz to 88 MHz (within FCC restricted bands)	+20 dBm setting, VDDS = 3.3 V		< -55		dBm
	88 MHz to 216 MHz (within FCC restricted bands)	+20 dBm setting, VDDS = 3.3 V		< -52		dBm
	216 MHz to 960 MHz (within FCC restricted bands)	+20 dBm setting, VDDS = 3.3 V		< -49		dBm
	960 MHz to 2390 MHz and above 2483.5 MHz (within FCC restricted band)	+20 dBm setting, VDDS = 3.3 V		< -41		dBm
	1 GHz to 12.75 GHz (outside FCC restricted bands)	+20 dBm setting, VDDS = 3.3 V		< -20		dBm

Measured on the CC1312PSIP-EM reference design with $T_c = 25\text{ }^\circ\text{C}$, $V_{DD5} = 3.0\text{ V}$ with DC/DC enabled and high power PA connected to V_{DD5} using 2-GFSK, 50 kbps, $\pm 25\text{ kHz}$ deviation unless otherwise noted. All measurements are performed at the antenna input. All measurements are performed conducted. ⁽¹⁾

PARAMETER		TEST CONDITIONS	MIN	TYP	MAX	UNIT
Spurious emissions out-of-band Regular PA, 920.6/928 MHz ⁽¹⁾	Below 710 MHz (ARIB T-108)	+14 dBm setting		< -36		dBm
	710 MHz to 900 MHz (ARIB T-108)	+14 dBm setting		< -55		dBm
	900 MHz to 915 MHz (ARIB T-108)	+14 dBm setting		< -55		dBm
	930 MHz to 1000 MHz (ARIB T-108)	+14 dBm setting		< -55		dBm
	1000 MHz to 1215 MHz (ARIB T-108)	+14 dBm setting		< -45		dBm
	Above 1215 MHz (ARIB T-108)	+14 dBm setting		< -30		dBm
Harmonics Regular PA	Second harmonic	+14 dBm setting, 868 MHz		< -30		dBm
		+14 dBm setting, 915 MHz		< -30		
	Third harmonic	+14 dBm setting, 868 MHz		< -30		dBm
		+14 dBm setting, 915 MHz		< -42		
	Fourth harmonic	+14 dBm setting, 868 MHz		< -30		dBm
		+14 dBm setting, 915 MHz		< -42		
Fifth harmonic	+14 dBm setting, 868 MHz		< -30		dBm	
	+14 dBm setting, 915 MHz		< -42			
Harmonics High power PA	Second harmonic	+20 dBm setting, $V_{DD5} = 3.3\text{ V}$, 915 MHz		-32		dBm
	Third harmonic	+20 dBm setting, $V_{DD5} = 3.3\text{ V}$, 915 MHz		-44		dBm
	Fourth harmonic	+20 dBm setting, $V_{DD5} = 3.3\text{ V}$, 915 MHz		-38		dBm
	Fifth harmonic	+20 dBm setting, $V_{DD5} = 3.3\text{ V}$, 915 MHz		-47		dBm
	Second harmonic	+19 dBm setting, $V_{DD5} = 3.3\text{ V}$, 915 MHz		-30		dBm
	Third harmonic	+19 dBm setting, $V_{DD5} = 3.3\text{ V}$, 915 MHz		-50		dBm
	Fourth harmonic	+19 dBm setting, $V_{DD5} = 3.3\text{ V}$, 915 MHz		-45		dBm
	Fifth harmonic	+19 dBm setting, $V_{DD5} = 3.3\text{ V}$, 915 MHz		-44		dBm
Adjacent Channel Power						
Adjacent channel power, regular 14 dBm PA	Adjacent channel, 20 kHz offset. 9.6 kbps, $h=0.5$	12.5 dBm setting. 868.3 MHz. 14 kHz channel BW		-24		dBm
Alternate channel power, regular 14 dBm PA	Alternate channel, 40 kHz offset. 9.6 kbps, $h=0.5$	12.5 dBm setting. 868.3 MHz. 14 kHz channel BW		-31		dBm

(1) Suitable for systems targeting compliance with EN 300 220, EN 303 131, EN 303 204, FCC CFR47 Part 15, ARIB STD-T108.

8.12 861 MHz to 1054 MHz - PLL Phase Noise Wideband Mode

When measured on the reference design with $T_c = 25\text{ }^\circ\text{C}$, $V_{DD5} = 3.0\text{ V}$.

PARAMETER	TEST CONDITIONS	MIN	TYP	MAX	UNIT
Phase noise in the 868- and 915-MHz bands 20 kHz PLL loop bandwidth	$\pm 10\text{ kHz}$ offset		-74		dBc/Hz
	$\pm 100\text{ kHz}$ offset		-97		dBc/Hz
	$\pm 200\text{ kHz}$ offset		-107		dBc/Hz
	$\pm 400\text{ kHz}$ offset		-113		dBc/Hz
	$\pm 1000\text{ kHz}$ offset		-120		dBc/Hz
	$\pm 2000\text{ kHz}$ offset		-127		dBc/Hz
	$\pm 10000\text{ kHz}$ offset		-141		dBc/Hz

8.13 861 MHz to 1054 MHz - PLL Phase Noise Narrowband Mode

When measured on the reference design with $T_c = 25\text{ }^\circ\text{C}$, $V_{DD5} = 3.0\text{ V}$.

PARAMETER	TEST CONDITIONS	MIN	TYP	MAX	UNIT
Phase noise in the 868- and 915-MHz bands 150 kHz PLL loop bandwidth	±10 kHz offset		-93		dBc/Hz
	±100 kHz offset		-93		dBc/Hz
	±200 kHz offset		-95		dBc/Hz
	±400 kHz offset		-104		dBc/Hz
	±1000 kHz offset		-121		dBc/Hz
	±2000 kHz offset		-130		dBc/Hz
	±10000 kHz offset		-140		dBc/Hz

8.14 Timing and Switching Characteristics

8.14.1 Reset Timing

PARAMETER	MIN	TYP	MAX	UNIT
RESET_N low duration	1			µs

8.14.2 Wakeup Timing

Measured over operating free-air temperature with $V_{DD5} = 3.0\text{ V}$ (unless otherwise noted). The times listed here do not include software overhead.

PARAMETER	TEST CONDITIONS	MIN	TYP	MAX	UNIT
MCU, Reset to Active ⁽¹⁾		850 - 4000			µs
MCU, Shutdown to Active ⁽¹⁾		850 - 4000			µs
MCU, Standby to Active		165			µs
MCU, Active to Standby		39			µs
MCU, Idle to Active		15			µs

- (1) The wakeup time is dependent on remaining charge on VDDR capacitor when starting the device, and thus how long the device has been in Reset or Shutdown before starting up again.

8.14.3 Clock Specifications

8.14.3.1 48 MHz Crystal Oscillator (XOSC_HF) and RF frequency accuracy

The module contains a 48 MHz crystal that is connected to the oscillator. The crystal is calibrated in production and the RF frequency is temperature compensated in software see [Clock Systems](#) for more information. Measured on a Texas Instruments reference design with $T_c = 25\text{ }^\circ\text{C}$, $V_{DD5} = 3.0\text{ V}$, unless otherwise noted.

PARAMETER	MIN	TYP	MAX	UNIT
Crystal frequency		48		MHz
Crystal oscillator start-up time ⁽¹⁾		200		µs
48 MHz initial frequency accuracy at 25°	-5	2	5	ppm
48 MHz frequency stability, temperature drift -40° to 105°	-16		18	ppm
Crystal aging, 5 years	-2		2	ppm
Crystal aging, 10 years	-4		2	ppm
RF Frequency accuracy including internal software compensated temperature drift, excluding aging, -40° to 65°. Based on estimated crystal drift across temperature from the crystal manufacturer's specification	-10		10	ppm

- (1) Start-up time using the TI-provided power driver. Start-up time may increase if driver is not used.

8.14.3.2 48 MHz RC Oscillator (RCOSC_HF)

Measured on a Texas Instruments reference design with $T_c = 25\text{ }^\circ\text{C}$, $V_{DD5} = 3.0\text{ V}$, unless otherwise noted.

PARAMETER	MIN	TYP	MAX	UNIT
Frequency		48		MHz
Uncalibrated frequency accuracy		±1		%
Calibrated frequency accuracy ⁽¹⁾		±0.25		%

Measured on a Texas Instruments reference design with $T_c = 25\text{ }^\circ\text{C}$, $V_{DD5} = 3.0\text{ V}$, unless otherwise noted.

	MIN	TYP	MAX	UNIT
Start-up time		5		μs

(1) Accuracy relative to the calibration source (XOSC_HF)

8.14.3.3 2 MHz RC Oscillator (RCOSC_MF)

Measured on a Texas Instruments reference design with $T_c = 25\text{ }^\circ\text{C}$, $V_{DD5} = 3.0\text{ V}$, unless otherwise noted.

	MIN	TYP	MAX	UNIT
Calibrated frequency		2		MHz
Start-up time		5		μs

8.14.3.4 32.768 kHz Crystal Oscillator (XOSC_LF) and RTC accuracy

The module contains a 32.768 kHz crystal that is connected to the oscillator. The RTC based on the 32.768 kHz crystal is calibrated in production and is temperature compensated in software, see [Clock Systems](#) for more information. Measured on a Texas Instruments reference design with $T_c = 25\text{ }^\circ\text{C}$, $V_{DD5} = 3.0\text{ V}$, unless otherwise noted.

	MIN	TYP	MAX	UNIT
Crystal frequency		32.768		kHz
Initial frequency accuracy at 25°	-20		20	ppm
32kHz crystal aging, first year	-3		3	ppm
Real Time Clock (RTC) accuracy using temperature compensation for the 32kHz xtal (if enabled in software), excluding aging, -40° to 105° degrees. Based on estimated crystal drift across temperature from the manufacturer's crystal specification.	-100		50	ppm
Real Time Clock (RTC) accuracy using temperature compensation for the 32kHz xtal (if enabled in software), excluding aging, -40° to 65° degrees. Based on estimated crystal drift across temperature from the manufacturer's crystal specification.	-50		50	ppm

8.14.3.5 32 kHz RC Oscillator (RCOSC_LF)

Measured on a Texas Instruments reference design with $T_c = 25\text{ }^\circ\text{C}$, $V_{DD5} = 3.0\text{ V}$, unless otherwise noted.

	MIN	TYP	MAX	UNIT
Frequency		32.8		kHz
Calibrated RTC variation ⁽¹⁾	Calibrated periodically against XOSC_HF ⁽²⁾		± 600 ⁽³⁾	ppm
Temperature coefficient		50		ppm/ $^\circ\text{C}$

- (1) When using RCOSC_LF as source for the low frequency system clock (SCLK_LF), the accuracy of the SCLK_LF-derived Real Time Clock (RTC) can be improved by measuring RCOSC_LF relative to XOSC_HF and compensating for the RTC tick speed. This functionality is available through the TI-provided Power driver. Note that since the SIP module already contains a 32kHz crystal, using the RCOSC_LF will be less relevant.
- (2) TI driver software calibrates the RTC every time XOSC_HF is enabled.
- (3) Some device's variation can exceed 1000 ppm. Further calibration will not improve variation.

8.14.4 Synchronous Serial Interface (SSI) Characteristics

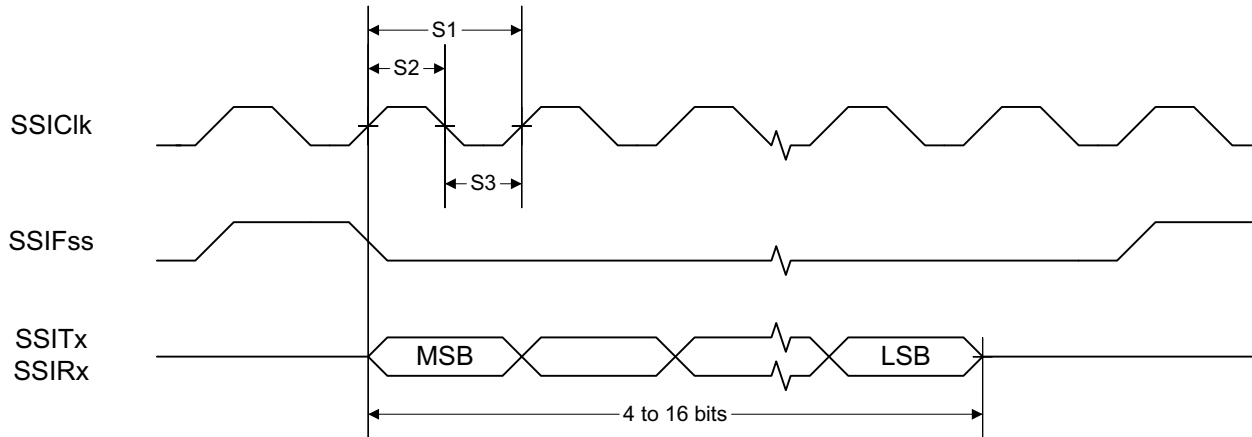

Figure 8-1. SSI Timing for TI Frame Format (FRF = 01), Single Transfer Timing Measurement

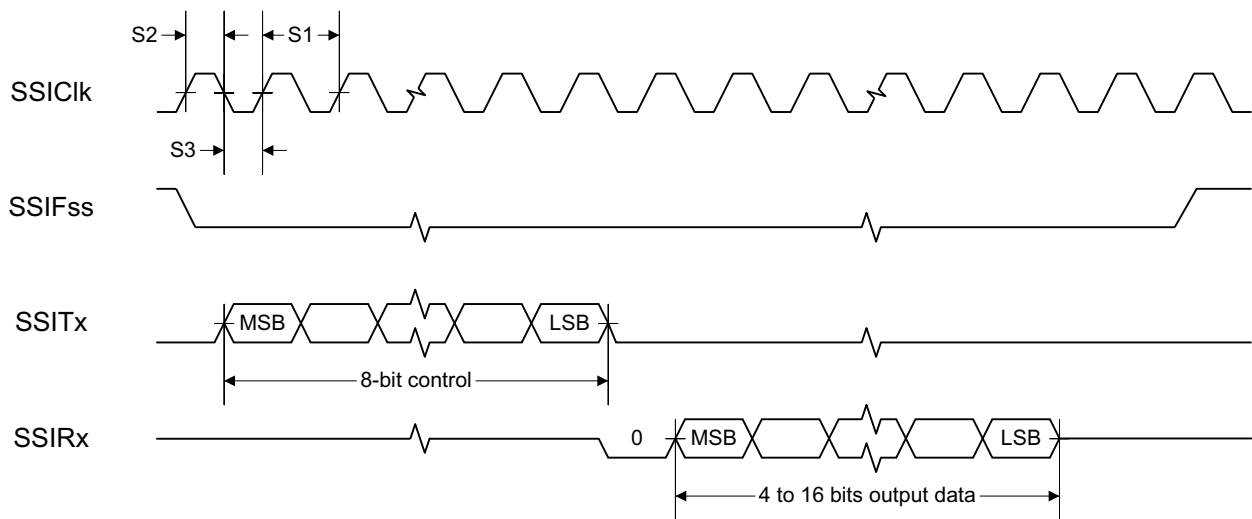

Figure 8-2. SSI Timing for MICROWIRE Frame Format (FRF = 10), Single Transfer

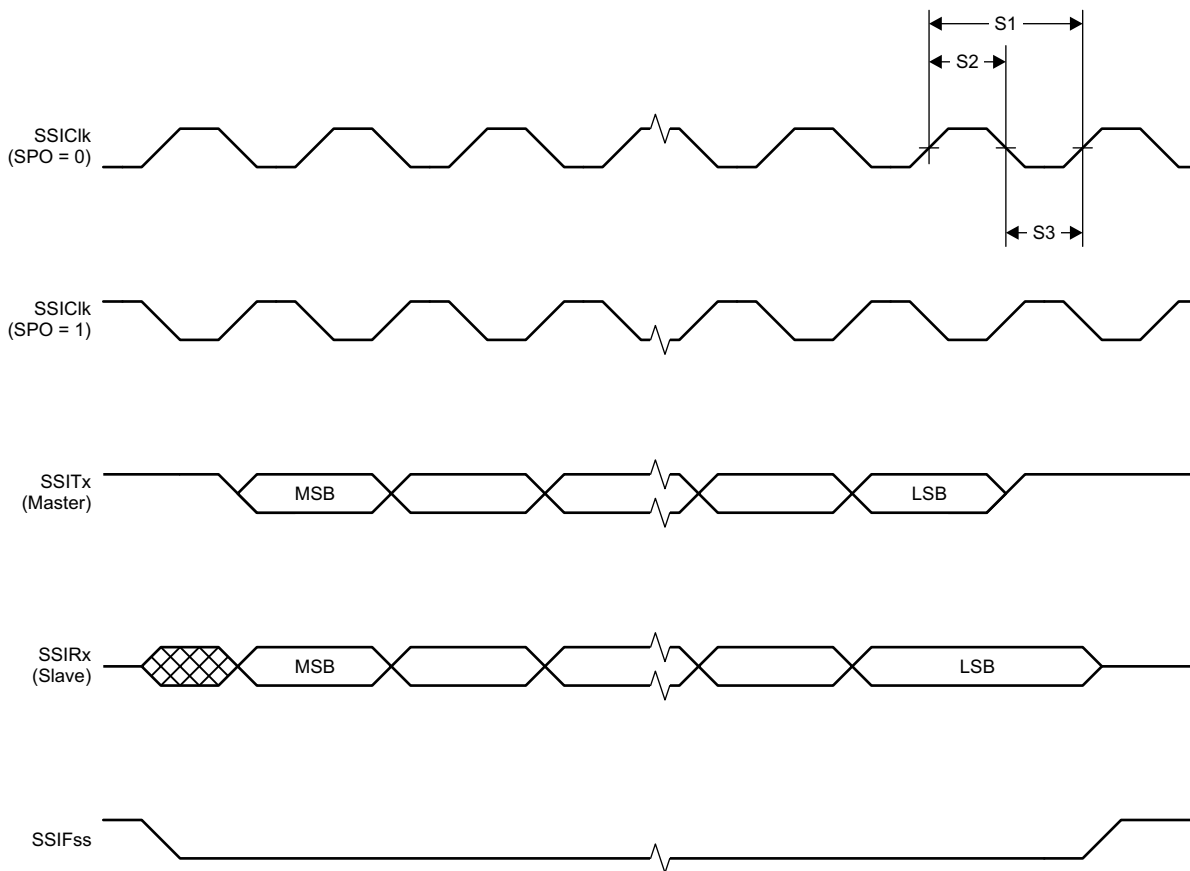

Figure 8-3. SSI Timing for SPI Frame Format (FRF = 00), With SPH = 1

8.14.4.1.1 Synchronous Serial Interface (SSI) Characteristics

over operating free-air temperature range (unless otherwise noted)

PARAMETER NO.	PARAMETER		MIN	TYP	MAX	UNIT
S1	$t_{\text{clk_per}}$	SSIClk cycle time	12		65024	System Clocks ⁽²⁾
S2 ⁽¹⁾	$t_{\text{clk_high}}$	SSIClk high time		0.5		$t_{\text{clk_per}}$
S3 ⁽¹⁾	$t_{\text{clk_low}}$	SSIClk low time		0.5		$t_{\text{clk_per}}$

(1) Refer to SSI timing diagrams [Figure 8-1](#), [Figure 8-2](#) and [Figure 8-3](#).

(2) When using the TI-provided Power driver, the SSI system clock is always 48 MHz.

8.14.5 UART

8.14.5.1 UART Characteristics

over operating free-air temperature range (unless otherwise noted)

PARAMETER	MIN	TYP	MAX	UNIT
UART rate			3	MBaud

8.15 Peripheral Characteristics

8.15.1 ADC

8.15.1.1 Analog-to-Digital Converter (ADC) Characteristics

$T_C = 25\text{ }^\circ\text{C}$, $V_{DD5} = 3.0\text{ V}$ and voltage scaling enabled, unless otherwise noted. ⁽¹⁾

Performance numbers require use of offset and gain adjustments in software by TI-provided ADC drivers.

PARAMETER		TEST CONDITIONS	MIN	TYP	MAX	UNIT
	Input voltage range		0		V _{DD5}	V
	Resolution			12		Bits
	Sample Rate				200	ksps
	Offset	Internal 4.3 V equivalent reference ⁽²⁾		±2		LSB
	Gain error	Internal 4.3 V equivalent reference ⁽²⁾		±7		LSB
DNL ⁽⁴⁾	Differential nonlinearity			>−1		LSB
INL	Integral nonlinearity			±4		LSB
ENOB	Effective number of bits	Internal 4.3 V equivalent reference ⁽²⁾ , 200 kSamples/s, 9.6 kHz input tone		9.8		Bits
		Internal 4.3 V equivalent reference ⁽²⁾ , 200 kSamples/s, 9.6 kHz input tone, DC/DC enabled		9.8		
		V _{DD5} as reference, 200 kSamples/s, 9.6 kHz input tone		10.1		
		Internal reference, voltage scaling disabled, 32 samples average, 200 kSamples/s, 300 Hz input tone		11.1		
		Internal reference, voltage scaling disabled, 14-bit mode, 200 kSamples/s, 600 Hz input tone ⁽⁵⁾		11.3		
		Internal reference, voltage scaling disabled, 15-bit mode, 200 kSamples/s, 150 Hz input tone ⁽⁵⁾		11.6		
THD	Total harmonic distortion	Internal 4.3 V equivalent reference ⁽²⁾ , 200 kSamples/s, 9.6 kHz input tone		−65		dB
		V _{DD5} as reference, 200 kSamples/s, 9.6 kHz input tone		−70		
		Internal reference, voltage scaling disabled, 32 samples average, 200 kSamples/s, 300 Hz input tone		−72		
SINAD, SNDR	Signal-to-noise and distortion ratio	Internal 4.3 V equivalent reference ⁽²⁾ , 200 kSamples/s, 9.6 kHz input tone		60		dB
		V _{DD5} as reference, 200 kSamples/s, 9.6 kHz input tone		63		
		Internal reference, voltage scaling disabled, 32 samples average, 200 kSamples/s, 300 Hz input tone		68		
SFDR	Spurious-free dynamic range	Internal 4.3 V equivalent reference ⁽²⁾ , 200 kSamples/s, 9.6 kHz input tone		70		dB
		V _{DD5} as reference, 200 kSamples/s, 9.6 kHz input tone		73		
		Internal reference, voltage scaling disabled, 32 samples average, 200 kSamples/s, 300 Hz input tone		75		
	Conversion time	Serial conversion, time-to-output, 24 MHz clock		50		Clock Cycles
	Current consumption	Internal 4.3 V equivalent reference ⁽²⁾		0.40		mA
	Current consumption	V _{DD5} as reference		0.57		mA
	Reference voltage	Equivalent fixed internal reference (input voltage scaling enabled). For best accuracy, the ADC conversion should be initiated through the TI-RTOS API in order to include the gain/offset compensation factors stored in FCFG1		4.3 ⁽²⁾ ⁽³⁾		V
	Reference voltage	Fixed internal reference (input voltage scaling disabled). For best accuracy, the ADC conversion should be initiated through the TI-RTOS API in order to include the gain/offset compensation factors stored in FCFG1. This value is derived from the scaled value (4.3 V) as follows: $V_{ref} = 4.3\text{ V} \times 1408 / 4095$		1.48		V
	Reference voltage	V _{DD5} as reference, input voltage scaling enabled		V _{DD5}		V
	Reference voltage	V _{DD5} as reference, input voltage scaling disabled		V _{DD5} / 2.82 ⁽³⁾		V

$T_c = 25\text{ }^\circ\text{C}$, $V_{DDs} = 3.0\text{ V}$ and voltage scaling enabled, unless otherwise noted. ⁽¹⁾
 Performance numbers require use of offset and gain adjustments in software by TI-provided ADC drivers.

PARAMETER		TEST CONDITIONS	MIN	TYP	MAX	UNIT
	Input impedance	200 kSamples/s, voltage scaling enabled. Capacitive input, Input impedance depends on sampling frequency and sampling time		>1		MΩ

- (1) Using IEEE Std 1241-2010 for terminology and test methods
- (2) Input signal scaled down internally before conversion, as if voltage range was 0 to 4.3 V
- (3) Applied voltage must be within [Section 8.1](#) at all times
- (4) No missing codes
- (5) $\text{ADC_output} = \sum(4^n \text{ samples}) \gg n$, $n = \text{desired extra bits}$

8.15.2 DAC

8.15.2.1 Digital-to-Analog Converter (DAC) Characteristics

$T_c = 25\text{ }^\circ\text{C}$, $V_{DD5} = 3.0\text{ V}$, unless otherwise noted.

PARAMETER		TEST CONDITIONS	MIN	TYP	MAX	UNIT
General Parameters						
	Resolution			8		Bits
V_{DD5}	Supply voltage	Any load, any V_{REF} , pre-charge OFF, DAC charge-pump ON	1.8		3.8	V
		External Load ⁽⁴⁾ , any V_{REF} , pre-charge OFF, DAC charge-pump OFF	2.0		3.8	
		Any load, $V_{REF} = \text{DCOUP}$ L, pre-charge ON	2.6		3.8	
F_{DAC}	Clock frequency	Buffer ON (recommended for external load)	16		250	kHz
		Buffer OFF (internal load)	16		1000	
	Voltage output settling time	$V_{REF} = V_{DD5}$, buffer OFF, internal load		13		1 / F_{DAC}
		$V_{REF} = V_{DD5}$, buffer ON, external capacitive load = 20 pF ⁽³⁾		13.8		
	External capacitive load			20	200	pF
	External resistive load		10			MΩ
	Short circuit current				400	μA
Z_{MAX}	Max output impedance $V_{ref} = V_{DD5}$, buffer ON, CLK 250 kHz	$V_{DD5} = 3.8\text{ V}$, DAC charge-pump OFF		50.8		kΩ
		$V_{DD5} = 3.0\text{ V}$, DAC charge-pump ON		51.7		
		$V_{DD5} = 3.0\text{ V}$, DAC charge-pump OFF		53.2		
		$V_{DD5} = 2.0\text{ V}$, DAC charge-pump ON		48.7		
		$V_{DD5} = 2.0\text{ V}$, DAC charge-pump OFF		70.2		
		$V_{DD5} = 1.8\text{ V}$, DAC charge-pump ON		46.3		
		$V_{DD5} = 1.8\text{ V}$, DAC charge-pump OFF		88.9		
Internal Load - Continuous Time Comparator / Low Power Clocked Comparator						
DNL	Differential nonlinearity	$V_{REF} = V_{DD5}$, load = Continuous Time Comparator or Low Power Clocked Comparator $F_{DAC} = 250\text{ kHz}$		±1		LSB ⁽¹⁾
	Differential nonlinearity	$V_{REF} = V_{DD5}$, load = Continuous Time Comparator or Low Power Clocked Comparator $F_{DAC} = 16\text{ kHz}$		±1.2		
	Offset error ⁽²⁾ Load = Continuous Time Comparator	$V_{REF} = V_{DD5} = 3.8\text{ V}$		±0.64		LSB ⁽¹⁾
		$V_{REF} = V_{DD5} = 3.0\text{ V}$		±0.81		
		$V_{REF} = V_{DD5} = 1.8\text{ V}$		±1.27		
		$V_{REF} = \text{DCOUP}$ L, pre-charge ON		±3.43		
		$V_{REF} = \text{DCOUP}$ L, pre-charge OFF		±2.88		
		$V_{REF} = \text{ADCRE}$ F		±2.37		
	Offset error ⁽²⁾ Load = Low Power Clocked Comparator	$V_{REF} = V_{DD5} = 3.8\text{ V}$		±0.78		LSB ⁽¹⁾
		$V_{REF} = V_{DD5} = 3.0\text{ V}$		±0.77		
		$V_{REF} = V_{DD5} = 1.8\text{ V}$		±3.46		
		$V_{REF} = \text{DCOUP}$ L, pre-charge ON		±3.44		
		$V_{REF} = \text{DCOUP}$ L, pre-charge OFF		±4.70		
		$V_{REF} = \text{ADCRE}$ F		±4.11		
	Max code output voltage variation ⁽²⁾ Load = Continuous Time Comparator	$V_{REF} = V_{DD5} = 3.8\text{ V}$		±1.53		LSB ⁽¹⁾
		$V_{REF} = V_{DD5} = 3.0\text{ V}$		±1.71		
		$V_{REF} = V_{DD5} = 1.8\text{ V}$		±2.10		
		$V_{REF} = \text{DCOUP}$ L, pre-charge ON		±6.00		
		$V_{REF} = \text{DCOUP}$ L, pre-charge OFF		±3.85		
		$V_{REF} = \text{ADCRE}$ F		±5.84		

$T_c = 25\text{ }^\circ\text{C}$, $V_{DD5} = 3.0\text{ V}$, unless otherwise noted.

PARAMETER		TEST CONDITIONS	MIN	TYP	MAX	UNIT
	Max code output voltage variation ⁽²⁾ Load = Low Power Clocked Comparator	$V_{REF} = V_{DD5} = 3.8\text{ V}$		± 2.92		LSB ⁽¹⁾
		$V_{REF} = V_{DD5} = 3.0\text{ V}$		± 3.06		
		$V_{REF} = V_{DD5} = 1.8\text{ V}$		± 3.91		
		$V_{REF} = \text{DCOUP}, \text{pre-charge ON}$		± 7.84		
		$V_{REF} = \text{DCOUP}, \text{pre-charge OFF}$		± 4.06		
		$V_{REF} = \text{ADCREf}$		± 6.94		
	Output voltage range ⁽²⁾ Load = Continuous Time Comparator	$V_{REF} = V_{DD5} = 3.8\text{ V}, \text{code } 1$		0.03		V
		$V_{REF} = V_{DD5} = 3.8\text{ V}, \text{code } 255$		3.62		
		$V_{REF} = V_{DD5} = 3.0\text{ V}, \text{code } 1$		0.02		
		$V_{REF} = V_{DD5} = 3.0\text{ V}, \text{code } 255$		2.86		
		$V_{REF} = V_{DD5} = 1.8\text{ V}, \text{code } 1$		0.01		
		$V_{REF} = V_{DD5} = 1.8\text{ V}, \text{code } 255$		1.71		
		$V_{REF} = \text{DCOUP}, \text{pre-charge OFF}, \text{code } 1$		0.01		
		$V_{REF} = \text{DCOUP}, \text{pre-charge OFF}, \text{code } 255$		1.21		
		$V_{REF} = \text{DCOUP}, \text{pre-charge ON}, \text{code } 1$		1.27		
		$V_{REF} = \text{DCOUP}, \text{pre-charge ON}, \text{code } 255$		2.46		
		$V_{REF} = \text{ADCREf}, \text{code } 1$		0.01		
		$V_{REF} = \text{ADCREf}, \text{code } 255$		1.41		
			Output voltage range ⁽²⁾ Load = Low Power Clocked Comparator	$V_{REF} = V_{DD5} = 3.8\text{ V}, \text{code } 1$		
$V_{REF} = V_{DD5} = 3.8\text{ V}, \text{code } 255$				3.61		
$V_{REF} = V_{DD5} = 3.0\text{ V}, \text{code } 1$				0.02		
$V_{REF} = V_{DD5} = 3.0\text{ V}, \text{code } 255$				2.85		
$V_{REF} = V_{DD5} = 1.8\text{ V}, \text{code } 1$				0.01		
$V_{REF} = V_{DD5} = 1.8\text{ V}, \text{code } 255$				1.71		
$V_{REF} = \text{DCOUP}, \text{pre-charge OFF}, \text{code } 1$				0.01		
$V_{REF} = \text{DCOUP}, \text{pre-charge OFF}, \text{code } 255$				1.21		
$V_{REF} = \text{DCOUP}, \text{pre-charge ON}, \text{code } 1$				1.27		
$V_{REF} = \text{DCOUP}, \text{pre-charge ON}, \text{code } 255$				2.46		
$V_{REF} = \text{ADCREf}, \text{code } 1$				0.01		
$V_{REF} = \text{ADCREf}, \text{code } 255$				1.41		
External Load						
INL	Integral nonlinearity	$V_{REF} = V_{DD5}, F_{DAC} = 250\text{ kHz}$		± 1		LSB ⁽¹⁾
		$V_{REF} = \text{DCOUP}, F_{DAC} = 250\text{ kHz}$		± 2		
		$V_{REF} = \text{ADCREf}, F_{DAC} = 250\text{ kHz}$		± 1		
DNL	Differential nonlinearity	$V_{REF} = V_{DD5}, F_{DAC} = 250\text{ kHz}$		± 1		LSB ⁽¹⁾
	Offset error	$V_{REF} = V_{DD5} = 3.8\text{ V}$		± 0.40		LSB ⁽¹⁾
		$V_{REF} = V_{DD5} = 3.0\text{ V}$		± 0.50		
		$V_{REF} = V_{DD5} = 1.8\text{ V}$		± 0.75		
		$V_{REF} = \text{DCOUP}, \text{pre-charge ON}$		± 1.55		
		$V_{REF} = \text{DCOUP}, \text{pre-charge OFF}$		± 1.30		
		$V_{REF} = \text{ADCREf}$		± 1.10		
	Max code output voltage variation	$V_{REF} = V_{DD5} = 3.8\text{ V}$		± 1.00		LSB ⁽¹⁾
		$V_{REF} = V_{DD5} = 3.0\text{ V}$		± 1.00		
		$V_{REF} = V_{DD5} = 1.8\text{ V}$		± 1.00		
		$V_{REF} = \text{DCOUP}, \text{pre-charge ON}$		± 3.45		
		$V_{REF} = \text{DCOUP}, \text{pre-charge OFF}$		± 2.10		
		$V_{REF} = \text{ADCREf}$		± 1.90		

$T_c = 25\text{ }^\circ\text{C}$, $V_{DD5} = 3.0\text{ V}$, unless otherwise noted.

PARAMETER		TEST CONDITIONS	MIN	TYP	MAX	UNIT
Output voltage range Load = Low Power Clocked Comparator		$V_{REF} = V_{DD5} = 3.8\text{ V}$, code 1		0.03		V
		$V_{REF} = V_{DD5} = 3.8\text{ V}$, code 255		3.61		
		$V_{REF} = V_{DD5} = 3.0\text{ V}$, code 1		0.02		
		$V_{REF} = V_{DD5} = 3.0\text{ V}$, code 255		2.85		
		$V_{REF} = V_{DD5} = 1.8\text{ V}$, code 1		0.02		
		$V_{REF} = V_{DD5} = 1.8\text{ V}$, code 255		1.71		
		$V_{REF} = \text{DCOUP}$, pre-charge OFF, code 1		0.02		
		$V_{REF} = \text{DCOUP}$, pre-charge OFF, code 255		1.20		
		$V_{REF} = \text{DCOUP}$, pre-charge ON, code 1		1.27		
		$V_{REF} = \text{DCOUP}$, pre-charge ON, code 255		2.46		
		$V_{REF} = \text{ADCRE}$, code 1		0.02		
		$V_{REF} = \text{ADCRE}$, code 255		1.42		

- (1) 1 LSB ($V_{REF} 3.8\text{ V}/3.0\text{ V}/1.8\text{ V}/\text{DCOUP}/\text{ADCRE}$) = 14.10 mV/11.13 mV/6.68 mV/4.67 mV/5.48 mV
- (2) Includes comparator offset
- (3) A load > 20 pF will increase the settling time
- (4) Keysight 34401A Multimeter

8.15.3 Temperature and Battery Monitor

8.15.3.1 Temperature Sensor

Measured on a Texas Instruments reference design with $T_c = 25\text{ °C}$, $V_{DD5} = 3.0\text{ V}$, unless otherwise noted.

PARAMETER	TEST CONDITIONS	MIN	TYP	MAX	UNIT
Resolution			2		°C
Accuracy	-40 °C to 0 °C		±5.0		°C
Accuracy	0 °C to 105 °C		±3.5		°C
Supply voltage coefficient ⁽¹⁾			3.6		°C/V

(1) The temperature sensor is automatically compensated for V_{DD5} variation when using the TI-provided temperature driver.

8.15.3.2 Battery Monitor

Measured on a Texas Instruments reference design with $T_c = 25\text{ °C}$, unless otherwise noted.

PARAMETER	TEST CONDITIONS	MIN	TYP	MAX	UNIT
Resolution			25		mV
Range		1.8		3.8	V
Integral nonlinearity (max)			23		mV
Accuracy	$V_{DD5} = 3.0\text{ V}$		22.5		mV
Offset error			-32		mV
Gain error			-1		%

8.15.4 Comparators

8.15.4.1 Low-Power Clocked Comparator

$T_c = 25\text{ }^\circ\text{C}$, $V_{DD5} = 3.0\text{ V}$, unless otherwise noted.

PARAMETER	TEST CONDITIONS	MIN	TYP	MAX	UNIT
Input voltage range		0		V_{DD5}	V
Clock frequency			SCLK_LF		
Internal reference voltage ⁽¹⁾	Using internal DAC with V_{DD5} as reference voltage, DAC code = 0 - 255		0.024 - 2.865		V
Offset	Measured at $V_{DD5} / 2$, includes error from internal DAC		± 5		mV
Decision time	Step from -50 mV to 50 mV		1		Clock Cycle

- (1) The comparator can use an internal 8 bits DAC as its reference. The DAC output voltage range depends on the reference voltage selected. See [Section 8.15.2.1](#).

8.15.4.2 Continuous Time Comparator

$T_c = 25\text{ }^\circ\text{C}$, $V_{DD5} = 3.0\text{ V}$, unless otherwise noted.

PARAMETER	TEST CONDITIONS	MIN	TYP	MAX	UNIT
Input voltage range ⁽¹⁾		0		V_{DD5}	V
Offset	Measured at $V_{DD5} / 2$		± 5		mV
Decision time	Step from -10 mV to 10 mV		0.70		μs
Current consumption	Internal reference		8.0		μA

- (1) The input voltages can be generated externally and connected throughout I/Os or an internal reference voltage can be generated using the DAC

8.15.5 Current Source

8.15.5.1 Programmable Current Source

$T_c = 25\text{ }^\circ\text{C}$, $V_{DD5} = 3.0\text{ V}$, unless otherwise noted.

PARAMETER	TEST CONDITIONS	MIN	TYP	MAX	UNIT
Current source programmable output range (logarithmic range)			0.25 - 20		μA
Resolution			0.25		μA

8.15.6 GPIO

8.15.6.1 GPIO DC Characteristics

PARAMETER	TEST CONDITIONS	MIN	TYP	MAX	UNIT
T_A = 25 °C, V_{DDs} = 1.8 V					
GPIO VOH at 8 mA load	IOCURR = 2, high-drive GPIOs only		1.56		V
GPIO VOL at 8 mA load	IOCURR = 2, high-drive GPIOs only		0.24		V
GPIO VOH at 4 mA load	IOCURR = 1		1.59		V
GPIO VOL at 4 mA load	IOCURR = 1		0.21		V
GPIO pullup current	Input mode, pullup enabled, Vpad = 0 V		73		μA
GPIO pulldown current	Input mode, pulldown enabled, Vpad = VDDs		19		μA
GPIO low-to-high input transition, with hysteresis	IH = 1, transition voltage for input read as 0 → 1		1.08		V
GPIO high-to-low input transition, with hysteresis	IH = 1, transition voltage for input read as 1 → 0		0.73		V
GPIO input hysteresis	IH = 1, difference between 0 → 1 and 1 → 0 points		0.35		V
T_A = 25 °C, V_{DDs} = 3.0 V					
GPIO VOH at 8 mA load	IOCURR = 2, high-drive GPIOs only		2.59		V
GPIO VOL at 8 mA load	IOCURR = 2, high-drive GPIOs only		0.42		V
GPIO VOH at 4 mA load	IOCURR = 1		2.63		V
GPIO VOL at 4 mA load	IOCURR = 1		0.40		V
T_A = 25 °C, V_{DDs} = 3.8 V					
GPIO pullup current	Input mode, pullup enabled, Vpad = 0 V		282		μA
GPIO pulldown current	Input mode, pulldown enabled, Vpad = VDDs		110		μA
GPIO low-to-high input transition, with hysteresis	IH = 1, transition voltage for input read as 0 → 1		1.97		V
GPIO high-to-low input transition, with hysteresis	IH = 1, transition voltage for input read as 1 → 0		1.55		V
GPIO input hysteresis	IH = 1, difference between 0 → 1 and 1 → 0 points		0.42		V
T_A = 25 °C					
V _{IH}	Lowest GPIO input voltage reliably interpreted as a <i>High</i>	0.8*V _{DDs}			V
V _{IL}	Highest GPIO input voltage reliably interpreted as a <i>Low</i>		0.2*V _{DDs}		V

8.16 Typical Characteristics

All measurements in this section are done with $T_c = 25\text{ }^\circ\text{C}$ and $V_{DD5} = 3.0\text{ V}$, unless otherwise noted. See *Recommended Operating Conditions* for device limits. Values exceeding these limits are for reference only.

8.16.1 MCU Current

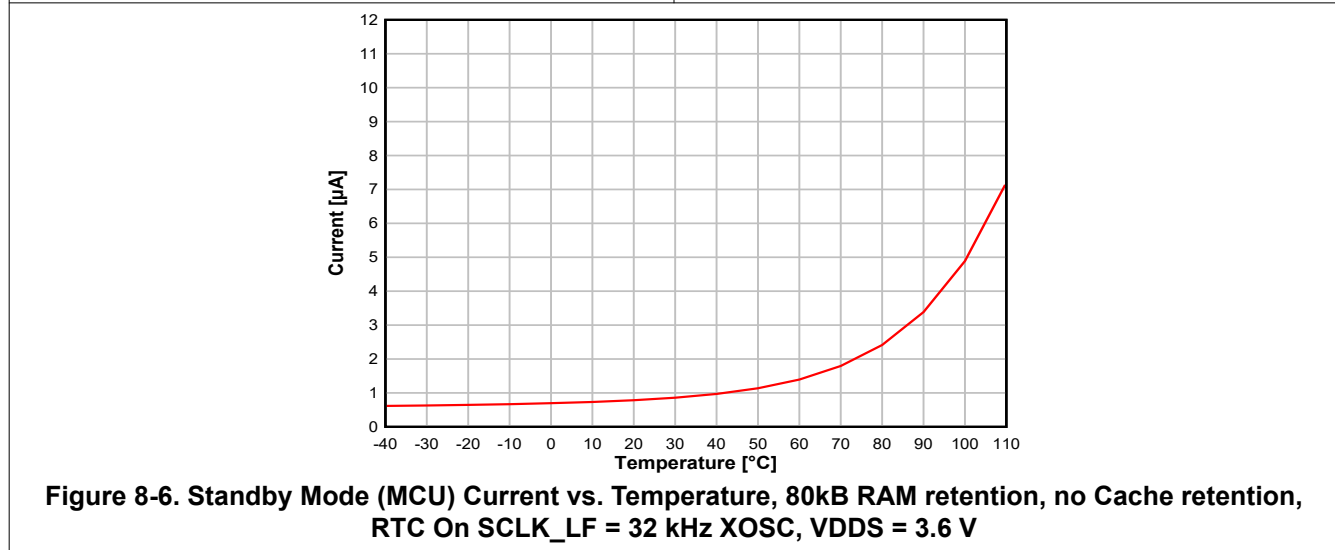
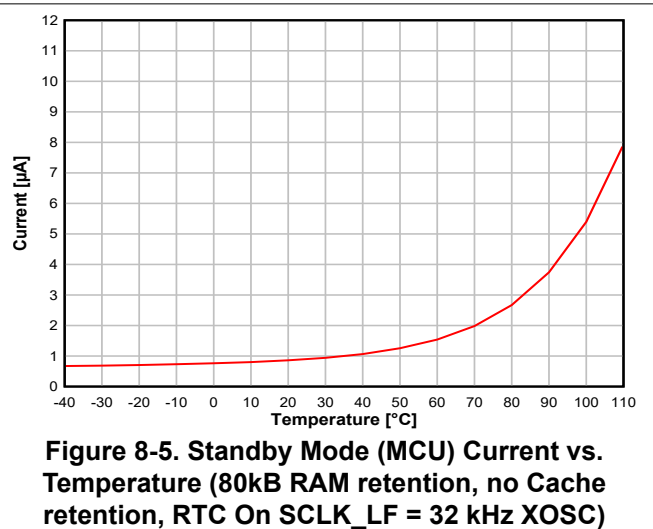
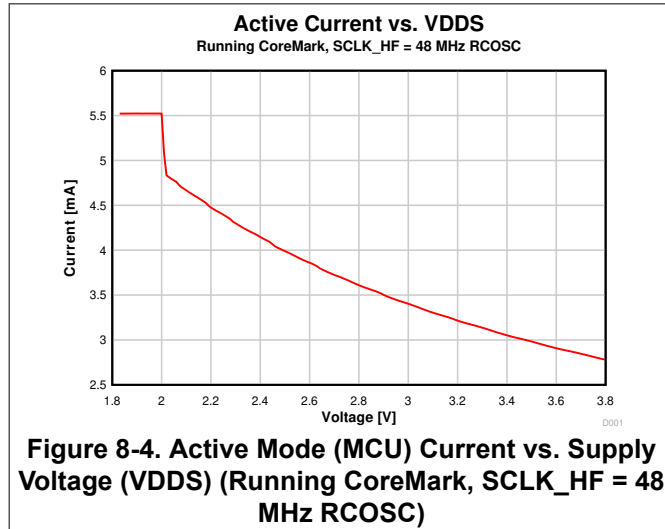

8.16.2 RX Current

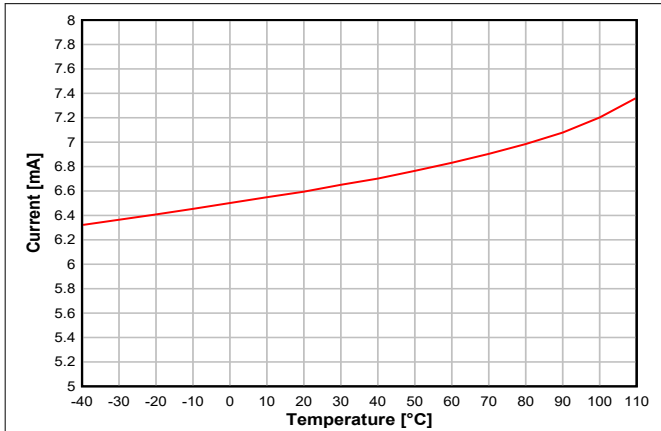

Figure 8-7. RX Current vs. Temperature (50 kbps, 868.3 MHz)

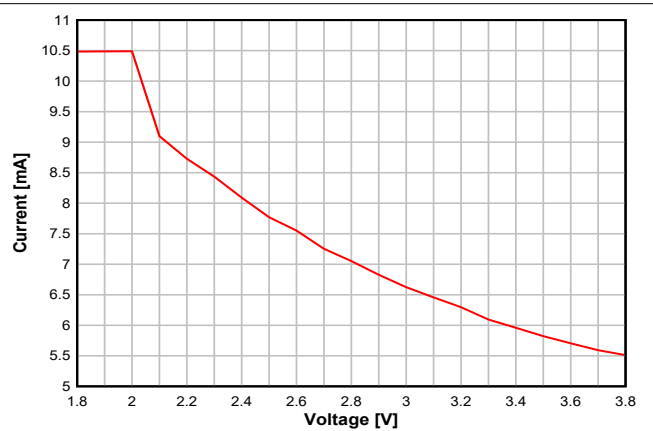

Figure 8-8. RX Current vs. Supply Voltage (VDD5) (50 kbps, 868.3 MHz)

8.16.3 TX Current

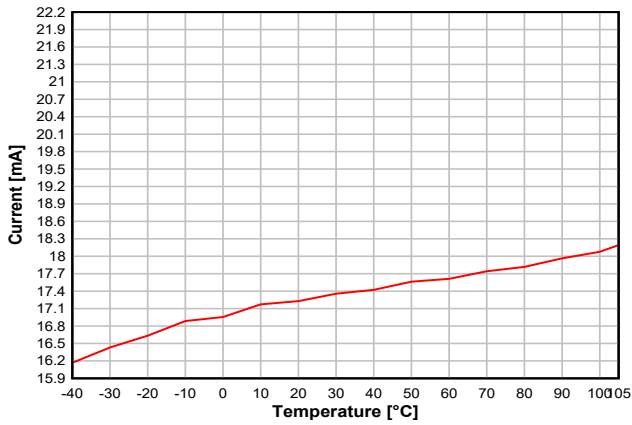

Figure 8-9. TX Current vs. Temperature (50 kbps, 868.3 MHz, +10 dBm, VDDS = 3.6 V)

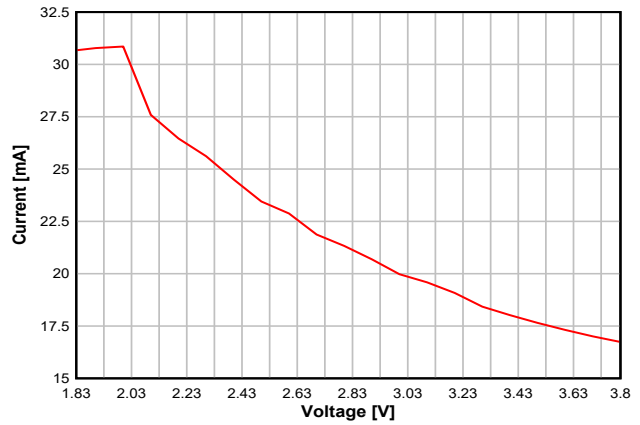

Figure 8-10. TX Current vs. Supply Voltage (VDDS) (50 kbps, 868.3 MHz, +10 dBm setting)

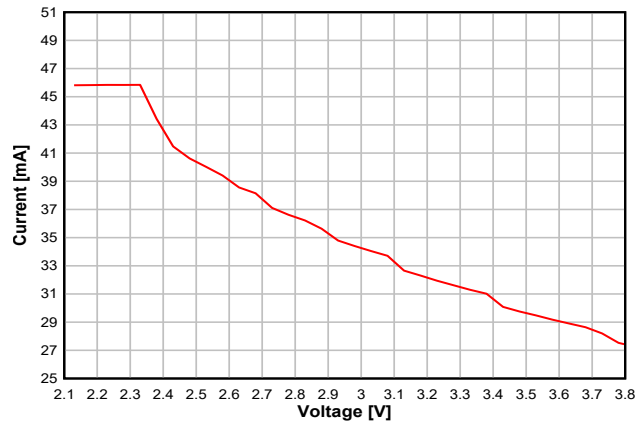

Figure 8-11. TX Current vs. Supply Voltage (VDDS) (50 kbps, 915 MHz, +14 dBm setting)

Table 8-1. Typical TX Current and Output Power

CC1312PSIP at 915 MHz, VDDS = 3.0 V (Measured on LP-EM-CC1312PSIP)			
txPower	TX Power Setting (SmartRF Studio)	Typical Output Power [dBm]	Typical Current Consumption [mA]
0x013F	14	13.8	34.6
0x823F	12.5	12.2	24.9
0x7828	12	11.8	23.5
0x7A15	11	10.9	21.6
0x4C0D	10	10.1	20.0
0x400A	9	9.5	19.1
0x449A	8	8.1	17.1
0x364D	7	6.8	15.3
0x2892	6	6.3	14.8
0x20DC	5	4.9	13.7
0x28D8	4	4	12.6
0x1C46	3	2.8	11.7
0x18D4	2	2.3	11.5
0x16D1	1	0.8	10.6
0x16D0	0	0.3	10.3
0x0CCB	-3	-3.4	8.6
0x0CC9	-5	-5.4	7.9
0x08C7	-7	-8	7.3
0x0AC5	-10	-11.7	6.6
0x08C3	-15	-17.1	5.9
0x08C2	-20	-20.9	5.6

8.16.4 RX Performance

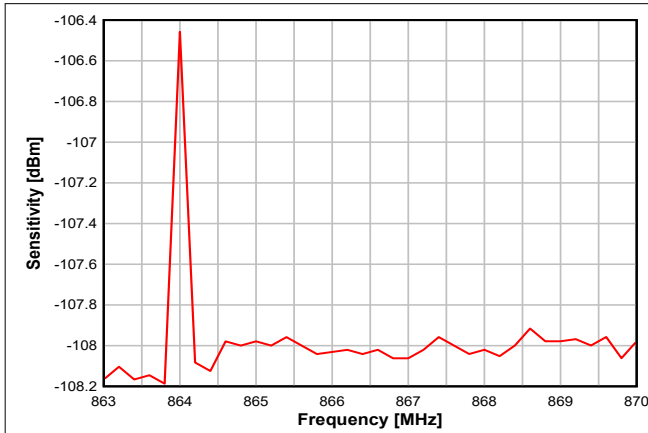

Figure 8-12. Sensitivity vs. Frequency (50 kbps)

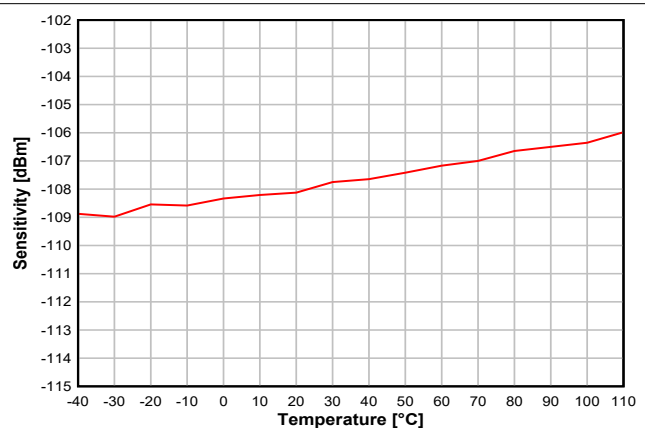

Figure 8-13. Sensitivity vs. Temperature (50 kbps, 868.3 MHz)

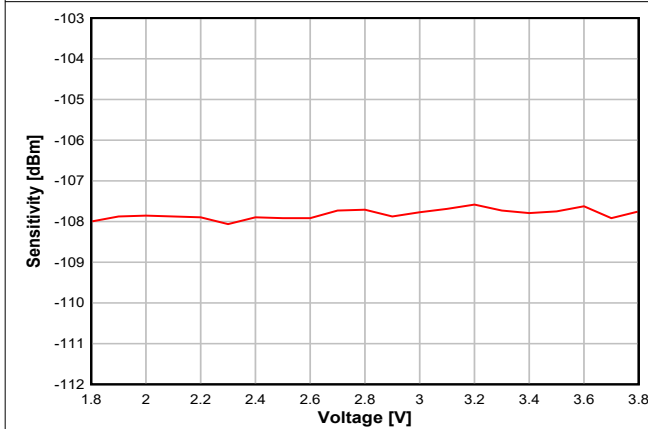

Figure 8-14. Sensitivity vs. Supply Voltage (VDD) (50 kbps, 868.3 MHz)

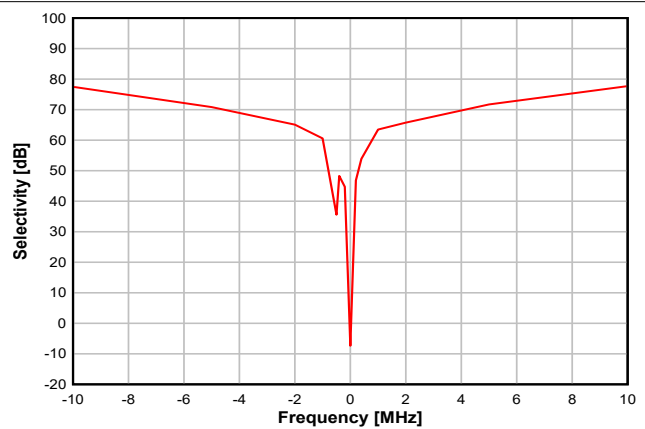

Figure 8-15. Selectivity vs. Frequency Offset (50 kbps, 868.3 MHz)

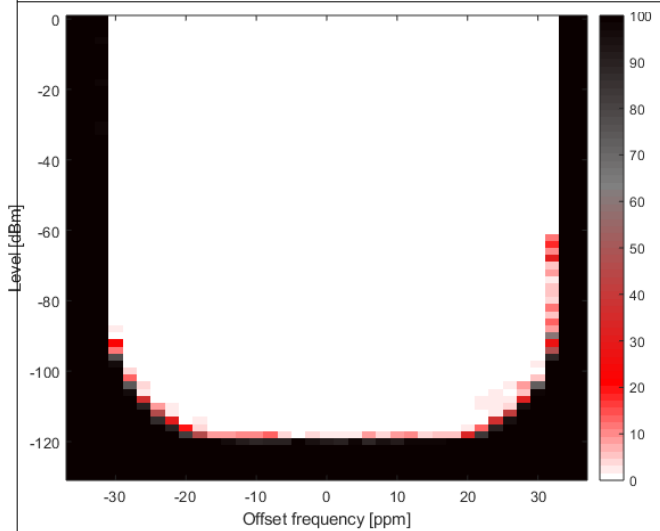

Figure 8-16. PER vs. Level vs. Frequency (SimpleLink™ Long Range 5 kbps, 868 MHz)

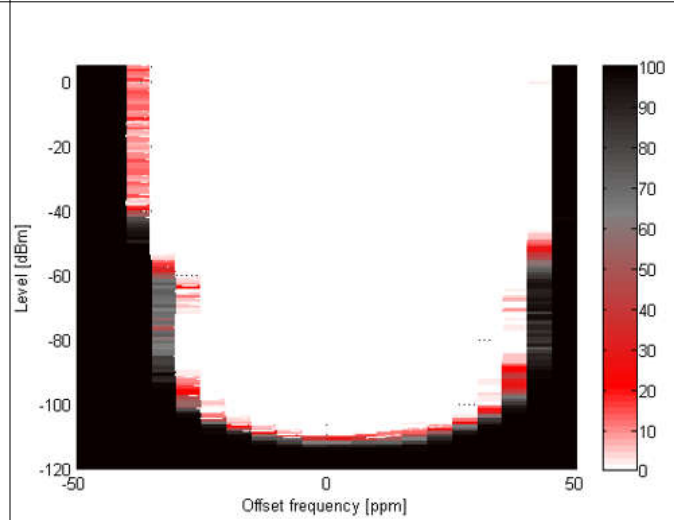

Figure 8-17. 802.15.4, 50 kbps, ±25 kHz deviation, 2-GFSK, 100 kHz RX Bandwidth

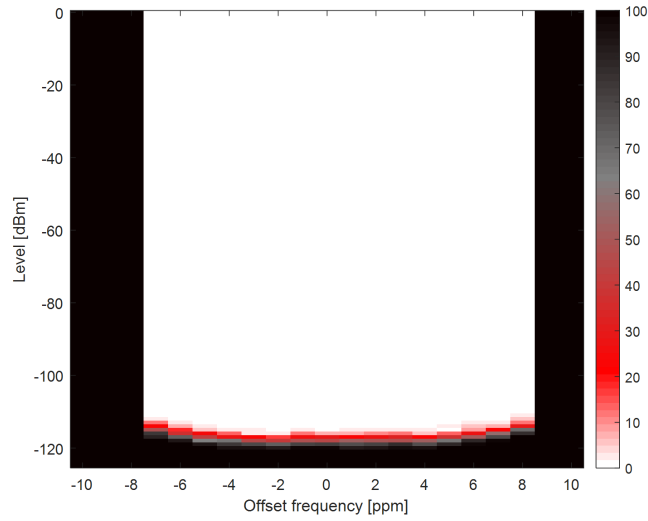

Figure 8-18. Narrowband, 9.6 kbps \pm 2.4 kHz deviation, 2-GFSK, 868 MHz, 17.1 kHz RX Bandwidth

8.16.5 TX Performance

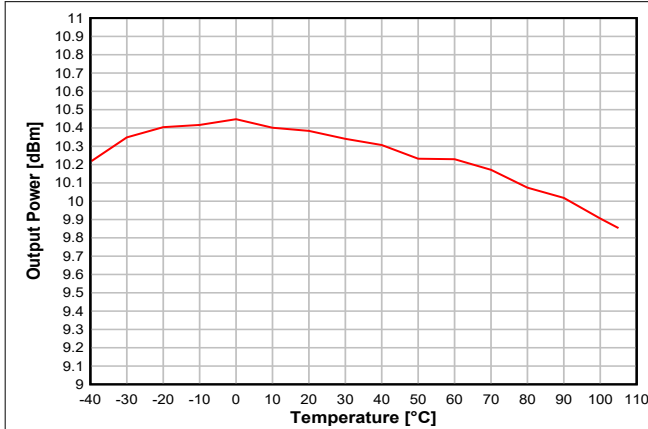

Figure 8-19. Output Power vs. Temperature (868.3 MHz, +10 dBm setting)

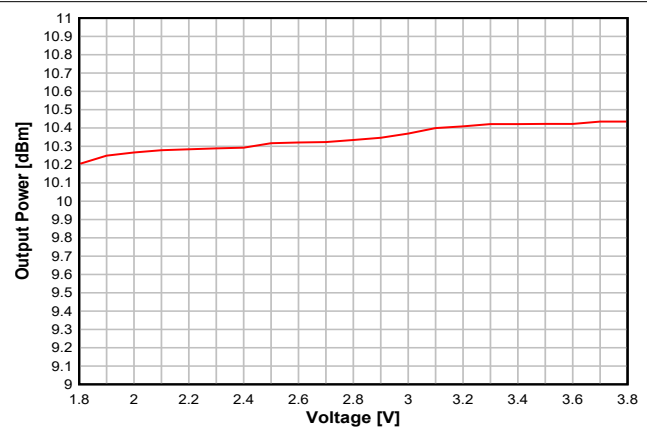

Figure 8-20. Output Power vs. Supply Voltage (VDDS) (868.3 MHz, +10 dBm setting)

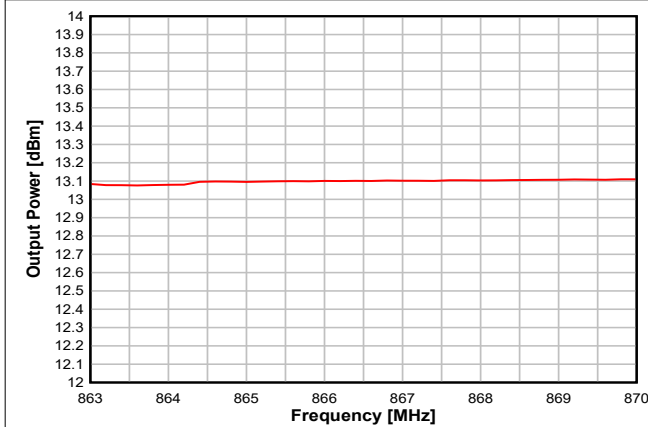

Figure 8-21. Output Power vs. Frequency (+14 dBm setting)

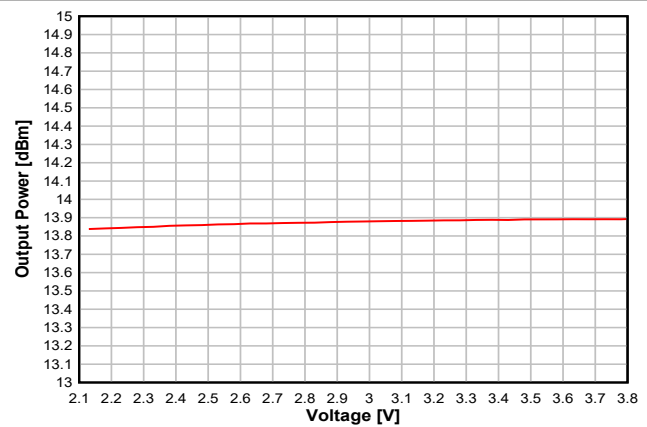

Figure 8-22. Output Power vs. Supply Voltage (VDDS) (915 MHz, +14 dBm setting)

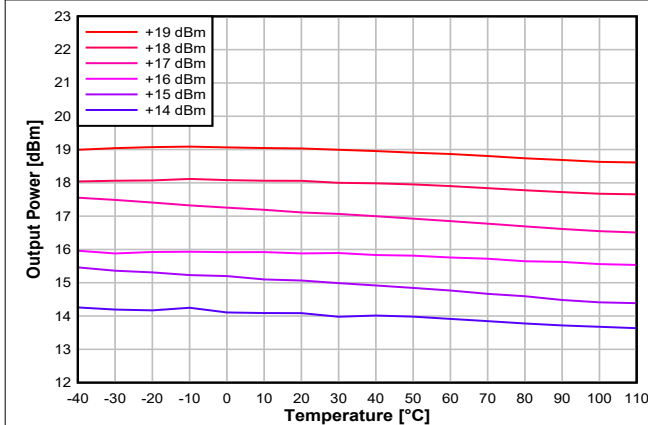

Figure 8-23. TX Current vs. Temperature (50 kbps, 915 MHz, +20 dBm PA, VDDS = 3.3 V)

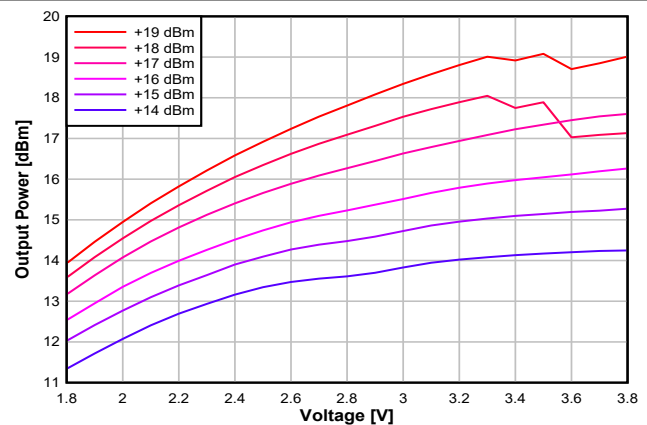
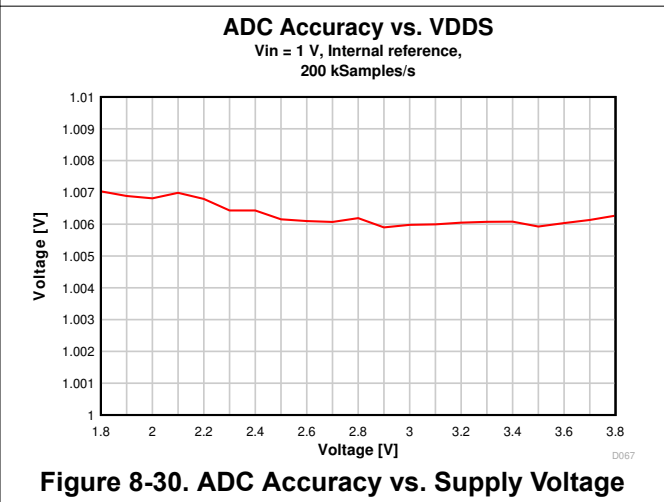
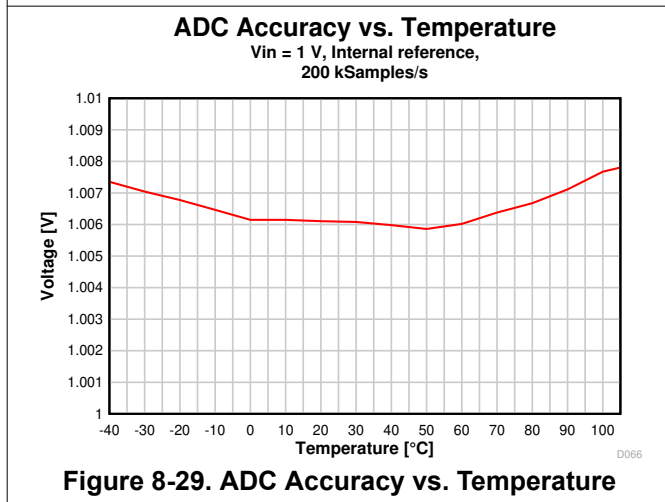
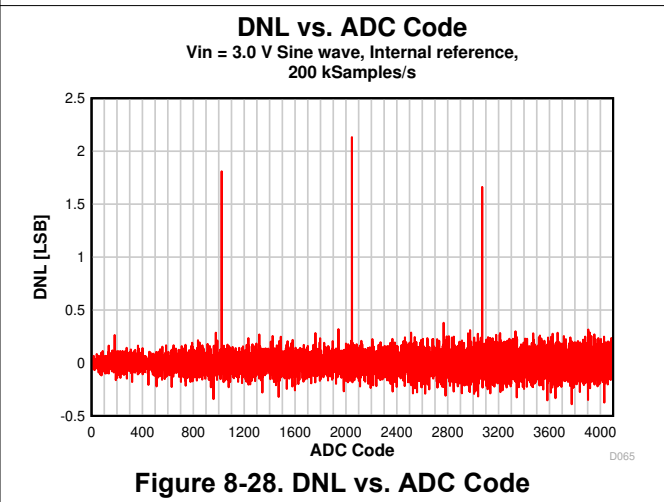
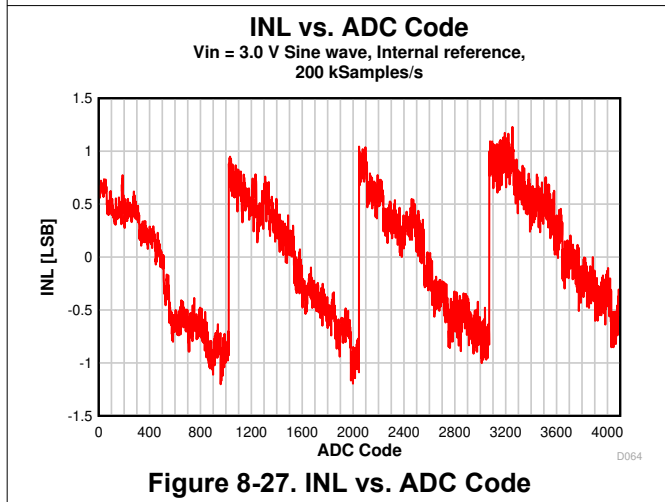
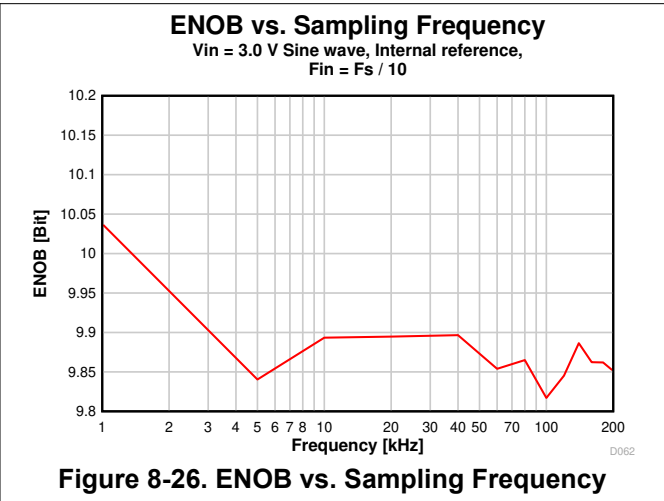
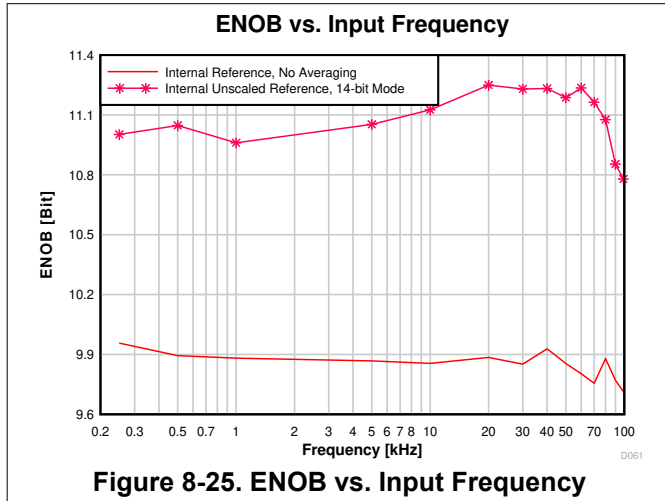

Figure 8-24. TX Current vs. Supply Voltage (VDDS) (50 kbps, 915 MHz, +20 dBm PA)

8.16.6 ADC Performance



8.16.7 Temperature Compensation

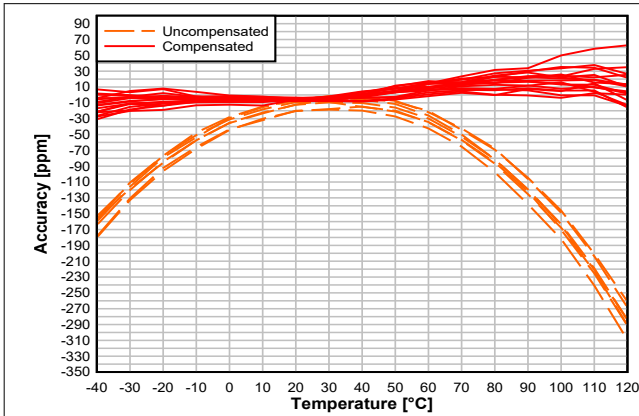

Figure 8-31. Temperature Compensation of the Real Time Clock (RTC)

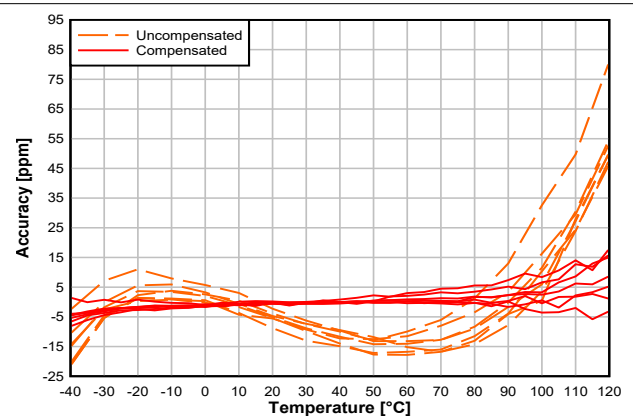

Figure 8-32. Temperature Compensation of the RF Frequency

9 Detailed Description

9.1 Overview

[Section 4](#) shows the core modules of the CC1312PSIP device.

9.2 System CPU

The CC1312PSIP SimpleLink™ Wireless MCU contains an Arm® Cortex®-M4F system CPU, which runs the application and the higher layers of radio protocol stacks.

The system CPU is the foundation of a high-performance, low-cost platform that meets the system requirements of minimal memory implementation, and low-power consumption, while delivering outstanding computational performance and exceptional system response to interrupts.

Its features include the following:

- ARMv7-M architecture optimized for small-footprint embedded applications
- Arm Thumb®-2 mixed 16- and 32-bit instruction set delivers the high performance expected of a 32-bit Arm core in a compact memory size
- Fast code execution permits increased sleep mode time
- Deterministic, high-performance interrupt handling for time-critical applications
- Single-cycle multiply instruction and hardware divide
- Hardware division and fast digital-signal-processing oriented multiply accumulate
- Saturating arithmetic for signal processing
- IEEE 754-compliant single-precision Floating Point Unit (FPU)
- Memory Protection Unit (MPU) for safety-critical applications
- Full debug with data matching for watchpoint generation
 - Data Watchpoint and Trace Unit (DWT)
 - JTAG Debug Access Port (DAP)
 - Flash Patch and Breakpoint Unit (FPB)
- Trace support reduces the number of pins required for debugging and tracing
 - Instrumentation Trace Macrocell Unit (ITM)
 - Trace Port Interface Unit (TPIU) with asynchronous serial wire output (SWO)
- Optimized for single-cycle flash memory access
- Tightly connected to 8-KB 4-way random replacement cache for minimal active power consumption and wait states
- Ultra-low-power consumption with integrated sleep modes
- 48 MHz operation
- 1.25 DMIPS per MHz

9.3 Radio (RF Core)

The RF Core is a highly flexible and future proof radio module which contains an Arm Cortex-M0 processor that interfaces the analog RF and base-band circuitry, handles data to and from the system CPU side, and assembles the information bits in a given packet structure. The RF core offers a high level, command-based API to the main CPU that configurations and data are passed through. The Arm Cortex-M0 processor is not programmable by customers and is interfaced through the TI-provided RF driver that is included with the SimpleLink Software Development Kit (SDK).

The RF core can autonomously handle the time-critical aspects of the radio protocols, thus offloading the main CPU, which reduces power and leaves more resources for the user application. Several signals are also available to control external circuitry such as RF switches or range extenders autonomously.

The various physical layer radio formats are partly built as a software defined radio where the radio behavior is either defined by radio ROM contents or by non-ROM radio formats delivered in form of firmware patches with the SimpleLink SDKs. This allows the radio platform to be updated for support of future versions of standards even with over-the-air (OTA) updates while still using the same silicon.

Note

Not all combinations of features, frequencies, data rates, and modulation formats described in this chapter are supported. Over time, TI can enable new physical radio formats (PHYs) for the device and provides performance numbers for selected PHYs in the data sheet. Supported radio formats for a specific device, including optimized settings to use with the TI RF driver, are included in the [SmartRF Studio](#) tool with performance numbers of selected formats found in the *Specifications* section.

9.3.1 Proprietary Radio Formats

The CC1312PSIP radio can support a wide range of physical radio formats through a set of hardware peripherals combined with firmware available in the device ROM, covering various customer needs for optimizing towards parameters such as speed or sensitivity. This allows great flexibility in tuning the radio both to work with legacy protocols as well as customizing the behavior for specific application needs.

Table 9-1 gives a simplified overview of features of the various radio formats available in ROM. Other radio formats may be available in the form of radio firmware patches or programs through the Software Development Kit (SDK) and may combine features in a different manner, as well as add other features.

Table 9-1. Feature Support

Feature	Main 2-(G)FSK Mode	High Data Rates	Low Data Rates	SimpleLink™ Long Range
Programmable preamble, sync word, and CRC	Yes	Yes	Yes	No
Programmable receive bandwidth	Yes	Yes	Yes (down to 4 kHz)	Yes
Data / Symbol rate ⁽³⁾	20 to 1000 kbps	≤ 2 Msps	≤ 100 ksps	≤ 20 ksps
Modulation format	2-(G)FSK	2-(G)FSK 4-(G)FSK	2-(G)FSK 4-(G)FSK	2-(G)FSK
Dual Sync Word	Yes	Yes	No	No
Carrier Sense ⁽¹⁾ ⁽²⁾	Yes	No	No	No
Preamble Detection ⁽²⁾	Yes	Yes	Yes	No
Data Whitening	Yes	Yes	Yes	Yes
Digital RSSI	Yes	Yes	Yes	Yes
CRC filtering	Yes	Yes	Yes	Yes
Direct-sequence spread spectrum (DSSS)	No	No	No	1:2 1:4 1:8
Forward error correction (FEC)	No	No	No	Yes
Link Quality Indicator (LQI)	Yes	Yes	Yes	Yes

- (1) Carrier Sense can be used to implement HW-controlled listen-before-talk (LBT) and Clear Channel Assessment (CCA) for compliance with such requirements in regulatory standards. This is available through the CMD_PROP_CS radio API.
- (2) Carrier Sense and Preamble Detection can be used to implement sniff modes where the radio is duty cycled to save power.
- (3) Data rates are only indicative. Data rates outside this range may also be supported. For some specific combinations of settings, a smaller range might be supported.

9.4 Memory

The up to 352-KB nonvolatile (Flash) memory provides storage for code and data. The flash memory is in-system programmable and erasable. The last flash memory sector must contain a Customer Configuration section (CCFG) that is used by boot ROM and TI provided drivers to configure the device. This configuration is done through the `ccfg.c` source file that is included in all TI provided examples.

The ultra-low leakage system static RAM (SRAM) is split into up to five 16-KB blocks and can be used for both storage of data and execution of code. Retention of SRAM contents in Standby power mode is enabled by default and included in Standby mode power consumption numbers. Parity checking for detection of bit errors in memory is built-in, which reduces chip-level soft errors and thereby increases reliability. System SRAM is always initialized to zeroes upon code execution from boot.

To improve code execution speed and lower power when executing code from nonvolatile memory, a 4-way nonassociative 8-KB cache is enabled by default to cache and prefetch instructions read by the system CPU. The cache can be used as a general-purpose RAM by enabling this feature in the Customer Configuration Area (CCFG).

There is a 4-KB ultra-low leakage SRAM available for use with the Sensor Controller Engine which is typically used for storing Sensor Controller programs, data and configuration parameters. This RAM is also accessible by the system CPU. The Sensor Controller RAM is not cleared to zeroes between system resets.

The ROM includes a TI-RTOS kernel and low-level drivers, as well as significant parts of selected radio stacks, which frees up flash memory for the application. The ROM also contains a serial (SPI and UART) bootloader that can be used for initial programming of the device.

9.5 Sensor Controller

The Sensor Controller contains circuitry that can be selectively enabled in both Standby and Active power modes. The peripherals in this domain can be controlled by the Sensor Controller Engine, which is a proprietary power-optimized CPU. This CPU can read and monitor sensors or perform other tasks autonomously; thereby significantly reducing power consumption and offloading the system CPU.

The Sensor Controller Engine is user programmable with a simple programming language that has syntax similar to C. This programmability allows for sensor polling and other tasks to be specified as sequential algorithms rather than static configuration of complex peripheral modules, timers, DMA, register programmable state machines, or event routing.

The main advantages are:

- Flexibility - data can be read and processed in unlimited manners while still [ensuring ultra-low power](#)
- 2 MHz low-power mode enables lowest possible handling of digital sensors
- Dynamic reuse of hardware resources
- 40-bit accumulator supporting multiplication, addition and shift
- Observability and debugging options

[Sensor Controller Studio](#) is used to write, test, and debug code for the Sensor Controller. The tool produces C driver source code, which the System CPU application uses to control and exchange data with the Sensor Controller. Typical use cases may be (but are not limited to) the following:

- Read analog sensors using integrated ADC or comparators
- Interface digital sensors using GPIOs, SPI, UART, or I²C (UART and I²C are bit-banged)
- Capacitive sensing
- Waveform generation
- Very low-power pulse counting (flow metering)
- Key scan

The peripherals in the Sensor Controller include the following:

- The low-power clocked comparator can be used to wake the system CPU from any state in which the comparator is active. A configurable internal reference DAC can be used in conjunction with the comparator. The output of the comparator can also be used to trigger an interrupt or the ADC.
- Capacitive sensing functionality is implemented through the use of a constant current source, a time-to-digital converter, and a comparator. The continuous time comparator in this block can also be used as a higher-accuracy alternative to the low-power clocked comparator. The Sensor Controller takes care of baseline tracking, hysteresis, filtering, and other related functions when these modules are used for capacitive sensing.
- The ADC is a 12-bit, 200-ksamples/s ADC with eight inputs and a built-in voltage reference. The ADC can be triggered by many different sources including timers, I/O pins, software, and comparators.
- The analog modules can connect to up to eight different GPIOs
- Dedicated SPI master with up to 6 MHz clock speed

The peripherals in the Sensor Controller can also be controlled from the main application processor.

9.6 Cryptography

The CC1312PSIP device comes with a wide set of modern cryptography-related hardware accelerators, drastically reducing code footprint and execution time for cryptographic operations. It also has the benefit of being lower power and improves availability and responsiveness of the system because the cryptography operations runs in a background hardware thread.

Together with a large selection of open-source cryptography libraries provided with the Software Development Kit (SDK), this allows for secure and future proof IoT applications to be easily built on top of the platform. The hardware accelerator modules are:

- **True Random Number Generator (TRNG)** module provides a true, nondeterministic noise source for the purpose of generating keys, initialization vectors (IVs), and other random number requirements. The TRNG is built on 24 ring oscillators that create unpredictable output to feed a complex nonlinear-combinatorial circuit.
- **Secure Hash Algorithm 2 (SHA-2)** with support for SHA224, SHA256, SHA384, and SHA512
- **Advanced Encryption Standard (AES)** with 128 and 256 bit key lengths
- **Public Key Accelerator** - Hardware accelerator supporting mathematical operations needed for elliptic curves up to 512 bits and RSA key pair generation up to 1024 bits.

Through use of these modules and the TI provided cryptography drivers, the following capabilities are available for an application or stack:

- **Key Agreement Schemes**
 - Elliptic curve Diffie–Hellman with static or ephemeral keys (ECDH and ECDHE)
 - Elliptic curve Password Authenticated Key Exchange by Juggling (ECJ-PAKE)
- **Signature Generation**
 - Elliptic curve Diffie-Hellman Digital Signature Algorithm (ECDSA)
- **Curve Support**
 - Short Weierstrass form (full hardware support), such as:
 - NIST-P224, NIST-P256, NIST-P384, NIST-P521
 - Brainpool-256R1, Brainpool-384R1, Brainpool-512R1
 - secp256r1
 - Montgomery form (hardware support for multiplication), such as:
 - Curve25519
- **SHA2 based MACs**
 - HMAC with SHA224, SHA256, SHA384, or SHA512
- Block cipher mode of operation
 - AESCCM
 - AESGCM
 - AESECB
 - AESCBC
 - AESCBC-MAC
- **True random number generation**

Other capabilities, such as RSA encryption and signatures as well as Edwards type of elliptic curves such as Curve1174 or Ed25519, can also be implemented using the provided hardware accelerators but are not part of the TI SimpleLink SDK for the CC1312PSIP device.

9.7 Timers

A large selection of timers are available as part of the CC1312PSIP device. These timers are:

- **Real-Time Clock (RTC)**

A 70-bit 3-channel timer running on the 32 kHz low frequency system clock (SCLK_LF)

This timer is available in all power modes except Shutdown. The timer can be calibrated to compensate for frequency drift when using the LF RCOSC as the low frequency system clock. If an external LF clock with frequency different from 32.768 kHz is used, the RTC tick speed can be adjusted to compensate for this. When using TI-RTOS, the RTC is used as the base timer in the operating system and should thus only be accessed through the kernel APIs such as the Clock module. The real time clock can also be read by the Sensor Controller Engine to timestamp sensor data and also has dedicated capture channels. By default, the RTC halts when a debugger halts the device.

- **General Purpose Timers (GPTIMER)**

The four flexible GPTIMERS can be used as either 4× 32 bit timers or 8× 16 bit timers, all running on up to 48 MHz. Each of the 16- or 32-bit timers support a wide range of features such as one-shot or periodic counting, pulse width modulation (PWM), time counting between edges and edge counting. The inputs and outputs of the timer are connected to the device event fabric, which allows the timers to interact with signals such as GPIO inputs, other timers, DMA and ADC. The GPTIMERS are available in Active and Idle power modes.

- **Sensor Controller Timers**

The Sensor Controller contains 3 timers:

AUX Timer 0 and 1 are 16-bit timers with a 2^N prescaler. Timers can either increment on a clock or on each edge of a selected tick source. Both one-shot and periodical timer modes are available.

AUX Timer 2 is a 16-bit timer that can operate at 24 MHz, 2 MHz or 32 kHz independent of the Sensor Controller functionality. There are 4 capture or compare channels, which can be operated in one-shot or periodical modes. The timer can be used to generate events for the Sensor Controller Engine or the ADC, as well as for PWM output or waveform generation.

- **Radio Timer**

A multichannel 32-bit timer running at 4 MHz is available as part of the device radio. The radio timer is typically used as the timing base in wireless network communication using the 32-bit timing word as the network time. The radio timer is synchronized with the RTC by using a dedicated radio API when the device radio is turned on or off. This ensures that for a network stack, the radio timer seems to always be running when the radio is enabled. The radio timer is in most cases used indirectly through the trigger time fields in the radio APIs and should only be used when running the accurate 48 MHz high frequency crystal is the source of SCLK_HF.

- **Watchdog timer**

The watchdog timer is used to regain control if the system operates incorrectly due to software errors. It is typically used to generate an interrupt to and reset of the device for the case where periodic monitoring of the system components and tasks fails to verify proper functionality. The watchdog timer runs on a 1.5 MHz clock rate and cannot be stopped once enabled. The watchdog timer pauses to run in Standby power mode and when a debugger halts the device.

9.8 Serial Peripherals and I/O

The SSIs are synchronous serial interfaces that are compatible with SPI, MICROWIRE, and TI's synchronous serial interfaces. The SSIs support both SPI master and slave up to 4 MHz. The SSI modules support configurable phase and polarity.

The UARTs implement universal asynchronous receiver and transmitter functions. They support flexible baud-rate generation up to a maximum of 3 Mbps.

The I²S interface is used to handle digital audio and can also be used to interface pulse-density modulation microphones (PDM).

The I²C interface is also used to communicate with devices compatible with the I²C standard. The I²C interface can handle 100 kHz and 400 kHz operation, and can serve as both master and slave.

The I/O controller (IOC) controls the digital I/O pins and contains multiplexer circuitry to allow a set of peripherals to be assigned to I/O pins in a flexible manner. All digital I/Os are interrupt and wake-up capable, have a programmable pullup and pulldown function, and can generate an interrupt on a negative or positive edge (configurable). When configured as an output, pins can function as either push-pull or open-drain. Five GPIOs have high-drive capabilities, which are marked in **bold** in [Section 7](#). All digital peripherals can be connected to any digital pin on the device.

For more information, see the [CC13x2, CC26x2 SimpleLink™ Wireless MCU Technical Reference Manual](#).

9.9 Battery and Temperature Monitor

A combined temperature and battery voltage monitor is available in the CC1312PSIP device. The battery and temperature monitor allows an application to continuously monitor on-chip temperature and supply voltage and respond to changes in environmental conditions as needed. The module contains window comparators to interrupt the system CPU when temperature or supply voltage go outside defined windows. These events can also be used to wake up the device from Standby mode through the Always-On (AON) event fabric.

9.10 μ DMA

The device includes a direct memory access (μ DMA) controller. The μ DMA controller provides a way to offload data-transfer tasks from the system CPU, thus allowing for more efficient use of the processor and the available bus bandwidth. The μ DMA controller can perform a transfer between memory and peripherals. The μ DMA controller has dedicated channels for each supported on-chip module and can be programmed to automatically perform transfers between peripherals and memory when the peripheral is ready to transfer more data.

Some features of the μ DMA controller include the following (this is not an exhaustive list):

- Highly flexible and configurable channel operation of up to 32 channels
- Transfer modes: memory-to-memory, memory-to-peripheral, peripheral-to-memory, and peripheral-to-peripheral
- Data sizes of 8, 16, and 32 bits
- Ping-pong mode for continuous streaming of data

9.11 Debug

The on-chip debug support is done through a dedicated cJTAG (IEEE 1149.7) or JTAG (IEEE 1149.1) interface. The device boots by default into cJTAG mode and must be reconfigured to use 4-pin JTAG.

9.12 Power Management

To minimize power consumption, the CC1312PSIP supports a number of power modes and power management features (see [Table 9-2](#)).

Table 9-2. Power Modes

MODE	SOFTWARE CONFIGURABLE POWER MODES				RESET PIN HELD
	ACTIVE	IDLE	STANDBY	SHUTDOWN	
CPU	Active	Off	Off	Off	Off
Flash	On	Available	Off	Off	Off
SRAM	On	On	Retention	Off	Off
Radio	Available	Available	Off	Off	Off
Supply System	On	On	Duty Cycled	Off	Off
Register and CPU retention	Full	Full	Partial	No	No
SRAM retention	Full	Full	Full	No	No
48 MHz high-speed clock (SCLK_HF)	XOSC_HF or RCOSC_HF	XOSC_HF or RCOSC_HF	Off	Off	Off
2 MHz medium-speed clock (SCLK_MF)	RCOSC_MF	RCOSC_MF	Available	Off	Off
32 kHz low-speed clock (SCLK_LF)	XOSC_LF or RCOSC_LF	XOSC_LF or RCOSC_LF	XOSC_LF or RCOSC_LF	Off	Off
Peripherals	Available	Available	Off	Off	Off
Sensor Controller	Available	Available	Available	Off	Off
Wake-up on RTC	Available	Available	Available	Off	Off
Wake-up on pin edge	Available	Available	Available	Available	Off
Wake-up on reset pin	On	On	On	On	On
Brownout detector (BOD)	On	On	Duty Cycled	Off	Off
Power-on reset (POR)	On	On	On	Off	Off
Watchdog timer (WDT)	Available	Available	Paused	Off	Off

In **Active** mode, the application system CPU is actively executing code. Active mode provides normal operation of the processor and all of the peripherals that are currently enabled. The system clock can be any available clock source (see [Table 9-2](#)).

In **Idle** mode, all active peripherals can be clocked, but the Application CPU core and memory are not clocked and no code is executed. Any interrupt event brings the processor back into active mode.

In **Standby** mode, only the always-on (AON) domain is active. An external wake-up event, RTC event, or Sensor Controller event is required to bring the device back to active mode. MCU peripherals with retention do not need to be reconfigured when waking up again, and the CPU continues execution from where it went into standby mode. All GPIOs are latched in standby mode.

In **Shutdown** mode, the device is entirely turned off (including the AON domain and Sensor Controller), and the I/Os are latched with the value they had before entering shutdown mode. A change of state on any I/O pin defined as a *wake from shutdown pin* wakes up the device and functions as a reset trigger. The CPU can differentiate between reset in this way and reset-by-reset pin or power-on reset by reading the reset status register. The only state retained in this mode is the latched I/O state and the flash memory contents.

The Sensor Controller is an autonomous processor that can control the peripherals in the Sensor Controller independently of the system CPU. This means that the system CPU does not have to wake up, for example to perform an ADC sampling or poll a digital sensor over SPI, thus saving both current and wake-up time that would otherwise be wasted. The [Sensor Controller Studio](#) tool enables the user to program the Sensor Controller, control its peripherals, and wake up the system CPU as needed. All Sensor Controller peripherals can also be controlled by the system CPU.

Note

The power, RF and clock management for the CC1312PSIP device require specific configuration and handling by software for optimized performance. This configuration and handling is implemented in the TI-provided drivers that are part of the CC1312PSIP software development kit (SDK). Therefore, TI highly recommends using this software framework for all application development on the device. The complete [SDK](#) with TI-RTOS (optional), device drivers, and examples are offered free of charge in source code.

9.13 Clock Systems, production calibration and temperature compensation

The CC1312PSIP device has several internal system clocks.

The 48 MHz SCLK_HF is used as the main system (MCU and peripherals) clock. This can be driven by the internal 48 MHz RC Oscillator (RCOSC_HF) or in-package 48 MHz crystal (XOSC_HF). Note that the radio operation runs off the included, in-package 48 MHz crystal within the module.

Production calibration of the 48 MHz crystal frequency

The crystal frequency is calibrated in production of the SIP module at room temperature to reduce the initial frequency error to a minimum. This is done by setting the internal capacitor array to the value that gives closest to 48 MHz.

Software TCXO

In addition to this initial analog frequency error removal by changing the internal load capacitance, the CC1312PSIP is also implementing a feature called Software TCXO. Software TCXO is not affecting the 48 MHz crystal frequency itself, but it is using the known initial frequency error and a model of the temperature behavior of the 48 MHz crystal to generate a very accurate RF frequency. The software TCXO feature works as follows: In the final production test of the SIP module, the RF frequency is measured and the RF frequency error (proportional to the ppm error) caused by the remaining error of the 48 MHz crystal is stored in factory flash area (FCFG). The internal PLL that is generating the RF frequency is using the 48 MHz crystal as a reference frequency, so the temperature drift of the crystal - in ppm (parts per million) will give the same error for the RF frequency. The temperature drift for the 48 MHz crystal can be modelled as a third order equation and used together with the internal temperature sensor, this would give a good average temperature estimation of the 48 MHz crystals used in the CC1312PSIP. The coefficients for the third order equation is defined in the sysconfig configuration software tool and firmware in the CC1312PSIP will then automatically correct the RF frequency in RX and TX by taking into account the initial frequency error as well as the temperature drift.

SCLK_LF is the 32.8 kHz internal low-frequency system clock. It can be used by the Sensor Controller for ultra-low-power operation and is also used for the RTC and to synchronize the radio timer before or after Standby power mode. SCLK_LF can be driven by the internal 32.8 kHz RC Oscillator (RCOSC_LF) or the included, in-package 32.768 kHz crystal within the module. When using a crystal or the internal RC oscillator, the device can output the 32 kHz SCLK_LF signal to other devices, thereby reducing the overall system cost.

RTC temperature compensation

The CC1312PSIP includes a firmware function that will improve the RTC (Real Time Clock) accuracy when using the in-package 32.768 kHz crystal as a basis for the RTC. In the final production test of the SIP module, the RTC frequency is measured and the error is stored in the factory flash area (FCFG). The temperature drift of the 32.768 kHz crystal can be modelled as a second order equation and the coefficient for this equation is

defined in the sysconfig configuration software tool. Firmware in the CC1312PSIP will then use the temperature sensor in the CC1312PSIP, the initial frequency error stored in factory flash area (FCFG) and the model for temperature drift to calculate a more accurate RTC.

9.14 Network Processor

Depending on the product configuration, the CC1312PSIP device can function as a wireless network processor (WNP - a device running the wireless protocol stack with the application running on a separate host MCU), or as a system-on-chip (SoC) with the application and protocol stack running on the system CPU inside the device.

In the first case, the external host MCU communicates with the device using SPI or UART. In the second case, the application must be written according to the application framework supplied with the wireless protocol stack.

9.15 Device Certification and Qualification

The module from TI is certified for FCC and IC/ISED. TI Customers that build products based on the TI module can save in testing cost and time per product family.

Note

The FCC and IC IDs must be located in both the user manual and on the packaging. Due to the small size of the module (7 mm x 7 mm), placing the IDs and markings in a type size large enough to be legible without the aid of magnification is impractical.

Table 9-3. List of Certifications

Regulatory Body	Specification	ID (IF APPLICABLE)
FCC (USA)	15.247 Operation within the 902–928 MHz band	ZAT-1312PSIP-2
IC/ISED (Canada)	RSS-247 Operation within the 902–928 MHz band	451H-1312PSIP2
ETSI/CE (Europe) & RER (UK)	EN 300 220, 863 -870 MHz band	-
	EN 303 204, 870–876 MHz band	
	EN 303 659, 865-868 MHz and 915-919.4MHz	

9.15.1 FCC Certification and Statement

CAUTION

FCC RF Radiation Exposure Statement:

This equipment complies with FCC radiation exposure limits set forth for an uncontrolled environment. End users must follow the specific operating instructions for satisfying RF exposure limits. This transmitter must not be co-located or operating with any other antenna or transmitter.

The CC1312PSIPMOT2 module from TI is certified for FCC as a single-modular transmitter. The module is an FCC-certified radio module that carries a modular grant.

You are cautioned that changes or modifications not expressly approved by the party responsible for compliance could void the user's authority to operate the equipment.

This device comply with Part 15 of the FCC Rules. Operation is subject to the following two conditions:

- This device may not cause harmful interference.
- This device must accept any interference received, including interference that may cause undesired operation of the device.

9.15.2 IC/ISED Certification and Statement

CAUTION

IC RF Radiation Exposure Statement:

To comply with IC RF exposure requirements, this device and its antenna must not be co-located or operating in conjunction with any other antenna or transmitter.

Pour se conformer aux exigences de conformité RF canadienne l'exposition, cet appareil et son antenne ne doivent pas être co-localisés ou fonctionnant en conjonction avec une autre antenne ou transmetteur.

The CC1312PSIPMOT module from TI is certified for IC as a single-modular transmitter. The CC1312PSIPMOT module from TI is meets IC modular approval and labeling requirements. The IC follows the same testing and rules as the FCC regarding certified modules in authorized equipment.

This device complies with Industry Canada licence-exempt RSS standards.

Operation is subject to the following two conditions:

- This device may not cause interference.
- This device must accept any interference, including interference that may cause undesired operation of the device.

Le présent appareil est conforme aux CNR d'Industrie Canada applicables aux appareils radio exempts de licence.

L'exploitation est autorisée aux deux conditions suivantes:

- L'appareil ne doit pas produire de brouillage
- L'utilisateur de l'appareil doit accepter tout brouillage radioélectrique subi, même si le brouillage est susceptible d'en compromettre le fonctionnement.

9.16 Module Markings

Figure 9-1 shows the top-side marking for the CC1312PSIP module.

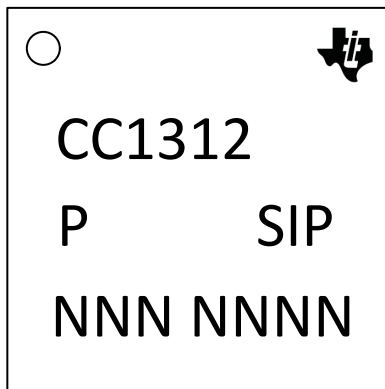

Figure 9-1. Top-Side Marking

Table 9-4 lists the CC1312PSIP module markings.

Table 9-4. Module Descriptions

MARKING	DESCRIPTION
CC1312	Generic Part Number
P	Model
SIP	SIP = Module type, X = pre-release
NNN NNNN	LTC (Lot Trace Code)

9.17 End Product Labeling

The CC1312PSIPMOT2 module complies with the FCC single modular FCC grant, FCC ID: **ZAT-1312PSIP-2**. The host system using this module must display a visible label indicating the following text:

Contains FCC ID: **ZAT-1312PSIP-2**

The CC1312PSIPMOT2 module complies with the IC single modular IC grant, IC: **451H-1312PSIP2**. The host system using this module must display a visible label indicating the following text:

Contains IC: **451H-1312PSIP2**

For more information on end product labeling and a sample label, please see section 4 of the [OEM Integrators Guide](#)

9.18 Manual Information to the End User

The OEM integrator must be aware not to provide information to the end user regarding how to install or remove this RF module in the user's manual of the end product which integrates this module.

The end user manual must include all required regulatory information and warnings as shown in this manual.

10 Application, Implementation, and Layout

Note

Information in the following Applications section is not part of the TI component specification, and TI does not warrant its accuracy or completeness. TI's customers are responsible for determining suitability of components for their purposes. Customers should validate and test their design implementation to confirm system functionality.

10.1 Application Information

10.1.1 Typical Application Circuit

Figure 10-1 shows the typical application schematic using the CC1312PSIP module. For the full reference schematic, download the LP-EM-CC1312PSIP Design Files.

Note

The following guidelines are recommended for implementation of the RF design:

- Ensure an RF path is designed with a characteristic impedance of 50 Ω.
- Tuning of the antenna impedance matching network is recommended after manufacturing of the PCB to account for PCB parasitics. Please refer to [CC13xx/CC26xx Hardware Configuration and PCB Design Considerations](#); section 5.1 for further information.

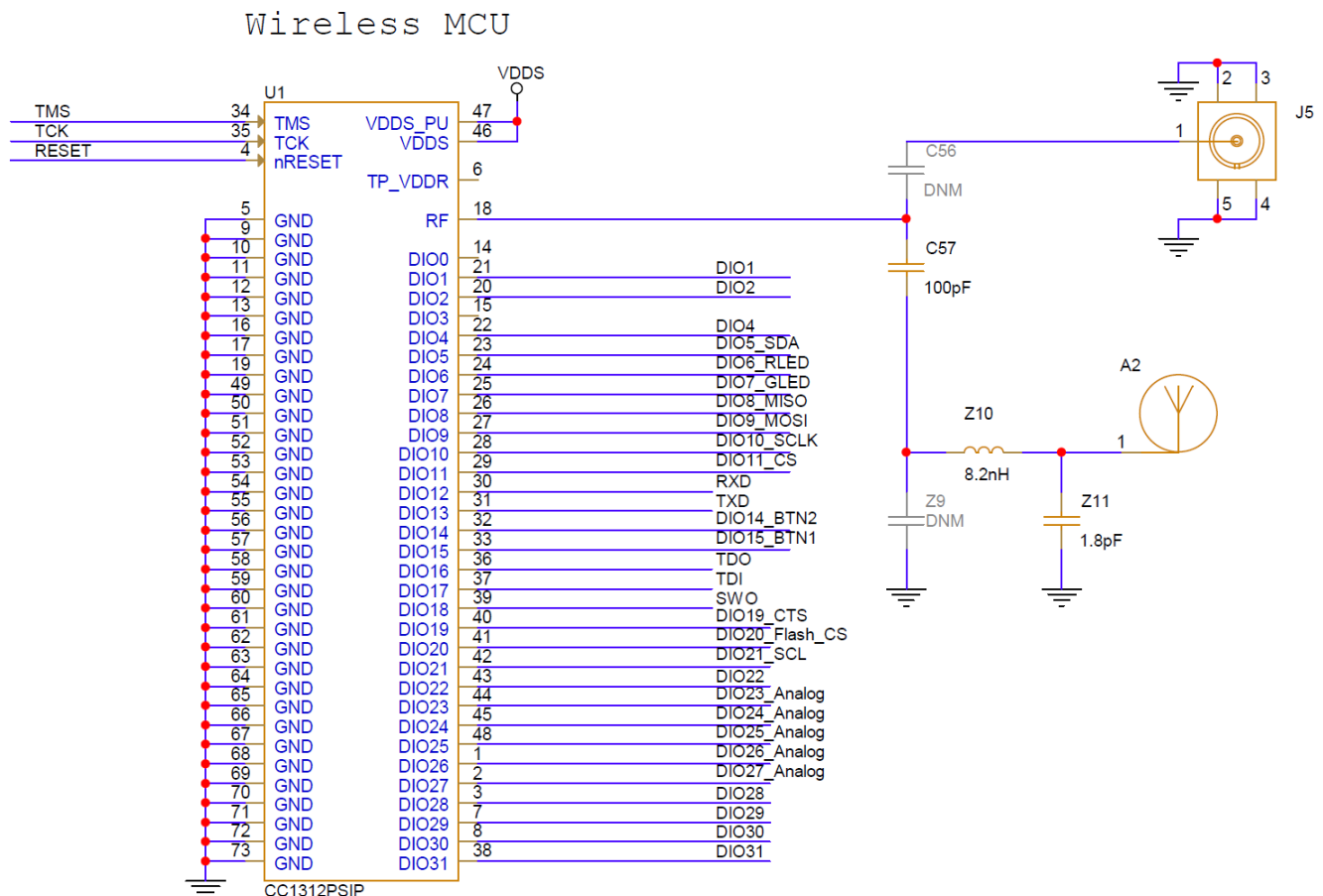

Figure 10-1. CC1312PSIP Typical Application Schematic with integrated antenna on LP-EM-CC1312PSIP

Table 10-1 provides the bill of materials for a typical application using the CC1312PSIP module in Figure 10-1.

It is always recommended to insert a pi-filter (Z9, Z10 and Z11) between the RF pad and the antenna / SMA connector. When matching towards an antenna, this will minimize the mismatch losses of the antenna. A low-pass match or high-pass matching network can typically be chosen.

For the CC1312PSIP, it is recommended to use a low-pass antenna match since this will both match the antenna but will also act as a low-pass filter function as well. As can be seen in Figure 10-1, Z10 and Z11 form a low-pass antenna match on the LP-EM-CC1312PSIP that has an integrated PCB antenna.

For 902-915 MHz only, in the event that no matching components are required for the antenna or direct connection to a SMA, it is recommended to just use a DC blocking capacitor of 100 pF. For operation at both 868/869 MHz and 902-928 MHz, then it is also recommended to use an LC filter of Z10: 3.9 nH and Z11: 3.6 pF as a low-pass filter.

For full operation reference design, see the LP-EM-CC1312PSIP Design Files.

Table 10-1. Bill of Materials

QTY	PART REFERENCE	VALUE	MANUFACTURER	PART NUMBER	DESCRIPTION
1	C57	100pF	Murata	GRM0335C1H101GA01D	Capacitor, Ceramic C0G/NP0, 100pF, 50V, -2%/+2%, -55DEGC/+125DEGC, 0201, SMD
1	U1	CC1312PSIP	Texas Instruments	CC1312PSIP	IC, CC1312PSIP, LGA73, SMD
1	Z10	8.2nH	Murata	LQP03TN8N2J02D	Inductor, RF, Chip, Non-magnetic core, 8.2nH, -5%/+5%, 0.25A, -55DEGC/+125DEGC, 0201, SMD
1	Z11	1.8pF	Murata	GRM0335C1H1R8BA01J	Capacitor, Ceramic C0G/NP0, 1.8pF, 50V, -0.1pF/+0.1pF, -55DEGC/+125DEGC, 0201, SMD

10.2 Device Connection and Layout Fundamentals

10.2.1 Reset

In order to meet the module power-on-reset requirements, VDDS (Pin 46) and VDDS_PU (Pin 47) should be connected together. If the reset signal is not based upon a power-on-reset and is instead derived from an external MCU, then VDDS_PU (Pin 47) should be No Connect (NC).

10.2.2 Unused Pins

All unused pins can be left unconnected without the concern of having leakage current. Please refer to [Connections for Unused Pins and Modules](#) for more details.

10.3 PCB Layout Guidelines

This section details the PCB guidelines to speed up the PCB design using the CC1312PSIP module. The integrator of the modules must comply with the PCB layout recommendations described in the following subsections to minimize the risk with regulatory certifications for the FCC, IC/ISED, ETSI/CE. Moreover, TI recommends customers to follow the guidelines described in this section to achieve similar performance to that obtained with the TI reference design.

10.3.1 General Layout Recommendations

Ensure that the following general layout recommendations are followed:

- Have a solid ground plane and ground vias under the module for stable system and thermal dissipation.
- Do not run signal traces underneath the module on a layer where the module is mounted.

10.3.2 RF Layout Recommendations

It is critical that the RF section be laid out correctly to ensure optimal module performance. A poor layout can cause low-output power and sensitivity degradation. [Figure 10-2](#) shows the RF placement and routing of the module with the Sub-1 GHz PCB antenna.

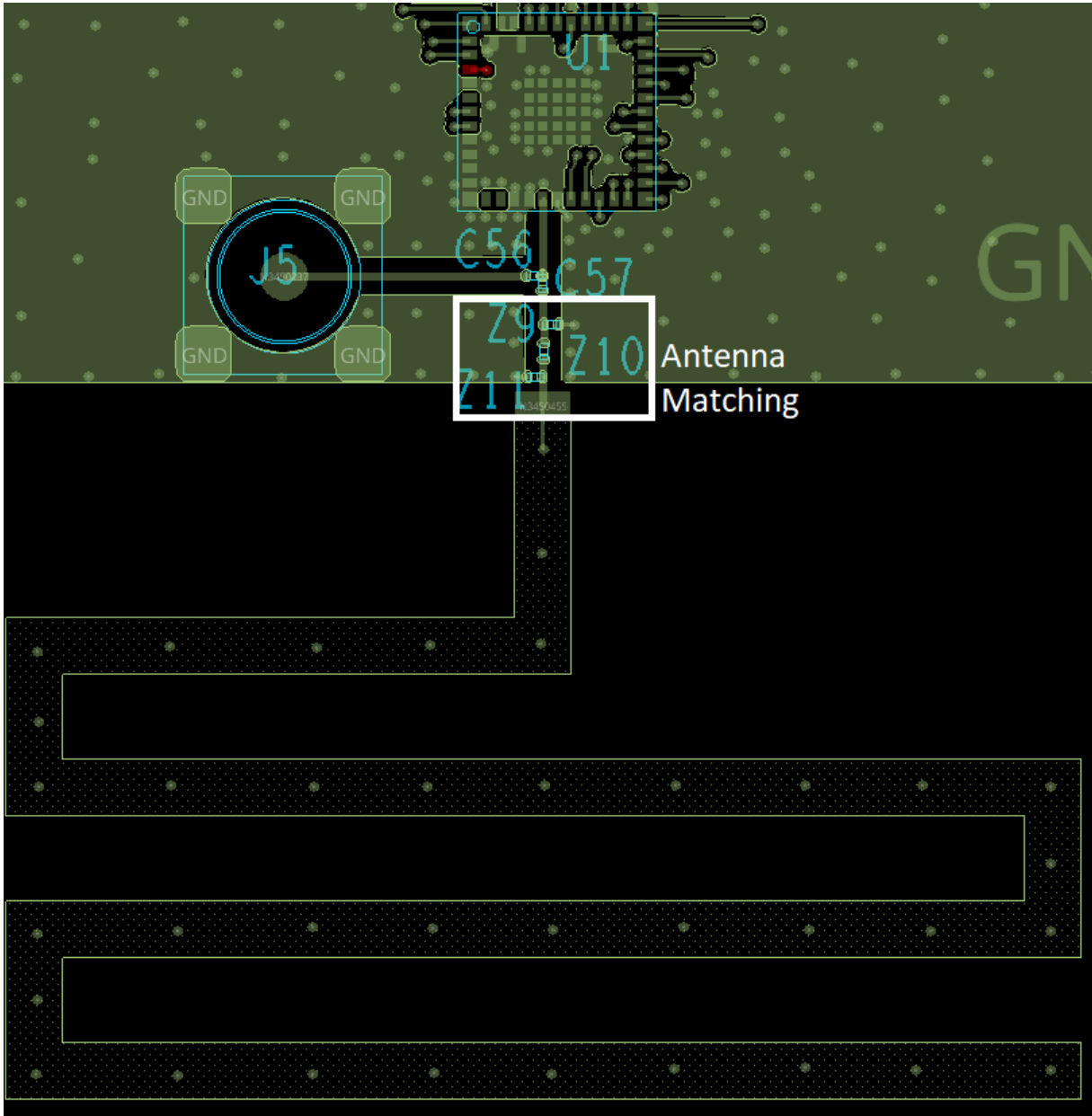

Figure 10-2. Module Layout Guidelines

Follow these RF layout recommendations for the module:

- RF traces must have a characteristic impedance of 50- Ω .
- There must be no traces or ground under the antenna section.
- RF traces must have via stitching on the ground plane beside the RF trace on both sides.
- RF traces must be as short as possible.
- The module must be as close to the PCB edge in consideration of the product enclosure and type of antenna being used.

10.3.2.1 Antenna Placement and Routing

The antenna is the element used to convert the guided waves on the PCB traces to the free space electromagnetic radiation. The placement and layout of the antenna are the keys to increased range and data rates. [Table 10-2](#) provides a summary of the antenna guidelines to follow with the CC1312PSIP module.

Table 10-2. Antenna Guidelines

SR NO.	GUIDELINES
1	Place the antenna on an edge of the PCB.
2	Ensure that no signals are routed across the antenna elements on any PCB layer.
3	Most antennas, including the PCB antenna used on the LaunchPad™, require ground clearance on all the layers of the PCB. Ensure that the ground is cleared on inner layers as well.
4	Ensure that there is provision to place matching components for the antenna. These must be tuned for best return loss when the complete board is assembled. Any plastics or casing must also be mounted while tuning the antenna because this can impact the impedance.
5	Ensure that the antenna characteristic impedance is 50-Ω as the module is designed for a 50-Ω system.
6	In case of printed antenna, ensure that the simulation is performed considering the soldermask thickness.
7	For good RF performance ensure that the Voltage Standing Wave Ratio (VSWR) is less than 2 across the frequency band of interest.
9	The feed point of the antenna is required to be grounded. This is only for the antenna type used on the LP-EM-CC1312PSIP LaunchPad™. See the specific antenna data sheets for the recommendations.

[Table 10-3](#) lists the recommended antennas to use with the CC1312PSIP module. Other antennas may be available for use with the CC1312PSIP module. Please refer to the CC1312PSIP Manual Information for the End User and OEM Installation Guide for a list of approved antennas (and antenna types) that can be used with the CC1312PSIP module.

Table 10-3. Recommended Antennas

CHOICE	ANTENNA	MANUFACTURER	NOTES
1	Integrated PCB antenna on the LP-EM-CC1312PSIP	Texas Instruments	+2.7 dBi gain at 915 MHz, see the LP-EM-CC1312PSIP reference design
3	External whip antenna	Pulse, W5017	+0.9 dBi gain at 915 MHz
4	Chip antenna	Johanson Technology, 0900AT43A0070	-0.5 dBi gain at 915 MHz
5	Chip antenna	Johanson Technology, 0915AT43A0026	+1.0 dBi gain at 915 MHz
6	Helical wire antenna	Pulse, W3113	+0.8 dBi gain at 915 MHz

10.3.2.2 Transmission Line Considerations

The RF signal from the module is routed to the antenna using a Coplanar Waveguide with ground (CPW-G) structure. CPW-G structure offers the maximum amount of isolation and the best possible shielding to the RF lines. In addition to the ground on the L1 layer, placing GND vias along the line also provides additional shielding.

Figure 10-3 shows a cross section of the coplanar waveguide with the critical dimensions.

Figure 10-4 shows the top view of the coplanar waveguide with GND and via stitching.

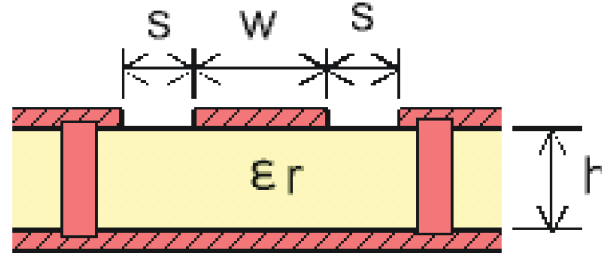

Figure 10-3. Coplanar Waveguide (Cross Section)

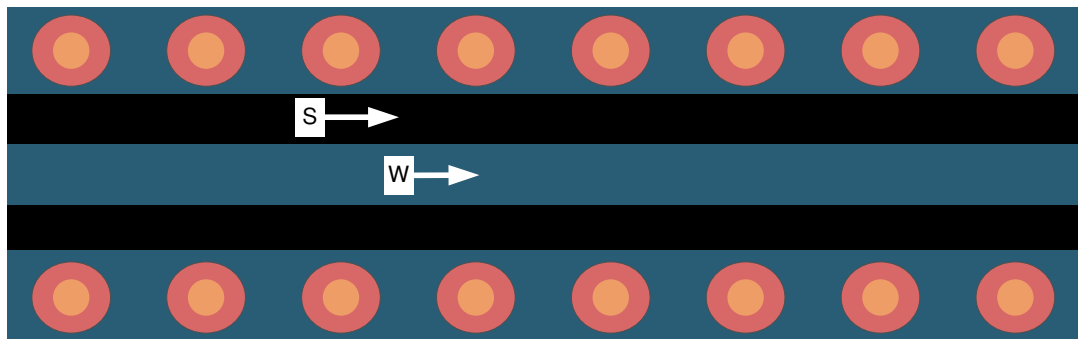

Figure 10-4. CPW With GND and Via Stitching (Top View)

The recommended values for a 4-layer PCB board is provided in [Table 10-4](#).

Table 10-4. Recommended PCB Values for 4-Layer Board (L1 to L2 = 0.175 mm)

PARAMETER	VALUE	UNITS
W	0.300	mm
S	0.500	mm
H	0.175	mm
Er (FR-4 substrate)	4.0	F/m

10.4 Reference Designs

The following reference designs should be followed closely when implementing designs using the CC1312PSIP device.

Special attention must be paid to RF component placement, decoupling capacitors and DCDC regulator components, as well as ground connections for all of these.

[LP-EM-CC1312PSIP Design Files](#)

The LP-EM-CC1312PSIP reference design provides schematic, layout and production files for the characterization board used for deriving the performance number found in this document.

[Sub-1 GHz and 2.4 GHz Antenna Kit for LaunchPad™ Development Kit and SensorTag](#)

The antenna kit allows real-life testing to identify the optimal antenna for your application. The antenna kit includes 16 antennas for frequencies from 169 MHz to 2.4 GHz, including:

- PCB antennas
- Helical antennas
- Chip antennas
- Dual-band antennas for 868 MHz and 915 MHz combined with 2.4 GHz

The antenna kit includes a JSC cable to connect to the Wireless MCU LaunchPad Development Kits and SensorTags.

11 Environmental Requirements and SMT Specifications

11.1 PCB Bending

The PCB follows IPC-A-600J for PCB twist and warpage < 0.75% or 7.5 mil per inch.

11.2 Handling Environment

11.2.1 Terminals

The product is mounted with motherboard through land-grid array (LGA). To prevent poor soldering, do not make skin contact with the LGA portion.

11.2.2 Falling

The mounted components will be damaged if the product falls or is dropped. Such damage may cause the product to malfunction.

11.3 Storage Condition

11.3.1 Moisture Barrier Bag Before Opened

A moisture barrier bag must be stored in a temperature of less than 30°C with humidity under 85% RH. The calculated shelf life for the dry-packed product will be 24 months from the date the bag is sealed.

11.3.2 Moisture Barrier Bag Open

Humidity indicator cards must be blue, < 30%.

11.4 PCB Assembly Guide

The wireless MCU modules are packaged in a substrate base Leadless Quad Flatpack (QFM) package. The modules are designed with pull back leads for easy PCB layout and board mounting.

11.4.1 PCB Land Pattern & Thermal Vias

We recommended a solder mask defined land pattern to provide a consistent soldering pad dimension in order to obtain better solder balancing and solder joint reliability. PCB land pattern are 1:1 to module soldering pad dimension. Thermal vias on PCB connected to other metal plane are for thermal dissipation purpose. It is critical to have sufficient thermal vias to avoid device thermal shutdown. Recommended vias size are 0.2mm and position not directly under solder paste to avoid solder dripping into the vias.

11.4.2 SMT Assembly Recommendations

The module surface mount assembly operations include:

- Screen printing the solder paste on the PCB
- Monitor the solder paste volume (uniformity)
- Package placement using standard SMT placement equipment
- X-ray pre-reflow check - paste bridging
- Reflow
- X-ray post-reflow check - solder bridging and voids

11.4.3 PCB Surface Finish Requirements

A uniform PCB plating thickness is key for high assembly yield. For an electroless nickel immersion gold finish, the gold thickness should range from 0.05 μm to 0.20 μm to avoid solder joint embrittlement. Using a PCB with Organic Solderability Preservative (OSP) coating finish is also recommended as an alternative to Ni-Au.

11.4.4 Solder Stencil

Solder paste deposition using a stencil-printing process involves the transfer of the solder paste through pre-defined apertures with the application of pressure. Stencil parameters such as aperture area ratio and the fabrication process have a significant impact on paste deposition. Inspection of the stencil prior to placement of package is highly recommended to improve board assembly yields.

11.4.5 Package Placement

Packages can be placed using standard pick and place equipment with an accuracy of ± 0.05 mm. Component pick and place systems are composed of a vision system that recognizes and positions the component and a mechanical system that physically performs the pick and place operation. Two commonly used types of vision systems are:

- A vision system that locates a package silhouette
- A vision system that locates individual pads on the interconnect pattern

The second type renders more accurate placements but tends to be more expensive and time consuming. Both methods are acceptable since the parts align due to a self-centering features of the solder joint during solder reflow. It is recommended to avoid solder bridging to 2 mils into the solder paste or with minimum force to avoid causing any possible damage to the thinner packages.

11.4.6 Solder Joint Inspection

After surface mount assembly, transmission X-ray should be used for sample monitoring of the solder attachment process. This identifies defects such as solder bridging, shorts, opens, and voids. It is also recommended to use side view inspection in addition to X-rays to determine if there are "Hour Glass" shaped solder and package tilting existing. The "Hour Glass" solder shape is not a reliable joint. 90° mirror projection can be used for side view inspection.

11.4.7 Rework and Replacement

TI recommends removal of modules by rework station applying a profile similar to the mounting process. Using a heat gun can sometimes cause damage to the module by overheating.

11.4.8 Solder Joint Voiding

TI recommends to control solder joint voiding to be less than 30% (per IPC-7093). Solder joint voids could be reduced by baking of components and PCB, minimized solder paste exposure duration, and reflow profile optimization.

11.5 Baking Conditions

Products require baking before mounting if:

- Humidity indicator cards read $> 30\%$
- Temp $< 30^\circ\text{C}$, humidity $< 70\%$ RH, over 96 hours

Baking condition: 90°C , 12 to 24 hours

Baking times: 1 time

11.6 Soldering and Reflow Condition

- Heating method: Conventional convection or IR convection
- Temperature measurement: Thermocouple d = 0.1 mm to 0.2 mm CA (K) or CC (T) at soldering portion or equivalent method
- Solder paste composition: SAC305
- Allowable reflow soldering times: 2 times based on the reflow soldering profile (see [Figure 11-1](#))
- Temperature profile: Reflow soldering will be done according to the temperature profile (see [Figure 11-1](#))
- Peak temperature: 240°C

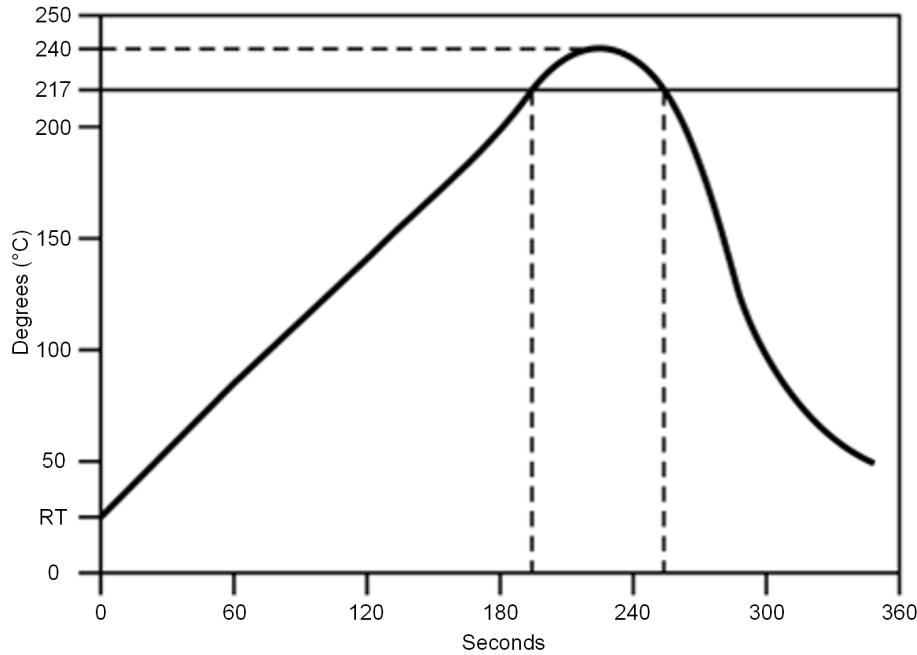

Figure 11-1. Temperature Profile for Evaluation of Solder Heat Resistance of a Component (at Solder Joint)

Table 11-1. Temperature Profile

Profile Elements	Convection or IR ⁽¹⁾
Peak temperature range	235 to 240°C typical
Pre-heat / soaking (150 to 180°C)	60 to 120 seconds
Time above melting point	< 90 seconds
Time above 230°C	30 seconds maximum
Ramp up	< 3°C / second
Ramp down	< 3°C / second

(1) For details, refer to the solder paste manufacturer's recommendation.

Note

TI does not recommend the use of conformal coating or similar material on the SimpleLink™ module. This coating can lead to localized stress on the solder connections inside the module and impact the module reliability. Use caution during the module assembly process to the final PCB to avoid the presence of foreign material inside the module.

12 Device and Documentation Support

TI offers an extensive line of development tools. Tools and software to evaluate the performance of the device, generate code, and develop solutions are listed as follows.

12.1 Device Nomenclature

To designate the stages in the product development cycle, TI assigns prefixes to all part numbers and/or date-code. Each device has one of three prefixes/identifications: X, P, or null (no prefix) (for example, XCC1312PSIP is in preview; therefore, an X prefix/identification is assigned).

Device development evolutionary flow:

- X** Experimental device that is not necessarily representative of the final device's electrical specifications and may not use production assembly flow.
- P** Prototype device that is not necessarily the final silicon die and may not necessarily meet final electrical specifications.
- null** Production version of the silicon die that is fully qualified.

Production devices have been characterized fully, and the quality and reliability of the device have been demonstrated fully. TI's standard warranty applies.

Predictions show that prototype devices (X or P) have a greater failure rate than the standard production devices. Texas Instruments recommends that these devices not be used in any production system because their expected end-use failure rate still is undefined. Only qualified production devices are to be used.

TI device nomenclature also includes a suffix with the device family name. This suffix indicates the package type (for example, RGZ).

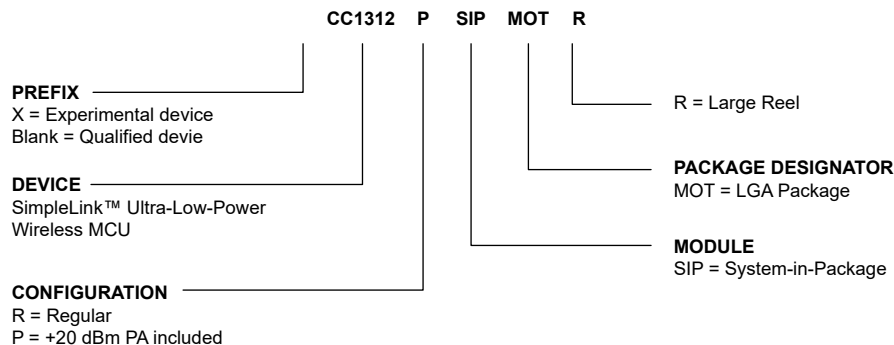

Figure 12-1. Device Nomenclature

12.2 Tools and Software

The CC1312PSIP device is supported by a variety of software and hardware development tools.

Development Kit

Software

[SimpleLink Low Power F2 SDK](#)

The SimpleLink Low Power F2 SDK provides a complete package for the development of wireless applications on the CC13x2 / CC26x2 family of devices. The SDK includes a comprehensive software package for the CC1312PSIP device, including the following protocol stacks:

- Wi-SUN®
- TI 15.4-Stack - an IEEE 802.15.4-based star networking solution for Sub-1 GHz and 2.4 GHz
- Prop RF API - a flexible set of building blocks for developing proprietary RF software stacks

The SimpleLink Low Power F2 SDK is part of TI's SimpleLink MCU platform, offering a single development environment that delivers flexible hardware, software and tool options for customers developing wired and wireless applications. For more information about the SimpleLink MCU Platform, visit <https://www.ti.com/simplelink>.

Development Tools

Code Composer Studio™ Integrated Development Environment (IDE)

Code Composer Studio is an integrated development environment (IDE) that supports TI's Microcontroller and Embedded Processors portfolio. Code Composer Studio comprises a suite of tools used to develop and debug embedded applications. It includes an optimizing C/C++ compiler, source code editor, project build environment, debugger, profiler, and many other features. The intuitive IDE provides a single user interface taking you through each step of the application development flow. Familiar tools and interfaces allow users to get started faster than ever before. Code Composer Studio combines the advantages of the Eclipse® software framework with advanced embedded debug capabilities from TI resulting in a compelling feature-rich development environment for embedded developers.

CCS has support for all SimpleLink Wireless MCUs and includes support for EnergyTrace™ software (application energy usage profiling). A real-time object viewer plugin is available for TI-RTOS, part of the SimpleLink SDK.

Code Composer Studio is provided free of charge when used in conjunction with the XDS debuggers included on a LaunchPad Development Kit.

Code Composer Studio™ Cloud IDE

Code Composer Studio (CCS) Cloud is a web-based IDE that allows you to create, edit and build CCS and Energia™ projects. After you have successfully built your project, you can download and run on your connected LaunchPad. Basic debugging, including features like setting breakpoints and viewing variable values is now supported with CCS Cloud.

IAR Embedded Workbench® for Arm®

IAR Embedded Workbench® is a set of development tools for building and debugging embedded system applications using assembler, C and C++. It provides a completely integrated development environment that includes a project manager, editor, and build tools. IAR has support for all SimpleLink Wireless MCUs. It offers broad debugger support, including XDS110, IAR I-jet™ and Segger J-Link™. A real-time object viewer plugin is available for TI-RTOS, part of the SimpleLink SDK. IAR is also supported out-of-the-box on most software examples provided as part of the SimpleLink SDK.

A 30-day evaluation or a 32 KB size-limited version is available through iar.com.

SmartRF™ Studio

SmartRF™ Studio is a Windows® application that can be used to evaluate and configure SimpleLink Wireless MCUs from Texas Instruments. The application will help designers of RF systems to easily evaluate the radio at an early stage in the design process. It is especially useful for generation of configuration register values and for practical testing and debugging of the RF system. SmartRF Studio can be used either as a standalone application or together with applicable evaluation boards or debug probes for the RF device. Features of the SmartRF Studio include:

- Link tests - send and receive packets between nodes
- Antenna and radiation tests - set the radio in continuous wave TX and RX states
- Export radio configuration code for use with the TI SimpleLink SDK RF driver
- Custom GPIO configuration for signaling and control of external switches

Sensor Controller Studio

Sensor Controller Studio is used to write, test and debug code for the Sensor Controller peripheral. The tool generates a Sensor Controller Interface driver, which is a set of C source files that are compiled into the System CPU application. These source files also contain the Sensor Controller binary image and allow the System CPU application to control and exchange data with the Sensor Controller. Features of the Sensor Controller Studio include:

- Ready-to-use examples for several common use cases
- Full toolchain with built-in compiler and assembler for programming in a C-like programming language
- Provides rapid development by using the integrated sensor controller task testing and debugging functionality, including visualization of sensor data and verification of algorithms

CCS UniFlash

CCS UniFlash is a standalone tool used to program on-chip flash memory on TI MCUs. UniFlash has a GUI, command line, and scripting interface. CCS UniFlash is available free of charge.

12.2.1 SimpleLink™ Microcontroller Platform

The SimpleLink microcontroller platform sets a new standard for developers with the broadest portfolio of wired and wireless Arm® MCUs (System-on-Chip) in a single software development environment. Delivering flexible hardware, software and tool options for your IoT applications. Invest once in the SimpleLink software development kit and use throughout your entire portfolio. Learn more on [ti.com/simplelink](https://www.ti.com/simplelink).

12.3 Documentation Support

To receive notification of documentation updates on data sheets, errata, application notes and similar, navigate to the device product folder on [ti.com/product/CC1312PSIP](https://www.ti.com/product/CC1312PSIP). In the upper right corner, click on *Alert me* to register and receive a weekly digest of any product information that has changed. For change details, review the revision history included in any revised document.

The current documentation that describes the MCU, related peripherals, and other technical collateral is listed as follows.

TI Resource Explorer

TI Resource Explorer

Software examples, libraries, executables, and documentation are available for your device and development board.

Errata

CC1312PSIP Silicon Errata

The silicon errata describes the known exceptions to the functional specifications for each silicon revision of the device and description on how to recognize a device revision.

Application Reports

All application reports for the CC1312PSIP device are found on the device product folder at: [ti.com/product/CC1312PSIP/technicaldocuments](https://www.ti.com/product/CC1312PSIP/technicaldocuments).

Technical Reference Manual (TRM)

CC13x2, CC26x2 SimpleLink™ Wireless MCU TRM

The TRM provides a detailed description of all modules and peripherals available in the device family.

12.4 Support Resources

[TI E2E™ support forums](#) are an engineer's go-to source for fast, verified answers and design help — straight from the experts. Search existing answers or ask your own question to get the quick design help you need.

Linked content is provided "AS IS" by the respective contributors. They do not constitute TI specifications and do not necessarily reflect TI's views; see TI's [Terms of Use](#).

12.5 Trademarks

SimpleLink™, LaunchPad™, Code Composer Studio™, EnergyTrace™, and TI E2E™ are trademarks of Texas Instruments.

I-jet™ is a trademark of IAR Systems AB.

J-Link™ is a trademark of SEGGER Microcontroller Systeme GmbH.

Arm® and Cortex® are registered trademarks of Arm Limited (or its subsidiaries) in the US and/or elsewhere.

CoreMark® is a registered trademark of Embedded Microprocessor Benchmark Consortium Corporation.
are registered trademarks of Arm.

Wi-Fi® is a registered trademark of Wi-Fi Alliance.

Bluetooth® is a registered trademark of Bluetooth.

Arm Thumb® is a registered trademark of Arm Limited (or its subsidiaries).

Eclipse® is a registered trademark of Eclipse Foundation.

IAR Embedded Workbench® is a registered trademark of IAR Systems AB.

Windows® is a registered trademark of Microsoft Corporation.

All trademarks are the property of their respective owners.

12.6 Electrostatic Discharge Caution



This integrated circuit can be damaged by ESD. Texas Instruments recommends that all integrated circuits be handled with appropriate precautions. Failure to observe proper handling and installation procedures can cause damage.

ESD damage can range from subtle performance degradation to complete device failure. Precision integrated circuits may be more susceptible to damage because very small parametric changes could cause the device not to meet its published specifications.

12.7 Glossary

[TI Glossary](#) This glossary lists and explains terms, acronyms, and definitions.

13 Mechanical, Packaging, and Orderable Information

The following pages include mechanical packaging and orderable information. This information is the most current data available for the designated devices. This data is subject to change without notice and revision of this document. For browser-based versions of this data sheet, refer to the left-hand navigation.

Note

The total height of the module is 1.51 mm.

The weight of the CC1312PSIP module is typically 0.19 g.

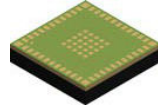

MOT0048A

PACKAGE OUTLINE

QFM - 1.51 mm max height

QUAD FLAT MODULE

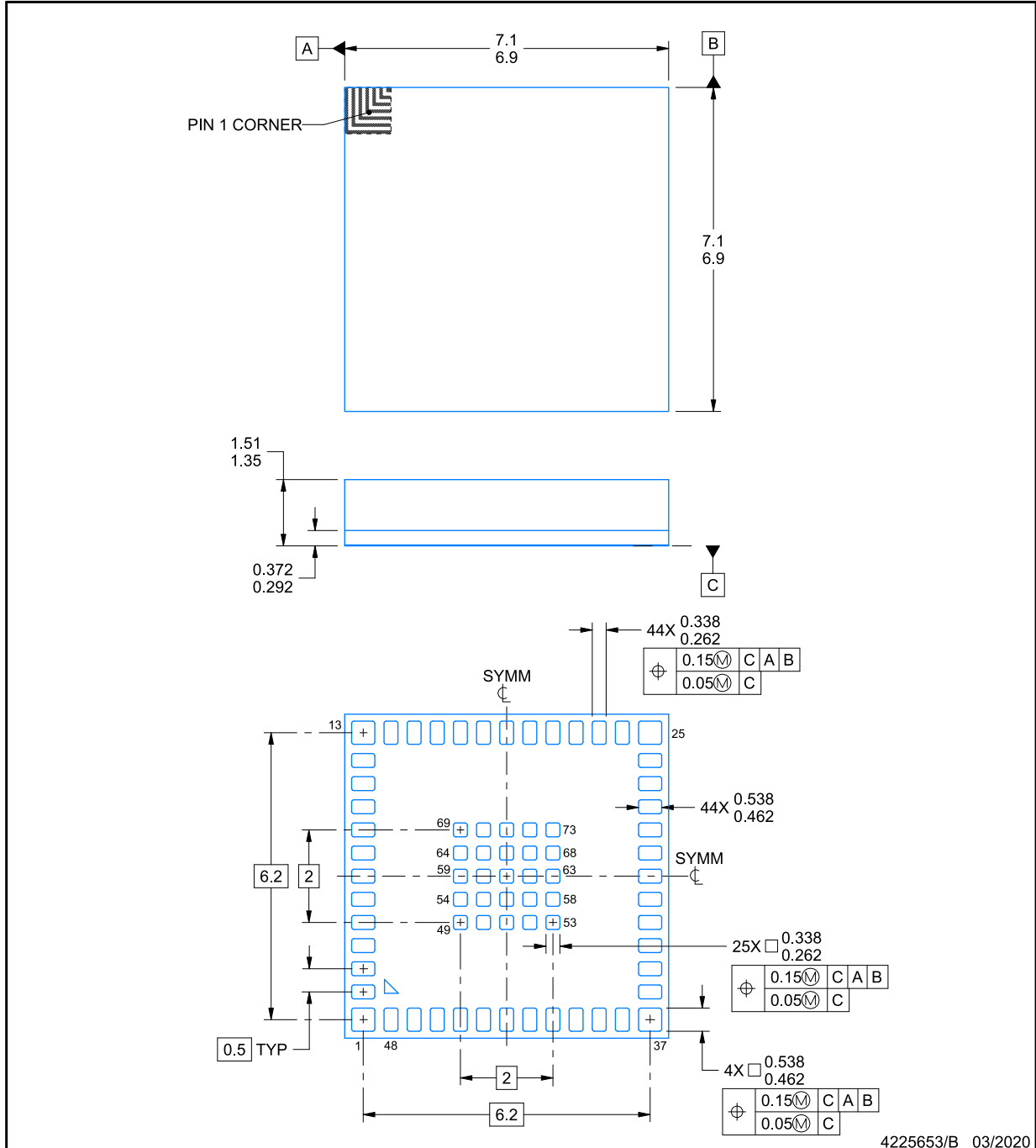

4225653/B 03/2020

NOTES:

1. All linear dimensions are in millimeters. Any dimensions in parenthesis are for reference only. Dimensioning and tolerancing per ASME Y14.5M.
2. This drawing is subject to change without notice.

EXAMPLE BOARD LAYOUT

MOT0048A

QFM - 1.51 mm max height

QUAD FLAT MODULE

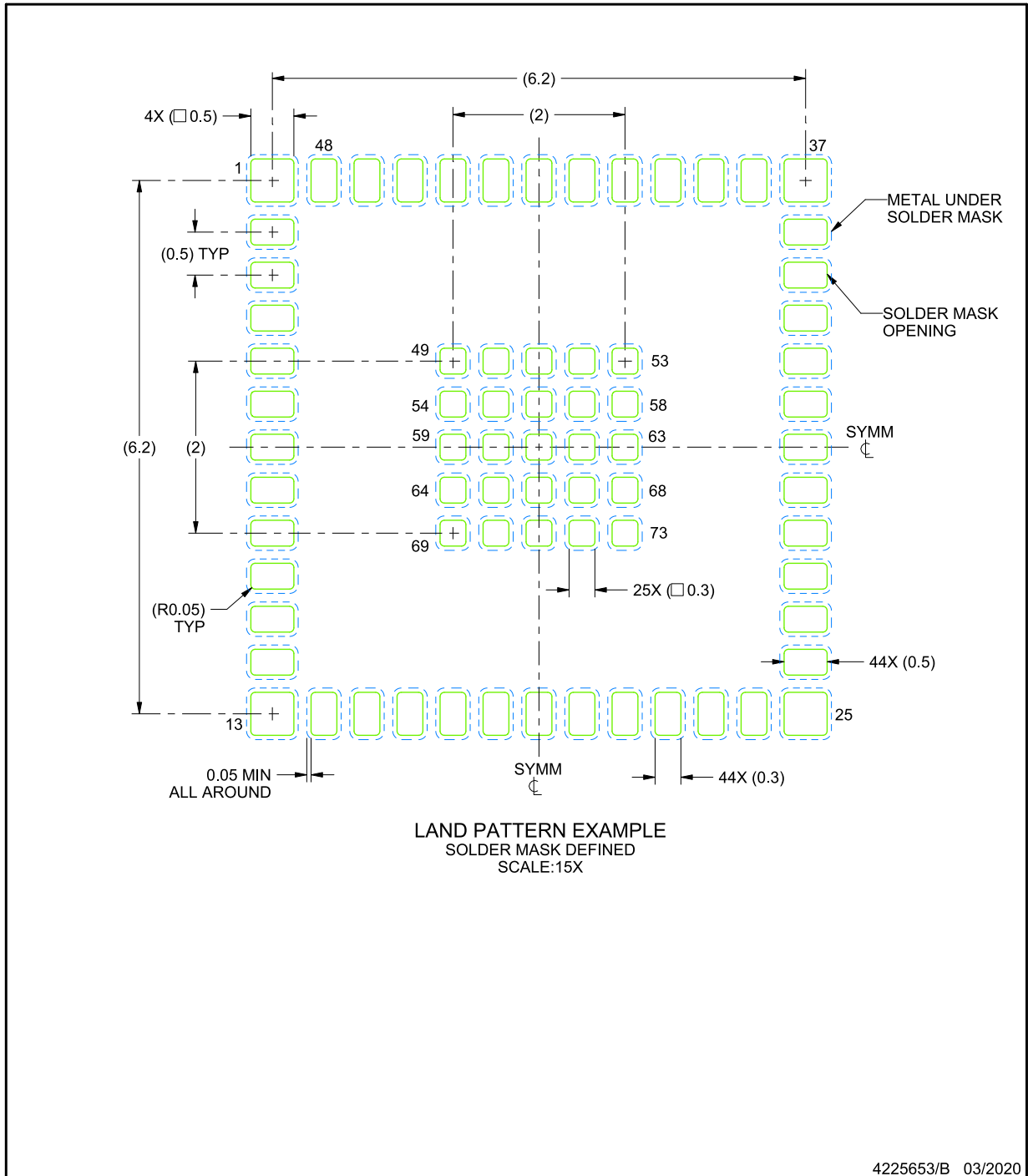

NOTES: (continued)

- This package is designed to be soldered to a thermal pad on the board. For more information, see Texas Instruments literature number SLUA271 (www.ti.com/lit/slua271).

EXAMPLE STENCIL DESIGN

MOT0048A

QFM - 1.51 mm max height

QUAD FLAT MODULE

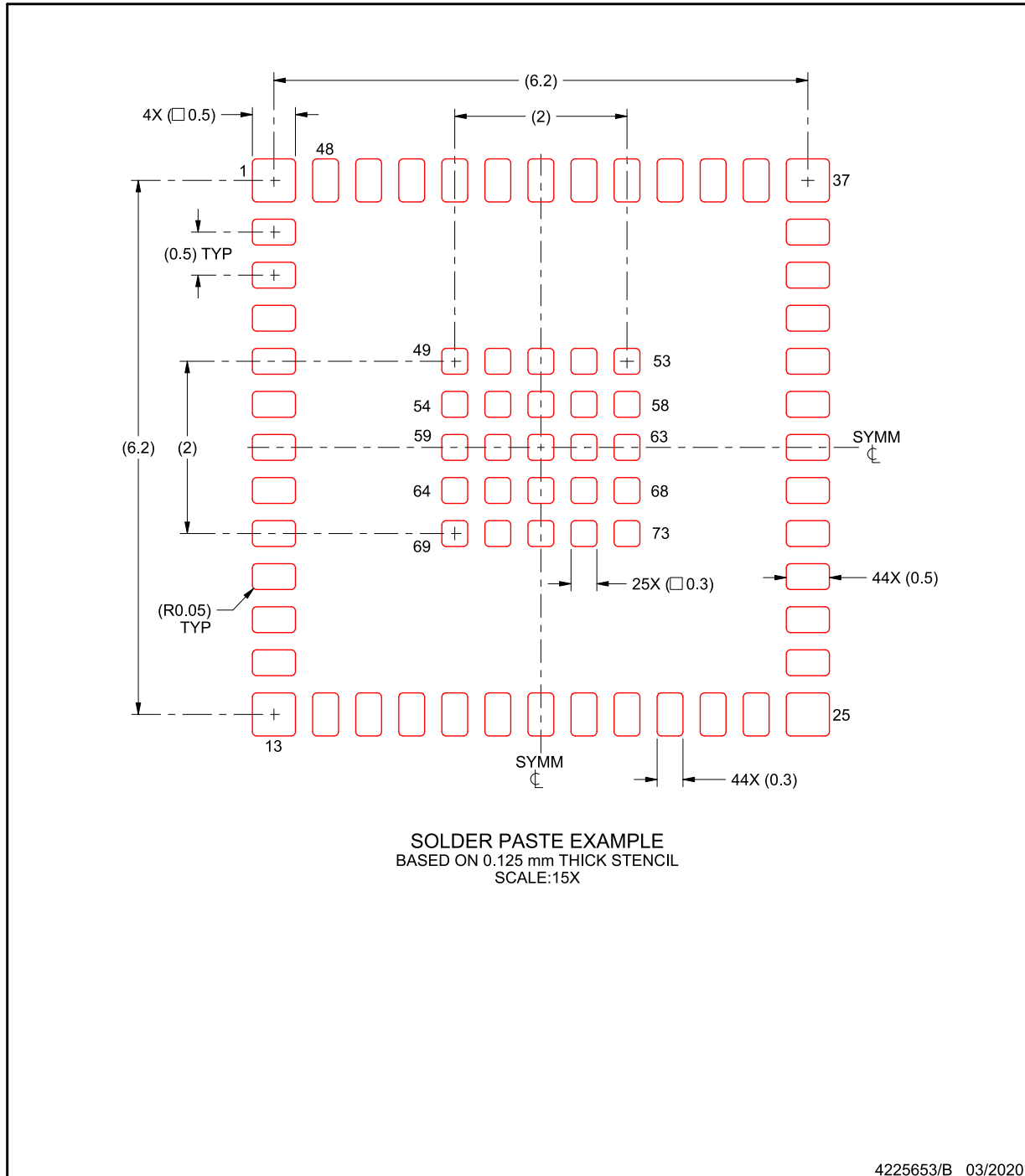

NOTES: (continued)

4. Laser cutting apertures with trapezoidal walls and rounded corners may offer better paste release. IPC-7525 may have alternate design recommendations.

PACKAGING INFORMATION

Orderable Device	Status (1)	Package Type	Package Drawing	Pins	Package Qty	Eco Plan (2)	Lead finish/ Ball material (6)	MSL Peak Temp (3)	Op Temp (°C)	Device Marking (4/5)	Samples
CC1312PSIPMOTR	ACTIVE	QFM	MOT	48	2000	RoHS (In Work) & Green (In Work)	ENEPIG	Level-3-260C-168 HR	-40 to 105	CC1312 P SIP	Samples

(1) The marketing status values are defined as follows:

ACTIVE: Product device recommended for new designs.

LIFEBUY: TI has announced that the device will be discontinued, and a lifetime-buy period is in effect.

NRND: Not recommended for new designs. Device is in production to support existing customers, but TI does not recommend using this part in a new design.

PREVIEW: Device has been announced but is not in production. Samples may or may not be available.

OBSOLETE: TI has discontinued the production of the device.

(2) **RoHS:** TI defines "RoHS" to mean semiconductor products that are compliant with the current EU RoHS requirements for all 10 RoHS substances, including the requirement that RoHS substance do not exceed 0.1% by weight in homogeneous materials. Where designed to be soldered at high temperatures, "RoHS" products are suitable for use in specified lead-free processes. TI may reference these types of products as "Pb-Free".

RoHS Exempt: TI defines "RoHS Exempt" to mean products that contain lead but are compliant with EU RoHS pursuant to a specific EU RoHS exemption.

Green: TI defines "Green" to mean the content of Chlorine (Cl) and Bromine (Br) based flame retardants meet JS709B low halogen requirements of <=1000ppm threshold. Antimony trioxide based flame retardants must also meet the <=1000ppm threshold requirement.

(3) MSL, Peak Temp. - The Moisture Sensitivity Level rating according to the JEDEC industry standard classifications, and peak solder temperature.

(4) There may be additional marking, which relates to the logo, the lot trace code information, or the environmental category on the device.

(5) Multiple Device Markings will be inside parentheses. Only one Device Marking contained in parentheses and separated by a "~" will appear on a device. If a line is indented then it is a continuation of the previous line and the two combined represent the entire Device Marking for that device.

(6) Lead finish/Ball material - Orderable Devices may have multiple material finish options. Finish options are separated by a vertical ruled line. Lead finish/Ball material values may wrap to two lines if the finish value exceeds the maximum column width.

Important Information and Disclaimer:The information provided on this page represents TI's knowledge and belief as of the date that it is provided. TI bases its knowledge and belief on information provided by third parties, and makes no representation or warranty as to the accuracy of such information. Efforts are underway to better integrate information from third parties. TI has taken and continues to take reasonable steps to provide representative and accurate information but may not have conducted destructive testing or chemical analysis on incoming materials and chemicals. TI and TI suppliers consider certain information to be proprietary, and thus CAS numbers and other limited information may not be available for release.

In no event shall TI's liability arising out of such information exceed the total purchase price of the TI part(s) at issue in this document sold by TI to Customer on an annual basis.

TAPE AND REEL INFORMATION

QUADRANT ASSIGNMENTS FOR PIN 1 ORIENTATION IN TAPE



*All dimensions are nominal

Device	Package Type	Package Drawing	Pins	SPQ	Reel Diameter (mm)	Reel Width W1 (mm)	A0 (mm)	B0 (mm)	K0 (mm)	P1 (mm)	W (mm)	Pin1 Quadrant
CC1312PSIPMOTR	QFM	MOT	48	2000	330.0	16.4	7.4	7.4	1.88	12.0	16.0	Q1

TAPE AND REEL BOX DIMENSIONS

*All dimensions are nominal

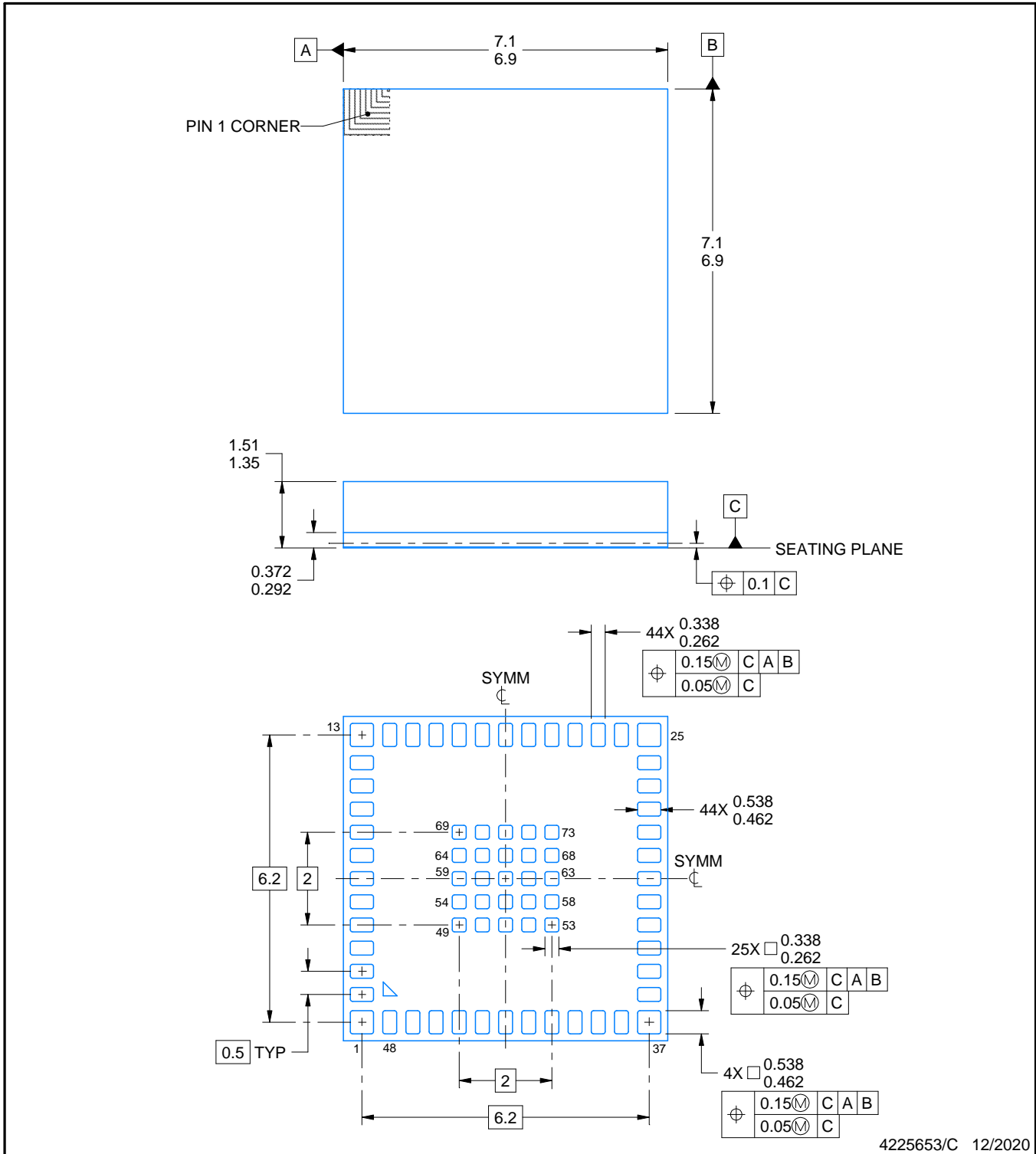
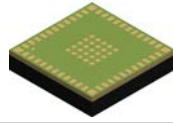
Device	Package Type	Package Drawing	Pins	SPQ	Length (mm)	Width (mm)	Height (mm)
CC1312PSIPMOTR	QFM	MOT	48	2000	336.6	336.6	31.8



NOTES:

1. All linear dimensions are in millimeters. Any dimensions in parenthesis are for reference only. Dimensioning and tolerancing per ASME Y14.5M.
2. This drawing is subject to change without notice.

EXAMPLE BOARD LAYOUT

MOT0048A

QFM - 1.51 mm max height

QUAD FLAT MODULE

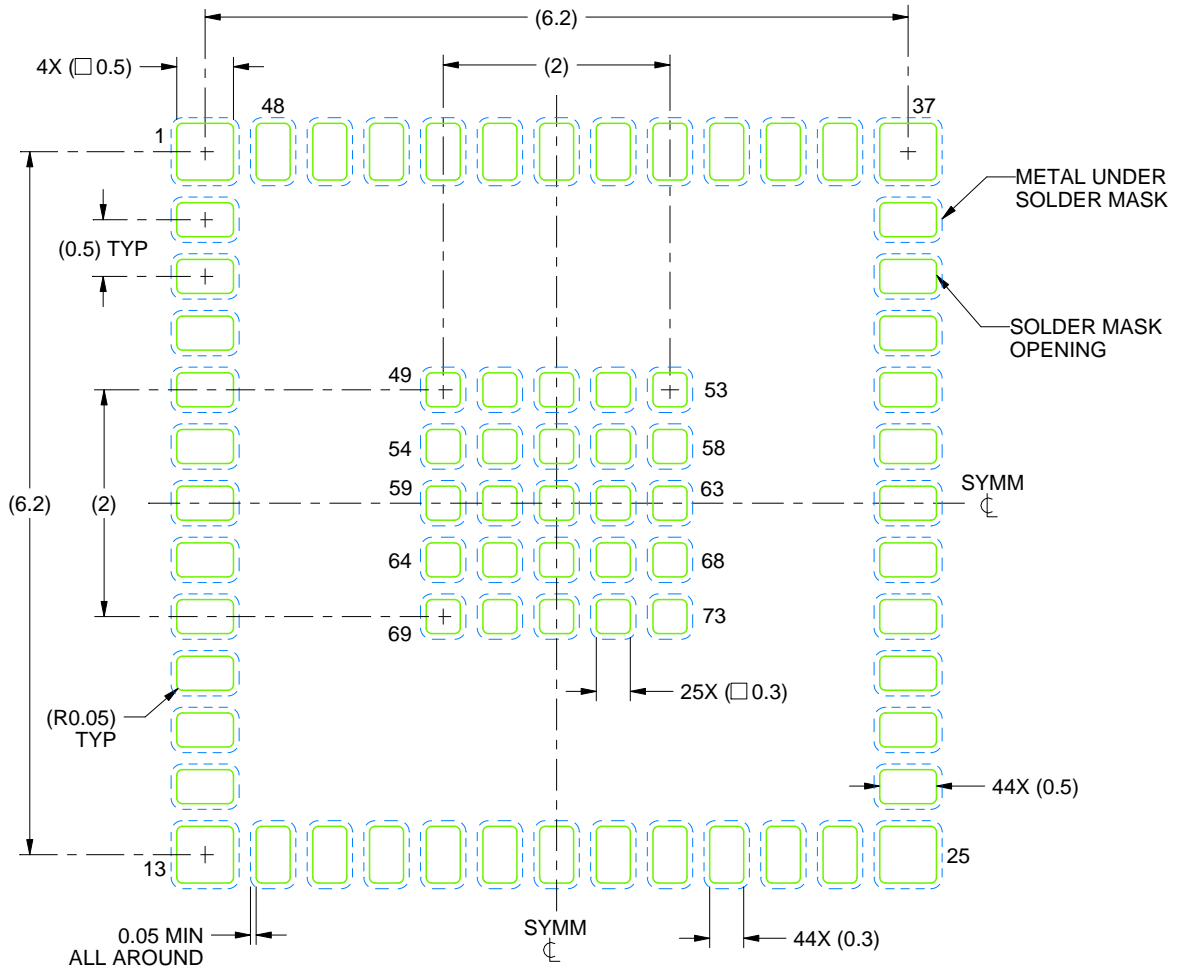

LAND PATTERN EXAMPLE
SOLDER MASK DEFINED
SCALE:15X

4225653/C 12/2020

NOTES: (continued)

3. This package is designed to be soldered to a thermal pad on the board. For more information, see Texas Instruments literature number SLUA271 (www.ti.com/lit/sluea271).

EXAMPLE STENCIL DESIGN

MOT0048A

QFM - 1.51 mm max height

QUAD FLAT MODULE

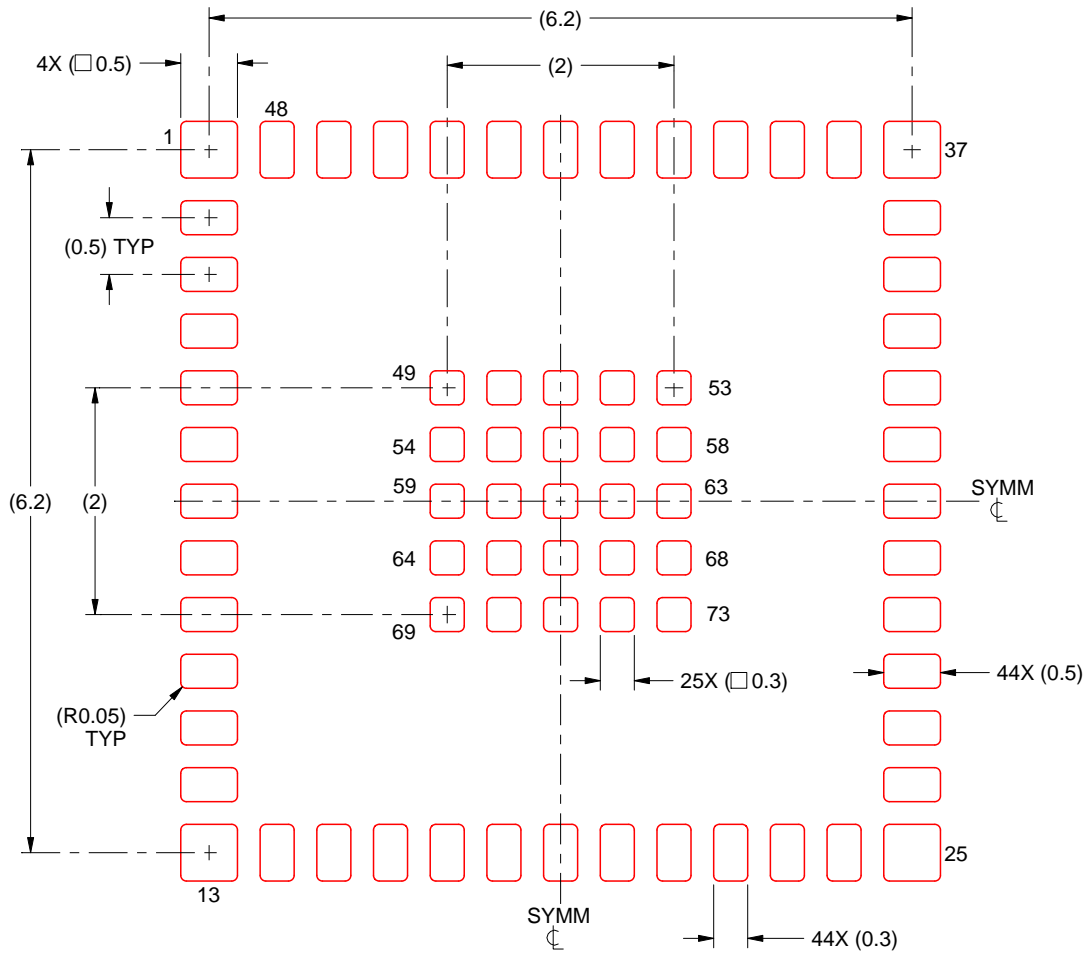

SOLDER PASTE EXAMPLE
 BASED ON 0.125 mm THICK STENCIL
 SCALE:15X

4225653/C 12/2020

NOTES: (continued)

4. Laser cutting apertures with trapezoidal walls and rounded corners may offer better paste release. IPC-7525 may have alternate design recommendations.

IMPORTANT NOTICE AND DISCLAIMER

TI PROVIDES TECHNICAL AND RELIABILITY DATA (INCLUDING DATA SHEETS), DESIGN RESOURCES (INCLUDING REFERENCE DESIGNS), APPLICATION OR OTHER DESIGN ADVICE, WEB TOOLS, SAFETY INFORMATION, AND OTHER RESOURCES "AS IS" AND WITH ALL FAULTS, AND DISCLAIMS ALL WARRANTIES, EXPRESS AND IMPLIED, INCLUDING WITHOUT LIMITATION ANY IMPLIED WARRANTIES OF MERCHANTABILITY, FITNESS FOR A PARTICULAR PURPOSE OR NON-INFRINGEMENT OF THIRD PARTY INTELLECTUAL PROPERTY RIGHTS.

These resources are intended for skilled developers designing with TI products. You are solely responsible for (1) selecting the appropriate TI products for your application, (2) designing, validating and testing your application, and (3) ensuring your application meets applicable standards, and any other safety, security, regulatory or other requirements.

These resources are subject to change without notice. TI grants you permission to use these resources only for development of an application that uses the TI products described in the resource. Other reproduction and display of these resources is prohibited. No license is granted to any other TI intellectual property right or to any third party intellectual property right. TI disclaims responsibility for, and you will fully indemnify TI and its representatives against, any claims, damages, costs, losses, and liabilities arising out of your use of these resources.

TI's products are provided subject to [TI's Terms of Sale](#) or other applicable terms available either on [ti.com](https://www.ti.com) or provided in conjunction with such TI products. TI's provision of these resources does not expand or otherwise alter TI's applicable warranties or warranty disclaimers for TI products.

TI objects to and rejects any additional or different terms you may have proposed.

Mailing Address: Texas Instruments, Post Office Box 655303, Dallas, Texas 75265
Copyright © 2024, Texas Instruments Incorporated