

# OPAx992-Q1 Automotive, 40V Rail-to-Rail Input or Output, Low Offset Voltage, Low Noise Op Amp

## 1 Features

- AEC-Q100 qualified for automotive applications
  - Temperature grade 1:  $-40^{\circ}\text{C}$  to  $+125^{\circ}\text{C}$ ,  $T_A$
  - Device HBM ESD classification level 2A
  - Device CDM ESD classification level C6
- Low offset voltage:  $\pm 210\mu\text{V}$
- Low offset voltage drift:  $\pm 0.25\mu\text{V}/^{\circ}\text{C}$
- Low noise:  $7\text{nV}/\sqrt{\text{Hz}}$  at 1kHz,  $4.4\text{nV}/\sqrt{\text{Hz}}$  broadband
- High common-mode rejection: 115dB
- Low bias current:  $\pm 10\text{pA}$
- Rail-to-rail input and output
- MUX-friendly/comparator inputs
  - Amplifier operates with differential inputs up to supply rail
  - Amplifier can be used in open-loop or as comparator
- Wide bandwidth: 10.6MHz GBW, unity-gain stable
- High slew rate:  $32\text{V}/\mu\text{s}$
- Low quiescent current: 2.4mA per amplifier
- Wide supply:  $\pm 1.35\text{V}$  to  $\pm 20\text{V}$ , 2.7V to 40V
- Robust EMIRR performance

## 2 Applications

- [Automotive head unit](#)
- [Automotive external amplifier](#)
- [Emergency call \(eCall\)](#)
- [Telematics control unit \(TCU\)](#)
- [Traction inverter](#)
- [HEV/EV on-board and wireless charger \(OBC\)](#)
- [HEV/EV DC/DC converter](#)
- [High-side and low-side current sensing](#)

## 3 Description

The OPAx992-Q1 family (OPA992-Q1, OPA2992-Q1, and OPA4992-Q1) is a family of high voltage (40V) general purpose operational amplifiers. These devices offer excellent DC precision and AC performance, including rail-to-rail input or output, low offset ( $\pm 210\mu\text{V}$ , typical), low offset drift ( $\pm 0.25\mu\text{V}/^{\circ}\text{C}$ , typical) and low noise ( $7\text{nV}/\sqrt{\text{Hz}}$  at 1kHz,  $4.4\text{nV}/\sqrt{\text{Hz}}$  at 10kHz).

Features such as differential and common-mode input voltage ranges to the supply rails, high short-circuit current ( $\pm 65\text{mA}$ ), and high slew rate ( $32\text{V}/\mu\text{s}$ ) make the OPAx992-Q1 a flexible, robust, and high-performance op amp for high-voltage automotive applications.

The OPAx992-Q1 family of op amps is available in standard packages (such as SOIC, TSSOP, VSSOP, SOT-23, and SC70), and is specified from  $-40^{\circ}\text{C}$  to  $125^{\circ}\text{C}$ .

### Package Information

PART NUMBER <sup>(1)</sup>	PACKAGE	PACKAGE SIZE <sup>(2)</sup>
OPA992-Q1	DCK (SC70, 5)	2mm × 2.1mm
	DBV (SOT-23, 5)	2.9mm × 2.8mm
OPA2992-Q1	DGK (VSSOP, 8)	3mm × 4.9mm
	PW (TSSOP, 8)	3mm × 6.4mm
	D (SOIC, 8)	4.9mm × 6mm
OPA4992-Q1	PW (TSSOP, 14)	5mm × 6.4mm
	D (SOIC, 14)	8.65mm × 6mm

(1) For all available packages, see the orderable addendum at the end of the data sheet.

(2) The package size (length × width) is a nominal value and includes pins, where applicable.

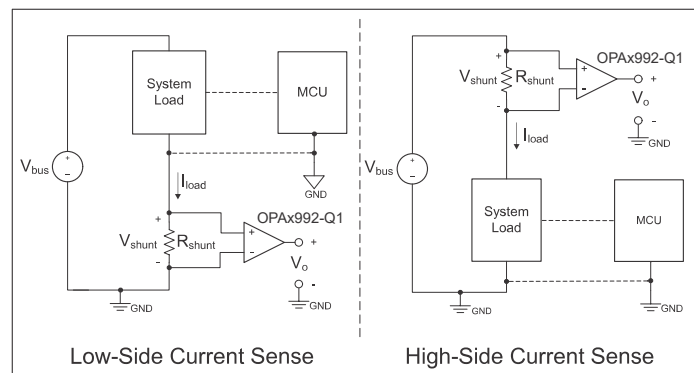

**OPAx992-Q1 in Current-Sensing Applications**



## Table of Contents

<b>1 Features</b> .....	1	6.4 Device Functional Modes.....	26
<b>2 Applications</b> .....	1	<b>7 Application and Implementation</b> .....	27
<b>3 Description</b> .....	1	7.1 Application Information.....	27
<b>4 Pin Configuration and Functions</b> .....	3	7.2 Typical Applications.....	27
<b>5 Specifications</b> .....	6	7.3 Power Supply Recommendations.....	28
5.1 Absolute Maximum Ratings.....	6	7.4 Layout.....	29
5.2 ESD Ratings.....	6	<b>8 Device and Documentation Support</b> .....	31
5.3 Recommended Operating Conditions.....	6	8.1 Device Support.....	31
5.4 Thermal Information for Single Channel.....	7	8.2 Documentation Support.....	31
5.5 Thermal Information for Dual Channel.....	7	8.3 Receiving Notification of Documentation Updates....	31
5.6 Thermal Information for Quad Channel.....	7	8.4 Support Resources.....	31
5.7 Electrical Characteristics.....	8	8.5 Trademarks.....	31
5.8 Typical Characteristics.....	10	8.6 Electrostatic Discharge Caution.....	31
<b>6 Detailed Description</b> .....	18	8.7 Glossary.....	31
6.1 Overview.....	18	<b>9 Revision History</b> .....	32
6.2 Functional Block Diagram.....	18	<b>10 Mechanical, Packaging, and Orderable Information</b> .....	32
6.3 Feature Description.....	19		

## 4 Pin Configuration and Functions

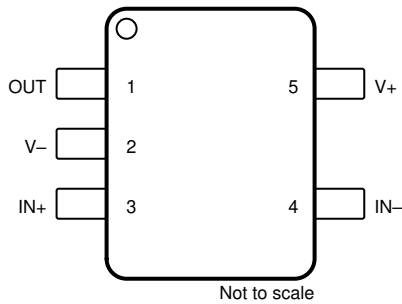

**Figure 4-1. OPA992-Q1 DBV Package,  
5-Pin SOT-23  
(Top View)**

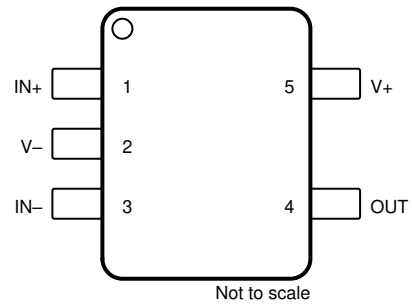
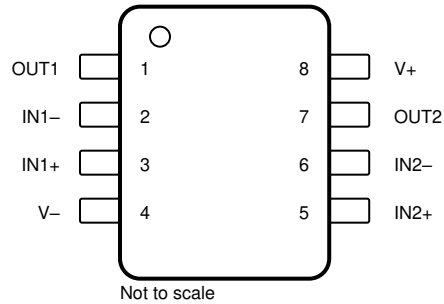

**Figure 4-2. OPA992-Q1 DCK Package,  
5-Pin SC70  
(Top View)**

**Table 4-1. Pin Functions: OPA992-Q1**

NAME	PIN		TYPE <sup>(1)</sup>	DESCRIPTION
	SOT-23	SC70		
IN+	3	1	I	Noninverting input
IN-	4	3	I	Inverting input
OUT	1	4	O	Output
V+	5	5	—	Positive (highest) power supply
V-	2	2	—	Negative (lowest) power supply

(1) I = input, O = output

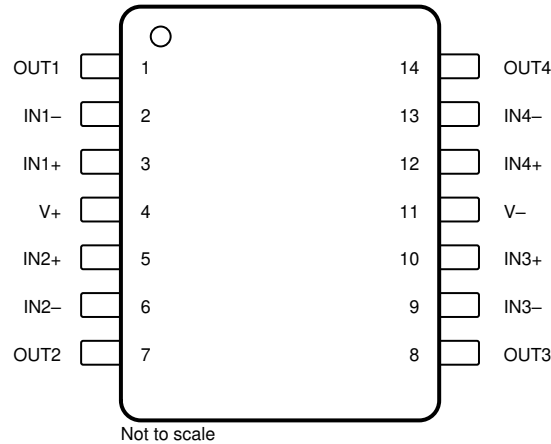

**Figure 4-3. OPA2992-Q1 D, PW, and DGK Package,  
 8-Pin SOIC, TSSOP, and VSSOP  
 (Top View)**

**Table 4-2. Pin Functions: OPA2992-Q1**

PIN		TYPE <sup>(1)</sup>	DESCRIPTION
NAME	NO.		
IN1+	3	I	Noninverting input, channel 1
IN1-	2	I	Inverting input, channel 1
IN2+	5	I	Noninverting input, channel 2
IN2-	6	I	Inverting input, channel 2
OUT1	1	O	Output, channel 1
OUT2	7	O	Output, channel 2
V+	8	—	Positive (highest) power supply
V-	4	—	Negative (lowest) power supply

(1) I = input, O = output



**Figure 4-4. OPA4992-Q1 D and PW Package,  
14-Pin SOIC and TSSOP  
(Top View)**

**Table 4-3. Pin Functions: OPA4992-Q1**

PIN		TYPE <sup>(1)</sup>	DESCRIPTION
NAME	NO.		
IN1+	3	I	Noninverting input, channel 1
IN1-	2	I	Inverting input, channel 1
IN2+	5	I	Noninverting input, channel 2
IN2-	6	I	Inverting input, channel 2
IN3+	10	I	Noninverting input, channel 3
IN3-	9	I	Inverting input, channel 3
IN4+	12	I	Noninverting input, channel 4
IN4-	13	I	Inverting input, channel 4
OUT1	1	O	Output, channel 1
OUT2	7	O	Output, channel 2
OUT3	8	O	Output, channel 3
OUT4	14	O	Output, channel 4
V+	4	—	Positive (highest) power supply
V-	11	—	Negative (lowest) power supply

(1) I = input, O = output

## 5 Specifications

### 5.1 Absolute Maximum Ratings

over operating ambient temperature range (unless otherwise noted)<sup>(1)</sup>

		MIN	MAX	UNIT
Supply voltage, $V_S = (V+) - (V-)$		0	42	V
Signal input pins	Common-mode voltage <sup>(3)</sup>	$(V-) - 0.5$	$(V+) + 0.5$	V
	Differential voltage <sup>(3)</sup>		$V_S + 0.2$	V
	Current <sup>(3)</sup>	-10	10	mA
Output short-circuit <sup>(2)</sup>		Continuous		
Operating ambient temperature, $T_A$		-55	150	°C
Junction temperature, $T_J$			150	°C
Storage temperature, $T_{stg}$		-65	150	°C

- (1) Operating the device beyond the ratings listed under *Absolute Maximum Ratings* will cause permanent damage to the device. These are stress ratings only, based on process and design limitations, and this device has not been designed to function outside the conditions indicated under *Recommended Operating Conditions*. Exposure to any condition outside *Recommended Operating Conditions* for extended periods, including absolute-maximum-rated conditions, may affect device reliability and performance.
- (2) Short-circuit to ground, one amplifier per package. Extended short-circuit current, especially with higher supply voltage, can cause excessive heating and eventual destruction.
- (3) Input pins are diode-clamped to the power-supply rails. Input signals that may swing more than 0.5V beyond the supply rails must be current limited to 10mA or less.

### 5.2 ESD Ratings

			VALUE	UNIT
OPA992-Q1				
$V_{(ESD)}$	Electrostatic discharge	Human body model (HBM), per AEC Q100-002 <sup>(1)</sup>	±2000	V
		Charged device model (CDM), per AEC Q100-011	±1500	
OPA2992-Q1 and OPA4992-Q1				
$V_{(ESD)}$	Electrostatic discharge	Human body model (HBM), per AEC Q100-002 <sup>(1)</sup>	±2500	V
		Charged device model (CDM), per AEC Q100-011	±1500	

- (1) AEC Q100-002 indicates HBM stressing is done in accordance with the ANSI/ESDA/JEDEC JS-001 specification.

### 5.3 Recommended Operating Conditions

over operating ambient temperature range (unless otherwise noted)

		MIN	MAX	UNIT
$V_S$	Supply voltage, $(V+) - (V-)$	2.7	40	V
$V_I$	Common mode voltage range	$(V-)$	$(V+)$	V
$T_A$	Specified temperature	-40	125	°C

## 5.4 Thermal Information for Single Channel

THERMAL METRIC <sup>(1)</sup>		OPA992-Q1		UNIT
		DBV (SOT-23)	DCK (SC70)	
		5 PINS	5 PINS	
R <sub>θJA</sub>	Junction-to-ambient thermal resistance	189.3	202.4	°C/W
R <sub>θJC(top)</sub>	Junction-to-case (top) thermal resistance	86.8	111.6	°C/W
R <sub>θJB</sub>	Junction-to-board thermal resistance	55.9	51.6	°C/W
ψ <sub>JT</sub>	Junction-to-top characterization parameter	23.6	25.8	°C/W
ψ <sub>JB</sub>	Junction-to-board characterization parameter	55.5	51.4	°C/W
R <sub>θJC(bot)</sub>	Junction-to-case (bottom) thermal resistance	N/A	N/A	°C/W

- (1) For more information about traditional and new thermal metrics, see the [Semiconductor and IC Package Thermal Metrics](#) application note.

## 5.5 Thermal Information for Dual Channel

THERMAL METRIC <sup>(1)</sup>		OPA2992-Q1			Unit
		D (SOIC)	PW (TSSOP)	DGK (VSSOP)	
		8 PINS	8 PINS	8 PINS	
R <sub>θJA</sub>	Junction-to-ambient thermal resistance	130.8	159.1	173.9	°C/W
R <sub>θJC(top)</sub>	Junction-to-case (top) thermal resistance	74.0	67.9	65.7	°C/W
R <sub>θJB</sub>	Junction-to-board thermal resistance	74.3	98.1	95.6	°C/W
ψ <sub>JT</sub>	Junction-to-top characterization parameter	25.8	9.1	10.9	°C/W
ψ <sub>JB</sub>	Junction-to-board characterization parameter	73.5	96.7	94.1	°C/W
R <sub>θJC(bot)</sub>	Junction-to-case (bottom) thermal resistance	N/A	N/A	N/A	°C/W

- (1) For more information about traditional and new thermal metrics, see the [Semiconductor and IC Package Thermal Metrics](#) application note.

## 5.6 Thermal Information for Quad Channel

THERMAL METRIC <sup>(1)</sup>		OPA4992-Q1		UNIT
		D (SOIC)	PW (TSSOP)	
		14 PINS	14 PINS	
R <sub>θJA</sub>	Junction-to-ambient thermal resistance	94.9	120.0	°C/W
R <sub>θJC(top)</sub>	Junction-to-case (top) thermal resistance	51.1	50.4	°C/W
R <sub>θJB</sub>	Junction-to-board thermal resistance	51.4	63.1	°C/W
ψ <sub>JT</sub>	Junction-to-top characterization parameter	15.3	8.1	°C/W
ψ <sub>JB</sub>	Junction-to-board characterization parameter	51.0	62.5	°C/W
R <sub>θJC(bot)</sub>	Junction-to-case (bottom) thermal resistance	N/A	N/A	°C/W

- (1) For more information about traditional and new thermal metrics, see the [Semiconductor and IC Package Thermal Metrics](#) application note.

## 5.7 Electrical Characteristics

For  $V_S = (V+) - (V-) = 2.7V$  to  $40V$  ( $\pm 1.35V$  to  $\pm 20V$ ) at  $T_A = 25^\circ C$ ,  $R_L = 10k\Omega$  connected to  $V_S / 2$ ,  $V_{CM} = V_S / 2$ , and  $V_{OUT} = V_S / 2$ , unless otherwise noted.

PARAMETER		TEST CONDITIONS		MIN	TYP	MAX	UNIT	
<b>OFFSET VOLTAGE</b>								
$V_{OS}$	Input offset voltage	$V_{CM} = V-$			$\pm 0.21$	$\pm 1.03$	mV	
			$T_A = -40^\circ C$ to $125^\circ C$			$\pm 1.2$		
$dV_{OS}/dT$	Input offset voltage drift	$V_{CM} = V-$	$T_A = -40^\circ C$ to $125^\circ C$		$\pm 0.25$		$\mu V/^\circ C$	
PSRR	Input offset voltage versus power supply	OPA992-Q1, OPA2992-Q1, $V_{CM} = V-$ , $V_S = 5V$ to $40V$	$T_A = -40^\circ C$ to $125^\circ C$		$\pm 0.2$	$\pm 1.3$	$\mu V/V$	
		OPA4992-Q1, $V_{CM} = V-$ , $V_S = 5V$ to $40V$			$\pm 0.4$	$\pm 1.8$		
		OPA992-Q1, OPA2992-Q1, OPA4992-Q1, $V_{CM} = V-$ , $V_S = 2.7V$ to $40V^{(1)}$			$\pm 0.8$	$\pm 7$		
	DC channel separation				0.4		$\mu V/V$	
<b>INPUT BIAS CURRENT</b>								
$I_B$	Input bias current				$\pm 10$		pA	
$I_{OS}$	Input offset current				$\pm 10$		pA	
<b>NOISE</b>								
$E_N$	Input voltage noise	$f = 0.1Hz$ to $10Hz$			2.77		$\mu V_{PP}$	
					0.49		$\mu V_{RMS}$	
$e_N$	Input voltage noise density	$f = 1kHz$			7		$nV/\sqrt{Hz}$	
		$f = 10kHz$			4.4			
$i_N$	Input current noise density	$f = 1kHz$			60		$fA/\sqrt{Hz}$	
<b>INPUT VOLTAGE RANGE</b>								
$V_{CM}$	Common-mode voltage range			(V-)		(V+)	V	
CMRR	Common-mode rejection ratio	$V_S = 40V$ , $V- < V_{CM} < (V+) - 2V$ (PMOS pair)	$T_A = -40^\circ C$ to $125^\circ C$		100	115	dB	
		$V_S = 5V$ , $V- < V_{CM} < (V+) - 2V$ (PMOS pair) <sup>(1)</sup>			75	98		
		$V_S = 2.7V$ , $V- < V_{CM} < (V+) - 2V$ (PMOS pair)				90		
		$V_S = 2.7 - 40V$ , $(V+) - 1V < V_{CM} < V+$ (NMOS pair)				79		
		$(V+) - 2V < V_{CM} < (V+) - 1V$			See <a href="#">Offset Voltage vs CommonMode Voltage (Transition Region)</a>			
<b>INPUT IMPEDANCE</b>								
$Z_{ID}$	Differential				$100 \parallel 9$		$M\Omega \parallel pF$	
$Z_{ICM}$	Common-mode				$6 \parallel 1$		$T\Omega \parallel pF$	
<b>OPEN-LOOP GAIN</b>								
$A_{OL}$	Open-loop voltage gain	$V_S = 40V$ , $V_{CM} = V_S / 2$ , $(V-) + 0.1V < V_O < (V+) - 0.1V$	$T_A = -40^\circ C$ to $125^\circ C$		120	142	dB	
		$V_S = 40V$ , $V_{CM} = V_S / 2$ , $(V-) + 0.12V < V_O < (V+) - 0.12V$				142		
		$V_S = 5V$ , $V_{CM} = V_S / 2$ , $(V-) + 0.1V < V_O < (V+) - 0.1V^{(1)}$		$T_A = -40^\circ C$ to $125^\circ C$		104		125
		$V_S = 2.7V$ , $V_{CM} = V_S / 2$ , $(V-) + 0.1V < V_O < (V+) - 0.1V^{(1)}$		$T_A = -40^\circ C$ to $125^\circ C$		90		105
		$V_S = 2.7V$ , $V_{CM} = V_S / 2$ , $(V-) + 0.1V < V_O < (V+) - 0.1V^{(1)}$		$T_A = -40^\circ C$ to $125^\circ C$				105



For  $V_S = (V_+) - (V_-) = 2.7V$  to  $40V$  ( $\pm 1.35V$  to  $\pm 20V$ ) at  $T_A = 25^\circ C$ ,  $R_L = 10k\Omega$  connected to  $V_S / 2$ ,  $V_{CM} = V_S / 2$ , and  $V_{OUT} = V_S / 2$ , unless otherwise noted.

PARAMETER		TEST CONDITIONS	MIN	TYP	MAX	UNIT
<b>FREQUENCY RESPONSE</b>						
GBW	Gain-bandwidth product			10.6		MHz
SR	Slew rate	$V_S = 40V$ , $G = +1$ , $V_{STEP} = 10V$ , $C_L = 20pF^{(3)}$		32		V/ $\mu s$
$t_s$	Settling time	To 0.1%, $V_S = 40V$ , $V_{STEP} = 10V$ , $G = +1$ , $C_L = 20pF$		0.65		$\mu s$
		To 0.1%, $V_S = 40V$ , $V_{STEP} = 2V$ , $G = +1$ , $C_L = 20pF$		0.3		
		To 0.01%, $V_S = 40V$ , $V_{STEP} = 10V$ , $G = +1$ , $C_L = 20pF$		0.86		
		To 0.01%, $V_S = 40V$ , $V_{STEP} = 2V$ , $G = +1$ , $C_L = 20pF$		0.44		
	Phase margin	$G = +1$ , $R_L = 10k\Omega$ , $C_L = 20pF$		64		$^\circ$
	Overload recovery time	$V_{IN} \times \text{gain} > V_S$		170		ns
THD+N	Total harmonic distortion + noise	$V_S = 40V$ , $V_O = 3V_{RMS}$ , $G = 1$ , $f = 1kHz$ , $R_L = 10k\Omega$		0.00005%		dB
		$V_S = 10V$ , $V_O = 3V_{RMS}$ , $G = 1$ , $f = 1kHz$ , $R_L = 128\Omega$		0.0032%		
		$V_S = 10V$ , $V_O = 0.4V_{RMS}$ , $G = 1$ , $f = 1kHz$ , $R_L = 32\Omega$		0.00032%		dB
				110		
<b>OUTPUT</b>						
	Voltage output swing from rail	Positive and negative rail headroom	$V_S = 40V$ , $R_L = \text{no load}$	7		mV
			$V_S = 40V$ , $R_L = 10k\Omega$	48	60	
			$V_S = 40V$ , $R_L = 2k\Omega$	220	300	
			$V_S = 2.7V$ , $R_L = \text{no load}$	0.5		
			$V_S = 2.7V$ , $R_L = 10k\Omega$	5	20	
			$V_S = 2.7V$ , $R_L = 2k\Omega$	20	50	
$I_{SC}$	Short-circuit current			$\pm 65^{(2)}$		mA
$C_{LOAD}$	Capacitive load drive			See <a href="#">Phase Margin vs Capacitive Load</a>		pF
$Z_O$	Open-loop output impedance	$I_O = 0A$		See <a href="#">Open-Loop Output Impedance vs Frequency</a>		$\Omega$
<b>POWER SUPPLY</b>						
$I_Q$	Quiescent current per amplifier	OPA2992-Q1, OPA4992-Q1, $I_O = 0A$		2.4	2.8	mA
			$T_A = -40^\circ C$ to $125^\circ C$		2.84	
		OPA992, $I_O = 0A$		2.48	2.92	
			$T_A = -40^\circ C$ to $125^\circ C$		2.98	

- (1) Specified by characterization only.
- (2) At high supply voltage, placing the OPAx992 in a sudden short to mid-supply or ground will lead to rapid thermal shutdown. Output current greater than  $I_{SC}$  can be achieved if rapid thermal shutdown is avoided as per [Output Voltage Swing vs Output Current](#).
- (3) See [Slew Rate vs Input Step Voltage](#) for more information.

## 5.8 Typical Characteristics

at  $T_A = 25^\circ\text{C}$ ,  $V_S = \pm 20\text{V}$ ,  $V_{CM} = V_S / 2$ ,  $R_{LOAD} = 10\text{k}\Omega$  (unless otherwise noted)

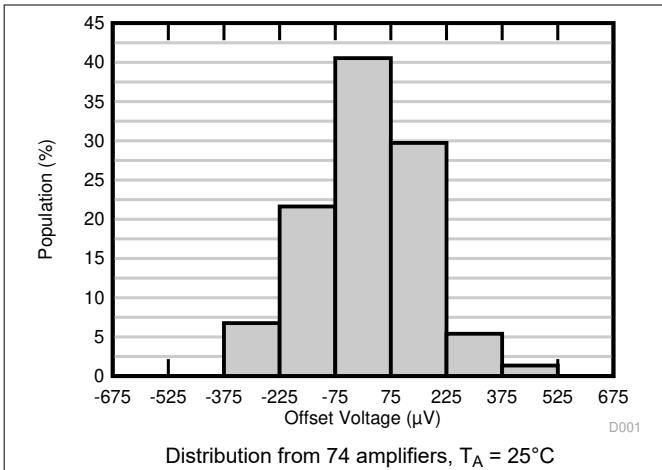

**Figure 5-1. Offset Voltage Production Distribution**

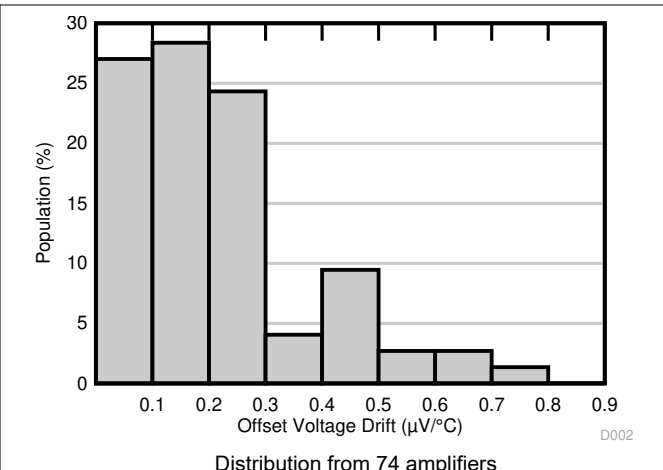

**Figure 5-2. Offset Voltage Drift Distribution**

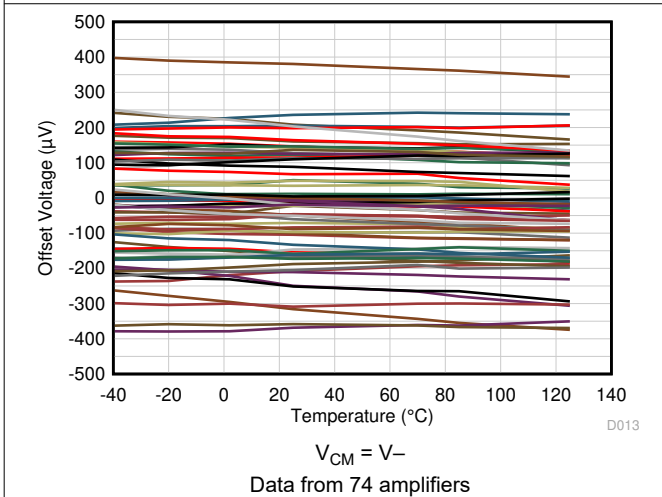

**Figure 5-3. Offset Voltage vs Temperature**

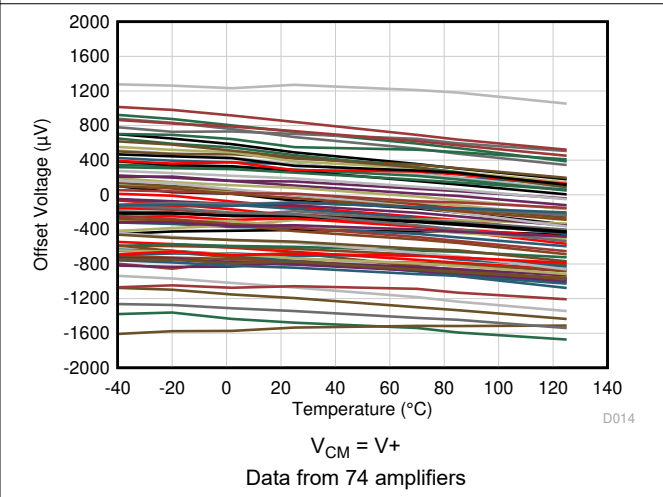

**Figure 5-4. Offset Voltage vs Temperature**

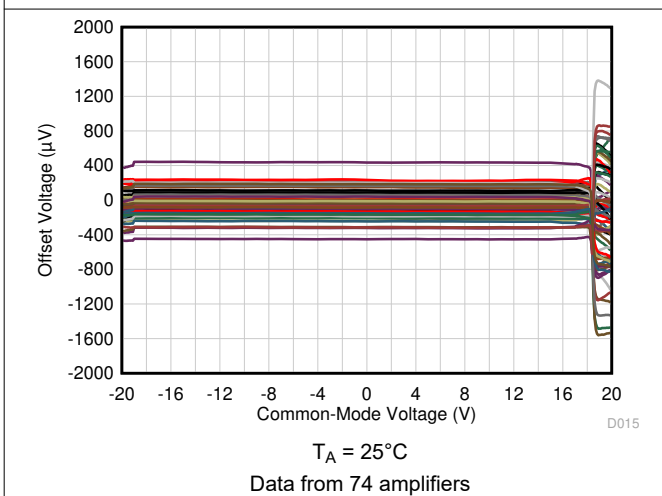

**Figure 5-5. Offset Voltage vs Common-Mode Voltage**

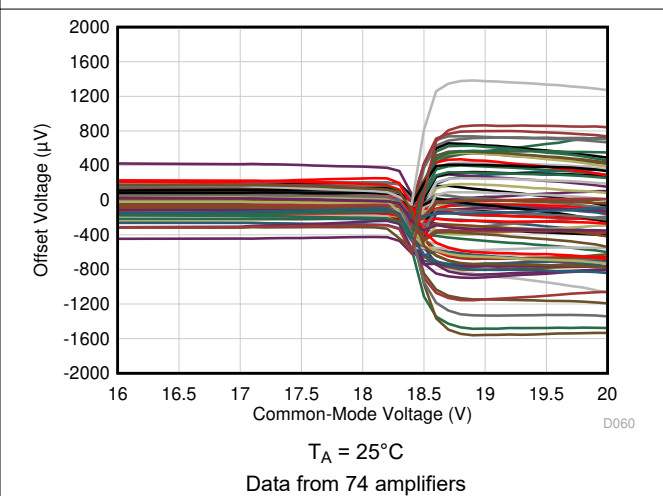

**Figure 5-6. Offset Voltage vs Common-Mode Voltage (Transition Region)**

### 5.8 Typical Characteristics (continued)

at  $T_A = 25^\circ\text{C}$ ,  $V_S = \pm 20\text{V}$ ,  $V_{CM} = V_S / 2$ ,  $R_{LOAD} = 10\text{k}\Omega$  (unless otherwise noted)

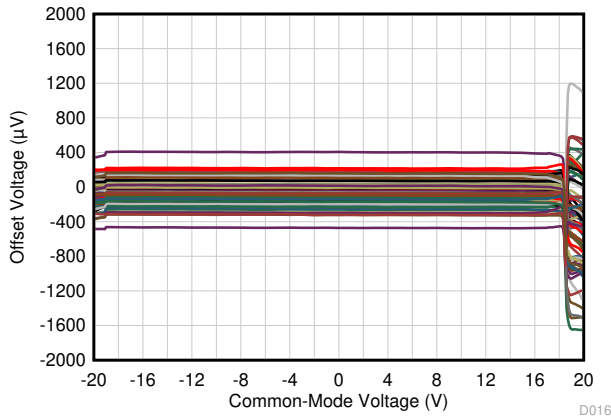

$T_A = 125^\circ\text{C}$   
Data from 74 amplifiers

**Figure 5-7. Offset Voltage vs Common-Mode Voltage**

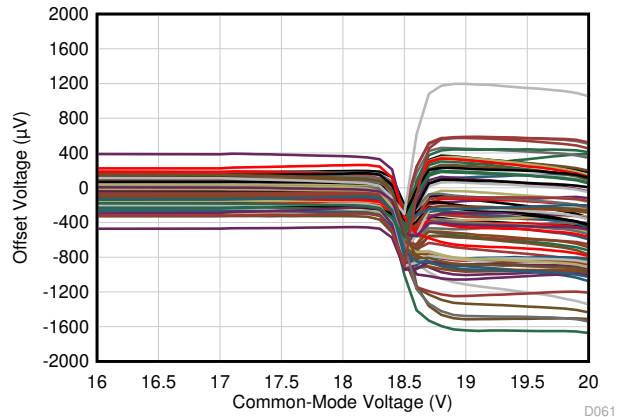

$T_A = 125^\circ\text{C}$   
Data from 74 amplifiers

**Figure 5-8. Offset Voltage vs Common-Mode Voltage (Transition Region)**

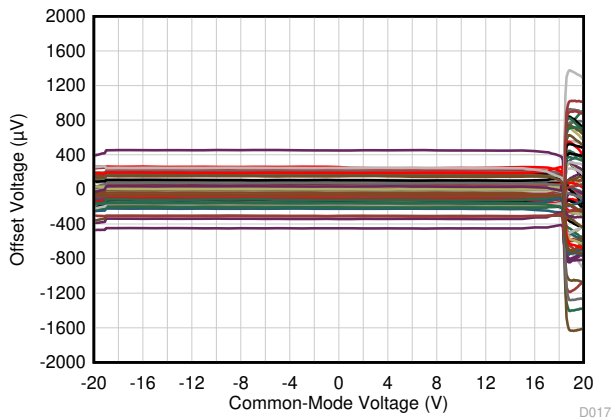

$T_A = -40^\circ\text{C}$   
Data from 74 amplifiers

**Figure 5-9. Offset Voltage vs Common-Mode Voltage**

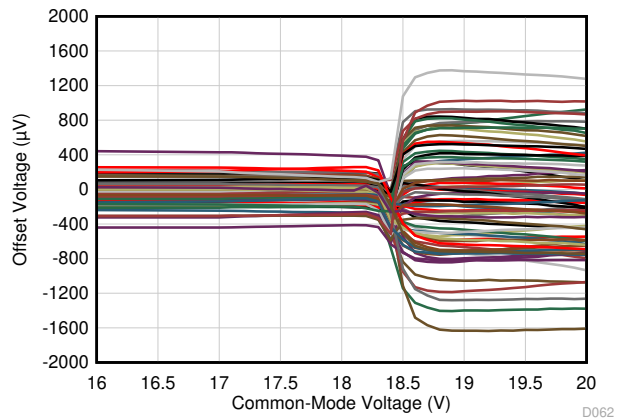

$T_A = -40^\circ\text{C}$   
Data from 74 amplifiers

**Figure 5-10. Offset Voltage vs Common-Mode Voltage (Transition Region)**

## 5.8 Typical Characteristics (continued)

at  $T_A = 25^\circ\text{C}$ ,  $V_S = \pm 20\text{V}$ ,  $V_{CM} = V_S / 2$ ,  $R_{LOAD} = 10\text{k}\Omega$  (unless otherwise noted)

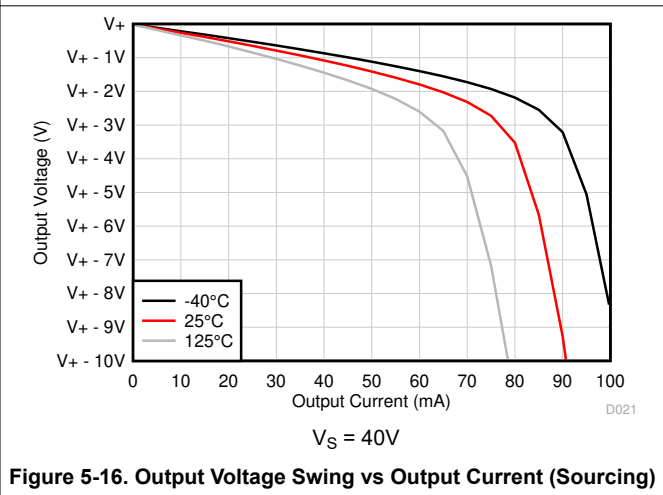
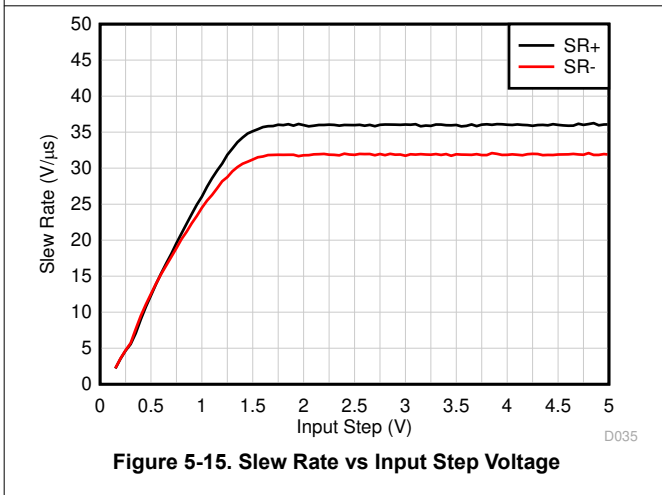
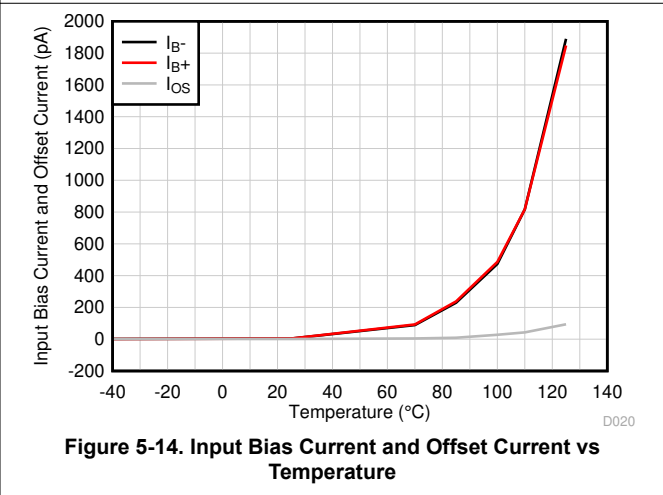
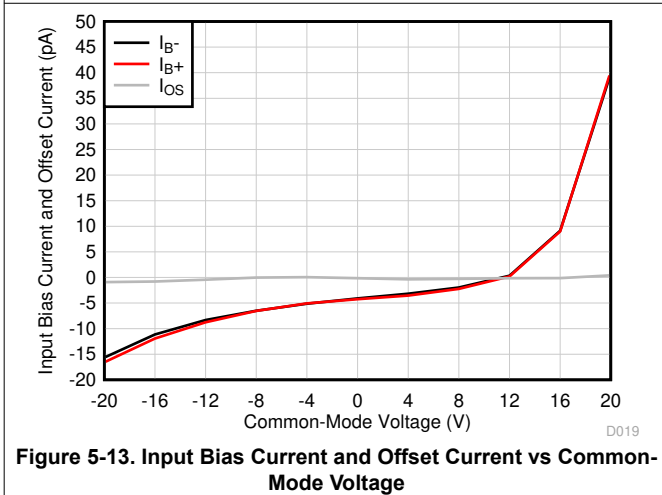
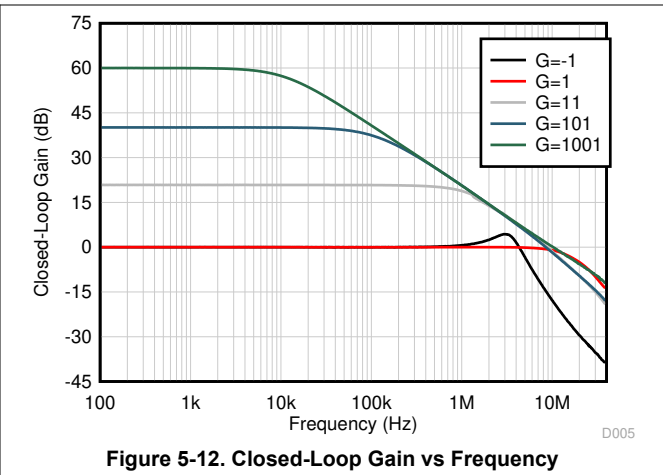
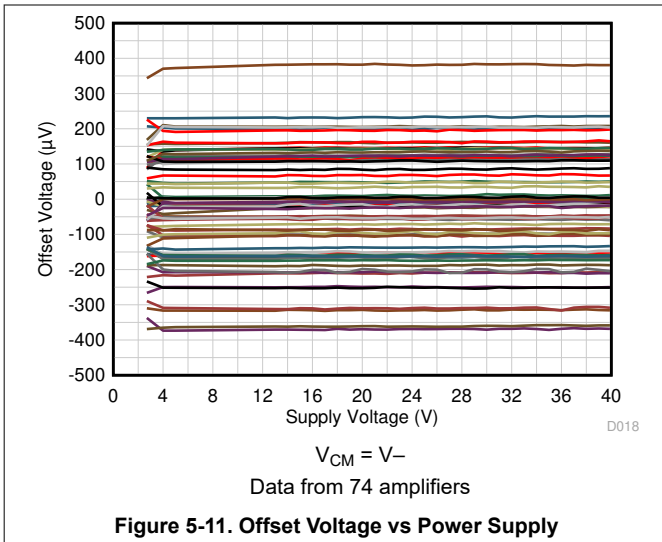

### 5.8 Typical Characteristics (continued)

at  $T_A = 25^\circ\text{C}$ ,  $V_S = \pm 20\text{V}$ ,  $V_{CM} = V_S / 2$ ,  $R_{LOAD} = 10\text{k}\Omega$  (unless otherwise noted)

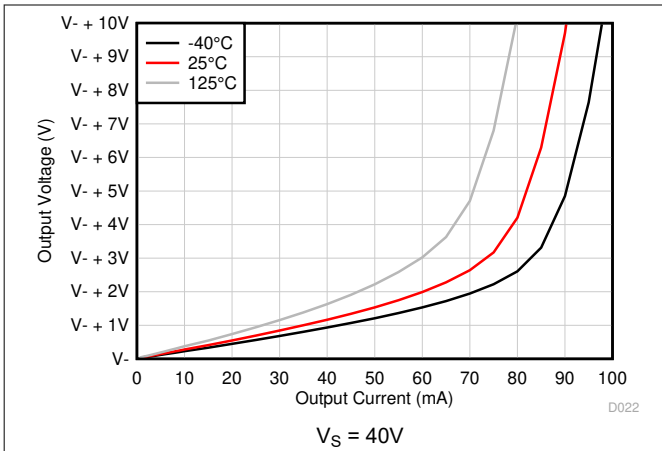

**Figure 5-17. Output Voltage Swing vs Output Current (Sinking)**

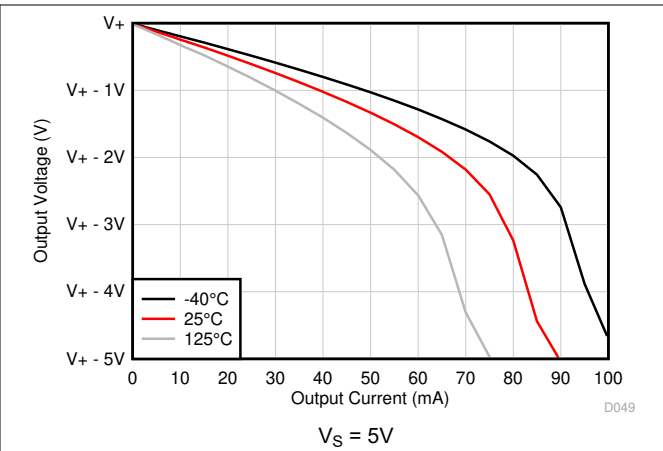

**Figure 5-18. Output Voltage Swing vs Output Current (Sourcing)**

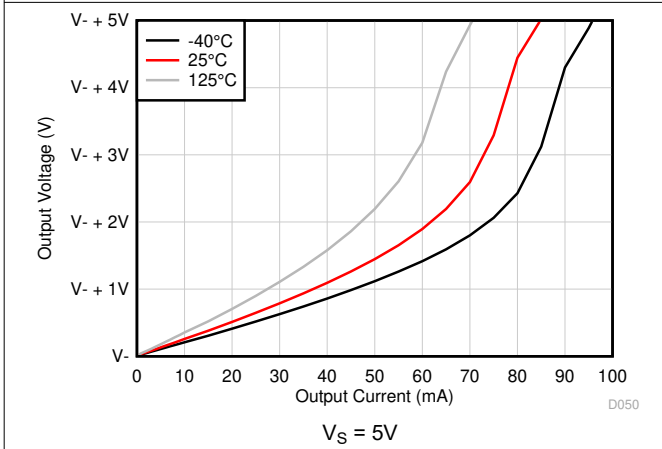

**Figure 5-19. Output Voltage Swing vs Output Current (Sinking)**

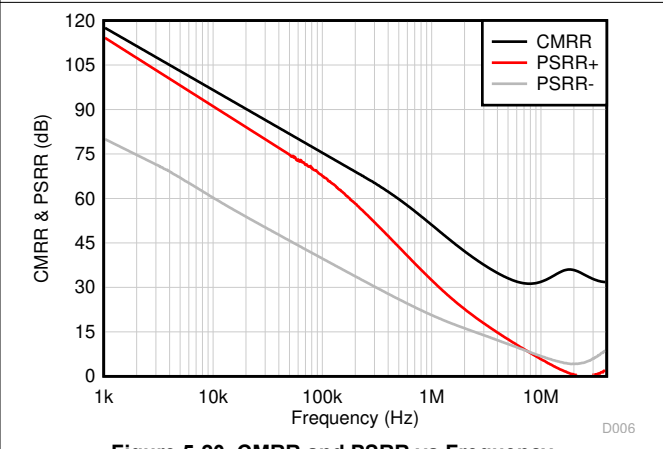

**Figure 5-20. CMRR and PSRR vs Frequency**

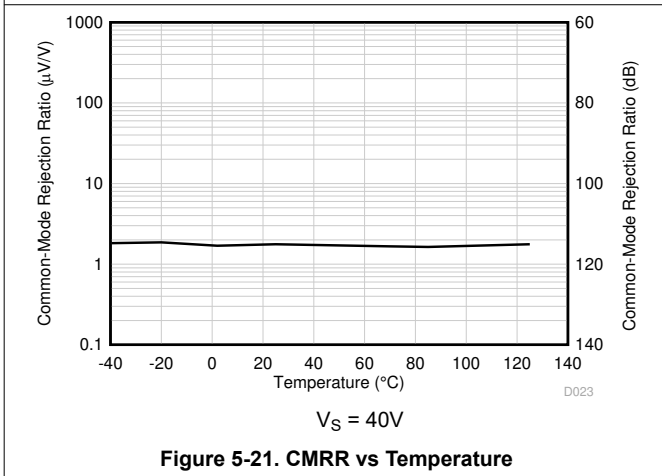

**Figure 5-21. CMRR vs Temperature**

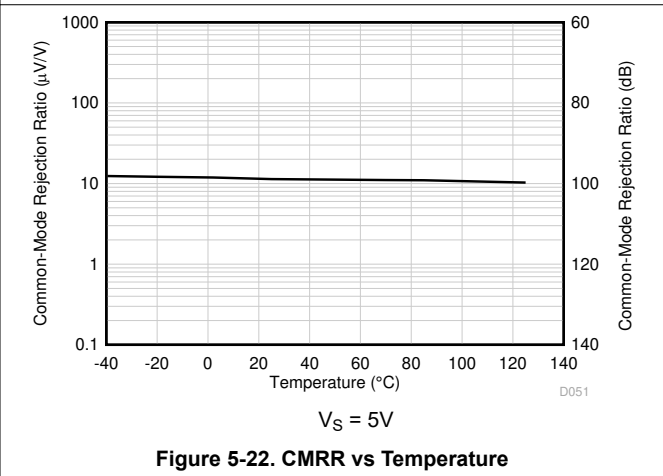

**Figure 5-22. CMRR vs Temperature**

## 5.8 Typical Characteristics (continued)

at  $T_A = 25^\circ\text{C}$ ,  $V_S = \pm 20\text{V}$ ,  $V_{CM} = V_S / 2$ ,  $R_{LOAD} = 10\text{k}\Omega$  (unless otherwise noted)

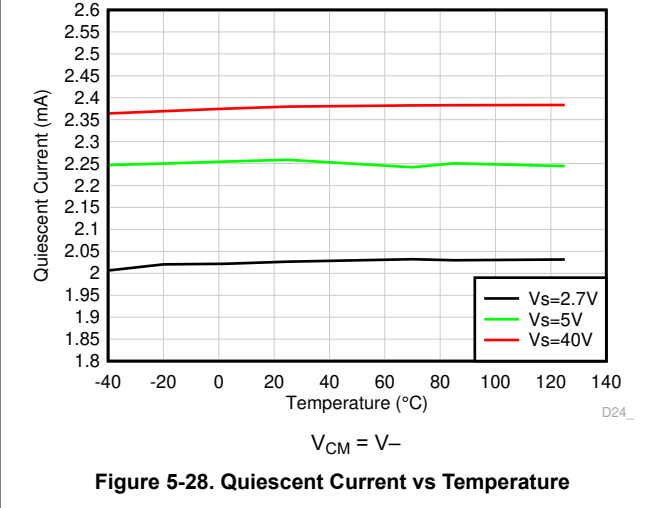
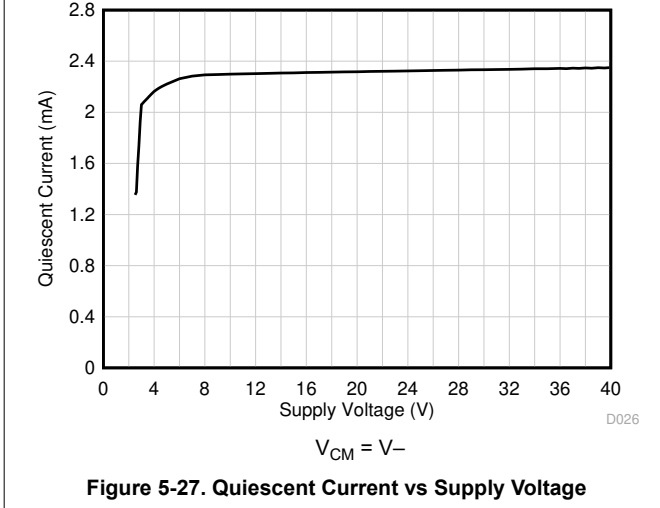
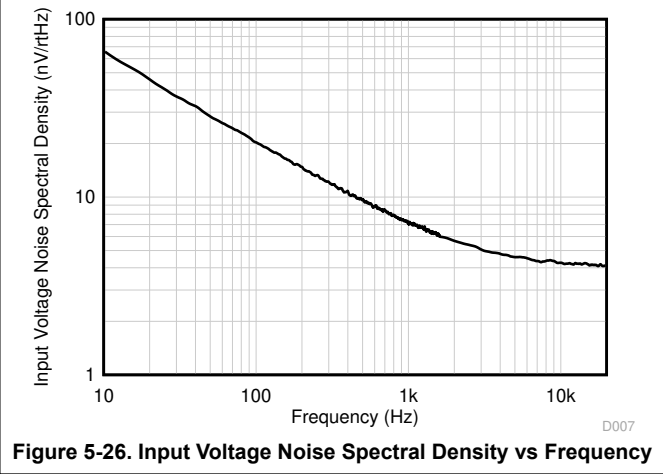
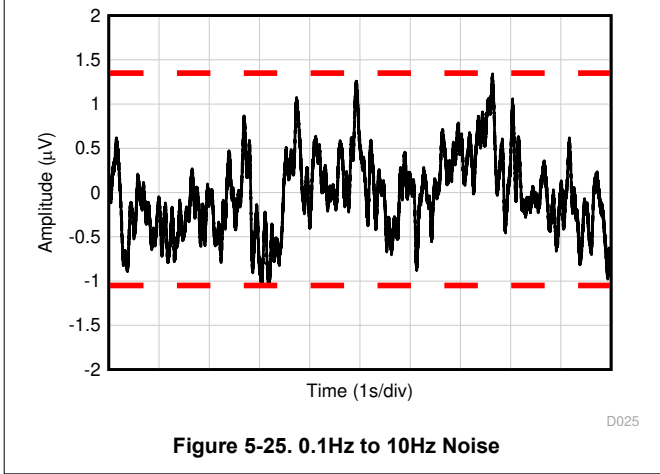
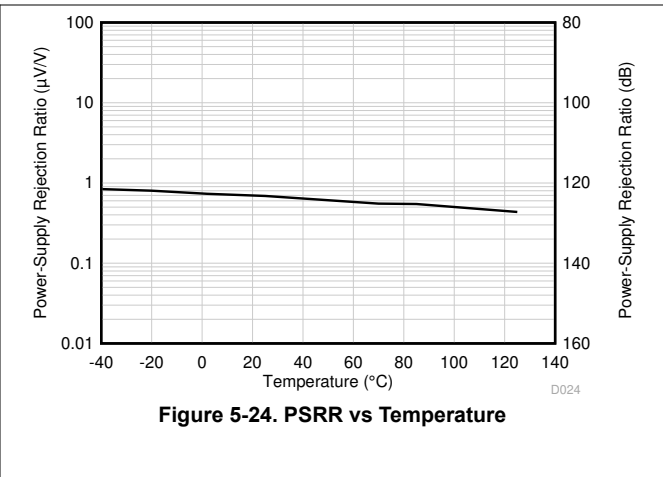
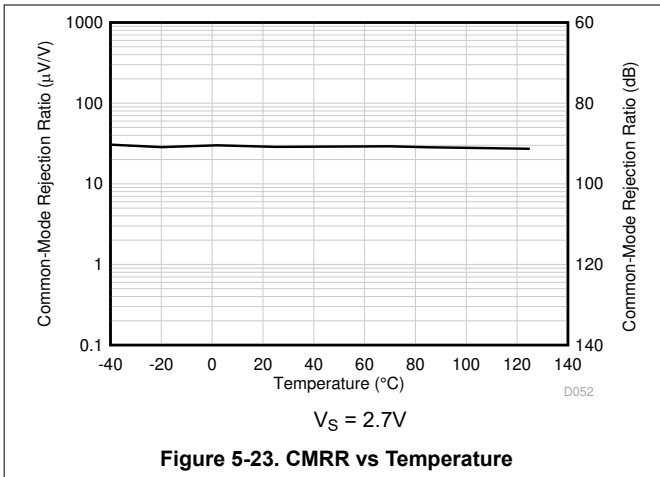

### 5.8 Typical Characteristics (continued)

at  $T_A = 25^\circ\text{C}$ ,  $V_S = \pm 20\text{V}$ ,  $V_{CM} = V_S / 2$ ,  $R_{LOAD} = 10\text{k}\Omega$  (unless otherwise noted)

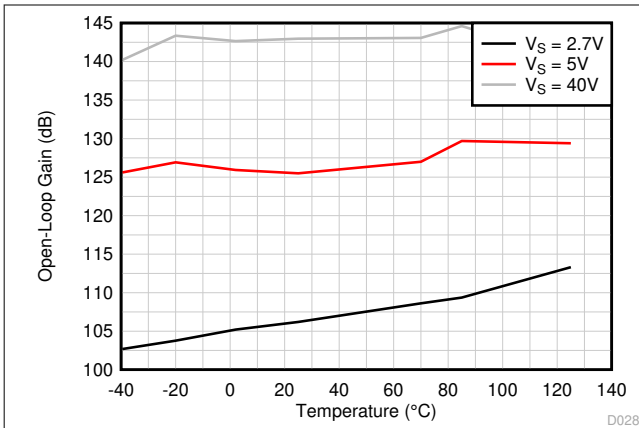

Figure 5-29. Open-Loop Voltage Gain vs Temperature (dB)

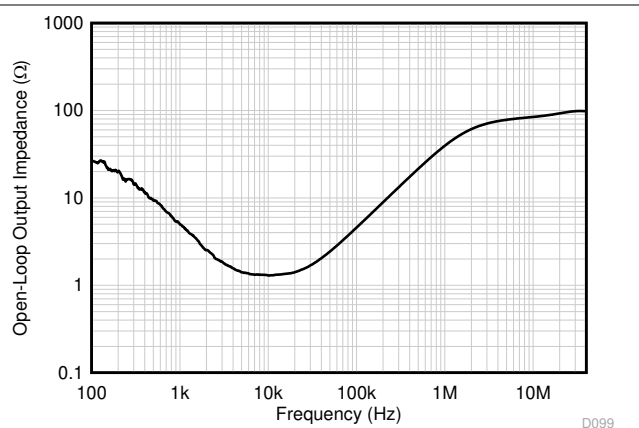

Figure 5-30. Open-Loop Output Impedance vs Frequency

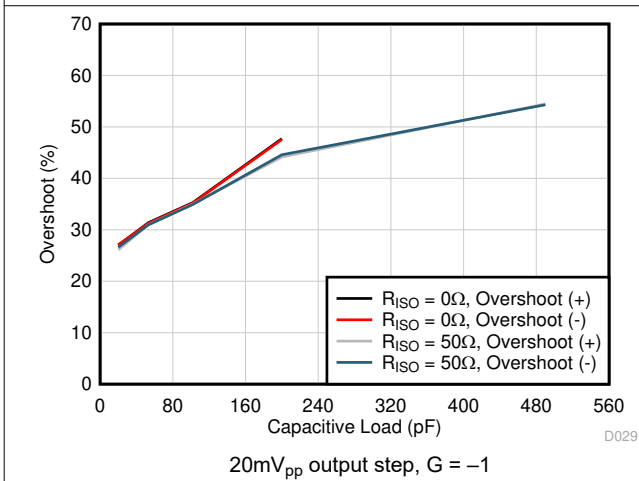

Figure 5-31. Small-Signal Overshoot vs Capacitive Load

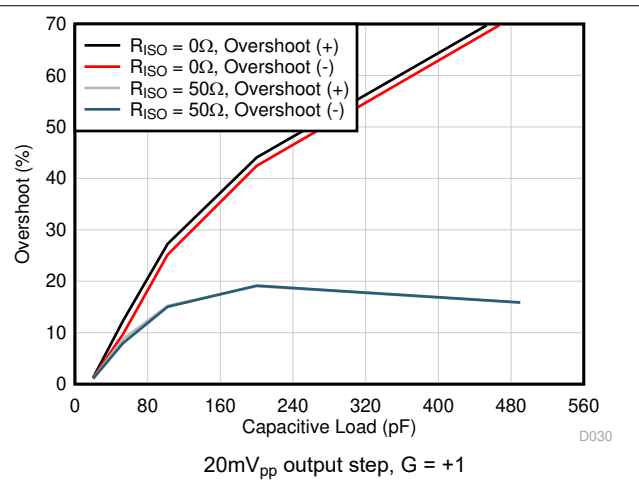

Figure 5-32. Small-Signal Overshoot vs Capacitive Load

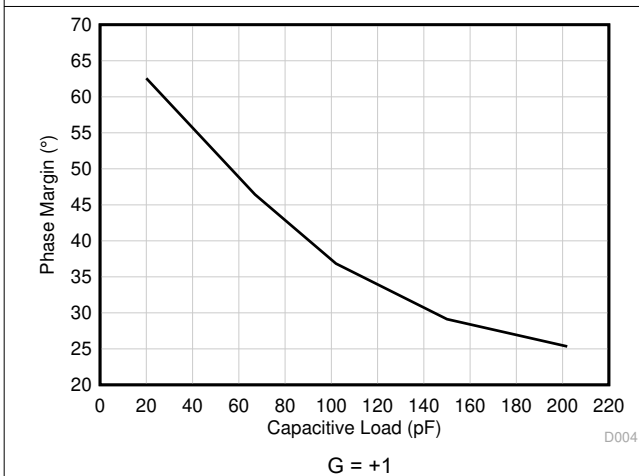

Figure 5-33. Phase Margin vs Capacitive Load

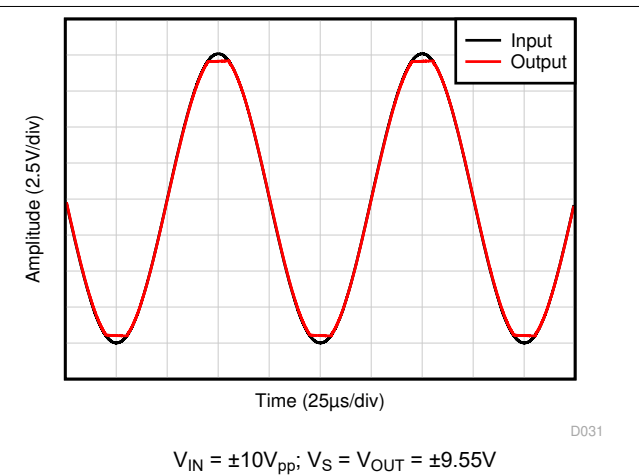
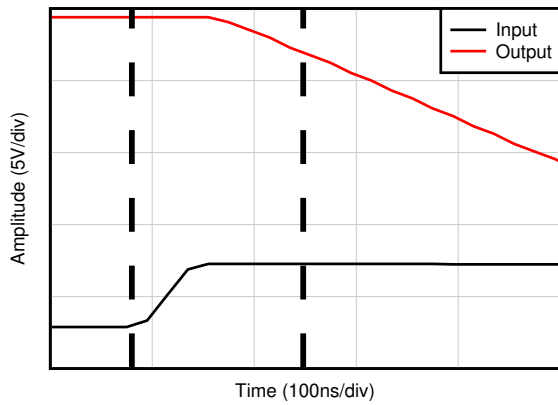

Figure 5-34. No Phase Reversal  
 $V_{IN} = \pm 10\text{V}_{pp}$ ;  $V_S = V_{OUT} = \pm 9.55\text{V}$

## 5.8 Typical Characteristics (continued)

at  $T_A = 25^\circ\text{C}$ ,  $V_S = \pm 20\text{V}$ ,  $V_{CM} = V_S / 2$ ,  $R_{LOAD} = 10\text{k}\Omega$  (unless otherwise noted)



$G = -10$

D032

**Figure 5-35. Positive Overload Recovery**

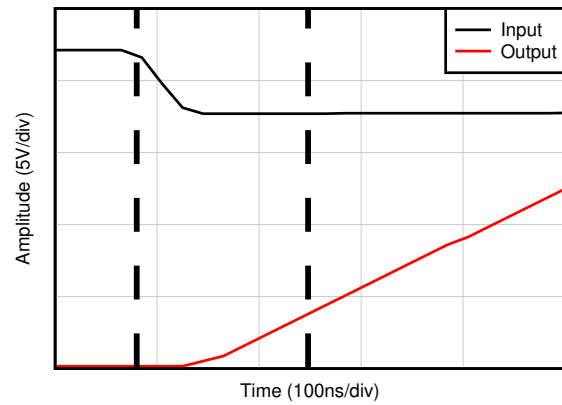

$G = -10$

D053

**Figure 5-36. Negative Overload Recovery**

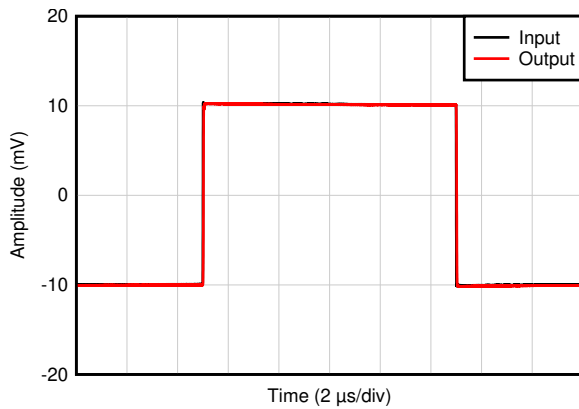

$C_L = 20\text{pF}$ ,  $G = 1$ ,  $20\text{mV}_{pp}$  step response

D033

**Figure 5-37. Small-Signal Step Response**

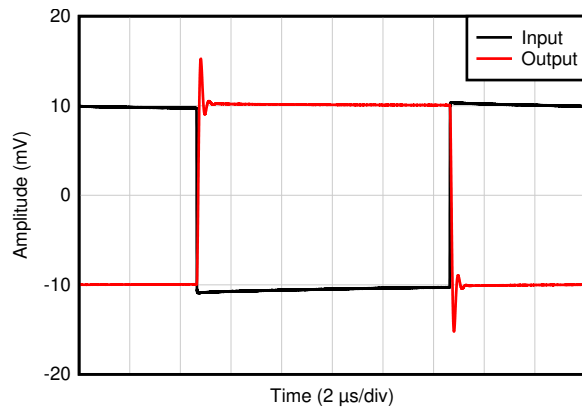

$C_L = 20\text{pF}$ ,  $G = -1$ ,  $20\text{mV}_{pp}$  step response

D054

**Figure 5-38. Small-Signal Step Response**

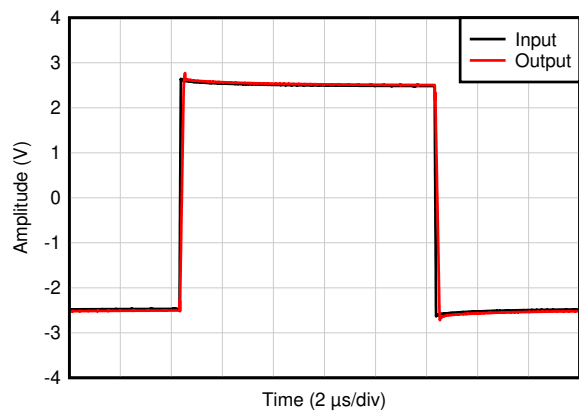

$C_L = 20\text{pF}$ ,  $G = 1$ ,  $5\text{V}_{pp}$  step response

D034

**Figure 5-39. Large-Signal Step Response**

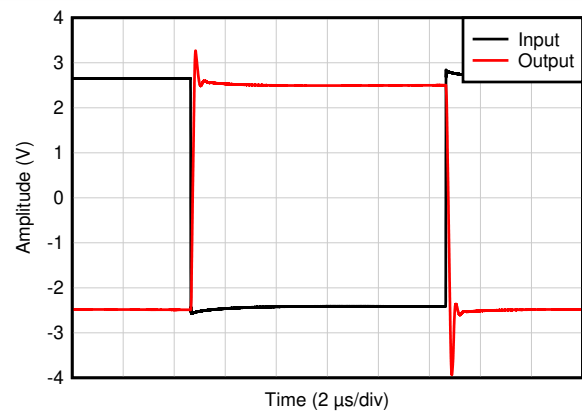

$C_L = 20\text{pF}$ ,  $G = -1$ ,  $5\text{V}_{pp}$  step response

D055

**Figure 5-40. Large-Signal Step Response**



### 5.8 Typical Characteristics (continued)

at  $T_A = 25^\circ\text{C}$ ,  $V_S = \pm 20\text{V}$ ,  $V_{CM} = V_S / 2$ ,  $R_{LOAD} = 10\text{k}\Omega$  (unless otherwise noted)

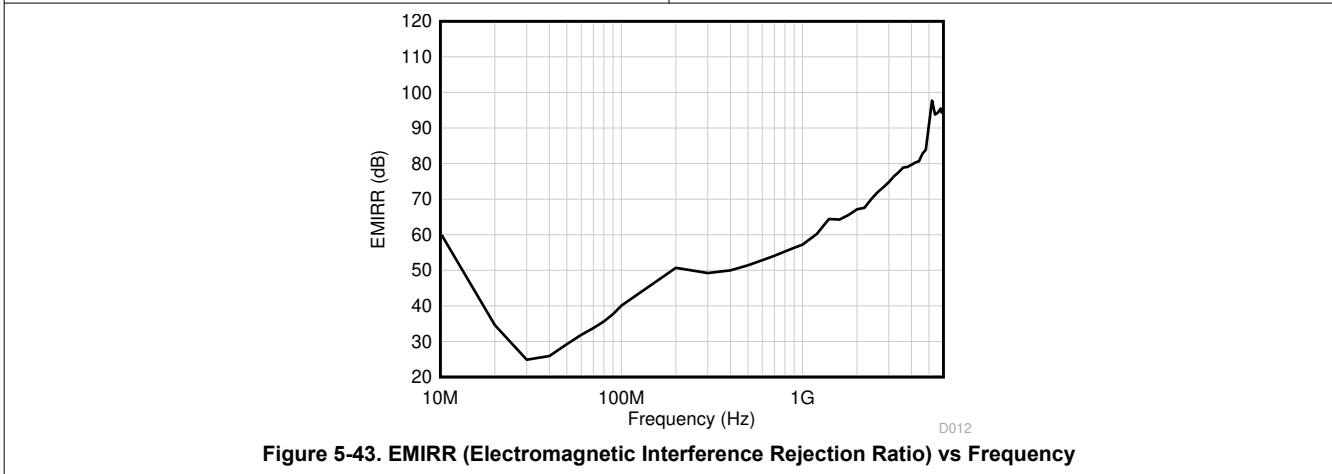
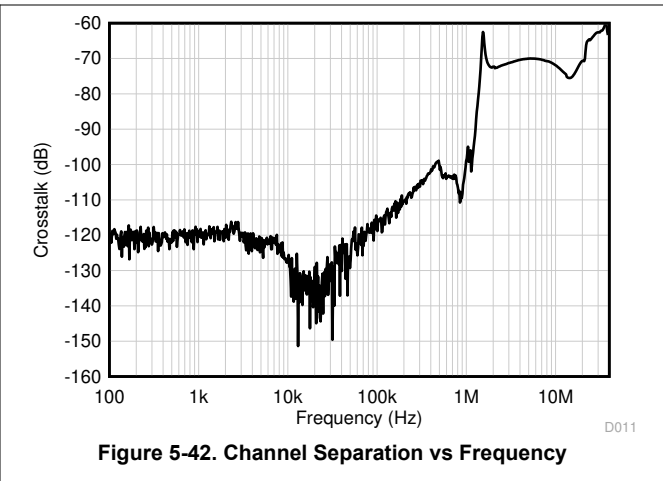
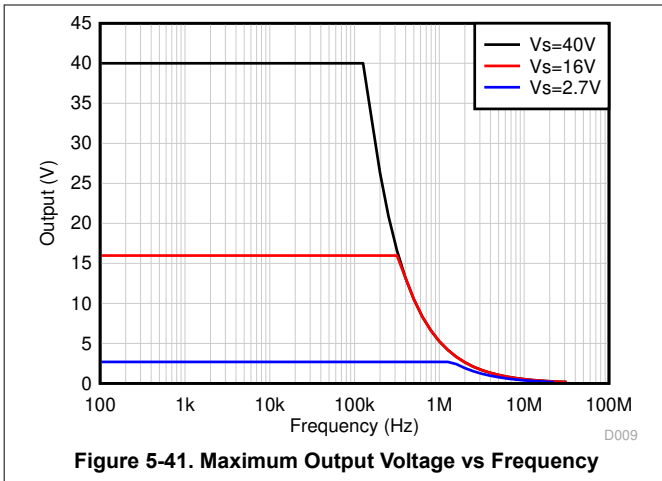

## 6 Detailed Description

### 6.1 Overview

The OPAx992-Q1 family (OPA992-Q1, OPA2992-Q1, and OPA4992-Q1) is a family of high voltage (40V) general purpose operational amplifiers.

These devices offer excellent DC precision and AC performance, including rail-to-rail input or output, low offset ( $\pm 210\mu\text{V}$ , typical), and low offset drift ( $\pm 0.25\mu\text{V}/^\circ\text{C}$ , typical).

Special features such as differential and common-mode input voltage range to the supply rail, high short-circuit current ( $\pm 65\text{mA}$ ), and high slew rate ( $32\text{V}/\mu\text{s}$ ) make the OPAx992-Q1 an extremely flexible, robust, and high-performance operational amplifier for high-voltage automotive applications.

### 6.2 Functional Block Diagram

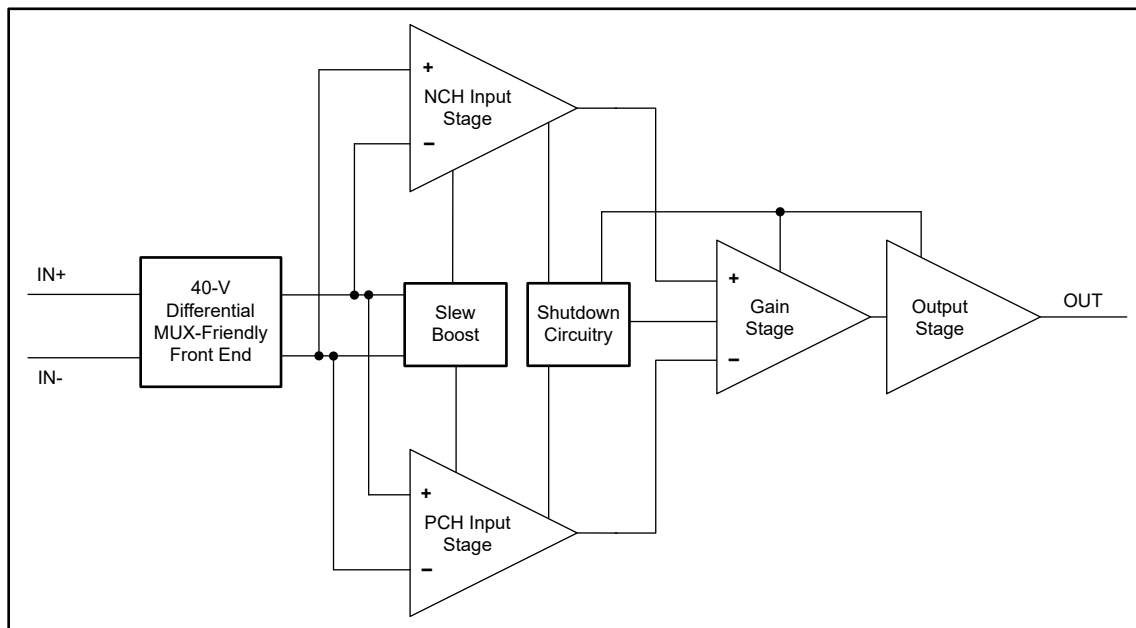

## 6.3 Feature Description

### 6.3.1 Input Protection Circuitry

The OPAx992-Q1 uses a special input architecture to eliminate the requirement for input protection diodes but still provides robust input protection under transient conditions. Figure 6-1 shows conventional input diode protection schemes that are activated by fast transient step responses and introduce signal distortion and settling time delays because of alternate current paths, as shown in Figure 6-2. For low-gain circuits, these fast-ramping input signals forward-bias back-to-back diodes, causing an increase in input current and resulting in extended settling time.

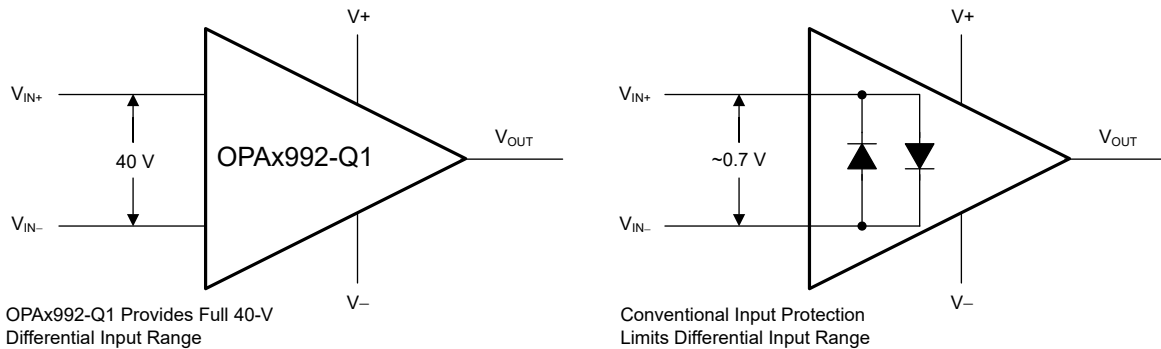

**Figure 6-1. OPAx992-Q1 Input Protection Does Not Limit Differential Input Capability**

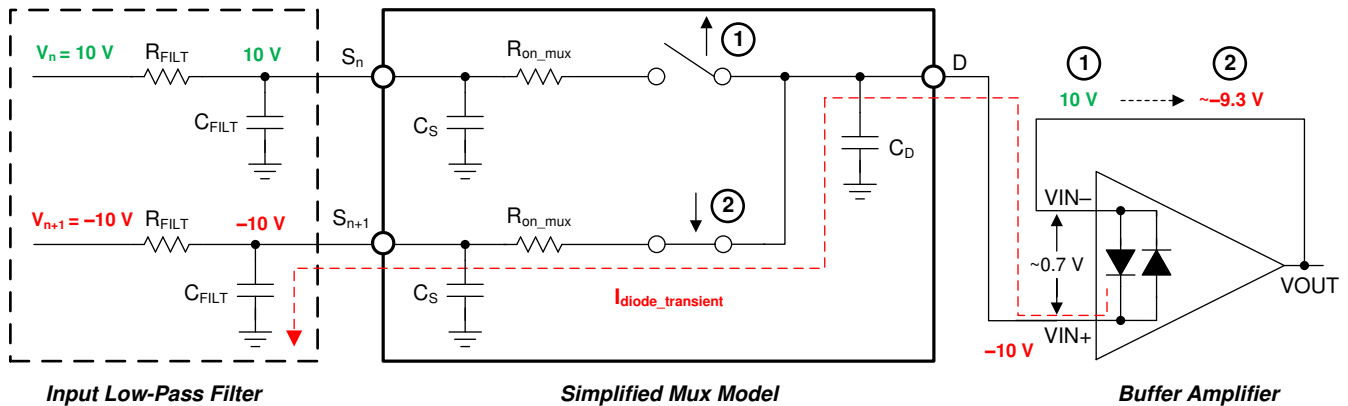

**Figure 6-2. Back-to-Back Diodes Create Settling Issues**

The OPAx992-Q1 family of operational amplifiers provides a true high-impedance differential input capability for high-voltage applications using a patented input protection architecture that does not introduce additional signal distortion or delayed settling time, making the device an excellent op amp for multichannel, high-switched, input applications. The OPAx992-Q1 tolerates a maximum differential swing (voltage between inverting and non-inverting pins of the op amp) of up to 40V, making the device designed for use as a comparator or in applications with fast-ramping input signals such as data-acquisition systems; see the TI TechNote [MUX-Friendly Precision Operational Amplifiers](#) for more information.

### 6.3.2 EMI Rejection

The OPAx992-Q1 uses integrated electromagnetic interference (EMI) filtering to reduce the effects of EMI from sources such as wireless communications and densely-populated boards with a mix of analog signal chain and digital components. EMI immunity can be improved with circuit design techniques; the OPAx992-Q1 benefits from these design improvements. Texas Instruments has developed the ability to accurately measure and quantify the immunity of an operational amplifier over a broad frequency spectrum extending from 10MHz to 6GHz. Figure 6-3 shows the results of this testing on the OPAx992-Q1. Table 6-1 provides the EMIRR IN+ values for the OPAx992-Q1 at particular frequencies commonly encountered in real-world applications. The [EMI Rejection Ratio of Operational Amplifiers](#) application report contains detailed information on the topic of EMIRR performance relating to op amps and is available for download from [www.ti.com](http://www.ti.com).

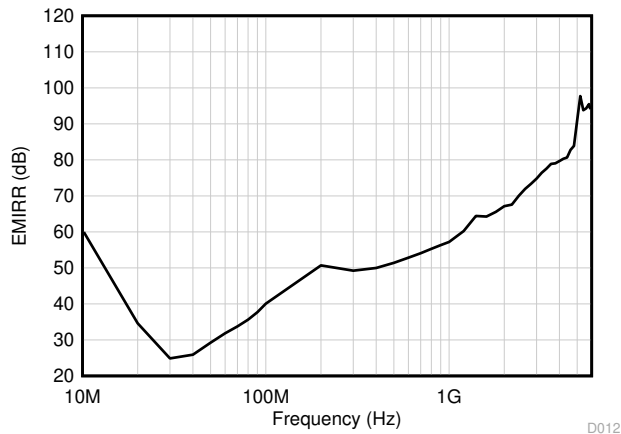

Figure 6-3. EMIRR Testing

Table 6-1. OPAx992-Q1 EMIRR IN+ For Frequencies of Interest

FREQUENCY	APPLICATION OR ALLOCATION	EMIRR IN+
400MHz	Mobile radio, mobile satellite, space operation, weather, radar, ultra-high frequency (UHF) applications	50.0dB
900MHz	Global system for mobile communications (GSM) applications, radio communication, navigation, GPS (to 1.6GHz), GSM, aeronautical mobile, UHF applications	56.3dB
1.8GHz	GSM applications, mobile personal communications, broadband, satellite, L-band (1GHz to 2GHz)	65.6dB
2.4GHz	802.11b, 802.11g, 802.11n, Bluetooth®, mobile personal communications, industrial, scientific and medical (ISM) radio band, amateur radio and satellite, S-band (2GHz to 4GHz)	70.0dB
3.6GHz	Radiolocation, aero communication and navigation, satellite, mobile, S-band	78.9dB
5GHz	802.11a, 802.11n, aero communication and navigation, mobile communication, space and satellite operation, C-band (4GHz to 8GHz)	91.0dB

### 6.3.3 Thermal Protection

The internal power dissipation of any amplifier causes the internal (junction) temperature to rise. This phenomenon is called *self heating*. The absolute maximum junction temperature of the OPAx992-Q1 is 150°C. Exceeding this temperature causes damage to the device. The OPAx992-Q1 has a thermal protection feature that reduces damage from self heating. The protection works by monitoring the temperature of the device and turning off the op amp output drive for temperatures above 170°C. Figure 6-4 shows an application example for the OPA2992-Q1 that has significant self heating because of the power dissipation (0.954W). In this example, both channels have a quiescent power dissipation while one of the channels has a significant load. Thermal calculations indicate that for an ambient temperature of 55°C, the device junction temperature reaches 180°C. The actual device, however, turns off the output drive to recover towards a safe junction temperature. Figure 6-4 shows how the circuit behaves during thermal protection. During normal operation, the device acts as a buffer so the output is 3V. When self heating causes the device junction temperature to increase above the internal limit, the thermal protection forces the output to a high-impedance state and the output is pulled to ground through resistor  $R_L$ . If the condition that caused excessive power dissipation is not removed, then the amplifier oscillates between a shutdown and enabled state until the output fault is corrected. Please note that thermal performance can vary greatly depending on the package selected and the PCB layout design. This example uses the thermal performance of the SOIC (8) package.

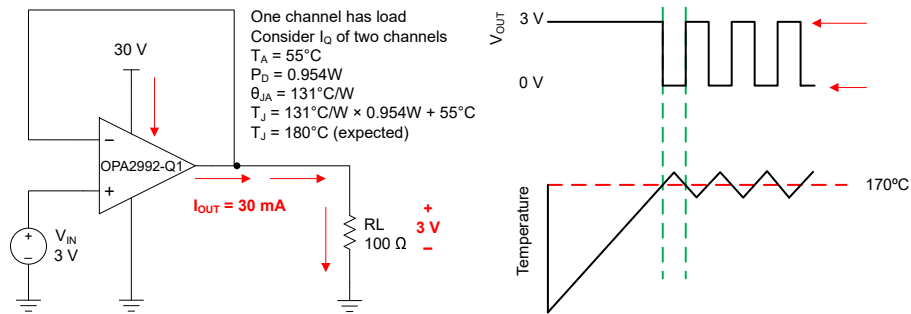

Figure 6-4. Thermal Protection

### 6.3.4 Capacitive Load and Stability

The OPAx992-Q1 features an output stage capable of driving moderate capacitive loads, and by leveraging an isolation resistor, the device can easily be configured to drive larger capacitive loads. Increasing the gain enhances the ability of the amplifier to drive greater capacitive loads; see Figure 6-5 and Figure 6-6. The particular op amp circuit configuration, layout, gain, and output loading are some of the factors to consider when establishing whether an amplifier are stable in operation.

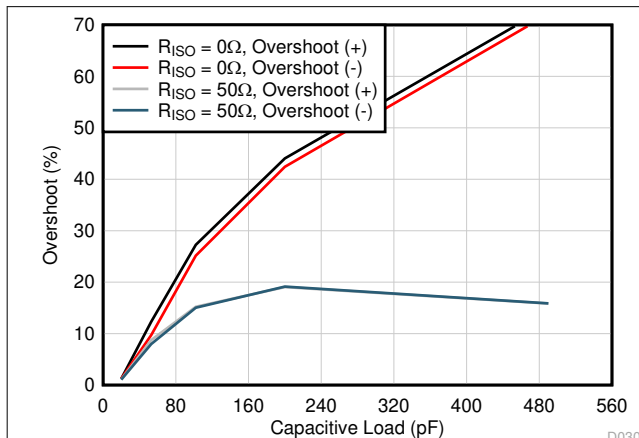

Figure 6-5. Small-Signal Overshoot vs Capacitive Load (20mV<sub>pp</sub> Output Step, G = +1)

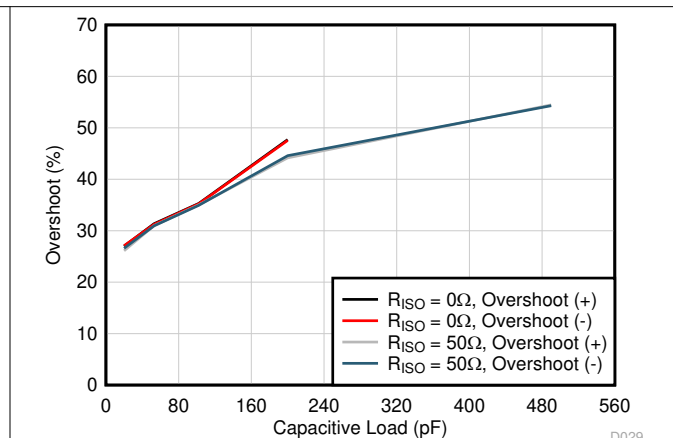
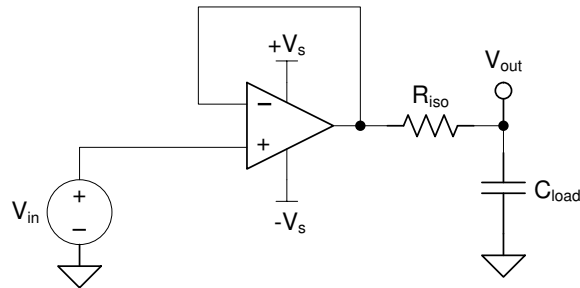

Figure 6-6. Small-Signal Overshoot vs Capacitive Load (20mV<sub>pp</sub> Output Step, G = -1)

For additional drive capability in unity-gain configurations, improve capacitive load drive by inserting a small resistor,  $R_{ISO}$ , in series with the output, as shown in Figure 6-7. This resistor significantly reduces ringing and maintains DC performance for purely capacitive loads. However, if a resistive load is in parallel with the capacitive load, then a voltage divider is created, thus introducing a gain error at the output and slightly reducing the output swing. The error introduced is proportional to the ratio  $R_{ISO} / R_L$ , and is generally negligible at low output levels. A high capacitive load drive makes the OPAx992-Q1 an excellent choice for applications such as reference buffers, MOSFET gate drives, and cable-shield drives. The circuit shown in Figure 6-7 uses an isolation resistor,  $R_{ISO}$ , to stabilize the output of an op amp.  $R_{ISO}$  modifies the open-loop gain of the system for increased phase margin.



**Figure 6-7. Extending Capacitive Load Drive With the OPA992-Q1**

### 6.3.5 Common-Mode Voltage Range

The OPAx992-Q1 is a 40V, true rail-to-rail input operational amplifier with an input common-mode range that extends to both supply rails. This wide range is achieved with paralleled complementary N-channel and P-channel differential input pairs, as shown in [Figure 6-8](#). The N-channel pair is active for input voltages close to the positive rail, typically from  $(V+) - 1V$  to the positive supply. The P-channel pair is active for inputs from the negative supply to approximately  $(V+) - 2V$ . There is a small transition region, typically  $(V+) - 2V$  to  $(V+) - 1V$ , in which both input pairs are on. This transition region can vary modestly with process variation. Within this region PSRR, CMRR, offset voltage, offset drift, noise, and THD performance can be degraded compared to operation outside this region.

[Figure 5-5](#) shows this transition region for a typical device in terms of input voltage offset in more detail.

For more information on common-mode voltage range and PMOS/NMOS pair interaction, see [Op Amps With Complementary-Pair Input Stages](#) application note.

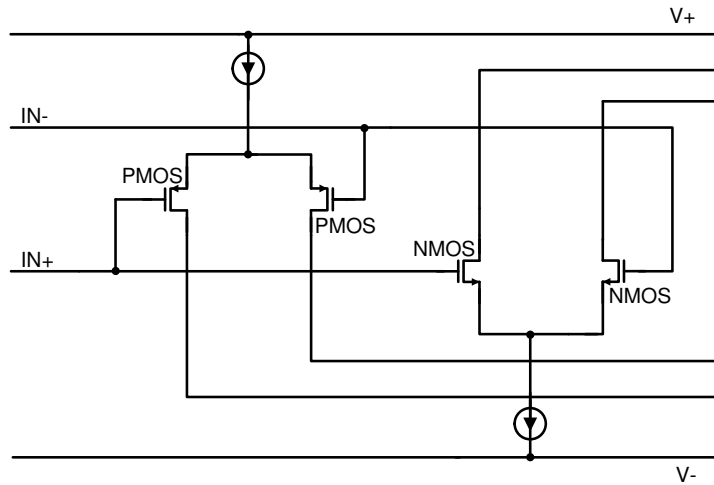

**Figure 6-8. Rail-to-Rail Input Stage**

### 6.3.6 Phase Reversal Protection

The OPAx992-Q1 family has internal phase-reversal protection. Many op amps exhibit a phase reversal when the input is driven beyond the linear common-mode range. This condition is most often encountered in non-inverting circuits when the input is driven beyond the specified common-mode voltage range, causing the output to reverse into the opposite rail. The OPAx992-Q1 is a rail-to-rail input op amp; therefore, the common-mode range can extend up to the rails. Input signals beyond the rails do not cause phase reversal; instead, the output limits into the appropriate rail. [Figure 6-9](#) shows this performance. For more information on phase reversal, see [Op Amps With Complementary-Pair Input Stages](#) application note.

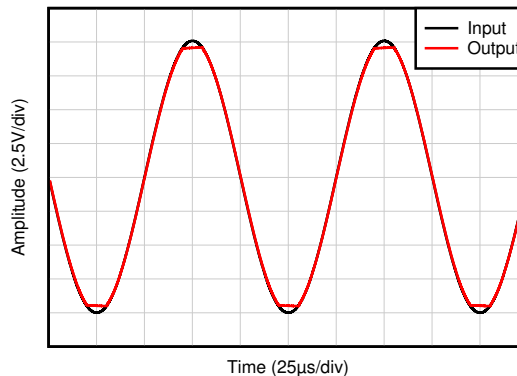

D031

**Figure 6-9. No Phase Reversal**

### 6.3.7 Electrical Overstress

Designers often ask questions about the capability of an operational amplifier to withstand electrical overstress (EOS). These questions tend to focus on the device inputs, but can involve the supply voltage pins or even the output pin. Each of these different pin functions have electrical stress limits determined by the voltage breakdown characteristics of the particular semiconductor fabrication process and specific circuits connected to the pin. Additionally, internal electrostatic discharge (ESD) protection is built into these circuits to protect them from accidental ESD events both before and during product assembly.

Having a good understanding of this basic ESD circuitry and the relevance to an electrical overstress event is helpful. Figure 6-10 shows the ESD circuits contained in the OPAX992-Q1 (indicated by the dashed line area). The ESD protection circuitry involves several current-steering diodes connected from the input and output pins and routed back to the internal power-supply lines, where the diodes meet at an absorption device or the power-supply ESD cell, internal to the operational amplifier. This protection circuitry is intended to remain inactive during normal circuit operation.

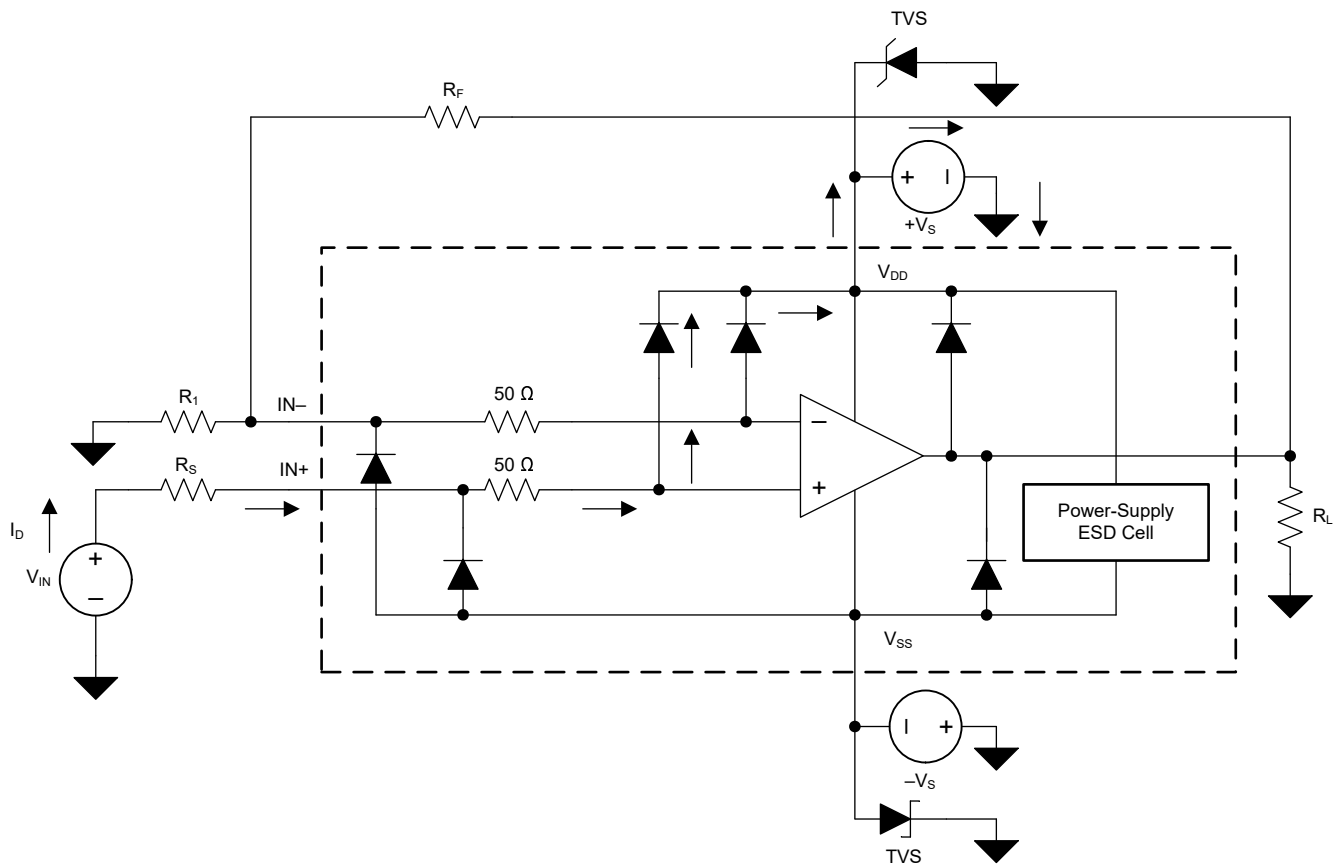

**Figure 6-10. Equivalent Internal ESD Circuitry Relative to a Typical Circuit Application**

An ESD event is very short in duration and very high voltage (for example, 1kV, 100ns), whereas an EOS event is long duration and lower voltage (for example, 50V, 100ms). The ESD diodes are designed for out-of-circuit ESD protection (that is, during assembly, test, and storage of the device before being soldered to the PCB). During an ESD event, the ESD signal is passed through the ESD steering diodes to an absorption circuit (labeled ESD power-supply circuit). The ESD absorption circuit clamps the supplies to a safe level.

Although this behavior is necessary for out-of-circuit protection, excessive current and damage is caused if activated in-circuit. A transient voltage suppressors (TVS) can be used to prevent against damage caused by turning on the ESD absorption circuit during an in-circuit ESD event. Using the appropriate current limiting resistors and TVS diodes allows for the use of device ESD diodes to protect against EOS events.



### 6.3.8 Overload Recovery

Overload recovery is defined as the time required for the op amp output to recover from a saturated state to a linear state. The output devices of the op amp enter a saturation region when the output voltage exceeds the rated operating voltage, either due to the high input voltage or the high gain. After the device enters the saturation region, the charge carriers in the output devices require time to return back to the linear state. After the charge carriers return back to the linear state, the device begins to slew at the specified slew rate. Thus, the propagation delay in case of an overload condition is the sum of the overload recovery time and the slew time. The overload recovery time for the OPAX992-Q1 is approximately 170ns.

### 6.3.9 Typical Specifications and Distributions

Designers often have questions about a typical specification of an amplifier to design a more robust circuit. Due to natural variation in process technology and manufacturing procedures, every specification of an amplifier exhibits some amount of deviation from the desired value, like the input offset voltage of an amplifier. These deviations often follow *Gaussian* (bell curve), or *normal* distributions, and circuit designers can leverage this information to guardband systems, even when there is not a minimum or maximum specification in the *Electrical Characteristics* table.

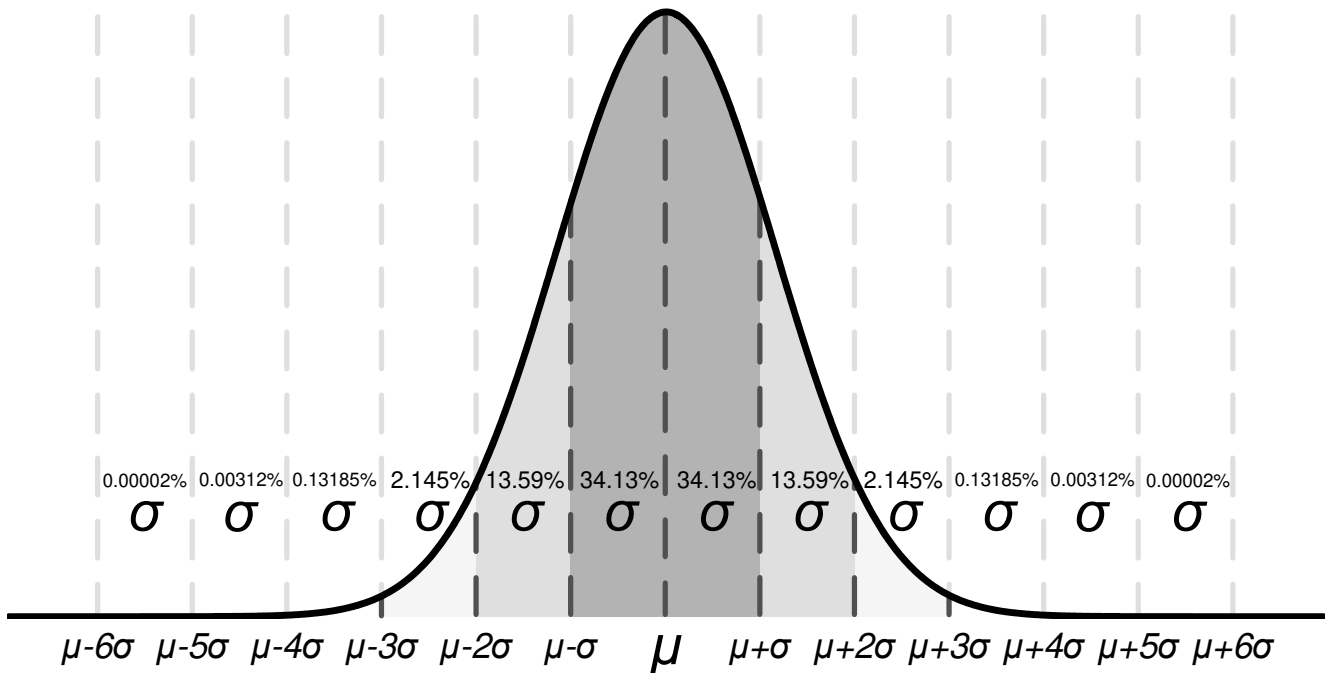

**Figure 6-11. Ideal Gaussian Distribution**

Figure 6-11 shows an example distribution, where  $\mu$ , or *mu*, is the mean of the distribution, and where  $\sigma$ , or *sigma*, is the standard deviation of a system. For a specification that exhibits this kind of distribution, approximately two-thirds (68.26%) of all units can be expected to have a value within one standard deviation, or one sigma, of the mean (from  $\mu - \sigma$  to  $\mu + \sigma$ ).

Depending on the specification, values listed in the *typical* column of the *Electrical Characteristics* table are represented in different ways. As a general rule, if a specification naturally has a nonzero mean (for example, like gain bandwidth), then the typical value is equal to the mean ( $\mu$ ). However, if a specification naturally has a mean near zero (like input offset voltage), then the typical value is equal to the mean plus one standard deviation ( $\mu + \sigma$ ) to most accurately represent the typical value.

This chart can be used to calculate approximate probability of a specification in a unit; for example, for OPAx992-Q1, the typical input voltage offset is 210 $\mu$ V. So 68.2% of all OPAx992-Q1 devices are expected to have an offset from  $-210\mu\text{V}$  to  $+210\mu\text{V}$ . At  $4\sigma$  ( $\pm 840\mu\text{V}$ ), 99.9937% of the distribution has an offset voltage less than  $\pm 840\mu\text{V}$ , which means 0.0063% of the population is outside of these limits, which corresponds to about 1 in 15,873 units.

Specifications with a value in the minimum or maximum column are specified by TI, and units outside these limits are removed from production material. For example, the OPAx992-Q1 family has a maximum offset voltage of 1mV at 25°C, and even though this corresponds to slightly less than  $5\sigma$  ( $\cong 1$  in 1.7 million units), which is extremely unlikely, TI maintains that any unit with larger offset than 1mV is removed from production material.

For specifications with no value in the minimum or maximum column, consider selecting a sigma value of sufficient guardband for the application, and design worst-case conditions using this value. For example, the  $6\sigma$  value corresponds to about 1 in 500 million units, which is an extremely unlikely chance, and can be an option as a wide guardband to design a system around. In this case, the OPAx992-Q1 family does not have a maximum or minimum for offset voltage drift. But based on the typical value of 0.25 $\mu\text{V}/^\circ\text{C}$  in the *Electrical Characteristics* table, the  $6\sigma$  value for offset voltage drift is about 1.5 $\mu\text{V}/^\circ\text{C}$  when calculated. When designing for worst-case system conditions, this value can be used to estimate the worst possible offset across temperature without having an actual minimum or maximum value.

Note that process variation and adjustments over time can shift typical means and standard deviations, and unless there is a value in the minimum or maximum specification column, TI cannot verify the performance of a device. This information must be used only to estimate the performance of a device.

## 6.4 Device Functional Modes

The OPAx992-Q1 has a single functional mode and is operational when the power-supply voltage is greater than or equal to 2.7V ( $\pm 1.35\text{V}$ ). The maximum power supply voltage for the OPAx992-Q1 is 40V ( $\pm 20\text{V}$ ).

## 7 Application and Implementation

### Note

Information in the following applications sections is not part of the TI component specification, and TI does not warrant its accuracy or completeness. TI's customers are responsible for determining suitability of components for their purposes, as well as validating and testing their design implementation to confirm system functionality.

### 7.1 Application Information

The OPAx992-Q1 family offers excellent DC precision and AC performance. These devices operate up to 40V supply rails and offer true rail-to-rail input or output, low offset voltage and offset voltage drift, as well as 10.6MHz bandwidth and high output drive. These features make the OPAx992-Q1 a robust, high-performance operational amplifier for high-voltage automotive applications.

### 7.2 Typical Applications

#### 7.2.1 Low-Side Current Measurement

Figure 7-1 shows the OPA992-Q1 configured in a low-side current sensing application. For a full analysis of the circuit shown in Figure 7-1 including theory, calculations, simulations, and measured data, see TI Precision Design TIPD129, [0A to 1A Single-Supply Low-Side Current-Sensing Solution](#).

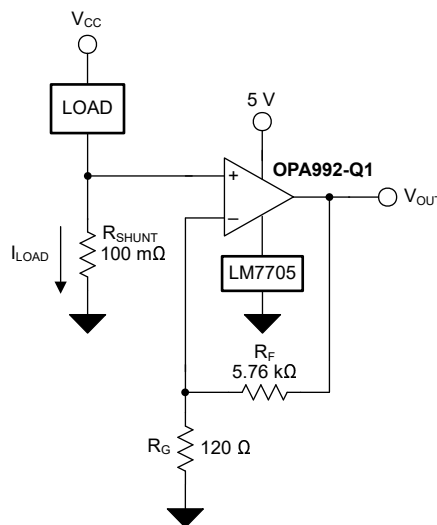

Figure 7-1. OPAx992-Q1 in a Low-Side, Current-Sensing Application

#### 7.2.1.1 Design Requirements

The design requirements for this design are:

- Load current: 0A to 1A
- Maximum output voltage: 4.9V
- Maximum shunt voltage: 100mV

#### 7.2.1.2 Detailed Design Procedure

The transfer function of the circuit in Figure 7-1 is given in Equation 1:

$$V_{OUT} = I_{LOAD} \times R_{SHUNT} \times \text{Gain} \quad (1)$$

The load current ( $I_{LOAD}$ ) produces a voltage drop across the shunt resistor ( $R_{SHUNT}$ ). The load current is set from 0A to 1A. To keep the shunt voltage below 100mV at maximum load current, the largest shunt resistor is defined using Equation 2:

$$R_{SHUNT} = \frac{V_{SHUNT\_MAX}}{I_{LOAD\_MAX}} = \frac{100\text{ mV}}{1\text{ A}} = 100\text{ m}\Omega \quad (2)$$

Using Equation 2,  $R_{SHUNT}$  is calculated to be 100m $\Omega$ . The voltage drop produced by  $I_{LOAD}$  and  $R_{SHUNT}$  is amplified by the OPA992-Q1 to produce an output voltage of 0V to 4.9V. The gain needed by the OPA992-Q1 to produce the necessary output voltage is calculated using Equation 3:

$$\text{Gain} = \frac{(V_{OUT\_MAX} - V_{OUT\_MIN})}{(V_{IN\_MAX} - V_{IN\_MIN})} \quad (3)$$

Using Equation 3, the required gain is calculated to be 49V/V, which is set with resistors  $R_F$  and  $R_G$ . Equation 4 is used to size the resistors,  $R_F$  and  $R_G$ , to set the gain of the OPA992-Q1 to 49V/V.

$$\text{Gain} = 1 + \frac{(R_F)}{(R_G)} \quad (4)$$

Choosing  $R_F$  as 5.76k $\Omega$ ,  $R_G$  is calculated to be 120 $\Omega$ .  $R_F$  and  $R_G$  were chosen as 5.76k $\Omega$  and 120 $\Omega$  because the values are standard value resistors that create a 49:1 ratio. Other resistors that create a 49:1 ratio can also be used. However, excessively large resistors generate thermal noise that exceeds the intrinsic noise of the op amp. Figure 7-2 shows the measured transfer function of the circuit shown in Figure 7-1.

### 7.2.1.3 Application Curve

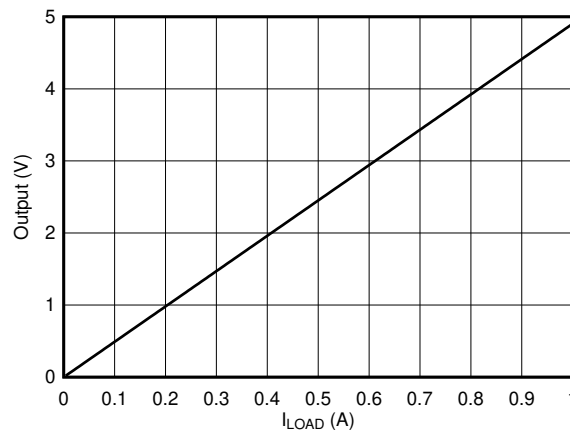

Figure 7-2. Low-Side, Current-Sense, Transfer Function

## 7.3 Power Supply Recommendations

The OPAX992-Q1 is specified for operation from 2.7V to 40V ( $\pm 1.35\text{V}$  to  $\pm 20\text{V}$ ); many specifications apply from  $-40^\circ\text{C}$  to  $125^\circ\text{C}$  or with specific supply voltages and test conditions.

### CAUTION

Supply voltages larger than 40V can permanently damage the device; see the *Absolute Maximum Ratings* table.

Place 0.1 $\mu\text{F}$  bypass capacitors close to the power-supply pins to reduce errors coupling in from noisy or high-impedance power supplies. For more detailed information on bypass capacitor placement, refer to [Layout](#).

## 7.4 Layout

### 7.4.1 Layout Guidelines

For best operational performance of the device, use good PCB layout practices, including:

- Noise can propagate into analog circuitry through the power pins of the circuit as a whole and through the op amp. Bypass capacitors are used to reduce the coupled noise by providing low-impedance power sources local to the analog circuitry.
  - Connect low-ESR, 0.1 $\mu$ F ceramic bypass capacitors between each supply pin and ground, placed as close to the device as possible. A single bypass capacitor from V+ to ground is applicable for single-supply applications.
- Separate grounding for analog and digital portions of circuitry is one of the simplest and most-effective methods of noise suppression. One or more layers on multilayer PCBs are usually devoted to ground planes. A ground plane helps distribute heat and reduces EMI noise pickup. Make sure to physically separate digital and analog grounds paying attention to the flow of the ground current.
- To reduce parasitic coupling, run the input traces as far away from the supply or output traces as possible. If these traces cannot be kept separate, crossing the sensitive trace perpendicular is much better as opposed to in parallel with the noisy trace.
- Place the external components as close to the device as possible. As shown in [Figure 7-4](#), keeping RF and RG close to the inverting input minimizes parasitic capacitance.
- Keep the length of input traces as short as possible. Always remember that the input traces are the most sensitive part of the circuit.
- Consider a driven, low-impedance guard ring around the critical traces. A guard ring can significantly reduce leakage currents from nearby traces that are at different potentials.
- Cleaning the PCB following board assembly is recommended for best performance.
- Any precision integrated circuit can experience performance shifts due to moisture ingress into the plastic package. Following any aqueous PCB cleaning process, baking the PCB assembly is recommended to remove moisture introduced into the device packaging during the cleaning process. A low temperature, post cleaning bake at 85°C for 30 minutes is sufficient for most circumstances.

### 7.4.2 Layout Example

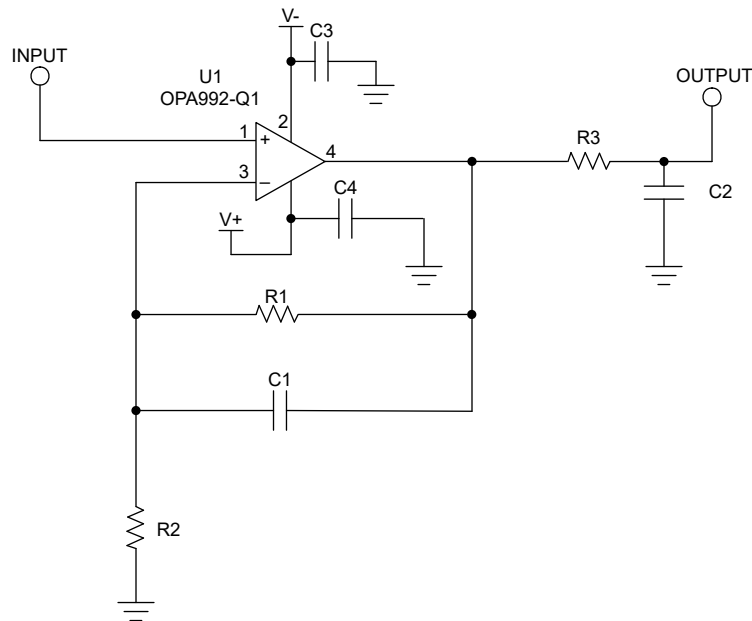

**Figure 7-3. Schematic for Noninverting Configuration Layout Example**

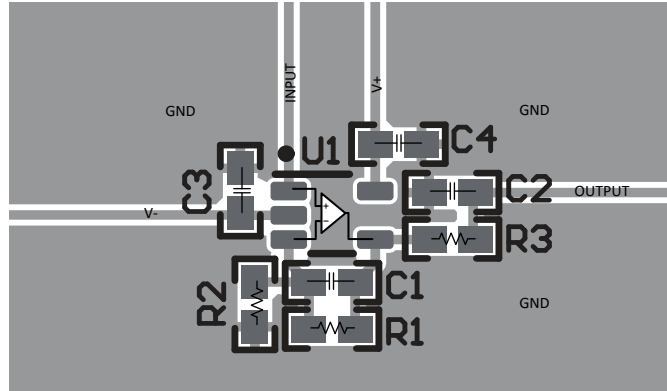

Figure 7-4. Operational Amplifier Board Layout for Noninverting Configuration - SC70 (DCK) Package

## 8 Device and Documentation Support

### 8.1 Device Support

#### 8.1.1 Development Support

##### 8.1.1.1 TINA-TI™ (Free Software Download)

TINA™ is a simple, powerful, and easy-to-use circuit simulation program based on a SPICE engine. TINA-TI is a free, fully-functional version of the TINA software, preloaded with a library of macro models in addition to a range of both passive and active models. TINA-TI provides all the conventional dc, transient, and frequency domain analysis of SPICE, as well as additional design capabilities.

Available as a [free download](#) from the Analog eLab Design Center, TINA-TI offers extensive post-processing capability that allows users to format results in a variety of ways. Virtual instruments offer the ability to select input waveforms and probe circuit nodes, voltages, and waveforms, creating a dynamic quick-start tool.

---

#### Note

These files require that either the TINA software (from DesignSoft™) or TINA-TI software be installed. Download the free TINA-TI software from the [TINA-TI folder](#).

---

### 8.2 Documentation Support

#### 8.2.1 Related Documentation

- Texas Instruments, [MUX-Friendly, Precision Operational Amplifiers](#) application brief
- Texas Instruments, [EMI Rejection Ratio of Operational Amplifiers](#) application note
- Texas Instruments, [Op Amps With Complementary-Pair Input Stages](#) application note
- Texas Instruments, [0A to 1A, Single-Supply, Low-Side, Current Sensing Solution](#) reference design (TIPD129)

### 8.3 Receiving Notification of Documentation Updates

To receive notification of documentation updates, navigate to the device product folder on [ti.com](#). Click on *Notifications* to register and receive a weekly digest of any product information that has changed. For change details, review the revision history included in any revised document.

### 8.4 Support Resources

[TI E2E™ support forums](#) are an engineer's go-to source for fast, verified answers and design help — straight from the experts. Search existing answers or ask your own question to get the quick design help you need.

Linked content is provided "AS IS" by the respective contributors. They do not constitute TI specifications and do not necessarily reflect TI's views; see TI's [Terms of Use](#).

### 8.5 Trademarks

TINA-TI™ is a trademark of Texas Instruments, Inc and DesignSoft, Inc.

TINA™ and DesignSoft™ are trademarks of DesignSoft, Inc.

TI E2E™ is a trademark of Texas Instruments.

Bluetooth® is a registered trademark of Bluetooth SIG, Inc.

All trademarks are the property of their respective owners.

### 8.6 Electrostatic Discharge Caution



This integrated circuit can be damaged by ESD. Texas Instruments recommends that all integrated circuits be handled with appropriate precautions. Failure to observe proper handling and installation procedures can cause damage.

ESD damage can range from subtle performance degradation to complete device failure. Precision integrated circuits may be more susceptible to damage because very small parametric changes could cause the device not to meet its published specifications.

### 8.7 Glossary

[TI Glossary](#) This glossary lists and explains terms, acronyms, and definitions.

## 9 Revision History

NOTE: Page numbers for previous revisions may differ from page numbers in the current version.

Changes from Revision D (April 2023) to Revision E (July 2024)	Page
• Added the 8-pin TSSOP (PW) package to the <i>Package Information</i> table.....	1
• Added 8-pin TSSOP (PW) package to the <i>Pin Configurations and Functions</i> section.....	3
• Added 8-pin TSSOP (PW) package to Thermal Information for Dual Channel table.....	7

Changes from Revision C (February 2023) to Revision D (April 2023)	Page
• Changed the status of the 14-pin SOIC (D) and TSSOP (PW) packages from: <i>Preview</i> to: <i>Active</i> .....	1

Changes from Revision B (January 2023) to Revision C (February 2023)	Page
• Changed the status of the 5-pin SOT-23 and 8-pin SOIC package from: <i>Preview</i> to: <i>Active</i> .....	1

Changes from Revision A (December 2022) to Revision B (January 2023)	Page
• Deleted the preview tag for the SC70-5 (DCK) package.....	1

Changes from Revision * (August 2022) to Revision A (December 2022)	Page
• Changed the device status from <i>Advance Information</i> to <i>ProdMix</i> .....	1
• Deleted the preview tag for the VSSOP-8 (DGK) package.....	1

## 10 Mechanical, Packaging, and Orderable Information

The following pages include mechanical, packaging, and orderable information. This information is the most current data available for the designated devices. This data is subject to change without notice and revision of this document. For browser-based versions of this data sheet, refer to the left-hand navigation.



**PACKAGING INFORMATION**

Orderable Device	Status (1)	Package Type	Package Drawing	Pins	Package Qty	Eco Plan (2)	Lead finish/ Ball material (6)	MSL Peak Temp (3)	Op Temp (°C)	Device Marking (4/5)	Samples
OPA2992QDGKRQ1	ACTIVE	VSSOP	DGK	8	2500	RoHS & Green	NIPDAU	Level-1-260C-UNLIM	-40 to 125	2S4T	<a href="#">Samples</a>
OPA2992QDRQ1	ACTIVE	SOIC	D	8	3000	RoHS & Green	NIPDAU	Level-1-260C-UNLIM	-40 to 125	O2992Q	<a href="#">Samples</a>
OPA4992QDRQ1	ACTIVE	SOIC	D	14	3000	RoHS & Green	NIPDAU	Level-1-260C-UNLIM	-40 to 125	OPA4992QD	<a href="#">Samples</a>
OPA4992QPWRQ1	ACTIVE	TSSOP	PW	14	3000	RoHS & Green	NIPDAU	Level-1-260C-UNLIM	-40 to 125	Q4992PW	<a href="#">Samples</a>
OPA992QDBVRQ1	ACTIVE	SOT-23	DBV	5	3000	RoHS & Green	SN	Level-1-260C-UNLIM	-40 to 125	2VWH	<a href="#">Samples</a>
OPA992QDCKRQ1	ACTIVE	SC70	DCK	5	3000	RoHS & Green	NIPDAU	Level-1-260C-UNLIM	-40 to 125	1NH	<a href="#">Samples</a>

(1) The marketing status values are defined as follows:

**ACTIVE:** Product device recommended for new designs.

**LIFEBUY:** TI has announced that the device will be discontinued, and a lifetime-buy period is in effect.

**NRND:** Not recommended for new designs. Device is in production to support existing customers, but TI does not recommend using this part in a new design.

**PREVIEW:** Device has been announced but is not in production. Samples may or may not be available.

**OBSELETE:** TI has discontinued the production of the device.

(2) **RoHS:** TI defines "RoHS" to mean semiconductor products that are compliant with the current EU RoHS requirements for all 10 RoHS substances, including the requirement that RoHS substance do not exceed 0.1% by weight in homogeneous materials. Where designed to be soldered at high temperatures, "RoHS" products are suitable for use in specified lead-free processes. TI may reference these types of products as "Pb-Free".

**RoHS Exempt:** TI defines "RoHS Exempt" to mean products that contain lead but are compliant with EU RoHS pursuant to a specific EU RoHS exemption.

**Green:** TI defines "Green" to mean the content of Chlorine (Cl) and Bromine (Br) based flame retardants meet JS709B low halogen requirements of <=1000ppm threshold. Antimony trioxide based flame retardants must also meet the <=1000ppm threshold requirement.

(3) MSL, Peak Temp. - The Moisture Sensitivity Level rating according to the JEDEC industry standard classifications, and peak solder temperature.

(4) There may be additional marking, which relates to the logo, the lot trace code information, or the environmental category on the device.

(5) Multiple Device Markings will be inside parentheses. Only one Device Marking contained in parentheses and separated by a "-" will appear on a device. If a line is indented then it is a continuation of the previous line and the two combined represent the entire Device Marking for that device.

(6) Lead finish/Ball material - Orderable Devices may have multiple material finish options. Finish options are separated by a vertical ruled line. Lead finish/Ball material values may wrap to two lines if the finish value exceeds the maximum column width.

**Important Information and Disclaimer:** The information provided on this page represents TI's knowledge and belief as of the date that it is provided. TI bases its knowledge and belief on information provided by third parties, and makes no representation or warranty as to the accuracy of such information. Efforts are underway to better integrate information from third parties. TI has taken and continues to take reasonable steps to provide representative and accurate information but may not have conducted destructive testing or chemical analysis on incoming materials and chemicals. TI and TI suppliers consider certain information to be proprietary, and thus CAS numbers and other limited information may not be available for release.

In no event shall TI's liability arising out of such information exceed the total purchase price of the TI part(s) at issue in this document sold by TI to Customer on an annual basis.

**OTHER QUALIFIED VERSIONS OF OPA2992-Q1, OPA4992-Q1, OPA992-Q1 :**

- Catalog : [OPA2992](#), [OPA4992](#), [OPA992](#)

NOTE: Qualified Version Definitions:

- Catalog - TI's standard catalog product

**TAPE AND REEL INFORMATION**

**QUADRANT ASSIGNMENTS FOR PIN 1 ORIENTATION IN TAPE**

\*All dimensions are nominal

Device	Package Type	Package Drawing	Pins	SPQ	Reel Diameter (mm)	Reel Width W1 (mm)	A0 (mm)	B0 (mm)	K0 (mm)	P1 (mm)	W (mm)	Pin1 Quadrant
OPA2992QDGKRQ1	VSSOP	DGK	8	2500	330.0	12.4	5.3	3.4	1.4	8.0	12.0	Q1
OPA2992QDRQ1	SOIC	D	8	3000	330.0	12.4	6.4	5.2	2.1	8.0	12.0	Q1
OPA4992QDRQ1	SOIC	D	14	3000	330.0	16.4	6.5	9.0	2.1	8.0	16.0	Q1
OPA4992QPWRQ1	TSSOP	PW	14	3000	330.0	12.4	6.9	5.6	1.6	8.0	12.0	Q1
OPA992QDBVRQ1	SOT-23	DBV	5	3000	180.0	8.4	3.2	3.2	1.4	4.0	8.0	Q3
OPA992QDCKRQ1	SC70	DCK	5	3000	178.0	9.0	2.4	2.5	1.2	4.0	8.0	Q3

**TAPE AND REEL BOX DIMENSIONS**

\*All dimensions are nominal

Device	Package Type	Package Drawing	Pins	SPQ	Length (mm)	Width (mm)	Height (mm)
OPA2992QDGKRQ1	VSSOP	DGK	8	2500	366.0	364.0	50.0
OPA2992QDRQ1	SOIC	D	8	3000	356.0	356.0	35.0
OPA4992QDRQ1	SOIC	D	14	3000	356.0	356.0	35.0
OPA4992QPWRQ1	TSSOP	PW	14	3000	356.0	356.0	35.0
OPA992QDBVRQ1	SOT-23	DBV	5	3000	210.0	185.0	35.0
OPA992QDCKRQ1	SC70	DCK	5	3000	180.0	180.0	18.0

# DCK0005A



## PACKAGE OUTLINE

SOT - 1.1 max height

SMALL OUTLINE TRANSISTOR

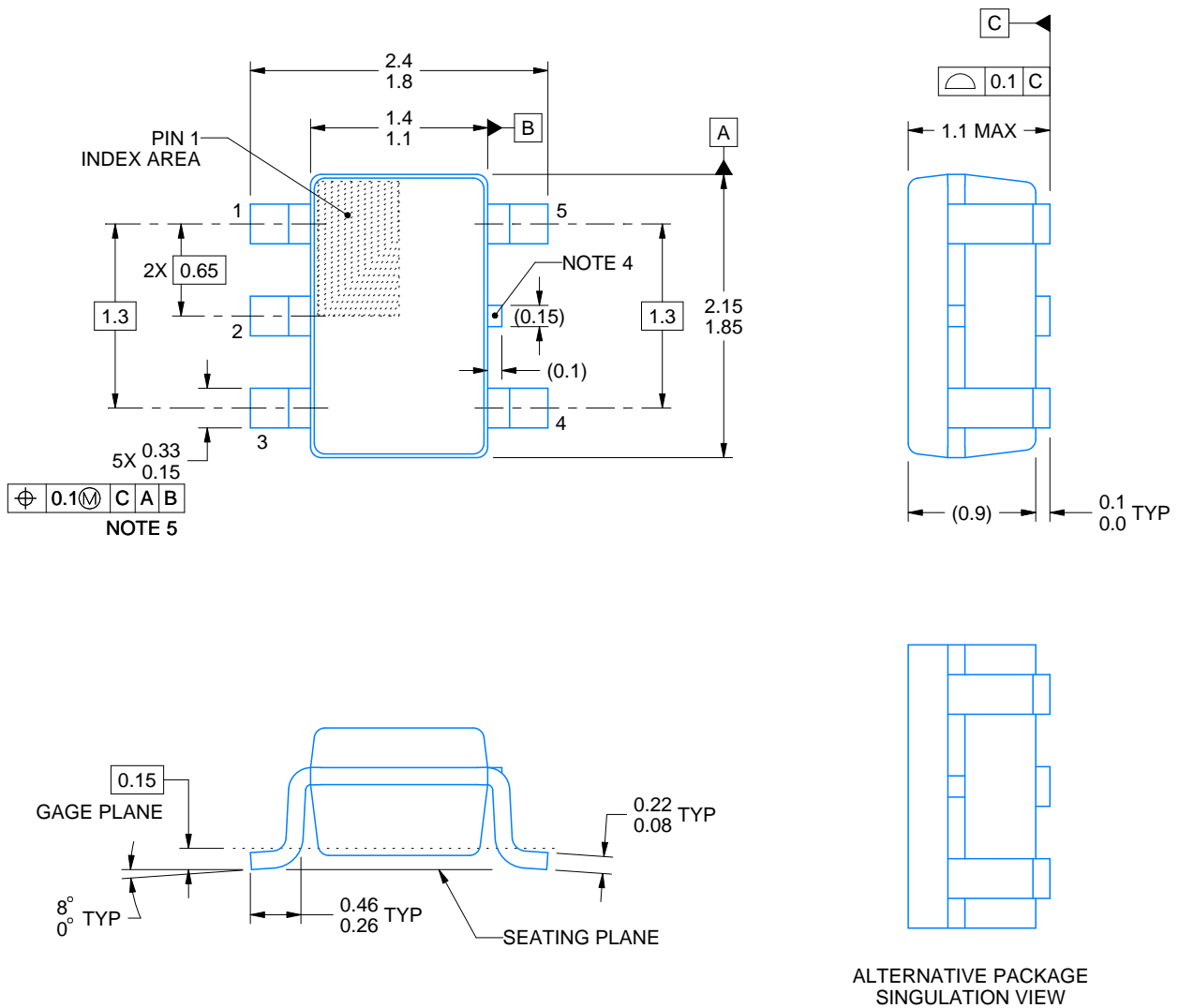

4214834/E 06/2024

### NOTES:

1. All linear dimensions are in millimeters. Any dimensions in parenthesis are for reference only. Dimensioning and tolerancing per ASME Y14.5M.
2. This drawing is subject to change without notice.
3. Reference JEDEC MO-203.
4. Support pin may differ or may not be present.
5. Lead width does not comply with JEDEC.
6. Body dimensions do not include mold flash, protrusions, or gate burrs. Mold flash, protrusions, or gate burrs shall not exceed 0.25mm per side

# EXAMPLE BOARD LAYOUT

DCK0005A

SOT - 1.1 max height

SMALL OUTLINE TRANSISTOR



LAND PATTERN EXAMPLE  
EXPOSED METAL SHOWN  
SCALE:18X



SOLDER MASK DETAILS

4214834/E 06/2024

NOTES: (continued)

7. Publication IPC-7351 may have alternate designs.
8. Solder mask tolerances between and around signal pads can vary based on board fabrication site.

# EXAMPLE STENCIL DESIGN

DCK0005A

SOT - 1.1 max height

SMALL OUTLINE TRANSISTOR

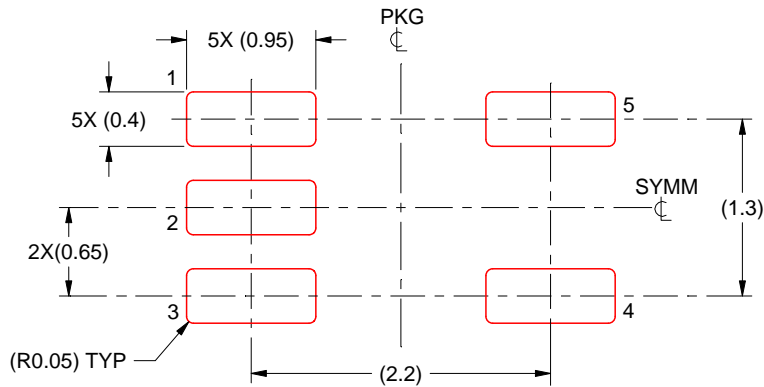

SOLDER PASTE EXAMPLE  
BASED ON 0.125 THICK STENCIL  
SCALE: 18X

4214834/E 06/2024

NOTES: (continued)

9. Laser cutting apertures with trapezoidal walls and rounded corners may offer better paste release. IPC-7525 may have alternate design recommendations.
10. Board assembly site may have different recommendations for stencil design.

# DGK0008A



# PACKAGE OUTLINE

VSSOP - 1.1 mm max height

SMALL OUTLINE PACKAGE



4214862/A 04/2023

**NOTES:**

PowerPAD is a trademark of Texas Instruments.

1. All linear dimensions are in millimeters. Any dimensions in parenthesis are for reference only. Dimensioning and tolerancing per ASME Y14.5M.
2. This drawing is subject to change without notice.
3. This dimension does not include mold flash, protrusions, or gate burrs. Mold flash, protrusions, or gate burrs shall not exceed 0.15 mm per side.
4. This dimension does not include interlead flash. Interlead flash shall not exceed 0.25 mm per side.
5. Reference JEDEC registration MO-187.



# EXAMPLE BOARD LAYOUT

DGK0008A

™ VSSOP - 1.1 mm max height

SMALL OUTLINE PACKAGE



LAND PATTERN EXAMPLE  
EXPOSED METAL SHOWN  
SCALE: 15X



SOLDER MASK DETAILS

4214862/A 04/2023

NOTES: (continued)

6. Publication IPC-7351 may have alternate designs.
7. Solder mask tolerances between and around signal pads can vary based on board fabrication site.
8. Vias are optional depending on application, refer to device data sheet. If any vias are implemented, refer to their locations shown on this view. It is recommended that vias under paste be filled, plugged or tented.
9. Size of metal pad may vary due to creepage requirement.

# EXAMPLE STENCIL DESIGN

DGK0008A

<sup>TM</sup> VSSOP - 1.1 mm max height

SMALL OUTLINE PACKAGE



SOLDER PASTE EXAMPLE  
SCALE: 15X

4214862/A 04/2023

NOTES: (continued)

11. Laser cutting apertures with trapezoidal walls and rounded corners may offer better paste release. IPC-7525 may have alternate design recommendations.
12. Board assembly site may have different recommendations for stencil design.

# DBV0005A



# PACKAGE OUTLINE

## SOT-23 - 1.45 mm max height

SMALL OUTLINE TRANSISTOR

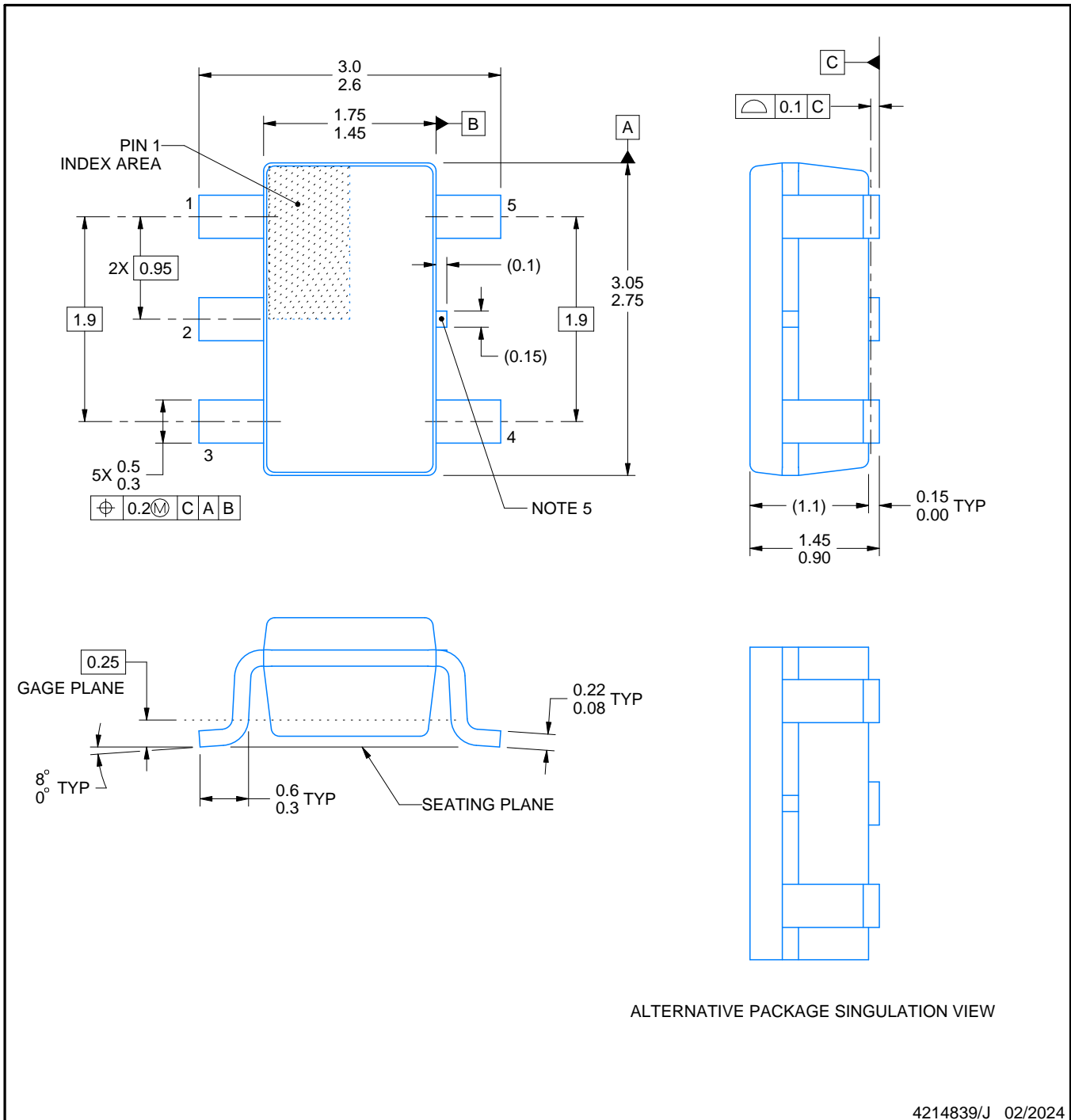

### NOTES:

1. All linear dimensions are in millimeters. Any dimensions in parenthesis are for reference only. Dimensioning and tolerancing per ASME Y14.5M.
2. This drawing is subject to change without notice.
3. Reference JEDEC MO-178.
4. Body dimensions do not include mold flash, protrusions, or gate burrs. Mold flash, protrusions, or gate burrs shall not exceed 0.25 mm per side.
5. Support pin may differ or may not be present.

# EXAMPLE BOARD LAYOUT

DBV0005A

SOT-23 - 1.45 mm max height

SMALL OUTLINE TRANSISTOR

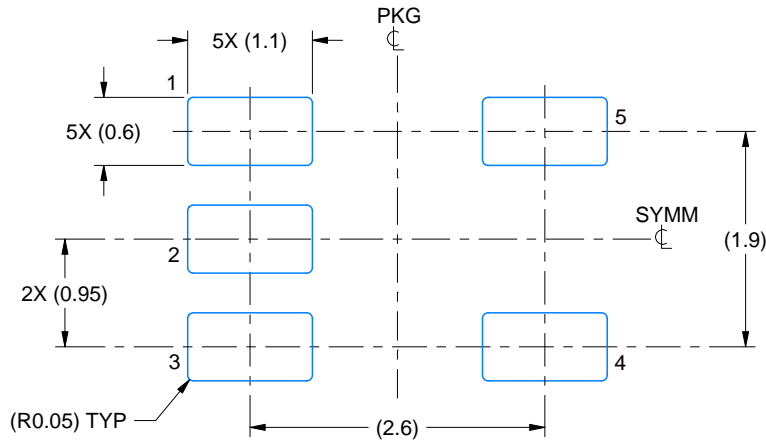

LAND PATTERN EXAMPLE  
EXPOSED METAL SHOWN  
SCALE:15X

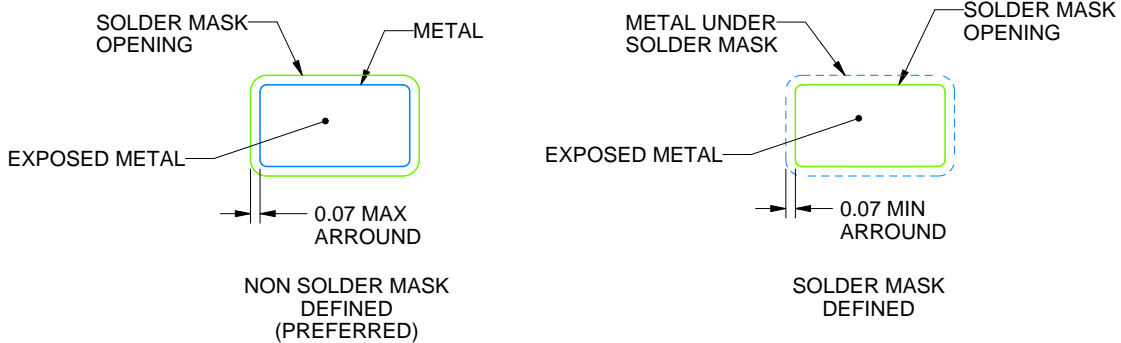

SOLDER MASK DETAILS

4214839/J 02/2024

NOTES: (continued)

6. Publication IPC-7351 may have alternate designs.
7. Solder mask tolerances between and around signal pads can vary based on board fabrication site.

# EXAMPLE STENCIL DESIGN

DBV0005A

SOT-23 - 1.45 mm max height

SMALL OUTLINE TRANSISTOR



SOLDER PASTE EXAMPLE  
BASED ON 0.125 mm THICK STENCIL  
SCALE:15X

4214839/J 02/2024

NOTES: (continued)

8. Laser cutting apertures with trapezoidal walls and rounded corners may offer better paste release. IPC-7525 may have alternate design recommendations.
9. Board assembly site may have different recommendations for stencil design.

D (R-PDSO-G14)

PLASTIC SMALL OUTLINE



- NOTES:
- A. All linear dimensions are in inches (millimeters).
  - B. This drawing is subject to change without notice.
  - $\triangle C$  Body length does not include mold flash, protrusions, or gate burrs. Mold flash, protrusions, or gate burrs shall not exceed 0.006 (0,15) each side.
  - $\triangle D$  Body width does not include interlead flash. Interlead flash shall not exceed 0.017 (0,43) each side.
  - E. Reference JEDEC MS-012 variation AB.

PW (R-PDSO-G14)

PLASTIC SMALL OUTLINE



4040064-3/G 02/11

- NOTES:
- A. All linear dimensions are in millimeters. Dimensioning and tolerancing per ASME Y14.5M-1994.
  - B. This drawing is subject to change without notice.
  -  C. Body length does not include mold flash, protrusions, or gate burrs. Mold flash, protrusions, or gate burrs shall not exceed 0,15 each side.
  -  D. Body width does not include interlead flash. Interlead flash shall not exceed 0,25 each side.
  - E. Falls within JEDEC MO-153

PW (R-PDSO-G14)

PLASTIC SMALL OUTLINE



- NOTES:
- All linear dimensions are in millimeters.
  - This drawing is subject to change without notice.
  - Publication IPC-7351 is recommended for alternate designs.
  - Laser cutting apertures with trapezoidal walls and also rounding corners will offer better paste release. Customers should contact their board assembly site for stencil design recommendations. Refer to IPC-7525 for other stencil recommendations.
  - Customers should contact their board fabrication site for solder mask tolerances between and around signal pads.





D0008A

# PACKAGE OUTLINE

SOIC - 1.75 mm max height

SMALL OUTLINE INTEGRATED CIRCUIT



4214825/C 02/2019

NOTES:

1. Linear dimensions are in inches [millimeters]. Dimensions in parenthesis are for reference only. Controlling dimensions are in inches. Dimensioning and tolerancing per ASME Y14.5M.
2. This drawing is subject to change without notice.
3. This dimension does not include mold flash, protrusions, or gate burrs. Mold flash, protrusions, or gate burrs shall not exceed .006 [0.15] per side.
4. This dimension does not include interlead flash.
5. Reference JEDEC registration MS-012, variation AA.

# EXAMPLE BOARD LAYOUT

D0008A

SOIC - 1.75 mm max height

SMALL OUTLINE INTEGRATED CIRCUIT



LAND PATTERN EXAMPLE  
EXPOSED METAL SHOWN  
SCALE:8X



SOLDER MASK DETAILS

4214825/C 02/2019

NOTES: (continued)

- 6. Publication IPC-7351 may have alternate designs.
- 7. Solder mask tolerances between and around signal pads can vary based on board fabrication site.

# EXAMPLE STENCIL DESIGN

D0008A

SOIC - 1.75 mm max height

SMALL OUTLINE INTEGRATED CIRCUIT



SOLDER PASTE EXAMPLE  
BASED ON .005 INCH [0.125 MM] THICK STENCIL  
SCALE:8X

4214825/C 02/2019

NOTES: (continued)

8. Laser cutting apertures with trapezoidal walls and rounded corners may offer better paste release. IPC-7525 may have alternate design recommendations.
9. Board assembly site may have different recommendations for stencil design.

## IMPORTANT NOTICE AND DISCLAIMER

TI PROVIDES TECHNICAL AND RELIABILITY DATA (INCLUDING DATA SHEETS), DESIGN RESOURCES (INCLUDING REFERENCE DESIGNS), APPLICATION OR OTHER DESIGN ADVICE, WEB TOOLS, SAFETY INFORMATION, AND OTHER RESOURCES "AS IS" AND WITH ALL FAULTS, AND DISCLAIMS ALL WARRANTIES, EXPRESS AND IMPLIED, INCLUDING WITHOUT LIMITATION ANY IMPLIED WARRANTIES OF MERCHANTABILITY, FITNESS FOR A PARTICULAR PURPOSE OR NON-INFRINGEMENT OF THIRD PARTY INTELLECTUAL PROPERTY RIGHTS.

These resources are intended for skilled developers designing with TI products. You are solely responsible for (1) selecting the appropriate TI products for your application, (2) designing, validating and testing your application, and (3) ensuring your application meets applicable standards, and any other safety, security, regulatory or other requirements.

These resources are subject to change without notice. TI grants you permission to use these resources only for development of an application that uses the TI products described in the resource. Other reproduction and display of these resources is prohibited. No license is granted to any other TI intellectual property right or to any third party intellectual property right. TI disclaims responsibility for, and you will fully indemnify TI and its representatives against, any claims, damages, costs, losses, and liabilities arising out of your use of these resources.

TI's products are provided subject to [TI's Terms of Sale](#) or other applicable terms available either on [ti.com](https://www.ti.com) or provided in conjunction with such TI products. TI's provision of these resources does not expand or otherwise alter TI's applicable warranties or warranty disclaimers for TI products.

TI objects to and rejects any additional or different terms you may have proposed.

Mailing Address: Texas Instruments, Post Office Box 655303, Dallas, Texas 75265  
Copyright © 2024, Texas Instruments Incorporated