

## TL07xx Low-Noise FET-Input Operational Amplifiers

### 1 Features

- High slew rate: 20 V/μs (TL07xH, typ)
- Low offset voltage: 1 mV (TL07xH, typ)
- Low offset voltage drift: 2 μV/°C
- Low power consumption: 940 μA/ch (TL07xH, typ)
- Wide common-mode and differential voltage ranges
  - Common-mode input voltage range includes  $V_{CC+}$
- Low input bias and offset currents
- Low noise:  $V_n = 18 \text{ nV}/\sqrt{\text{Hz}}$  (typ) at  $f = 1 \text{ kHz}$
- Output short-circuit protection
- Low total harmonic distortion: 0.003% (typ)
- Wide supply voltage: ±2.25 V to ±20 V, 4.5 V to 40 V

### 2 Applications

- [Solar energy: string and central inverter](#)
- [Motor drives: AC and servo drive control and power stage modules](#)
- [Single phase online UPS](#)
- [Three phase UPS](#)
- [Pro audio mixers](#)
- [Battery test equipment](#)

### 3 Description

The TL07xH (TL071H, TL072H, and TL074H) family of devices are the next-generation versions of the industry-standard TL07x (TL071, TL072, and TL074) devices. These devices provide outstanding value for cost-sensitive applications, with features including low offset (1 mV, typical), high slew rate (20 V/μs), and common-mode input to the positive supply. High ESD

(1.5 kV, HBM), integrated EMI and RF filters, and operation across the full –40°C to 125°C enable the TL07xH devices to be used in the most rugged and demanding applications.

#### Package Information

PART NUMBER <sup>(1)</sup>	PACKAGE	BODY SIZE (NOM)
TL071x	P (PDIP, 8)	9.59 mm × 6.35 mm
	DCK (SC70, 5)	2.00 mm × 1.25 mm
	PS (SO, 8)	6.20 mm × 5.30 mm
	D (SOIC, 8)	4.90 mm × 3.90 mm
	DBV (SOT-23, 5)	1.60 mm × 1.20 mm
TL072x	P (PDIP, 8)	9.59 mm × 6.35 mm
	PS (SO, 8)	6.20 mm × 5.30 mm
	D (SOIC, 8)	4.90 mm × 3.90 mm
	P (SOT-23, 8)	2.90 mm × 1.60 mm
	PW (TSSOP, 8)	4.40 mm × 3.00 mm
TL072M	JG (CDIP, 8)	9.59 mm × 6.67 mm
	W (CFP, 10)	6.12 mm × 3.56 mm
	FK (LCCC, 20)	8.89 mm × 8.89 mm
TL074x	N (PDIP, 14)	19.30 mm × 6.35 mm
	NS (SO, 14)	10.30 mm × 5.30 mm
	D (SOIC, 14)	8.65 mm × 3.91 mm
	DYY (SOT-23, 14)	4.20 mm × 2.00 mm
	DB (SSOP, 14)	6.20 mm × 5.30 mm
	PW (TSSOP, 14)	5.00 mm × 4.40 mm
TL074M	J (CDIP, 14)	19.56 mm × 6.92 mm
	W (CFP, 14)	9.21 mm × 6.29 mm
	FK (LCCC, 20)	8.89 mm × 8.89 mm

(1) For all available packages, see the orderable addendum at the end of the data sheet.

TL071



TL072 (each amplifier)  
 TL074 (each amplifier)



Copyright © 2017, Texas Instruments Incorporated

### Logic Symbols



## Table of Contents

<b>1 Features</b> .....	1	<b>8 Detailed Description</b> .....	32
<b>2 Applications</b> .....	1	8.1 Overview.....	32
<b>3 Description</b> .....	1	8.2 Functional Block Diagram.....	32
<b>4 Revision History</b> .....	2	8.3 Feature Description.....	32
<b>5 Pin Configuration and Functions</b> .....	5	8.4 Device Functional Modes.....	32
<b>6 Specifications</b> .....	12	<b>9 Application and Implementation</b> .....	33
6.1 Absolute Maximum Ratings.....	12	9.1 Application Information.....	33
6.2 ESD Ratings.....	12	9.2 Typical Application.....	33
6.3 Recommended Operating Conditions.....	12	9.3 Unity Gain Buffer.....	34
6.4 Thermal Information for Single Channel.....	13	9.4 System Examples.....	35
6.5 Thermal Information for Dual Channel.....	13	9.5 Power Supply Recommendations.....	36
6.6 Thermal Information for Quad Channel.....	14	9.6 Layout.....	36
6.7 Electrical Characteristics: TL07xH.....	15	<b>10 Device and Documentation Support</b> .....	38
6.8 Electrical Characteristics (DC): TL07xC, TL07xAC, TL07xBC, TL07xI, TL07xM.....	17	10.1 Receiving Notification of Documentation Updates..	38
6.9 Electrical Characteristics (AC): TL07xC, TL07xAC, TL07xBC, TL07xI, TL07xM.....	19	10.2 Support Resources.....	38
6.10 Typical Characteristics: TL07xH.....	20	10.3 Trademarks.....	38
6.11 Typical Characteristics: All Devices Except TL07xH.....	27	10.4 Electrostatic Discharge Caution.....	38
<b>7 Parameter Measurement Information</b> .....	31	10.5 Glossary.....	38
		<b>11 Mechanical, Packaging, and Orderable Information</b> .....	38

## 4 Revision History

NOTE: Page numbers for previous revisions may differ from page numbers in the current version.

<b>Changes from Revision U (December 2022) to Revision V (April 2023)</b>	<b>Page</b>
• Updated <i>Overview</i> , <i>Functional Block Diagram</i> , and <i>Feature Description</i> sections .....	32

<b>Changes from Revision T (December 2021) to Revision U (December 2022)</b>	<b>Page</b>
• Changed <i>Absolute Maximum Ratings</i> , <i>ESD Ratings</i> , <i>Recommended Operating Conditions</i> , and <i>Thermal Information</i> sections by merging TL07xH and TL07xx specifications.....	12
• Changed <i>Electrical Characteristics</i> tables by merging TL07xC, TL07xAC, TL07xBC, TL07xI, and TL07xM specifications.....	17
• Changed gain bandwidth value of all non-NS/non-PS packages and non-TL07xM devices from 3 MHz to 5.25 MHz.....	17
• Changed TL07xC, TL07xAC, TL07xBC, TL07xI, and TL07xM <i>Switching Characteristics</i> tables by renaming to <i>Electrical Characteristics (AC)</i> .....	19
• Changed input voltage noise density at 1 kHz for all non-PS/non-NS packages and all non-TL07xM devices to 37 nV/√Hz .....	19
• Changed THD+N for all non-PS/non-NS packages and all non-TL07xM devices to 0.00012%.....	19

<b>Changes from Revision S (July 2021) to Revision T (December 2021)</b>	<b>Page</b>
• Corrected DCK pinout diagram and table in <i>Pin Configurations and Functions</i> section.....	5

<b>Changes from Revision R (June 2021) to Revision S (July 2021)</b>	<b>Page</b>
• Deleted preview note from TL071H SOIC (8), SOT-23 (5) and SC70 (5) packages throughout the data sheet	1

<b>Changes from Revision Q (June 2021) to Revision R (June 2021)</b>	<b>Page</b>
• Deleted preview note from TL072H SOIC (8), SOT-23 (8) and TSSOP (8) packages throughout the data sheet.....	1

• Added ESD information for TL072H.....	12
• Added I <sub>Q</sub> spec for TL072H.....	15

---

**Changes from Revision P (November 2020) to Revision Q (June 2021) Page**

• Deleted VSSOP (8) package from the <i>Device Information</i> section.....	1
• Added DBV, DCK, and D Package,s to TL071H in <i>Pin Configuration and Functions</i> section.....	5
• Deleted DGK Package, from TL072x in <i>Pin Configuration and Functions</i> section.....	5
• Deleted tables with duplicate information from the <i>Specifications</i> section.....	12
• Added D, DCK, and DBV package thermal information in Thermal Information for Single Channel: TL071H section.....	13
• Added D, DDF, and PW package thermal information in Thermal Information for Dual Channel: TL072H section.....	13
• Added I <sub>B</sub> and I <sub>OS</sub> specification for single channel DCK and DBV package.....	15
• Added I <sub>Q</sub> spec for TL071H.....	15
• Deleted <i>Related Links</i> section from the <i>Device and Documentation Support</i> section.....	38

---

**Changes from Revision O (October 2020) to Revision P (November 2020) Page**

• Added SOIC and TSSOP package thermal information in <i>Thermal Information for Quad Channel: TL074H section</i> .....	14
• Added <i>Typical Characteristics:TL07xH</i> section in <i>Specifications</i> section.....	20

---

**Changes from Revision N (July 2017) to Revision O (October 2020) Page**

• Updated the numbering format for tables, figures, and cross-references throughout the document.....	1
• Features of TL07xH added to the <i>Features</i> section.....	1
• Added link to applications in the <i>Applications</i> section.....	1
• Added TL07xH in the <i>Description</i> section.....	1
• Added TL07xH device in the <i>Device Information</i> section.....	1
• Added SOT-23 (14), VSSOP (8), SOT-23 (8), SC70 (5), and SOT-23 (5) packages to the <i>Device Information</i> section.....	1
• Added TSSOP, VSSOP and DDF Package,s to TL072x in <i>Pin Configuration and Functions</i> section.....	5
• Added DYY Package, to TL074x in <i>Pin Configuration and Functions</i> section.....	5
• Removed Table of Graphs from the <i>Typical Characteistics</i> section.....	27
• Deleted reference to obsolete documentation in <i>Layout Guidelines</i> section.....	36
• Removed <i>Related Documentation</i> section.....	38

---

**Changes from Revision M (February 2014) to Revision N (July 2017) Page**

• Updated data sheet text to latest documentation and translation standards.....	1
• Added TL072M and TL074M devices to data sheet .....	1
• Rewrote text in <i>Description</i> section .....	1
• Changed TL07x 8-pin PDIP package to 8-pin CDIP package in <i>Device Information</i> table .....	1
• Deleted 20-pin LCCC package from <i>Device Information</i> table .....	1
• Added 2017 copyright statement to front page schematic.....	1
• Deleted TL071x FK (LCCC) pinout drawing and pinout table in <i>Pin Configurations and Functions</i> section .....	5
• Updated pinout diagrams and pinout tables in <i>Pin Configurations and Functions</i> section .....	5
• Added <a href="#">Figure 6-59</a> to <i>Typical Characteristics</i> section.....	27
• Added second <i>Typical Application</i> section application curves .....	34
• Changed document references in <i>Layout Guidelines</i> section .....	36

---

**Changes from Revision L (February 2014) to Revision M (February 2014)**

**Page**

- Added *Device Information* table, *Pin Configuration and Functions* section, *ESD Ratings* table, *Feature Description* section, *Device Functional Modes, Application and Implementation* section, *Power Supply Recommendations* section, *Layout* section..... 1
-

## 5 Pin Configuration and Functions



**Figure 5-1. TL071H DBV Package,  
5-Pin SOT-23  
(Top View)**



**Figure 5-2. TL071H DCK Package,  
5-Pin SC70  
(Top View)**



NC- no internal connection

**Figure 5-3. TL071H D Package,  
8-Pin SOIC  
(Top View)**

**Table 5-1. Pin Functions: TL071H**

NAME	PIN			I/O	DESCRIPTION
	DBV	DCK	D		
IN-	4	3	2	I	Inverting input
IN+	3	1	3	I	Noninverting input
NC	—	—	8	—	Do not connect
NC	—	—	1	—	Do not connect
NC	—	—	5	—	Do not connect
OUT	1	4	6	O	Output
VCC-	2	2	4	—	Power supply
VCC+	5	5	7	—	Power supply



NC- no internal connection

**Figure 5-4. TL071x D, P, and PS Package,  
8-Pin SOIC, PDIP, and SO  
(Top View)**

**Table 5-2. Pin Functions: TL071x**

PIN		I/O	DESCRIPTION
NAME	NO.		
IN-	2	I	Inverting input
IN+	3	I	Noninverting input
NC	8	—	Do not connect
OFFSET N1	1	—	Input offset adjustment
OFFSET N2	5	—	Input offset adjustment
OUT	6	O	Output
VCC-	4	—	Power supply
VCC+	7	—	Power supply

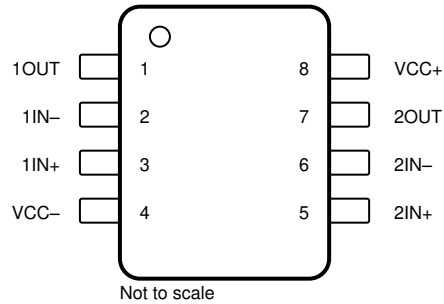

**Figure 5-5. TL072x D, DDF, JG, P, PS, and PW Package,  
8-Pin SOIC, SOT-23, CDIP, PDIP, SO, and TSSOP  
(Top View)**

**Table 5-3. Pin Functions: TL072x**

PIN		I/O	DESCRIPTION
NAME	NO.		
1IN-	2	I	Inverting input
1IN+	3	I	Noninverting input
1OUT	1	O	Output
2IN-	6	I	Inverting input
2IN+	5	I	Noninverting input
2OUT	7	O	Output
VCC-	4	—	Power supply
VCC+	8	—	Power supply

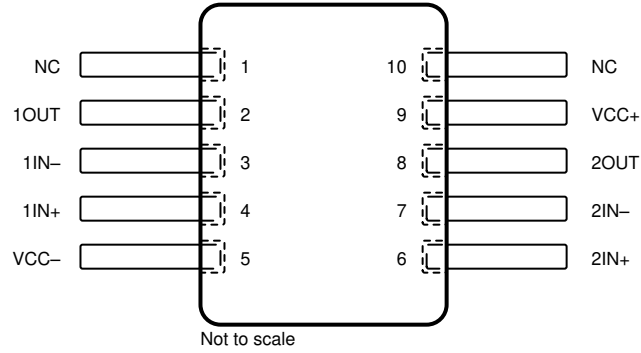

NC- no internal connection

**Figure 5-6. TL072x U Package,  
10-Pin CFP  
(Top View)**

**Table 5-4. Pin Functions: TL072x**

PIN		I/O	DESCRIPTION
NAME	NO.		
1IN-	3	I	Inverting input
1IN+	4	I	Noninverting input
1OUT	2	O	Output
2IN-	7	I	Inverting input
2IN+	6	I	Noninverting input
2OUT	8	O	Output
NC	1, 10	—	Do not connect
VCC-	5	—	Power supply
VCC+	9	—	Power supply





NC- no internal connection

**Figure 5-7. TL072 FK Package,  
20-Pin LCCC  
(Top View)**

**Table 5-5. Pin Functions: TL072x**

PIN		I/O	DESCRIPTION
NAME	NO.		
1IN-	5	I	Inverting input
1IN+	7	I	Noninverting input
1OUT	2	O	Output
2IN-	15	I	Inverting input
2IN+	12	I	Noninverting input
2OUT	17	O	Output
NC	1, 3, 4, 6, 8, 9, 11, 13, 14, 16, 18, 19	—	Do not connect
VCC-	10	—	Power supply
VCC+	20	—	Power supply



**Figure 5-8. TL074x D, N, NS, PW, J, DYY, and W Package,  
 14-Pin SOIC, PDIP, SO, TSSOP, CDIP, SOT-23, and CFP  
 (Top View)**

**Table 5-6. Pin Functions: TL074x**

PIN		I/O	DESCRIPTION
NAME	NO.		
1IN-	2	I	Inverting input
1IN+	3	I	Noninverting input
1OUT	1	O	Output
2IN-	6	I	Inverting input
2IN+	5	I	Noninverting input
2OUT	7	O	Output
3IN-	9	I	Inverting input
3IN+	10	I	Noninverting input
3OUT	8	O	Output
4IN-	13	I	Inverting input
4IN+	12	I	Noninverting input
4OUT	14	O	Output
V <sub>CC-</sub>	11	—	Power supply
V <sub>CC+</sub>	4	—	Power supply



NC- no internal connection

**Figure 5-9. TL074 FK Package,  
20-Pin LCCC  
(Top View)**

**Table 5-7. Pin Functions: TL074x**

PIN		I/O	DESCRIPTION
NAME	NO.		
1IN-	3	I	Inverting input
1IN+	4	I	Noninverting input
1OUT	2	O	Output
2IN-	9	I	Inverting input
2IN+	8	I	Noninverting input
2OUT	10	O	Output
3IN-	13	I	Inverting input
3IN+	14	I	Noninverting input
3OUT	12	O	Output
4IN-	19	I	Inverting input
4IN+	18	I	Noninverting input
4OUT	20	O	Output
NC	1, 5, 7, 11, 15, 17	—	Do not connect
VCC-	16	—	Power supply
VCC+	6	—	Power supply

## 6 Specifications

### 6.1 Absolute Maximum Ratings

over operating ambient temperature range (unless otherwise noted) <sup>(1)</sup>

			MIN	MAX	UNIT
Supply voltage, $V_S = (V+) - (V-)$	All NS and PS packages; All TL07xM devices		-0.3	36	V
	All other devices		0	42	V
Signal input pins	Common-mode voltage <sup>(3)</sup>	All NS and PS packages; All TL07xM devices	$(V-) - 0.3$	$(V-) + 36$	V
		All other devices	$(V-) - 0.5$	$(V+) + 0.5$	V
	Differential voltage <sup>(3)</sup>	All NS and PS packages; All TL07xM devices <sup>(4)</sup>	$(V-) - 0.3$	$(V-) + 36$	V
		All other devices		$V_S + 0.2$	V
Current <sup>(3)</sup>	All NS and PS packages; All TL07xM devices		50	mA	
	All other devices		-10	10	mA
Output short-circuit <sup>(2)</sup>			Continuous		
Operating ambient temperature, $T_A$			-55	150	°C
Junction temperature, $T_J$				150	°C
Case temperature for 60 seconds - FK package				260	°C
Lead temperature 1.8 mm (1/16 inch) from case for 10 seconds				300	°C
Storage temperature, $T_{stg}$			-65	150	°C

- (1) Stresses beyond those listed under *Absolute Maximum Ratings* may cause permanent damage to the device. These are stress ratings only, which do not imply functional operation of the device at these or any other conditions beyond those indicated under *Recommended Operating Conditions*. Exposure to absolute-maximum-rated conditions for extended periods may affect device reliability.
- (2) Short-circuit to ground, one amplifier per package.
- (3) Input pins are diode-clamped to the power-supply rails. Input signals that can swing more than 0.5 V beyond the supply rails must be current limited to 10 mA or less.
- (4) Differential voltage only limited by input voltage.

### 6.2 ESD Ratings

			VALUE	UNIT
$V_{(ESD)}$	Electrostatic discharge	Human-body model (HBM), per ANSI/ESDA/JEDEC JS-001 <sup>(1)</sup>	±2000	V
		Charged-device model (CDM), per JEDEC specification JESD22-C101 <sup>(2)</sup>	±1000	

- (1) JEDEC document JEP155 states that 500-V HBM allows safe manufacturing with a standard ESD control process.
- (2) JEDEC document JEP157 states that 250-V CDM allows safe manufacturing with a standard ESD control process.

### 6.3 Recommended Operating Conditions

over operating ambient temperature range (unless otherwise noted)

			MIN	MAX	UNIT
$V_S$	Supply voltage, $(V+) - (V-)$	All NS and PS packages; All TL07xM devices <sup>(1)</sup>	10	30	V
		All other devices	4.5	40	V
$V_I$	Input voltage range	All NS and PS packages; All TL07xM devices	$(V-) + 2$	$(V+) + 0.1$	V
		All other devices	$(V-) + 4$	$(V+) + 0.1$	V
$T_A$	Specified temperature	TL07xM	-55	125	°C
		TL07xH	-40	125	°C
		TL07xI	-40	85	°C
		TL07xC	0	70	°C

- (1)  $V+$  and  $V-$  are not required to be of equal magnitude, provided that the total  $V_S$  ( $V+ - V-$ ) is between 10 V and 30 V.

## 6.4 Thermal Information for Single Channel

THERMAL METRIC <sup>(1)</sup>		TL071xx					UNIT
		D (SOIC)	DCK (SC70)	DBV (SOT-23)	P (PDIP)	PS (SO)	
		8 PINS	5 PINS	5 PINS	8 PINS	8 PINS	
R <sub>θJA</sub>	Junction-to-ambient thermal resistance	158.8	217.5	212.2	85	95	°C/W
R <sub>θJC(top)</sub>	Junction-to-case (top) thermal resistance	98.6	113.1	111.1	–	–	°C/W
R <sub>θJB</sub>	Junction-to-board thermal resistance	102.3	63.8	79.4	–	–	°C/W
ψ <sub>JT</sub>	Junction-to-top characterization parameter	45.8	34.8	51.8	–	–	°C/W
ψ <sub>JB</sub>	Junction-to-board characterization parameter	101.5	63.5	79.0	–	–	°C/W
R <sub>θJC(bot)</sub>	Junction-to-case (bottom) thermal resistance	N/A	N/A	N/A	N/A	N/A	°C/W

(1) For more information about traditional and new thermal metrics, see the *Semiconductor and IC Package Thermal Metrics* application report, [SPRA953](#).

## 6.5 Thermal Information for Dual Channel

THERMAL METRIC <sup>(1)</sup>		TL072xx								UNIT
		D (SOIC)	DDF (SOT-23)	FK (LCCC)	JG (CDIP)	P (PDIP)	PS (SO)	PW (TSSOP)	U (CFP)	
		8 PINS	8 PINS	20 PINS	8 PINS	8 PINS	8 PINS	8 PINS	10 PINS	
R <sub>θJA</sub>	Junction-to-ambient thermal resistance	147.8	181.5	–	–	85	95	200.3	169.8	°C/W
R <sub>θJC(top)</sub>	Junction-to-case (top) thermal resistance	88.2	112.5	5.61	15.05	–	–	89.4	62.1	°C/W
R <sub>θJB</sub>	Junction-to-board thermal resistance	91.4	98.2	–	–	–	–	131.0	176.2	°C/W
ψ <sub>JT</sub>	Junction-to-top characterization parameter	36.8	17.2	–	–	–	–	22.2	48.4	°C/W
ψ <sub>JB</sub>	Junction-to-board characterization parameter	90.6	97.6	–	–	–	–	129.3	144.1	°C/W
R <sub>θJC(bot)</sub>	Junction-to-case (bottom) thermal resistance	N/A	N/A	–	–	–	–	N/A	5.4	°C/W

(1) For more information about traditional and new thermal metrics, see the *Semiconductor and IC Package Thermal Metrics* application report, [SPRA953](#).

## 6.6 Thermal Information for Quad Channel

THERMAL METRIC <sup>(1)</sup>		TL074xx								UNIT
		D (SOIC)	DYY (SOT-23)	FK (TSSOP)	J (TSSOP)	N (TSSOP)	NS (TSSOP)	PW (TSSOP)	W (TSSOP)	
		14 PINS	14 PINS	20 PINS	14 PINS	14 PINS	14 PINS	14 PINS	14 PINS	
R <sub>θJA</sub>	Junction-to-ambient thermal resistance	114.2	153.2	–	–	80	76	–	128.8	°C/W
R <sub>θJC(top)</sub>	Junction-to-case (top) thermal resistance	70.3	88.7	5.61	14.5	–	–	14.5	56.1	°C/W
R <sub>θJB</sub>	Junction-to-board thermal resistance	70.2	65.4	–	–	–	–	–	127.6	°C/W
ψ <sub>JT</sub>	Junction-to-top characterization parameter	28.8	9.5	–	–	–	–	–	29	°C/W
ψ <sub>JB</sub>	Junction-to-board characterization parameter	69.8	65.0	–	–	–	–	–	106.1	°C/W
R <sub>θJC(bot)</sub>	Junction-to-case (bottom) thermal resistance	N/A	N/A	–	–	–	–	–	0.5	°C/W

- (1) For more information about traditional and new thermal metrics, see the *Semiconductor and IC Package Thermal Metrics* application report, [SPRA953](#).

## 6.7 Electrical Characteristics: TL07xH

For  $V_S = (V_{CC+}) - (V_{CC-}) = 4.5\text{ V to }40\text{ V}$  ( $\pm 2.25\text{ V to } \pm 20\text{ V}$ ) at  $T_A = 25^\circ\text{C}$ ,  $R_L = 10\text{ k}\Omega$  connected to  $V_S / 2$ ,  $V_{CM} = V_S / 2$ , and  $V_{O\text{ UT}} = V_S / 2$ , unless otherwise noted.

PARAMETER		TEST CONDITIONS		MIN	TYP	MAX	UNIT	
<b>OFFSET VOLTAGE</b>								
$V_{OS}$	Input offset voltage				$\pm 1$	$\pm 4$	mV	
				$T_A = -40^\circ\text{C to }125^\circ\text{C}$		$\pm 5$		
$dV_{OS}/dT$	Input offset voltage drift				$\pm 2$		$\mu\text{V}/^\circ\text{C}$	
PSRR	Input offset voltage versus power supply	$V_S = 5\text{ V to }40\text{ V}$ , $V_{CM} = V_S / 2$	$T_A = -40^\circ\text{C to }125^\circ\text{C}$		$\pm 1$	$\pm 10$	$\mu\text{V}/\text{V}$	
	Channel separation			$f = 0\text{ Hz}$		10		$\mu\text{V}/\text{V}$
<b>INPUT BIAS CURRENT</b>								
$I_B$	Input bias current				$\pm 1$	$\pm 120$	pA	
				DCK and DBV packages		$\pm 1$	$\pm 300$	pA
				$T_A = -40^\circ\text{C to }125^\circ\text{C}$ (1)			$\pm 5$	nA
$I_{OS}$	Input offset current				$\pm 0.5$	$\pm 120$	pA	
				DCK and DBV packages		$\pm 0.5$	$\pm 250$	pA
				$T_A = -40^\circ\text{C to }125^\circ\text{C}$ (1)			$\pm 5$	nA
<b>NOISE</b>								
$E_N$	Input voltage noise	$f = 0.1\text{ Hz to }10\text{ Hz}$			9.2		$\mu\text{V}_{PP}$	
					1.4		$\mu\text{V}_{RMS}$	
$e_N$	Input voltage noise density	$f = 1\text{ kHz}$			37		$\text{nV}/\sqrt{\text{Hz}}$	
		$f = 10\text{ kHz}$			21			
$i_N$	Input current noise	$f = 1\text{ kHz}$			80		$\text{fA}/\sqrt{\text{Hz}}$	
<b>INPUT VOLTAGE RANGE</b>								
$V_{CM}$	Common-mode voltage range			$(V_{CC-}) + 1.5$		$(V_{CC+})$	V	
CMRR	Common-mode rejection ratio	$V_S = 40\text{ V}$ , $(V_{CC-}) + 2.5\text{ V} < V_{CM} < (V_{CC+}) - 1.5\text{ V}$		100	105		dB	
			$T_A = -40^\circ\text{C to }125^\circ\text{C}$	95			dB	
		$V_S = 40\text{ V}$ , $(V_{CC-}) + 2.5\text{ V} < V_{CM} < (V_{CC+})$		90	105		dB	
			$T_A = -40^\circ\text{C to }125^\circ\text{C}$	80			dB	
<b>INPUT CAPACITANCE</b>								
$Z_{ID}$	Differential				$100 \parallel 2$		$\text{M}\Omega \parallel \text{pF}$	
$Z_{ICM}$	Common-mode				$6 \parallel 1$		$\text{T}\Omega \parallel \text{pF}$	
<b>OPEN-LOOP GAIN</b>								
$A_{OL}$	Open-loop voltage gain	$V_S = 40\text{ V}$ , $V_{CM} = V_S / 2$ , $(V_{CC-}) + 0.3\text{ V} < V_{O} < (V_{CC+}) - 0.3\text{ V}$	$T_A = -40^\circ\text{C to }125^\circ\text{C}$	118	125		dB	
$A_{OL}$	Open-loop voltage gain	$V_S = 40\text{ V}$ , $V_{CM} = V_S / 2$ , $R_L = 2\text{ k}\Omega$ , $(V_{CC-}) + 1.2\text{ V} < V_{O} < (V_{CC+}) - 1.2\text{ V}$	$T_A = -40^\circ\text{C to }125^\circ\text{C}$	115	120		dB	
<b>FREQUENCY RESPONSE</b>								
GBW	Gain-bandwidth product				5.25		MHz	
SR	Slew rate	$V_S = 40\text{ V}$ , $G = +1$ , $C_L = 20\text{ pF}$			20		$\text{V}/\mu\text{s}$	
$t_s$	Settling time	$T_O 0.1\%$ , $V_S = 40\text{ V}$ , $V_{STEP} = 10\text{ V}$ , $G = +1$ , $C_L = 20\text{ pF}$			0.63		$\mu\text{s}$	
		$T_O 0.1\%$ , $V_S = 40\text{ V}$ , $V_{STEP} = 2\text{ V}$ , $G = +1$ , $C_L = 20\text{ pF}$			0.56			
		$T_O 0.01\%$ , $V_S = 40\text{ V}$ , $V_{STEP} = 10\text{ V}$ , $G = +1$ , $C_L = 20\text{ pF}$			0.91			
		$T_O 0.01\%$ , $V_S = 40\text{ V}$ , $V_{STEP} = 2\text{ V}$ , $G = +1$ , $C_L = 20\text{ pF}$			0.48			
	Phase margin	$G = +1$ , $R_L = 10\text{ k}\Omega$ , $C_L = 20\text{ pF}$			56		$^\circ$	
	Overload recovery time	$V_{IN} \times \text{gain} > V_S$			300		ns	
THD+N	Total harmonic distortion + noise	$V_S = 40\text{ V}$ , $V_O = 6\text{ V}_{RMS}$ , $G = +1$ , $f = 1\text{ kHz}$			0.00012		%	
EMIRR	EMI rejection ratio	$f = 1\text{ GHz}$			53		dB	
<b>OUTPUT</b>								

## 6.7 Electrical Characteristics: TL07xH (continued)

For  $V_S = (V_{CC+}) - (V_{CC-}) = 4.5 \text{ V to } 40 \text{ V}$  ( $\pm 2.25 \text{ V to } \pm 20 \text{ V}$ ) at  $T_A = 25^\circ\text{C}$ ,  $R_L = 10 \text{ k}\Omega$  connected to  $V_S / 2$ ,  $V_{CM} = V_S / 2$ , and  $V_{O UT} = V_S / 2$ , unless otherwise noted.

PARAMETER	TEST CONDITIONS		MIN	TYP	MAX	UNIT
Voltage output swing from rail	Positive rail headroom	$V_S = 40 \text{ V}, R_L = 10 \text{ k}\Omega$		115	210	mV
		$V_S = 40 \text{ V}, R_L = 2 \text{ k}\Omega$		520	965	
	Negative rail headroom	$V_S = 40 \text{ V}, R_L = 10 \text{ k}\Omega$		105	215	
		$V_S = 40 \text{ V}, R_L = 2 \text{ k}\Omega$		500	1030	
$I_{SC}$	Short-circuit current		$\pm 26$			mA
$C_{LOAD}$	Capacitive load drive			300		pF
$Z_O$	Open-loop output impedance	$f = 1 \text{ MHz}, I_O = 0 \text{ A}$		125		$\Omega$
<b>POWER SUPPLY</b>						
$I_Q$	Quiescent current per amplifier	$I_O = 0 \text{ A}$	$T_A = -40^\circ\text{C to } 125^\circ\text{C}$	937.5	1125	$\mu\text{A}$
		$I_O = 0 \text{ A}, (\text{TL071H})$		960	1156	
		$I_O = 0 \text{ A}$			1130	
		$I_O = 0 \text{ A}, (\text{TL072H})$			1143	
		$I_O = 0 \text{ A}, (\text{TL071H})$			1160	
	Turn-On Time	At $T_A = 25^\circ\text{C}, V_S = 40 \text{ V}, V_S$ ramp rate $> 0.3 \text{ V}/\mu\text{s}$		60		$\mu\text{s}$

(1) Max  $I_B$  and  $I_{OS}$  data is specified based on characterization results.



## 6.8 Electrical Characteristics (DC): TL07xC, TL07xAC, TL07xBC, TL07xI, TL07xM

For  $V_S = (V_{CC+}) - (V_{CC-}) = \pm 15\text{ V}$  at  $T_A = 25^\circ\text{C}$ , unless otherwise noted

PARAMETER		TEST CONDITIONS <sup>(1) (2)</sup>		MIN	TYP	MAX	UNIT
$V_{OS}$	Input offset voltage	$V_O = 0\text{ V}$ $R_S = 50\ \Omega$	TL07xC		3	10	mV
				$T_A = \text{Full range}$		13	
			TL07xAC		3	6	
				$T_A = \text{Full range}$		7.5	
			TL07xBC		2	3	
				$T_A = \text{Full range}$		5	
			TL07xI		3	6	
				$T_A = \text{Full range}$		8	
TL071M, TL072M		3	6				
	$T_A = \text{Full range}$		9				
TL074M		3	9				
	$T_A = \text{Full range}$		15				
$dV_{OS}/dT$	Input offset voltage drift	$V_O = 0\text{ V}$ , $R_S = 50\ \Omega$	$T_A = \text{Full range}$		$\pm 18$		$\mu\text{V}/^\circ\text{C}$
$I_{OS}$	Input offset current	$V_O = 0\text{ V}$	TL07xC		5	100	pA
				$T_A = \text{Full range}$		10	nA
			TL07xAC, TL07xBC, TL07xI		5	100	pA
				$T_A = \text{Full range}$		2	nA
			TL07xM		5	100	pA
$T_A = \text{Full range}$		20		nA			
$I_B$	Input bias current	$V_O = 0\text{ V}$	TL07xC, TL07xAC, TL07xBC, TL07xI		65	200	pA
				$T_A = \text{Full range}$		7	nA
			TL071M, TL072M		65	200	pA
				$T_A = \text{Full range}$		50	nA
			TL074M		65	200	pA
$T_A = \text{Full range}$		20	nA				
$V_{CM}$	Common-mode voltage range			$\pm 11$	-12 to 15		V
VOM	Maximum peak output voltage swing	$R_L = 10\ \text{k}\Omega$	$T_A = \text{Full range}$	$\pm 12$	$\pm 13.5$	V	
		$R_L \geq 10\ \text{k}\Omega$		$\pm 12$			
		$R_L \geq 2\ \text{k}\Omega$		$\pm 10$			
$A_{OL}$	Open-loop voltage gain	$V_O = 0\text{ V}$	TL07xC		25	200	V/mV
				$T_A = \text{Full range}$		15	
			TL07xAC, TL07xBC, TL07xI		50	200	
				$T_A = \text{Full range}$		25	
			TL07xM		35	200	
$T_A = \text{Full range}$		15					
GBW	Gain-bandwidth product	All NS and PS packages; All TL07xM devices			3	MHz	
		All other devices			5.25		
$R_{ID}$	Common-mode input resistance				1	T $\Omega$	
CMRR	Common-mode rejection ratio	$V_{IC} = V_{ICR(\text{min})}$ $V_O = 0\text{ V}$ $R_S = 50\ \Omega$	TL07xC	70	100	dB	
			TL07xAC, TL07xBC, TL07xI	75	100		
			TL07xM	80	86		
PSRR	Input offset voltage versus power supply	$V_S = \pm 9\text{ V to } \pm 18\text{ V}$ $V_O = 0\text{ V}$ $R_S = 50\ \Omega$	TL07xC	70	100	dB	
			TL07xAC, TL07xBC, TL07xI	80	100		
			TL07xM	80	86		
$I_Q$	Quiescent current per amplifier	$V_O = 0\text{ V}$ ; no load			1.4	2.5	mA

## 6.8 Electrical Characteristics (DC): TL07xC, TL07xAC, TL07xBC, TL07xI, TL07xM (continued)

For  $V_S = (V_{CC+}) - (V_{CC-}) = \pm 15\text{ V}$  at  $T_A = 25^\circ\text{C}$ , unless otherwise noted

PARAMETER	TEST CONDITIONS <sup>(1) (2)</sup>	MIN	TYP	MAX	UNIT
Channel separation	f = 0 Hz		1		$\mu\text{V/V}$

- (1) All characteristics are measured under open-loop conditions with zero common-mode voltage, unless otherwise specified.
- (2) Full range is  $T_A = 0^\circ\text{C}$  to  $70^\circ\text{C}$  for the TL07xC, TL07xAC, and TL07xBC;  $T_A = -40^\circ\text{C}$  to  $85^\circ\text{C}$  for the TL07xI; and  $T_A = -55^\circ\text{C}$  to  $125^\circ\text{C}$  for the TL07xM.

## 6.9 Electrical Characteristics (AC): TL07xC, TL07xAC, TL07xBC, TL07xI, TL07xM

For  $V_S = (V_{CC+}) - (V_{CC-}) = \pm 15\text{ V}$  at  $T_A = 25^\circ\text{C}$ , unless otherwise noted.

PARAMETER		TEST CONDITIONS		MIN	TYP	MAX	UNIT
SR	Slew rate	$V_I = 10\text{ V}$ , $C_L = 100\text{ pF}$ , $R_L = 2\text{ k}\Omega$	TL07xM	5	20		V/ $\mu\text{s}$
			TL07xC, TL07xAC, TL07xBC, TL07xI	8	20		V/ $\mu\text{s}$
$t_s$	Settling time	$V_I = 20\text{ V}$ , $C_L = 100\text{ pF}$ , $R_L = 2\text{ k}\Omega$			0.1		$\mu\text{s}$
					20%		
$e_N$	Input voltage noise density	All PS and NS packages; All TL07xM devices	$R_S = 20\ \Omega$ , $f = 1\text{ kHz}$		18		$\text{nV}/\sqrt{\text{Hz}}$
			$f = 1\text{ kHz}$		37		$\text{nV}/\sqrt{\text{Hz}}$
			$f = 10\text{ kHz}$		21		
$E_N$	Input voltage noise	All PS and NS packages; All TL07xM devices	$R_S = 20\ \Omega$ , $f = 10\text{ Hz to } 10\text{ kHz}$		4		$\mu\text{V}_{\text{RMS}}$
			All other devices	$f = 0.1\text{ Hz to } 10\text{ Hz}$		1.4	
$i_N$	Input current noise		$R_S = 20\ \Omega$ , $f = 1\text{ kHz}$		10		$\text{fA}/\sqrt{\text{Hz}}$
	Phase margin	TL07xC, TL07xAC, TL07xBC, TL07xI	$G = +1$ , $R_L = 10\text{ k}\Omega$ , $C_L = 20\text{ pF}$		56		$^\circ$
	Overload recovery time		$V_{\text{IN}} \times \text{gain} > V_S$		300		ns
THD+N	Total harmonic distortion + noise	All PS and NS packages; All TL07xM devices	$V_O = 6\text{ V}_{\text{RMS}}$ , $R_L \geq 2\text{ k}\Omega$ , $f = 1\text{ kHz}$ , $G = +1$ , $R_S \leq 1\text{ k}\Omega$		0.003		%
			All other devices	$V_S = 40\text{ V}$ , $V_O = 6\text{ V}_{\text{RMS}}$ , $G = +1$ , $f = 1\text{ kHz}$		0.00012	
EMIRR	EMI rejection ratio	TL07xC, TL07xAC, TL07xBC, TL07xI	$f = 1\text{ GHz}$		53		dB
$Z_O$	Open-loop output impedance	TL07xC, TL07xAC, TL07xBC, TL07xI	$f = 1\text{ MHz}$ , $I_O = 0\text{ A}$		125		$\Omega$

## 6.10 Typical Characteristics: TL07xH

at  $T_A = 25^\circ\text{C}$ ,  $V_S = 40\text{ V}$  ( $\pm 20\text{ V}$ ),  $V_{CM} = V_S / 2$ ,  $R_{LOAD} = 10\text{ k}\Omega$  connected to  $V_S / 2$ , and  $C_L = 20\text{ pF}$  (unless otherwise noted)

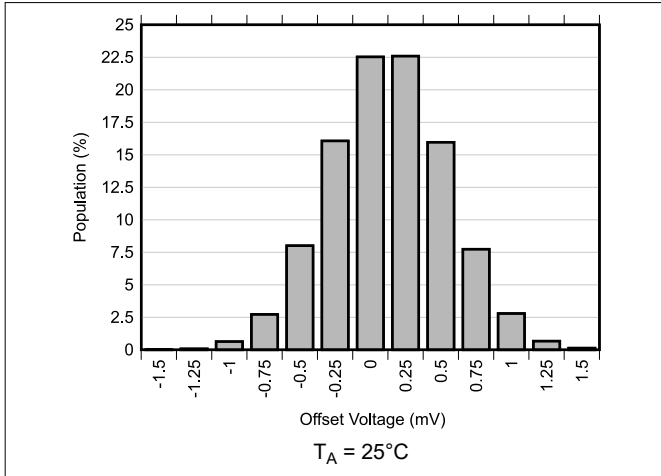

**Figure 6-1. Offset Voltage Production Distribution**

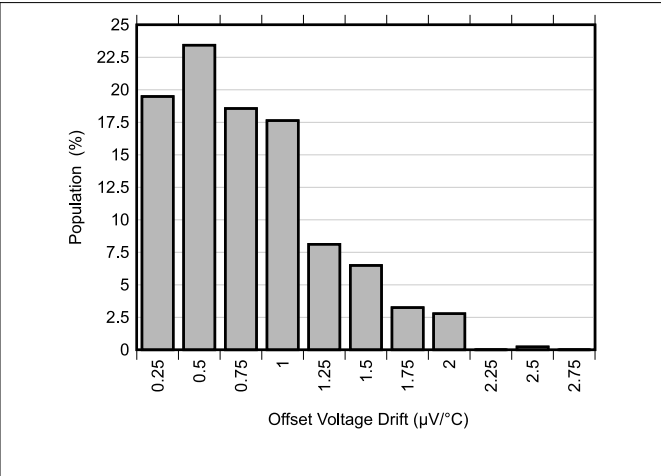

**Figure 6-2. Offset Voltage Drift Distribution**

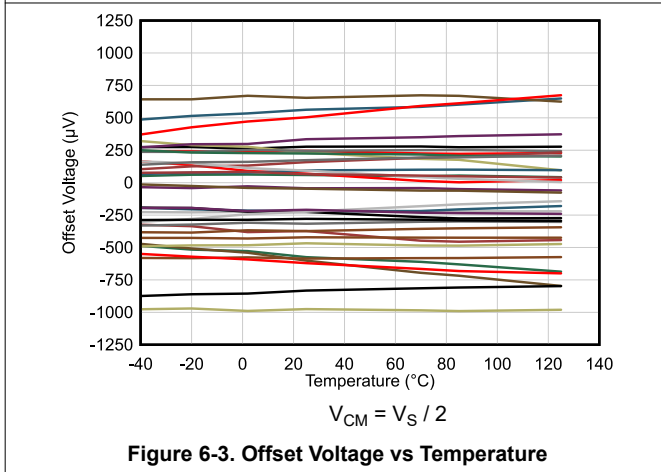

**Figure 6-3. Offset Voltage vs Temperature**

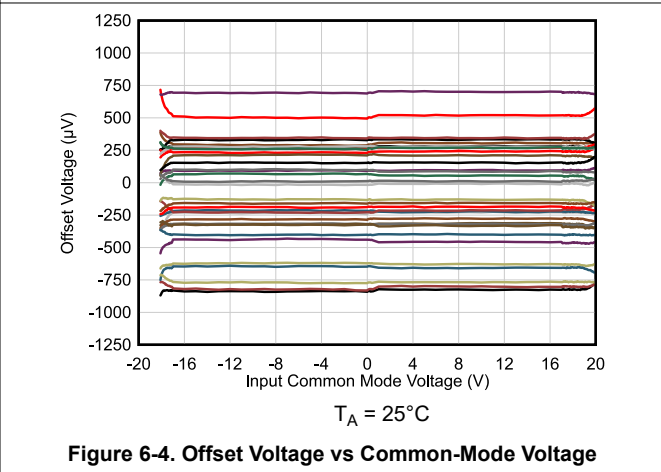

**Figure 6-4. Offset Voltage vs Common-Mode Voltage**

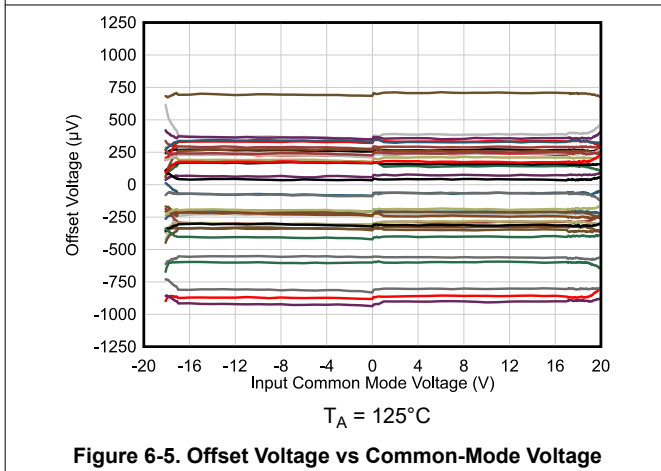

**Figure 6-5. Offset Voltage vs Common-Mode Voltage**

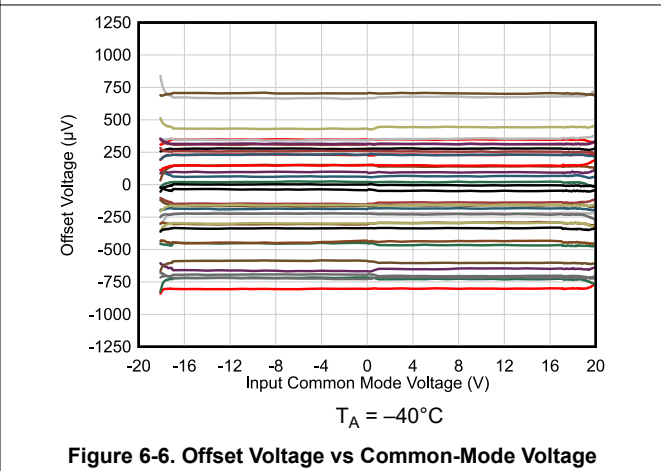

**Figure 6-6. Offset Voltage vs Common-Mode Voltage**

### 6.10 Typical Characteristics: TL07xH (continued)

at  $T_A = 25^\circ\text{C}$ ,  $V_S = 40\text{ V}$  ( $\pm 20\text{ V}$ ),  $V_{CM} = V_S / 2$ ,  $R_{LOAD} = 10\text{ k}\Omega$  connected to  $V_S / 2$ , and  $C_L = 20\text{ pF}$  (unless otherwise noted)

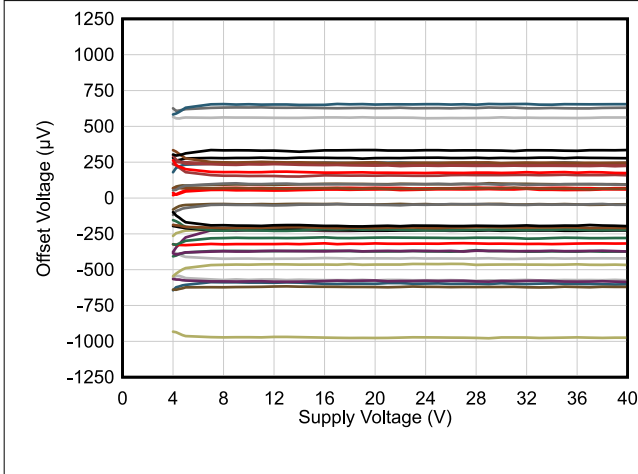

Figure 6-7. Offset Voltage vs Power Supply

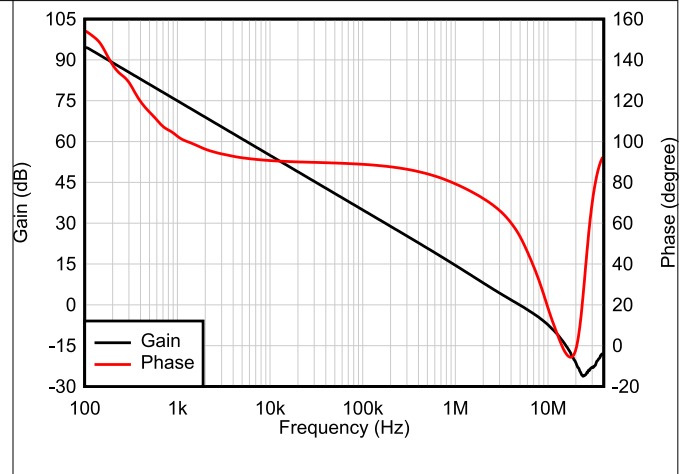

Figure 6-8. Open-Loop Gain and Phase vs Frequency

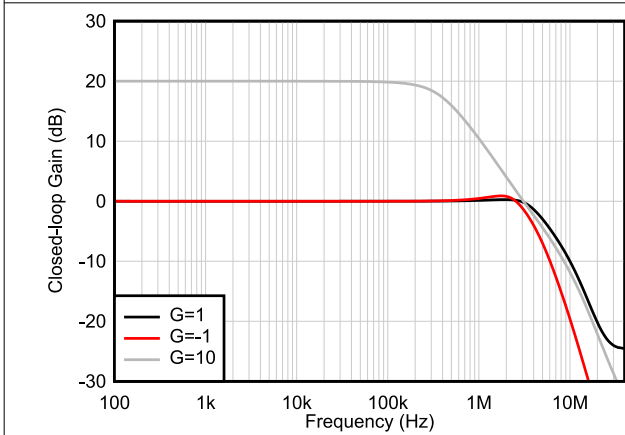

Figure 6-9. Closed-Loop Gain vs Frequency

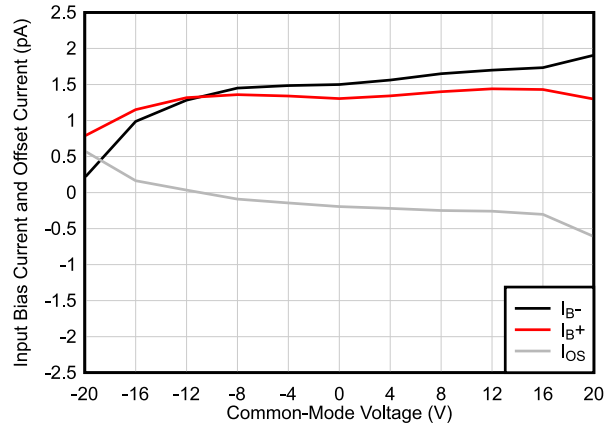

Figure 6-10. Input Bias Current vs Common-Mode Voltage

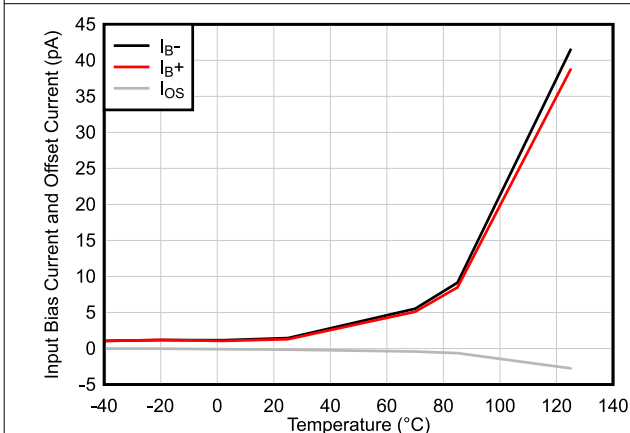

Figure 6-11. Input Bias Current vs Temperature

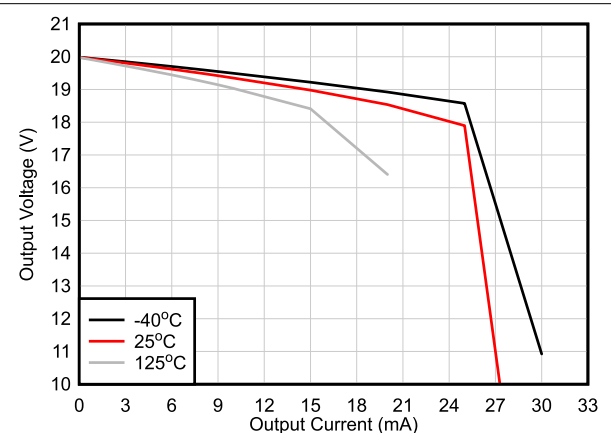

Figure 6-12. Output Voltage Swing vs Output Current (Sourcing)

## 6.10 Typical Characteristics: TL07xH (continued)

at  $T_A = 25^\circ\text{C}$ ,  $V_S = 40\text{ V}$  ( $\pm 20\text{ V}$ ),  $V_{CM} = V_S / 2$ ,  $R_{LOAD} = 10\text{ k}\Omega$  connected to  $V_S / 2$ , and  $C_L = 20\text{ pF}$  (unless otherwise noted)

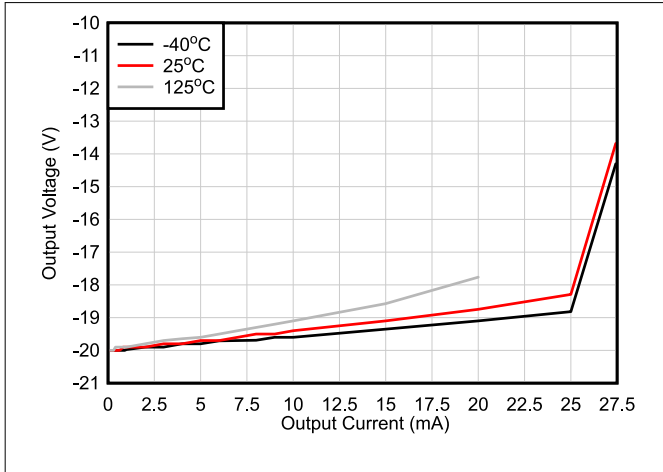

Figure 6-13. Output Voltage Swing vs Output Current (Sinking)



Figure 6-14. CMRR and PSRR vs Frequency

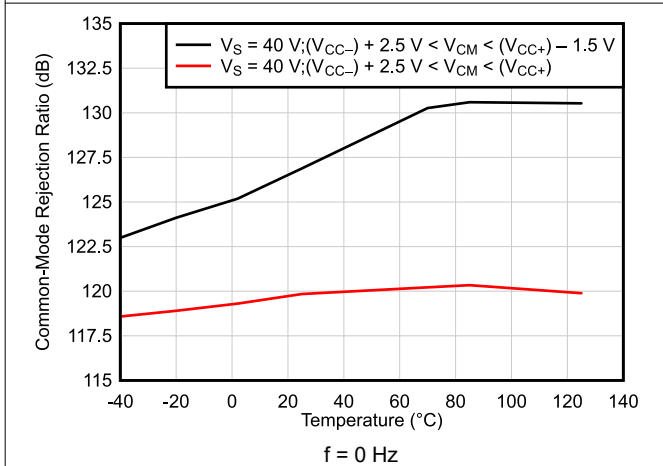

Figure 6-15. CMRR vs Temperature (dB)

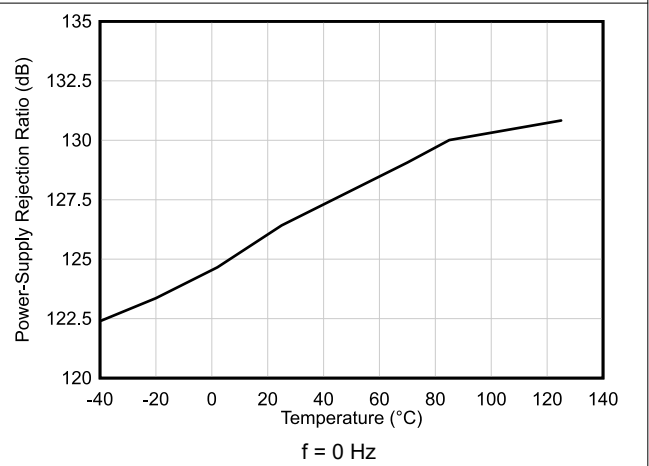

Figure 6-16. PSRR vs Temperature (dB)

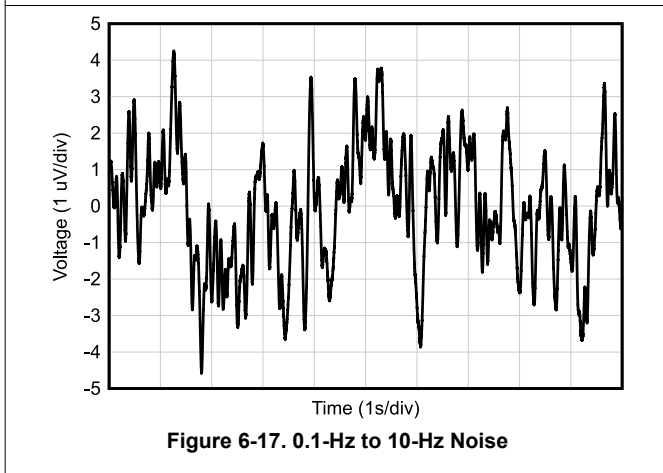

Figure 6-17. 0.1-Hz to 10-Hz Noise

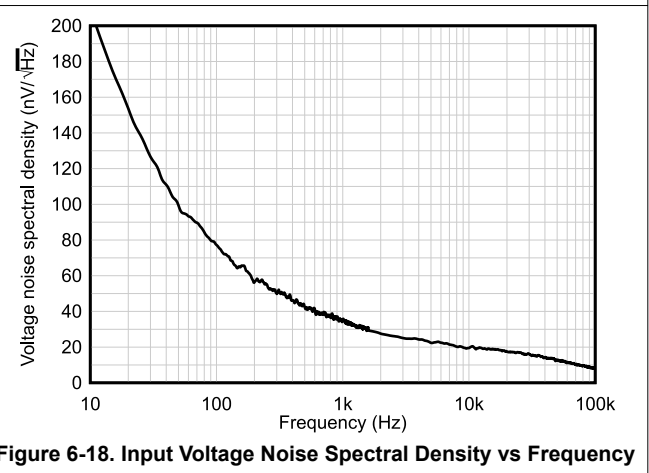
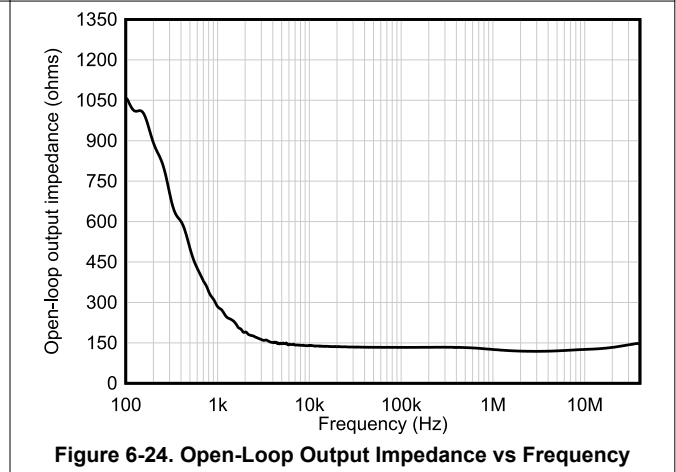
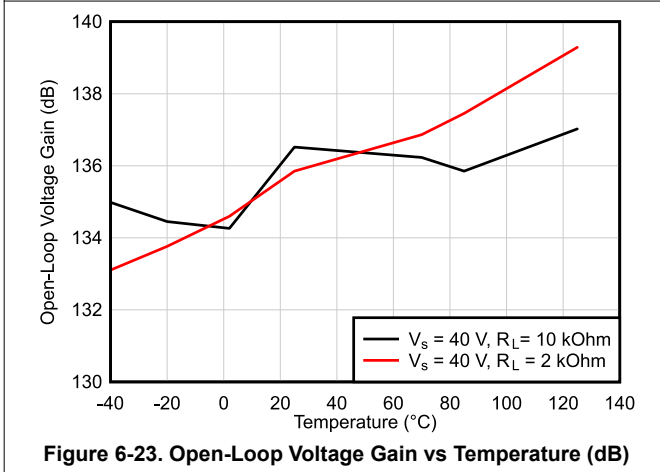
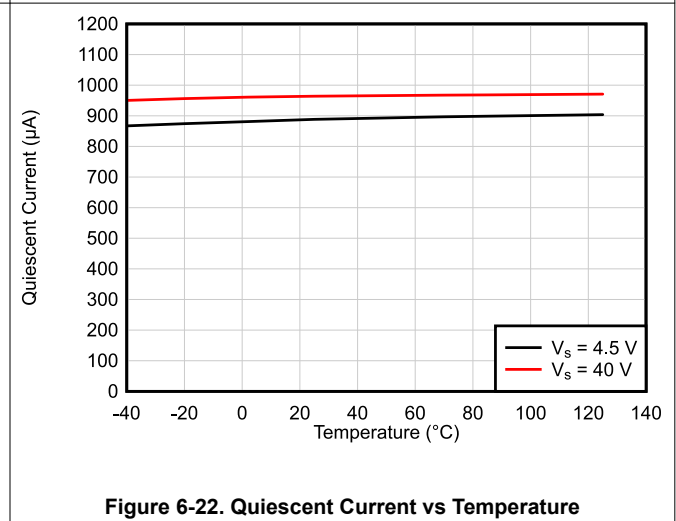
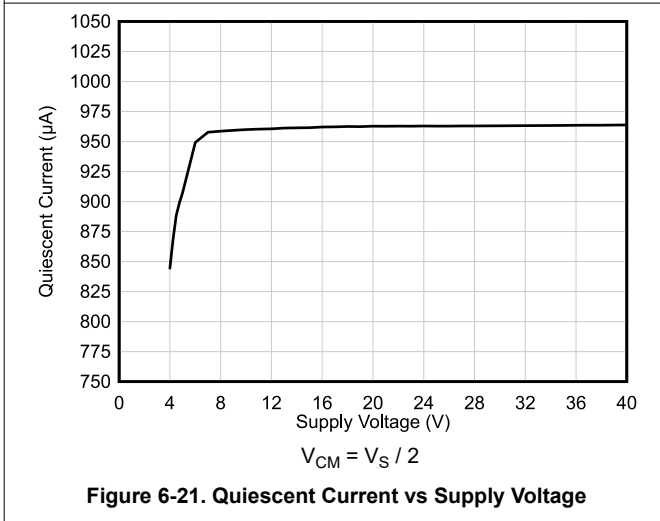
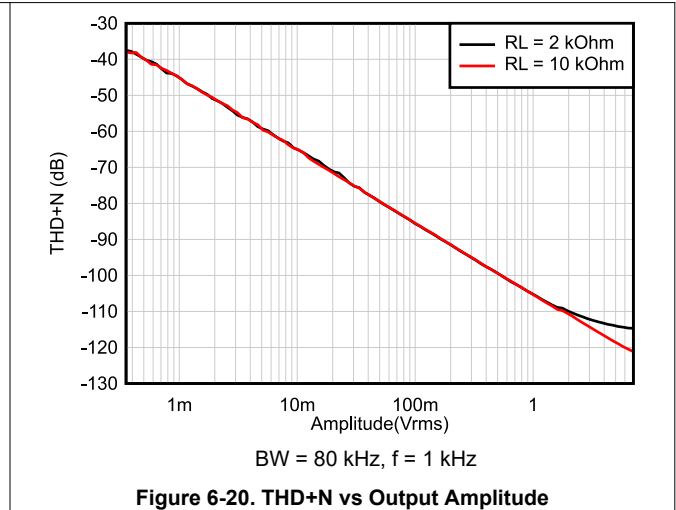
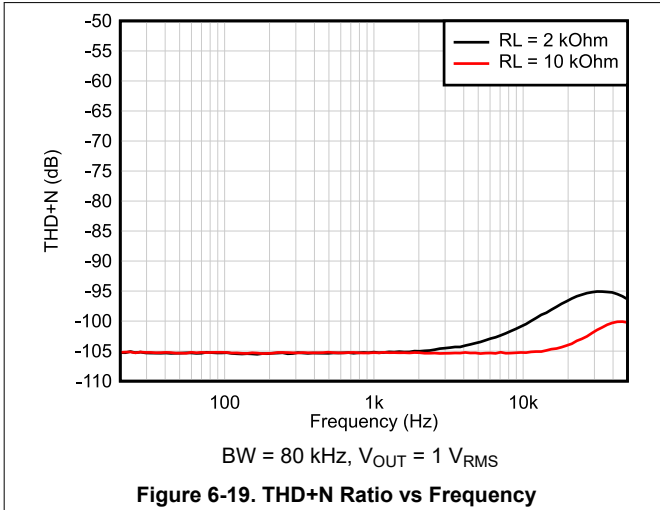

Figure 6-18. Input Voltage Noise Spectral Density vs Frequency

### 6.10 Typical Characteristics: TL07xH (continued)

at  $T_A = 25^\circ\text{C}$ ,  $V_S = 40\text{ V}$  ( $\pm 20\text{ V}$ ),  $V_{CM} = V_S / 2$ ,  $R_{LOAD} = 10\text{ k}\Omega$  connected to  $V_S / 2$ , and  $C_L = 20\text{ pF}$  (unless otherwise noted)



## 6.10 Typical Characteristics: TL07xH (continued)

at  $T_A = 25^\circ\text{C}$ ,  $V_S = 40\text{ V}$  ( $\pm 20\text{ V}$ ),  $V_{CM} = V_S / 2$ ,  $R_{LOAD} = 10\text{ k}\Omega$  connected to  $V_S / 2$ , and  $C_L = 20\text{ pF}$  (unless otherwise noted)

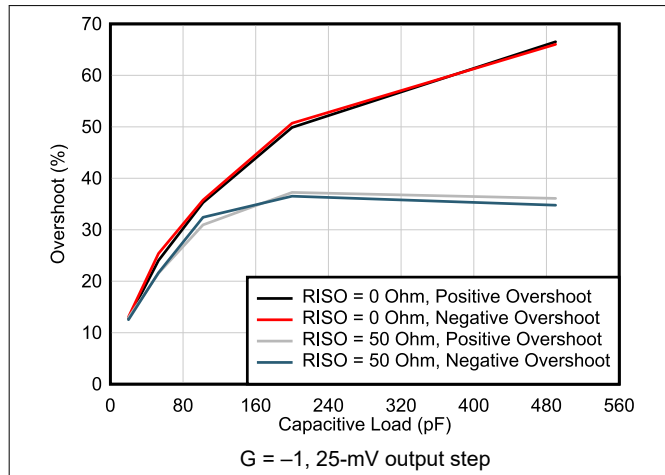

Figure 6-25. Small-Signal Overshoot vs Capacitive Load

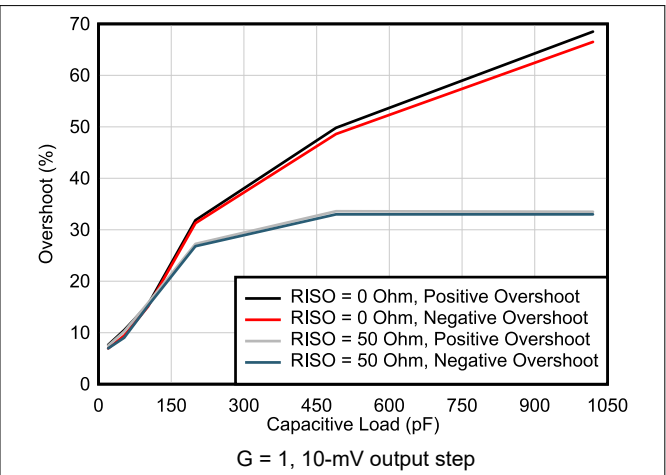

Figure 6-26. Small-Signal Overshoot vs Capacitive Load

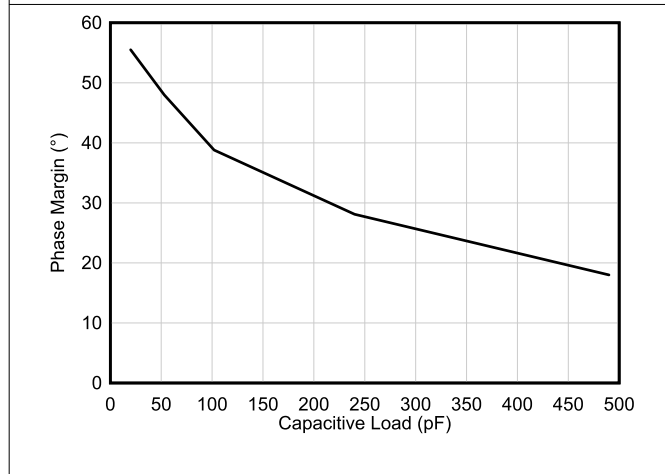

Figure 6-27. Phase Margin vs Capacitive Load

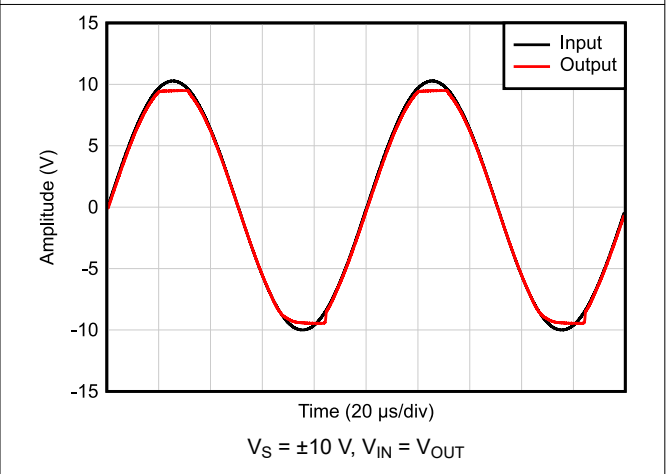

Figure 6-28. No Phase Reversal

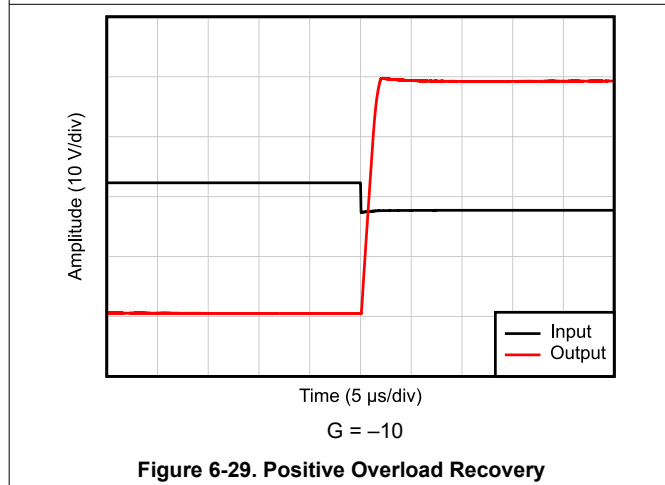

Figure 6-29. Positive Overload Recovery

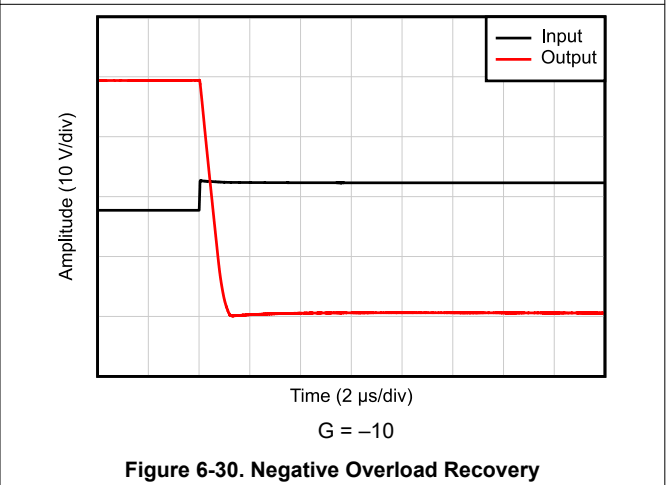

Figure 6-30. Negative Overload Recovery



## 6.10 Typical Characteristics: TL07xH (continued)

at  $T_A = 25^\circ\text{C}$ ,  $V_S = 40\text{ V}$  ( $\pm 20\text{ V}$ ),  $V_{CM} = V_S / 2$ ,  $R_{LOAD} = 10\text{ k}\Omega$  connected to  $V_S / 2$ , and  $C_L = 20\text{ pF}$  (unless otherwise noted)



$C_L = 20\text{ pF}$ ,  $G = 1$ , 10-mV step response  
**Figure 6-31. Small-Signal Step Response, Rising**

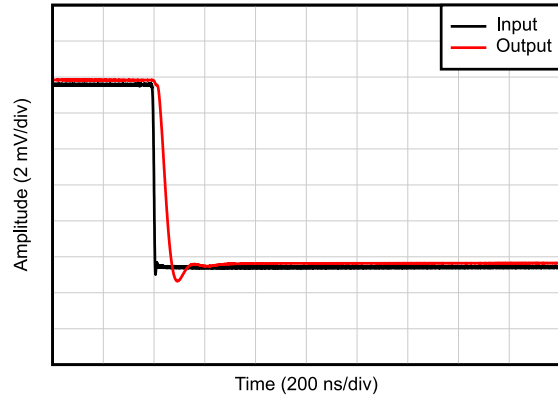

$C_L = 20\text{ pF}$ ,  $G = 1$ , 10-mV step response  
**Figure 6-32. Small-Signal Step Response, Falling**

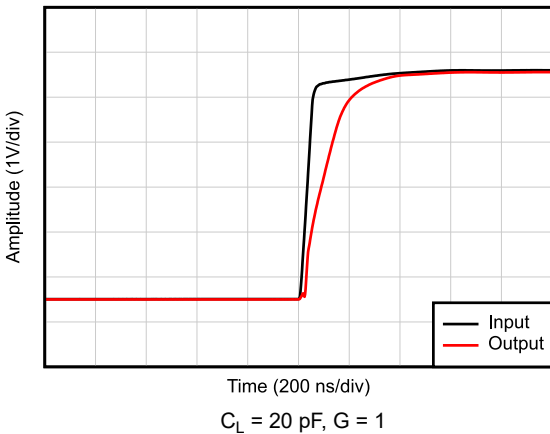

$C_L = 20\text{ pF}$ ,  $G = 1$   
**Figure 6-33. Large-Signal Step Response (Rising)**

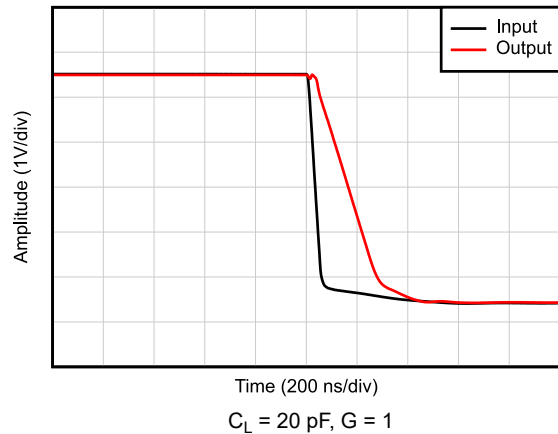

$C_L = 20\text{ pF}$ ,  $G = 1$   
**Figure 6-34. Large-Signal Step Response (Falling)**

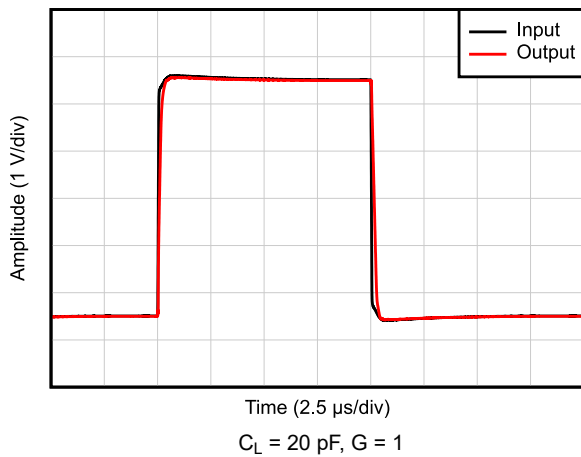

$C_L = 20\text{ pF}$ ,  $G = 1$   
**Figure 6-35. Large-Signal Step Response**

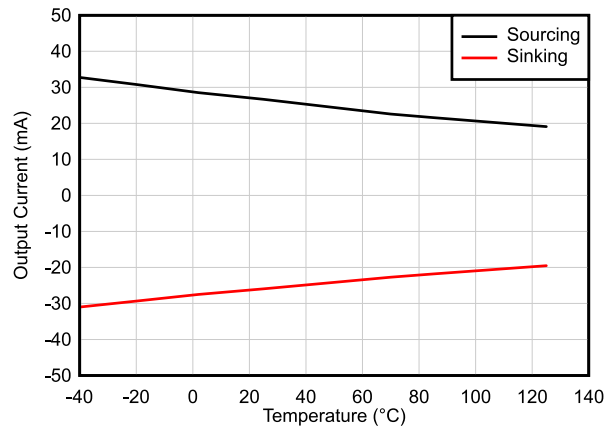

**Figure 6-36. Short-Circuit Current vs Temperature**

## 6.10 Typical Characteristics: TL07xH (continued)

at  $T_A = 25^\circ\text{C}$ ,  $V_S = 40\text{ V}$  ( $\pm 20\text{ V}$ ),  $V_{CM} = V_S / 2$ ,  $R_{LOAD} = 10\text{ k}\Omega$  connected to  $V_S / 2$ , and  $C_L = 20\text{ pF}$  (unless otherwise noted)



### 6.11 Typical Characteristics: All Devices Except TL07xH



Figure 6-40. Input Bias Current vs Free-Air Temperature

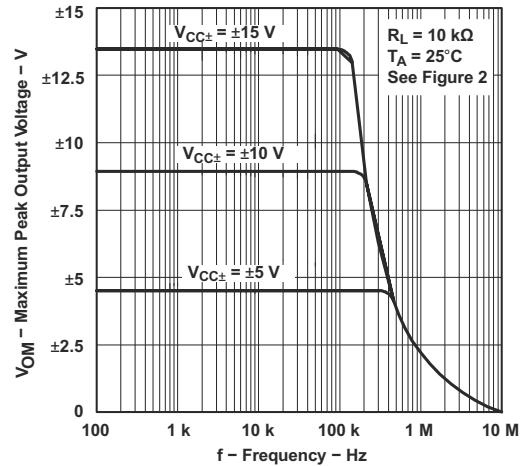

Figure 6-41. Maximum Peak Output Voltage vs Frequency



Figure 6-42. Maximum Peak Output Voltage vs Frequency

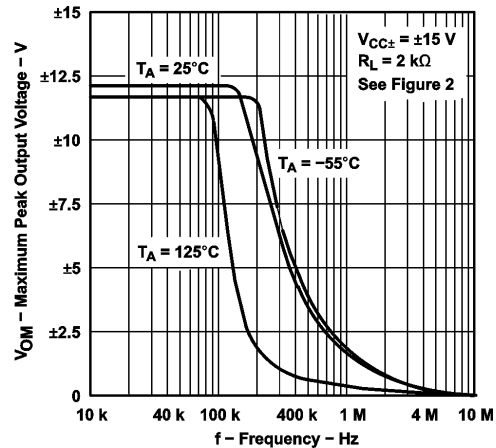

Figure 6-43. Maximum Peak Output Voltage vs Frequency

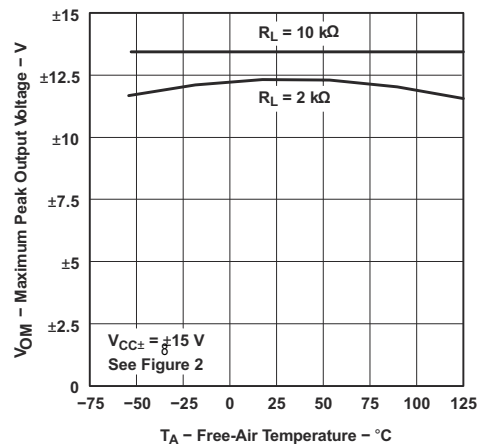

Figure 6-44. Maximum Peak Output Voltage vs Free-Air Temperature

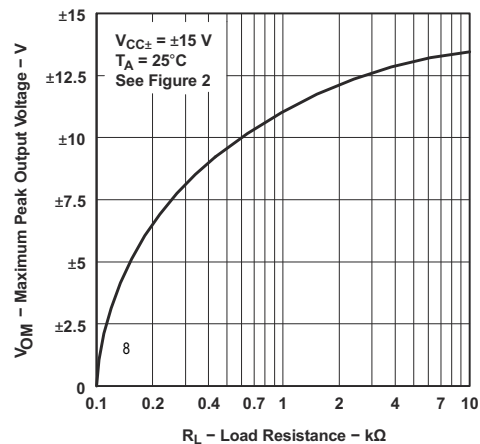
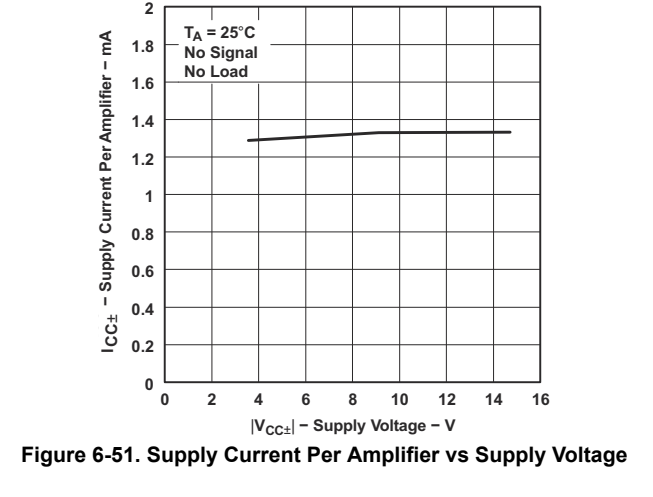
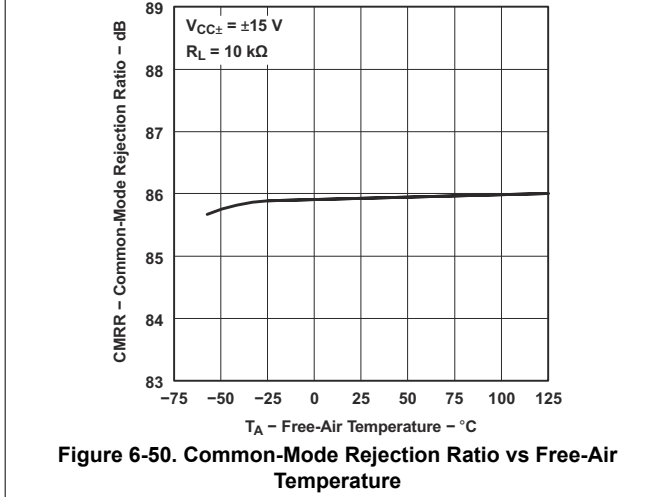
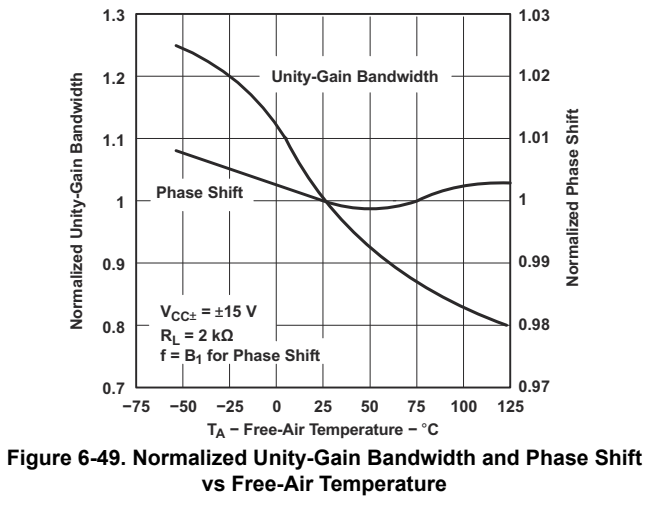
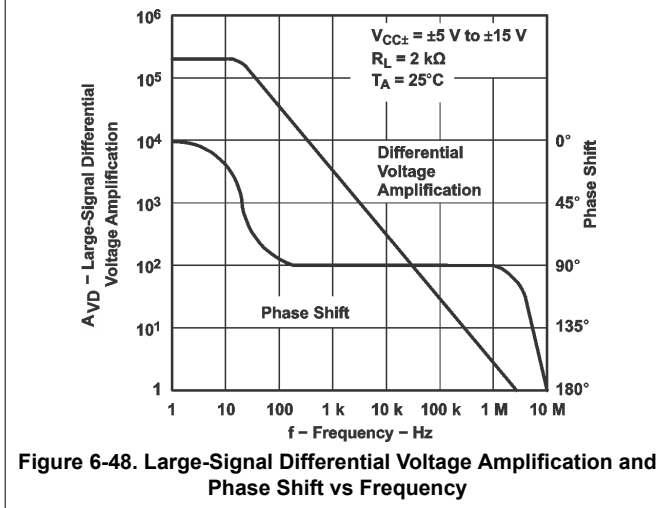
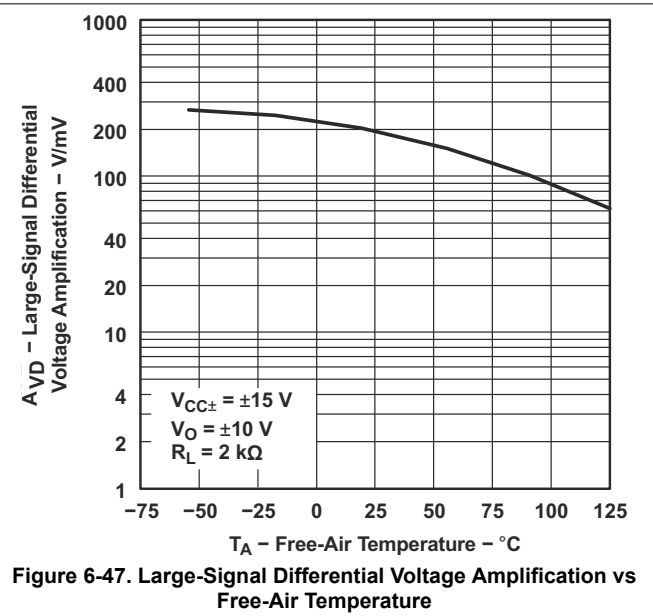
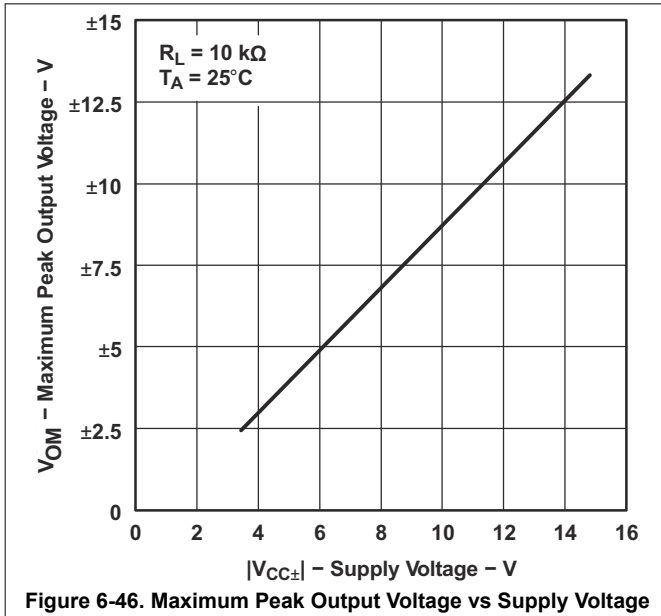
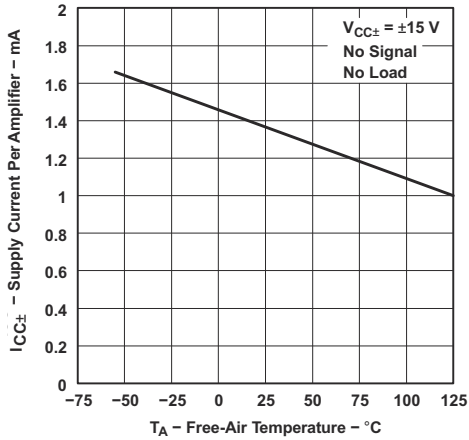

Figure 6-45. Maximum Peak Output Voltage vs Load Resistance

### 6.11 Typical Characteristics: All Devices Except TL07xH (continued)



**6.11 Typical Characteristics: All Devices Except TL07xH (continued)**



**Figure 6-52. Supply Current Per Amplifier vs Free-Air Temperature**

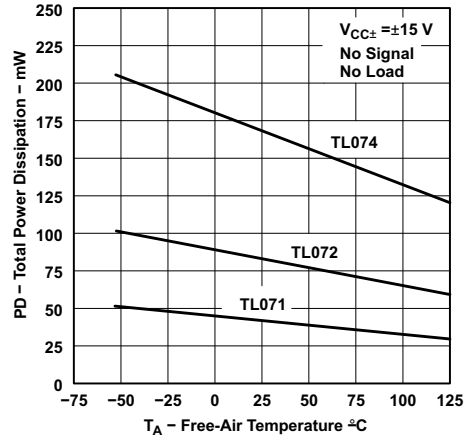

**Figure 6-53. Total Power Dissipation vs Free-Air Temperature**

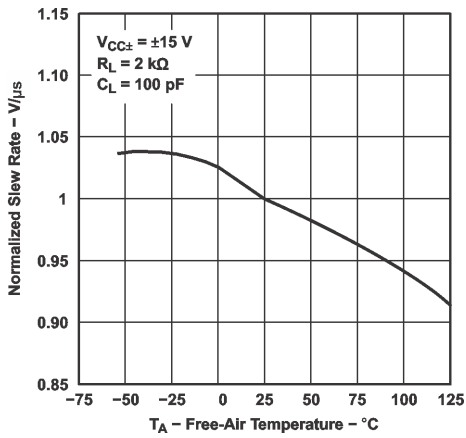

**Figure 6-54. Normalized Slew Rate vs Free-Air Temperature**

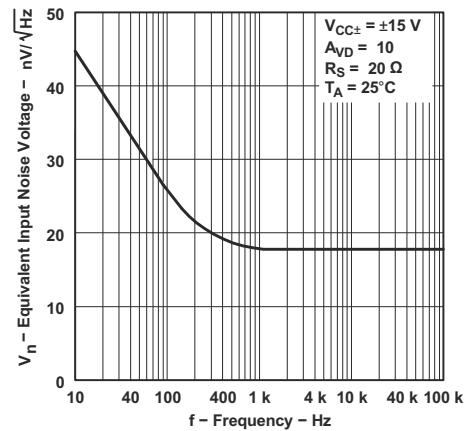

**Figure 6-55. Equivalent Input Noise Voltage vs Frequency**

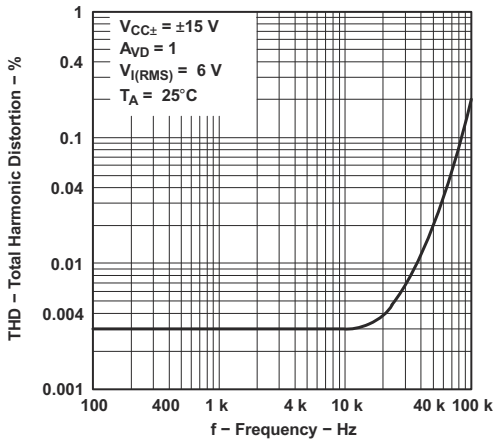

**Figure 6-56. Total Harmonic Distortion vs Frequency**

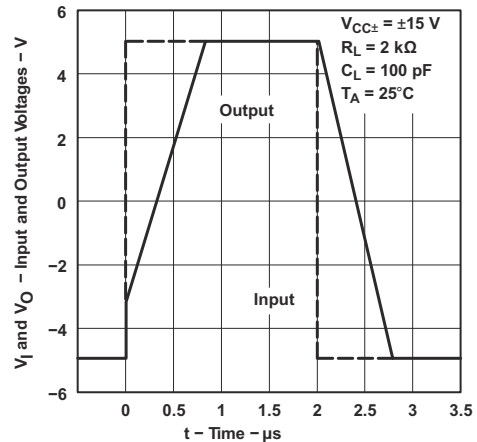

**Figure 6-57. Voltage-Follower Large-Signal Pulse Response**

### 6.11 Typical Characteristics: All Devices Except TL07xH (continued)

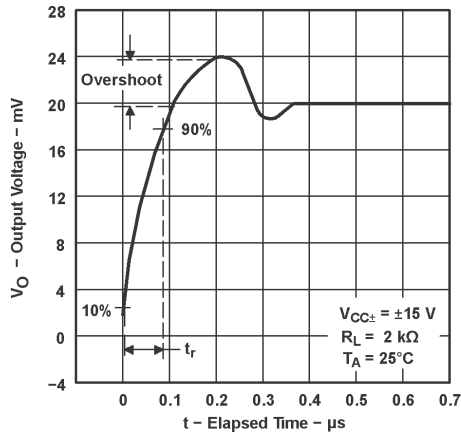

Figure 6-58. Output Voltage vs Elapsed Time

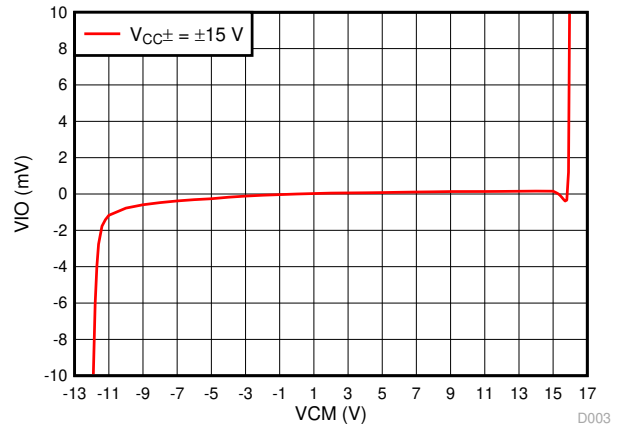

Figure 6-59.  $V_{IO}$  vs  $V_{CM}$

## 7 Parameter Measurement Information

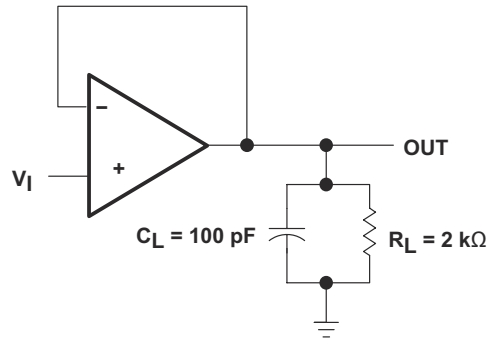

Figure 7-1. Unity-Gain Amplifier

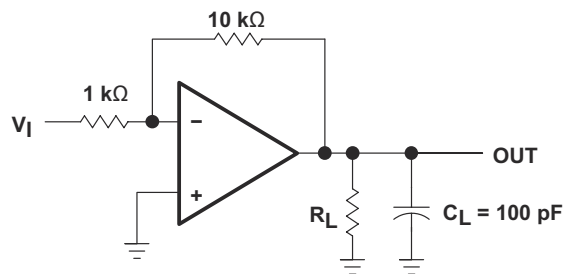

Figure 7-2. Gain-of-10 Inverting Amplifier

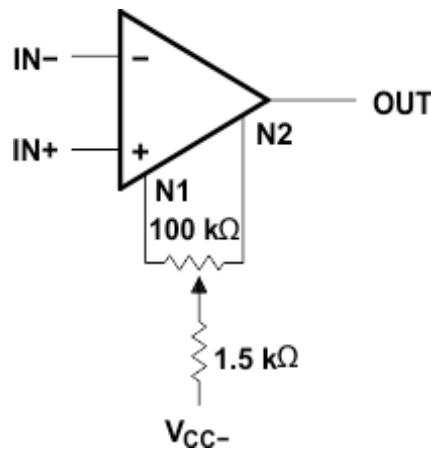

Figure 7-3. Input Offset-Voltage Null Circuit

## 8 Detailed Description

### 8.1 Overview

The TL07xH (TL071H, TL072H, and TL074H) family of devices are the next-generation versions of the industry-standard TL07x (TL071, TL072, and TL074) devices. These devices provide outstanding value for cost-sensitive applications, with features including low offset (1 mV, typical), high slew rate (20 V/μs, typical), and common-mode input to the positive supply. High ESD (2 kV, HBM), integrated EMI and RF filters, and operation across the full –40°C to 125°C enable the TL07xH devices to be used in the most rugged and demanding applications.

The C-suffix devices are characterized for operation from 0°C to 70°C. The I-suffix devices are characterized for operation from –40°C to +85°C. The M-suffix devices are characterized for operation over the full military temperature range of –55°C to +125°C.

### 8.2 Functional Block Diagram



### 8.3 Feature Description

The TL07xH family of devices improve many specifications as compared to the industry-standard TL07x family. Several comparisons of key specifications between these families are included in the following sections to show the advantages of the TL07xH family.

#### 8.3.1 Total Harmonic Distortion

Harmonic distortions to an audio signal are created by electronic components in a circuit. Total harmonic distortion (THD) is a measure of harmonic distortions accumulated by a signal in an audio system. These devices have a very low THD of 0.003% meaning that the TL07x device adds little harmonic distortion when used in audio signal applications.

#### 8.3.2 Slew Rate

The slew rate is the rate at which an operational amplifier can change the output when there is a change on the input. These devices have a 20-V/μs slew rate.

### 8.4 Device Functional Modes

These devices are powered on when the supply is connected. These devices can be operated as a single-supply operational amplifier or dual-supply amplifier depending on the application.



## 9 Application and Implementation

### Note

Information in the following applications sections is not part of the TI component specification, and TI does not warrant its accuracy or completeness. TI's customers are responsible for determining suitability of components for their purposes, as well as validating and testing their design implementation to confirm system functionality.

### 9.1 Application Information

A typical application for an operational amplifier is an inverting amplifier. This amplifier takes a positive voltage on the input, and makes the voltage a negative voltage. In the same manner, the amplifier makes negative voltages positive.

### 9.2 Typical Application

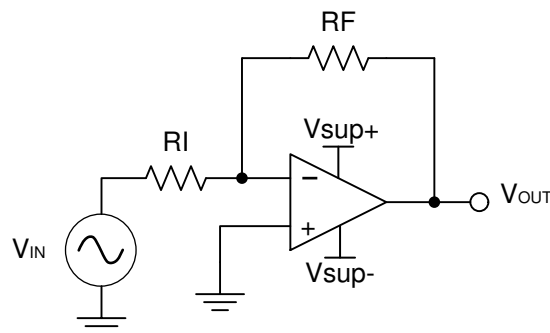

Figure 9-1. Inverting Amplifier

#### 9.2.1 Design Requirements

The supply voltage must be selected so the supply voltage is larger than the input voltage range and output range. For instance, this application scales a signal of  $\pm 0.5$  V to  $\pm 1.8$  V. Setting the supply at  $\pm 12$  V is sufficient to accommodate this application.

#### 9.2.2 Detailed Design Procedure

$$V_o = (V_i + V_{io}) \times \left(1 + \frac{1M\Omega}{1k\Omega}\right) \quad (1)$$

Determine the gain required by the inverting amplifier:

$$A_V = \frac{V_{OUT}}{V_{IN}} \quad (2)$$

$$A_V = \frac{1.8}{-0.5} = -3.6 \quad (3)$$

Once the desired gain is determined, select a value for  $R_I$  or  $R_F$ . Selecting a value in the kilohm range is desirable because the amplifier circuit uses currents in the milliamp range. This ensures the part does not draw too much current. This example uses 10 k $\Omega$  for  $R_I$  which means 36 k $\Omega$  is used for  $R_F$ . This is determined by [Equation 4](#).

$$A_V = -\frac{R_F}{R_I} \quad (4)$$

### 9.2.3 Application Curve

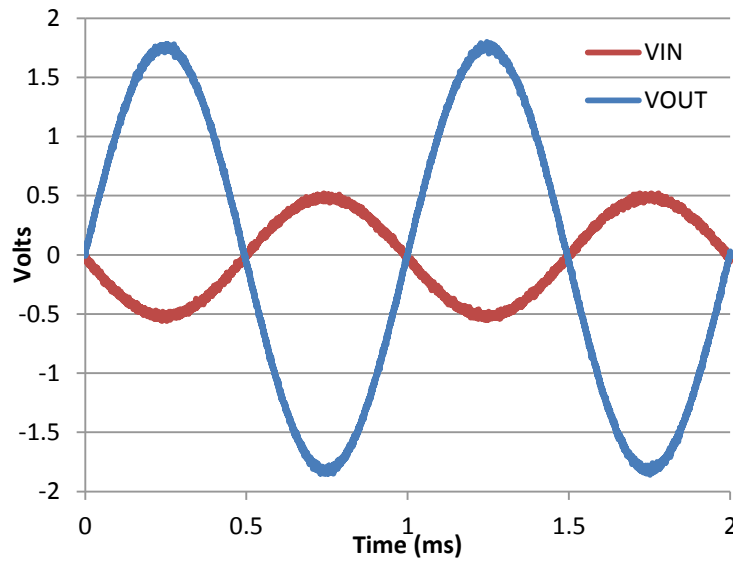
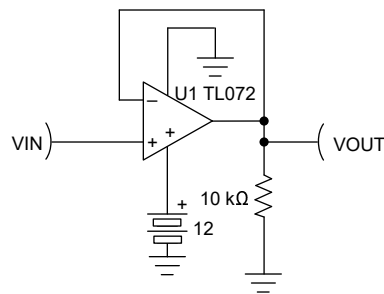

Figure 9-2. Input and Output Voltages of the Inverting Amplifier

### 9.3 Unity Gain Buffer



Copyright © 2017, Texas Instruments Incorporated

Figure 9-3. Single-Supply Unity Gain Amplifier

#### 9.3.1 Design Requirements

- $V_{CC}$  must be within valid range per [Recommended Operating Conditions](#). This example uses a value of 12 V for  $V_{CC}$ .
- Input voltage must be within the recommended common-mode range, as shown in [Recommended Operating Conditions](#). The valid common-mode range is 4 V to 12 V ( $V_{CC-} + 4$  V to  $V_{CC+}$ ).
- Output is limited by output range, which is typically 1.5 V to 10.5 V, or  $V_{CC-} + 1.5$  V to  $V_{CC+} - 1.5$  V.

#### 9.3.2 Detailed Design Procedure

- Avoid input voltage values below 1 V to prevent phase reversal where output goes high.
- Avoid input values below 4 V to prevent degraded  $V_{IO}$  that results in an apparent gain greater than 1. This may cause instability in some second-order filter designs.

### 9.3.3 Application Curves

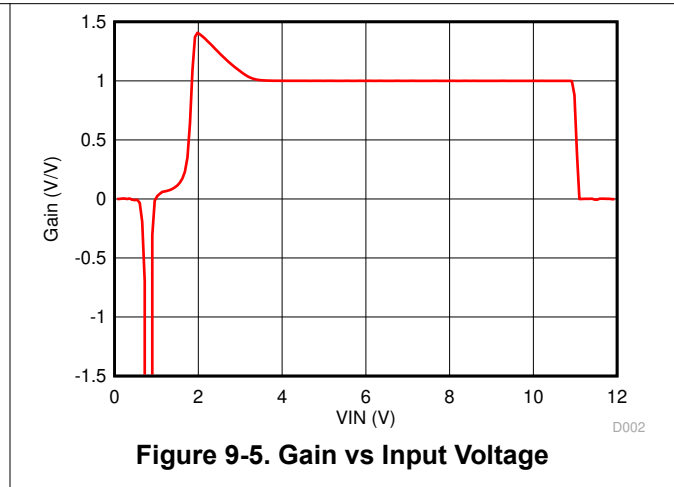
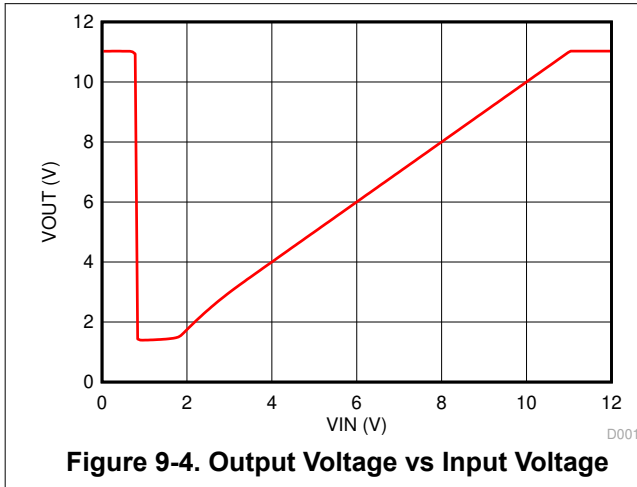

### 9.4 System Examples

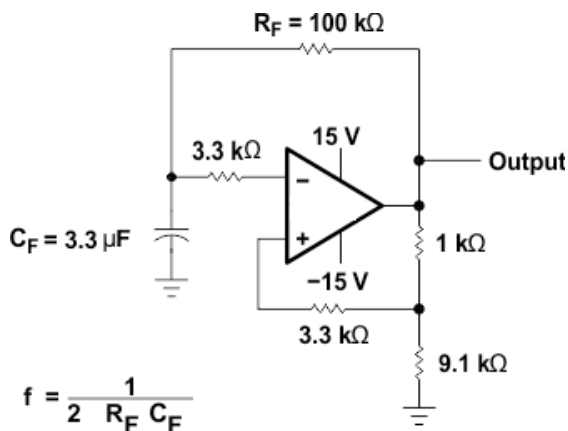

**Figure 9-6. 0.5-Hz Square-Wave Oscillator**

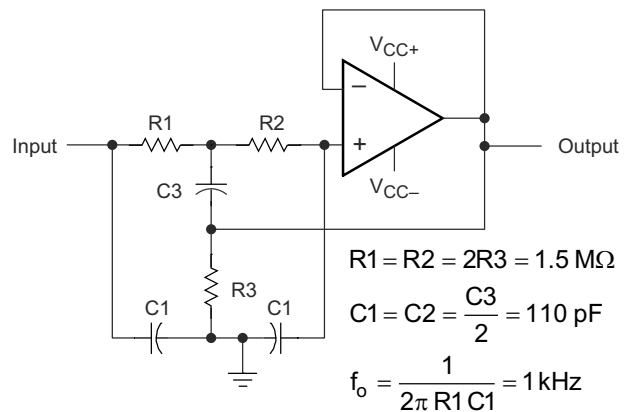

**Figure 9-7. High-Q Notch Filter**



**Figure 9-8. 100-kHz Quadrature Oscillator**

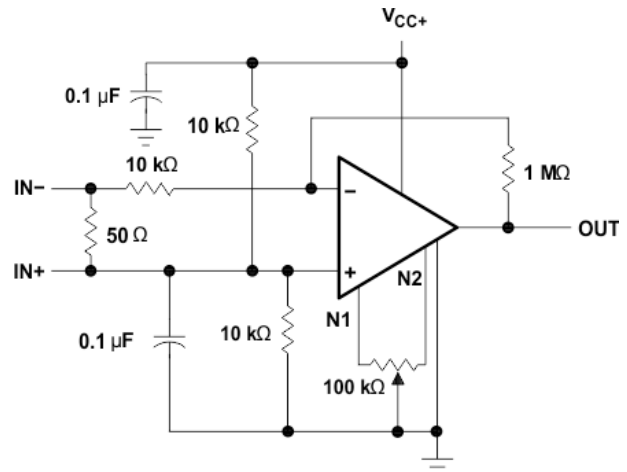

**Figure 9-9. AC Amplifier**

## 9.5 Power Supply Recommendations

### CAUTION

Supply voltages larger than 36 V for a single-supply or outside the range of  $\pm 18$  V for a dual-supply can permanently damage the device (see [Section 6.1](#)).

Place 0.1- $\mu$ F bypass capacitors close to the power-supply pins to reduce errors coupling in from noisy or high-impedance power supplies. For more detailed information on bypass capacitor placement, see [Section 9.6](#).

## 9.6 Layout

### 9.6.1 Layout Guidelines

For best operational performance of the device, use good PCB layout practices, including:

- Noise can propagate into analog circuitry through the power pins of the circuit as a whole, as well as the operational amplifier. Bypass capacitors are used to reduce the coupled noise by providing low impedance power sources local to the analog circuitry.
  - Connect low-ESR, 0.1- $\mu$ F ceramic bypass capacitors between each supply pin and ground, placed as close to the device as possible. A single bypass capacitor from  $V_{CC+}$  to ground is applicable for single-supply applications.
- Separate grounding for analog and digital portions of circuitry is one of the simplest and most-effective methods of noise suppression. One or more layers on multilayer PCBs are usually devoted to ground planes. A ground plane helps distribute heat and reduces EMI noise pickup. Take care to physically separate digital and analog grounds, paying attention to the flow of the ground current.
- To reduce parasitic coupling, run the input traces as far away from the supply or output traces as possible. If it is not possible to keep them separate, it is much better to cross the sensitive trace perpendicular as opposed to in parallel with the noisy trace.
- Place the external components as close to the device as possible. Keeping RF and RG close to the inverting input minimizes parasitic capacitance. For more information, see [Section 9.6.2](#).
- Keep the length of input traces as short as possible. Always remember that the input traces are the most sensitive part of the circuit.
- Consider a driven, low-impedance guard ring around the critical traces. A guard ring can significantly reduce leakage currents from nearby traces that are at different potentials.

### 9.6.2 Layout Example



**Figure 9-10. Operational Amplifier Board Layout for Noninverting Configuration**

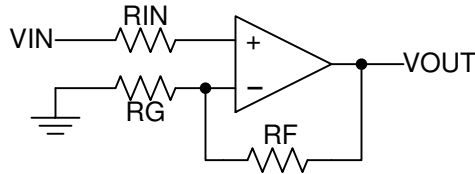

**Figure 9-11. Operational Amplifier Schematic for Noninverting Configuration**

## 10 Device and Documentation Support

### 10.1 Receiving Notification of Documentation Updates

To receive notification of documentation updates, navigate to the device product folder on [ti.com](http://ti.com). Click on *Subscribe to updates* to register and receive a weekly digest of any product information that has changed. For change details, review the revision history included in any revised document.

### 10.2 Support Resources

TI E2E™ [support forums](#) are an engineer's go-to source for fast, verified answers and design help — straight from the experts. Search existing answers or ask your own question to get the quick design help you need.

Linked content is provided "AS IS" by the respective contributors. They do not constitute TI specifications and do not necessarily reflect TI's views; see TI's [Terms of Use](#).

### 10.3 Trademarks

TI E2E™ is a trademark of Texas Instruments.  
All trademarks are the property of their respective owners.

### 10.4 Electrostatic Discharge Caution



This integrated circuit can be damaged by ESD. Texas Instruments recommends that all integrated circuits be handled with appropriate precautions. Failure to observe proper handling and installation procedures can cause damage.

ESD damage can range from subtle performance degradation to complete device failure. Precision integrated circuits may be more susceptible to damage because very small parametric changes could cause the device not to meet its published specifications.

### 10.5 Glossary

[TI Glossary](#) This glossary lists and explains terms, acronyms, and definitions.

## 11 Mechanical, Packaging, and Orderable Information

The following pages include mechanical packaging and orderable information. This information is the most current data available for the designated devices. This data is subject to change without notice and revision of this document. For browser based versions of this data sheet, refer to the left hand navigation.

**PACKAGING INFORMATION**

Orderable Device	Status (1)	Package Type	Package Drawing	Pins	Package Qty	Eco Plan (2)	Lead finish/ Ball material (6)	MSL Peak Temp (3)	Op Temp (°C)	Device Marking (4/5)	Samples
81023052A	ACTIVE	LCCC	FK	20	55	Non-RoHS & Green	SNPB	N / A for Pkg Type	-55 to 125	81023052A TL072MFKB	<a href="#">Samples</a>
8102305HA	ACTIVE	CFP	U	10	25	Non-RoHS & Green	SNPB	N / A for Pkg Type	-55 to 125	8102305HA TL072M	<a href="#">Samples</a>
8102305PA	ACTIVE	CDIP	JG	8	50	Non-RoHS & Green	SNPB	N / A for Pkg Type	-55 to 125	8102305PA TL072M	<a href="#">Samples</a>
81023062A	ACTIVE	LCCC	FK	20	55	Non-RoHS & Green	SNPB	N / A for Pkg Type	-55 to 125	81023062A TL074MFKB	<a href="#">Samples</a>
8102306CA	ACTIVE	CDIP	J	14	25	Non-RoHS & Green	SNPB	N / A for Pkg Type	-55 to 125	8102306CA TL074MJB	<a href="#">Samples</a>
8102306DA	ACTIVE	CFP	W	14	25	Non-RoHS & Green	SNPB	N / A for Pkg Type	-55 to 125	8102306DA TL074MWB	<a href="#">Samples</a>
JM38510/11905BPA	ACTIVE	CDIP	JG	8	50	Non-RoHS & Green	SNPB	N / A for Pkg Type	-55 to 125	JM38510 /11905BPA	<a href="#">Samples</a>
M38510/11905BPA	ACTIVE	CDIP	JG	8	50	Non-RoHS & Green	SNPB	N / A for Pkg Type	-55 to 125	JM38510 /11905BPA	<a href="#">Samples</a>
TL071ACDR	ACTIVE	SOIC	D	8	2500	RoHS & Green	NIPDAU	Level-1-260C-UNLIM	0 to 70	071AC	<a href="#">Samples</a>
TL071ACP	ACTIVE	PDIP	P	8	50	RoHS & Green	NIPDAU	N / A for Pkg Type	0 to 70	TL071ACP	<a href="#">Samples</a>
TL071BCDR	ACTIVE	SOIC	D	8	2500	RoHS & Green	NIPDAU	Level-1-260C-UNLIM	0 to 70	071BC	<a href="#">Samples</a>
TL071BCP	ACTIVE	PDIP	P	8	50	RoHS & Green	NIPDAU	N / A for Pkg Type	0 to 70	TL071BCP	<a href="#">Samples</a>
TL071CDR	ACTIVE	SOIC	D	8	2500	RoHS & Green	NIPDAU	Level-1-260C-UNLIM	0 to 70	TL071C	<a href="#">Samples</a>
TL071CDRE4	ACTIVE	SOIC	D	8	2500	TBD	Call TI	Call TI	0 to 70		<a href="#">Samples</a>
TL071CDRG4	ACTIVE	SOIC	D	8	2500	TBD	Call TI	Call TI	0 to 70		<a href="#">Samples</a>
TL071CP	ACTIVE	PDIP	P	8	50	RoHS & Green	NIPDAU	N / A for Pkg Type	0 to 70	TL071CP	<a href="#">Samples</a>
TL071CPE4	ACTIVE	PDIP	P	8	50	TBD	Call TI	Call TI	0 to 70		<a href="#">Samples</a>
TL071CPSR	ACTIVE	SO	PS	8	2000	RoHS & Green	NIPDAU	Level-1-260C-UNLIM	0 to 70	T071	<a href="#">Samples</a>

Orderable Device	Status (1)	Package Type	Package Drawing	Pins	Package Qty	Eco Plan (2)	Lead finish/ Ball material (6)	MSL Peak Temp (3)	Op Temp (°C)	Device Marking (4/5)	Samples
TL071HIDBVR	ACTIVE	SOT-23	DBV	5	3000	RoHS & Green	NIPDAU   SN	Level-1-260C-UNLIM	-40 to 125	T71V	<a href="#">Samples</a>
TL071HIDCKR	ACTIVE	SC70	DCK	5	3000	RoHS & Green	SN	Level-1-260C-UNLIM	-40 to 125	11O	<a href="#">Samples</a>
TL071HIDR	ACTIVE	SOIC	D	8	3000	RoHS & Green	NIPDAU	Level-1-260C-UNLIM	-40 to 125	TL071D	<a href="#">Samples</a>
TL071IDR	ACTIVE	SOIC	D	8	2500	RoHS & Green	NIPDAU	Level-1-260C-UNLIM	-40 to 85	TL071I	<a href="#">Samples</a>
TL071IDRG4	ACTIVE	SOIC	D	8	2500	TBD	Call TI	Call TI	-40 to 85		<a href="#">Samples</a>
TL071IP	ACTIVE	PDIP	P	8	50	RoHS & Green	NIPDAU	N / A for Pkg Type	-40 to 85	TL071IP	<a href="#">Samples</a>
TL072ACDR	ACTIVE	SOIC	D	8	2500	RoHS & Green	NIPDAU	Level-1-260C-UNLIM	0 to 70	072AC	<a href="#">Samples</a>
TL072ACDRE4	ACTIVE	SOIC	D	8	2500	RoHS & Green	NIPDAU	Level-1-260C-UNLIM	0 to 70	072AC	<a href="#">Samples</a>
TL072ACDRG4	ACTIVE	SOIC	D	8	2500	RoHS & Green	NIPDAU	Level-1-260C-UNLIM	0 to 70	072AC	<a href="#">Samples</a>
TL072ACP	ACTIVE	PDIP	P	8	50	RoHS & Green	NIPDAU	N / A for Pkg Type	0 to 70	TL072ACP	<a href="#">Samples</a>
TL072ACPE4	ACTIVE	PDIP	P	8	50	TBD	Call TI	Call TI	0 to 70		<a href="#">Samples</a>
TL072ACPS	ACTIVE	SO	PS	8	80	RoHS & Green	NIPDAU	Level-1-260C-UNLIM	0 to 70	T072A	<a href="#">Samples</a>
TL072BCD	OBSOLETE	SOIC	D	8		TBD	Call TI	Call TI	0 to 70	072BC	
TL072BCDR	ACTIVE	SOIC	D	8	2500	RoHS & Green	NIPDAU	Level-1-260C-UNLIM	0 to 70	072BC	<a href="#">Samples</a>
TL072BCP	ACTIVE	PDIP	P	8	50	RoHS & Green	NIPDAU	N / A for Pkg Type	0 to 70	TL072BCP	<a href="#">Samples</a>
TL072CDR	ACTIVE	SOIC	D	8	2500	RoHS & Green	NIPDAU	Level-1-260C-UNLIM	0 to 70	TL072C	<a href="#">Samples</a>
TL072CP	ACTIVE	PDIP	P	8	50	RoHS & Green	NIPDAU	N / A for Pkg Type	0 to 70	TL072CP	<a href="#">Samples</a>
TL072CPS	ACTIVE	SO	PS	8	80	RoHS & Green	NIPDAU	Level-1-260C-UNLIM	0 to 70	T072	<a href="#">Samples</a>
TL072CPSR	ACTIVE	SO	PS	8	2000	RoHS & Green	NIPDAU	Level-1-260C-UNLIM	0 to 70	T072	<a href="#">Samples</a>
TL072CPSRG4	ACTIVE	SO	PS	8	2000	RoHS & Green	NIPDAU	Level-1-260C-UNLIM	0 to 70	T072	<a href="#">Samples</a>
TL072CPWR	ACTIVE	TSSOP	PW	8	2000	RoHS & Green	NIPDAU	Level-1-260C-UNLIM	0 to 70	T072	<a href="#">Samples</a>



Orderable Device	Status (1)	Package Type	Package Drawing	Pins	Package Qty	Eco Plan (2)	Lead finish/ Ball material (6)	MSL Peak Temp (3)	Op Temp (°C)	Device Marking (4/5)	Samples
TL072CPWRE4	ACTIVE	TSSOP	PW	8	2000	TBD	Call TI	Call TI	0 to 70		<a href="#">Samples</a>
TL072CPWRG4	ACTIVE	TSSOP	PW	8	2000	TBD	Call TI	Call TI	0 to 70		<a href="#">Samples</a>
TL072HIDDFR	ACTIVE	SOT-23-THIN	DDF	8	3000	RoHS & Green	NIPDAU	Level-1-260C-UNLIM	-40 to 125	O72F	<a href="#">Samples</a>
TL072HIDR	ACTIVE	SOIC	D	8	3000	RoHS & Green	NIPDAU	Level-1-260C-UNLIM	-40 to 125	TL072D	<a href="#">Samples</a>
TL072HIPWR	ACTIVE	TSSOP	PW	8	3000	RoHS & Green	NIPDAU	Level-1-260C-UNLIM	-40 to 125	072HPW	<a href="#">Samples</a>
TL072IDR	ACTIVE	SOIC	D	8	2500	RoHS & Green	NIPDAU	Level-1-260C-UNLIM	-40 to 85	TL072I	<a href="#">Samples</a>
TL072IP	ACTIVE	PDIP	P	8	50	RoHS & Green	NIPDAU	N / A for Pkg Type	-40 to 85	TL072IP	<a href="#">Samples</a>
TL072IPE4	ACTIVE	PDIP	P	8	50	TBD	Call TI	Call TI	-40 to 85		<a href="#">Samples</a>
TL072MFKB	ACTIVE	LCCC	FK	20	55	Non-RoHS & Green	SNPB	N / A for Pkg Type	-55 to 125	81023052A TL072MFKB	<a href="#">Samples</a>
TL072MJG	ACTIVE	CDIP	JG	8	50	Non-RoHS & Green	SNPB	N / A for Pkg Type	-55 to 125	TL072MJG	<a href="#">Samples</a>
TL072MJGB	ACTIVE	CDIP	JG	8	50	Non-RoHS & Green	SNPB	N / A for Pkg Type	-55 to 125	8102305PA TL072M	<a href="#">Samples</a>
TL072MUB	ACTIVE	CFP	U	10	25	Non-RoHS & Green	SNPB	N / A for Pkg Type	-55 to 125	8102305HA TL072M	<a href="#">Samples</a>
TL074ACDR	ACTIVE	SOIC	D	14	2500	RoHS & Green	NIPDAU	Level-1-260C-UNLIM	0 to 70	TL074AC	<a href="#">Samples</a>
TL074ACN	ACTIVE	PDIP	N	14	25	RoHS & Green	NIPDAU	N / A for Pkg Type	0 to 70	TL074ACN	<a href="#">Samples</a>
TL074ACNSR	ACTIVE	SO	NS	14	2000	RoHS & Green	NIPDAU	Level-1-260C-UNLIM	0 to 70	TL074A	<a href="#">Samples</a>
TL074BCD	OBSOLETE	SOIC	D	14		TBD	Call TI	Call TI	0 to 70	TL074BC	
TL074BCDR	ACTIVE	SOIC	D	14	2500	RoHS & Green	NIPDAU	Level-1-260C-UNLIM	0 to 70	TL074BC	<a href="#">Samples</a>
TL074BCDRE4	ACTIVE	SOIC	D	14	2500	RoHS & Green	NIPDAU	Level-1-260C-UNLIM	0 to 70	TL074BC	<a href="#">Samples</a>
TL074BCDRG4	ACTIVE	SOIC	D	14	2500	RoHS & Green	NIPDAU	Level-1-260C-UNLIM	0 to 70	TL074BC	<a href="#">Samples</a>
TL074BCN	ACTIVE	PDIP	N	14	25	RoHS & Green	NIPDAU	N / A for Pkg Type	0 to 70	TL074BCN	<a href="#">Samples</a>
TL074CD	OBSOLETE	SOIC	D	14		TBD	Call TI	Call TI	0 to 70	TL074C	

Orderable Device	Status (1)	Package Type	Package Drawing	Pins	Package Qty	Eco Plan (2)	Lead finish/ Ball material (6)	MSL Peak Temp (3)	Op Temp (°C)	Device Marking (4/5)	Samples
TL074CDBR	ACTIVE	SSOP	DB	14	2000	RoHS & Green	NIPDAU	Level-1-260C-UNLIM	0 to 70	T074	<a href="#">Samples</a>
TL074CDR	ACTIVE	SOIC	D	14	2500	RoHS & Green	NIPDAU	Level-1-260C-UNLIM	0 to 70	TL074C	<a href="#">Samples</a>
TL074CDRG4	ACTIVE	SOIC	D	14	2500	RoHS & Green	NIPDAU	Level-1-260C-UNLIM	0 to 70	TL074C	<a href="#">Samples</a>
TL074CN	ACTIVE	PDIP	N	14	25	RoHS & Green	NIPDAU	N / A for Pkg Type	0 to 70	TL074CN	<a href="#">Samples</a>
TL074CNSR	ACTIVE	SO	NS	14	2000	RoHS & Green	NIPDAU	Level-1-260C-UNLIM	0 to 70	TL074	<a href="#">Samples</a>
TL074CPW	OBSOLETE	TSSOP	PW	14		TBD	Call TI	Call TI	0 to 70	T074	
TL074CPWR	ACTIVE	TSSOP	PW	14	2000	RoHS & Green	NIPDAU	Level-1-260C-UNLIM	0 to 70	T074	<a href="#">Samples</a>
TL074CPWRE4	ACTIVE	TSSOP	PW	14	2000	RoHS & Green	NIPDAU	Level-1-260C-UNLIM	0 to 70	T074	<a href="#">Samples</a>
TL074CPWRG4	ACTIVE	TSSOP	PW	14	2000	RoHS & Green	NIPDAU	Level-1-260C-UNLIM	0 to 70	T074	<a href="#">Samples</a>
TL074HIDR	ACTIVE	SOIC	D	14	2500	RoHS & Green	NIPDAU	Level-1-260C-UNLIM	-40 to 125	TL074HID	<a href="#">Samples</a>
TL074HIDYYR	ACTIVE	SOT-23-THIN	DYY	14	3000	RoHS & Green	NIPDAU	Level-1-260C-UNLIM	-40 to 125	T074HDYY	<a href="#">Samples</a>
TL074HIPWR	ACTIVE	TSSOP	PW	14	2000	RoHS & Green	NIPDAU	Level-1-260C-UNLIM	-40 to 125	TL074PW	<a href="#">Samples</a>
TL074ID	OBSOLETE	SOIC	D	14		TBD	Call TI	Call TI	-40 to 85	TL074I	
TL074IDR	ACTIVE	SOIC	D	14	2500	RoHS & Green	NIPDAU	Level-1-260C-UNLIM	-40 to 85	TL074I	<a href="#">Samples</a>
TL074IDRE4	ACTIVE	SOIC	D	14	2500	RoHS & Green	NIPDAU	Level-1-260C-UNLIM	-40 to 85	TL074I	<a href="#">Samples</a>
TL074IDRG4	ACTIVE	SOIC	D	14	2500	RoHS & Green	NIPDAU	Level-1-260C-UNLIM	-40 to 85	TL074I	<a href="#">Samples</a>
TL074IN	ACTIVE	PDIP	N	14	25	RoHS & Green	NIPDAU	N / A for Pkg Type	-40 to 85	TL074IN	<a href="#">Samples</a>
TL074MFK	ACTIVE	LCCC	FK	20	55	Non-RoHS & Green	SNPB	N / A for Pkg Type	-55 to 125	TL074MFK	<a href="#">Samples</a>
TL074MFKB	ACTIVE	LCCC	FK	20	55	Non-RoHS & Green	SNPB	N / A for Pkg Type	-55 to 125	81023062A TL074MFKB	<a href="#">Samples</a>
TL074MJ	ACTIVE	CDIP	J	14	25	Non-RoHS & Green	SNPB	N / A for Pkg Type	-55 to 125	TL074MJ	<a href="#">Samples</a>
TL074MJB	ACTIVE	CDIP	J	14	25	Non-RoHS & Green	SNPB	N / A for Pkg Type	-55 to 125	8102306CA TL074MJB	<a href="#">Samples</a>

Orderable Device	Status (1)	Package Type	Package Drawing	Pins	Package Qty	Eco Plan (2)	Lead finish/ Ball material (6)	MSL Peak Temp (3)	Op Temp (°C)	Device Marking (4/5)	Samples
TL074MWB	ACTIVE	CFP	W	14	25	Non-RoHS & Green	SNPB	N / A for Pkg Type	-55 to 125	8102306DA TL074MWB	Samples

(1) The marketing status values are defined as follows:

**ACTIVE:** Product device recommended for new designs.

**LIFEBUY:** TI has announced that the device will be discontinued, and a lifetime-buy period is in effect.

**NRND:** Not recommended for new designs. Device is in production to support existing customers, but TI does not recommend using this part in a new design.

**PREVIEW:** Device has been announced but is not in production. Samples may or may not be available.

**OBSOLETE:** TI has discontinued the production of the device.

(2) **RoHS:** TI defines "RoHS" to mean semiconductor products that are compliant with the current EU RoHS requirements for all 10 RoHS substances, including the requirement that RoHS substance do not exceed 0.1% by weight in homogeneous materials. Where designed to be soldered at high temperatures, "RoHS" products are suitable for use in specified lead-free processes. TI may reference these types of products as "Pb-Free".

**RoHS Exempt:** TI defines "RoHS Exempt" to mean products that contain lead but are compliant with EU RoHS pursuant to a specific EU RoHS exemption.

**Green:** TI defines "Green" to mean the content of Chlorine (Cl) and Bromine (Br) based flame retardants meet JS709B low halogen requirements of <=1000ppm threshold. Antimony trioxide based flame retardants must also meet the <=1000ppm threshold requirement.

(3) MSL, Peak Temp. - The Moisture Sensitivity Level rating according to the JEDEC industry standard classifications, and peak solder temperature.

(4) There may be additional marking, which relates to the logo, the lot trace code information, or the environmental category on the device.

(5) Multiple Device Markings will be inside parentheses. Only one Device Marking contained in parentheses and separated by a "~" will appear on a device. If a line is indented then it is a continuation of the previous line and the two combined represent the entire Device Marking for that device.

(6) Lead finish/Ball material - Orderable Devices may have multiple material finish options. Finish options are separated by a vertical ruled line. Lead finish/Ball material values may wrap to two lines if the finish value exceeds the maximum column width.

**Important Information and Disclaimer:**The information provided on this page represents TI's knowledge and belief as of the date that it is provided. TI bases its knowledge and belief on information provided by third parties, and makes no representation or warranty as to the accuracy of such information. Efforts are underway to better integrate information from third parties. TI has taken and continues to take reasonable steps to provide representative and accurate information but may not have conducted destructive testing or chemical analysis on incoming materials and chemicals. TI and TI suppliers consider certain information to be proprietary, and thus CAS numbers and other limited information may not be available for release.

In no event shall TI's liability arising out of such information exceed the total purchase price of the TI part(s) at issue in this document sold by TI to Customer on an annual basis.

**OTHER QUALIFIED VERSIONS OF TL072, TL072M, TL074, TL074M :**

- Catalog : [TL072](#), [TL074](#)
- Enhanced Product : [TL072-EP](#), [TL072-EP](#), [TL074-EP](#), [TL074-EP](#)
- Military : [TL072M](#), [TL074M](#)

NOTE: Qualified Version Definitions:

- Catalog - TI's standard catalog product
- Enhanced Product - Supports Defense, Aerospace and Medical Applications
- Military - QML certified for Military and Defense Applications

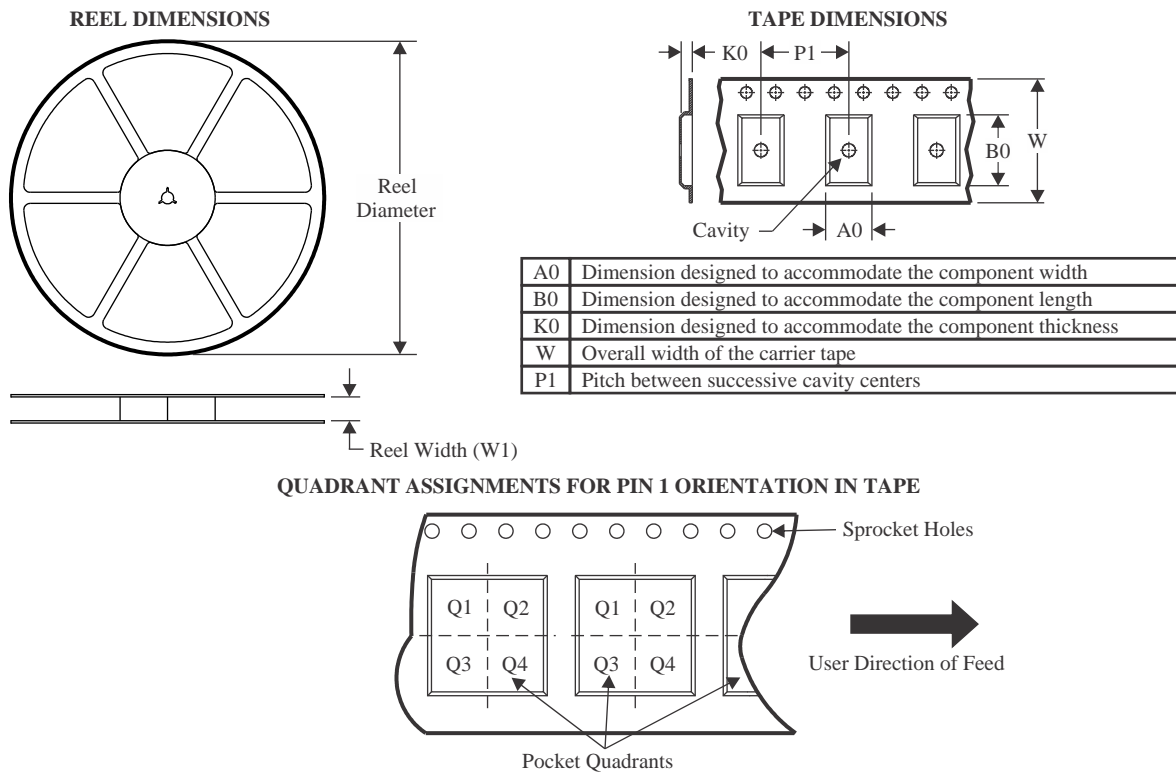
**TAPE AND REEL INFORMATION**

\*All dimensions are nominal

Device	Package Type	Package Drawing	Pins	SPQ	Reel Diameter (mm)	Reel Width W1 (mm)	A0 (mm)	B0 (mm)	K0 (mm)	P1 (mm)	W (mm)	Pin1 Quadrant
TL071ACDR	SOIC	D	8	2500	330.0	12.4	6.4	5.2	2.1	8.0	12.0	Q1
TL071ACDR	SOIC	D	8	2500	330.0	12.4	6.4	5.2	2.1	8.0	12.0	Q1
TL071BCDR	SOIC	D	8	2500	330.0	12.4	6.4	5.2	2.1	8.0	12.0	Q1
TL071BCDR	SOIC	D	8	2500	330.0	12.4	6.4	5.2	2.1	8.0	12.0	Q1
TL071CDR	SOIC	D	8	2500	330.0	12.4	6.4	5.2	2.1	8.0	12.0	Q1
TL071CPSR	SO	PS	8	2000	330.0	16.4	8.35	6.6	2.4	12.0	16.0	Q1
TL071HIDBVR	SOT-23	DBV	5	3000	180.0	8.4	3.2	3.2	1.4	4.0	8.0	Q3
TL071HIDCKR	SC70	DCK	5	3000	178.0	9.0	2.4	2.5	1.2	4.0	8.0	Q3
TL071HIDR	SOIC	D	8	3000	330.0	12.4	6.4	5.2	2.1	8.0	12.0	Q1
TL071IDR	SOIC	D	8	2500	330.0	12.4	6.4	5.2	2.1	8.0	12.0	Q1
TL072ACDR	SOIC	D	8	2500	330.0	12.4	6.4	5.2	2.1	8.0	12.0	Q1
TL072BCDR	SOIC	D	8	2500	330.0	12.4	6.4	5.2	2.1	8.0	12.0	Q1
TL072BCDR	SOIC	D	8	2500	330.0	12.4	6.4	5.2	2.1	8.0	12.0	Q1
TL072CDR	SOIC	D	8	2500	330.0	12.4	6.4	5.2	2.1	8.0	12.0	Q1
TL072CDR	SOIC	D	8	2500	330.0	12.4	6.4	5.2	2.1	8.0	12.0	Q1
TL072CPSR	SO	PS	8	2000	330.0	16.4	8.35	6.6	2.4	12.0	16.0	Q1

Device	Package Type	Package Drawing	Pins	SPQ	Reel Diameter (mm)	Reel Width W1 (mm)	A0 (mm)	B0 (mm)	K0 (mm)	P1 (mm)	W (mm)	Pin1 Quadrant
TL072CPWR	TSSOP	PW	8	2000	330.0	12.4	7.0	3.6	1.6	8.0	12.0	Q1
TL072CPWR	TSSOP	PW	8	2000	330.0	12.4	7.0	3.6	1.6	8.0	12.0	Q1
TL072HIDDFR	SOT-23-THIN	DDF	8	3000	180.0	8.4	3.2	3.2	1.4	4.0	8.0	Q3
TL072HIDR	SOIC	D	8	3000	330.0	12.4	6.4	5.2	2.1	8.0	12.0	Q1
TL072HIPWR	TSSOP	PW	8	3000	330.0	12.4	7.0	3.6	1.6	8.0	12.0	Q1
TL072IDR	SOIC	D	8	2500	330.0	12.4	6.4	5.2	2.1	8.0	12.0	Q1
TL072IDR	SOIC	D	8	2500	330.0	12.4	6.4	5.2	2.1	8.0	12.0	Q1
TL074ACDR	SOIC	D	14	2500	330.0	16.4	6.5	9.0	2.1	8.0	16.0	Q1
TL074ACDR	SOIC	D	14	2500	330.0	16.4	6.5	9.0	2.1	8.0	16.0	Q1
TL074ACNSR	SO	NS	14	2000	330.0	16.4	8.2	10.5	2.5	12.0	16.0	Q1
TL074BCDR	SOIC	D	14	2500	330.0	16.4	6.5	9.0	2.1	8.0	16.0	Q1
TL074BCDR	SOIC	D	14	2500	330.0	16.4	6.5	9.0	2.1	8.0	16.0	Q1
TL074CDBR	SSOP	DB	14	2000	330.0	16.4	8.35	6.6	2.4	12.0	16.0	Q1
TL074CDR	SOIC	D	14	2500	330.0	16.4	6.5	9.0	2.1	8.0	16.0	Q1
TL074CDR	SOIC	D	14	2500	330.0	16.4	6.5	9.0	2.1	8.0	16.0	Q1
TL074CDRG4	SOIC	D	14	2500	330.0	16.4	6.5	9.0	2.1	8.0	16.0	Q1
TL074CNSR	SO	NS	14	2000	330.0	16.4	8.2	10.5	2.5	12.0	16.0	Q1
TL074CPWR	TSSOP	PW	14	2000	330.0	12.4	6.9	5.6	1.6	8.0	12.0	Q1
TL074CPWR	TSSOP	PW	14	2000	330.0	12.4	6.9	5.6	1.6	8.0	12.0	Q1
TL074HIDR	SOIC	D	14	2500	330.0	16.4	6.5	9.0	2.1	8.0	16.0	Q1
TL074HIDYYR	SOT-23-THIN	DYY	14	3000	330.0	12.4	4.8	3.6	1.6	8.0	12.0	Q3
TL074HIPWR	TSSOP	PW	14	2000	330.0	12.4	6.9	5.6	1.6	8.0	12.0	Q1
TL074IDR	SOIC	D	14	2500	330.0	16.4	6.5	9.0	2.1	8.0	16.0	Q1

## TAPE AND REEL BOX DIMENSIONS



\*All dimensions are nominal

Device	Package Type	Package Drawing	Pins	SPQ	Length (mm)	Width (mm)	Height (mm)
TL071ACDR	SOIC	D	8	2500	356.0	356.0	35.0
TL071ACDR	SOIC	D	8	2500	340.5	338.1	20.6
TL071BCDR	SOIC	D	8	2500	356.0	356.0	35.0
TL071BCDR	SOIC	D	8	2500	340.5	338.1	20.6
TL071CDR	SOIC	D	8	2500	356.0	356.0	35.0
TL071CPSR	SO	PS	8	2000	356.0	356.0	35.0
TL071HIDBVR	SOT-23	DBV	5	3000	210.0	185.0	35.0
TL071HIDCKR	SC70	DCK	5	3000	190.0	190.0	30.0
TL071HIDR	SOIC	D	8	3000	356.0	356.0	35.0
TL071IDR	SOIC	D	8	2500	356.0	356.0	35.0
TL072ACDR	SOIC	D	8	2500	356.0	356.0	35.0
TL072BCDR	SOIC	D	8	2500	353.0	353.0	32.0
TL072BCDR	SOIC	D	8	2500	356.0	356.0	35.0
TL072CDR	SOIC	D	8	2500	356.0	356.0	35.0
TL072CDR	SOIC	D	8	2500	356.0	356.0	35.0
TL072CPSR	SO	PS	8	2000	356.0	356.0	35.0
TL072CPWR	TSSOP	PW	8	2000	356.0	356.0	35.0
TL072CPWR	TSSOP	PW	8	2000	356.0	356.0	35.0

Device	Package Type	Package Drawing	Pins	SPQ	Length (mm)	Width (mm)	Height (mm)
TL072HIDDFR	SOT-23-THIN	DDF	8	3000	210.0	185.0	35.0
TL072HIDR	SOIC	D	8	3000	356.0	356.0	35.0
TL072HIPWR	TSSOP	PW	8	3000	356.0	356.0	35.0
TL072IDR	SOIC	D	8	2500	356.0	356.0	35.0
TL072IDR	SOIC	D	8	2500	356.0	356.0	35.0
TL074ACDR	SOIC	D	14	2500	356.0	356.0	35.0
TL074ACDR	SOIC	D	14	2500	353.0	353.0	32.0
TL074ACNSR	SO	NS	14	2000	356.0	356.0	35.0
TL074BCDR	SOIC	D	14	2500	353.0	353.0	32.0
TL074BCDR	SOIC	D	14	2500	356.0	356.0	35.0
TL074CDBR	SSOP	DB	14	2000	356.0	356.0	35.0
TL074CDR	SOIC	D	14	2500	356.0	356.0	35.0
TL074CDR	SOIC	D	14	2500	353.0	353.0	32.0
TL074CDRG4	SOIC	D	14	2500	356.0	356.0	35.0
TL074CNSR	SO	NS	14	2000	356.0	356.0	35.0
TL074CPWR	TSSOP	PW	14	2000	356.0	356.0	35.0
TL074CPWR	TSSOP	PW	14	2000	356.0	356.0	35.0
TL074HIDR	SOIC	D	14	2500	356.0	356.0	35.0
TL074HIDYYR	SOT-23-THIN	DYY	14	3000	336.6	336.6	31.8
TL074HIPWR	TSSOP	PW	14	2000	356.0	356.0	35.0
TL074IDR	SOIC	D	14	2500	356.0	356.0	35.0



**TUBE**

\*All dimensions are nominal

Device	Package Name	Package Type	Pins	SPQ	L (mm)	W (mm)	T (µm)	B (mm)
81023052A	FK	LCCC	20	55	506.98	12.06	2030	NA
8102305HA	U	CFP	10	25	506.98	26.16	6220	NA
81023062A	FK	LCCC	20	55	506.98	12.06	2030	NA
8102306DA	W	CFP	14	25	506.98	26.16	6220	NA
TL071ACP	P	PDIP	8	50	506	13.97	11230	4.32
TL071BCP	P	PDIP	8	50	506	13.97	11230	4.32
TL071CP	P	PDIP	8	50	506	13.97	11230	4.32
TL071IP	P	PDIP	8	50	506	13.97	11230	4.32
TL072ACP	P	PDIP	8	50	506	13.97	11230	4.32
TL072ACPS	PS	SOP	8	80	530	10.5	4000	4.1
TL072BCP	P	PDIP	8	50	506	13.97	11230	4.32
TL072CP	P	PDIP	8	50	506	13.97	11230	4.32
TL072CPS	PS	SOP	8	80	530	10.5	4000	4.1
TL072IP	P	PDIP	8	50	506	13.97	11230	4.32
TL072MFKB	FK	LCCC	20	55	506.98	12.06	2030	NA
TL072MUB	U	CFP	10	25	506.98	26.16	6220	NA
TL074ACN	N	PDIP	14	25	506	13.97	11230	4.32
TL074ACN	N	PDIP	14	25	506	13.97	11230	4.32
TL074BCN	N	PDIP	14	25	506	13.97	11230	4.32
TL074BCN	N	PDIP	14	25	506	13.97	11230	4.32
TL074CN	N	PDIP	14	25	506	13.97	11230	4.32
TL074CN	N	PDIP	14	25	506	13.97	11230	4.32
TL074IN	N	PDIP	14	25	506	13.97	11230	4.32
TL074MFK	FK	LCCC	20	55	506.98	12.06	2030	NA
TL074MFKB	FK	LCCC	20	55	506.98	12.06	2030	NA
TL074MWB	W	CFP	14	25	506.98	26.16	6220	NA

# PACKAGE OUTLINE

JG0008A

CDIP - 5.08 mm max height

CERAMIC DUAL IN-LINE PACKAGE



**NOTES:**

1. All linear dimensions are in millimeters. Any dimensions in parenthesis are for reference only. Dimensioning and tolerancing per ASME Y14.5M.
2. This drawing is subject to change without notice.
3. This package can be hermetically sealed with a ceramic lid using glass frit.
4. Index point is provided on cap for terminal identification.
5. Falls within MIL STD 1835 GDIP1-T8

# EXAMPLE BOARD LAYOUT

JG0008A

CDIP - 5.08 mm max height

CERAMIC DUAL IN-LINE PACKAGE



LAND PATTERN EXAMPLE  
NON SOLDER MASK DEFINED  
SCALE: 9X

4230036/A 09/2023

# U0010A



## PACKAGE OUTLINE

CFP - 2.03 mm max height

CERAMIC FLATPACK

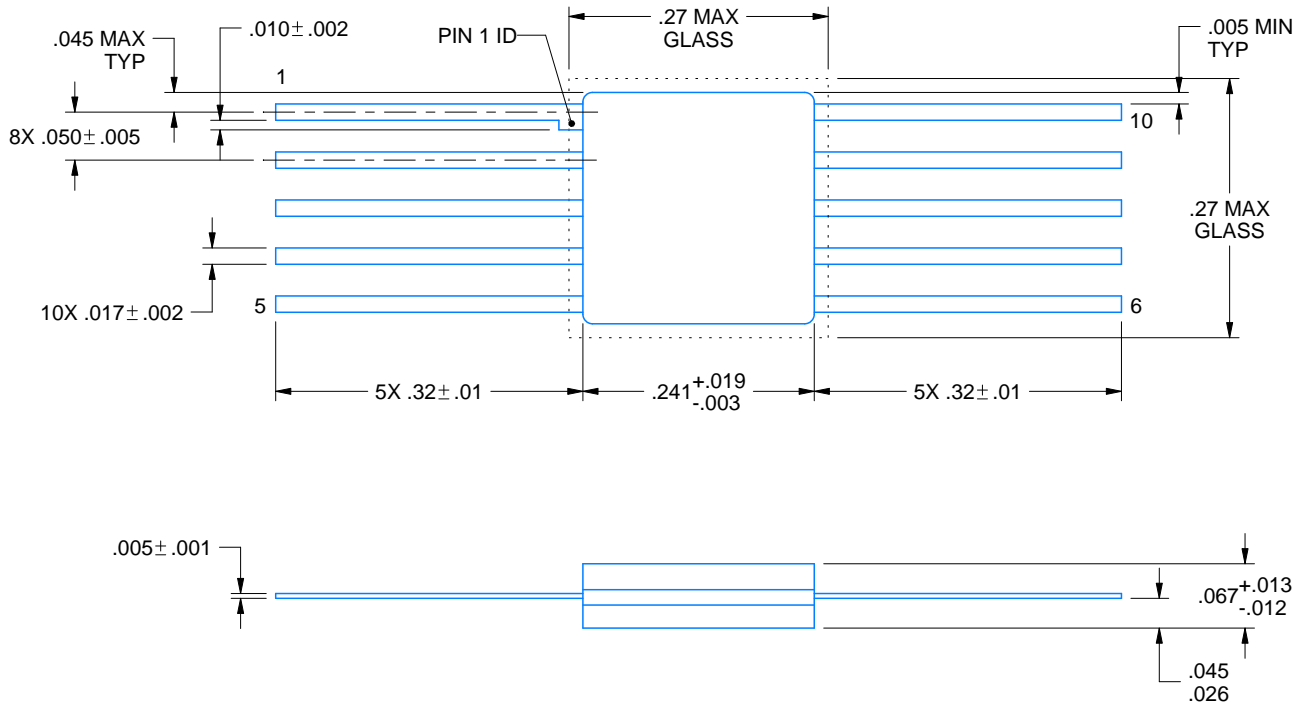

4225582/A 01/2020

### NOTES:

1. All linear dimensions are in inches. Any dimensions in parenthesis are for reference only. Dimensioning and tolerancing per ASME Y14.5M.
2. This drawing is subject to change without notice.



# PACKAGE OUTLINE

## DBV0005A

## SOT-23 - 1.45 mm max height

SMALL OUTLINE TRANSISTOR



4214839/K 08/2024

### NOTES:

- All linear dimensions are in millimeters. Any dimensions in parenthesis are for reference only. Dimensioning and tolerancing per ASME Y14.5M.
- This drawing is subject to change without notice.
- Reference JEDEC MO-178.
- Body dimensions do not include mold flash, protrusions, or gate burrs. Mold flash, protrusions, or gate burrs shall not exceed 0.25 mm per side.
- Support pin may differ or may not be present.

# EXAMPLE BOARD LAYOUT

DBV0005A

SOT-23 - 1.45 mm max height

SMALL OUTLINE TRANSISTOR



LAND PATTERN EXAMPLE  
EXPOSED METAL SHOWN  
SCALE:15X



SOLDER MASK DETAILS

4214839/K 08/2024

NOTES: (continued)

- 6. Publication IPC-7351 may have alternate designs.
- 7. Solder mask tolerances between and around signal pads can vary based on board fabrication site.

# EXAMPLE STENCIL DESIGN

DBV0005A

SOT-23 - 1.45 mm max height

SMALL OUTLINE TRANSISTOR



SOLDER PASTE EXAMPLE  
BASED ON 0.125 mm THICK STENCIL  
SCALE:15X

4214839/K 08/2024

NOTES: (continued)

8. Laser cutting apertures with trapezoidal walls and rounded corners may offer better paste release. IPC-7525 may have alternate design recommendations.
9. Board assembly site may have different recommendations for stencil design.

# D0014A



# PACKAGE OUTLINE

## SOIC - 1.75 mm max height

SMALL OUTLINE INTEGRATED CIRCUIT



4220718/A 09/2016

**NOTES:**

1. All linear dimensions are in millimeters. Dimensions in parenthesis are for reference only. Dimensioning and tolerancing per ASME Y14.5M.
2. This drawing is subject to change without notice.
3. This dimension does not include mold flash, protrusions, or gate burrs. Mold flash, protrusions, or gate burrs shall not exceed 0.15 mm, per side.
4. This dimension does not include interlead flash. Interlead flash shall not exceed 0.43 mm, per side.
5. Reference JEDEC registration MS-012, variation AB.



# EXAMPLE BOARD LAYOUT

D0014A

SOIC - 1.75 mm max height

SMALL OUTLINE INTEGRATED CIRCUIT



LAND PATTERN EXAMPLE  
SCALE:8X



SOLDER MASK DETAILS

4220718/A 09/2016

NOTES: (continued)

- 6. Publication IPC-7351 may have alternate designs.
- 7. Solder mask tolerances between and around signal pads can vary based on board fabrication site.

# EXAMPLE STENCIL DESIGN

D0014A

SOIC - 1.75 mm max height

SMALL OUTLINE INTEGRATED CIRCUIT



SOLDER PASTE EXAMPLE  
BASED ON 0.125 mm THICK STENCIL  
SCALE:8X

4220718/A 09/2016

NOTES: (continued)

8. Laser cutting apertures with trapezoidal walls and rounded corners may offer better paste release. IPC-7525 may have alternate design recommendations.
9. Board assembly site may have different recommendations for stencil design.

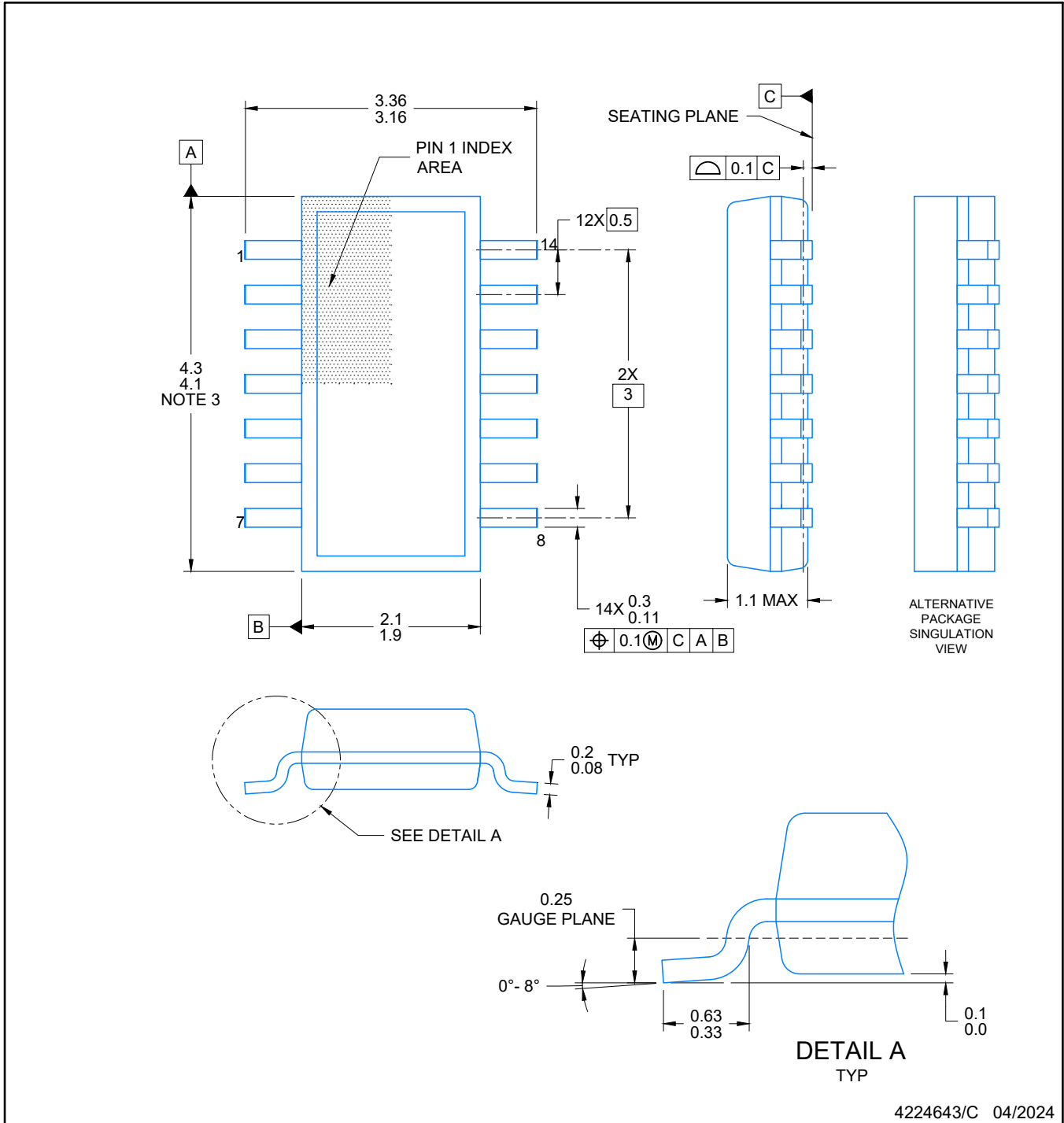

NOTES:

1. All linear dimensions are in millimeters. Any dimensions in parenthesis are for reference only. Dimensioning and tolerancing per ASME Y14.5M.
2. This drawing is subject to change without notice.
3. This dimension does not include mold flash, protrusions, or gate burrs. Mold flash, protrusions, or gate burrs shall not exceed 0.15 per side.
4. This dimension does not include interlead flash. Interlead flash shall not exceed 0.50 per side.
5. Reference JEDEC Registration MO-345, Variation AB



LAND PATTERN EXAMPLE  
EXPOSED METAL SHOWN  
SCALE: 20X

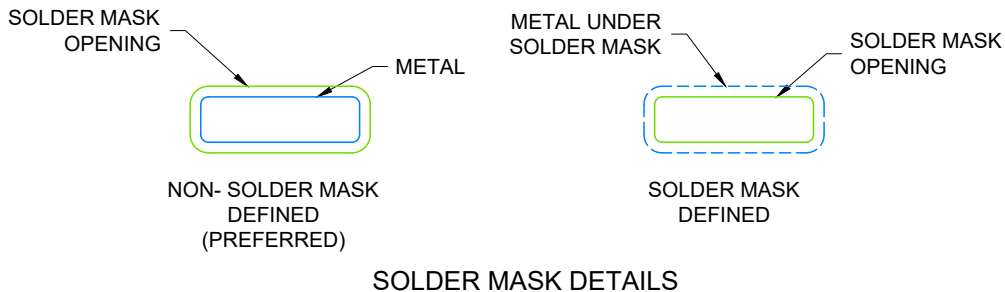

4224643/C 04/2024

NOTES: (continued)

- 6. Publication IPC-7351 may have alternate designs.
- 7. Solder mask tolerances between and around signal pads can vary based on board fabrication site.

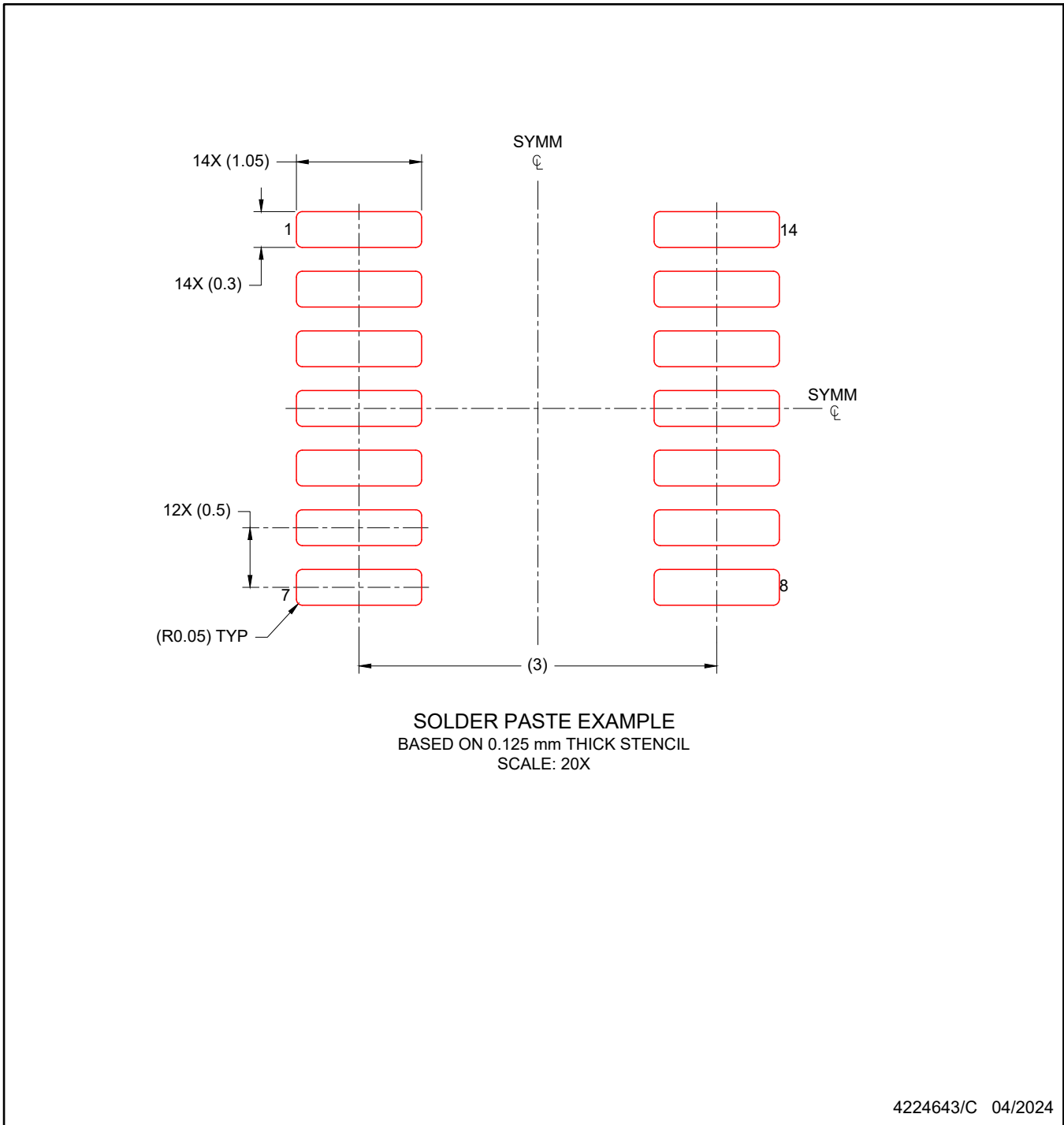

NOTES: (continued)

8. Laser cutting apertures with trapezoidal walls and rounded corners may offer better paste release. IPC-7525 may have alternate design recommendations.
9. Board assembly site may have different recommendations for stencil design.

## MECHANICAL DATA

**NS (R-PDSO-G\*\*)**

**PLASTIC SMALL-OUTLINE PACKAGE**

**14-PINS SHOWN**



- NOTES:
- A. All linear dimensions are in millimeters.
  - B. This drawing is subject to change without notice.
  - C. Body dimensions do not include mold flash or protrusion, not to exceed 0,15.

W (R-GDFP-F14)

CERAMIC DUAL FLATPACK



- NOTES:
- A. All linear dimensions are in inches (millimeters).
  - B. This drawing is subject to change without notice.
  - C. This package can be hermetically sealed with a ceramic lid using glass frit.
  - D. Index point is provided on cap for terminal identification only.
  - E. Falls within MIL STD 1835 GDFP1-F14

# DB0014A



# PACKAGE OUTLINE

## SSOP - 2 mm max height

SMALL OUTLINE PACKAGE



### NOTES:

1. All linear dimensions are in millimeters. Any dimensions in parenthesis are for reference only. Dimensioning and tolerancing per ASME Y14.5M.
2. This drawing is subject to change without notice.
3. This dimension does not include mold flash, protrusions, or gate burrs. Mold flash, protrusions, or gate burrs shall not exceed 0.15 mm per side.
4. Reference JEDEC registration MO-150.



# EXAMPLE BOARD LAYOUT

DB0014A

SSOP - 2 mm max height

SMALL OUTLINE PACKAGE



LAND PATTERN EXAMPLE  
EXPOSED METAL SHOWN  
SCALE: 10X



4220762/A 05/2024

NOTES: (continued)

- 5. Publication IPC-7351 may have alternate designs.
- 6. Solder mask tolerances between and around signal pads can vary based on board fabrication site.

# EXAMPLE STENCIL DESIGN

DB0014A

SSOP - 2 mm max height

SMALL OUTLINE PACKAGE



SOLDER PASTE EXAMPLE  
BASED ON 0.125 mm THICK STENCIL  
SCALE: 10X

4220762/A 05/2024

NOTES: (continued)

7. Laser cutting apertures with trapezoidal walls and rounded corners may offer better paste release. IPC-7525 may have alternate design recommendations.
8. Board assembly site may have different recommendations for stencil design.

## GENERIC PACKAGE VIEW

**FK 20**

**LCCC - 2.03 mm max height**

8.89 x 8.89, 1.27 mm pitch

LEADLESS CERAMIC CHIP CARRIER

This image is a representation of the package family, actual package may vary.  
Refer to the product data sheet for package details.



4229370VA\

J 14

**GENERIC PACKAGE VIEW**  
**CDIP - 5.08 mm max height**  
CERAMIC DUAL IN LINE PACKAGE



Images above are just a representation of the package family, actual package may vary.  
Refer to the product data sheet for package details.

4040083-5/G

J0014A



# PACKAGE OUTLINE

CDIP - 5.08 mm max height

CERAMIC DUAL IN LINE PACKAGE



4214771/A 05/2017

NOTES:

1. All controlling linear dimensions are in inches. Dimensions in brackets are in millimeters. Any dimension in brackets or parenthesis are for reference only. Dimensioning and tolerancing per ASME Y14.5M.
2. This drawing is subject to change without notice.
3. This package is hermetically sealed with a ceramic lid using glass frit.
4. Index point is provided on cap for terminal identification only and on press ceramic glass frit seal only.
5. Falls within MIL-STD-1835 and GDIP1-T14.

# EXAMPLE BOARD LAYOUT

J0014A

CDIP - 5.08 mm max height

CERAMIC DUAL IN LINE PACKAGE



LAND PATTERN EXAMPLE  
NON-SOLDER MASK DEFINED  
SCALE: 5X



4214771/A 05/2017

# DDF0008A



# PACKAGE OUTLINE

## SOT-23-THIN - 1.1 mm max height

PLASTIC SMALL OUTLINE



4222047/E 07/2024

### NOTES:

1. All linear dimensions are in millimeters. Any dimensions in parenthesis are for reference only. Dimensioning and tolerancing per ASME Y14.5M.
2. This drawing is subject to change without notice.
3. This dimension does not include mold flash, protrusions, or gate burrs. Mold flash, protrusions, or gate burrs shall not exceed 0.15 mm per side.

# EXAMPLE BOARD LAYOUT

DDF0008A

SOT-23-THIN - 1.1 mm max height

PLASTIC SMALL OUTLINE

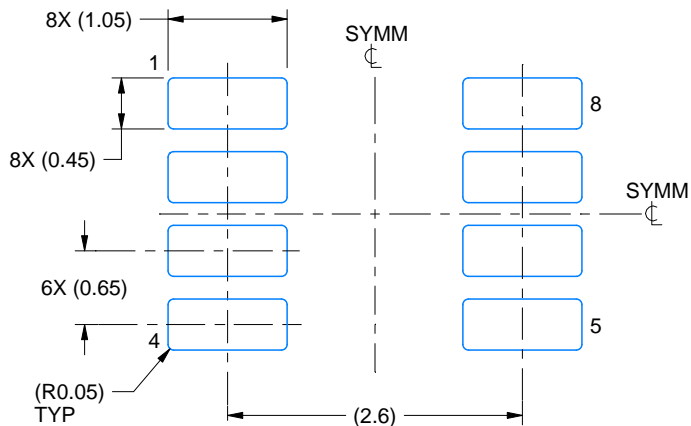

LAND PATTERN EXAMPLE  
EXPOSED METAL SHOWN  
SCALE:15X

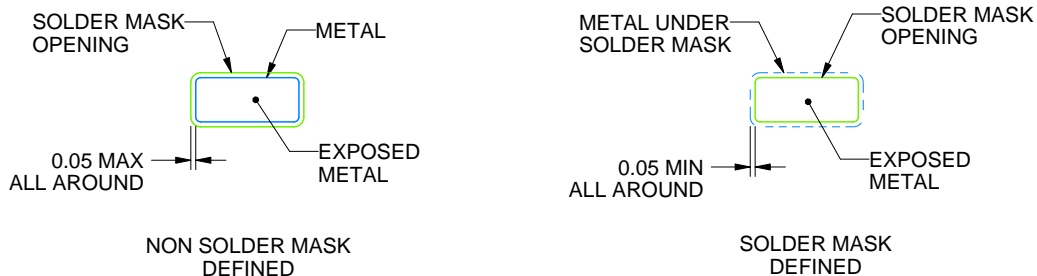

SOLDER MASK DETAILS

4222047/E 07/2024

NOTES: (continued)

- 4. Publication IPC-7351 may have alternate designs.
- 5. Solder mask tolerances between and around signal pads can vary based on board fabrication site.



# EXAMPLE STENCIL DESIGN

DDF0008A

SOT-23-THIN - 1.1 mm max height

PLASTIC SMALL OUTLINE



SOLDER PASTE EXAMPLE  
BASED ON 0.125 mm THICK STENCIL  
SCALE:15X

4222047/E 07/2024

NOTES: (continued)

6. Laser cutting apertures with trapezoidal walls and rounded corners may offer better paste release. IPC-7525 may have alternate design recommendations.
7. Board assembly site may have different recommendations for stencil design.



D0008A

# PACKAGE OUTLINE

SOIC - 1.75 mm max height

SMALL OUTLINE INTEGRATED CIRCUIT



4214825/C 02/2019

NOTES:

1. Linear dimensions are in inches [millimeters]. Dimensions in parenthesis are for reference only. Controlling dimensions are in inches. Dimensioning and tolerancing per ASME Y14.5M.
2. This drawing is subject to change without notice.
3. This dimension does not include mold flash, protrusions, or gate burrs. Mold flash, protrusions, or gate burrs shall not exceed .006 [0.15] per side.
4. This dimension does not include interlead flash.
5. Reference JEDEC registration MS-012, variation AA.

# EXAMPLE BOARD LAYOUT

D0008A

SOIC - 1.75 mm max height

SMALL OUTLINE INTEGRATED CIRCUIT



LAND PATTERN EXAMPLE  
EXPOSED METAL SHOWN  
SCALE:8X



SOLDER MASK DETAILS

4214825/C 02/2019

NOTES: (continued)

6. Publication IPC-7351 may have alternate designs.

7. Solder mask tolerances between and around signal pads can vary based on board fabrication site.

# EXAMPLE STENCIL DESIGN

D0008A

SOIC - 1.75 mm max height

SMALL OUTLINE INTEGRATED CIRCUIT



SOLDER PASTE EXAMPLE  
BASED ON .005 INCH [0.125 MM] THICK STENCIL  
SCALE:8X

4214825/C 02/2019

NOTES: (continued)

8. Laser cutting apertures with trapezoidal walls and rounded corners may offer better paste release. IPC-7525 may have alternate design recommendations.
9. Board assembly site may have different recommendations for stencil design.

# MECHANICAL DATA

PS (R-PDSO-G8)

PLASTIC SMALL-OUTLINE PACKAGE

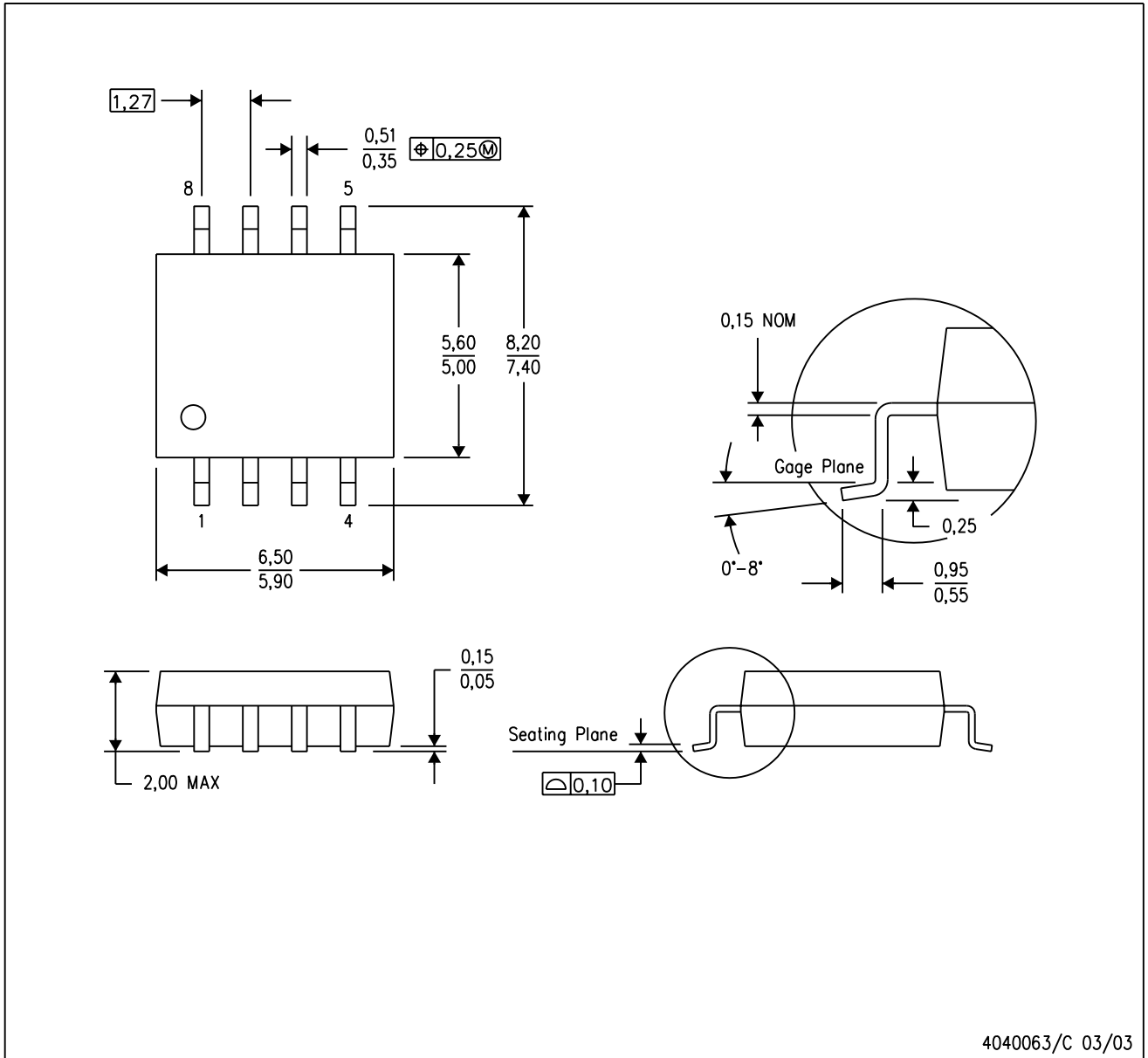

- NOTES:
- A. All linear dimensions are in millimeters.
  - B. This drawing is subject to change without notice.
  - C. Body dimensions do not include mold flash or protrusion, not to exceed 0,15.

PS (R-PDSO-G8)

PLASTIC SMALL OUTLINE



- NOTES:
- All linear dimensions are in millimeters.
  - This drawing is subject to change without notice.
  - Publication IPC-7351 is recommended for alternate designs.
  - Laser cutting apertures with trapezoidal walls and also rounding corners will offer better paste release. Customers should contact their board assembly site for stencil design recommendations. Refer to IPC-7525 for other stencil recommendations.
  - Customers should contact their board fabrication site for solder mask tolerances between and around signal pads.

P (R-PDIP-T8)

PLASTIC DUAL-IN-LINE PACKAGE

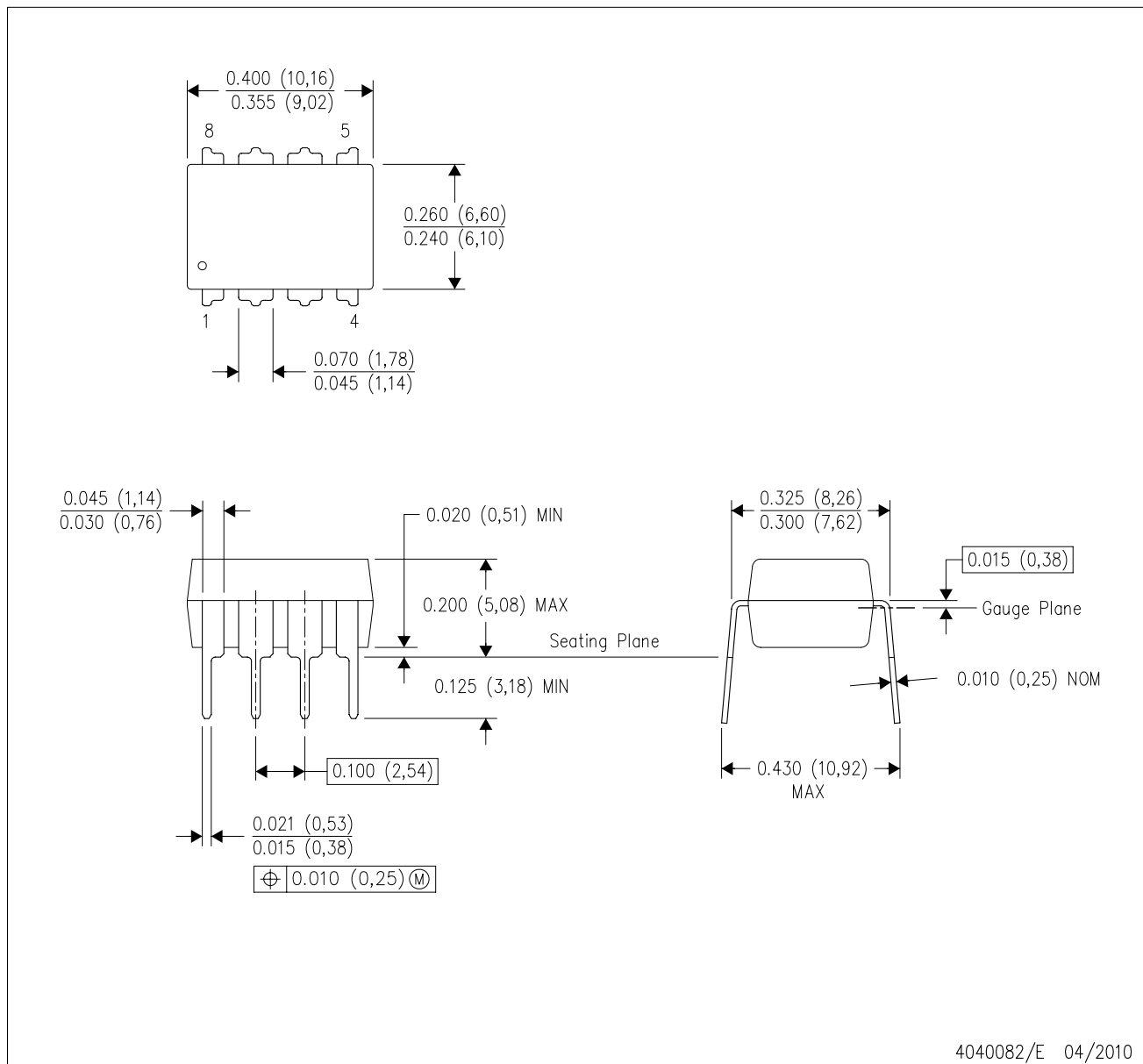

- NOTES:
- A. All linear dimensions are in inches (millimeters).
  - B. This drawing is subject to change without notice.
  - C. Falls within JEDEC MS-001 variation BA.

N (R-PDIP-T\*\*)

PLASTIC DUAL-IN-LINE PACKAGE

16 PINS SHOWN



- NOTES:
- A. All linear dimensions are in inches (millimeters).
  - B. This drawing is subject to change without notice.
  - $\triangle C$  Falls within JEDEC MS-001, except 18 and 20 pin minimum body length (Dim A).
  - $\triangle D$  The 20 pin end lead shoulder width is a vendor option, either half or full width.



# DCK0005A



# PACKAGE OUTLINE

SOT - 1.1 max height

SMALL OUTLINE TRANSISTOR

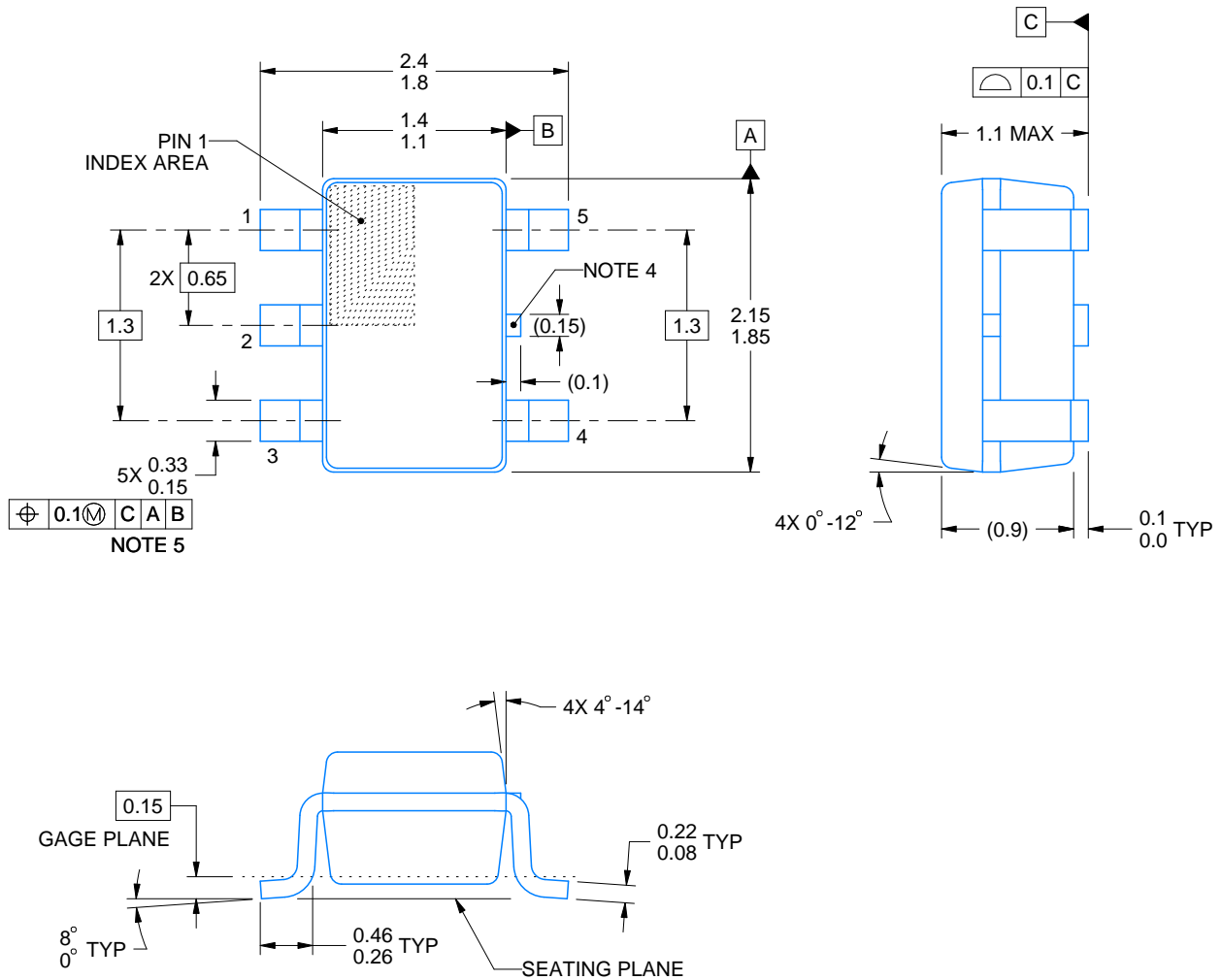

4214834/F 08/2024

## NOTES:

1. All linear dimensions are in millimeters. Any dimensions in parenthesis are for reference only. Dimensioning and tolerancing per ASME Y14.5M.
2. This drawing is subject to change without notice.
3. Reference JEDEC MO-203.
4. Support pin may differ or may not be present.
5. Lead width does not comply with JEDEC.
6. Body dimensions do not include mold flash, protrusions, or gate burrs. Mold flash, protrusions, or gate burrs shall not exceed 0.25mm per side

# EXAMPLE BOARD LAYOUT

DCK0005A

SOT - 1.1 max height

SMALL OUTLINE TRANSISTOR



LAND PATTERN EXAMPLE  
EXPOSED METAL SHOWN  
SCALE:18X

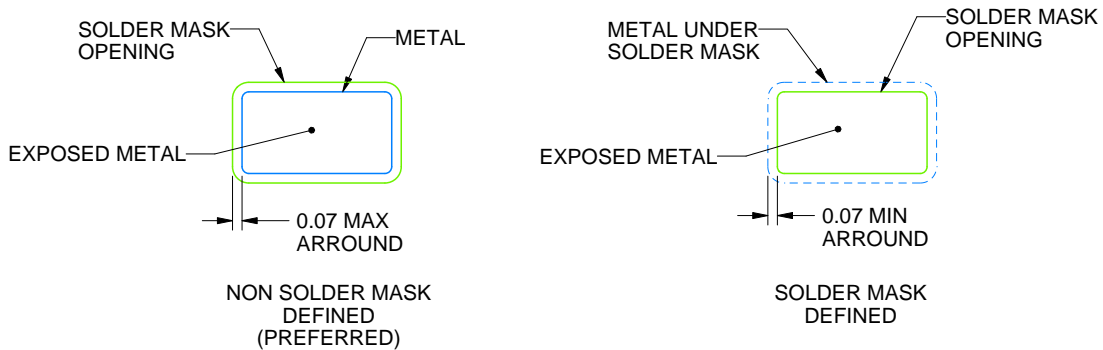

SOLDER MASK DETAILS

4214834/F 08/2024

NOTES: (continued)

7. Publication IPC-7351 may have alternate designs.
8. Solder mask tolerances between and around signal pads can vary based on board fabrication site.

# EXAMPLE STENCIL DESIGN

DCK0005A

SOT - 1.1 max height

SMALL OUTLINE TRANSISTOR



SOLDER PASTE EXAMPLE  
BASED ON 0.125 THICK STENCIL  
SCALE: 18X

4214834/F 08/2024

NOTES: (continued)

9. Laser cutting apertures with trapezoidal walls and rounded corners may offer better paste release. IPC-7525 may have alternate design recommendations.
10. Board assembly site may have different recommendations for stencil design.

PW0014A

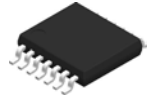

**PACKAGE OUTLINE**  
**TSSOP - 1.2 mm max height**

SMALL OUTLINE PACKAGE

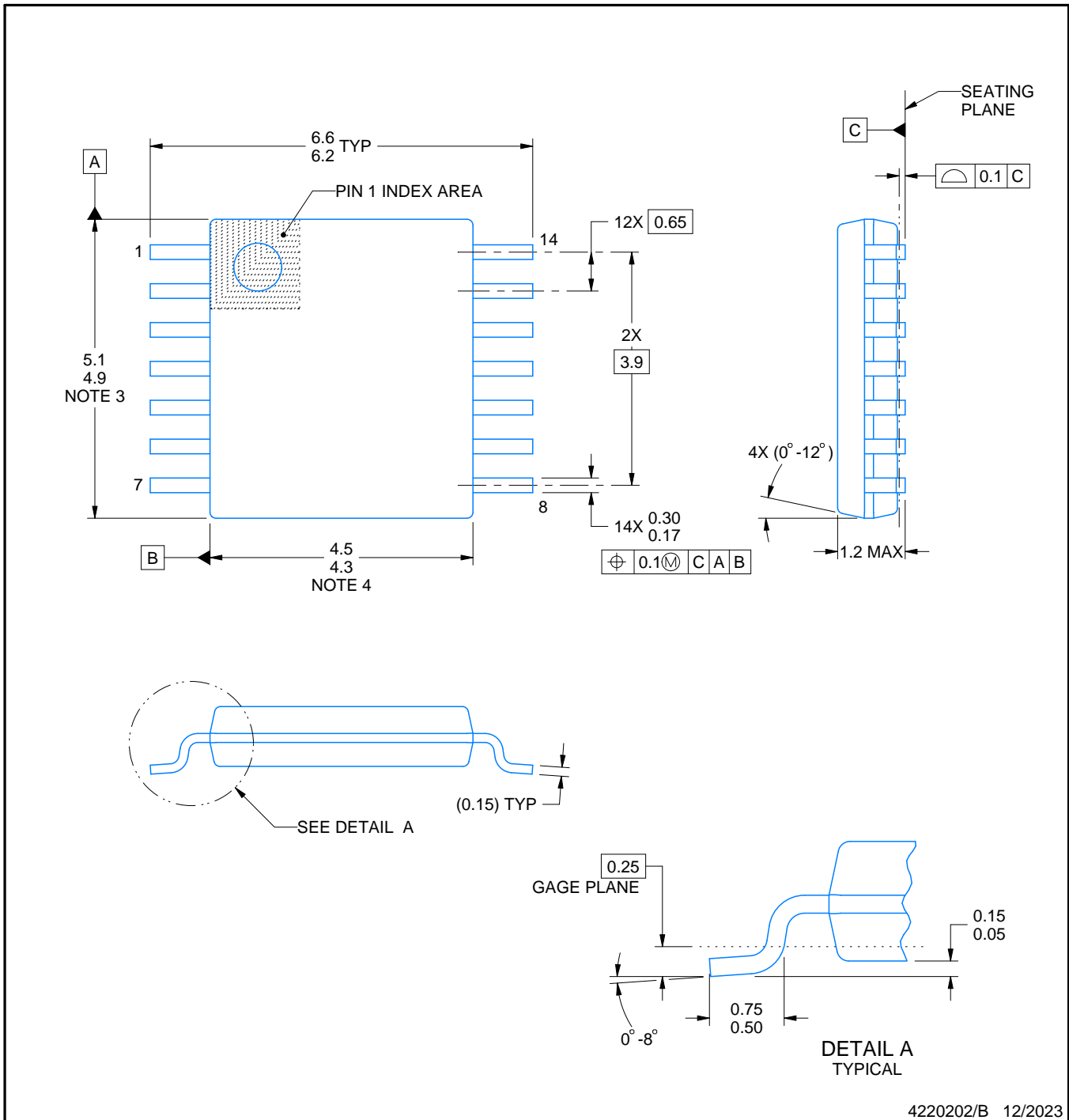

4220202/B 12/2023

NOTES:

1. All linear dimensions are in millimeters. Any dimensions in parenthesis are for reference only. Dimensioning and tolerancing per ASME Y14.5M.
2. This drawing is subject to change without notice.
3. This dimension does not include mold flash, protrusions, or gate burrs. Mold flash, protrusions, or gate burrs shall not exceed 0.15 mm per side.
4. This dimension does not include interlead flash. Interlead flash shall not exceed 0.25 mm per side.
5. Reference JEDEC registration MO-153.

# EXAMPLE BOARD LAYOUT

PW0014A

TSSOP - 1.2 mm max height

SMALL OUTLINE PACKAGE



LAND PATTERN EXAMPLE  
EXPOSED METAL SHOWN  
SCALE: 10X



4220202/B 12/2023

NOTES: (continued)

6. Publication IPC-7351 may have alternate designs.
7. Solder mask tolerances between and around signal pads can vary based on board fabrication site.

# EXAMPLE STENCIL DESIGN

PW0014A

TSSOP - 1.2 mm max height

SMALL OUTLINE PACKAGE



SOLDER PASTE EXAMPLE  
BASED ON 0.125 mm THICK STENCIL  
SCALE: 10X

4220202/B 12/2023

NOTES: (continued)

8. Laser cutting apertures with trapezoidal walls and rounded corners may offer better paste release. IPC-7525 may have alternate design recommendations.
9. Board assembly site may have different recommendations for stencil design.

PW0008A



# PACKAGE OUTLINE

## TSSOP - 1.2 mm max height

SMALL OUTLINE PACKAGE



4221848/A 02/2015

### NOTES:

1. All linear dimensions are in millimeters. Any dimensions in parenthesis are for reference only. Dimensioning and tolerancing per ASME Y14.5M.
2. This drawing is subject to change without notice.
3. This dimension does not include mold flash, protrusions, or gate burrs. Mold flash, protrusions, or gate burrs shall not exceed 0.15 mm per side.
4. This dimension does not include interlead flash. Interlead flash shall not exceed 0.25 mm per side.
5. Reference JEDEC registration MO-153, variation AA.

# EXAMPLE BOARD LAYOUT

PW0008A

TSSOP - 1.2 mm max height

SMALL OUTLINE PACKAGE



LAND PATTERN EXAMPLE  
SCALE:10X



SOLDER MASK DETAILS  
NOT TO SCALE

4221848/A 02/2015

NOTES: (continued)

- 6. Publication IPC-7351 may have alternate designs.
- 7. Solder mask tolerances between and around signal pads can vary based on board fabrication site.



# EXAMPLE STENCIL DESIGN

PW0008A

TSSOP - 1.2 mm max height

SMALL OUTLINE PACKAGE



SOLDER PASTE EXAMPLE  
BASED ON 0.125 mm THICK STENCIL  
SCALE:10X

4221848/A 02/2015

NOTES: (continued)

8. Laser cutting apertures with trapezoidal walls and rounded corners may offer better paste release. IPC-7525 may have alternate design recommendations.
9. Board assembly site may have different recommendations for stencil design.

## IMPORTANT NOTICE AND DISCLAIMER

TI PROVIDES TECHNICAL AND RELIABILITY DATA (INCLUDING DATA SHEETS), DESIGN RESOURCES (INCLUDING REFERENCE DESIGNS), APPLICATION OR OTHER DESIGN ADVICE, WEB TOOLS, SAFETY INFORMATION, AND OTHER RESOURCES "AS IS" AND WITH ALL FAULTS, AND DISCLAIMS ALL WARRANTIES, EXPRESS AND IMPLIED, INCLUDING WITHOUT LIMITATION ANY IMPLIED WARRANTIES OF MERCHANTABILITY, FITNESS FOR A PARTICULAR PURPOSE OR NON-INFRINGEMENT OF THIRD PARTY INTELLECTUAL PROPERTY RIGHTS.

These resources are intended for skilled developers designing with TI products. You are solely responsible for (1) selecting the appropriate TI products for your application, (2) designing, validating and testing your application, and (3) ensuring your application meets applicable standards, and any other safety, security, regulatory or other requirements.

These resources are subject to change without notice. TI grants you permission to use these resources only for development of an application that uses the TI products described in the resource. Other reproduction and display of these resources is prohibited. No license is granted to any other TI intellectual property right or to any third party intellectual property right. TI disclaims responsibility for, and you will fully indemnify TI and its representatives against, any claims, damages, costs, losses, and liabilities arising out of your use of these resources.

TI's products are provided subject to [TI's Terms of Sale](#) or other applicable terms available either on [ti.com](https://www.ti.com) or provided in conjunction with such TI products. TI's provision of these resources does not expand or otherwise alter TI's applicable warranties or warranty disclaimers for TI products.

TI objects to and rejects any additional or different terms you may have proposed.

Mailing Address: Texas Instruments, Post Office Box 655303, Dallas, Texas 75265  
Copyright © 2024, Texas Instruments Incorporated