

## Dual Channel 12-Bit 500Mps Analog-to-Digital Converter

Check for Samples: [ADS5404](#)

### FEATURES

- Dual Channel
- 12-Bit Resolution
- Maximum Clock Rate: 500 Msps
- Low Swing Fullscale Input: 1.0 Vpp
- Analog Input Buffer with High Impedance Input
- Input Bandwidth (3 dB): >1.2 GHz
- Data Output Interface: DDR LVDS
- 196-Pin BGA Package (12x12mm)
- Power Dissipation: 910 mW/ch
- Performance at  $f_{in} = 230$  MHz IF
  - SNR: 60.6 dBFS
  - SFDR: 77 dBc
- Performance at  $f_{in} = 700$  MHz IF
  - SNR: 59.4 dBFS
  - SFDR: 70 dBc

### APPLICATIONS

- Test and Measurement Instrumentation
- Ultra-Wide Band Software Defined Radio
- Data Acquisition
- Power Amplifier Linearization
- Signal Intelligence and Jamming
- Radar and Satellite Systems
- Microwave Receivers

### DESCRIPTION

The ADS5404 is a high linearity dual channel 12-bit, 500 MSPS analog-to-digital converter (ADC) easing front end filter design for wide bandwidth receivers. The analog input buffer isolates the internal switching of the on-chip track-and-hold from disturbing the signal source as well as providing a high-impedance input. Optionally the output data can be decimated by two. Designed for high SFDR, the ADC has low-noise performance and outstanding spurious-free dynamic range over a large input-frequency range. The device is available in a 196-pin BGA package and is specified over the full industrial temperature range (–40°C to 85°C).

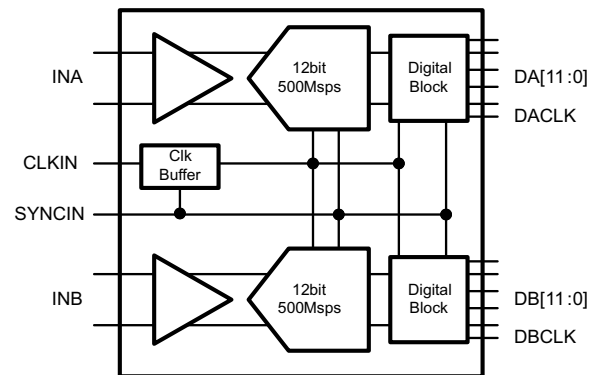

| Device Part No. | Number of Channels | Speed Grade |
|-----------------|--------------------|-------------|
| ADS5402         | 2                  | 800Msps     |
| ADS5401         | 1                  | 800Msps     |
| ADS5404         | 2                  | 500Msps     |
| ADS5403         | 1                  | 500Msps     |
| ADS5407         | 2                  | 500Msps     |
| ADS5409         | 2                  | 900Msps     |



Please be aware that an important notice concerning availability, standard warranty, and use in critical applications of Texas Instruments semiconductor products and disclaimers thereto appears at the end of this data sheet.



This integrated circuit can be damaged by ESD. Texas Instruments recommends that all integrated circuits be handled with appropriate precautions. Failure to observe proper handling and installation procedures can cause damage.

ESD damage can range from subtle performance degradation to complete device failure. Precision integrated circuits may be more susceptible to damage because very small parametric changes could cause the device not to meet its published specifications.

### DETAILED BLOCK DIAGRAM

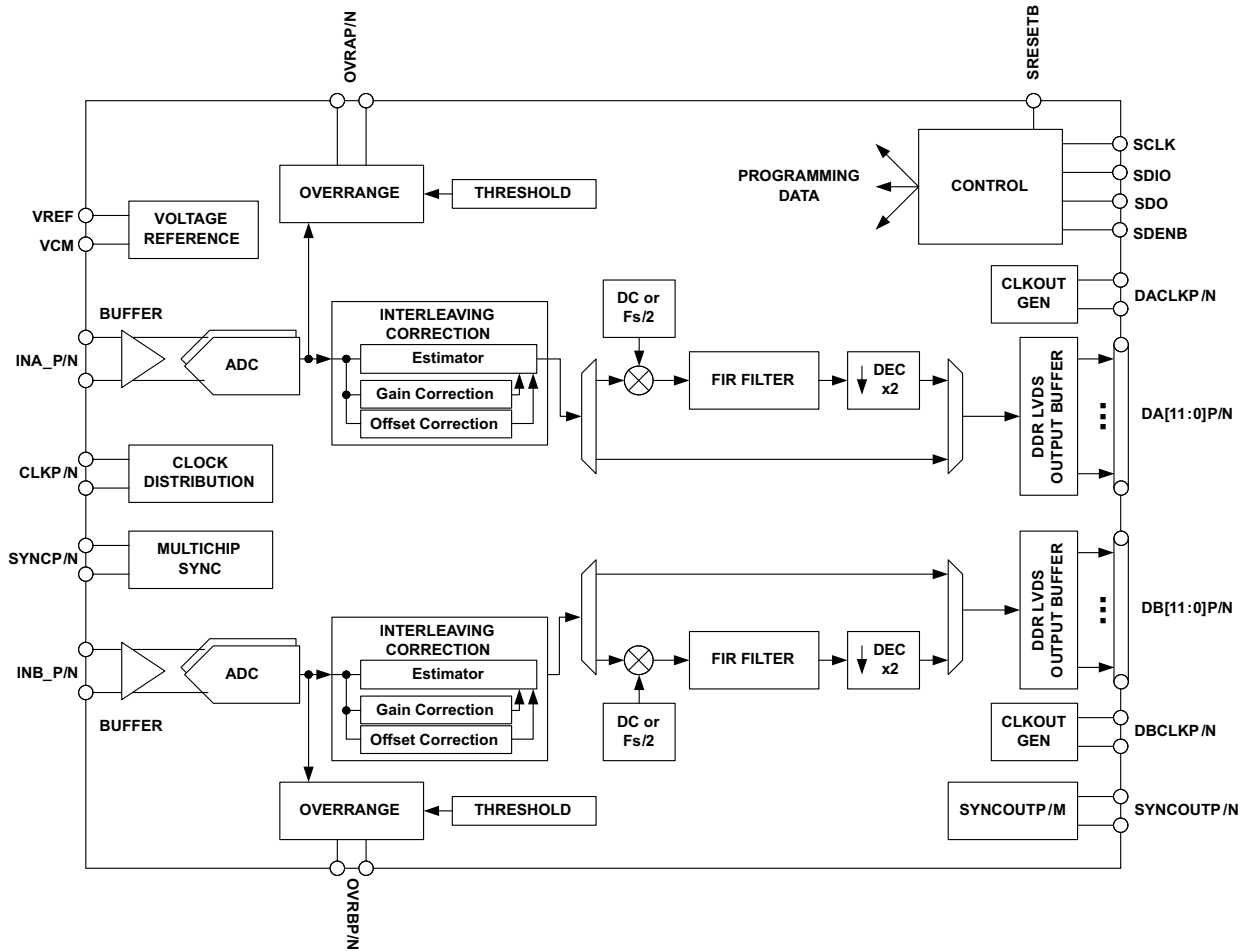

Figure 1. Detailed Block Diagram

### PINOUT INFORMATION

|    | A     | B         | C         | D         | E      | F         | G      | H      | J      | K      | L         | M         | N         | P         |    |
|----|-------|-----------|-----------|-----------|--------|-----------|--------|--------|--------|--------|-----------|-----------|-----------|-----------|----|
| 14 | VREF  | VCM       | GND       | INB_N     | INB_P  | GND       | AVDDC  | AVDDC  | GND    | INA_P  | INA_N     | GND       | GND       | CLKINP    | 14 |
| 13 | SDENB | TEST MODE | GND       | GND       | GND    | GND       | GND    | GND    | GND    | GND    | GND       | GND       | GND       | CLKINN    | 13 |
| 12 | SCLK  | SRESET B  | GND       | AVDD33    | AVDD33 | AVDD33    | AVDD33 | AVDD33 | AVDD33 | AVDD33 | AVDD33    | GND       | AVDD33    | AVDD33    | 12 |
| 11 | SDIO  | ENABLE    | GND       | AVDD18    | AVDD18 | AVDD18    | AVDD18 | AVDD18 | AVDD18 | AVDD18 | AVDD18    | GND       | AVDD18    | AVDD18    | 11 |
| 10 | SDO   | IOVDD     | GND       | AVDD18    | GND    | GND       | GND    | GND    | GND    | GND    | AVDD18    | GND       | NC        | NC        | 10 |
| 9  | DVDD  | DVDD      | GND       | GND       | GND    | GND       | GND    | GND    | GND    | GND    | GND       | GND       | SYNCP     | SYNCP     | 9  |
| 8  | DVDD  | DVDD      | DVDD      | DVDD      | GND    | GND       | GND    | GND    | GND    | GND    | DVDD      | DVDD      | DVDD      | DVDD      | 8  |
| 7  | DB0N  | DB0P      | DVDD LVDS | DVDD LVDS | GND    | GND       | GND    | GND    | GND    | GND    | DVDD LVDS | DVDD LVDS | NC        | NC        | 7  |
| 6  | DB1N  | DB1P      | DVDD LVDS | DVDD LVDS | GND    | GND       | GND    | GND    | GND    | GND    | DVDD LVDS | DVDD LVDS | NC        | NC        | 6  |
| 5  | DB2N  | DB2P      | OVRBN     | OVRBP     | GND    | GND       | GND    | GND    | GND    | GND    | OVRAN     | OVRAP     | SYNC OUTN | SYNC OUTP | 5  |
| 4  | DB3N  | DB3P      | DB8P      | DB10P     | NC     | NC        | NC     | DA0P   | DA2P   | DA4P   | DA6P      | DA8P      | NC        | NC        | 4  |
| 3  | DB4N  | DB4P      | DB8N      | DB10N     | NC     | NC        | NC     | DA0N   | DA2N   | DA4N   | DA6N      | DA8N      | DA11N     | DA11P     | 3  |
| 2  | DB5N  | DB5P      | DB7P      | DB9P      | DB11P  | SYNC OUTP | DBCLKP | DACLKP | DA1P   | DA3P   | DA5P      | DA7P      | DA10N     | DA10P     | 2  |
| 1  | DB6N  | DB6P      | DB7N      | DB9N      | DB11N  | SYNC OUTN | DBCLKN | DACLKN | DA1N   | DA3N   | DA5N      | DA7N      | DA9N      | DA9P      | 1  |
|    | A     | B         | C         | D         | E      | F         | G      | H      | J      | K      | L         | M         | N         | P         |    |

**Figure 2. Pinout in DDR output mode (top down view)**

### PIN ASSIGNMENTS

| PIN                    |          | I/O | DESCRIPTION  |
|------------------------|----------|-----|--|
| NAME                   | NUMBER   |     |  |
| <b>INPUT/REFERENCE</b> |          |     |  |
| INA_P/N                | K14, L14 | I   | Analog ADC A differential input signal.  |
| INB_P/N                | E14, D14 | I   | Analog ADC B differential input signal.  |
| VCM                    | B14      | O   | Output of the analog input common mode (nominally 1.9V). A 0.1µF capacitor to AGND is recommended.   |
| VREF                   | A14      | I   | Reference voltage input. A 0.1µF capacitor to AGND is recommended, but not required.   |
| <b>CLOCK/SYNC</b>      |          |     |  |
| CLKINP/N               | P14, P13 | I   | Differential input clock   |
| SYNCP/N                | P9, N9   | I   | Synchronization input. Inactive if logic low. When clocked in a high state initially, this is used for resetting internal clocks and digital logic and starting the SYNCOUT signal. Internal 100Ω termination. |
| <b>CONTROL/SERIAL</b>  |          |     |  |
| SRESET                 | B12      | I   | Serial interface reset input. Active low. Initialized internal registers during high to low transition. Asynchronous. Internal 50kΩ pull up resistor to IOVDD.   |

**PIN ASSIGNMENTS (continued)**

| PIN                   |  | I/O | DESCRIPTION  |
|-----------------------|--|-----|--|
| NAME                  | NUMBER   |     |  |
| ENABLE                | B11  | I   | Chip enable – active high. Power down function can be controlled through SPI register assignment. Internal 50kΩ pull up resistor to IOVDD.   |
| SCLK                  | A12  | I   | Serial interface clock. Internal 50kΩ pull-down resistor.  |
| SDIO                  | A11  | I/O | Bi-directional serial data in 3 pin mode (default). In 4-pin interface mode (register x00, D16), the SDIO pin in an input only. Internal 50kΩ pull-down.   |
| SDENB                 | A13  | I   | Serial interface enable. Internal 50kΩ pull-down resistor.   |
| SDO                   | A10  | O   | Uni-directional serial interface data in 4 pin mode (register x00, D16). The SDO pin is tri-stated in 3-pin interface mode (default). Internal 50kΩ pull-down resistor.                              |
| TESTMODE              | B13  | –   | Factory internal test, do not connect  |
| <b>DATA INTERFACE</b> |  |     |  |
| DA[11:0]P/N           | P3, N3, P2, N2, P1, N1, M4, M3, M2, M1, L4, L3, L2, L1, K4, K3, K2, K1, J4, J3, J2, J1, H4, H3 | O   | ADC A Data Bits 11 (MSB) to 0 (LSB) in DDR output mode. Standard LVDS output.  |
| DB[11:0]P/N           | E2, E1, D4, D3, D2, D1, C4, C3, C2, C1, B1, A1, B2, A2, B3, A3, B4, A4, B5, A5, B6, A6, B7, A7 | O   | ADC B Data Bits 11 (MSB) to 0 (LSB) in DDR output mode. Standard LVDS output.  |
| DACLKP/N              | H2, H1   | O   | DDR differential output data clock for Bus A. Register programmable to provide either rising or falling edge to center of stable data nominal timing.  |
| DBCLKP/N              | G2, G1   | O   | DDR differential output data clock for Bus B. Register programmable to provide either rising or falling edge to center of stable data nominal timing. Optionally Bus B can be latched with DACLKP/N. |
| SYNCOUTP/N            | F2, F1, P5, N5   | O   | Synchronization output signal for synchronizing multiple ADCs. Can be disabled via SPI.  |
| OVRAP/N               | M5, L5   | O   | Bus A, Overrange indicator, LVDS output. A logic high signals an analog input in excess of the full-scale range. Optional SYNC output.   |
| OVRBP/N               | D5, C5   | O   | Bus B, Overrange indicator, LVDS output. A logic high signals an analog input in excess of the full-scale range. Optional SYNC output.   |
| NC                    | E3, E4, F3, F4, G3, G4, N4, N6, N7, N10, P4, P6, P7, P10                                       | –   | Don't connect to pin   |
| <b>POWER SUPPLY</b>   |  |     |  |
| AVDD33                | D12, E12, F12, G12, H12, J12, K12, L12, N12, P12   | I   | 3.3V analog supply   |
| AVDDC                 | G14, H14   | I   | 1.8V supply for clock input  |
| AVDD18                | D10, D11, E11, F11, G11, H11, J11, K11, L10, L11, N11, P11                                     | I   | 1.8V analog supply   |
| DVDD                  | A8, A9, B8, B9, C8, D8, L8, M8, N8, P8   | I   | 1.8V supply for digital block  |
| DVDDLVD               | C6, C7, D6, D7, L6, L7, M6, M7   | I   | 1.8V supply for LVDS outputs   |
| IOVDD                 | B10  | I   | 1.8V for digital I/Os  |
| GND                   |  | I   | Ground   |

**PACKAGE/ORDERING INFORMATION**

| PRODUCT | PACKAGE-LEAD | PACKAGE DESIGNATOR | SPECIFIED TEMPERATURE RANGE | ECO PLAN <sup>(2)</sup>       | LEAD/BALL FINISH | PACKAGE MARKING | ORDERING NUMBER | TRANSPORT MEDIA, QUANTITY |
|---------|--------------|--------------------|-----------------------------|-------------------------------|------------------|-----------------|-----------------|---------------------------|
| ADS5404 | 196-BGA      | ZAY                | -40°C to 85°C               | GREEN<br>(RoHS & no<br>Sb/Br) |                  | ADS5404I        | ADS5404IZAY     | Tray                      |
|         |              |                    |                             |                               |                  |                 | ADS5404IZAYR    | Tape and Reel             |

**ABSOLUTE MAXIMUM RATINGS**

over operating free-air temperature range (unless otherwise noted)

|  | VALUE                                  |      | UNIT         |   |
|--|--|------|--------------|---|
|  | MIN                                    | MAX  |              |   |
| Supply voltage range, AVDD33                         | -0.5                                   | 4    | V            |   |
| Supply voltage range, AVDDC                          | -0.5                                   | 2.3  | V            |   |
| Supply voltage range, AVDD18                         | -0.5                                   | 2.3  | V            |   |
| Supply voltage range, DVDD                           | -0.5                                   | 2.3  | V            |   |
| Supply voltage range, DVDDLVD                        | -0.5                                   | 2.3  | V            |   |
| Supply voltage range, IOVDD                          | -0.5                                   | 4    | V            |   |
| Voltage applied to input pins                        | INA/B_P, INA/B_N                       | -0.5 | AVDD33 + 0.5 | V |
|  | CLKINP, CLKINN                         | -0.5 | AVDDC + 0.5  | V |
|  | SYNCP, SYNCN                           | -0.5 | AVDD33 + 0.5 | V |
|  | SRESET, SDENB, SCLK, SDIO, SDO, ENABLE | -0.5 | IOVDD + 0.5  | V |
| Operating free-air temperature range, T <sub>A</sub> | -40                                    | 85   | °C           |   |
| Operating junction temperature range, T <sub>J</sub> |  | 150  | °C           |   |
| Storage temperature range                            | -65                                    | 150  | °C           |   |
| ESD, Human Body Model                                |  | 2    | kV           |   |

**THERMAL INFORMATION**

| THERMAL METRIC <sup>(1)</sup> |   | ADS5404  | UNITS |
|-------------------------------|---|----------|-------|
|                               |   | nFBGA    |       |
|                               |   | 196 PINS |       |
| $\theta_{JA}$                 | Junction-to-ambient thermal resistance <sup>(2)</sup>       | 37.6     | °C/W  |
| $\theta_{JCTop}$              | Junction-to-case (top) thermal resistance <sup>(3)</sup>    | 6.8      |       |
| $\theta_{JB}$                 | Junction-to-board thermal resistance <sup>(4)</sup>         | 16.8     |       |
| $\psi_{JT}$                   | Junction-to-top characterization parameter <sup>(5)</sup>   | 0.2      |       |
| $\psi_{JB}$                   | Junction-to-board characterization parameter <sup>(6)</sup> | 16.4     |       |

- (1) For more information about traditional and new thermal metrics, see the *IC Package Thermal Metrics* application report, [SPRA953](#).
- (2) The junction-to-ambient thermal resistance under natural convection is obtained in a simulation on a JEDEC-standard, high-K board, as specified in JESD51-7, in an environment described in JESD51-2a.
- (3) The junction-to-case (top) thermal resistance is obtained by simulating a cold plate test on the package top. No specific JEDEC-standard test exists, but a close description can be found in the ANSI SEMI standard G30-88.
- (4) The junction-to-board thermal resistance is obtained by simulating in an environment with a ring cold plate fixture to control the PCB temperature, as described in JESD51-8.
- (5) The junction-to-top characterization parameter,  $\psi_{JT}$ , estimates the junction temperature of a device in a real system and is extracted from the simulation data for obtaining  $\theta_{JA}$ , using a procedure described in JESD51-2a (sections 6 and 7).
- (6) The junction-to-board characterization parameter,  $\psi_{JB}$ , estimates the junction temperature of a device in a real system and is extracted from the simulation data for obtaining  $\theta_{JA}$ , using a procedure described in JESD51-2a (sections 6 and 7).

## RECOMMENDED OPERATING CONDITIONS

over operating free-air temperature range (unless otherwise noted)

|                |   | MIN | NOM | MAX | UNIT |
|----------------|---|-----|-----|-----|------|
| T <sub>J</sub> | Recommended operating junction temperature                  | 105 |     |     | °C   |
|                | Maximum rated operating junction temperature <sup>(1)</sup> | 125 |     |     |      |
| T <sub>A</sub> | Recommended free-air temperature                            | -40 | 25  | 85  | °C   |

(1) Prolonged use at this junction temperature may increase the device failure-in-time (FIT) rate.

## ELECTRICAL CHARACTERISTICS

Typical values at T<sub>A</sub> = 25°C, full temperature range is T<sub>MIN</sub> = -40°C to T<sub>MAX</sub> = 85°C, ADC sampling rate = 500MSPS, 50% clock duty cycle, AVDD33 = 3.3V, AVDDC/AVDD18/DVDD/DVDDLVD/IOVDD = 1.8V, -1dBFS differential input (unless otherwise noted).

| PARAMETER                          | TEST CONDITIONS                 | MIN  | TYP  | MAX  | UNITS |
|------------------------------------|---------------------------------|--|------|------|-------|
| <b>ADC Clock Frequency</b>         |                                 | 40   |      | 500  | MSPS  |
| <b>Resolution</b>                  |                                 | 12   |      |      | Bits  |
| <b>SUPPLY</b>                      |                                 |  |      |      |       |
| AVDD33                             |                                 | 3.15   | 3.3  | 3.45 | V     |
| AVDDC, AVDD18, DVDD, DVDDLVD       |                                 | 1.7  | 1.8  | 1.9  | V     |
| IOVDD                              |                                 | 1.7  | 1.8  | 3.45 | V     |
| <b>POWER SUPPLY</b>                |                                 |  |      |      |       |
| I <sub>AVDD33</sub>                | 3.3V Analog supply current      |  | 297  | 330  | mA    |
| I <sub>AVDD18</sub>                | 1.8V Analog supply current      |  | 84   | 100  | mA    |
| I <sub>AVDDC</sub>                 | 1.8V Clock supply current       |  | 26   | 45   | mA    |
| I <sub>DVDD</sub>                  | 1.8V Digital supply current     | Auto correction enabled                              | 230  | 260  | mA    |
| I <sub>DVDD</sub>                  | 1.8V Digital supply current     | Auto correction disabled                             | 106  |      | mA    |
| I <sub>DVDD</sub>                  | 1.8V Digital supply current     | Auto correction disabled, decimation filter enabled  | 135  |      | mA    |
| I <sub>DVDDLVD</sub>               | 1.8V LVDS supply current        |  | 140  | 170  | mA    |
| I <sub>IOVDD</sub>                 | 1.8V I/O Voltage supply current |  | 1    | 2    | mA    |
| P <sub>dis</sub>                   | Total power dissipation         | Auto correction enabled, decimation filter disabled  | 1.84 |      | W     |
| P <sub>dis</sub>                   | Total power dissipation         | Auto correction disabled, decimation filter disabled | 1.62 |      | W     |
| PSRR                               | 250 kHz to 500 MHz              | 40   |      |      | dB    |
| Shut-down power dissipation        |                                 |  | 7    |      | mW    |
| Shut-down wake up time             |                                 |  | 2.5  |      | ms    |
| Standby power dissipation          |                                 |  | 7    |      | mW    |
| Standby wake up time               |                                 |  | 100  |      | µs    |
| Deep-sleep mode power dissipation  | Auto correction disabled        |  | 282  |      | mW    |
|                                    | Auto correction enabled         |  | 370  |      | mW    |
| Deep-sleep mode wakeup time        |                                 |  | 20   |      | µs    |
| Light-sleep mode power dissipation | Auto correction disabled        |  | 549  |      | mW    |
|                                    | Auto correction enabled         |  | 650  |      | mW    |
| Light-sleep mode wakeup time       |                                 |  | 2    |      | µs    |

## ELECTRICAL CHARACTERISTICS

Typical values at  $T_A = 25^\circ\text{C}$ , full temperature range is  $T_{\text{MIN}} = -40^\circ\text{C}$  to  $T_{\text{MAX}} = 85^\circ\text{C}$ , ADC sampling rate = 500MSPS, 50% clock duty cycle,  $\text{AVDD3V} = 3.3\text{V}$ ,  $\text{AVDD/DRVDD/IOVDD} = 1.8\text{V}$ ,  $-1\text{dBFS}$  differential input (unless otherwise noted).

| PARAMETER                      | TEST CONDITIONS                  | MIN | TYP   | MAX  | UNITS           |
|--------------------------------|----------------------------------|-----|-------|------|-----------------|
| <b>ANALOG INPUTS</b>           |                                  |     |       |      |                 |
| Differential input full-scale  |                                  |     | 1.0   | 1.25 | V <sub>pp</sub> |
| Input common mode voltage      |                                  |     | 1.9   | ±0.1 | V               |
| Input resistance               | Differential at DC               |     | 1     |      | kΩ              |
| Input capacitance              | Each input to GND                |     | 2     |      | pF              |
| VCM common mode voltage output |                                  |     | 1.9   |      | V               |
| Analog input bandwidth (3dB)   |                                  |     | 1200  |      | MHz             |
| <b>DYNAMIC ACCURACY</b>        |                                  |     |       |      |                 |
| Offset Error                   | Auto correction disabled         | -20 | -7.5  | 20   | mV              |
|                                | Auto correction enabled          | -1  | 0     | 1    | mV              |
| Offset temperature coefficient |                                  |     | -611  |      | μV/°C           |
| Gain error                     |                                  | -5  |       | 5    | %FS             |
| Gain temperature coefficient   |                                  |     | 0.005 |      | %FS/°C          |
| Differential nonlinearity      | $f_{\text{IN}} = 230\text{ MHz}$ | -1  | ±0.9  | 2    | LSB             |
| Integral nonlinearity          | $f_{\text{IN}} = 230\text{ MHz}$ | -5  | ±1.5  | 5    | LSB             |
| <b>CLOCK INPUT</b>             |                                  |     |       |      |                 |
| Input clock frequency          |                                  | 40  |       | 500  | MHz             |
| Input clock amplitude          |                                  |     | 2     |      | V <sub>pp</sub> |
| Input clock duty cycle         |                                  | 40% | 50%   | 60%  |                 |
| Internal clock biasing         |                                  |     | 0.9   |      | V               |

### ELECTRICAL CHARACTERISTICS

Typical values at  $T_A = 25^\circ\text{C}$ , full temperature range is  $T_{\text{MIN}} = -40^\circ\text{C}$  to  $T_{\text{MAX}} = 85^\circ\text{C}$ , ADC sampling rate = 500MSPS, 50% clock duty cycle, AVDD33 = 3.3V, AVDDC/AVDD18/DVDD/DVDDLVD/IOVDD = 1.8V, -1dBFS differential input (unless otherwise noted).

| PARAMETER                                 |  | TEST CONDITIONS  | MIN     | TYP  | MAX | MIN      | TYP  | MAX | UNITS |
|---|--|--|---------|------|-----|----------|------|-----|-------|
| <b>Auto Correction</b>                    |  |  | Enabled |      |     | Disabled |      |     | Vpp   |
| DYNAMIC AC CHARACTERISTICS <sup>(1)</sup> |  |  |         |      |     |          |      |     |       |
| SNR                                       | Signal to Noise Ratio  | $f_{\text{IN}} = 10 \text{ MHz}$   |         | 60.8 |     |          | 60.8 |     | dBFS  |
|   |  | $f_{\text{IN}} = 100 \text{ MHz}$  |         | 60.7 |     |          | 60.8 |     |       |
|   |  | $f_{\text{IN}} = 230 \text{ MHz}$  | 59      | 60.6 |     |          | 60.7 |     |       |
|   |  | $f_{\text{IN}} = 450 \text{ MHz}$  |         | 60.2 |     |          | 60.6 |     |       |
|   |  | $f_{\text{IN}} = 700 \text{ MHz}$  |         | 59.4 |     |          | 60.1 |     |       |
| HD2,3                                     | Second and third harmonic distortion                                     | $f_{\text{IN}} = 10 \text{ MHz}$   |         | 84   |     |          | 86   |     | dBc   |
|   |  | $f_{\text{IN}} = 100 \text{ MHz}$  |         | 84   |     |          | 82   |     |       |
|   |  | $f_{\text{IN}} = 230 \text{ MHz}$  | 70      | 80   |     |          | 83   |     |       |
|   |  | $f_{\text{IN}} = 450 \text{ MHz}$  |         | 82   |     |          | 84   |     |       |
|   |  | $f_{\text{IN}} = 700 \text{ MHz}$  |         | 76   |     |          | 74   |     |       |
| Non HD2,3                                 | Spur Free Dynamic Range (excluding second and third harmonic distortion) | $f_{\text{IN}} = 10 \text{ MHz}$   |         | 77   |     |          | 78   |     | dBc   |
|   |  | $f_{\text{IN}} = 100 \text{ MHz}$  |         | 77   |     |          | 78   |     |       |
|   |  | $f_{\text{IN}} = 230 \text{ MHz}$  | 70      | 77   |     |          | 77   |     |       |
|   |  | $f_{\text{IN}} = 450 \text{ MHz}$  |         | 74   |     |          | 75   |     |       |
|   |  | $f_{\text{IN}} = 700 \text{ MHz}$  |         | 70   |     |          | 71   |     |       |
| IL  | Fs/2-Fin interleaving spur   | $f_{\text{IN}} = 10 \text{ MHz}$   |         | 92   |     |          | 80   |     | dBc   |
|   |  | $f_{\text{IN}} = 100 \text{ MHz}$  |         | 83   |     |          | 79   |     |       |
|   |  | $f_{\text{IN}} = 230 \text{ MHz}$  | 70      | 83   |     |          | 79   |     |       |
|   |  | $f_{\text{IN}} = 450 \text{ MHz}$  |         | 79   |     |          | 76   |     |       |
|   |  | $f_{\text{IN}} = 700 \text{ MHz}$  |         | 75   |     |          | 73   |     |       |
| SINAD                                     | Signal to noise and distortion ratio                                     | $f_{\text{IN}} = 10 \text{ MHz}$   |         | 60.6 |     |          | 60.7 |     | dBFS  |
|   |  | $f_{\text{IN}} = 100 \text{ MHz}$  |         | 60.6 |     |          | 60.7 |     |       |
|   |  | $f_{\text{IN}} = 230 \text{ MHz}$  | 57.5    | 60.5 |     |          | 60.7 |     |       |
|   |  | $f_{\text{IN}} = 450 \text{ MHz}$  |         | 60.1 |     |          | 60.5 |     |       |
|   |  | $f_{\text{IN}} = 700 \text{ MHz}$  |         | 59.3 |     |          | 60   |     |       |
| THD                                       | Total Harmonic Distortion  | $f_{\text{IN}} = 10 \text{ MHz}$   |         | 76.3 |     |          | 79.0 |     | dBc   |
|   |  | $f_{\text{IN}} = 100 \text{ MHz}$  |         | 76.5 |     |          | 77.6 |     |       |
|   |  | $f_{\text{IN}} = 230 \text{ MHz}$  | 68      | 77.4 |     |          | 78.1 |     |       |
|   |  | $f_{\text{IN}} = 450 \text{ MHz}$  |         | 76.3 |     |          | 77.9 |     |       |
|   |  | $f_{\text{IN}} = 700 \text{ MHz}$  |         | 73.4 |     |          | 72.9 |     |       |
| IMD3                                      | Inter modulation distortion  | $F_{\text{in}} = 129.5 \text{ and } 130.5 \text{ MHz, } -7 \text{ dBFS}$ |         | 82   |     |          | 82   |     | dBFS  |
|   |  | $F_{\text{in}} = 349.5 \text{ and } 350.5 \text{ MHz, } -7 \text{ dBFS}$ |         | 80   |     |          | 80   |     |       |
|   | Crosstalk  |  |         | 90   |     |          | 90   |     | dB    |
| ENOB                                      | Effective number of bits   | $f_{\text{IN}} = 230 \text{ MHz}$  |         | 9.8  |     |          | 9.8  |     | LSB   |

(1) SFDR and SNR calculations do not include the DC or Fs/2 bins when Auto Correction is disabled.



## ELECTRICAL CHARACTERISTICS

Typical values at  $T_A = 25^\circ\text{C}$ , full temperature range is  $T_{\text{MIN}} = -40^\circ\text{C}$  to  $T_{\text{MAX}} = 85^\circ\text{C}$ , ADC sampling rate = 500Mpsps, 50% clock duty cycle, AVDD33 = 3.3V, AVDDC/AVDD18/DVDD/DVDDLVD/IOVDD = 1.8V, –1dBFS differential input (unless otherwise noted).

| PARAMETER                            | TEST CONDITIONS   | MIN | TYP | MAX | UNITS                 |
|--------------------------------------|---|-----|-----|-----|-----------------------|
| <b>OVER-DRIVE RECOVERY ERROR</b>     |   |     |     |     |                       |
| Input overload recovery              | Recovery to within 5% (of final value) for 6dB overload with sine wave input      |     | 2   |     | ns                    |
| <b>SAMPLE TIMING CHARACTERISTICS</b> |   |     |     |     |                       |
| rms Aperture Jitter                  | Sample uncertainty  |     | 100 |     | fs rms                |
| Data Latency                         | ADC sample to digital output, auto correction disabled                            |     | 38  |     | Clock Cycles          |
|                                      | ADC sample to digital output, auto correction enabled                             |     | 50  |     |                       |
|                                      | ADC sample to digital output, Decimation filter enabled, Auto correction disabled |     | 74  |     | Sampling clock Cycles |
| Over-range Latency                   | ADC sample to over-range output   |     | 12  |     | Clock Cycles          |

## ELECTRICAL CHARACTERISTICS

The DC specifications refer to the condition where the digital outputs are not switching, but are permanently at a valid logic level 0 or 1. AVDD33 = 3.3V, AVDDC/AVDD18/DVDD/DVDDLVD/IOVDD = 1.8V

| PARAMETER   | TEST CONDITIONS   | MIN                               | TYP   | MAX          | UNITS         |    |
|---|---|-----------------------------------|-------|--------------|---------------|----|
| <b>DIGITAL INPUTS – SRESET, SCLK, SDENB, SDIO, ENABLE</b>   |   |                                   |       |              |               |    |
| High-level input voltage  | All digital inputs support 1.8V and 3.3V logic levels.                      | 0.7 x IOVDD                       |       |              | V             |    |
| Low-level input voltage   |   |                                   |       | 0.3 x IOVDD  | V             |    |
| High-level input current  |   | –50                               |       | 200          | $\mu\text{A}$ |    |
| Low-level input current   |   | –50                               |       | 50           | $\mu\text{A}$ |    |
| Input capacitance   |   |                                   | 5     |              | pF            |    |
| <b>DIGITAL OUTPUTS – SDO</b>  |   |                                   |       |              |               |    |
| High-level output voltage   | $I_{\text{load}} = -100 \mu\text{A}$  | IOVDD – 0.2                       |       |              | V             |    |
|   | $I_{\text{load}} = -2 \text{ mA}$   | 0.8 x IOVDD                       |       |              |               |    |
| Low-level output voltage  | $I_{\text{load}} = 100 \mu\text{A}$   |                                   |       | 0.2          | V             |    |
|   | $I_{\text{load}} = 2 \text{ mA}$  |                                   |       | 0.22 x IOVDD |               |    |
| <b>DIGITAL INPUTS – SYNC/P/N</b>  |   |                                   |       |              |               |    |
| $V_{\text{ID}}$   | Differential input voltage  | 250                               | 350   | 450          | mV            |    |
| $V_{\text{CM}}$   | Input common mode voltage   | 1.125                             | 1.2   | 1.375        | V             |    |
| $t_{\text{SU}}$   |   | 500                               |       |              | ps            |    |
| <b>DIGITAL OUTPUTS – DA[11:0]P/N, DACLK/P/N, OVRAP/N, SYNCOUTP/N, DB[11:0]P/N, DBCLK/P/N, OVRBP/N</b> |   |                                   |       |              |               |    |
| $V_{\text{OD}}$   | Output differential voltage   | $I_{\text{OUT}} = 3.5 \text{ mA}$ | 250   | 350          | 450           | mV |
| $V_{\text{OCM}}$  | Output common mode voltage  | $I_{\text{OUT}} = 3.5 \text{ mA}$ | 1.125 | 1.25         | 1.375         | V  |
| $t_{\text{suA}}$  | $F_s = 500 \text{ Mpsps}$ , Data valid to zero-crossing of DACLK            | 600                               | 800   |              | ps            |    |
| $t_{\text{hA}}$   | $F_s = 500 \text{ Mpsps}$ , Zero-crossing of DACLK to data becoming invalid | 600                               | 790   |              | ps            |    |
| $t_{\text{suB}}$  | $F_s = 500 \text{ Mpsps}$ , Data valid to zero-crossing of DBCLK            | 700                               | 900   |              | ps            |    |
| $t_{\text{hB}}$   | $F_s = 500 \text{ Mpsps}$ , Zero-crossing of DBCLK to data becoming invalid | 500                               | 600   |              | ps            |    |

### ELECTRICAL CHARACTERISTICS (continued)

The DC specifications refer to the condition where the digital outputs are not switching, but are permanently at a valid logic level 0 or 1. AVDD33 = 3.3V, AVDDC/AVDD18/DVDD/DVDDL/VDS/IOVDD = 1.8V

| PARAMETER  | TEST CONDITIONS   | MIN  | TYP  | MAX  | UNITS |
|------------|---|------|------|------|-------|
| $t_{PD}$   | $F_s = 500$ Msp/s, CLKIN falling edge to DACLK, DBCLK rising edge | 3.28 | 3.48 | 3.74 | ns    |
| $t_{RISE}$ | 10% - 90%   | 100  | 150  | 200  | ps    |
| $t_{FALL}$ | 90% - 10%   | 100  | 150  | 200  | ps    |

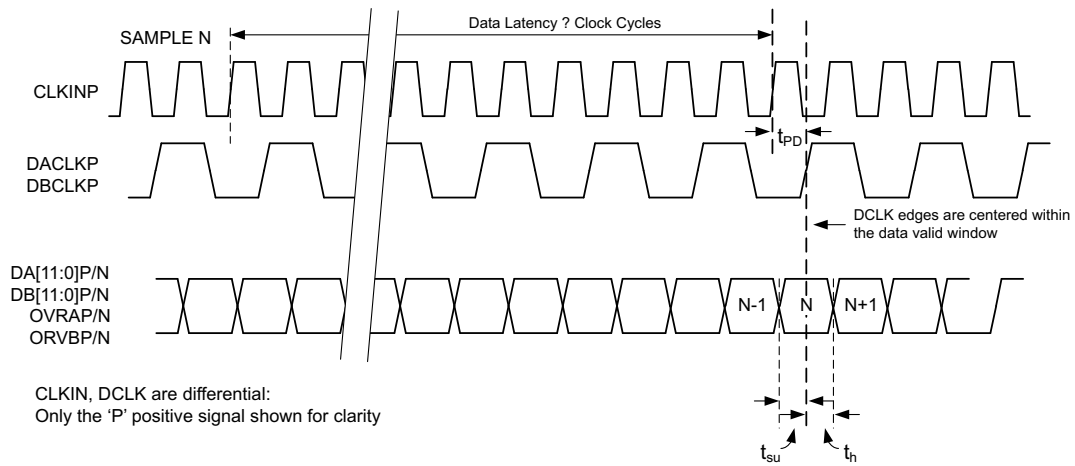

Figure 3. Timing Diagram for 12-bit DDR Output

### TYPICAL CHARACTERISTICS

Typical values at TA = +25°C, full temperature range is T<sub>MIN</sub> = -40°C to T<sub>MAX</sub> = +85°C, ADC sampling rate = 500Mps, 50% clock duty cycle, AVDD33 = 3.3V, AVDDC/AVDD18/DVDD/DVDDLVS/IOVDD = 1.8V, -1dBFS differential input, unless otherwise noted.

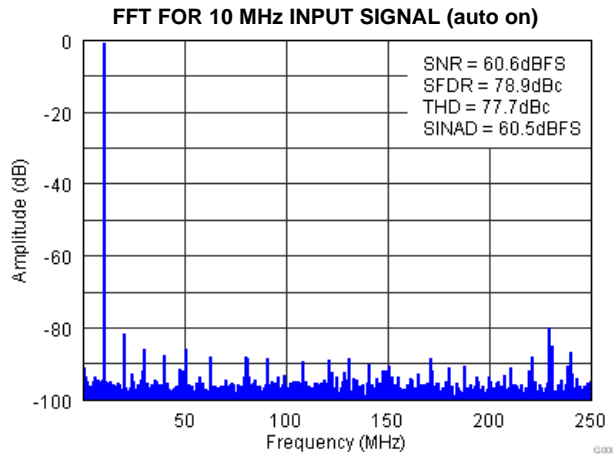

Figure 4.

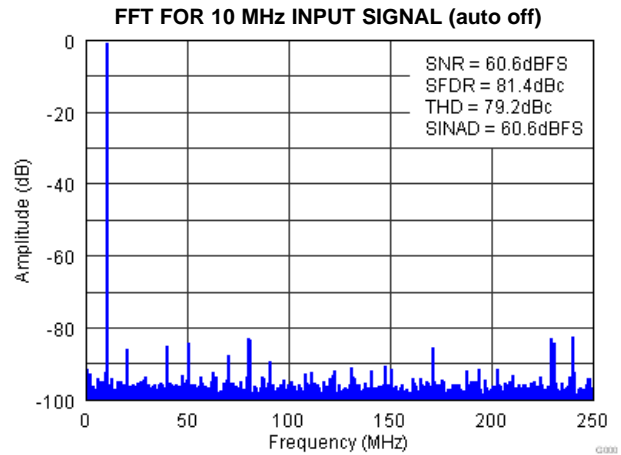

Figure 5.

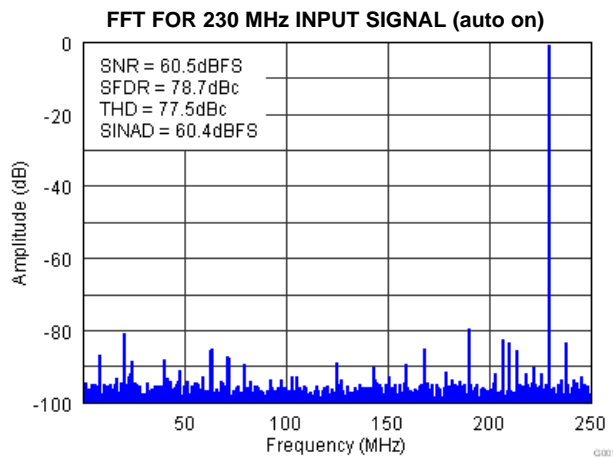

Figure 6.

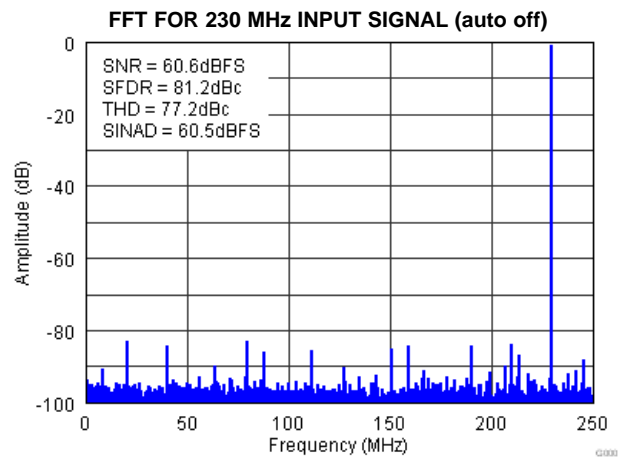

Figure 7.

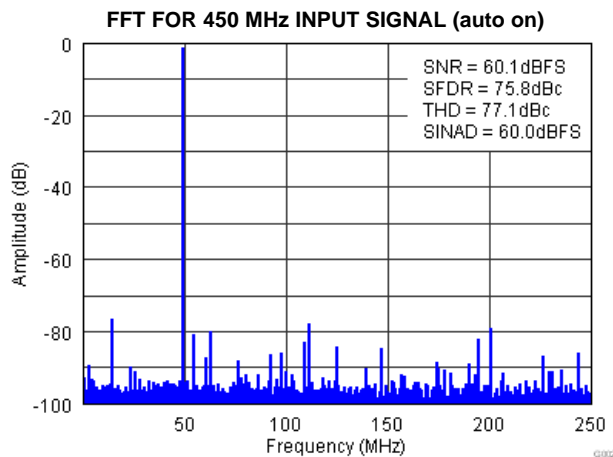

Figure 8.

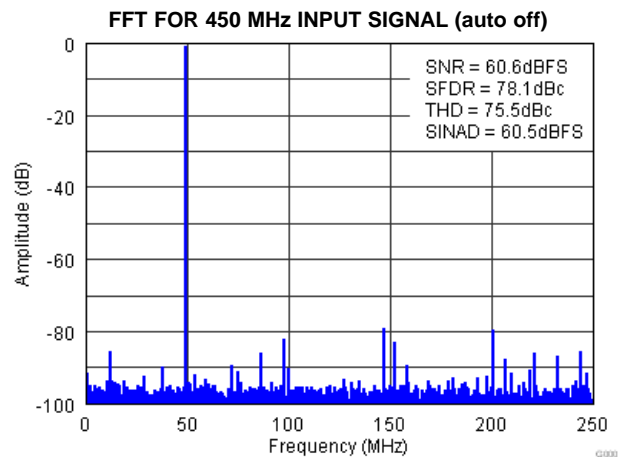

Figure 9.

**TYPICAL CHARACTERISTICS (continued)**

Typical values at TA = +25°C, full temperature range is T<sub>MIN</sub> = -40°C to T<sub>MAX</sub> = +85°C, ADC sampling rate = 500Mpsps, 50% clock duty cycle, AVDD33 = 3.3V, AVDDC/AVDD18/DVDD/DVDDLVS/IOVDD = 1.8V, -1dBFS differential input, unless otherwise noted.

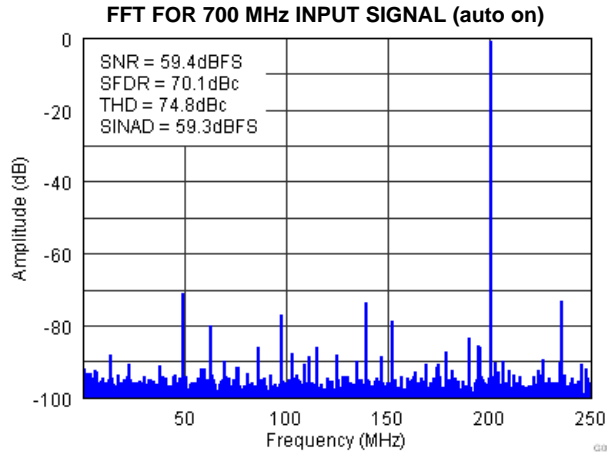

Figure 10.

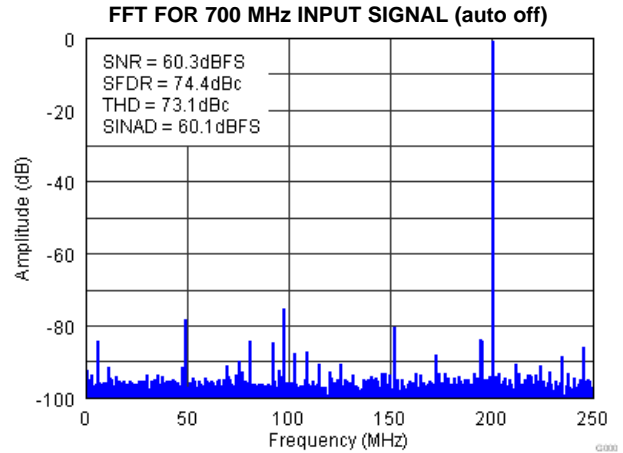

Figure 11.

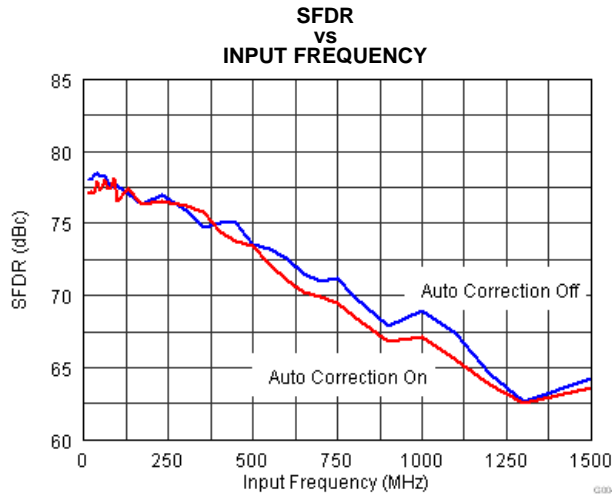

Figure 12.

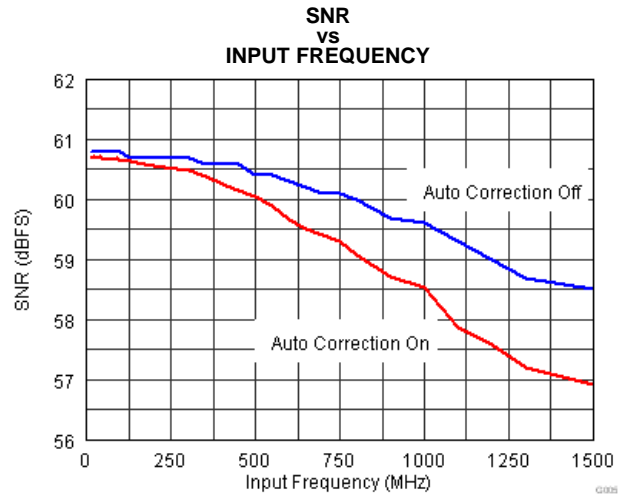

Figure 13.

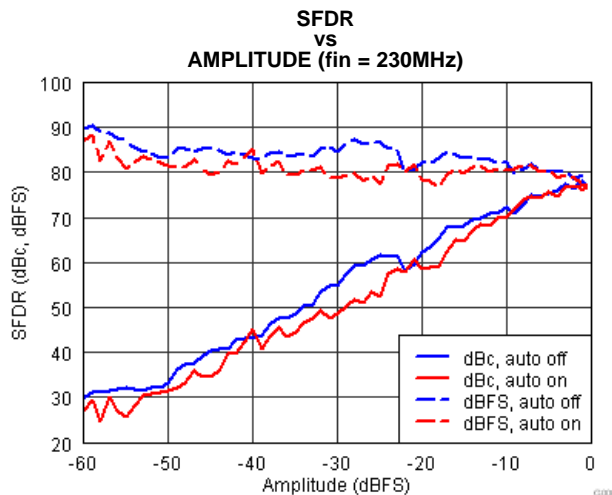

Figure 14.

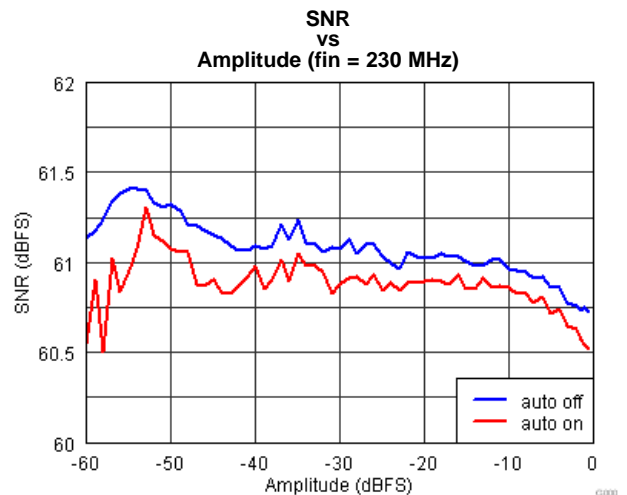

Figure 15.

**TYPICAL CHARACTERISTICS (continued)**

Typical values at TA = +25°C, full temperature range is T<sub>MIN</sub> = -40°C to T<sub>MAX</sub> = +85°C, ADC sampling rate = 500Mpsps, 50% clock duty cycle, AVDD33 = 3.3V, AVDDC/AVDD18/DVDD/DVDDLVD/IOVDD = 1.8V, -1dBFS differential input, unless otherwise noted.

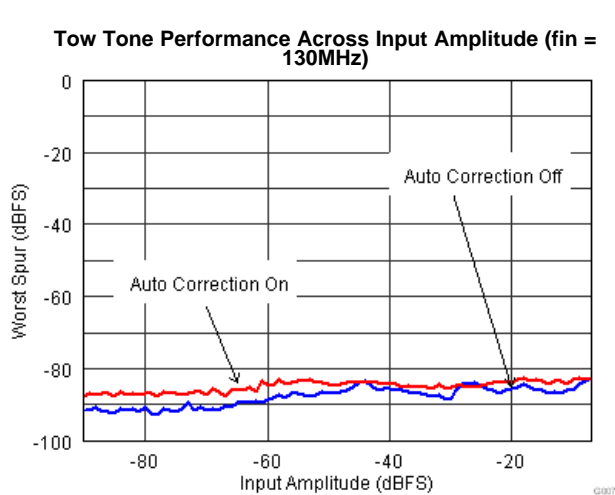

Figure 16.

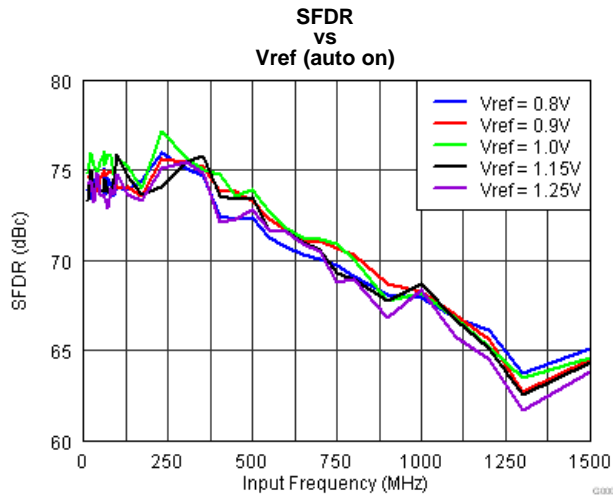

Figure 17.

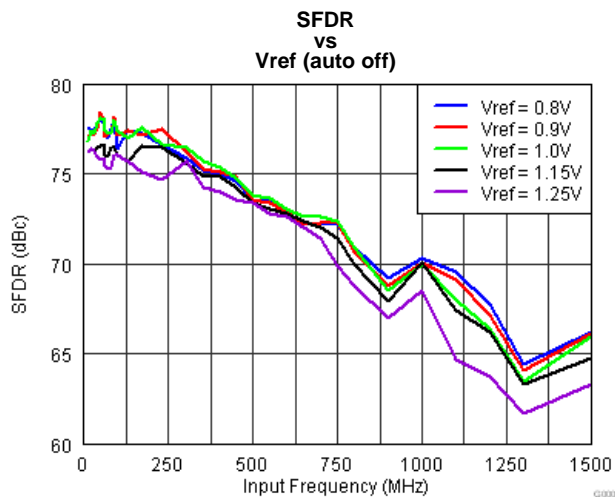

Figure 18.

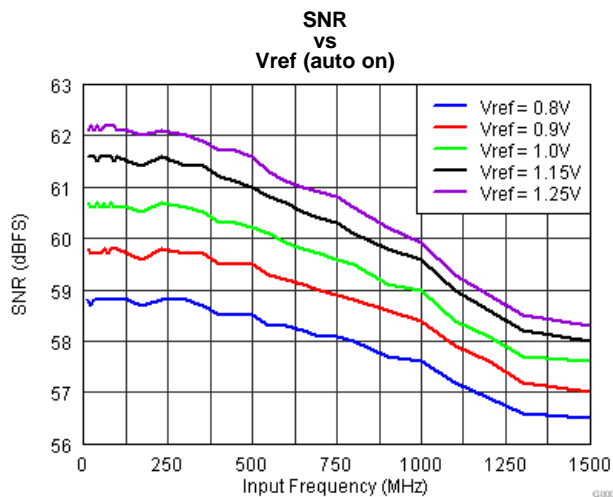

Figure 19.

### TYPICAL CHARACTERISTICS (continued)

Typical values at TA = +25°C, full temperature range is T<sub>MIN</sub> = -40°C to T<sub>MAX</sub> = +85°C, ADC sampling rate = 500Mps, 50% clock duty cycle, AVDD33 = 3.3V, AVDDC/AVDD18/DVDD/DVDDLVS/IOVDD = 1.8V, -1dBFS differential input, unless otherwise noted.

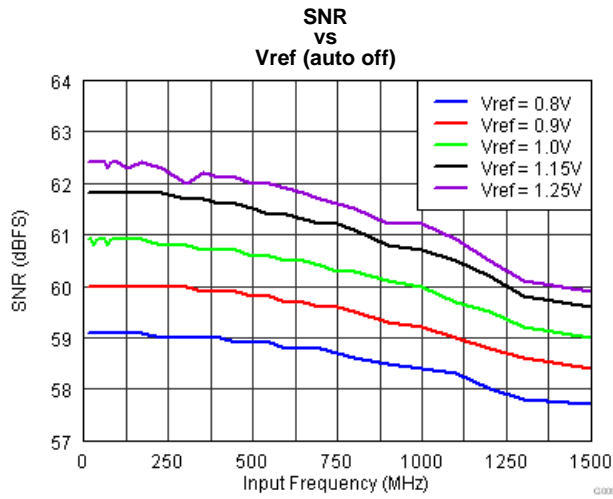

Figure 20.

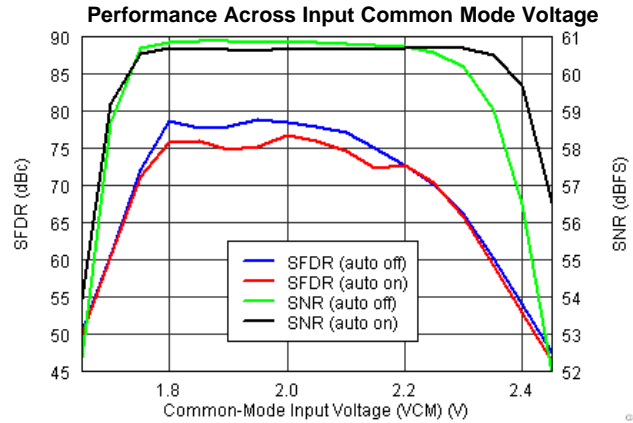

Figure 21.

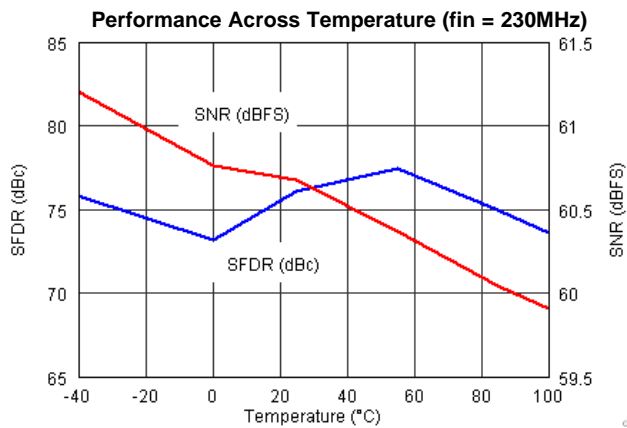

Figure 22.

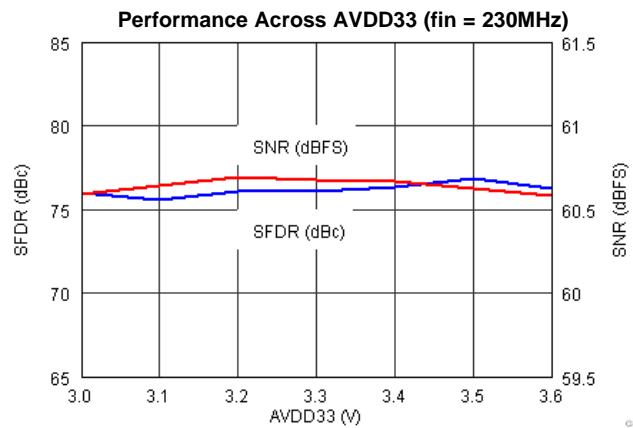

Figure 23.

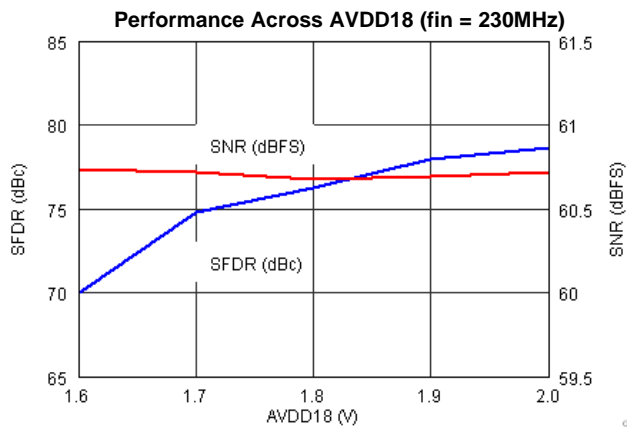

Figure 24.

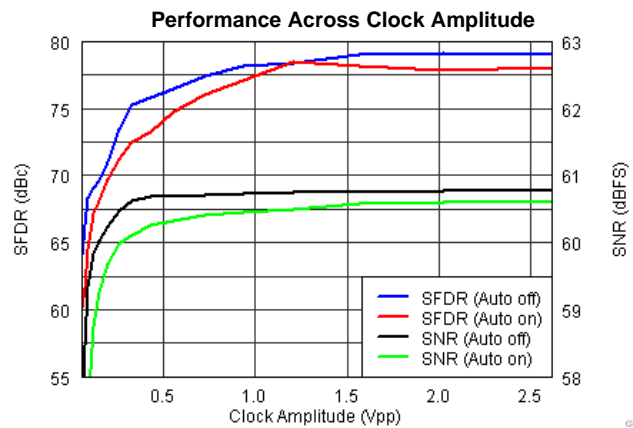

Figure 25.

**TYPICAL CHARACTERISTICS (continued)**

Typical values at TA = +25°C, full temperature range is T<sub>MIN</sub> = -40°C to T<sub>MAX</sub> = +85°C, ADC sampling rate = 500Mps, 50% clock duty cycle, AVDD33 = 3.3V, AVDDC/AVDD18/DVDD/DVDDLVS/IOVDD = 1.8V, -1dBFS differential input, unless otherwise noted.

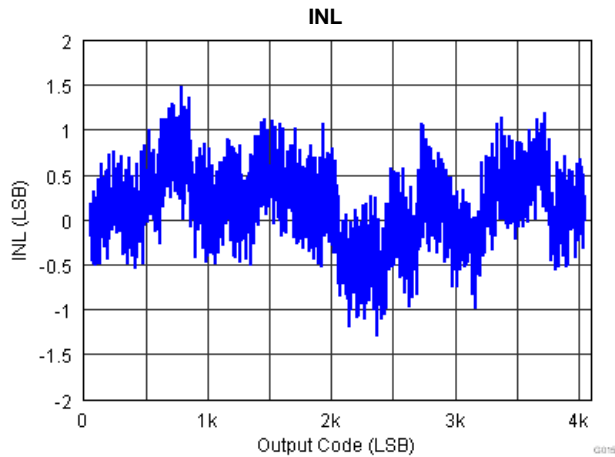

Figure 26.

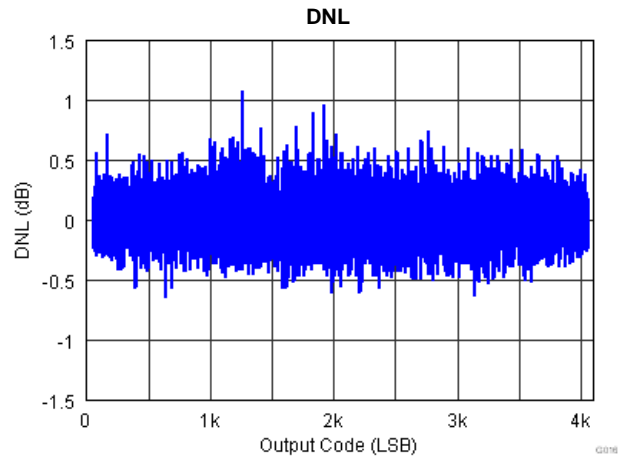

Figure 27.

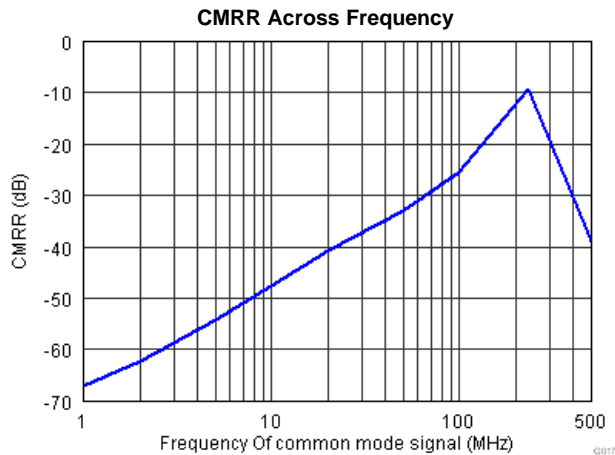

Figure 28.

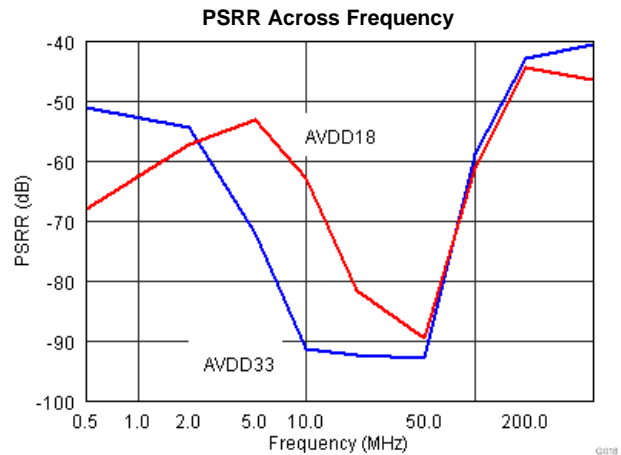

Figure 29.

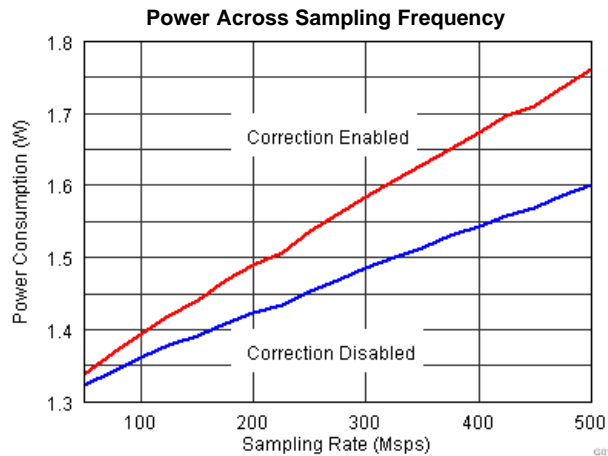

Figure 30.

**TYPICAL CHARACTERISTICS (continued)**

Typical values at TA = +25°C, full temperature range is T<sub>MIN</sub> = -40°C to T<sub>MAX</sub> = +85°C, ADC sampling rate = 500Mps, 50% clock duty cycle, AVDD33 = 3.3V, AVDDC/AVDD18/DVDD/DVDDLVS/IOVDD = 1.8V, -1dBFS differential input, unless otherwise noted.

**SFDR Across Input and Sampling Frequencies (auto on)**

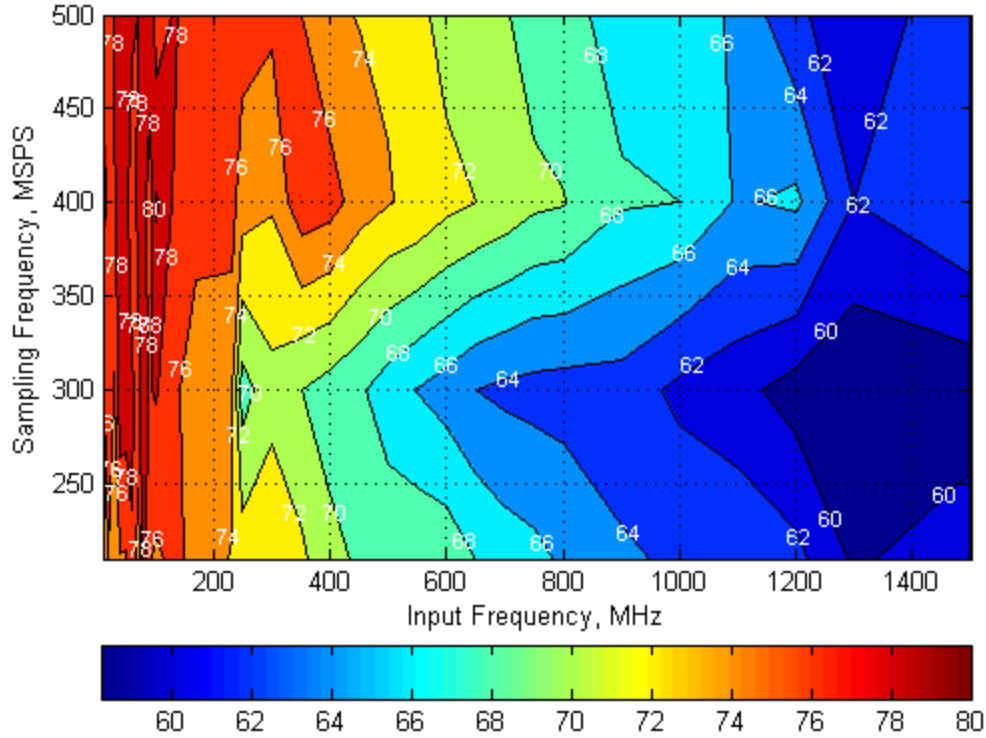

Figure 31.



**TYPICAL CHARACTERISTICS (continued)**

Typical values at TA = +25°C, full temperature range is T<sub>MIN</sub> = -40°C to T<sub>MAX</sub> = +85°C, ADC sampling rate = 500Mps, 50% clock duty cycle, AVDD33 = 3.3V, AVDDC/AVDD18/DVDD/DVDDLVD/IOVDD = 1.8V, -1dBFS differential input, unless otherwise noted.

**SFDR Across Input and Sampling Frequencies (auto off)**

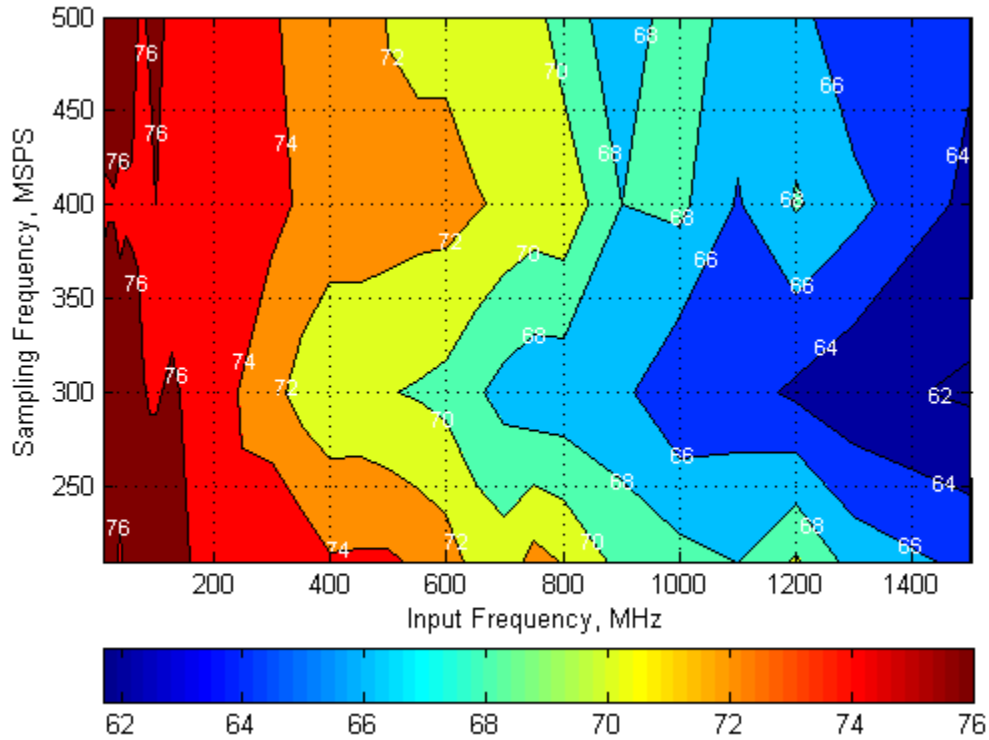

Figure 32.

**TYPICAL CHARACTERISTICS (continued)**

Typical values at TA = +25°C, full temperature range is T<sub>MIN</sub> = -40°C to T<sub>MAX</sub> = +85°C, ADC sampling rate = 500MSPS, 50% clock duty cycle, AVDD33 = 3.3V, AVDDC/AVDD18/DVDD/DVDDLVD5/IOVDD = 1.8V, -1dBFS differential input, unless otherwise noted.

**SNR Across Input and Sampling Frequencies (auto on)**

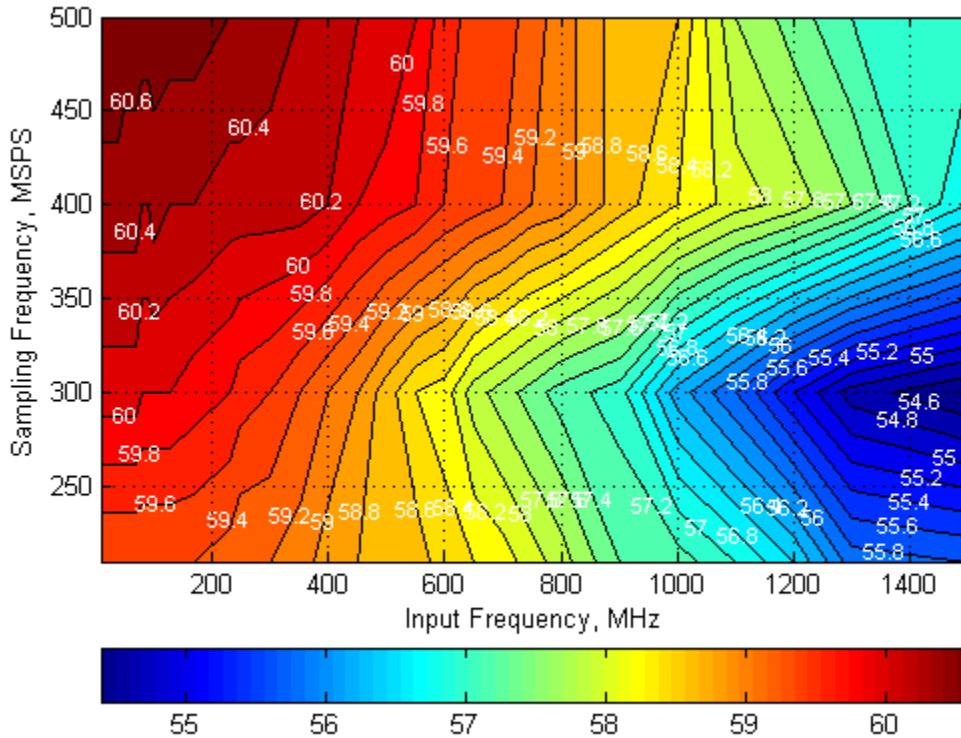

Figure 33.

**TYPICAL CHARACTERISTICS (continued)**

Typical values at TA = +25°C, full temperature range is T<sub>MIN</sub> = -40°C to T<sub>MAX</sub> = +85°C, ADC sampling rate = 500Mpsps, 50% clock duty cycle, AVDD33 = 3.3V, AVDDC/AVDD18/DVDD/DVDDLVS/IOVDD = 1.8V, -1dBFS differential input, unless otherwise noted.

**SNR Across Input and Sampling Frequencies (auto on)**

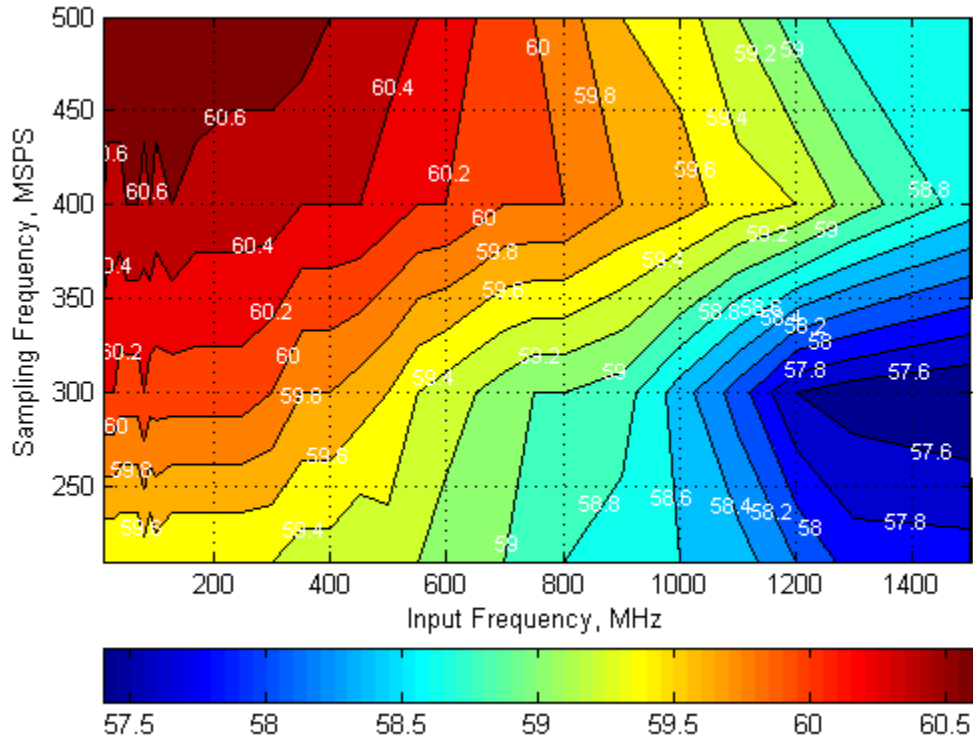

Figure 34.

## FEATURES

### POWER DOWN MODES

The ADS5404 can be configured via SPI write (address x37) to a stand-by, light or deep sleep power mode which is controlled by the ENABLE pin. The sleep modes are active when the ENABLE pin goes low. Different internal functions stay powered up which results in different power consumption and wake up time between the two sleep modes.

| Sleep mode         | Wake up time | Power Consumption Auto correction disabled | Power Consumption Auto correction enabled |
|--------------------|--------------|--|---|
| Complete Shut Down | 2.5 ms       | 7mW  | 7mW                                       |
| Stand-by           | 100µs        | 7mW  | 7mW                                       |
| Deep Sleep         | 20µs         | 282mW                                      | 370mW                                     |
| Light Sleep        | 2µs          | 549mW                                      | 650mW                                     |

### TEST PATTERN OUTPUT

The ADS5404 can be configured to output different test patterns that can be used to verify the digital interface is connected and working properly. To enable the test pattern mode, the high performance mode 1 has to be disabled first via SPI register write. Then different test patterns can be selected by configuring registers x3C, x3D and x3E. All three registers must be configured for the test pattern to work properly.

First set HP1 = 0 (Addr 0x01, D01)

| Register Address | All 0s | All 1s | Toggle (0xAAA => 0x555) | Toggle (0xFFF => 0x000) |
|------------------|--------|--------|-------------------------|-------------------------|
| 0x3C             | 0x8000 | 0xBFFC | 0x9554                  | 0xBFFC                  |
| 0x3D             | 0x0000 | 0x3FFC | 0x2AA8                  | 0x0000                  |
| 0x3E             | 0x0000 | 0x3FFC | 0x1554                  | 0x3FFC                  |

| Register Address | Custom Pattern |     |     |     |     |     |    |    |    |    |    |    |    |    |    |    |
|------------------|----------------|-----|-----|-----|-----|-----|----|----|----|----|----|----|----|----|----|----|
|                  | D15            | D14 | D13 | D12 | D11 | D10 | D9 | D8 | D7 | D6 | D5 | D4 | D3 | D2 | D1 | D0 |
| x3C              | 1              | 0   |     |     |     |     |    |    |    |    |    |    |    |    | 0  | 0  |
| x3D              | 0              | 0   | D11 | D10 | D9  | D8  | D7 | D6 | D5 | D4 | D3 | D2 | D1 | D0 | 0  | 0  |
| x3E              | 0              | 0   |     |     |     |     |    |    |    |    |    |    |    |    | 0  | 0  |

For normal operation, set HP1 = 1 (Addr 0x01, D01) and 0x3C, 0x3D, 0x3E all to 0.

### CLOCK INPUT

The ADS5404 clock input can be driven differentially with a sine wave, LVPECL or LVDS source with little or no difference in performance. The common mode voltage of the clock input is set to 0.9V using internal 2kΩ resistors. This allows for AC coupling of the clock inputs. The termination resistors should be placed as close as possible to the clock inputs in order to minimize signal reflections and jitter degradation.

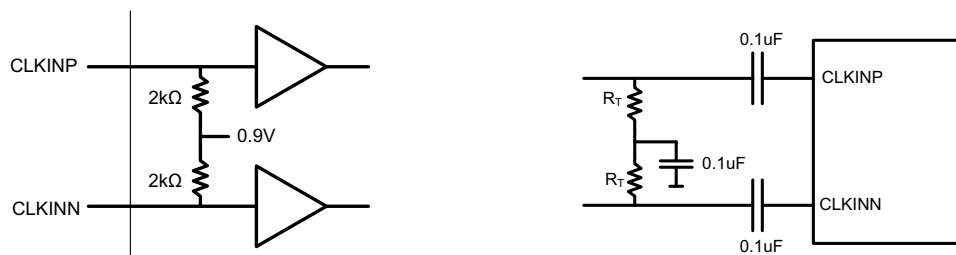

Recommended differential clock driving circuit

Figure 35. Recommended Differential Clock Driving Circuit

## SNR AND CLOCK JITTER

The signal to noise ratio of the ADC is limited by three different factors: the quantization noise is typically not noticeable in pipeline converters and is 72dB for a 12bit ADC. The thermal noise limits the SNR at low input frequencies while the clock jitter sets the SNR for higher input frequencies.

$$\text{SNR}_{\text{ADC}}[\text{dBc}] = -20 \times \log \sqrt{\left(10 - \frac{\text{SNR}_{\text{Quantization\_Noise}}}{20}\right)^2 + \left(10 - \frac{\text{SNR}_{\text{ThermalNoise}}}{20}\right)^2 + \left(10 - \frac{\text{SNR}_{\text{Jitter}}}{20}\right)^2} \quad (1)$$

The SNR limitation due to sample clock jitter can be calculated as following:

$$\text{SNR}_{\text{Jitter}}[\text{dBc}] = -20 \times \log(2\pi \times f_{\text{IN}} \times t_{\text{jitter}}) \quad (2)$$

The total clock jitter (TJitter) has three components – the internal aperture jitter (100fs for ADS5404) which is set by the noise of the clock input buffer, the external clock jitter and the jitter from the analog input signal. It can be calculated as following:

$$T_{\text{Jitter}} = \sqrt{(T_{\text{Jitter,Ext.Clock\_Input}})^2 + (T_{\text{Aperture\_ADC}})^2} \quad (3)$$

External clock jitter can be minimized by using high quality clock sources and jitter cleaners as well as bandpass filters at the clock input while a faster clock slew rate improves the ADC aperture jitter.

The ADS5404 has a thermal noise of 60.8 dBFS and internal aperture jitter of 100fs. The SNR depending on amount of external jitter for different input frequencies is shown in the following figure.

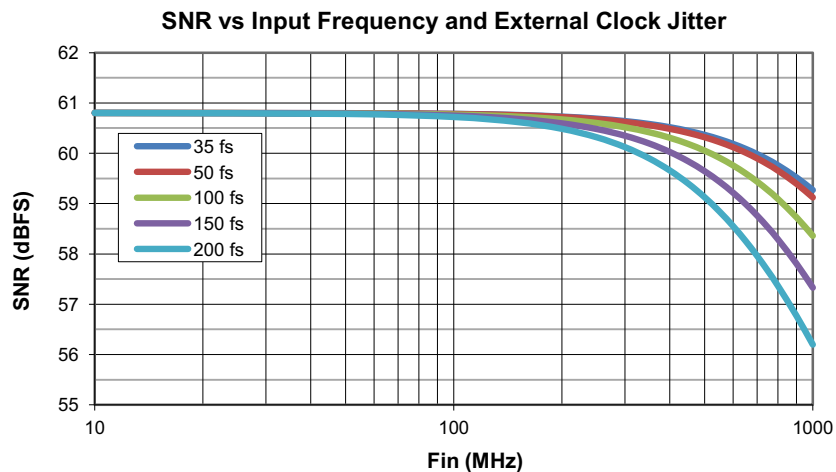

## ANALOG INPUTS

The ADS5404 analog signal inputs are designed to be driven differentially. The analog input pins have internal analog buffers that drive the sampling circuit. As a result of the analog buffer, the input pins present a high impedance input across a very wide frequency range to the external driving source which enables great flexibility in the external analog filter design as well as excellent 50Ω matching for RF applications. The buffer also helps to isolate the external driving circuit from the internal switching currents of the sampling circuit which results in a more constant SFDR performance across input frequencies.

The common-mode voltage of the signal inputs is internally biased to 1.9V using 500Ω resistors which allows for AC coupling of the input drive network. Each input pin (INP, INM) must swing symmetrically between (VCM + 0.25V) and (VCM – 0.25V), resulting in a 1.0Vpp (default) differential input swing. The input sampling circuit has a 3dB bandwidth that extends up to 1.2GHz.

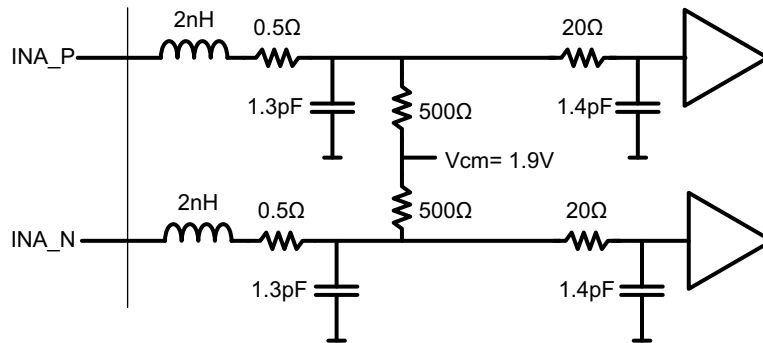

## OVER-RANGE INDICATION

The ADS5404 provides a fast over-range indication on the OVRA/B pins. The fast OVR is triggered if the input voltage exceeds the programmable overrange threshold and it gets presented after just 12 clock cycles enabling a quicker reaction to an overrange event. The OVR threshold can be configured using SPI register writes.

The input voltage level at which the overload is detected is referred to as the threshold and is programmable using the Over-range threshold bits. The threshold at which fast OVR is triggered is (full-scale × [the decimal value of the FAST OVR THRESH bits] / 16). After reset, the default value of the over-range threshold is set to 15 (decimal) which corresponds to a threshold of 0.56dB below full scale (20\*log(15/16)).

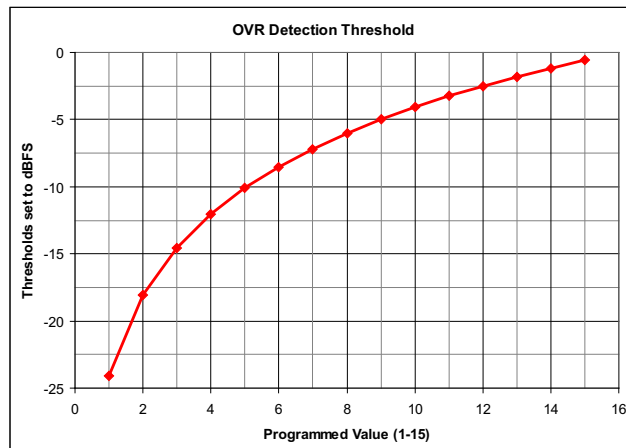

Each of the two data converter channels consists of two interleaved ADCs each operating at half of the ADC sampling rate but 180° out of phase from each other. The front end track and hold circuitry is operating at the full ADC sampling rate which minimizes the timing mismatch between the two interleaved ADCs. In addition the ADS5404 is equipped with internal interleaving correction logic that can be enabled via SPI register write.

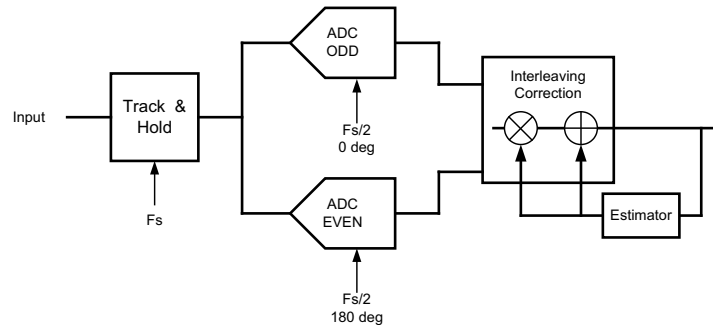

The interleaving operation creates 2 distinct and interleaving products:

- $F_s/2 - F_{in}$ : this spur is created by gain timing mismatch between the ADCs. Since internally the front end track and hold is operated at the full sampling rate, this component is greatly improved and mostly dependent on gain mismatch.
- $F_s/2$  Spur: due to offset mismatch between ADCs

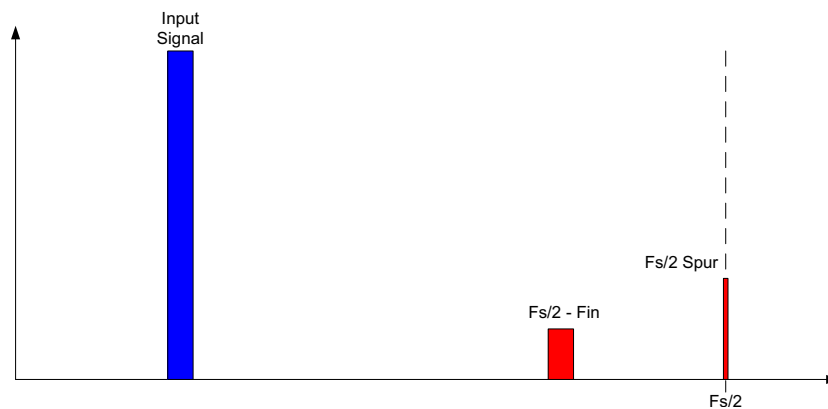

The auto correction loop can be enabled via SPI register write in address 0x01. By default it is disabled for lowest possible power consumption. The DC correction function can be enabled in 0x03 & 0x1A for chA and chB respectively. The default settings for the auto correction function should work for most applications. However please contact Texas Instruments if further fine tuning of the algorithm is required.

The auto correction function yields best performance for input frequencies below 250MHz.

### DECIMATION FILTER

Each channel has a digital filter in the data path as shown in [Figure 36](#). The filter can be programmed as a low-pass or a high-pass filter and the normalized frequency response of both filters is shown in [Figure 37](#).

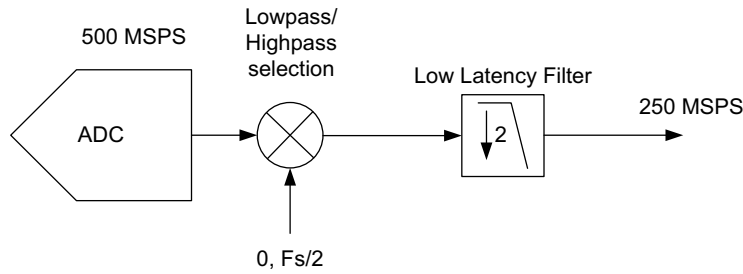

Figure 36.

The decimation filter response has a 0.1dB pass band ripple with approximately 41% pass-band bandwidth. The stop-band attenuation is approximately 40dB.

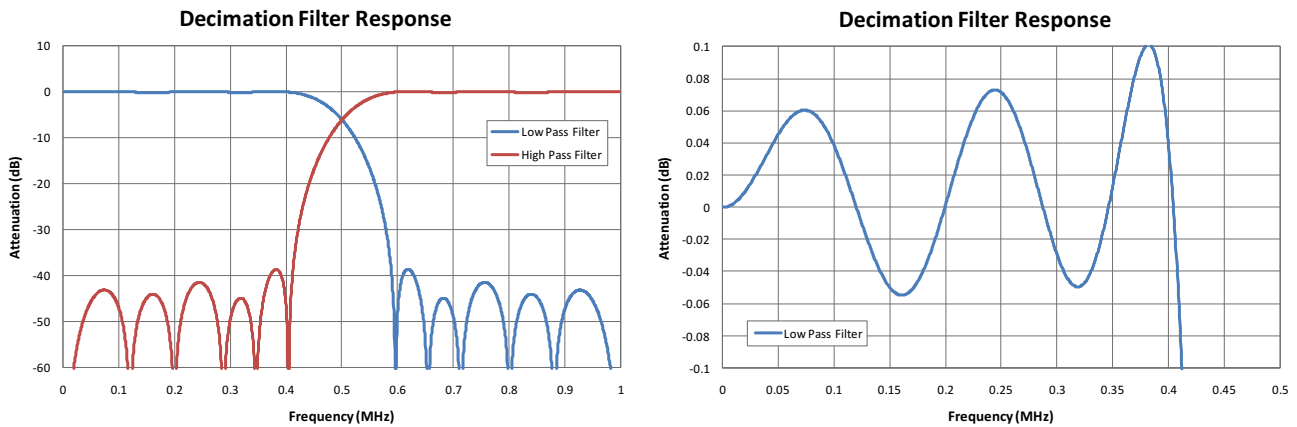
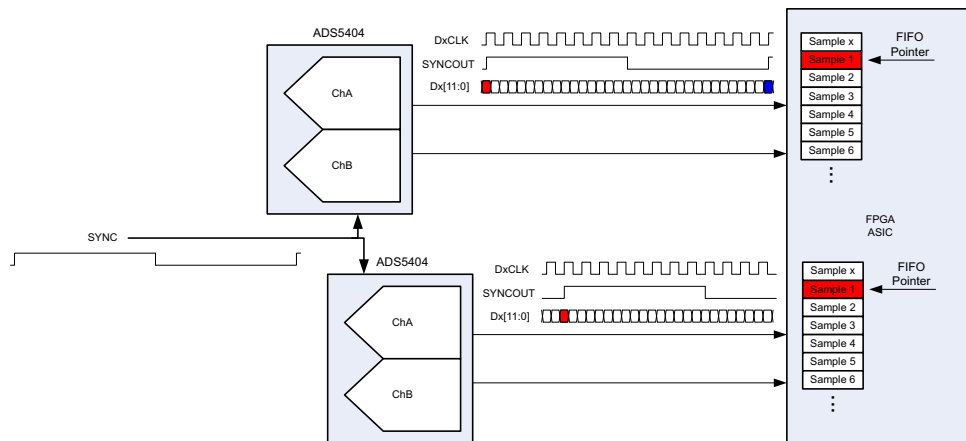

Figure 37.



## MULTI DEVICE SYNCHRONIZATION

The ADS5404 simplifies the synchronization of data from multiple ADCs in one common receiver. Upon receiving the initial SYNC input signal, the ADS5404 resets all the internal clocks and digital logic while also starting a SYNCOUT signal which operates on a 5bit counter (32 clock cycles). Therefore by providing a common SYNC signal to multiple ADCs their output data can be synchronized as the SYNCOUT signal marks a specific sample with the same latency in all ADCs. The SYNCOUT signal then can be used in the receiving device to synchronize the FIFO pointers across the different input data streams. Thus the output data of multiple ADCs can be aligned properly even if there are different trace lengths between the different ADCs.



The SYNC input signal should be a one time pulse to trigger the periodic 5-bit counter for SYNCOUT or a periodic signal repeating every 32 CLKIN clock cycles. It gets registered on the rising edge of the ADC input clock (CLKIN). Upon registering the initial rising edge of the SYNC signal, the internal clocks and logic get reset which results in invalid output data for 36 samples (1 complete sync cycle and 4 additional samples). The SYNCOUT signal starts with the next output clock (DACLK) rising edge and operates on a 5-bit counter. If a SYNCIN rising edge gets registered at a new position, the counter gets reset and SYNCOUT starts from the new position.

Since the ADS5404 output interface operates with a DDR clock, the synchronization can happen on the rising edge or falling edge sample. Synchronization on the falling edge sample will result in a half cycle clock stretch of DA/BCLK. For convenience the SYNCOUT signal is available on the ChA/B output LVDS bus. When using decimation the SYNCOUT signal still operates on 32 clock cycles of CLKIN but since the output data is decimated by 2, only the first 18 samples should be discarded.

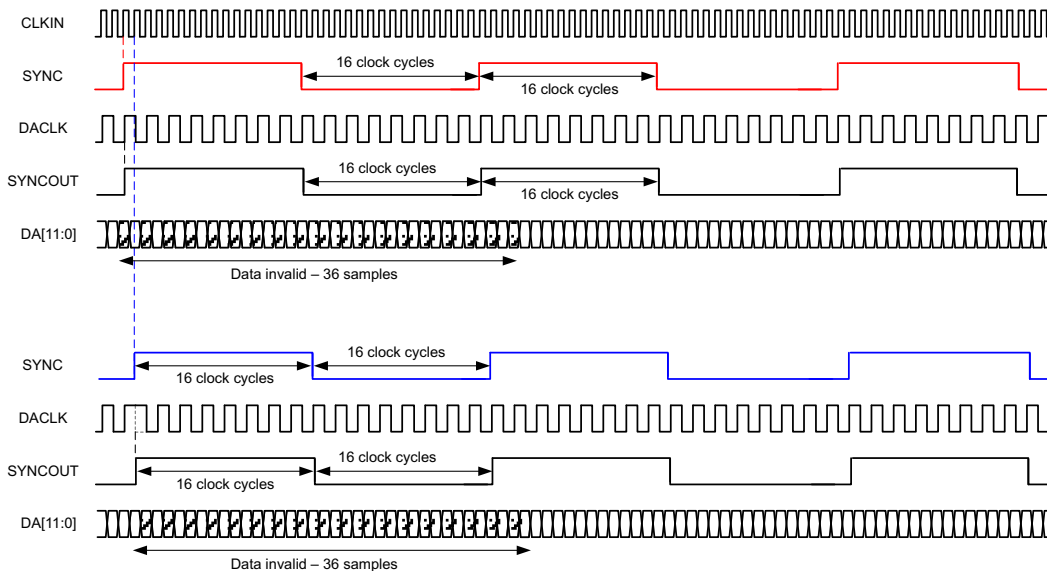

## PROGRAMMING INTERFACE

The serial interface (SIF) included in the ADS5404 is a simple 3 or 4 pin interface. In normal mode, 3 pins are used to communicate with the device. There is an enable (SDENB), a clock (SCLK) and a bi-directional IO port (SDIO). If the user would like to use the 4 pin interface one write must be implemented in the 3 pin mode to enable 4 pin communications. In this mode, the SDO pin becomes the dedicated output. The serial interface has an 8-bit address word and a 16-bit data word. The first rising edge of SCLK after SDENB goes low will latch the read/write bit. If a high is registered then a read is requested, if it is low then a write is requested. SDENB must be brought high again before another transfer can be requested. The signal diagram is shown below:

### Device Initialization

After power up, it is recommended to initialize the device through a hardware reset by applying a logic low pulse on the SRESETb pin (of width greater than 20ns), as shown in Figure 38. This resets all internal digital blocks (including SPI registers) to their default condition.

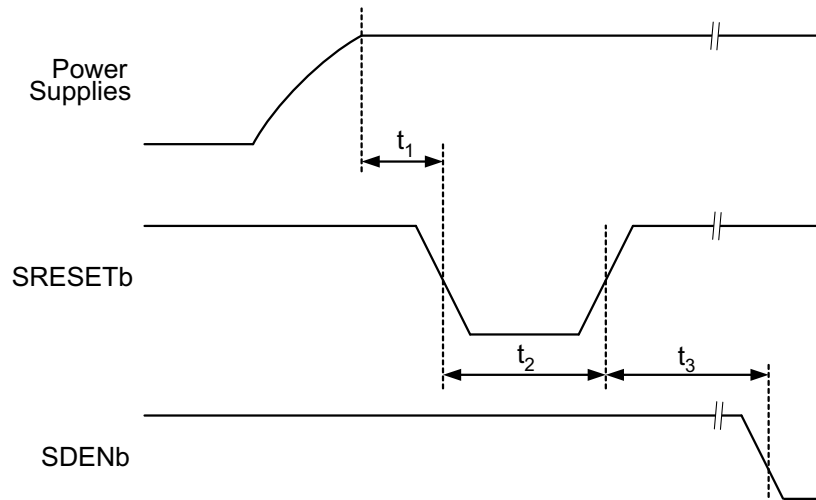

Figure 38. Device Initialization Timing Diagram

Table 1. Reset Timing

| PARAMETER      |                      | CONDITIONS                                    | MIN | TYP | MAX | UNIT |
|----------------|----------------------|---|-----|-----|-----|------|
| t <sub>1</sub> | Power-on delay       | Delay from power up to active low RESET pulse | 3   |     |     | ms   |
| t <sub>2</sub> | Reset pulse width    | Active low RESET pulse width                  | 20  |     |     | ns   |
| t <sub>3</sub> | Register write delay | Delay from RESET disable to SDENb active      | 100 |     |     | ns   |

Recommended Device Initialization Sequence:

1. Power up
2. Reset ADS5404 using hardware reset.
3. Apply clock and input signal.
4. Set register 0x01 bit D15 to "1" (ChA Corr EN) and bit D9 to "1" (ChB Corr EN) to enable gain/offset correction circuit and other desired registers.
5. Set register 0x03 and 0x1A bit D14 to "1" (Start Auto Corr ChA/B). This clears and resets the accumulator values in the DC and gain correction loop.
6. Set register 0x03 and 0x1A bit D14 to "0" (Start Auto Corr ChA/B). This starts the DC and gain auto-correction loop.

### Serial Register Write

The internal register of the ADS5404 can be programmed following these steps:

1. Drive SDENB pin low
2. Set the R/W bit to '0' (bit A7 of the 8 bit address)

3. Initiate a serial interface cycle specifying the address of the register (A6 to A0) whose content has to be written
4. Write 16bit data which is latched on the rising edge of SCLK

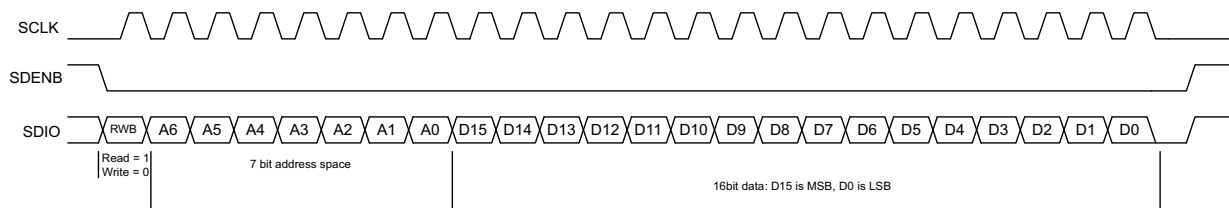

Figure 39. Serial Register Write Timing Diagram

| PARAMETER    |   | MIN | TYP <sup>(1)</sup> | MAX | UNIT |
|--------------|---|-----|--------------------|-----|------|
| $f_{SCLK}$   | SCLK frequency (equal to $1/t_{SCLK}$ ) | >DC |                    | 20  | MHz  |
| $t_{SLOADS}$ | SDENB to SCLK setup time                | 25  |                    |     | ns   |
| $t_{SLOADH}$ | SCLK to SDENB hold time                 | 25  |                    |     | ns   |
| $t_{DSU}$    | SDIO setup time                         | 25  |                    |     | ns   |
| $t_{DH}$     | SDIO hold time                          | 25  |                    |     | ns   |

(1) Typical values at +25°C; minimum and maximum values across the full temperature range: TMIN = -40°C to TMAX = +85°C, AVDD3V = 3.3V, AVDD, DRVDD = 1.9V, unless otherwise noted.

### Serial Register Readout

The device includes a mode where the contents of the internal registers can be read back using the SDO/SDIO pins. This read-back mode may be useful as a diagnostic check to verify the serial interface communication between the external controller and the ADC.

1. Drive SDENB pin low
2. Set the RW bit (A7) to '1'. This setting disables any further writes to the registers
3. Initiate a serial interface cycle specifying the address of the register (A6 to A0) whose content has to be read.
4. The device outputs the contents (D15 to D0) of the selected register on the SDO/SDIO pin
5. The external controller can latch the contents at the SCLK rising edge.
6. To enable register writes, reset the RW register bit to '0'.

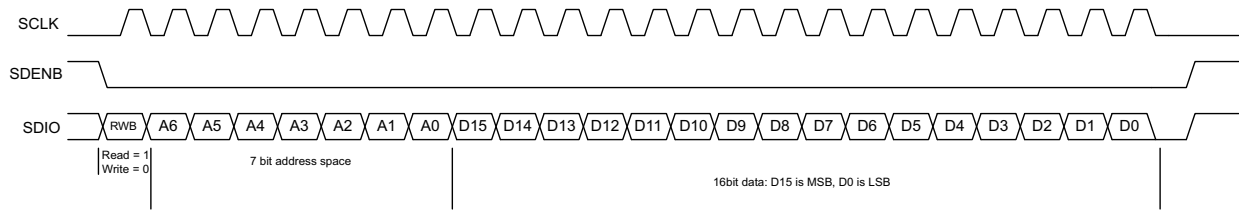

**Figure 40. Serial Register Read Timing Diagram**

**SERIAL REGISTER MAP<sup>(2)</sup>**

(2) Multiple functions in a register can be programmed in a single write operation.

| Register Address | Register Data         |                      |         |                   |                           |                      |                   |             |    |          |          |           |             |         |          |    |   |
|------------------|-----------------------|----------------------|---------|-------------------|---------------------------|----------------------|-------------------|-------------|----|----------|----------|-----------|-------------|---------|----------|----|---|
| A7-A0 IN HEX     | D15                   | D14                  | D13     | D12               | D11                       | D10                  | D9                | D8          | D7 | D6       | D5       | D4        | D3          | D2      | D1       | D0 |   |
| 0                | 3/4 Wire SPI          | Decimation Filter EN | 0       | ChA High/Low Pass | 0                         | 0                    | ChB High/Low Pass | 0           | 0  | 0        | 0        | 0         | 0           | 0       | 0        | 0  |   |
| 1                | ChA Corr EN           | 0                    | 0       | 0                 | 0                         | 0                    | ChB Corr EN       | 0           | 0  | 0        | 0        | 0         | Data Format | 0       | Hp Mode1 | 0  |   |
| 2                | 0                     | 0                    | 0       | 0                 | 0                         | Over-range threshold |                   |             |    | 0        | 0        | 0         | 0           | 0       | 0        | 0  |   |
| 3                | 0                     | Start Auto Corr ChA  | 0       | 0                 | 1                         | 0                    | 1                 | 1           | 0  | 0        | 0        | 1         | 1           | 0       | 0        | 0  |   |
| E                | Sync Select           |                      |         |                   |                           |                      |                   |             |    |          |          |           |             |         |          | 0  | 0 |
| F                | Sync Select           |                      |         |                   | 0                         | 0                    | 0                 | 0           | 0  | VREF Set |          |           | 0           | 0       | 0        | 0  |   |
| 1A               | 0                     | Start Auto Corr ChB  | 0       | 0                 | 1                         | 0                    | 1                 | 1           | 0  | 0        | 0        | 1         | 1           | 0       | 0        | 0  |   |
| 2B               | 0                     | 0                    | 0       | 0                 | 0                         | 0                    | 0                 | Temp Sensor |    |          |          |           |             |         |          |    |   |
| 2C               | Reset                 |                      |         |                   |                           |                      |                   |             |    |          |          |           |             |         |          |    |   |
| 37               | Sleep Modes           |                      |         |                   |                           |                      |                   | 0           | 0  | 0        | 0        | 0         | 0           | 0       | 0        | 0  | 0 |
| 38               | HP Mode2              |                      |         |                   |                           |                      |                   |             |    | BIAS EN  | SYNC EN  | LP Mode 1 | 1           | 1       | 1        | 1  |   |
| 3A               | LVDS Current Strength |                      | LVDS SW |                   | Internal LVDS Termination |                      | 0                 | 0           | 0  | 0        | DACLK EN | DBCLK EN  | 0           | OVRA EN | OVRB EN  |    |   |
| 66               | LVDS Output Bus A EN  |                      |         |                   |                           |                      |                   |             |    |          |          |           |             |         |          |    |   |
| 67               | LVDS Output Bus B EN  |                      |         |                   |                           |                      |                   |             |    |          |          |           |             |         |          |    |   |

**DESCRIPTION OF SERIAL INTERFACE REGISTERS**

| Register Address | Register Data |                      |     |                   |     |     |                   |    |    |    |    |    |    |    |    |    |
|------------------|---------------|----------------------|-----|-------------------|-----|-----|-------------------|----|----|----|----|----|----|----|----|----|
| A7-A0 in hex     | D15           | D14                  | D13 | D12               | D11 | D10 | D9                | D8 | D7 | D6 | D5 | D4 | D3 | D2 | D1 | D0 |
| 0                | 3/4 Wire SPI  | Decimation Filter EN | 0   | ChA High/Low Pass | 0   | 0   | ChB High/Low Pass | 0  | 0  | 0  | 0  | 0  | 0  | 0  | 0  | 0  |

- D15 3/4 Wire SPI** Enables 4-bit serial interface when set  
Default 0
- 0 3 wire SPI is used with SDIO pin operating as bi-directional I/O port
- 1 4 wire SPI is used with SDIO pin operating as data input and SDO pin as data output port.
- D14 Decimation Filter EN** 2x decimation filter is enabled when bit is set  
Default 0
- 0 Normal operation with data output at full sampling rate
- 1 2x decimation filter enabled
- D12 ChA High/Low Pass** (Decimation filter must be enabled first: set bit D14)  
Default 0
- 0 Low Pass

- 1 High Pass
- D9 **ChB High/Low Pass** (Decimation filter must be enabled first: set bit D14)  
Default 0
- 0 Low Pass
- 1 High Pass

| Register Address | Register Data |     |     |     |     |     |             |    |    |    |    |    |             |    |          |    |
|------------------|---------------|-----|-----|-----|-----|-----|-------------|----|----|----|----|----|-------------|----|----------|----|
| A7-A0 in hex     | D15           | D14 | D13 | D12 | D11 | D10 | D9          | D8 | D7 | D6 | D5 | D4 | D3          | D2 | D1       | D0 |
| 1                | ChA Corr EN   | 0   | 0   | 0   | 0   | 0   | ChB Corr EN | 0  | 0  | 0  | 0  | 0  | Data Format | 0  | HP Mode1 | 0  |

- D15 **ChA Corr EN (should be enabled for maximum performance)**  
Default 0
  - 0 auto correction disabled
  - 1 auto correction enabled
- D9 **ChB Corr EN (should be enabled for maximum performance)**  
Default 0
  - 0 auto correction disabled
  - 1 auto correction enabled
- D3 **Data Format**  
Default 0
  - 0 Two's complement
  - 1 Offset Binary
- D1 **HP Mode 1**  
Default 0
  - 1 Must be set to 1 for optimum performance

| Register Address | Register Data |     |     |     |     |     |                      |    |    |    |    |    |    |    |    |    |
|------------------|---------------|-----|-----|-----|-----|-----|----------------------|----|----|----|----|----|----|----|----|----|
|                  | D15           | D14 | D13 | D12 | D11 | D10 | D9                   | D8 | D7 | D6 | D5 | D4 | D3 | D2 | D1 | D0 |
| A7-A0 in hex     | 2             | 0   | 0   | 0   | 0   | 0   | Over-range threshold |    |    | 0  | 0  | 0  | 0  | 0  | 0  | 0  |

**D10-D7 Over-range threshold** The over-range detection is triggered 12 output clock cycles after the overload condition occurs. The threshold at which the OVR is triggered =  $1.0V \times [\text{decimal value of } \langle \text{Over-range threshold} \rangle] / 16$ . After power up or reset, the default value is 15 (decimal) which corresponds to a OVR threshold of 0.56dB below fullscale ( $20 \times \log(15/16)$ ). This OVR threshold is applicable to both channels.

Default 1111

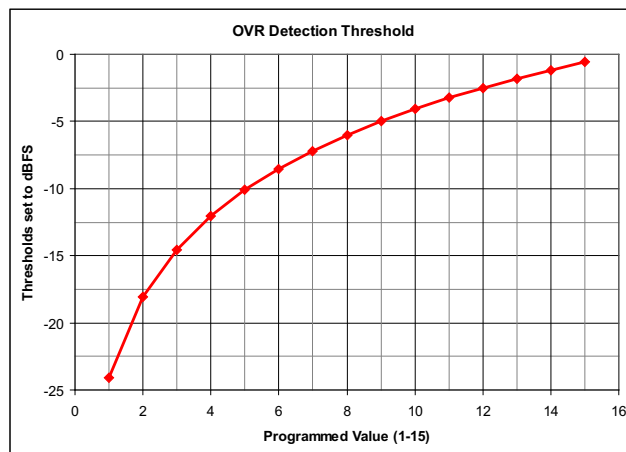

| Register Address | Register Data |     |                     |     |     |     |    |    |    |    |    |    |    |    |    |    |
|------------------|---------------|-----|---------------------|-----|-----|-----|----|----|----|----|----|----|----|----|----|----|
|                  | D15           | D14 | D13                 | D12 | D11 | D10 | D9 | D8 | D7 | D6 | D5 | D4 | D3 | D2 | D1 | D0 |
| A7-A0 in hex     | 3             | 0   | Start Auto Corr ChA | 0   | 0   | 1   | 0  | 1  | 1  | 0  | 0  | 0  | 1  | 1  | 0  | 0  |

**D14 Start Auto Corr ChA** Starts DC offset and gain correction loop for ChA  
 Default 1

0 Starts the DC offset and gain correction loop

1 Clears the DC offset correction value to 0 and gain value to 1

**D11, 9, 8, 4, 3** Must be set to 1 for maximum performance  
 Default 1

| Register Address | Register Data |     |     |     |     |     |    |    |    |    |    |    |    |    |    |    |
|------------------|---------------|-----|-----|-----|-----|-----|----|----|----|----|----|----|----|----|----|----|
| A7-A0 in hex     | D15           | D14 | D13 | D12 | D11 | D10 | D9 | D8 | D7 | D6 | D5 | D4 | D3 | D2 | D1 | D0 |
| E                | Sync Select   |     |     |     |     |     |    |    |    |    |    |    |    |    | 0  | 0  |

**D15-D2**                    **Sync Select**                    Sync selection for the clock generator block (also need to see address 0x0F)  
 Default 1010 1010 1010 10  
 0000 0000 0000 00                    Sync is disabled  
 0101 0101 0101 01                    Sync is set to one shot (one time synchronization only)  
 1010 1010 1010 10                    Sync is derived from SYNC input pins  
 1111 1111 1111 11                    not supported

| Register Address | Register Data |     |     |     |     |     |    |    |    |          |    |    |    |    |    |    |
|------------------|---------------|-----|-----|-----|-----|-----|----|----|----|----------|----|----|----|----|----|----|
| A7-A0 in hex     | D15           | D14 | D13 | D12 | D11 | D10 | D9 | D8 | D7 | D6       | D5 | D4 | D3 | D2 | D1 | D0 |
| F                | Sync Select   |     |     |     | 0   | 0   | 0  | 0  | 0  | VREF Sel |    |    | 0  | 0  | 0  | 0  |

**D15-D12**                    **Sync Select**                    Sync selection for the clock generator block  
 Default 1010  
 0000                    Sync is disabled  
 0101                    Sync is set to one shot (one time synchronization only)  
 1010                    Sync is derived from SYNC input pins  
 1111                    not supported

**D6-D4**                    **VREF SEL**                    Internal voltage reference selection  
 Default 000  
 000                    1.0V  
 001                    1.25V  
 010                    0.9V  
 011                    0.8V  
 100                    1.15V  
 Others                    external reference

| Register Address | Register Data |                     |     |     |     |     |    |    |    |    |    |    |    |    |    |    |
|------------------|---------------|---------------------|-----|-----|-----|-----|----|----|----|----|----|----|----|----|----|----|
| A7-A0 in hex     | D15           | D14                 | D13 | D12 | D11 | D10 | D9 | D8 | D7 | D6 | D5 | D4 | D3 | D2 | D1 | D0 |
| 1A               | 0             | Start Auto Corr ChB | 0   | 0   | 1   | 0   | 1  | 1  | 0  | 0  | 0  | 1  | 1  | 0  | 0  | 0  |

**D14**                    **Start Auto Corr ChB**                    Starts DC offset and gain correction loop for ChB  
 Default 1  
 0                    Starts the DC offset and gain correction loops  
 1                    Clears DC offset correction value to 0 and gain value to 1

**D11, 9, 8, 4, 3**                    Must be set to 1 for maximum performance  
 Default 1



| Register Address | Register Data |     |     |     |     |     |    |             |    |    |    |    |    |    |    |    |
|------------------|---------------|-----|-----|-----|-----|-----|----|-------------|----|----|----|----|----|----|----|----|
| A7-A0 in hex     | D15           | D14 | D13 | D12 | D11 | D10 | D9 | D8          | D7 | D6 | D5 | D4 | D3 | D2 | D1 | D0 |
| 2B               | 0             | 0   | 0   | 0   | 0   | 0   | 0  | Temp Sensor |    |    |    |    |    |    |    |    |

D8-D0     **Temp Sensor**     Internal temperature sensor value – read only

| Register Address | Register Data |     |     |     |     |     |    |    |    |    |    |    |    |    |    |    |
|------------------|---------------|-----|-----|-----|-----|-----|----|----|----|----|----|----|----|----|----|----|
| A7-A0 in hex     | D15           | D14 | D13 | D12 | D11 | D10 | D9 | D8 | D7 | D6 | D5 | D4 | D3 | D2 | D1 | D0 |
| 2C               | Reset         |     |     |     |     |     |    |    |    |    |    |    |    |    |    |    |

D15-D0     **Reset**     This is a software reset to reset all SPI registers to their default value. Self Default clears to 0.

Default  
0000

1101001011110000     Perform software reset

| Register Address | Register Data |     |     |     |     |     |    |    |    |    |    |    |    |    |    |    |
|------------------|---------------|-----|-----|-----|-----|-----|----|----|----|----|----|----|----|----|----|----|
| A7-A0 in hex     | D15           | D14 | D13 | D12 | D11 | D10 | D9 | D8 | D7 | D6 | D5 | D4 | D3 | D2 | D1 | D0 |
| 37               | Sleep Modes   |     |     |     |     |     | 0  | 0  | 0  | 0  | 0  | 0  | 0  | 0  | 0  | 0  |

D15-D14     **Sleep Modes**     Sleep mode selection which is controlled by the ENABLE pin. Sleep modes are active when ENABLE pin goes low.

Default 00

000000     Complete shut down     Wake up time 2.5 ms

100000     Stand-by mode     Wake up time 100  $\mu$ s

110000     Deep sleep mode     Wake up time 20  $\mu$ s

110101     Light sleep mode     Wake up time 2  $\mu$ s

| Register Address | Register Data |     |     |     |     |     |    |    |    |         |         |           |    |    |    |    |
|------------------|---------------|-----|-----|-----|-----|-----|----|----|----|---------|---------|-----------|----|----|----|----|
|                  | D15           | D14 | D13 | D12 | D11 | D10 | D9 | D8 | D7 | D6      | D5      | D4        | D3 | D2 | D1 | D0 |
| 38               | HP Mode 2     |     |     |     |     |     |    |    |    | Bias EN | SYNC EN | LP Mode 1 | 1  | 1  | 1  | 1  |

D15-D7 **HP Mode 2**

Default 11111111

1 Set to 1 for normal operation

D6 **BIAS EN** Enables internal fuse bias voltages – can be disabled after power up to save power.

Default 1

0 Internal bias powered down

1 Internal bias enabled

D5 **SYNC EN** Enables the SYNC input buffer.

Default 1

0 SYNC input buffer disabled

1 SYNC input bffer enabled

D4 **LP Mode 1** Low power mode 1 to disable unused internal input buffers.

Default 1

0 Internal input buffer disabled

1 Internal input buffer disabled

D3-D0 Read back 1

| Register Address | Register Data         |     |     |         |     |                           |    |    |    |    |    |          |          |    |         |         |
|------------------|-----------------------|-----|-----|---------|-----|---------------------------|----|----|----|----|----|----------|----------|----|---------|---------|
|                  | D15                   | D14 | D13 | D12     | D11 | D10                       | D9 | D8 | D7 | D6 | D5 | D4       | D3       | D2 | D1      | D0      |
| 3A               | LVDS Current Strength |     |     | LVDS SW |     | Internal LVDS Termination |    | 0  | 0  | 0  | 0  | DACLK EN | DBCLK EN | 0  | OVRA EN | OVRB EN |

|         |                                  |  |         |
|---------|----------------------------------|--|---------|
| D15-D13 | <b>LVDS Current Strength</b>     | LVDS output current strength.  |         |
|         | Default 000                      |  |         |
| 000     | 2 mA                             | 100  | 3 mA    |
| 001     | 2.25 mA                          | 101  | 3.25 mA |
| 010     | 2.5 mA                           | 110  | 3.5 mA  |
| 011     | 2.75 mA                          | 111  | 3.75 mA |
| D12-D11 | <b>LVDS SW</b>                   | LVDS driver internal switch setting – correct range must be set for setting in D15-D13 |         |
|         | Default 01                       |  |         |
| 01      | 2 mA to 2.75 mA                  |  |         |
| 11      | 3mA to 3.75mA                    |  |         |
| D10-D9  | <b>Internal LVDS Termination</b> | Internal termination   |         |
|         | Default 00                       |  |         |
| 00      | 2 k $\Omega$                     |  |         |
| 01      | 200 $\Omega$                     |  |         |
| 10      | 200 $\Omega$                     |  |         |
| 11      | 100 $\Omega$                     |  |         |
| D4      | <b>DACLK EN</b>                  | Enable DACLK output buffer   |         |
|         | Default 1                        |  |         |
| 0       | DACLK output buffer powered down |  |         |
| 1       | DACLK output buffer enabled      |  |         |
| D3      | <b>DBCLK EN</b>                  | Enable DBCLK output buffer   |         |
|         | Default 1                        |  |         |
| 0       | DBCLK output buffer powered down |  |         |
| 1       | DBCLK output buffer enabled      |  |         |
| D1      | <b>OVRA EN</b>                   | Enable OVRA output buffer  |         |
|         | Default 1                        |  |         |
| 0       | OVRA output buffer powered down  |  |         |
| 1       | OVRA output buffer enabled       |  |         |
| D0      | <b>OVRB EN</b>                   | Enable OVRB output buffer  |         |
|         | Default 1                        |  |         |
| 0       | OVRB output buffer powered down  |  |         |
| 1       | OVRB output buffer enabled       |  |         |

| Register Address | Register Data        |     |     |     |     |     |    |    |    |    |    |    |    |    |    |    |
|------------------|----------------------|-----|-----|-----|-----|-----|----|----|----|----|----|----|----|----|----|----|
| A7-A0 in hex     | D15                  | D14 | D13 | D12 | D11 | D10 | D9 | D8 | D7 | D6 | D5 | D4 | D3 | D2 | D1 | D0 |
| 66               | LVDS Output Bus A EN |     |     |     |     |     |    |    |    |    |    |    |    |    |    |    |

- D15-D0    **LVDS Output Bus A EN**    Individual LVDS output pin power down for channel A  
Default FFFF
- 0    Output is powered down
- 1    Output is enabled
- D15    Pins N7, P7 (no connect pins) which are not used and should be powered down for power savings
- D14    Pins N6, P6 (no connect pins) which are not used and should be powered down for power savings
- D13    SYNCOUTP/N (pins P5, N5)
- D12    Pins N4, P4 (no connect pins) which are not used and should be powered down for power savings
- D11-D0    corresponds to DA11-DA0

| Register Address | Register Data        |     |     |     |     |     |    |    |    |    |    |    |    |    |    |    |
|------------------|----------------------|-----|-----|-----|-----|-----|----|----|----|----|----|----|----|----|----|----|
| A7-A0 in hex     | D15                  | D14 | D13 | D12 | D11 | D10 | D9 | D8 | D7 | D6 | D5 | D4 | D3 | D2 | D1 | D0 |
| 67               | LVDS Output Bus B EN |     |     |     |     |     |    |    |    |    |    |    |    |    |    |    |

- D15-D0    **LVDS Output Bus B EN**    Individual LVDS output pin power down for channel B  
Default FFFF
- 0    Output is powered down
- 1    Output is enabled
- D15    Pins G3, G4 (no connect pins) which are not used and should be powered down for power savings
- D14    Pins F3, F4 (no connect pins) which are not used and should be powered down for power savings
- D13    SYNCOUTP/N (pins F1, F2)
- D12    Pins E3, E4 (no connect pins) which are not used and should be powered down for power savings
- D11-D0    corresponds to DB11-DB0

## REVISION HISTORY

| <b>Changes from Revision A (August 2013) to Revision B</b>   | <b>Page</b> |
|--|-------------|
| • Deleted last sentence in last paragraph in INTERLEAVING CORRECTION section .....                   | 23          |
| • Changed second paragraph in MULTI DEVICE SYNCHRONIZATION section .....                             | 25          |
| • Deleted Register Initialization section and added Device Initialization section .....              | 26          |
| • Changed Register Address E Bits D1 and D0 to 0 in SERIAL REGISTER MAP .....                        | 29          |
| • Changed Register Address 38 Bits D3 to D0 from 0 to 1 in SERIAL REGISTER MAP .....                 | 29          |
| • Changed Register Address 1 Bit D14 from 1 to 0 .....   | 30          |
| • Deleted Register Address 2 Bit D14 read back 1 .....   | 31          |
| • Changed Register Address E Bit D1 and D0 to 0 .....  | 32          |
| • Changed Register Address 38 Bits D3 to D0 from 0 to 1 and add D3 to D0 Read back 1 .....           | 34          |
| • Changed Register Address 66 D15-D10 to D15-D0 and DA11-D0 to DA11-DA0 .....                        | 36          |
| • Changed Register Address 67 D15-D10 to D15-D0 .....  | 36          |
| <b>Changes from Original (April 2013) to Revision A</b>  | <b>Page</b> |
| • Changed D11-D10 - corresponds to DA11-DA0 in Register 66 To: D11-D0 -corresponds to DA11-D0 .....  | 36          |
| • Changed D11-D10 - corresponds to DB11-DB0 in Register 67 To: D11-D0 -corresponds to DB11-DB0 ..... | 36          |

**PACKAGING INFORMATION**

| Orderable Device | Status<br>(1) | Package Type | Package Drawing | Pins | Package Qty | Eco Plan<br>(2) | Lead finish/<br>Ball material<br>(6) | MSL Peak Temp<br>(3) | Op Temp (°C) | Device Marking<br>(4/5) | Samples                 |
|------------------|---------------|--------------|-----------------|------|-------------|-----------------|--------------------------------------|----------------------|--------------|-------------------------|-------------------------|
| ADS5404IZAY      | ACTIVE        | NFBGA        | ZAY             | 196  | 160         | RoHS & Green    | SNAGCU                               | Level-3-260C-168 HR  | -40 to 85    | ADS5404I                | <a href="#">Samples</a> |
| ADS5404IZAYR     | ACTIVE        | NFBGA        | ZAY             | 196  | 1000        | RoHS & Green    | SNAGCU                               | Level-3-260C-168 HR  | -40 to 85    | ADS5404I                | <a href="#">Samples</a> |

(1) The marketing status values are defined as follows:

**ACTIVE:** Product device recommended for new designs.

**LIFEBUY:** TI has announced that the device will be discontinued, and a lifetime-buy period is in effect.

**NRND:** Not recommended for new designs. Device is in production to support existing customers, but TI does not recommend using this part in a new design.

**PREVIEW:** Device has been announced but is not in production. Samples may or may not be available.

**OBSOLETE:** TI has discontinued the production of the device.

(2) **RoHS:** TI defines "RoHS" to mean semiconductor products that are compliant with the current EU RoHS requirements for all 10 RoHS substances, including the requirement that RoHS substance do not exceed 0.1% by weight in homogeneous materials. Where designed to be soldered at high temperatures, "RoHS" products are suitable for use in specified lead-free processes. TI may reference these types of products as "Pb-Free".

**RoHS Exempt:** TI defines "RoHS Exempt" to mean products that contain lead but are compliant with EU RoHS pursuant to a specific EU RoHS exemption.

**Green:** TI defines "Green" to mean the content of Chlorine (Cl) and Bromine (Br) based flame retardants meet JS709B low halogen requirements of <=1000ppm threshold. Antimony trioxide based flame retardants must also meet the <=1000ppm threshold requirement.

(3) MSL, Peak Temp. - The Moisture Sensitivity Level rating according to the JEDEC industry standard classifications, and peak solder temperature.

(4) There may be additional marking, which relates to the logo, the lot trace code information, or the environmental category on the device.

(5) Multiple Device Markings will be inside parentheses. Only one Device Marking contained in parentheses and separated by a "~" will appear on a device. If a line is indented then it is a continuation of the previous line and the two combined represent the entire Device Marking for that device.

(6) Lead finish/Ball material - Orderable Devices may have multiple material finish options. Finish options are separated by a vertical ruled line. Lead finish/Ball material values may wrap to two lines if the finish value exceeds the maximum column width.

**Important Information and Disclaimer:**The information provided on this page represents TI's knowledge and belief as of the date that it is provided. TI bases its knowledge and belief on information provided by third parties, and makes no representation or warranty as to the accuracy of such information. Efforts are underway to better integrate information from third parties. TI has taken and continues to take reasonable steps to provide representative and accurate information but may not have conducted destructive testing or chemical analysis on incoming materials and chemicals. TI and TI suppliers consider certain information to be proprietary, and thus CAS numbers and other limited information may not be available for release.

In no event shall TI's liability arising out of such information exceed the total purchase price of the TI part(s) at issue in this document sold by TI to Customer on an annual basis.



**TAPE AND REEL INFORMATION**

**QUADRANT ASSIGNMENTS FOR PIN 1 ORIENTATION IN TAPE**

\*All dimensions are nominal

| Device       | Package Type | Package Drawing | Pins | SPQ  | Reel Diameter (mm) | Reel Width W1 (mm) | A0 (mm) | B0 (mm) | K0 (mm) | P1 (mm) | W (mm) | Pin1 Quadrant |
|--------------|--------------|-----------------|------|------|--------------------|--------------------|---------|---------|---------|---------|--------|---------------|
| ADS5404IZAYR | NFBGA        | ZAY             | 196  | 1000 | 330.0              | 24.4               | 12.3    | 12.3    | 2.3     | 16.0    | 24.0   | Q1            |



**TAPE AND REEL BOX DIMENSIONS**

\*All dimensions are nominal

| Device       | Package Type | Package Drawing | Pins | SPQ  | Length (mm) | Width (mm) | Height (mm) |
|--------------|--------------|-----------------|------|------|-------------|------------|-------------|
| ADS5404IZAYR | NFBGA        | ZAY             | 196  | 1000 | 350.0       | 350.0      | 43.0        |

**TRAY**



Chamfer on Tray corner indicates Pin 1 orientation of packed units.

\*All dimensions are nominal

| Device      | Package Name | Package Type | Pins | SPQ | Unit array matrix | Max temperature (°C) | L (mm) | W (mm) | K0 (µm) | P1 (mm) | CL (mm) | CW (mm) |
|-------------|--------------|--------------|------|-----|-------------------|----------------------|--------|--------|---------|---------|---------|---------|
| ADS5404IZAY | ZAY          | NFBGA        | 196  | 160 | 8 x 20            | 150                  | 315    | 135.9  | 7620    | 15.4    | 11.2    | 19.65   |

# ZAY0196A

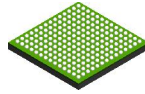

# PACKAGE OUTLINE

## NFBGA - 1.4 mm max height

PLASTIC BALL GRID ARRAY

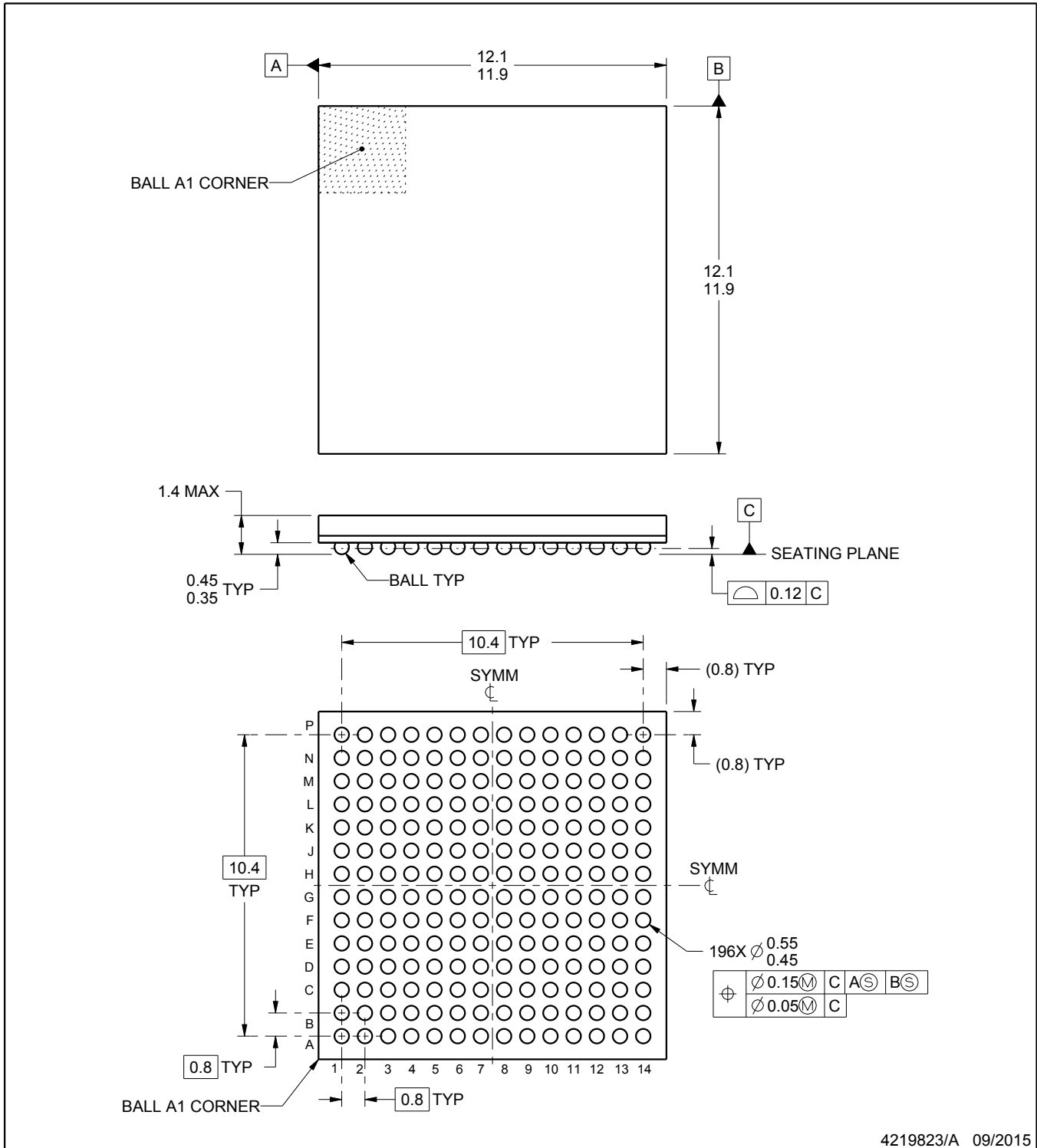

4219823/A 09/2015

**NOTES:**

1. All linear dimensions are in millimeters. Any dimensions in parenthesis are for reference only. Dimensioning and tolerancing per ASME Y14.5M.
2. This drawing is subject to change without notice.

# EXAMPLE BOARD LAYOUT

ZAY0196A

NFBGA - 1.4 mm max height

PLASTIC BALL GRID ARRAY

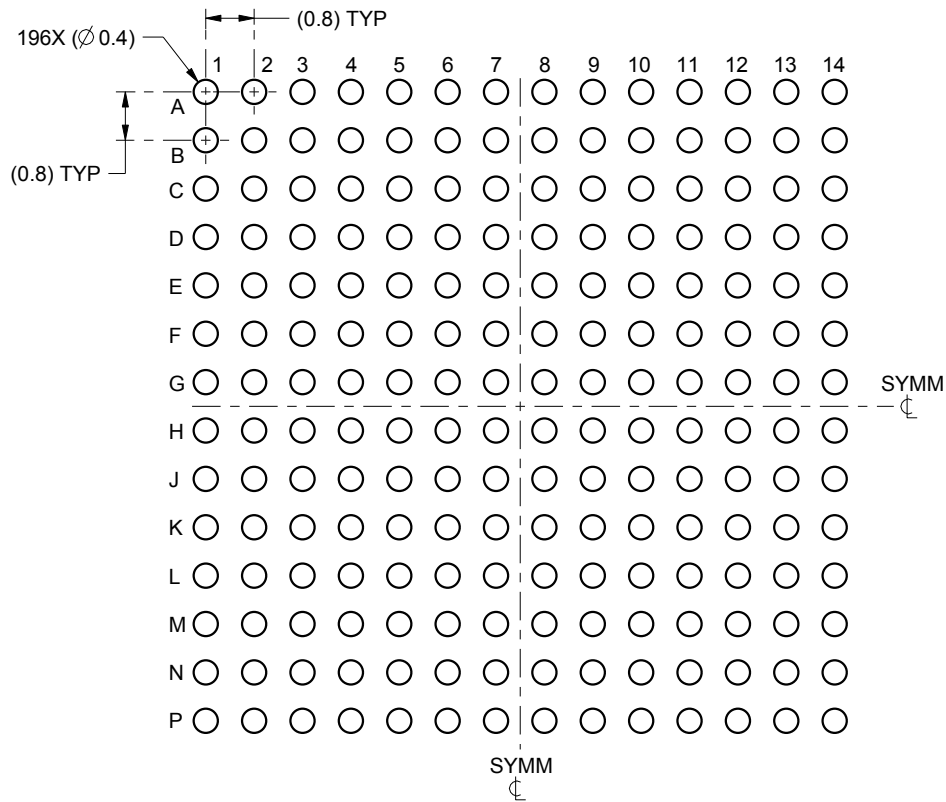

LAND PATTERN EXAMPLE  
SCALE:8X

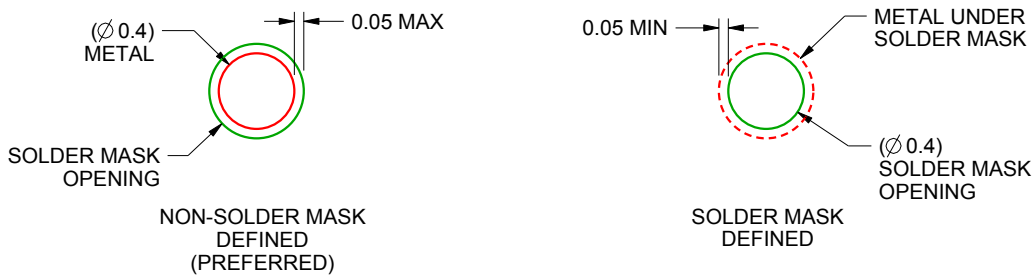

SOLDER MASK DETAILS  
NOT TO SCALE

4219823/A 09/2015

NOTES: (continued)

- Final dimensions may vary due to manufacturing tolerance considerations and also routing constraints. For information, see Texas Instruments literature number SPRAA99 ([www.ti.com/lit/spraa99](http://www.ti.com/lit/spraa99)).

# EXAMPLE STENCIL DESIGN

ZAY0196A

NFBGA - 1.4 mm max height

PLASTIC BALL GRID ARRAY

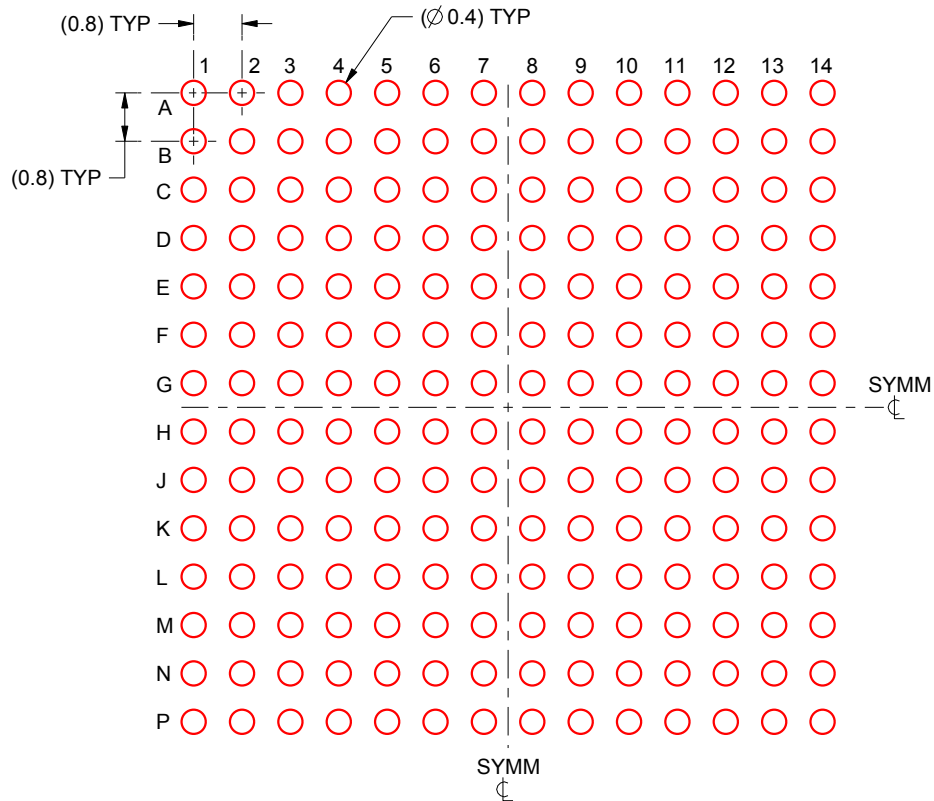

SOLDER PASTE EXAMPLE  
BASED ON 0.15 mm THICK STENCIL  
SCALE:8X

4219823/A 09/2015

NOTES: (continued)

4. Laser cutting apertures with trapezoidal walls and rounded corners may offer better paste release.

## IMPORTANT NOTICE AND DISCLAIMER

TI PROVIDES TECHNICAL AND RELIABILITY DATA (INCLUDING DATA SHEETS), DESIGN RESOURCES (INCLUDING REFERENCE DESIGNS), APPLICATION OR OTHER DESIGN ADVICE, WEB TOOLS, SAFETY INFORMATION, AND OTHER RESOURCES "AS IS" AND WITH ALL FAULTS, AND DISCLAIMS ALL WARRANTIES, EXPRESS AND IMPLIED, INCLUDING WITHOUT LIMITATION ANY IMPLIED WARRANTIES OF MERCHANTABILITY, FITNESS FOR A PARTICULAR PURPOSE OR NON-INFRINGEMENT OF THIRD PARTY INTELLECTUAL PROPERTY RIGHTS.

These resources are intended for skilled developers designing with TI products. You are solely responsible for (1) selecting the appropriate TI products for your application, (2) designing, validating and testing your application, and (3) ensuring your application meets applicable standards, and any other safety, security, regulatory or other requirements.

These resources are subject to change without notice. TI grants you permission to use these resources only for development of an application that uses the TI products described in the resource. Other reproduction and display of these resources is prohibited. No license is granted to any other TI intellectual property right or to any third party intellectual property right. TI disclaims responsibility for, and you will fully indemnify TI and its representatives against, any claims, damages, costs, losses, and liabilities arising out of your use of these resources.

TI's products are provided subject to [TI's Terms of Sale](#) or other applicable terms available either on [ti.com](https://www.ti.com) or provided in conjunction with such TI products. TI's provision of these resources does not expand or otherwise alter TI's applicable warranties or warranty disclaimers for TI products.

TI objects to and rejects any additional or different terms you may have proposed.

Mailing Address: Texas Instruments, Post Office Box 655303, Dallas, Texas 75265  
Copyright © 2023, Texas Instruments Incorporated