

AMC1301-Q1 Automotive, Precision, ± 250 -mV Input, Reinforced Isolated Amplifier

1 Features

- AEC-Q100 qualified for automotive applications:
 - Temperature grade 1: -40°C to $+125^{\circ}\text{C}$, T_A
- **Functional Safety-Capable**
 - [Documentation available to aid functional safety system design](#)
- ± 250 -mV input voltage range optimized for current measurements using shunt resistors
- Fixed gain: 8.2 V/V
- Low DC errors:
 - Offset error: ± 0.2 mV (max)
 - Offset drift: ± 3 $\mu\text{V}/^{\circ}\text{C}$ (max)
 - Gain error: $\pm 0.3\%$ (max)
 - Gain drift: ± 50 ppm/ $^{\circ}\text{C}$ (max)
 - Nonlinearity: 0.03% (max)
- 3.3-V operation on high-side and low-side
- System-level diagnostic features
- Safety-related certifications:
 - 7070- V_{PK} reinforced isolation per DIN EN IEC 60747-17 (VDE 0884-17)
 - 5000- V_{RMS} isolation for 1 minute per UL1577

2 Applications

- Shunt-based current sensing or resistor-divider-based voltage sensing in:
 - [Traction inverters](#)
 - [Onboard chargers \(OBC\)](#)
 - [DC/DC converters](#)
 - [Battery management systems \(BMS\)](#)

3 Description

The AMC1301-Q1 is a precision, isolated amplifier with an output separated from the input circuitry by an isolation barrier that is highly resistant to magnetic interference. This barrier is certified to provide reinforced isolation of up to 7070 V_{PEAK} according to the DIN EN IEC 60747-17 (VDE 0884-17) and UL1577 standards, and supports a working voltage up to 1 kV_{RMS} .

The isolation barrier separates parts of the system that operate on different common-mode voltage levels and protects the low-side from voltage levels that can cause electrical damage and are potentially harmful to an operator.

The input of the AMC1301-Q1 is optimized for direct connection to shunt resistors or other low voltage-level signal sources. The excellent DC accuracy and low temperature drift supports accurate current control in onboard chargers (OBC), DC/DC converters, frequency inverters, or other high-voltage applications. The integrated common-mode overvoltage and missing high-side supply voltage detection features of the AMC1301-Q1 simplify system-level design and diagnostics.

The AMC1301-Q1 is offered in a wide-body 8-pin SOIC package, is AEC-Q100 qualified for automotive applications, and supports the temperature range from -40°C to $+125^{\circ}\text{C}$.

Package Information

PART NUMBER	PACKAGE ⁽¹⁾	BODY SIZE (NOM)
AMC1301-Q1	DWV (SOIC, 8)	5.85 mm × 7.50 mm

(1) For all available packages, see the orderable addendum at the end of the data sheet.

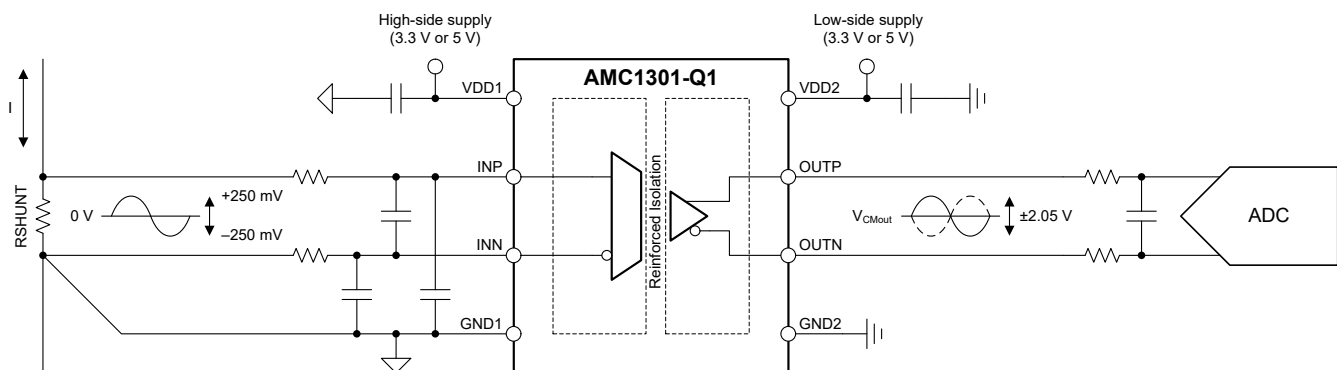

Typical Application



Table of Contents

1 Features	1	7.1 Overview.....	19
2 Applications	1	7.2 Functional Block Diagram.....	19
3 Description	1	7.3 Feature Description.....	19
4 Revision History	2	7.4 Device Functional Modes.....	21
5 Pin Configuration and Functions	4	8 Application and Implementation	22
6 Specifications	5	8.1 Application Information.....	22
6.1 Absolute Maximum Ratings.....	5	8.2 Typical Application.....	22
6.2 ESD Ratings.....	5	8.3 Best Design Practices.....	25
6.3 Recommended Operating Conditions.....	5	8.4 Power Supply Recommendations.....	25
6.4 Thermal Information.....	6	8.5 Layout.....	26
6.5 Power Ratings.....	6	9 Device and Documentation Support	27
6.6 Insulation Specifications.....	7	9.1 Documentation Support.....	27
6.7 Safety-Related Certifications.....	8	9.2 Receiving Notification of Documentation Updates.....	27
6.8 Safety Limiting Values.....	8	9.3 Support Resources.....	27
6.9 Electrical Characteristics.....	9	9.4 Trademarks.....	27
6.10 Switching Characteristics.....	10	9.5 Electrostatic Discharge Caution.....	27
6.11 Timing Diagram.....	10	9.6 Glossary.....	27
6.12 Insulation Characteristics Curves.....	11	10 Mechanical, Packaging, and Orderable Information	27
6.13 Typical Characteristics.....	12		
7 Detailed Description	19		

4 Revision History

NOTE: Page numbers for previous revisions may differ from page numbers in the current version.

Changes from March 13, 2023 to April 24, 2023 (from Revision A (April 2017) to Revision B (April 2023))

	Page
• Changed document title.....	1
• Changed <i>Features</i> section: Changed, deleted, and reorganized bullets.....	1
• Added <i>Functional-Safety-Capable</i> bullet to <i>Features</i> section.....	1
• Changed isolation standard from DIN VDE V 0884-11 (VDE V 0884-10) to DIN EN IEC 60747-17 (VDE 0884-17) and updated the <i>Insulation Specifications</i> and <i>Safety-Related Certifications</i> tables accordingly.....	1
• Changed the <i>Description</i> section to include common-mode decoupling capacitors as a known best practice..	1
• Changed pin names VINP to INP, VINN to INN, VOUTP to OUTP, and VOUTN to OUTN throughout document.....	4
• Changed <i>Description</i> column and added footnotes to <i>Pin Functions</i> table.....	4
• Changed PD from 81.4 mW to 99 mW.....	6
• Changed PD1 (VDD1 = 3.3 V) from 24.85 mW to 31 mW.....	6
• Changed PD1 (VDD1 = 5.5 V) from 45.65 mW to 54 mW.....	6
• Changed PD2 (VDD2 = 3.3 V) from 20.16 mW to 26 mW.....	6
• Changed PD2 (VDD2 = 5.5 V) from 35.75 mW to 45 mW.....	6
• Changed DTI from ≥ 0.027 mm to ≥ 0.021 mm in <i>Insulation Specifications</i> table.....	7
• Changed I_{IB} parameter specification and conditions.....	9
• Changed IDD1 ($3.0\text{ V} \leq VDD1 \leq 3.6\text{ V}$) from 5.0 mA (typ) / 6.9 mA (max) to 6.3 mA (typ) / 8.5 mA (max).....	9
• Changed IDD1 ($4.5\text{ V} \leq VDD1 \leq 5.5\text{ V}$) from 5.9 mA (typ) / 8.3 mA (max) to 7.2 mA (typ) / 9.8 mA (max).....	9
• Changed IDD2 ($3.0\text{ V} \leq VDD2 \leq 3.6\text{ V}$) from 4.4 mA (typ) / 5.6 mA (max) to 5.3 mA (typ) / 7.2 mA (max).....	9
• Changed IDD2 ($4.5\text{ V} \leq VDD2 \leq 5.5\text{ V}$) from 4.8 mA (typ) / 6.5 mA (max) to 5.9 mA (typ) / 8.1 mA (max).....	9
• Changed <i>Timing Diagram</i> section.....	10
• Changed <i>Input Bias Current vs Common-Mode Input Voltage</i> figure to align with new test condition.....	12
• Changed <i>Input Bias Current vs High-Side Supply Voltage</i> figure to align with new test condition.....	12
• Changed <i>Input Bias Current vs Temperature</i> figure to align with new test condition.....	12
• Changed legend of <i>Output Voltage vs Input Voltage</i> figure, V_{OUTP} is now red and V_{OUTN} is now black	12
• Changed <i>Overview</i> section.....	19
• Changed <i>Functional Block Diagram</i> image.....	19

• Changed the <i>Analog Input</i> section.....	19
• Added the <i>Isolation Channel Signal Transmission</i> section.....	20
• Added <i>Analog Output</i> section, deleted <i>Fail-Safe Output</i> section.....	21
• Changed <i>Device Functional Modes</i> section.....	21
• Changed <i>Application Information</i> section.....	22
• Changed <i>Typical Application</i> section.....	22
• Changed <i>Best Design Practices</i> section.....	25
• Changed <i>Power Supply Recommendations</i> section.....	25
• Changed the <i>Recommended Layout of the AMC1301-Q1</i> figure.....	26
• Added a link to the <i>Isolated Voltage-Measurement Circuit</i> in the <i>Related Documentation</i> section.....	27

Changes from Revision * (April 2017) to Revision A (April 2017)	Page
--	-------------

• Changed max specification of <i>Supply voltage</i> row in <i>Absolute Maximum Ratings</i> table from 6.5 V to 7 V.....	5
--	---

5 Pin Configuration and Functions

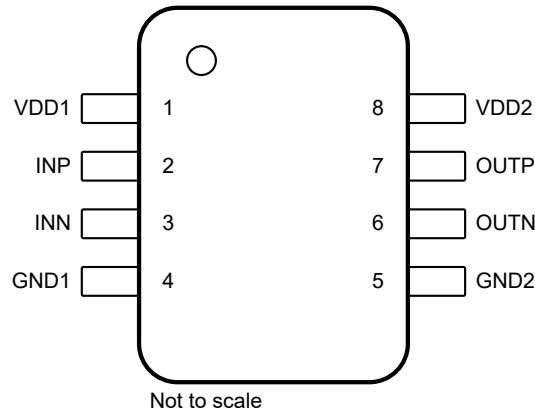

Figure 5-1. DWV Package, 8-Pin SOIC (Top View)

Table 5-1. Pin Functions

PIN		TYPE	DESCRIPTION
NO.	NAME		
1	VDD1	High-side power	High-side power supply. ⁽¹⁾
2	INP	Analog input	Noninverting analog input. Either INP or INN must have a DC current path to GND1 to define the common-mode input voltage. ⁽²⁾
3	INN	Analog input	Inverting analog input. Either INP or INN must have a DC current path to GND1 to define the common-mode input voltage. ⁽²⁾
4	GND1	High-side ground	High-side analog ground.
5	GND2	Low-side ground	Low-side analog ground.
6	OUTN	Analog output	Inverting analog output.
7	OUTP	Analog output	Noninverting analog output.
8	VDD2	Low-side power	Low-side power supply. ⁽¹⁾

(1) See the [Power Supply Recommendations](#) section for power-supply decoupling recommendations.

(2) See the [Layout](#) section for details.

6 Specifications

6.1 Absolute Maximum Ratings

see⁽¹⁾

		MIN	MAX	UNIT
Power-supply voltage	High-side VDD1 to GND1	-0.3	7	V
	Low-side VDD2 to GND2	-0.3	7	
Analog input voltage	INP, INN	GND1 – 6	VDD1 + 0.5	V
Input current	Continuous, any pin except power-supply pins	-10	10	mA
Temperature	Junction, T _J		150	°C
	Storage, T _{stg}	-65	150	

- (1) Operation outside the *Absolute Maximum Ratings* may cause permanent device damage. *Absolute Maximum Ratings* do not imply functional operation of the device at these or any other conditions beyond those listed under *Recommended Operating Conditions*. If used outside the Recommended Operating Conditions but within the Absolute Maximum Ratings, the device may not be fully functional, and this may affect device reliability, functionality, performance, and shorten the device lifetime

6.2 ESD Ratings

			VALUE	UNIT
V _(ESD)	Electrostatic discharge	Human-body model (HBM), per AEC Q100-002 ⁽¹⁾ , HBM ESD classification Level 2	±2000	V
		Charged-device model (CDM), per AEC Q100-011, CDM ESD classification Level C6	±1000	

- (1) AEC Q100-002 indicates that HBM stressing shall be in accordance with the ANSI/ESDA/JEDEC JS-001 specification.

6.3 Recommended Operating Conditions

over operating ambient temperature range (unless otherwise noted)

			MIN	NOM	MAX	UNIT
POWER SUPPLY						
	High-side power supply	VDD1 to GND1	3	5	5.5	V
	Low-side power supply	VDD2 to GND2	3	3.3	5.5	V
ANALOG INPUT						
V _{Clipping}	Differential input voltage before clipping output	$V_{IN} = V_{INP} - V_{INN}$	±302.7			mV
V _{FSR}	Specified linear differential full-scale voltage	$V_{IN} = V_{INP} - V_{INN}$	-250	250		mV
	Absolute common-mode input voltage ⁽¹⁾	$(V_{INP} + V_{INN}) / 2$ to GND1	-2	VDD1		V
V _{CM}	Operating common-mode input voltage	$(V_{INP} + V_{INN}) / 2$ to GND1	-0.16	VDD1 – 2.1		V
TEMPERATURE RANGE						
T _A	Specified ambient temperature		-40	125		°C

- (1) Steady-state voltage supported by the device in case of a system failure. See specified common-mode input voltage V_{CM} for normal operation. Observe analog input voltage range as specified in *Absolute Maximum Ratings* table.

6.4 Thermal Information

THERMAL METRIC ⁽¹⁾		DWV (SOIC)	UNIT
		8 PINS	
R _{θJA}	Junction-to-ambient thermal resistance	110.1	°C/W
R _{θJC(top)}	Junction-to-case (top) thermal resistance	51.7	°C/W
R _{θJB}	Junction-to-board thermal resistance	66.4	°C/W
Ψ _{JT}	Junction-to-top characterization parameter	16.0	°C/W
Ψ _{JB}	Junction-to-board characterization parameter	64.5	°C/W
R _{θJC(bot)}	Junction-to-case (bottom) thermal resistance	N/A	°C/W

(1) For more information about traditional and new thermal metrics, see the [Semiconductor and IC Package Thermal Metrics](#) application report.

6.5 Power Ratings

PARAMETER	TEST CONDITIONS	VALUE	UNIT
P _D	VDD1 = VDD2 = 5.5 V	99	mW
P _{D1}	VDD1 = 3.6 V	31	mW
	VDD1 = 5.5 V	54	
P _{D2}	VDD2 = 3.6 V	26	mW
	VDD2 = 5.5 V	45	

6.6 Insulation Specifications

over operating ambient temperature range (unless otherwise noted)

PARAMETER		TEST CONDITIONS	VALUE	UNIT
GENERAL				
CLR	External clearance ⁽¹⁾	Shortest pin-to-pin distance through air	≥ 8.5	mm
CPG	External creepage ⁽¹⁾	Shortest pin-to-pin distance across the package surface	≥ 8.5	mm
DTI	Distance through insulation	Minimum internal gap (internal clearance) of the double insulation	≥ 0.021	mm
CTI	Comparative tracking index	DIN EN 60112 (VDE 0303-11); IEC 60112	≥ 600	V
	Material group	According to IEC 60664-1	I	
	Overvoltage category per IEC 60664-1	Rated mains voltage ≤ 600 V _{RMS}	I-IV	
		Rated mains voltage ≤ 1000 V _{RMS}	I-III	
DIN EN IEC 60747-17 (VDE 0884-17)⁽²⁾				
V _{IORM}	Maximum repetitive peak isolation voltage	At AC voltage	1500	V _{PK}
V _{IOWM}	Maximum-rated isolation working voltage	At AC voltage (sine wave)	1000	V _{RMS}
		At DC voltage	1500	V _{DC}
V _{IOTM}	Maximum transient isolation voltage	V _{TEST} = V _{IOTM} , t = 60 s (qualification test), V _{TEST} = 1.2 × V _{IOTM} , t = 1 s (100% production test)	7000	V _{PK}
V _{IMP}	Maximum impulse voltage ⁽²⁾	Tested in air, 1.2/50-μs waveform per IEC 62368-1	7700	V _{PK}
V _{IOSM}	Maximum surge isolation voltage ⁽³⁾	Tested in oil (qualification test), 1.2/50-μs waveform per IEC 62368-1	10000	V _{PK}
q _{pd}	Apparent charge ⁽⁵⁾	Method a, after input/output safety test subgroups 2 and 3, V _{pd(ini)} = V _{IOTM} , t _{ini} = 60 s, V _{pd(m)} = 1.2 × V _{IORM} , t _m = 10 s	≤ 5	pC
		Method a, after environmental tests subgroup 1, V _{pd(ini)} = V _{IOTM} , t _{ini} = 60 s, V _{pd(m)} = 1.6 × V _{IORM} , t _m = 10 s	≤ 5	
		Method b1, at preconditioning (type test) and routine test, V _{pd(ini)} = 1.2 × V _{IOTM} , t _{ini} = 1 s, V _{pd(m)} = 1.875 × V _{IORM} , t _m = 1 s	≤ 5	
		Method b2, at routine test (100% production) ⁽⁷⁾ , V _{pd(ini)} = V _{pd(m)} = 1.2 × V _{IOTM} , t _{ini} = t _m = 1 s	≤ 5	
C _{IO}	Barrier capacitance, input to output ⁽⁵⁾	V _{IO} = 0.5 V _{PP} at 1 MHz	~1.2	pF
R _{IO}	Insulation resistance, input to output ⁽⁵⁾	V _{IO} = 500 V at T _A = 25°C	> 10 ¹²	Ω
		V _{IO} = 500 V at 100°C ≤ T _A ≤ 125°C	> 10 ¹¹	
		V _{IO} = 500 V at T _S = 150°C	> 10 ⁹	
	Pollution degree		2	
	Climatic category	AMC1301	40/125/21	
		AMC1301S	55/125/21	
UL1577				
V _{ISO}	Withstand isolation voltage	V _{TEST} = V _{ISO} , t = 60 s (qualification test), V _{TEST} = 1.2 × V _{ISO} , t = 1 s (100% production test)	5000	V _{RMS}

- (1) Apply creepage and clearance requirements according to the specific equipment isolation standards of an application. Care must be taken to maintain the creepage and clearance distance of a board design to ensure that the mounting pads of the isolator on the printed circuit board (PCB) do not reduce this distance. Creepage and clearance on a PCB become equal in certain cases. Techniques such as inserting grooves, ribs, or both on a PCB are used to help increase these specifications.
- (2) Testing is carried out in air to determine the surge immunity of the package.
- (3) Testing is carried in oil to determine the intrinsic surge immunity of the isolation barrier.
- (4) Apparent charge is electrical discharge caused by a partial discharge (pd).
- (5) All pins on each side of the barrier are tied together, creating a two-pin device.
- (6) Either method b1 or b2 is used in production.

6.7 Safety-Related Certifications

VDE	UL
DIN EN IEC 60747-17 (VDE 0884-17), EN IEC 60747-17, DIN EN IEC 62368-1 (VDE 0868-1), EN IEC 62368-1, IEC 62368-1 Clause : 5.4.3 ; 5.4.4.4 ; 5.4.9	Recognized under 1577 component recognition program
Reinforced insulation	Single protection
Certificate number: 40040142	File number: E181974

6.8 Safety Limiting Values

Safety limiting⁽¹⁾ intends to minimize potential damage to the isolation barrier upon failure of input or output circuitry. A failure of the I/O can allow low resistance to ground or the supply and, without current limiting, dissipate sufficient power to over-heat the die and damage the isolation barrier potentially leading to secondary system failures.

PARAMETER		TEST CONDITIONS	MIN	TYP	MAX	UNIT
I _S	Safety input, output, or supply current	R _{θJA} = 110.1°C/W, VDDx = 5.5 V, T _J = 150°C, T _A = 25°C			206	mA
I _S	Safety input, output, or supply current	R _{θJA} = 110.1°C/W, VDDx = 3.6 V, T _J = 150°C, T _A = 25°C			315	mA
P _S	Safety input, output, or total power	R _{θJA} = 110.1°C/W, T _J = 150°C, T _A = 25°C			1135	mW
T _S	Maximum safety temperature				150	°C

- (1) The maximum safety temperature, T_S, has the same value as the maximum junction temperature, T_J, specified for the device. The I_S and P_S parameters represent the safety current and safety power, respectively. Do not exceed the maximum limits of I_S and P_S. These limits vary with the ambient temperature, T_A.

The junction-to-air thermal resistance, R_{θJA}, in the Thermal Information table is that of a device installed on a high-K test board for leaded surface-mount packages. Use these equations to calculate the value for each parameter:

$T_J = T_A + R_{\theta JA} \times P$, where P is the power dissipated in the device.

$T_{J(max)} = T_S = T_A + R_{\theta JA} \times P_S$, where T_{J(max)} is the maximum junction temperature.

$P_S = I_S \times VDD_{max}$, where VDD_{max} is the maximum supply voltage for high-side and low-side.

6.9 Electrical Characteristics

minimum and maximum specifications apply from $T_A = -40^\circ\text{C}$ to $+125^\circ\text{C}$, $V_{DD1} = 3.0\text{ V}$ to 5.5 V , $V_{DD2} = 3.0\text{ V}$ to 5.5 V , $I_{NP} = -250\text{ mV}$ to $+250\text{ mV}$, and $I_{NN} = \text{GND1}$; typical specifications are at $T_A = 25^\circ\text{C}$, $V_{DD1} = 5\text{ V}$, and $V_{DD2} = 3.3\text{ V}$ (unless otherwise noted)

PARAMETER		TEST CONDITIONS	MIN	TYP	MAX	UNIT
ANALOG INPUT						
V_{CMov}	Common-mode overvoltage detection level	$(V_{INP} + V_{INN}) / 2$ to GND1	$V_{DD1} - 2$			V
	Hysteresis of common-mode overvoltage detection level		60			mV
V_{OS}	Input offset voltage ⁽¹⁾	Initial, at $T_A = 25^\circ\text{C}$, $I_{NP} = I_{NN} = \text{GND1}$	-0.2	± 0.05	0.2	mV
TCV_{OS}	Input offset drift ⁽¹⁾ ((4))		-3	± 1	3	$\mu\text{V}/^\circ\text{C}$
CMRR	Common-mode rejection ratio	$f_{IN} = 0\text{ Hz}$, $V_{CM\ min} \leq V_{CM} \leq V_{CM\ max}$	-93			dB
		$f_{IN} = 10\text{ kHz}$, $V_{CM\ min} \leq V_{CM} \leq V_{CM\ max}$	-93			
R_{IN}	Single-ended input resistance	$I_{NN} = \text{GND1}$	18			k Ω
R_{IND}	Differential input resistance		22			k Ω
I_{IB}	Input bias current	$I_{NP} = I_{NN} = \text{GND1}$; $I_{IB} = (I_{IBP} + I_{IBN}) / 2$	-41	-30	-24	μA
TCI_{IB}	Input bias current drift		1			$\text{nA}/^\circ\text{C}$
C_{IND}	Differential input capacitance		1			pF
ANALOG OUTPUT						
	Nominal gain		8.2			V/V
E_G	Gain error ⁽¹⁾	at $T_A = 25^\circ\text{C}$	-0.3%	$\pm 0.05\%$	0.3%	
TCE_G	Gain drift ⁽¹⁾ ((5))		-50	± 15	50	$\text{ppm}/^\circ\text{C}$
	Nonlinearity ⁽¹⁾		-0.03%	$\pm 0.01\%$	0.03%	
	Nonlinearity drift		± 1			$\text{ppm}/^\circ\text{C}$
THD	Total harmonic distortion ⁽³⁾	$f_{IN} = 10\text{ kHz}$	-87			dB
	Output noise	$I_{NP} = I_{NN} = \text{GND1}$, $f_{IN} = 0\text{ Hz}$, $BW = 100\text{ kHz}$ brickwall filter	220			μV_{RMS}
SNR	Signal-to-noise ratio	$f_{IN} = 1\text{ kHz}$, $BW = 10\text{ kHz}$	80	84		dB
		$f_{IN} = 10\text{ kHz}$, $BW = 100\text{ kHz}$	71			
PSRR	Power-supply rejection ratio ⁽²⁾	PSRR vs V_{DD1} , at DC	-94			dB
		PSRR vs V_{DD1} , 100-mV and 10-kHz ripple	-90			
		PSRR vs V_{DD2} , at DC	-100			
		PSRR vs V_{DD2} , 100-mV and 10-kHz ripple	-94			
V_{CMout}	Common-mode output voltage		1.39	1.44	1.49	V
$V_{CLIPout}$	Clipping differential output voltage	$V_{OUT} = (V_{OUTP} - V_{OUTN})$; $ V_{IN} = V_{INP} - V_{INN} > V_{Clipping} $	-2.52	± 2.49	2.52	V
$V_{Failsafe}$	Failsafe differential output voltage	$V_{CM} \geq V_{CMov}$, or V_{DD1} missing	-2.563	-2.545		V
BW	Output bandwidth		190	210		kHz
R_{OUT}	Output resistance	On O_{UTP} or O_{UTN}	< 0.2			Ω
	Output short-circuit current	On O_{UTP} or O_{UTN} , sourcing or sinking, $I_{NN} = I_{NP} = \text{GND1}$, outputs shorted to either GND2 or V_{DD2}	13			mA
CMTI	Common-mode transient immunity	$ GND1 - GND2 = 1\text{ kV}$	15			$\text{kV}/\mu\text{s}$

6.9 Electrical Characteristics (continued)

minimum and maximum specifications apply from $T_A = -40^{\circ}\text{C}$ to $+125^{\circ}\text{C}$, $V_{DD1} = 3.0\text{ V}$ to 5.5 V , $V_{DD2} = 3.0\text{ V}$ to 5.5 V , $\text{INP} = -250\text{ mV}$ to $+250\text{ mV}$, and $\text{INN} = \text{GND1}$; typical specifications are at $T_A = 25^{\circ}\text{C}$, $V_{DD1} = 5\text{ V}$, and $V_{DD2} = 3.3\text{ V}$ (unless otherwise noted)

PARAMETER		TEST CONDITIONS	MIN	TYP	MAX	UNIT
POWER SUPPLY						
IDD1	High-side supply current	$3.0\text{ V} \leq V_{DD1} \leq 3.6\text{ V}$		6.3	8.5	mA
		$4.5\text{ V} \leq V_{DD1} \leq 5.5\text{ V}$		7.2	9.8	
IDD2	Low-side supply current	$3.0\text{ V} \leq V_{DD2} \leq 3.6\text{ V}$		5.3	7.2	mA
		$4.5\text{ V} \leq V_{DD2} \leq 5.5\text{ V}$		5.9	8.1	

- (1) The typical value includes one standard deviation (*sigma*) at nominal operating conditions.
- (2) This parameter is input referred.
- (3) THD is the ratio of the rms sum of the amplitudes of first five higher harmonics to the amplitude of the fundamental.
- (4) Offset error temperature drift is calculated using the box method, as described by the following equation:
 $TCV_{OS} = (V_{OS,MAX} - V_{OS,MIN}) / TempRange$ where $V_{OS,MAX}$ and $V_{OS,MIN}$ refer to the maximum and minimum V_{OS} values measured within the temperature range (-40 to 125°C).
- (5) Gain error temperature drift is calculated using the box method, as described by the following equation:
 $TCE_G (ppm) = ((E_{G,MAX} - E_{G,MIN}) / TempRange) \times 10^4$ where $E_{G,MAX}$ and $E_{G,MIN}$ refer to the maximum and minimum E_G values (in %) measured within the temperature range (-40 to 125°C).

6.10 Switching Characteristics

over operating ambient temperature range (unless otherwise noted)

PARAMETER		TEST CONDITIONS	MIN	TYP	MAX	UNIT
t_r	Output signal rise time			2.0		μs
t_f	Output signal fall time			2.0		μs
	V_{INx} to V_{OUTx} signal delay (50% - 10%)	Unfiltered output		0.7	2.0	μs
	V_{INx} to V_{OUTx} signal delay (50% - 50%)	Unfiltered output		1.6	2.6	μs
	V_{INx} to V_{OUTx} signal delay (50% - 90%)	Unfiltered output		2.5	3	μs

6.11 Timing Diagram

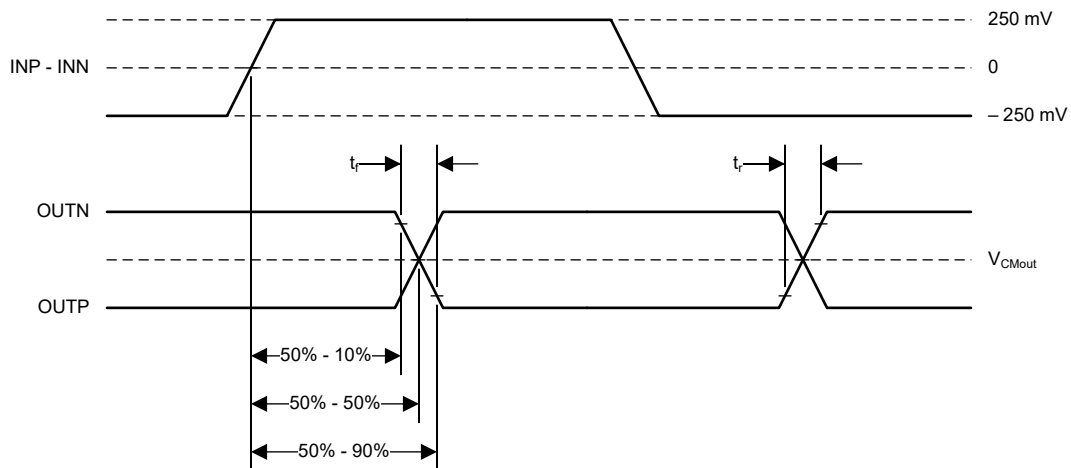

Figure 6-1. Rise, Fall, and Delay Time Definition

6.12 Insulation Characteristics Curves

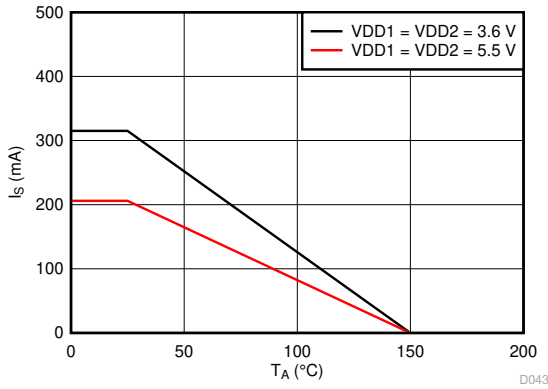

Figure 6-2. Thermal Derating Curve for Safety-Limiting Current per VDE

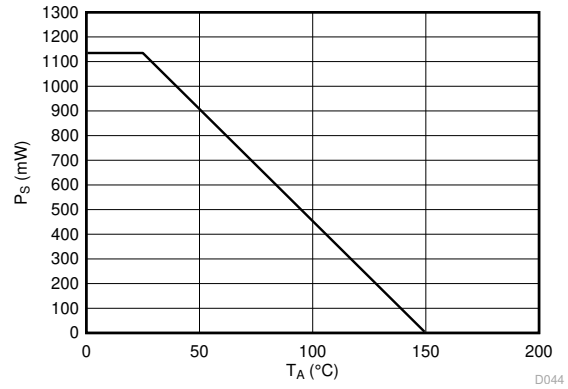
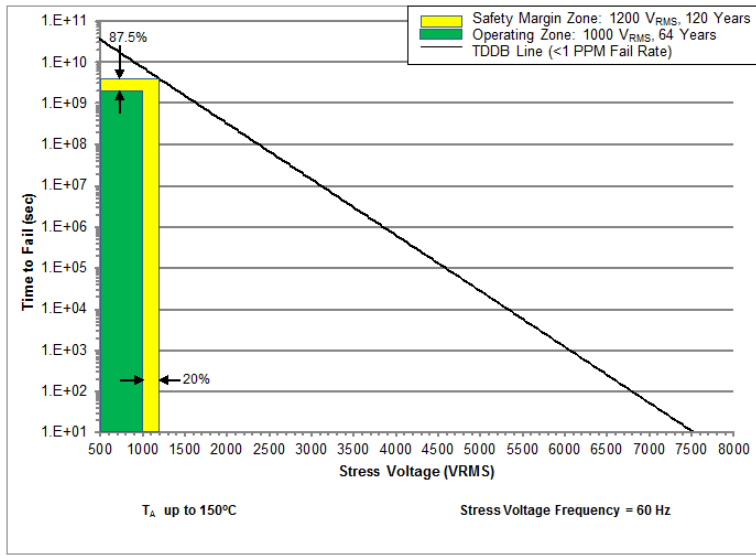

Figure 6-3. Thermal Derating Curve for Safety-Limiting Power per VDE



T_A up to 150°C, stress voltage frequency = 60 Hz

Figure 6-4. Reinforced Isolation Capacitor Lifetime Projection

6.13 Typical Characteristics

at VDD1 = 5 V, VDD2 = 3.3 V, INP = -250 mV to 250 mV, INN = 0 V, and $f_{IN} = 10$ kHz (unless otherwise noted)

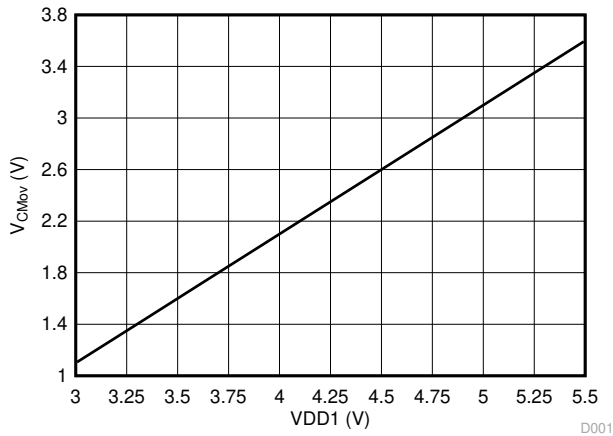

Figure 6-5. Common-Mode Overvoltage Detection Level vs High-Side Supply Voltage

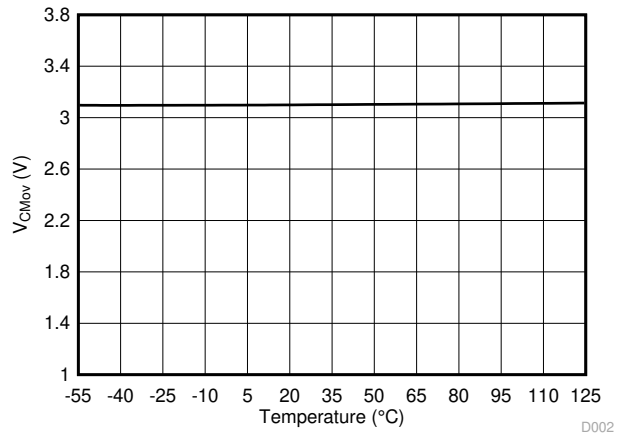

Figure 6-6. Common-Mode Overvoltage Detection Level vs Temperature

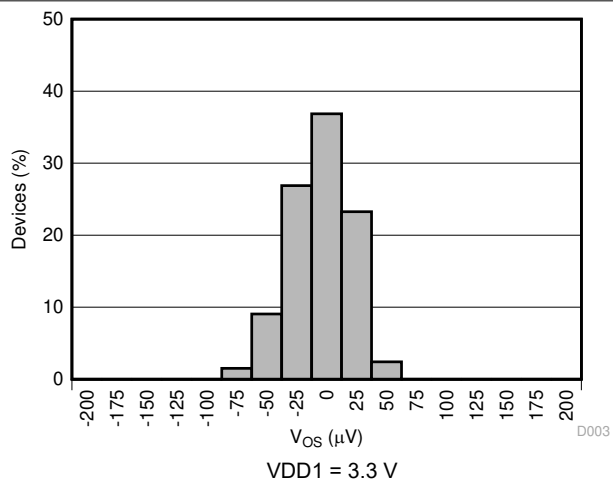

Figure 6-7. Input Offset Voltage Histogram

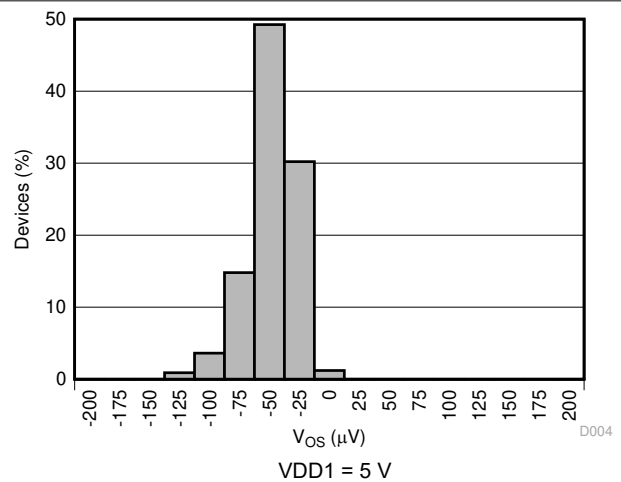

Figure 6-8. Input Offset Voltage Histogram

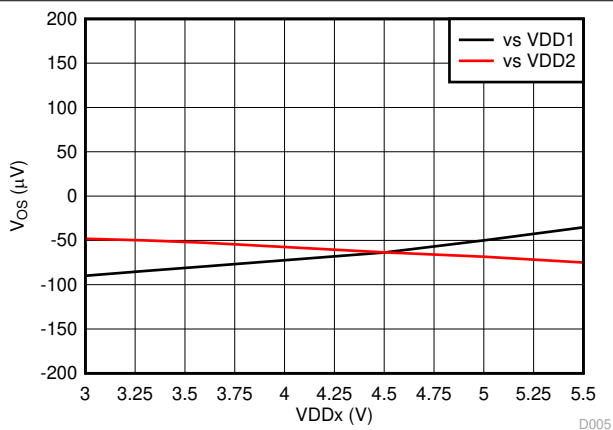

Figure 6-9. Input Offset Voltage vs Supply Voltage

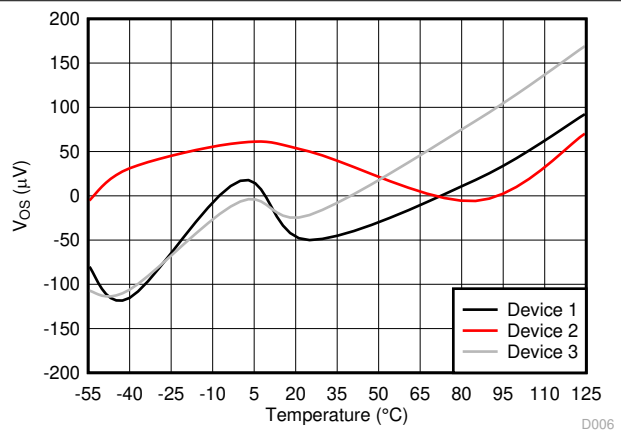

Figure 6-10. Input Offset Voltage vs Temperature

6.13 Typical Characteristics (continued)

at VDD1 = 5 V, VDD2 = 3.3 V, INP = -250 mV to 250 mV, INN = 0 V, and $f_{IN} = 10$ kHz (unless otherwise noted)

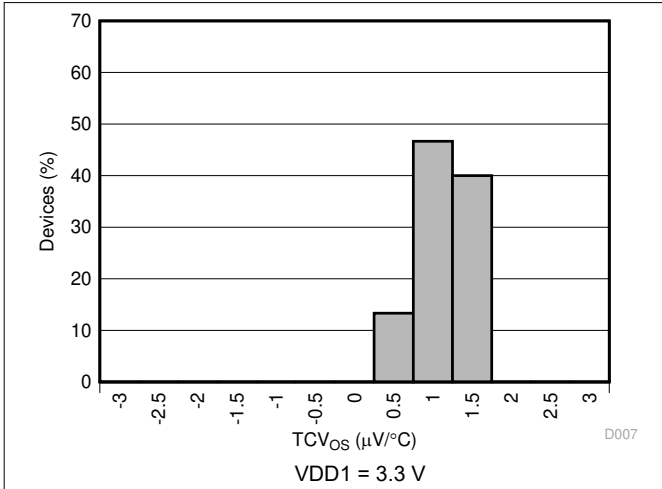

Figure 6-11. Input Offset Drift Histogram

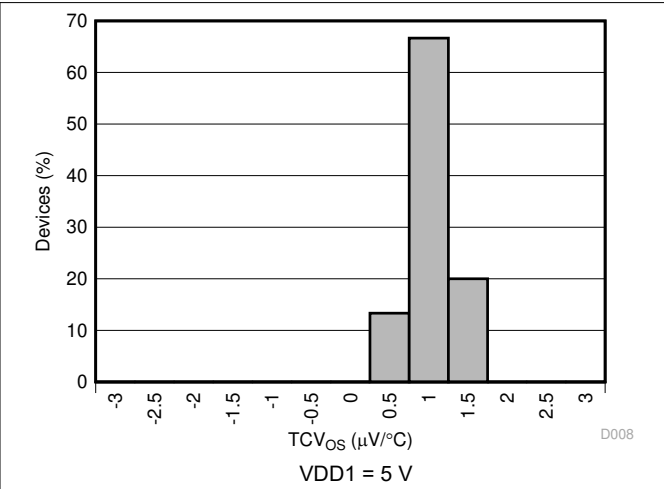

Figure 6-12. Input Offset Drift Histogram

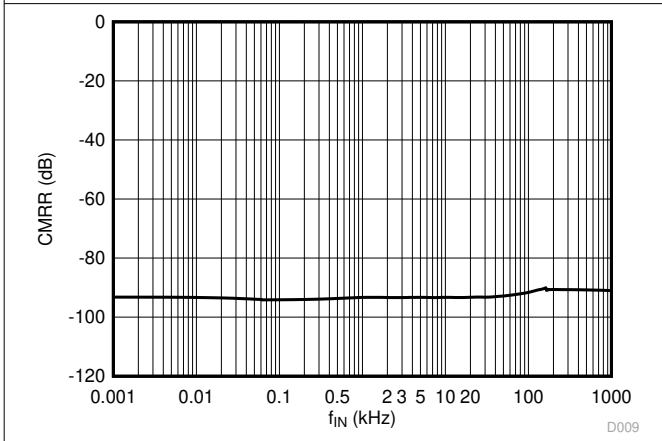

Figure 6-13. Common-Mode Rejection Ratio vs Input Frequency

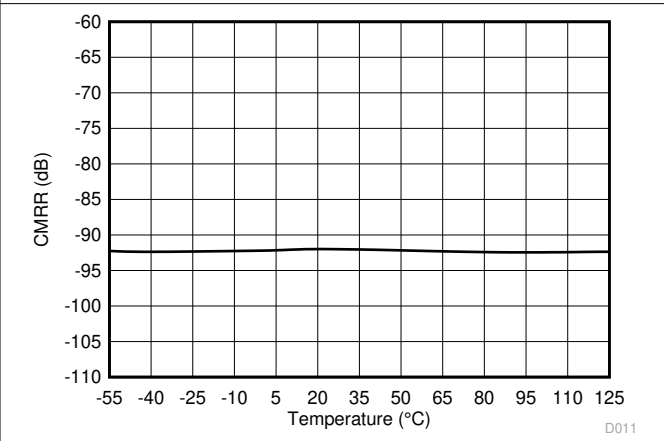

Figure 6-14. Common-Mode Rejection Ratio vs Temperature

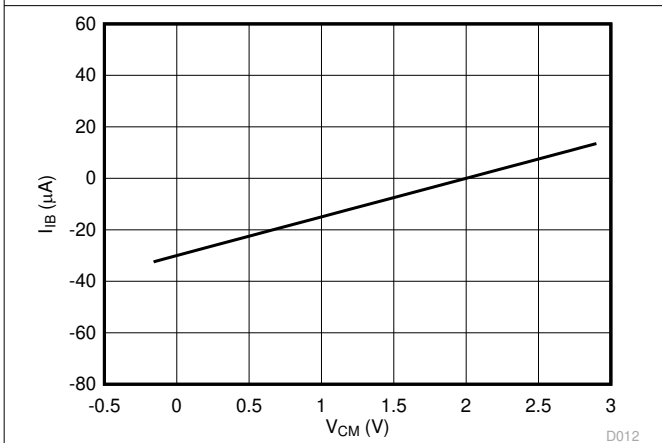

Figure 6-15. Input Bias Current vs Common-Mode Input Voltage

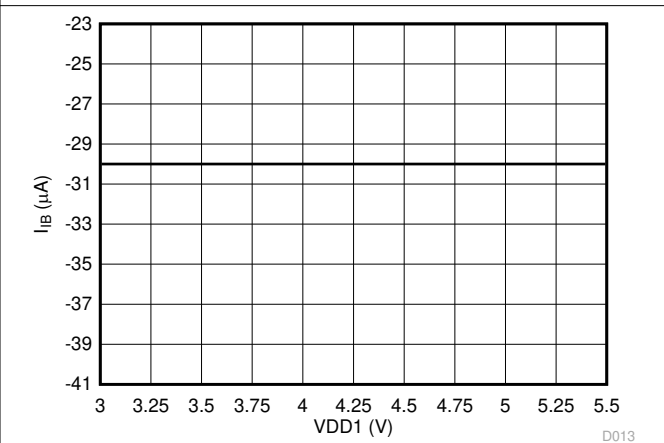

Figure 6-16. Input Bias Current vs High-Side Supply Voltage

6.13 Typical Characteristics (continued)

at VDD1 = 5 V, VDD2 = 3.3 V, INP = -250 mV to 250 mV, INN = 0 V, and $f_{IN} = 10$ kHz (unless otherwise noted)

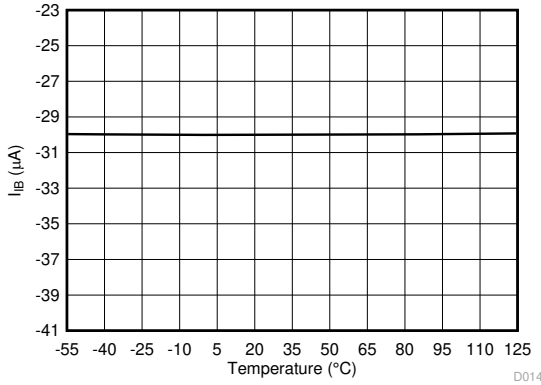

Figure 6-17. Input Bias Current vs Temperature

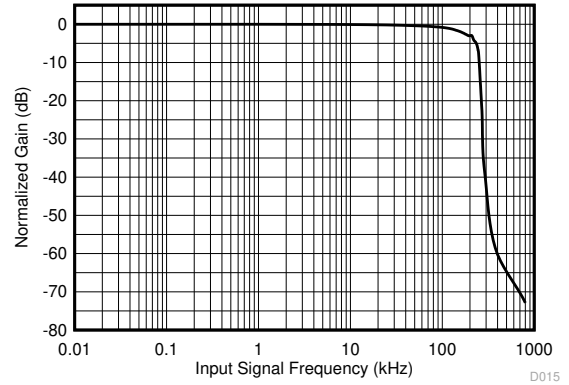

Figure 6-18. Normalized Gain vs Input Frequency

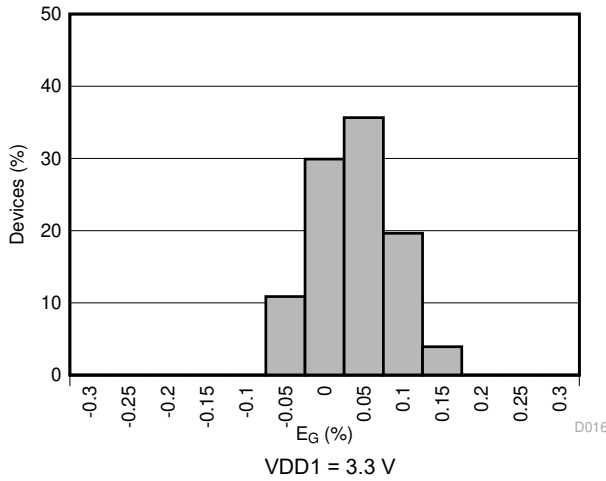

Figure 6-19. Gain Error Histogram

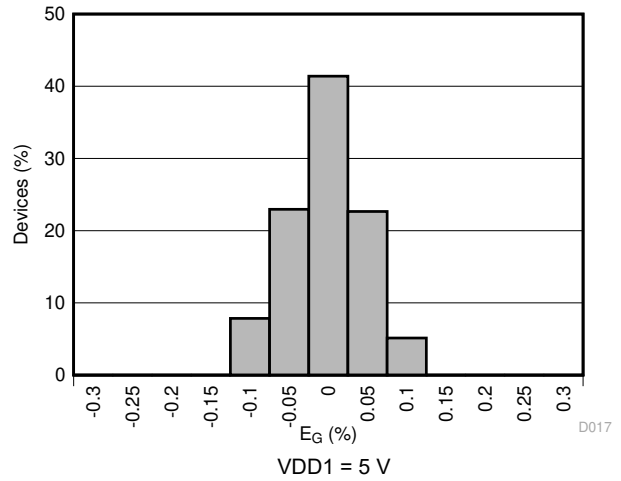

Figure 6-20. Gain Error Histogram

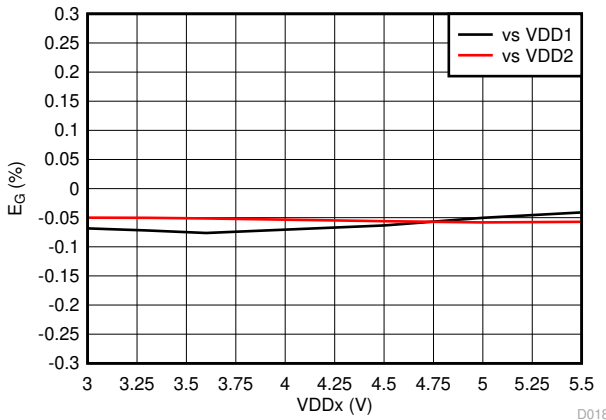

Figure 6-21. Gain Error vs Supply Voltage

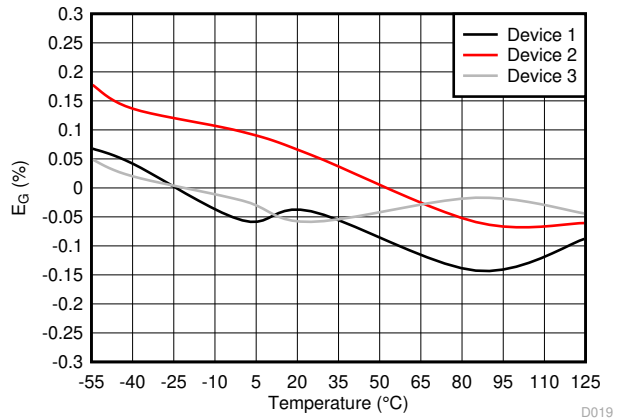

Figure 6-22. Gain Error vs Temperature

6.13 Typical Characteristics (continued)

at VDD1 = 5 V, VDD2 = 3.3 V, INP = -250 mV to 250 mV, INN = 0 V, and $f_{IN} = 10$ kHz (unless otherwise noted)

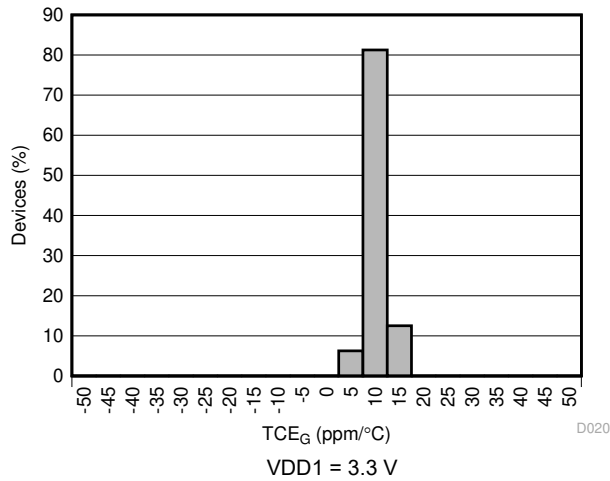

Figure 6-23. Gain Error Drift Histogram

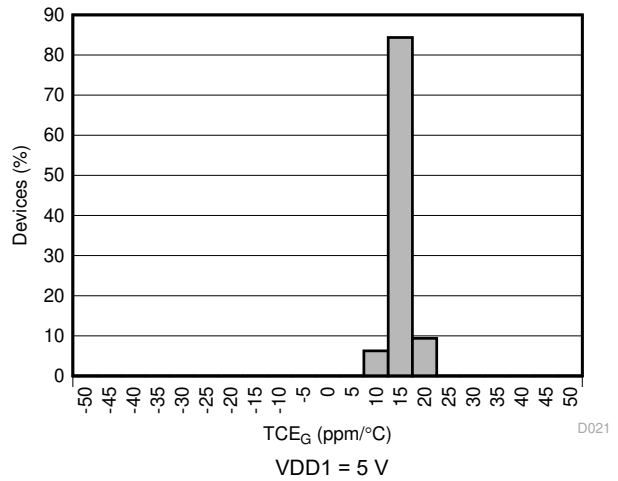

Figure 6-24. Gain Error Drift Histogram

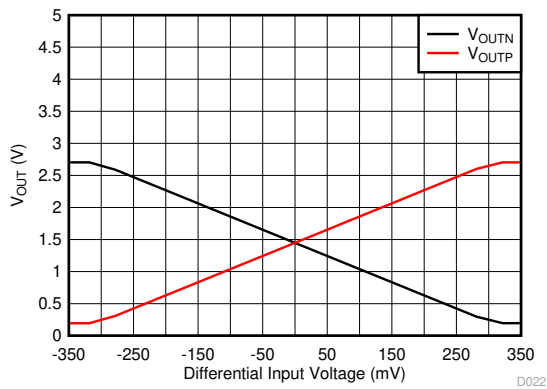

Figure 6-25. Output Voltage vs Input Voltage

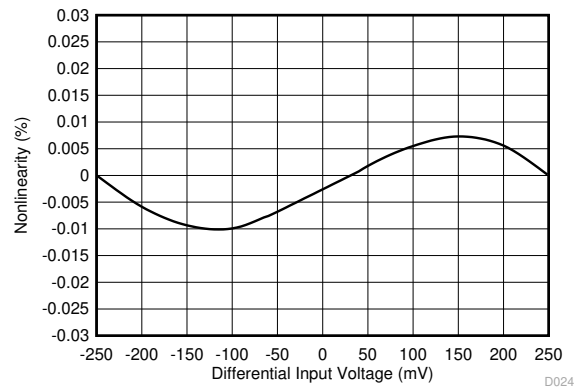

Figure 6-26. Nonlinearity vs Input Voltage

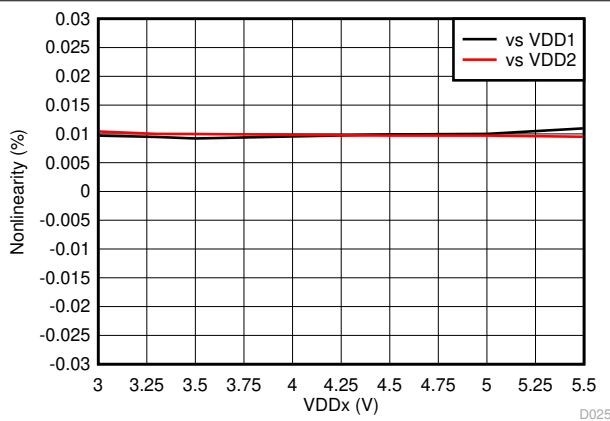

Figure 6-27. Nonlinearity vs Supply Voltage

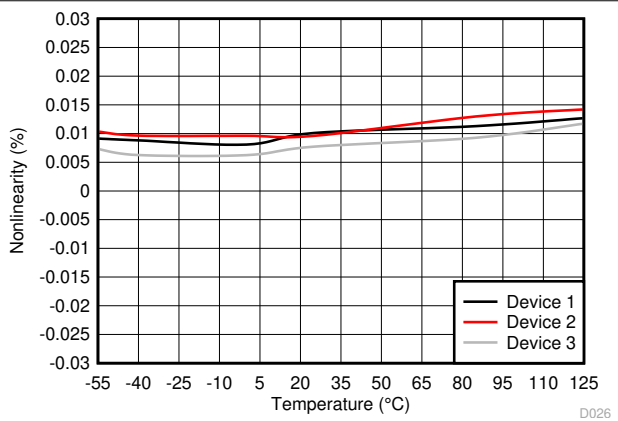

Figure 6-28. Nonlinearity vs Temperature

6.13 Typical Characteristics (continued)

at VDD1 = 5 V, VDD2 = 3.3 V, INP = -250 mV to 250 mV, INN = 0 V, and $f_{IN} = 10$ kHz (unless otherwise noted)

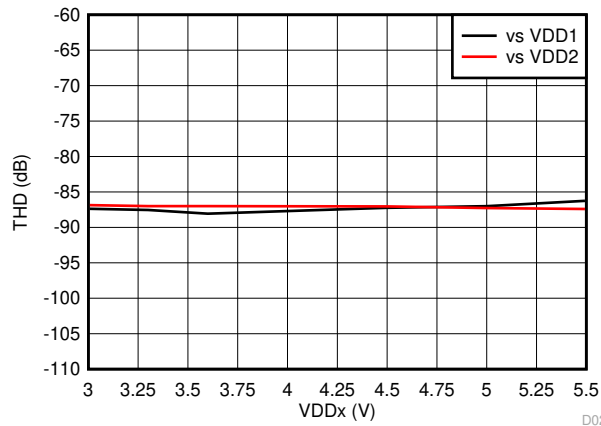

Figure 6-29. Total Harmonic Distortion vs Supply Voltage

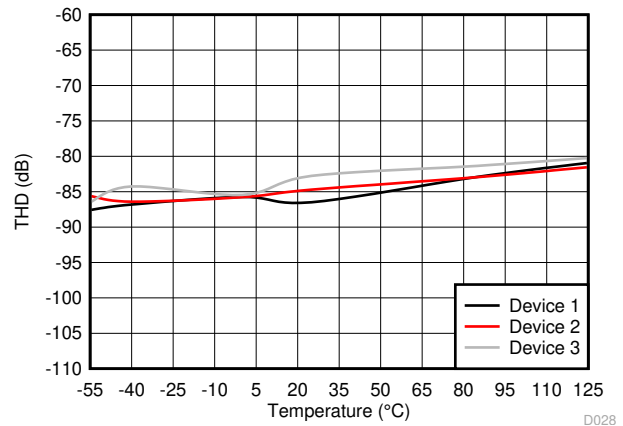

Figure 6-30. Total Harmonic Distortion vs Temperature

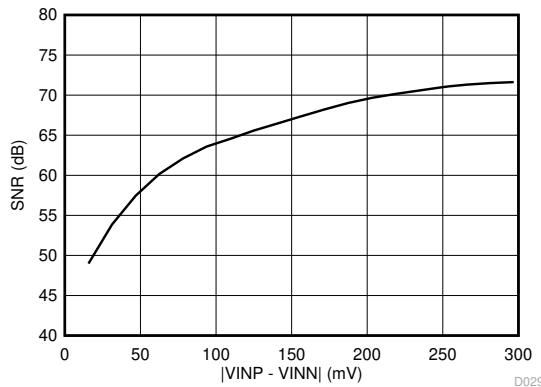

Figure 6-31. Signal-to-Noise Ratio vs Input Voltage

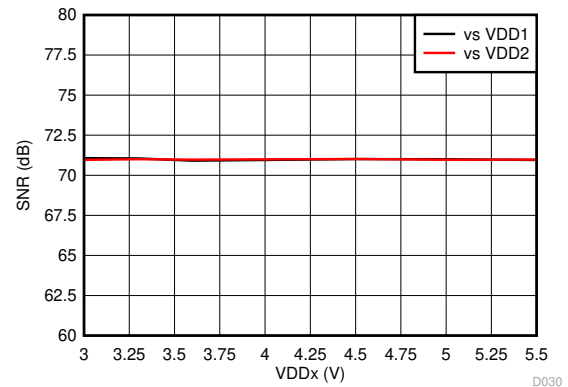

Figure 6-32. Signal-to-Noise Ratio vs Supply Voltage

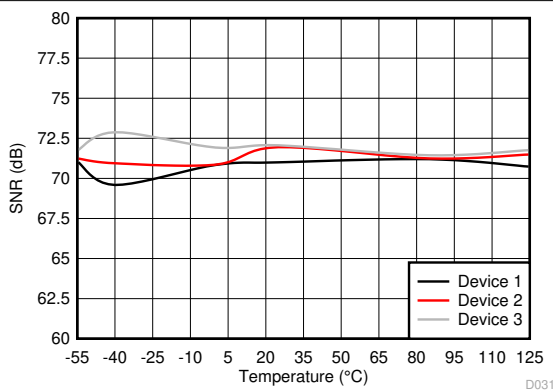

Figure 6-33. Signal-to-Noise Ratio vs Temperature

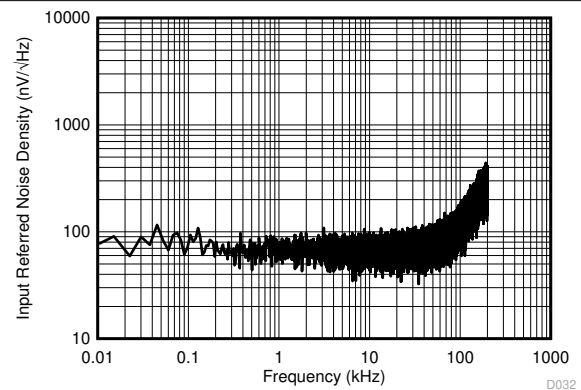

Figure 6-34. Input-Referred Noise Density vs Frequency

6.13 Typical Characteristics (continued)

at VDD1 = 5 V, VDD2 = 3.3 V, INP = -250 mV to 250 mV, INN = 0 V, and $f_{IN} = 10$ kHz (unless otherwise noted)

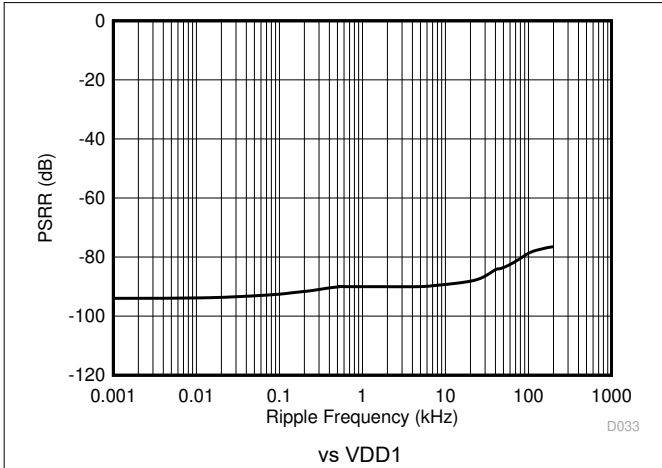

Figure 6-35. Power-Supply Rejection Ratio vs Ripple Frequency

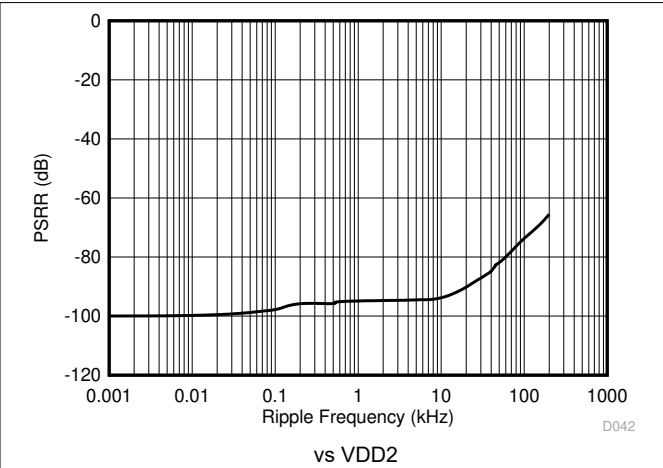

Figure 6-36. Power-Supply Rejection Ratio vs Ripple Frequency

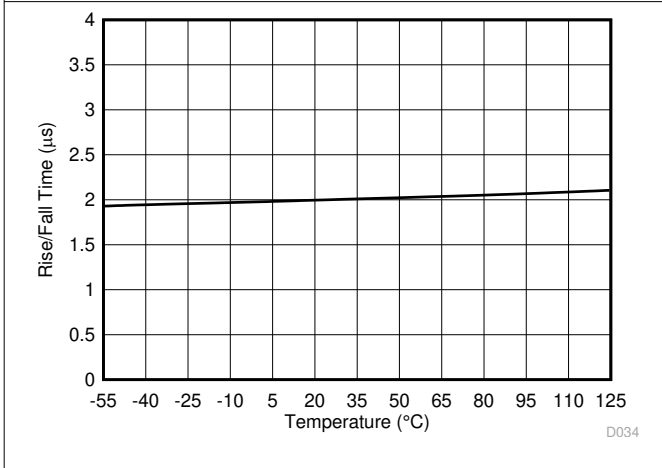

Figure 6-37. Output Rise and Fall Time vs Temperature

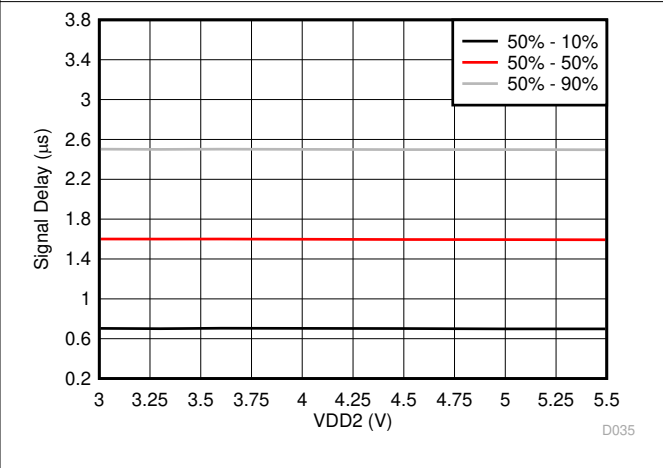

Figure 6-38. V_{IN} to V_{OUT} Signal Delay vs Low-Side Supply Voltage

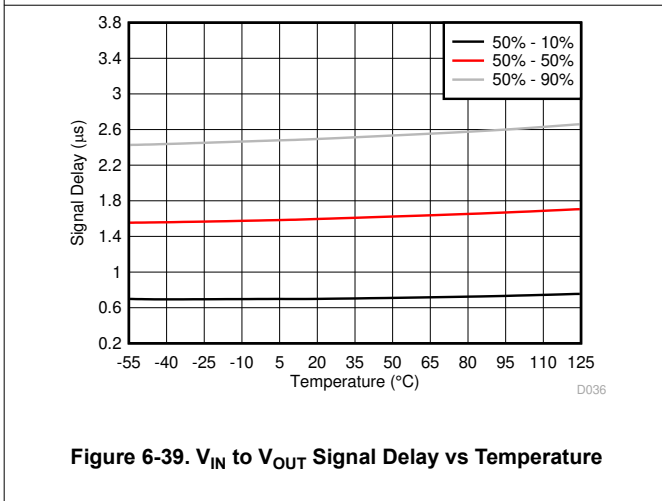

Figure 6-39. V_{IN} to V_{OUT} Signal Delay vs Temperature

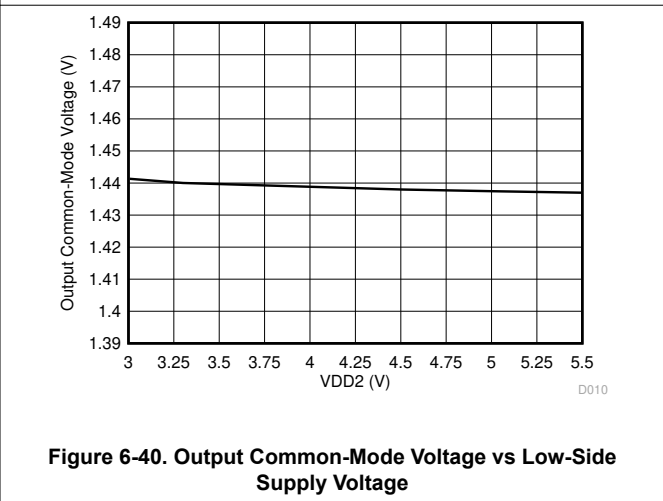

Figure 6-40. Output Common-Mode Voltage vs Low-Side Supply Voltage

6.13 Typical Characteristics (continued)

at VDD1 = 5 V, VDD2 = 3.3 V, INP = -250 mV to 250 mV, INN = 0 V, and $f_{IN} = 10$ kHz (unless otherwise noted)

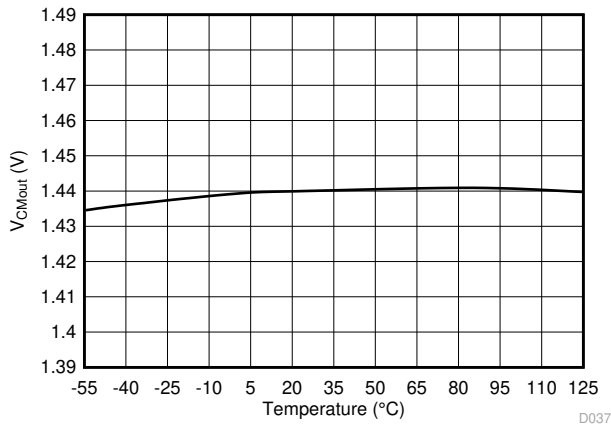

Figure 6-41. Output Common-Mode Voltage vs Temperature

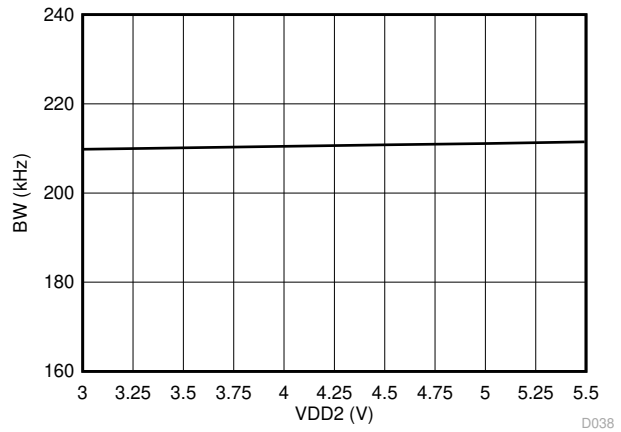

Figure 6-42. Output Bandwidth vs Low-Side Supply Voltage

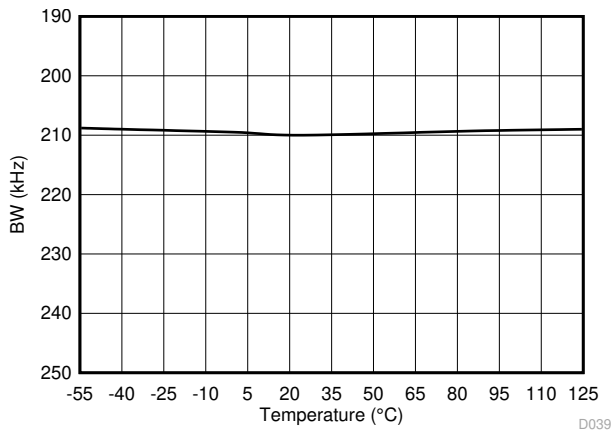

Figure 6-43. Output Bandwidth vs Temperature

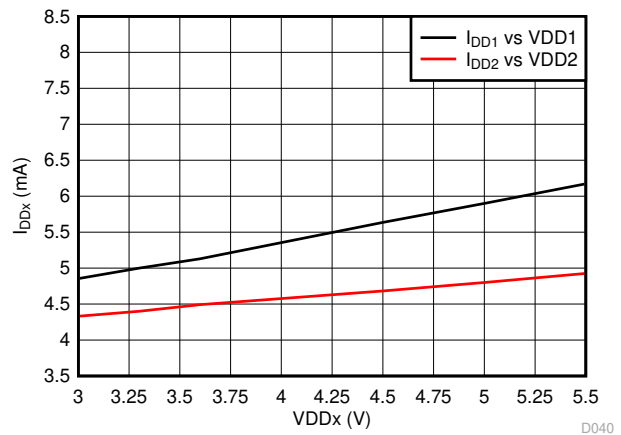

Figure 6-44. Supply Current vs Supply Voltage

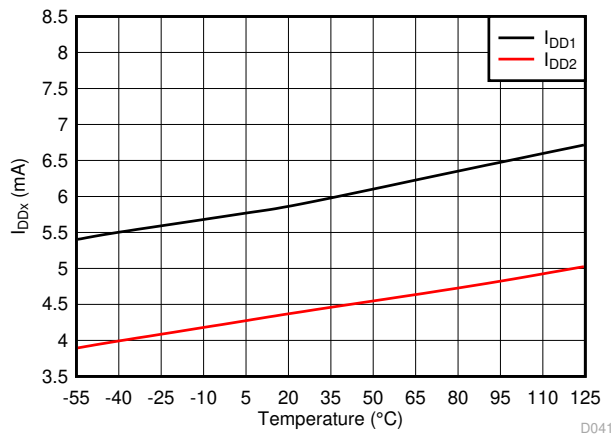

Figure 6-45. Supply Current vs Temperature

7 Detailed Description

7.1 Overview

The AMC1301-Q1 is a fully differential, precision, isolated amplifier. The input stage of the device consists of a fully differential amplifier that drives a second-order, delta-sigma ($\Delta\Sigma$) modulator. The modulator converts the analog input signal into a digital bitstream that is transferred across the isolation barrier that separates the high-side from the low-side. On the low-side, the received bitstream is processed by a fourth-order analog filter that outputs a differential signal at the OUPN and OUTN pins that is proportional to the input signal.

The SiO₂-based, capacitive isolation barrier supports a high level of magnetic field immunity, as described in the [ISO72x Digital Isolator Magnetic-Field Immunity application note](#). The digital modulation used in the AMC1301-Q1 to transmit data across the isolation barrier, and the isolation barrier characteristics, result in high reliability and common-mode transient immunity.

7.2 Functional Block Diagram

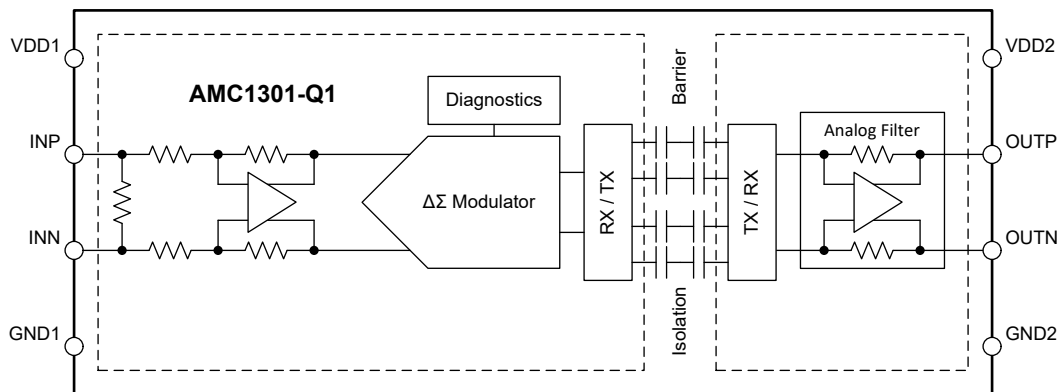

7.3 Feature Description

7.3.1 Analog Input

The differential amplifier input stage of the AMC1301-Q1 feeds a second-order, switched-capacitor, feed-forward $\Delta\Sigma$ modulator. The gain of the differential amplifier is set by internal precision resistors with a differential input impedance of R_{IND} . The modulator converts the analog input signal into a bitstream that is transferred across the isolation barrier, as described in the [Isolation Channel Signal Transmission](#) section.

There are two restrictions on the analog input signals (INP and INN). First, if the input voltages V_{INP} or V_{INN} exceed the range specified in the [Absolute Maximum Ratings](#) table, the input currents must be limited to the absolute maximum value, because the electrostatic discharge (ESD) protection turns on. In addition, the linearity and parametric performance of the device are ensured only when the analog input voltage remains within the linear full-scale range (V_{FSR}) and within the common-mode input voltage range (V_{CM}), as specified in the [Recommended Operating Conditions](#) table.

7.3.2 Isolation Channel Signal Transmission

The AMC1301-Q1 uses an on-off keying (OOK) modulation scheme, as shown in [Figure 7-1](#), to transmit the modulator output bitstream across the SiO₂-based isolation barrier. The transmit driver (TX) shown in the [Functional Block Diagram](#) transmits an internally generated, high-frequency carrier across the isolation barrier to represent a digital *one* and does not send a signal to represent a digital *zero*. The nominal frequency of the carrier used inside the AMC1301-Q1 is 480 MHz.

The receiver (RX) on the other side of the isolation barrier recovers and demodulates the signal and provides the input to the fourth-order analog filter. The AMC1301-Q1 transmission channel is optimized to achieve the highest level of common-mode transient immunity (CMTI) and lowest level of radiated emissions caused by the high-frequency carrier and RX/TX buffer switching.

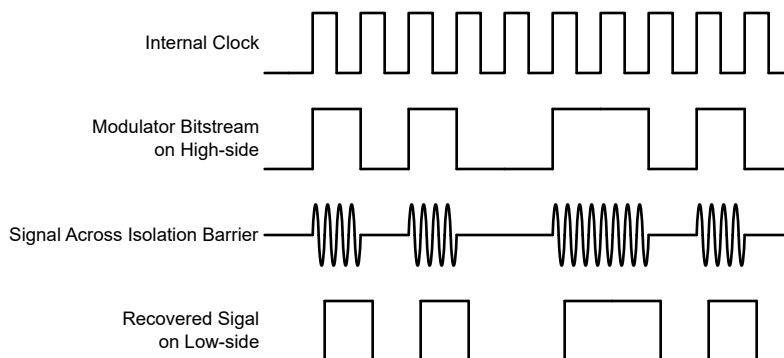

Figure 7-1. OOK-Based Modulation Scheme

7.3.3 Analog Output

The AMC1301-Q1 offers a differential analog output comprised of the OUTP and OUTN pins. For differential input voltages ($V_{INP} - V_{INN}$) in the range from -250 mV to 250 mV , the device provides a linear response with a nominal gain of 8.2. For example, for a differential input voltage of 250 mV , the differential output voltage ($V_{OUTP} - V_{OUTN}$) is 2.05 V . At zero input (INP shorted to INN), both pins output the same common-mode output voltage V_{CMOut} , as specified in the [Electrical Characteristics](#) table. For absolute differential input voltages greater than 250 mV but less than 320 mV , the differential output voltage continues to increase in magnitude but with reduced linearity performance. The outputs saturate at a differential output voltage of $V_{CLIPOut}$, as shown in [Figure 7-2](#), if the differential input voltage exceeds the $V_{Clipping}$ value.

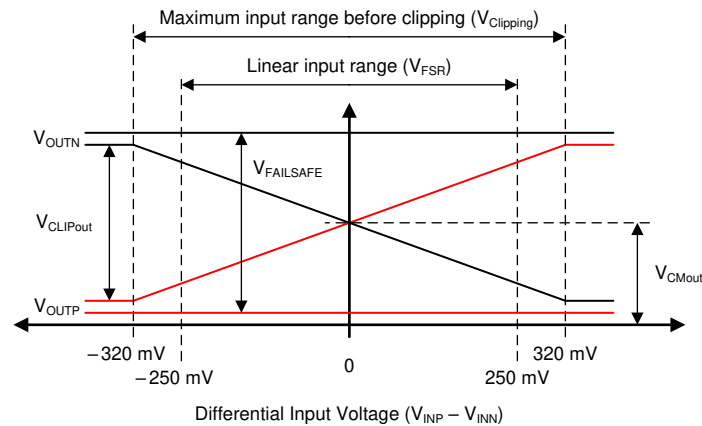

Figure 7-2. Output Behavior of the AMC1301-Q1

The AMC1301-Q1 offers a fail-safe feature that simplifies diagnostics on a system level. [Figure 7-2](#) shows the fail-safe mode, in which the AMC1301-Q1 outputs a negative differential output voltage that does not occur under normal operating conditions. The fail-safe output is active in two cases:

- When the high-side supply is missing or below the V_{DD1UV} threshold
- When the common-mode input voltage, that is $V_{CM} = (V_{INP} + V_{INN}) / 2$, exceeds the common-mode overvoltage detection level V_{CMov}

Use the maximum $V_{FAILSAFE}$ voltage specified in the [Electrical Characteristics](#) table as a reference value for fail-safe detection on a system level.

7.4 Device Functional Modes

The AMC1301-Q1 assumes normal operation as soon as V_{DD1} , V_{DD2} , and the input common-mode voltage (V_{CM}) are within the operational ranges, as specified in [Electrical Characteristics](#) table. In this mode, the output voltage is proportional to the input voltage.

The AMC1301-Q1 enters fail-safe mode whenever the high-side supply (V_{DD1}) is missing or the input common-mode voltage (V_{CM}) exceeds the specified input-overvoltage detection level V_{CMov} . In this mode, the differential output voltage is a fixed, negative value ($V_{FAILSAFE}$). See the [Analog Output](#) section for details.

8 Application and Implementation

Note

Information in the following applications sections is not part of the TI component specification, and TI does not warrant its accuracy or completeness. TI's customers are responsible for determining suitability of components for their purposes, as well as validating and testing their design implementation to confirm system functionality.

8.1 Application Information

With a low analog input voltage range, high DC accuracy, and low temperature drift, the AMC1301-Q1 is designed for precision, shunt-based current sensing in applications requiring high voltage isolation.

8.2 Typical Application

Figure 8-1 shows the AMC1301-Q1 in a typical application of a motor drive for an AC compressor. The load current flowing through an external shunt resistor RSHUNT produces a voltage drop that is sensed by the AMC1301-Q1. The AMC1301-Q1 digitizes the analog input signal on the high-side, transfers the data across the isolation barrier to the low-side, reconstructs the analog signal, and presents that signal as a differential voltage on the output pins.

The differential input, differential output, and the high common-mode transient immunity (CMTI) of the AMC1301-Q1 provide reliable and accurate operation even in high-noise environments.

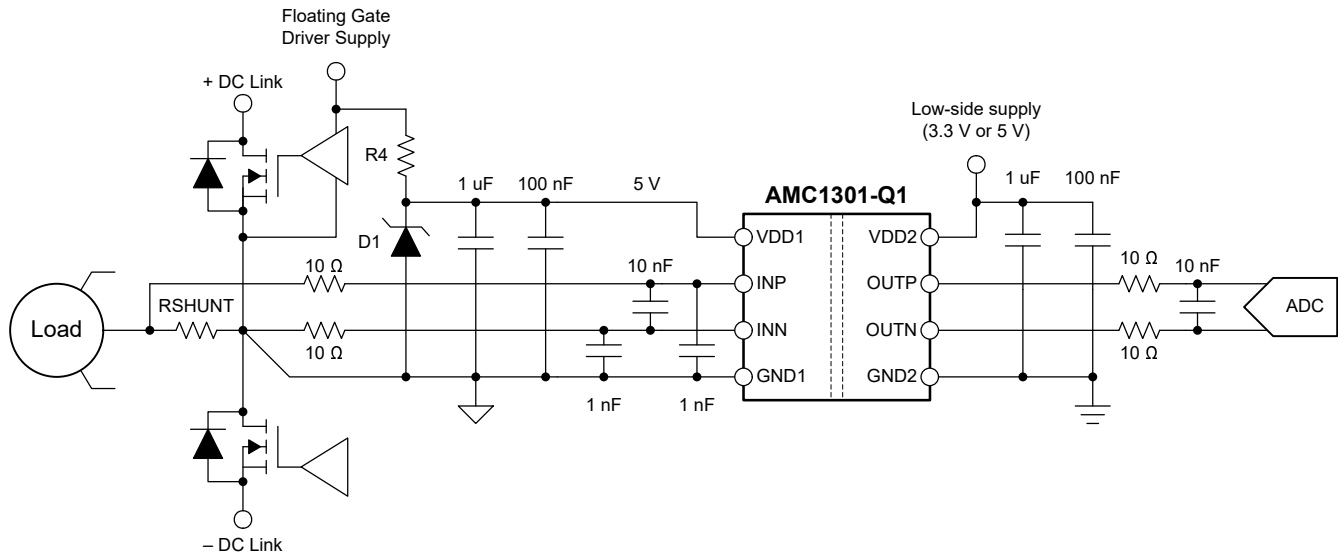

Figure 8-1. Using the AMC1301-Q1 for Current Sensing in a Typical Application

8.2.1 Design Requirements

Table 8-1 lists the parameters for this typical application.

Table 8-1. Design Requirements

PARAMETER	VALUE
High-side supply voltage	3.3 V or 5 V
Low-side supply voltage	3.3 V or 5 V
Voltage drop across RSHUNT for a linear response	±250 mV (maximum)
Signal delay (50% V_{IN} to 90% $OUTP$, $OUTN$)	3 μ s (maximum)

8.2.2 Detailed Design Procedure

In Figure 8-1, the high-side power supply (VDD1) for the AMC1301-Q1 is derived from the floating power supply of the upper gate driver.

The floating ground reference (GND1) is derived from the end of the shunt resistor that is connected to the negative input of the AMC1301-Q1 (INN). If a four-pin shunt is used, the inputs of the AMC1301-Q1 are connected to the inner leads and GND1 is connected to the outer lead on the INN-side of the shunt. To minimize offset and improve accuracy, route the ground connection as a separate trace that connects directly to the shunt resistor rather than shorting GND1 to INN directly at the input to the device. See the [Layout](#) section for more details.

8.2.2.1 Shunt Resistor Sizing

Use Ohm's Law to calculate the voltage drop across the shunt resistor (V_{SHUNT}) for the desired measured current: $V_{SHUNT} = I \times R_{SHUNT}$.

Consider the following two restrictions when selecting the value of the shunt resistor, R_{SHUNT} :

- The voltage drop caused by the nominal current range must not exceed the recommended differential input voltage range for a linear response: $|V_{SHUNT}| \leq |V_{FSR}|$
- The voltage drop caused by the maximum allowed overcurrent must not exceed the input voltage that causes a clipping output: $|V_{SHUNT}| \leq |V_{Clipping}|$

8.2.2.2 Input Filter Design

Place a differential RC filter (R1, R2, C5) in front of the isolated amplifier to improve signal-to-noise performance of the signal path. Design the input filter such that:

- The cutoff frequency of the filter is at least one order of magnitude lower than the sampling frequency of the $\Delta\Sigma$ modulator (20 MHz)
- The input bias current does not generate significant voltage drop across the DC impedances (R1, R2) of the input filter
- The impedances measured from the analog inputs are equal (R1 equals R2)

Capacitors C6 and C7 are optional and improve common-mode rejection at high frequencies (>1 MHz). For best performance, C6 must match the value of C7 and both capacitors must be 10 to 20 times lower in value than C5. For most applications, the structure shown in Figure 8-2 achieves excellent performance.

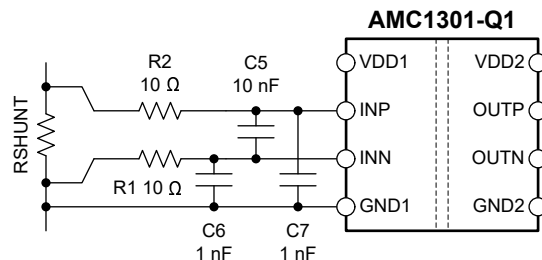

Figure 8-2. Differential Input Filter

8.2.2.3 Differential to Single-Ended Output Conversion

Figure 8-3 shows an example of a TLV900x-Q1-based signal conversion and filter circuit for systems using single-ended input ADCs to convert the analog output voltage into digital. For $R1 = R3$ and $R2 = R4$, the output voltage equals $(R2 / R1) \times (V_{OUTP} - V_{OUTN}) + V_{REF}$. Tailor the bandwidth of this filter stage to the bandwidth requirement of the system and use NP0-type capacitors for best performance. For most applications, $R1 = R2 = R3 = R4 = 3.3 \text{ k}\Omega$ and $C1 = C2 = 330 \text{ pF}$ yields good performance.

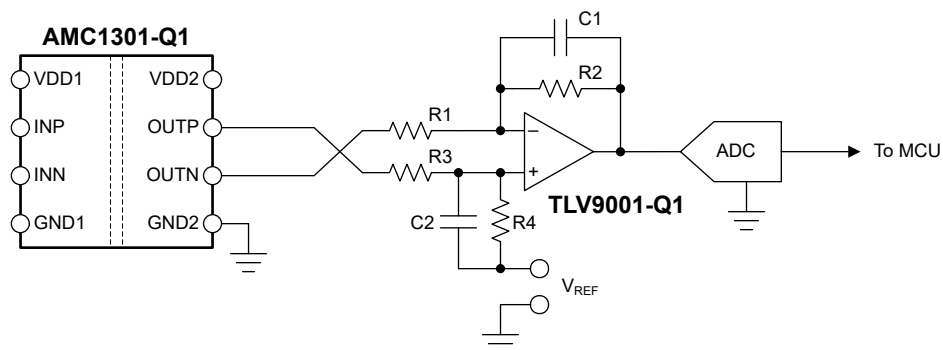

Figure 8-3. Connecting the AMC1301-Q1 Output to a Single-Ended Input ADC

For more information on the general procedure to design the filtering and driving stages of SAR ADCs, see the [18-Bit, 1MSPS Data Acquisition Block \(DAQ\) Optimized for Lowest Distortion and Noise](#) and [18-Bit Data Acquisition Block \(DAQ\) Optimized for Lowest Power reference guides](#), available for download at www.ti.com.

8.2.3 Application Curve

One important aspect of power-stage design is the effective detection of an overcurrent condition to protect the switching devices and passive components from damage. To power off the system quickly in the event of an overcurrent condition, a low delay caused by the isolated amplifier is required. Figure 8-4 shows the typical full-scale step response of the AMC1301-Q1.



Figure 8-4. Step Response of the AMC1301-Q1

8.3 Best Design Practices

Do not leave the inputs of the AMC1301-Q1 unconnected (floating) when the device is powered up. If the device inputs are left floating, the input bias current can possibly drive the inputs to a positive value that exceeds the operating common-mode input voltage, thus causing the device to output the fail-safe voltage as described in the [Analog Output](#) section.

Connect the high-side ground (GND1) to INN, either by a hard short or through a resistive path. A DC current path between INN and GND1 is required to define the input common-mode voltage. Take care not to exceed the input common-mode range as specified in the [Recommended Operating Conditions](#) table. For best accuracy, route the ground connection as a separate trace that connects directly to the shunt resistor rather than shorting GND1 to INN directly at the input to the device. See the [Layout](#) section for more details.

8.4 Power Supply Recommendations

The AMC1301-Q1 does not require any specific power-up sequencing. The high-side power supply (AVDD) is decoupled with a low-ESR, 100-nF capacitor (C1) parallel to a low-ESR, 1- μ F capacitor (C2). The low-side power supply (DVDD) is equally decoupled with a low-ESR, 100-nF capacitor (C3) parallel to a low-ESR, 1- μ F capacitor (C4). Place all four capacitors (C1, C2, C3, and C4) as close to the device as possible.

The ground reference for the high-side (AGND) is derived from the end of the shunt resistor that is connected to the negative input (INN) of the device. For best DC accuracy, use a separate trace to make this connection instead of shorting AGND to INN directly at the device input. If a four-terminal shunt is used, the device inputs are connected to the inner leads and AGND is connected to the outer lead on the INN side of the shunt. [Figure 8-5](#) shows a decoupling diagram of the AMC1301-Q1.

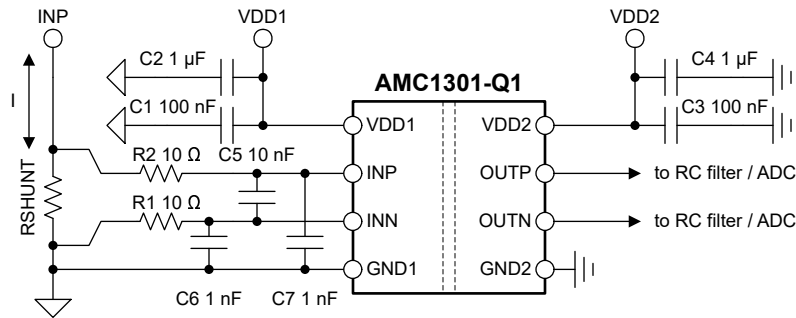

Figure 8-5. Decoupling of the AMC1301-Q1

8.5 Layout

8.5.1 Layout Guidelines

Figure 8-6 shows a layout recommendation with the critical placement of the decoupling capacitors (as close as possible to the AMC1301-Q1 supply pins) and placement of the other components required by the device. For best performance, place the shunt resistor close to the INP and INN inputs of the AMC1301-Q1 and keep the layout of both connections symmetrical.

8.5.2 Layout Example

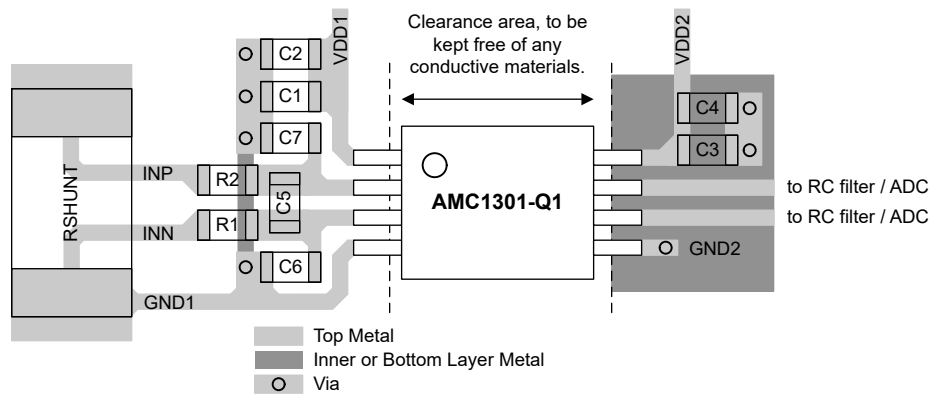

Figure 8-6. Recommended Layout of the AMC1301-Q1

9 Device and Documentation Support

9.1 Documentation Support

9.1.1 Related Documentation

For related documentation, see the following:

- Texas Instruments, [Isolation Glossary application note](#)
- Texas Instruments, [Semiconductor and IC Package Thermal Metrics application note](#)
- Texas Instruments, [ISO72x Digital Isolator Magnetic-Field Immunity application note](#)
- Texas Instruments, [TLV900x-Q1 Low-Power RRIO 1-MHz Automotive Operational Amplifier data sheet](#)
- Texas Instruments, [18-Bit, 1-MSPS Data Acquisition Block \(DAQ\) Optimized for Lowest Distortion and Noise reference guide](#)
- Texas Instruments, [18-Bit, 1-MSPS Data Acquisition Block \(DAQ\) Optimized for Lowest Power reference guide](#)
- Texas Instruments, [Isolated Amplifier Voltage Sensing Excel Calculator design tool](#)
- Texas Instruments, [Best in Class Radiated Emissions EMI Performance with the AMC1300B-Q1 Isolated Amplifier technical white paper](#)
- Texas Instruments, [Isolated Voltage-Measurement Circuit With \$\pm 250\$ -mV Input and Differential Output application note](#)

9.2 Receiving Notification of Documentation Updates

To receive notification of documentation updates, navigate to the device product folder on [ti.com](#). Click on *Subscribe to updates* to register and receive a weekly digest of any product information that has changed. For change details, review the revision history included in any revised document.

9.3 Support Resources

[TI E2E™ support forums](#) are an engineer's go-to source for fast, verified answers and design help — straight from the experts. Search existing answers or ask your own question to get the quick design help you need.

Linked content is provided "AS IS" by the respective contributors. They do not constitute TI specifications and do not necessarily reflect TI's views; see TI's [Terms of Use](#).

9.4 Trademarks

TI E2E™ is a trademark of Texas Instruments.
All trademarks are the property of their respective owners.

9.5 Electrostatic Discharge Caution



This integrated circuit can be damaged by ESD. Texas Instruments recommends that all integrated circuits be handled with appropriate precautions. Failure to observe proper handling and installation procedures can cause damage.

ESD damage can range from subtle performance degradation to complete device failure. Precision integrated circuits may be more susceptible to damage because very small parametric changes could cause the device not to meet its published specifications.

9.6 Glossary

[TI Glossary](#) This glossary lists and explains terms, acronyms, and definitions.

10 Mechanical, Packaging, and Orderable Information

The following pages include mechanical, packaging, and orderable information. This information is the most current data available for the designated devices. This data is subject to change without notice and revision of this document. For browser-based versions of this data sheet, refer to the left-hand navigation.

PACKAGING INFORMATION

Orderable Device	Status (1)	Package Type	Package Drawing	Pins	Package Qty	Eco Plan (2)	Lead finish/ Ball material (6)	MSL Peak Temp (3)	Op Temp (°C)	Device Marking (4/5)	Samples
AMC1301QDWVQ1	ACTIVE	SOIC	DWV	8	64	RoHS & Green	NIPDAU	Level-3-260C-168 HR	-40 to 125	1301Q1	Samples
AMC1301QDWVRQ1	ACTIVE	SOIC	DWV	8	1000	RoHS & Green	NIPDAU	Level-3-260C-168 HR	-40 to 125	1301Q1	Samples

(1) The marketing status values are defined as follows:

ACTIVE: Product device recommended for new designs.

LIFEBUY: TI has announced that the device will be discontinued, and a lifetime-buy period is in effect.

NRND: Not recommended for new designs. Device is in production to support existing customers, but TI does not recommend using this part in a new design.

PREVIEW: Device has been announced but is not in production. Samples may or may not be available.

OBSOLETE: TI has discontinued the production of the device.

(2) **RoHS:** TI defines "RoHS" to mean semiconductor products that are compliant with the current EU RoHS requirements for all 10 RoHS substances, including the requirement that RoHS substance do not exceed 0.1% by weight in homogeneous materials. Where designed to be soldered at high temperatures, "RoHS" products are suitable for use in specified lead-free processes. TI may reference these types of products as "Pb-Free".

RoHS Exempt: TI defines "RoHS Exempt" to mean products that contain lead but are compliant with EU RoHS pursuant to a specific EU RoHS exemption.

Green: TI defines "Green" to mean the content of Chlorine (Cl) and Bromine (Br) based flame retardants meet JS709B low halogen requirements of <=1000ppm threshold. Antimony trioxide based flame retardants must also meet the <=1000ppm threshold requirement.

(3) MSL, Peak Temp. - The Moisture Sensitivity Level rating according to the JEDEC industry standard classifications, and peak solder temperature.

(4) There may be additional marking, which relates to the logo, the lot trace code information, or the environmental category on the device.

(5) Multiple Device Markings will be inside parentheses. Only one Device Marking contained in parentheses and separated by a "~" will appear on a device. If a line is indented then it is a continuation of the previous line and the two combined represent the entire Device Marking for that device.

(6) Lead finish/Ball material - Orderable Devices may have multiple material finish options. Finish options are separated by a vertical ruled line. Lead finish/Ball material values may wrap to two lines if the finish value exceeds the maximum column width.

Important Information and Disclaimer:The information provided on this page represents TI's knowledge and belief as of the date that it is provided. TI bases its knowledge and belief on information provided by third parties, and makes no representation or warranty as to the accuracy of such information. Efforts are underway to better integrate information from third parties. TI has taken and continues to take reasonable steps to provide representative and accurate information but may not have conducted destructive testing or chemical analysis on incoming materials and chemicals. TI and TI suppliers consider certain information to be proprietary, and thus CAS numbers and other limited information may not be available for release.

In no event shall TI's liability arising out of such information exceed the total purchase price of the TI part(s) at issue in this document sold by TI to Customer on an annual basis.

OTHER QUALIFIED VERSIONS OF AMC1301-Q1 :

- Catalog : [AMC1301](#)

NOTE: Qualified Version Definitions:

- Catalog - TI's standard catalog product

TAPE AND REEL INFORMATION

QUADRANT ASSIGNMENTS FOR PIN 1 ORIENTATION IN TAPE

*All dimensions are nominal

Device	Package Type	Package Drawing	Pins	SPQ	Reel Diameter (mm)	Reel Width W1 (mm)	A0 (mm)	B0 (mm)	K0 (mm)	P1 (mm)	W (mm)	Pin1 Quadrant
AMC1301QDWVRQ1	SOIC	DWV	8	1000	330.0	16.4	12.15	6.2	3.05	16.0	16.0	Q1
AMC1301QDWVRQ1	SOIC	DWV	8	1000	330.0	16.4	12.05	6.15	3.3	16.0	16.0	Q1

TAPE AND REEL BOX DIMENSIONS

*All dimensions are nominal

Device	Package Type	Package Drawing	Pins	SPQ	Length (mm)	Width (mm)	Height (mm)
AMC1301QDWVRQ1	SOIC	DWV	8	1000	356.0	356.0	35.0
AMC1301QDWVRQ1	SOIC	DWV	8	1000	350.0	350.0	43.0

TUBE

*All dimensions are nominal

Device	Package Name	Package Type	Pins	SPQ	L (mm)	W (mm)	T (μm)	B (mm)
AMC1301QDWVQ1	DWV	SOIC	8	64	505.46	13.94	4826	6.6

PACKAGE OUTLINE

DWV0008A



SOIC - 2.8 mm max height

SOIC

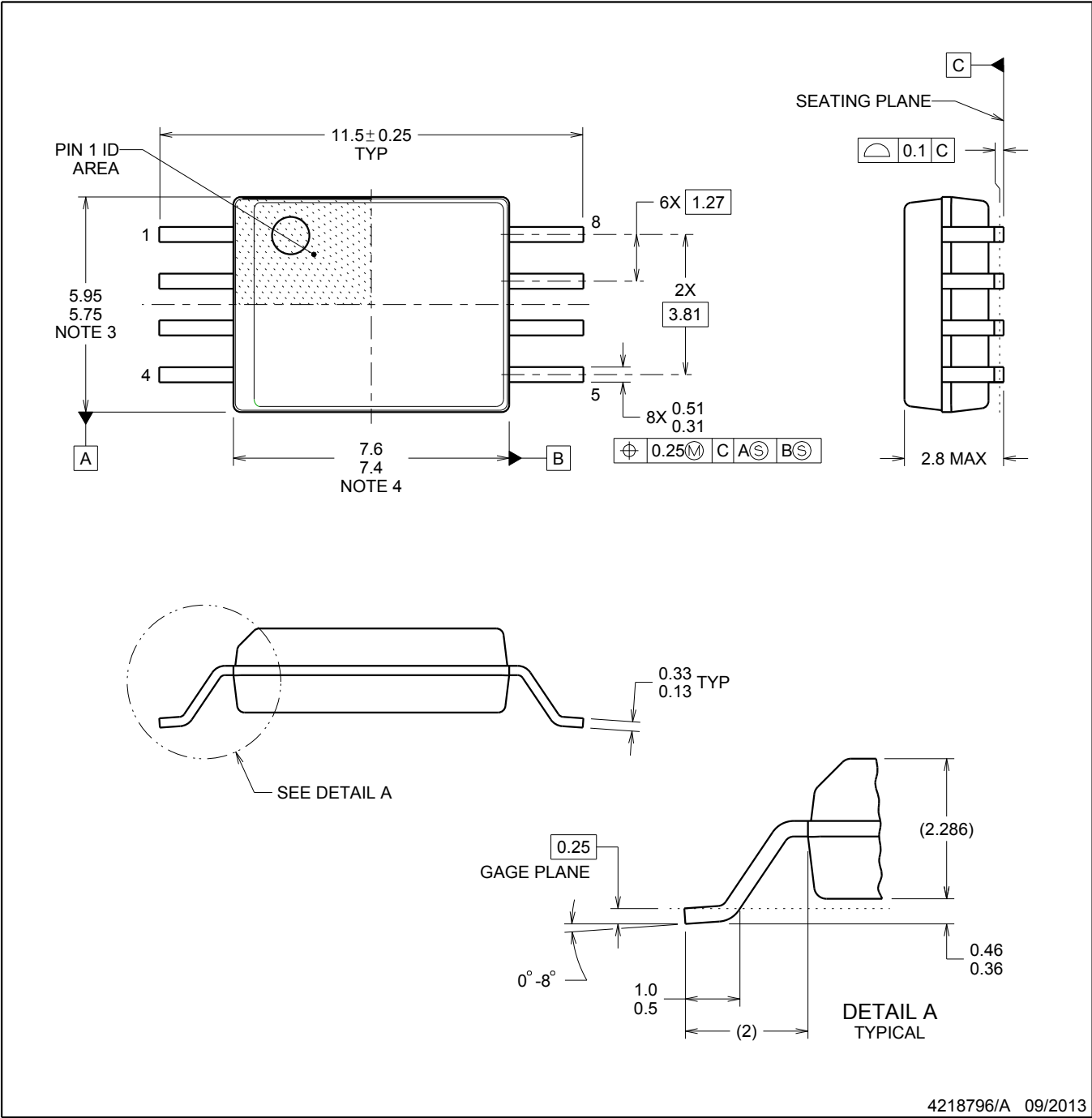

4218796/A 09/2013

NOTES:

1. All linear dimensions are in millimeters. Dimensions in parenthesis are for reference only. Dimensioning and tolerancing per ASME Y14.5M.
2. This drawing is subject to change without notice.
3. This dimension does not include mold flash, protrusions, or gate burrs. Mold flash, protrusions, or gate burrs shall not exceed 0.15 mm, per side.
4. This dimension does not include interlead flash. Interlead flash shall not exceed 0.25 mm, per side.

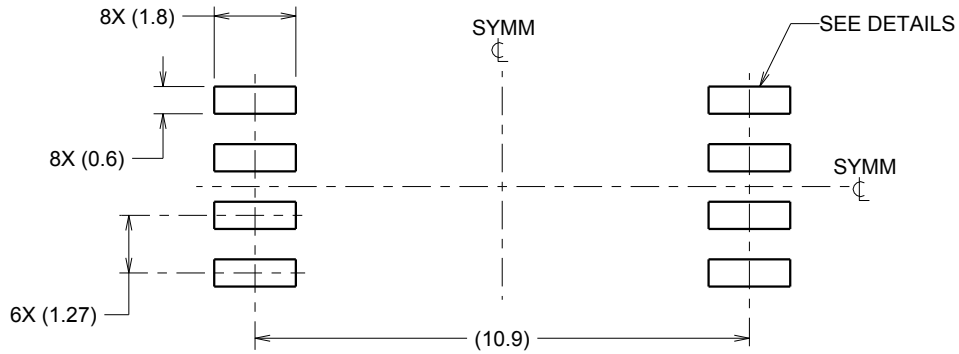

LAND PATTERN EXAMPLE
9.1 mm NOMINAL CLEARANCE/CREEPAGE
SCALE:6X

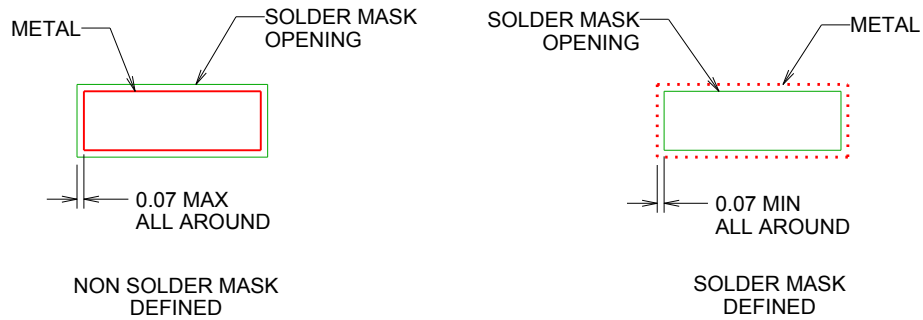

SOLDER MASK DETAILS

4218796/A 09/2013

NOTES: (continued)

- 5. Publication IPC-7351 may have alternate designs.
- 6. Solder mask tolerances between and around signal pads can vary based on board fabrication site.

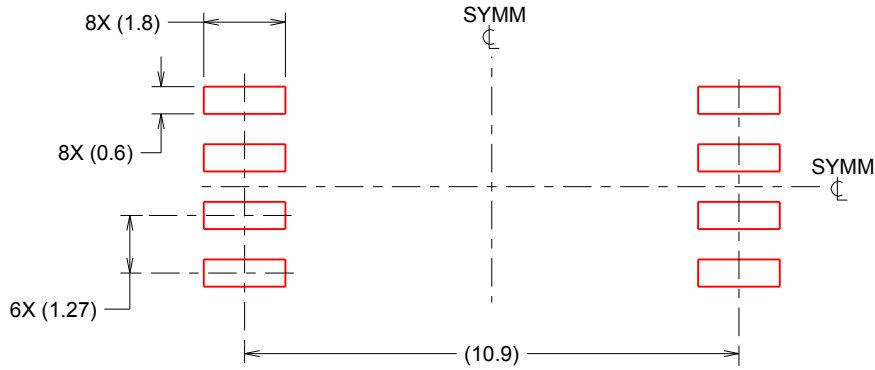

SOLDER PASTE EXAMPLE
 BASED ON 0.125 mm THICK STENCIL
 SCALE:6X

4218796/A 09/2013

NOTES: (continued)

- 7. Laser cutting apertures with trapezoidal walls and rounded corners may offer better paste release. IPC-7525 may have alternate design recommendations.
- 8. Board assembly site may have different recommendations for stencil design.

IMPORTANT NOTICE AND DISCLAIMER

TI PROVIDES TECHNICAL AND RELIABILITY DATA (INCLUDING DATA SHEETS), DESIGN RESOURCES (INCLUDING REFERENCE DESIGNS), APPLICATION OR OTHER DESIGN ADVICE, WEB TOOLS, SAFETY INFORMATION, AND OTHER RESOURCES "AS IS" AND WITH ALL FAULTS, AND DISCLAIMS ALL WARRANTIES, EXPRESS AND IMPLIED, INCLUDING WITHOUT LIMITATION ANY IMPLIED WARRANTIES OF MERCHANTABILITY, FITNESS FOR A PARTICULAR PURPOSE OR NON-INFRINGEMENT OF THIRD PARTY INTELLECTUAL PROPERTY RIGHTS.

These resources are intended for skilled developers designing with TI products. You are solely responsible for (1) selecting the appropriate TI products for your application, (2) designing, validating and testing your application, and (3) ensuring your application meets applicable standards, and any other safety, security, regulatory or other requirements.

These resources are subject to change without notice. TI grants you permission to use these resources only for development of an application that uses the TI products described in the resource. Other reproduction and display of these resources is prohibited. No license is granted to any other TI intellectual property right or to any third party intellectual property right. TI disclaims responsibility for, and you will fully indemnify TI and its representatives against, any claims, damages, costs, losses, and liabilities arising out of your use of these resources.

TI's products are provided subject to [TI's Terms of Sale](#) or other applicable terms available either on [ti.com](https://www.ti.com) or provided in conjunction with such TI products. TI's provision of these resources does not expand or otherwise alter TI's applicable warranties or warranty disclaimers for TI products.

TI objects to and rejects any additional or different terms you may have proposed.

Mailing Address: Texas Instruments, Post Office Box 655303, Dallas, Texas 75265
Copyright © 2024, Texas Instruments Incorporated