

# CD4041UB Types

## CMOS Quad True/Complement Buffer

### High Voltage Types (20-Volt Rating)

■ CD4041UB types are quad true/complement buffers consisting of n- and p-channel units having low channel resistance and high current (sourcing and sinking) capability. The CD4041UB is intended for use as a buffer, line driver, or CMOS-to-TTL driver. It can be used as an ultra-low power resistor-network driver for A/D and D/A conversion, as a transmission-line driver, and in other applications where high noise immunity and low power dissipation are primary design requirements.

The CD4041UB types are supplied in 14-lead hermetic dual-in-line ceramic packages (F3A suffix), 14-lead dual-in-line plastic packages (E suffix), 14-lead small-outline packages (M, MT, M96, and NSR suffixes), and 14-lead thin shrink small-outline packages (PW and PWR suffixes).

#### MAXIMUM RATINGS, Absolute-Maximum Values:

DC SUPPLY-VOLTAGE RANGE, ( $V_{DD}$ )		
Voltages referenced to $V_{SS}$ Terminal)		-0.5V to +20V
INPUT VOLTAGE RANGE, ALL INPUTS		-0.5V to $V_{DD} + 0.5V$
DC INPUT CURRENT, ANY ONE INPUT		$\pm 10mA$
POWER DISSIPATION PER PACKAGE ( $P_D$ ):		
For $T_A = -55^\circ C$ to $+100^\circ C$		500mW
For $T_A = +100^\circ C$ to $+125^\circ C$		Derate Linearly at 12mW/ $^\circ C$ to 200mW
DEVICE DISSIPATION PER OUTPUT TRANSISTOR		
FOR $T_A =$ FULL PACKAGE-TEMPERATURE RANGE (All Package Types)		100mW
OPERATING-TEMPERATURE RANGE ( $T_A$ )		$-55^\circ C$ to $+125^\circ C$
STORAGE TEMPERATURE RANGE ( $T_{stg}$ )		$-65^\circ C$ to $+150^\circ C$
LEAD TEMPERATURE (DURING SOLDERING):		
At distance $1/16 \pm 1/32$ inch ( $1.59 \pm 0.79mm$ ) from case for 10s max		$+265^\circ C$

#### RECOMMENDED OPERATING CONDITIONS

For maximum reliability, nominal operating conditions should be selected so that operation is always within the following range:

CHARACTERISTIC	LIMITS		UNITS
	Min.	Max.	
Supply-Voltage Range (For $T_A =$ Full Package-Temperature Range)	3	18	V

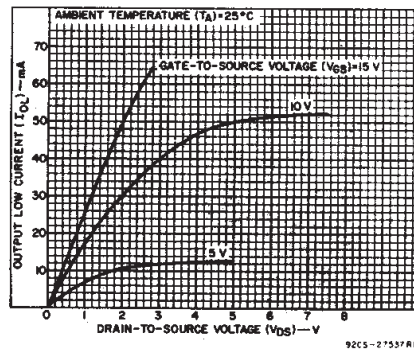

Fig.2 – Typical output low (sink) current characteristics.

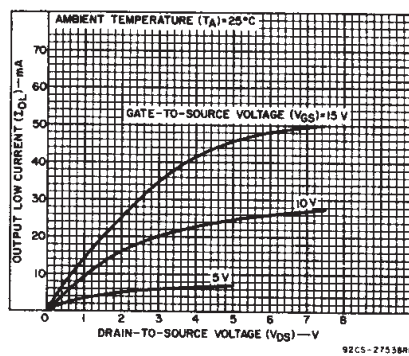

Fig.3 – Minimum low (sink) current characteristics.

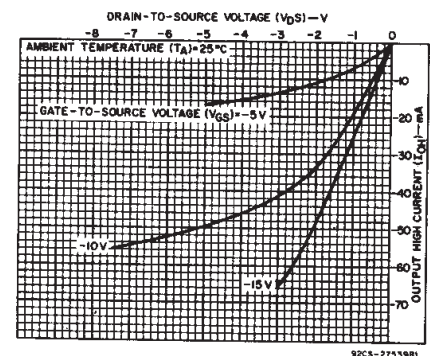

Fig.4 – Typical output high (source) current characteristics.

#### Features:

- Balanced sink and source current; approximately 4 times standard "B" drive
- Equalized delay to true and complement outputs
- 100% tested for quiescent current at 20 V
- Maximum input current of 1  $\mu A$  at 18 V over full package temperature range; 100 nA at 18 V and 25 $^\circ C$
- 5-V, 10-V, and 15-V parametric ratings
- Meets all requirements of JEDEC Tentative Standard No. 13B, "Standard Specifications for Description of 'B' Series CMOS Devices"

#### Applications:

- High current source/sink driver
- CMOS-to-DTL/TTL Converter Buffer
- Display driver
- MOS clock driver
- Resistor network driver (Ladder or weighted R)
- Buffer
- Transmission line driver

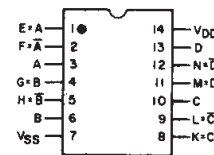
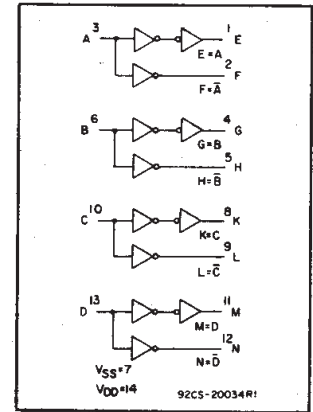

92CS-20755R1

#### TOP VIEW TERMINAL ASSIGNMENT

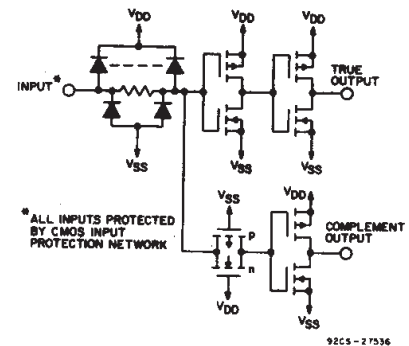

Fig.1 – Schematic diagram 1 of 4 buffers.

3  
COMMERCIAL CMOS  
HIGH VOLTAGE ICs

# CD4041UB Types

## STATIC ELECTRICAL CHARACTERISTICS

CHARACTERISTIC	CONDITIONS			LIMITS AT INDICATED TEMPERATURES (°C)							UNITS
	V <sub>O</sub> (V)	V <sub>IN</sub> (V)	V <sub>DD</sub> (V)	-55	-40	+85	+125	+25			
								Min.	Typ.	Max.	
Quiescent Device Current I <sub>DD</sub> Max.	—	0.5	5	1	1	30	30	—	0.02	1	μA
	—	0.10	10	2	2	60	60	—	0.02	2	
	—	0.15	15	4	4	120	120	—	0.02	4	
	—	0.20	20	20	20	600	600	—	0.04	20	
Output Low (Sink) Current, I <sub>OL</sub> Min.	0.4	0.5	5	2.1	1.8	1.3	1.2	1.6	3.2	—	mA
	0.5	0.10	10	6.25	5.6	4	3.5	5	10	—	
	1.5	0.15	15	24	23	15.5	13	19	38	—	
	4.6	0.5	5	-2.1	-1.8	-1.3	-1.2	-1.6	-3.2	—	
Output High (Source) Current, I <sub>OH</sub> Min.	2.5	0.5	5	-8.4	-6.7	-5.3	-4.6	-6.4	-12.8	—	mA
	9.5	0.10	10	-6.25	-5.6	-4	-3.5	-5	-10	—	
	13.5	0.15	15	-24	-23	-15.5	-13	-19	-38	—	
Output Voltage: Low-Level, V <sub>OL</sub> Max.	—	0.5	5	0.05				—	0	0.05	V
	—	0.10	10	0.05				—	0	0.05	
	—	0.15	15	0.05				—	0	0.05	
Output Voltage: High-Level, V <sub>OH</sub> Min.	—	0.5	5	4.95				4.95	5	—	V
	—	0.10	10	9.95				9.95	10	—	
	—	0.15	15	14.95				14.95	15	—	
Input Low Voltage, V <sub>IL</sub> Max.	0.5, 4.5	—	5	1				—	—	1	V
	1.9	—	10	2				—	—	2	
	1.5, 13.5	—	15	2.5				—	—	2.5	
Input High Voltage, V <sub>IH</sub> Min.	0.5, 4.5	—	5	4				4	—	—	V
	1.9	—	10	8				8	—	—	
	1.5, 13.5	—	15	12.5				12.5	—	—	
Input Current, I <sub>IN</sub> Max.	—	0.18	18	±0.1	±0.1	±1	±1	—	±10 <sup>-5</sup>	±0.1	μA

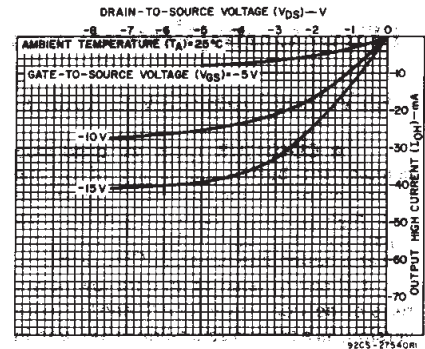

Fig. 5 - Minimum output high (source) current characteristics.

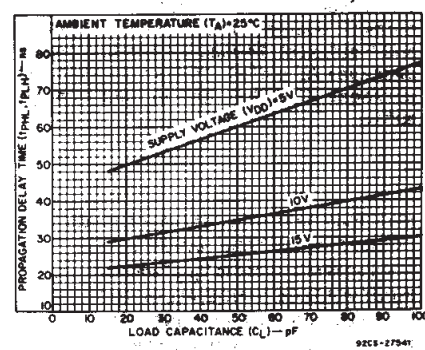

Fig. 6 - Typical propagation delay time vs. load capacitance.

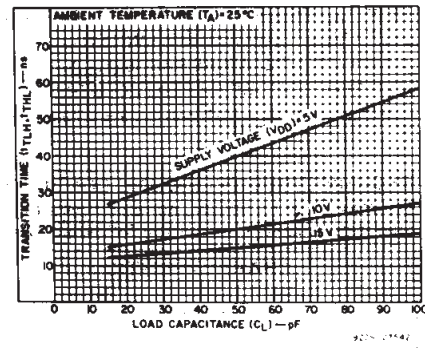

Fig. 7 - Typical transition time vs. load capacitance.

DYNAMIC ELECTRICAL CHARACTERISTICS at T<sub>A</sub> = 25°C, Input t<sub>r</sub>, t<sub>f</sub> = 20 ns, C<sub>L</sub> = 50 pF, R<sub>L</sub> = 200 kΩ

CHARACTERISTIC	CONDITIONS	LIMITS		UNITS
		V <sub>DD</sub> Volts	Typ. Max.	
Propagation Delay Time: t <sub>PHL</sub> t <sub>PLH</sub>	Any Input	5	60 120	ns
		10	35 70	
		15	25 50	
Transition Time t <sub>THL</sub> t <sub>TLH</sub>	Any Input	5	40 80	ns
		10	20 40	
		15	15 30	
Input Capacitance	C <sub>IN</sub>	Any Input	15 22.5	pF

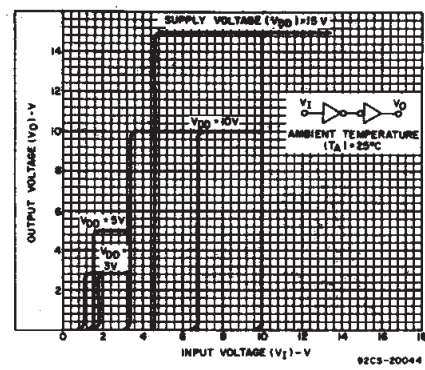

Fig. 8 - Minimum and maximum transfer characteristics - true output.

# CD4041UB Types

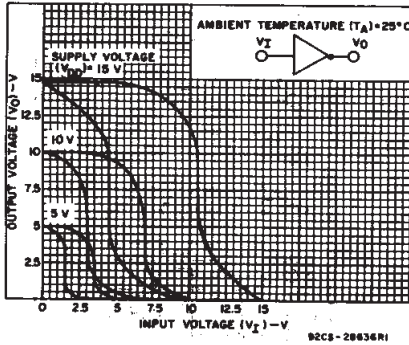

Fig. 9 - Minimum and maximum transfer characteristics - complement output.

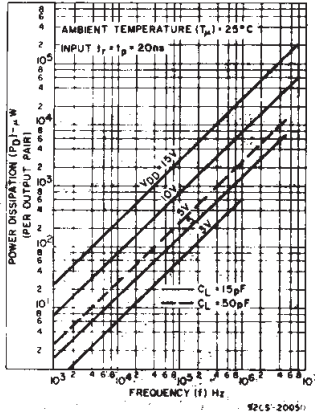

Fig. 11 - Typical power dissipation vs frequency per output pair.

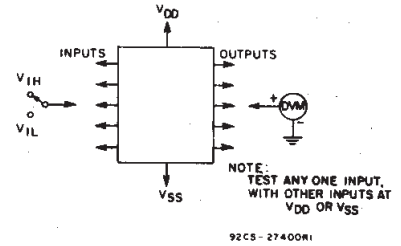

Fig. 13 - Input voltage test circuit.

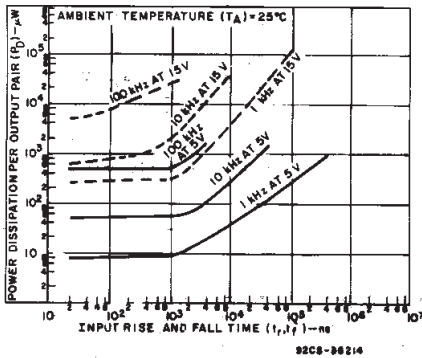

Fig. 10 - Typical power dissipation vs. input rise & fall time per output pair.

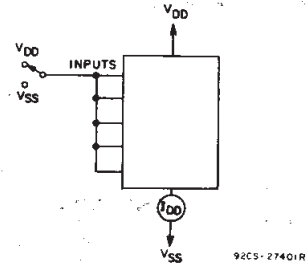

Fig. 12 - Quiescent device current test circuit.

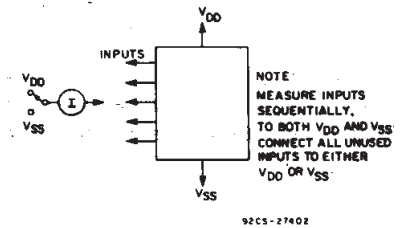
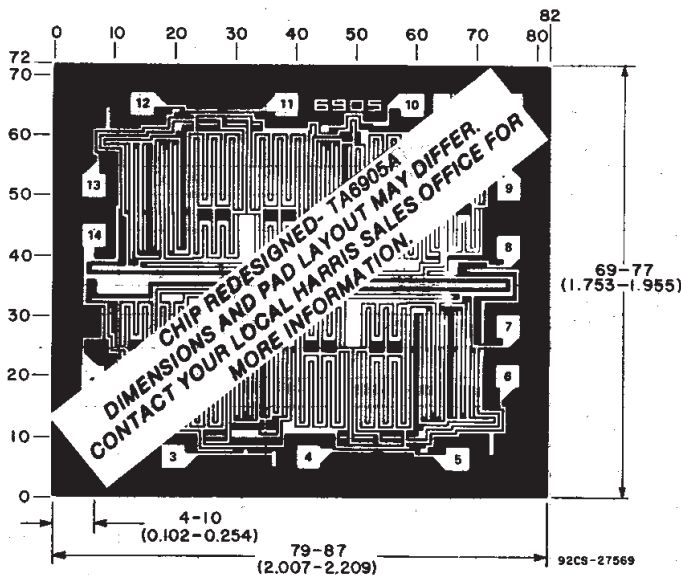

Fig. 14 - Input-leakage-current test circuit.

## Dimensions and pad layout for the CD4041UBH



Dimensions in parentheses are in millimeters and are derived from the basic inch dimensions as indicated. Grid graduations are in mils ( $10^{-3}$  inch).

3  
COMMERCIAL CMOS  
HIGH VOLTAGE ICs

## PACKAGING INFORMATION

Orderable Device	Status (1)	Package Type	Package Drawing	Pins	Package Qty	Eco Plan (2)	Lead finish/ Ball material (6)	MSL Peak Temp (3)	Op Temp (°C)	Device Marking (4/5)	Samples
CD4041UBE	ACTIVE	PDIP	N	14	25	RoHS & Green	NIPDAU	N / A for Pkg Type	-55 to 125	CD4041UBE	<a href="#">Samples</a>
CD4041UBF	ACTIVE	CDIP	J	14	25	Non-RoHS & Green	SNPB	N / A for Pkg Type	-55 to 125	CD4041UBF	<a href="#">Samples</a>
CD4041UBF3A	ACTIVE	CDIP	J	14	25	Non-RoHS & Green	SNPB	N / A for Pkg Type	-55 to 125	CD4041UBF3A	<a href="#">Samples</a>
CD4041UBM	OBSOLETE	SOIC	D	14		TBD	Call TI	Call TI	-55 to 125	CD4041UBM	
CD4041UBM96	ACTIVE	SOIC	D	14	2500	RoHS & Green	NIPDAU	Level-1-260C-UNLIM	-55 to 125	CD4041UBM	<a href="#">Samples</a>
CD4041UBMT	OBSOLETE	SOIC	D	14		TBD	Call TI	Call TI	-55 to 125	CD4041UBM	
CD4041UBPW	OBSOLETE	TSSOP	PW	14		TBD	Call TI	Call TI	-55 to 125	CM041UB	
CD4041UBPWR	ACTIVE	TSSOP	PW	14	2000	RoHS & Green	NIPDAU	Level-1-260C-UNLIM	-55 to 125	CM041UB	<a href="#">Samples</a>

(1) The marketing status values are defined as follows:

**ACTIVE:** Product device recommended for new designs.

**LIFEBUY:** TI has announced that the device will be discontinued, and a lifetime-buy period is in effect.

**NRND:** Not recommended for new designs. Device is in production to support existing customers, but TI does not recommend using this part in a new design.

**PREVIEW:** Device has been announced but is not in production. Samples may or may not be available.

**OBSOLETE:** TI has discontinued the production of the device.

(2) **RoHS:** TI defines "RoHS" to mean semiconductor products that are compliant with the current EU RoHS requirements for all 10 RoHS substances, including the requirement that RoHS substance do not exceed 0.1% by weight in homogeneous materials. Where designed to be soldered at high temperatures, "RoHS" products are suitable for use in specified lead-free processes. TI may reference these types of products as "Pb-Free".

**RoHS Exempt:** TI defines "RoHS Exempt" to mean products that contain lead but are compliant with EU RoHS pursuant to a specific EU RoHS exemption.

**Green:** TI defines "Green" to mean the content of Chlorine (Cl) and Bromine (Br) based flame retardants meet JS709B low halogen requirements of <=1000ppm threshold. Antimony trioxide based flame retardants must also meet the <=1000ppm threshold requirement.

(3) MSL, Peak Temp. - The Moisture Sensitivity Level rating according to the JEDEC industry standard classifications, and peak solder temperature.

(4) There may be additional marking, which relates to the logo, the lot trace code information, or the environmental category on the device.

(5) Multiple Device Markings will be inside parentheses. Only one Device Marking contained in parentheses and separated by a "~" will appear on a device. If a line is indented then it is a continuation of the previous line and the two combined represent the entire Device Marking for that device.

(6) Lead finish/Ball material - Orderable Devices may have multiple material finish options. Finish options are separated by a vertical ruled line. Lead finish/Ball material values may wrap to two lines if the finish value exceeds the maximum column width.

**Important Information and Disclaimer:**The information provided on this page represents TI's knowledge and belief as of the date that it is provided. TI bases its knowledge and belief on information provided by third parties, and makes no representation or warranty as to the accuracy of such information. Efforts are underway to better integrate information from third parties. TI has taken and continues to take reasonable steps to provide representative and accurate information but may not have conducted destructive testing or chemical analysis on incoming materials and chemicals. TI and TI suppliers consider certain information to be proprietary, and thus CAS numbers and other limited information may not be available for release.

In no event shall TI's liability arising out of such information exceed the total purchase price of the TI part(s) at issue in this document sold by TI to Customer on an annual basis.

**OTHER QUALIFIED VERSIONS OF CD4041UB, CD4041UB-MIL :**

- Catalog : [CD4041UB](#)
- Military : [CD4041UB-MIL](#)

NOTE: Qualified Version Definitions:

- Catalog - TI's standard catalog product
- Military - QML certified for Military and Defense Applications

**TAPE AND REEL INFORMATION**

**QUADRANT ASSIGNMENTS FOR PIN 1 ORIENTATION IN TAPE**

\*All dimensions are nominal

Device	Package Type	Package Drawing	Pins	SPQ	Reel Diameter (mm)	Reel Width W1 (mm)	A0 (mm)	B0 (mm)	K0 (mm)	P1 (mm)	W (mm)	Pin1 Quadrant
CD4041UBM96	SOIC	D	14	2500	330.0	16.4	6.5	9.0	2.1	8.0	16.0	Q1
CD4041UBPWR	TSSOP	PW	14	2000	330.0	12.4	6.9	5.6	1.6	8.0	12.0	Q1

**TAPE AND REEL BOX DIMENSIONS**

\*All dimensions are nominal

Device	Package Type	Package Drawing	Pins	SPQ	Length (mm)	Width (mm)	Height (mm)
CD4041UBM96	SOIC	D	14	2500	356.0	356.0	35.0
CD4041UBPWR	TSSOP	PW	14	2000	356.0	356.0	35.0

**TUBE**

\*All dimensions are nominal

Device	Package Name	Package Type	Pins	SPQ	L (mm)	W (mm)	T (μm)	B (mm)
CD4041UBE	N	PDIP	14	25	506	13.97	11230	4.32
CD4041UBE	N	PDIP	14	25	506	13.97	11230	4.32



J 14

**GENERIC PACKAGE VIEW**  
**CDIP - 5.08 mm max height**  
CERAMIC DUAL IN LINE PACKAGE



Images above are just a representation of the package family, actual package may vary.  
Refer to the product data sheet for package details.

4040083-5/G

# J0014A



## PACKAGE OUTLINE

CDIP - 5.08 mm max height

CERAMIC DUAL IN LINE PACKAGE



4214771/A 05/2017

### NOTES:

1. All controlling linear dimensions are in inches. Dimensions in brackets are in millimeters. Any dimension in brackets or parenthesis are for reference only. Dimensioning and tolerancing per ASME Y14.5M.
2. This drawing is subject to change without notice.
3. This package is hermetically sealed with a ceramic lid using glass frit.
4. Index point is provided on cap for terminal identification only and on press ceramic glass frit seal only.
5. Falls within MIL-STD-1835 and GDIP1-T14.

# EXAMPLE BOARD LAYOUT

J0014A

CDIP - 5.08 mm max height

CERAMIC DUAL IN LINE PACKAGE



LAND PATTERN EXAMPLE  
NON-SOLDER MASK DEFINED  
SCALE: 5X



4214771/A 05/2017

D (R-PDSO-G14)

PLASTIC SMALL OUTLINE



4040047-5/M 06/11

- NOTES:
- A. All linear dimensions are in inches (millimeters).
  - B. This drawing is subject to change without notice.
  - $\triangle C$  Body length does not include mold flash, protrusions, or gate burrs. Mold flash, protrusions, or gate burrs shall not exceed 0.006 (0,15) each side.
  - $\triangle D$  Body width does not include interlead flash. Interlead flash shall not exceed 0.017 (0,43) each side.
  - E. Reference JEDEC MS-012 variation AB.

D (R-PDSO-G14)

PLASTIC SMALL OUTLINE



- NOTES:
- All linear dimensions are in millimeters.
  - This drawing is subject to change without notice.
  - Publication IPC-7351 is recommended for alternate designs.
  - Laser cutting apertures with trapezoidal walls and also rounding corners will offer better paste release. Customers should contact their board assembly site for stencil design recommendations. Refer to IPC-7525 for other stencil recommendations.
  - Customers should contact their board fabrication site for solder mask tolerances between and around signal pads.



N (R-PDIP-T\*\*)

PLASTIC DUAL-IN-LINE PACKAGE

16 PINS SHOWN



- NOTES:
- A. All linear dimensions are in inches (millimeters).
  - B. This drawing is subject to change without notice.
  - Falls within JEDEC MS-001, except 18 and 20 pin minimum body length (Dim A).
  - The 20 pin end lead shoulder width is a vendor option, either half or full width.

## IMPORTANT NOTICE AND DISCLAIMER

TI PROVIDES TECHNICAL AND RELIABILITY DATA (INCLUDING DATA SHEETS), DESIGN RESOURCES (INCLUDING REFERENCE DESIGNS), APPLICATION OR OTHER DESIGN ADVICE, WEB TOOLS, SAFETY INFORMATION, AND OTHER RESOURCES "AS IS" AND WITH ALL FAULTS, AND DISCLAIMS ALL WARRANTIES, EXPRESS AND IMPLIED, INCLUDING WITHOUT LIMITATION ANY IMPLIED WARRANTIES OF MERCHANTABILITY, FITNESS FOR A PARTICULAR PURPOSE OR NON-INFRINGEMENT OF THIRD PARTY INTELLECTUAL PROPERTY RIGHTS.

These resources are intended for skilled developers designing with TI products. You are solely responsible for (1) selecting the appropriate TI products for your application, (2) designing, validating and testing your application, and (3) ensuring your application meets applicable standards, and any other safety, security, regulatory or other requirements.

These resources are subject to change without notice. TI grants you permission to use these resources only for development of an application that uses the TI products described in the resource. Other reproduction and display of these resources is prohibited. No license is granted to any other TI intellectual property right or to any third party intellectual property right. TI disclaims responsibility for, and you will fully indemnify TI and its representatives against, any claims, damages, costs, losses, and liabilities arising out of your use of these resources.

TI's products are provided subject to [TI's Terms of Sale](#) or other applicable terms available either on [ti.com](https://www.ti.com) or provided in conjunction with such TI products. TI's provision of these resources does not expand or otherwise alter TI's applicable warranties or warranty disclaimers for TI products.

TI objects to and rejects any additional or different terms you may have proposed.

Mailing Address: Texas Instruments, Post Office Box 655303, Dallas, Texas 75265  
Copyright © 2024, Texas Instruments Incorporated