

DAC8771 Single-Channel, 16-Bit Voltage and Current Output Digital-to-Analog Converter with Adaptive Power Management

1 Features

- Output Current:
 - 0 mA - 24 mA; 3.5 mA - 23.5 mA;
 - 0 mA - 20 mA; 4 mA - 20 mA; ± 24 mA
- Output Voltage (with/without 20% over-range):
 - 0 V - 5 V; 0 V - 10 V; ± 5 V; ± 10 V
 - 0 V - 6 V; 0 V - 12 V; ± 6 V; ± 12 V
- Adaptive Power Management
- Single Wide Power Supply Pin
 - 12 V - 36 V with Buck-Boost
 - 12 V - 33 V without Buck-Boost
- $\pm 0.1\%$ FSR Total Unadjusted Error (TUE)
- DNL: ± 1 LSB Max
- Internal 5-V Reference (10 ppm/ $^{\circ}$ C max)
- Internal 5-V Digital Power Supply Output
- CRC/Frame Error Check, Watchdog Timer
- Thermal Alarm, Open/Short circuit
- Safe actions on alarm condition
- Auto Learn Feature
- Wide Temperature Range: -40° C to $+125^{\circ}$ C

2 Applications

- 4 mA to 20 mA Current Loops
- Analog Output Modules
- Programmable Logic Controllers (PLCs)
- Building Automation

3 Description

The DAC8771 is a single channel, precision, fully integrated 16-bit digital to analog converter (DAC) with adaptive power management, and is designed to meet the requirements of industrial control applications. The adaptive power management circuit, when enabled, minimizes the power dissipation of the chip. When programmed as a current output, the supply voltage on the current output driver is regulated between 4 V and 32 V based on continuous feedback of voltage on the current output pin via a buck/boost converter. When programmed as a voltage output, this circuit generates a programmable supply voltage for the voltage output stage (± 15 V). DAC8771 contains an LDO to generate the digital supply (5 V) from a single power supply pin, particularly helpful in isolated applications.

DAC8771 is also implemented with a HART Signal Interface to superimpose an external HART signal on the current output. The slew rate of the current output DAC is register programmable. The devices can operate with a single external power supply of +12 V to +36 V using the integrated buck/boost converter or with external power supplies when the buck/boost converter is disabled.

Device Information⁽¹⁾

PART NUMBER	PACKAGE	BODY SIZE (NOM)
DAC8771	VQFN (48)	7.00 mm x 7.00 mm

(1) For all available packages, see the orderable addendum at the end of the data sheet.

DAC8771 Block Diagram

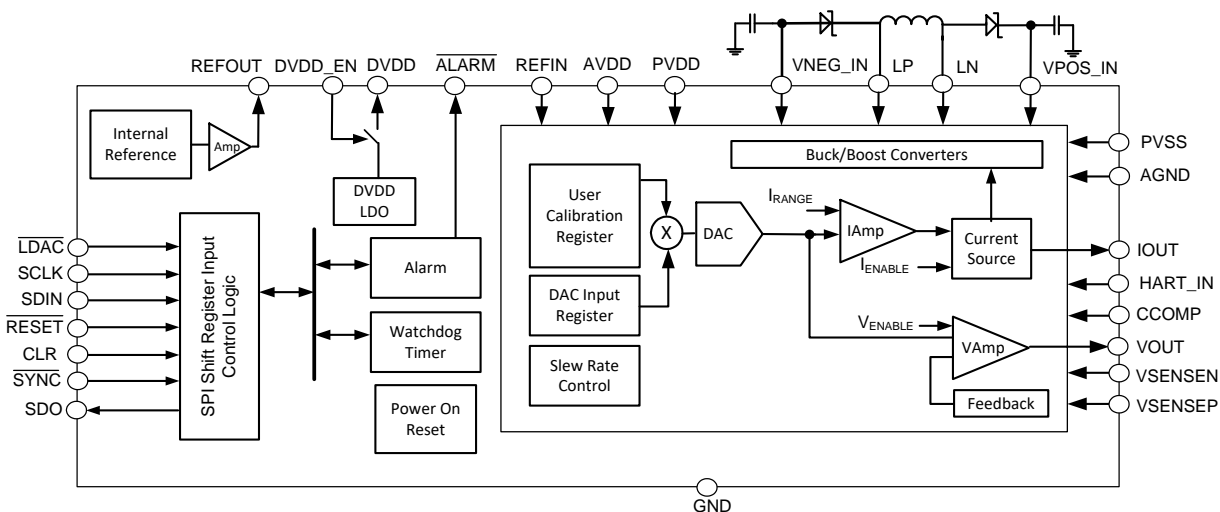

Copyright © 2018, Texas Instruments Incorporated



Table of Contents

1 Features	1	8.4 Device Functional Modes.....	40
2 Applications	1	8.5 Register Maps	45
3 Description	1	9 Application and Implementation	60
4 Revision History	2	9.1 Application Information.....	60
5 Device Comparison Table	3	9.2 Typical Application	63
6 Pin Configuration and Functions	3	10 Power Supply Recommendations	66
7 Specifications	5	11 Layout	68
7.1 Absolute Maximum Ratings	5	11.1 Layout Guidelines	68
7.2 ESD Ratings.....	5	11.2 Layout Example	69
7.3 Recommended Operating Conditions.....	6	12 Device and Documentation Support	72
7.4 Thermal Information	6	12.1 Device Support.....	72
7.5 Electrical Characteristics.....	7	12.2 Documentation Support	72
7.6 Timing Requirements: Write and Readback Mode ..	13	12.3 Receiving Notification of Documentation Updates ..	72
7.7 Typical Characteristics	15	12.4 Community Resources.....	72
8 Detailed Description	31	12.5 Trademarks	72
8.1 Overview	31	12.6 Electrostatic Discharge Caution.....	72
8.2 Functional Block Diagram	31	12.7 Glossary	72
8.3 Feature Description.....	31	13 Mechanical, Packaging, and Orderable Information	72

4 Revision History

DATE	REVISION	NOTES
February 2018	*	Initial release.

5 Device Comparison Table

PRODUCT	RESOLUTION	DIFFERENTIAL NONLINEARITY (LSB)	SPECIFIED TEMPERATURE RANGE
DAC8771	16	±1	–40°C to +125°C

6 Pin Configuration and Functions

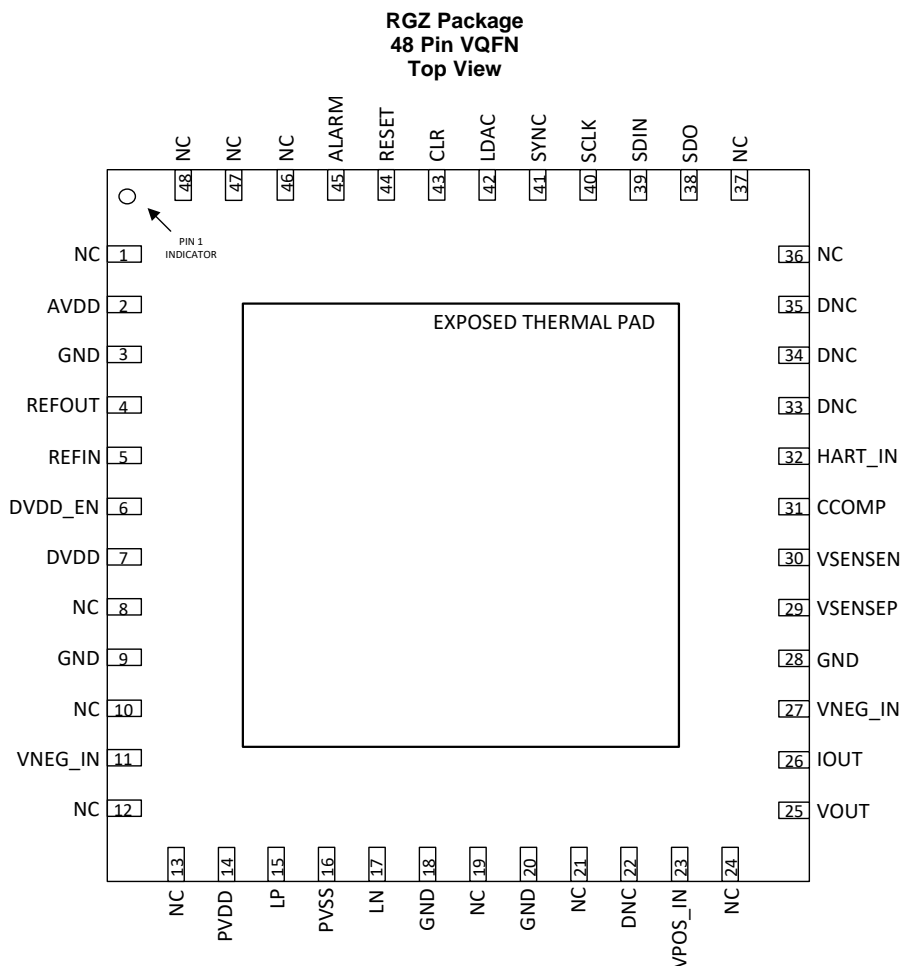

Thermal pad connected to ground.

Pin Functions

NAME	NUMBER	TYPE	DESCRIPTION
AVDD	2	Supply	Power supply for all analog circuitry of the device except buck-boost converter and output amplifiers.
GND	3, 9, 18, 20, 28	Supply	Ground.
REFOUT	4	Analog Output	Internal reference output. Connects to REFIN when using internal reference.
REFIN	5	Analog Input	Reference input. Connects to REFOUT when using internal reference.
DVDD_EN	6	Digital Input	Internal power-supply enable pin. Connect this pin to GND to disable the internal DVDD, or leave this pin unconnected to enable the internal DVDD. When this pin is connected to GND an external supply must be connected to the DVDD pin.

Pin Functions (continued)

NAME	NUMBER	TYPE	DESCRIPTION
DVDD	7	Supply	Digital supply pin (Input/Output). Internal DVDD enabled when DVDD_EN is floating, External DVDD must be supplied when DVDD_EN is connected to GND.
VNEG_IN	11, 27	Supply	Negative power supply for output stage. Connected internally, however both external connections are required.
PVDD	14	Supply	Buck-Boost converter power supply.
LP	15	Analog Output	External inductor positive terminal.
PVSS	16	Supply	Switch ground for Buck-Boost converter.
LN	17	Analog Output	External inductor negative terminal.
VPOS_IN	23	Supply	Positive power supply for output stage.
VOUT	25	Analog Output	Voltage output pin.
IOUT	26	Analog Output	Current output pin.
VSENSEP	29	Analog Input	Positive sense pin for voltage output.
VSENSEN	30	Analog Input	Negative sense pin for voltage output.
CCOMP	31	Analog Output	External compensation capacitor connection pin for voltage output. Addition of the external capacitor improves stability for high capacitive loads at the VOUT pin by reducing the bandwidth of the output amplifier at the expense of settling time.
HART_IN	32	Analog Input	Input pin for HART modulation. If this pin is used it must be AC coupled to the HART input sinusoidal waveforms via a capacitor. If this feature is not used TI recommends to AC couple this pin to ground via a capacitor, though it may also be left floating.
SDO	38	Digital Output	Serial data output. Data is valid on the falling edge of SCLK.
SDIN	39	Digital Input	Serial data input. Data is clocked into the 24-bit input shift register on the falling edge of the serial clock input. Schmitt-Trigger logic input.
SCLK	40	Digital Input	Serial clock input of serial peripheral interface (SPI™). Data can be transferred at rates up to 25 MHz. Schmitt-Trigger logic input.
$\overline{\text{SYNC}}$	41	Digital Input	SPI™ bus chip select input (active low). Data bits are not clocked into the serial shift register unless SYNC is low. When SYNC is high SDO is in a high-impedance state.
$\overline{\text{LDAC}}$	42	Digital Input	Load DAC latch control input. A logic low on this pin loads the input shift register data into the DAC register and updates the DAC output.
CLR	43	Digital Input	Level triggered clear pin (active high). Clears DAC output to zero code or mid code (see DAC Clear section).
$\overline{\text{RESET}}$	44	Digital Input	Reset input (active low). Logic low on this pin causes the device to perform a reset.
$\overline{\text{ALARM}}$	45	Digital Output	$\overline{\text{ALARM}}$ pin. Open drain output. External pull-up resistor required (10 kΩ). The pin goes low (active) when any ALARM condition is detected (open-circuit, over-temperature, watchdog timeout, and others).
NC	1, 8, 10, 12, 13, 19, 21, 24, 36, 37, 46, 47, 48	N/A	No connection is required on these pins.
DNC	22, 33, 34, 35	N/A	Do not connect these pins.

7 Specifications

7.1 Absolute Maximum Ratings

Over operating free-air temperature range (unless otherwise noted)⁽¹⁾

		MIN	MAX	UNIT
Input voltage	PVDD/AVDD to PBKG	-0.3	40	V
	PVSS to GND	-0.3	0.3	
	VPOS_IN to VNEG_IN	-0.3	40	
	VPOS_IN to GND	-0.3	33	
	VNEG_IN to GND	-20	0.3	
	VSENSE to GND	VNEG_IN	VPOS_IN	
	VSENSEP to GND	VNEG_IN	VPOS_IN	
	CCOMP to VNEG_IN	-0.3	6	
	DVDD to GND	-0.3	6	
	REFOUT/REFIN to GND	-0.3	6	
	Digital input voltage to GND	-0.3	DVDD+0.3	
Output voltage	VOUT to GND	VNEG_IN	VPOS_IN	V
	IOUT to GND	VNEG_IN	VPOS_IN	
	SDO, ALARM to GND	-0.3	DVDD+0.3	
Input Current	Current into any pin	-10	10	mA
Power dissipation			(T _{Jmax} – T _A)/Theta _{JA}	W
Operating junction temperature, T _J		-40	150	°C
Junction temperature range (T _J max)			150	
Storage temperature, T _{stg}		-65	150	

(1) Stresses beyond those listed under Absolute Maximum Ratings may cause permanent damage to the device. These are stress ratings only, which do not imply functional operation of the device at these or any other conditions beyond those indicated under Recommended Operating Conditions. Exposure to absolute-maximum-rated conditions for extended periods may affect device reliability.

7.2 ESD Ratings

		VALUE	UNIT
V _(ESD)	Electrostatic discharge	Human body model (HBM), per ANSI/ESDA/JEDEC JS-001, all pins ⁽¹⁾	±2000
		Charged device model (CDM), per JEDEC specification JESD22-C101, all pins ⁽²⁾	±500

(1) JEDEC document JEP155 states that 500-V HBM allows safe manufacturing with a standard ESD control process.

(2) JEDEC document JEP157 states that 250-V CDM allows safe manufacturing with a standard ESD control process.

7.3 Recommended Operating Conditions

 Over operating free-air temperature range (unless otherwise noted)⁽¹⁾

		MIN	NOM	MAX	UNIT
POWER SUPPLY					
PVDD/AVDD/ to GND	Positive supply voltage to ground	12		36	V
VPOS_IN to GND	Positive supply voltage to ground for all modes	-0.3		33	
VNEG_IN to GND	Negative supply voltage to substrate for current output mode	-18		0	V
	Negative supply voltage to substrate for voltage output mode	-18		-5	V
VPOS_IN to VNEG_IN		12		36	V
VSENSE to GND	The minimum headroom spec for voltage output stage must be met	-7		7	V
DVDD to GND	Digital supply voltage to substrate	2.7		5.5	V
DIGITAL INPUTS					
V _{IH} , input high voltage		2			V
V _{IL} , input low voltage	3.6 V < DVDD < 5.5 V			0.8	V
	2.7 V < DVDD < 3.6 V			0.6	V
REFERENCE INPUT					
REFIN to GND	Reference input to substrate	4.95		5.05	V
TEMPERATURE RANGE					
T _A	Operating temperature	-40		125	°C

(1) The minimum headroom spec for voltage output stage and the compliance voltage for current output stage should be met. When Buck-Boost converter is enabled VPOS_IN_x/VNEG_IN_x are generated internally to meet headroom and compliance specs. When Buck-Boost converter is disabled VPOS_IN_x, AVDD, and PVDD must be tied together.

7.4 Thermal Information

THERMAL METRIC ⁽¹⁾		DAC8771	UNIT
		RGZ	
		48 PINS	
R _{θJA}	Junction-to-ambient thermal resistance	21.8	°C/W
R _{θJC(top)}	Junction-to-case (top) thermal resistance	9.2	°C/W
R _{θJB}	Junction-to-board thermal resistance	5.6	°C/W
Ψ _{JT}	Junction-to-top characterization parameter	0.1	°C/W
Ψ _{JB}	Junction-to-board characterization parameter	5.5	°C/W
R _{θJC(bot)}	Junction-to-case (bottom) thermal resistance	0.3	°C/W

(1) For more information about traditional and new thermal metrics, see the Semiconductor and IC Package Thermal Metrics application report, SPRA953

7.5 Electrical Characteristics

AVDD/PVDD/VPOS_IN = +15V, VNEG_IN = -15V, VSENSEN = GND = PVSS = 0 V, External DVDD = 2.7 V. VOUT : RL = 1 kΩ, CL = 200 pF, IOUT : RL = 250Ω; all specifications -40C to +125C, unless otherwise noted. REFIN= +5 V external, REFOUT = +5V internal, Buck-Boost Converter disabled unless otherwise stated

PARAMETER		TEST CONDITIONS	MIN	TYP	MAX	UNIT
CURRENT OUTPUT						
IOUT	Output Current Ranges		0		24	mA
			0		20	mA
			3.5		23.5	mA
			-24		24	mA
			4		20	mA
ACCURACY						
	Resolution		16			Bits
INL	Relative accuracy ⁽¹⁾	All ranges except bipolar range	-10		10	LSB
		Bipolar range only	-12		12	LSB
DNL	Differential Nonlinearity ⁽¹⁾	Ensured monotonic	-1		1	LSB
TUE	Total Unadjusted Error ⁽¹⁾	-40°C to 125°C	-0.1		0.1	%FSR
		TA = +25°C	-0.08		0.08	
		-40°C to 125°C (4-20mA)	-0.130		0.130	
		TA = +25°C (4-20mA)	-0.08		0.08	
OE	Offset Error ⁽¹⁾	-40°C to 125°C	-0.06		0.06	%FSR
		TA = +25°C	-0.05		0.05	
		-40°C to -125°C (4-20mA)	-0.085		0.085	
		TA = +25°C (4-20mA)	-0.04		0.04	
OE-TC	Offset Error Temperature Coefficient	-40°C to -125°C		1.5		ppm FSR / °C
ZCE	Zero Code Error	DAC data set to 0x0000	-13		13	uA
		DAC data set to 0x0000 (4-20mA)	-13		13	uA
ZCE-TC	Zero Code Error Temperature Coefficient	DAC data set to 0x0000, -40°C to -125°C		1.5		ppm/ °C
GE	Gain Error ⁽¹⁾	-40°C to -125°C	-0.1		0.1	%FSR
		TA = +25°C	-0.075		0.075	
		-40°C to -125°C (4-20mA)	-0.110		0.110	
		TA = +25°C (4-20mA)	-0.08		0.08	
GE-TC	Gain Error Temperature Coefficient	-40C to -125C		3		ppm FSR / °C
FSE	Full Scale Error	DAC data set to 0xFFFF, -40°C to -125°C	-0.1		0.1	%FSR
		DAC data set to 0xFFFF, -40°C to -125°C (4-20mA)	-0.130		0.130	%FSR
NFSE	Negative Full Scale Error	DAC data set to 0x0000, bipolar range only, -40°C to -125°C	-0.05		0.05	%FSR
FSE-TC	Full Scale Error Temperature Coefficient			3		ppm FSR / °C
BPZE	Bipolar Zero Error	bipolar range only, DAC data set to 0x8000, -40°C to -125°C	-0.05		0.05	%FSR
		bipolar range only, DAC data set to 0x8000, TA = +25°C	-0.02		0.02	
BPZE-TC	Bipolar Zero Error Temperature Coefficient	0x8000h into DAC, -40°C to -125°C		4		ppm/ °C

(1) For current output all ranges except ±24 mA, low code of 256d and a high code of 65280d are used, for ±24 mA range low code of 0d and a high code of 65280d. For voltage output, low code of 256d and a high code of 65280d are used

Electrical Characteristics (continued)

AVDD/PVDD/VPOS_IN = +15V, VNEG_IN = -15V, VSENSE = GND = PVSS = 0 V, External DVDD = 2.7 V. VOUT : RL = 1 kΩ, CL = 200 pF, IOUT : RL = 250Ω; all specifications -40°C to +125°C, unless otherwise noted. REFIN= +5 V external, REFOUT = +5V internal, Buck-Boost Converter disabled unless otherwise stated

PARAMETER		TEST CONDITIONS	MIN	TYP	MAX	UNIT
VCL	Loop Compliance Voltage	Output=24mA			VPOS_I N-3	V
		Output=±24mA	VNEG _IN -3		VPOS_I N-3	
RL	Resistive Load	All except ±24 mA range			1.2K	Ω
		±24 mA range			0.625K	
DC-PSRR	DC Power Supply Rejection Ratio	DAC data set to 0x8000, 20mA range		0.1		μA/V
Zo	Output Impedance	DAC data set to 0x8000		10		MΩ
IOLEAK	Output Current Leakage	Iout is disabled or in power-down		1		nA
HART INTERFACE						
VHART-IN	HART Input		400	500	600	mVpp
	Corresponding Output	HART In = 500mVpp 1.2KHz		1		mApp
VOLTAGE OUTPUT						
VOUT	Voltage Output Ranges (normal mode)		0		5	
			0		10	
			-5		5	
			-10		10	
	Voltage Output Ranges (Overrange mode)		0		6	
			0		12	
			-6		6	
			-12		12	
ACCURACY						
	Resolution		16			Bits
INL	Relative Accuracy, INL ⁽¹⁾		-12		12	LSB
DNL	Differential Nonlinearity, DNL ⁽¹⁾	Ensured monotonic	-1		1	LSB
TUE	Total Unadjusted Error, TUE ⁽¹⁾	-40°C to 125°C, VOUT unloaded	-0.1	±0.05	0.1	%FSR
		TA = +25°C, VOUT unloaded	-0.75		0.75	
BPZE	Bipolar Zero Error	bipolar range only, DAC data set to 0x8000, -40°C to 125°C, VOUT unloaded	-0.05		0.05	%FSR
		bipolar range only, DAC data set to 0x8000, TA = +25°C, VOUT unloaded	-0.03		0.03	
BPZE-TC	Bipolar Zero Error Temperature Coefficient	bipolar range only, DAC data set to 0x8000, -40°C to 125°C, (VOUT unloaded)		1		ppm FSR / °C
OE	Offset Error	Unipolar ranges only, (Vout unloaded), -40°C to 125°C	-5		5	mV
OE	Offset Error	Unipolar ranges only, (Vout unloaded), TA = 25°C		0.65		mV
OE-TC	Offset Error Temperature Coefficient	Unipolar ranges only, -40°C to 125°C		1.5		ppm FSR / °C
GE	Gain Error ⁽¹⁾	-40°C to 125°C, VOUT unloaded	-0.1		0.1	%FSR
		TA = +25°C, VOUT unloaded	-0.07		0.07	
GE-TC	Gain Error Temperature Coefficient			3		ppm FSR / °C
FSE	Full Scale Error	DAC data set to 0xFFFF, -40° to 125°C, (Vout unloaded)	-0.1		0.1	%FSR
		DAC data set to 0xFFFF, 25°C, (Vout unloaded)		0.03		%FSR

Electrical Characteristics (continued)

AVDD/PVDD/VPOS_IN = +15V, VNEG_IN = -15V, VSENSE = GND = PVSS = 0 V, External DVDD = 2.7 V. VOUT : RL = 1 kΩ, CL = 200 pF, IOUT : RL = 250Ω; all specifications -40°C to +125°C, unless otherwise noted. REFIN= +5 V external, REFOUT = +5V internal, Buck-Boost Converter disabled unless otherwise stated

PARAMETER		TEST CONDITIONS	MIN	TYP	MAX	UNIT
NFSE	Negative Full Scale Error	Bipolar ranges only, DAC data set to 0x0000, -40°C to 125°C, (Vout unloaded)	-0.07		0.07	%FSR
		Bipolar ranges only, DAC data set to 0x0000, -40°C to 125°C, (Vout unloaded)		0.002		%FSR
FSE-TC	Full Scale Error Temperature Coefficient	(Vout unloaded)		2		ppm FSR / °C
	Headroom	Output unloaded, VPOS_IN with respect to VOUT, DAC data set to 0xFFFF, specified by design	0.5			V
		1kΩ output load, VPOS_IN with respect to VOUT, DAC data set to 0xFFFF, specified by design	3			V
	Footroom	Bipolar, ranges only, VNEG_IN with respect to VOUT, DAC data set to 0x0000, specified by design	-3			V
		Unipolar ranges only, VNEG_IN with respect to VOUT, DAC data set to 0x0000, specified by design	-5			V
	Short-Circuit Current	SCLIM[1:0] = "00" (see register map)	17		27	mA
		SCLIM[1:0] = "01" (see register map)	8		12	mA
		SCLIM[1:0] = "10" (see register map)	22		30	mA
		SCLIM[1:0] = "11" (see register map)	26		36	mA
RL	Load		1		kΩ	
CL	Capacitive Load Stability	RL = Open			20	nF
		RL = 1 kΩ			20	nF
		RL = 1 kΩ with External compensation capacitor (150pF) connected.			1	μF
ZO	DC Output Impedance	Voltage output enabled, Vout = Mid-Scale, 0-10V range		0.01		Ω
		Voltage output disabled		50		MΩ
		Voltage output disabled (POC = '0')		30		kΩ
DC-PSRR	DC Power Supply Rejection Ratio	No Output Load		10		μV/V
	VSENSE Impedance	VOUT Enabled, Vout = Mid-Scale, 0-10V Range, specified by design		120		kΩ
	VSENSE Impedance	VOUT Enabled, Vout = Mid-Scale, 0-10V Range, specified by design		240		kΩ
EXTERNAL REFERENCE INPUT						
IREF	External reference current	Vout = Negative Full-Scale, ±12V range		350		μA
	Reference Input Capacitance			100		pF
INTERNAL REFERENCE OUTPUT						
VREF	Reference Output	TA = 25°C	4.99		5.01	V
VREF-TC	Reference TC	TA = -40°C to 125°C	-10		10	ppm/°C
TUE	DAC Voltage Output Total unadjusted error ⁽¹⁾	-40°C to 125°C, VOUT unloaded, Internal reference enabled		0.2		%FSR
	DAC Current Output Total unadjusted error ⁽¹⁾	-40°C to +125°C, Internal reference enabled		0.2		%FSR
	Output Noise (0.1 Hz to 10 Hz)	TA = 25°C		13		μV p-p
	Noise Spectral Density	At 10 kHz, 25°C		200		nV/sqrtHz

Electrical Characteristics (continued)

AVDD/PVDD/VPOS_IN = +15V, VNEG_IN = -15V, VSENSE = GND = PVSS = 0 V, External DVDD = 2.7 V. VOUT : RL = 1 kΩ, CL = 200 pF, IOUT : RL = 250Ω; all specifications -40C to +125C, unless otherwise noted. REFIN= +5 V external, REFOUT = +5V internal, Buck-Boost Converter disabled unless otherwise stated

PARAMETER		TEST CONDITIONS	MIN	TYP	MAX	UNIT
CL	Capacitive Load				600	nF
IL	Load Current			±5		mA
	Short Circuit Current	Reference output shorted to GND		20		mA
	Load Regulation	Sourcing and Sinking, TA = +25°C		5		μV/mA
	Line regulation	TA = +25°C		1		uV/V
BUCK BOOST CONVERTER						
RON	Switch On Resistance	TA = +25°C		3		Ω
ILEAK	Switch Leakage Current	TA = +25°C		20		nA
L	Inductor	between LP and LN		100		μH
ILMAX	Peak Inductor Current	TA = +25°C, maximum specified by design		0.35	0.5	A
VO	Output Voltage	VPOS_IN	4		32	V
		VNEG_IN	-18		-5	V
CL	Load Capacitor	VPOS_IN and VNEG_IN	10			μF
	Start up time	After enabling VPOS_IN and VNEG_IN with 10μF load capacitor on these pins		3		ms
DVDD LDO						
VO	Output Voltage			5		V
ILOAD	Load Current				10	mA
CL	Load Capacitor				0.2	μF
THERMAL ALARM						
	Trip point			150		°C
	Hysteresis			15		°C
DIGITAL INPUTS						
	Hysteresis voltage			0.4		V
	Input Current		-5		5	μA
	Pin Capacitance	Per pin		10		pF
DIGITAL OUTPUTS						
SDO						
VOL	Output Low Voltage	Sinking 200 μA			0.4	V
VOH	Output High Voltage	Sourcing 200 μA	DVDD-0.5			V
ILEAK	High Impedance Leakage		-5		5	μA
	High Impedance Output Capacitance			10		pF
ALARM						
VOL	Output Low Voltage	At 10 mA		0.4		V
ILEAK	High Impedance Leakage			50		μA
	High Impedance Output Capacitance			10		pF
POWER REQUIREMENTS						
IAVDD	Current Flowing into AVDD	Buck-Boost converter enabled, All IOUT Active, 0mA, 0-20mA range		3		mA
		IOUT Active, 0 mA, 0-20mA range, VNEG_IN = 0V		1.3		mA
IPVDD	Current Flowing into PVDD	Buck-Boost converter enabled, Peak Current, specified by design			0.5	A
		Buck-Boost converter disabled		0.1		mA

Electrical Characteristics (continued)

AVDD/PVDD/VPOS_IN = +15V, VNEG_IN = -15V, VSENSEN = GND = PVSS = 0 V, External DVDD = 2.7 V. VOUT : RL = 1 kΩ, CL = 200 pF, IOOUT : RL = 250Ω; all specifications -40C to +125C, unless otherwise noted. REFIN= +5 V external, REFOUT = +5V internal, Buck-Boost Converter disabled unless otherwise stated

PARAMETER		TEST CONDITIONS	MIN	TYP	MAX	UNIT
IDVDD	Current Flowing into DVDD	All digital pins at DVDD, DVDD 2.7V to 5.5V		1.8		mA
IVPOS_IN	Current Flowing into VPOS_IN	IOOUT Active, 0mA, 0-20mA range			1.2	mA
		VOUT Active, no load, 0-10V range, mid scale code			3	mA
IVNEG_IN	Current Flowing into VNEG_IN	IOOUT Active, 0mA, ±24mA range			1.2	mA
		VOUT Active, no load, 0-10V range, mid scale code			3	mA
PDISS	Power dissipation (PVDD+AVDD)	Buck-Boost converter positive output enabled, IOOUT mode operation, All IOOUT channels enabled, Rload = 1Ω, 24mA, PVDD = AVDD = 12V		0.226	0.275	W
IVSENSEP	Current Flowing into VSENSEP	VOUT Disabled, specified by design			40	nA
IVSENSEN	Current Flowing into VSENSEN	VOUT Disabled, specified by design			20	nA
DYNAMIC PERFORMANCE						
VOLTAGE OUTPUT						
T _{sett}	Output Voltage Settling Time	0 to 10V, to ±0.03% FSR RL = 1kΩ CL = 200pF		15		μs
		0 to 5V, to ±0.03% FSR RL = 1kΩ CL = 200pF		10		μs
		-5 to 5V, to ±0.03% FSR RL = 1kΩ CL = 200pF		20		μs
		-10 to 10V, to ±0.03% FSR RL = 1kΩ CL = 200pF		30		μs
	Output voltage ripple	Buck-Boost converter enabled, 50 KHz 20dB/decade low-pass filter on VPOS_IN		2		mVpp
SR	Slew Rate	RL = 1kΩ CL = 200pF		1		V/μs
	Power-On Glitch Energy ⁽²⁾	Specified by design			0.1	V
	Power-off Glitch Energy ⁽³⁾	Specified by design			0.8	V
	Code-Code Glitch			0.15		μV-sec
	Digital Feedthrough			1		nV-sec
	Output Noise (0.1 Hz to 10 Hz Bandwidth)	0-10V range, Mid-Scale		0.1		LSB p-p
	Output Noise (100 kHz Bandwidth)	0-10V range, Mid-Scale		200		μVrms
	Output Noise Spectral Density	±10V Measured at 10 kHz, Mid-Scale		200		nV/sqrtHz
AC-PSRR	AC Power Supply Rejection Ratio	200mV 50/60Hz sinusoid superimposed on power supply voltage (AC analysis).		-75		dB
CURRENT OUTPUT						
T _{sett}	Output Current Settling Time	24 mA Step, to 0.1% FSR, no L		10		μs
		24 mA Step, to 0.1% FSR , L = 1mH, CL = 22nF		50		μs
	Output current ripple	Buck-boost converter enabled, 50 KHz 20dB/decade low-pass filter on VPOS_IN		2		μApp
L	Inductive Load ⁽⁴⁾				50	mH

(2) No load, DVDD supply ramps up before VPOS_IN, and VNEG_IN, ramp rate of VPOS_IN, and VNEG_IN limited to 18V/msec

(3) Vout disabled, no load, ramp rate of VPOS_IN, and VNEG_IN limited to 18V/msec

(4) 680nF is required at IOOUT pin for 50mH pure inductor load

Electrical Characteristics (continued)

AVDD/PVDD/VPOS_IN = +15V, VNEG_IN = -15V, VSENSEN = GND = PVSS = 0 V, External DVDD = 2.7 V. VOUT : RL = 1 k Ω , CL = 200 pF, IOUT : RL = 250 Ω ; all specifications -40C to +125C, unless otherwise noted. REFIN= +5 V external, REFOUT = +5V internal, Buck-Boost Converter disabled unless otherwise stated

PARAMETER		TEST CONDITIONS	MIN	TYP	MAX	UNIT
AC-PSRR	AC Power Supply Rejection Ratio	200mV 50/60Hz Sine wave superimposed on power supply voltage		-75		dB

7.6 Timing Requirements: Write and Readback Mode

At $T_A = -40^{\circ}\text{C}$ to $+125^{\circ}\text{C}$ and $DVDD = +2.7\text{ V}$ to $+5.5\text{ V}$, unless otherwise noted.

PARAMETER		TEST CONDITIONS	MIN	MAX	UNIT
f_{SCLK}	Max clock frequency			25	MHz
t_1	SCLK cycle time		40		ns
t_2	SCLK high time		18		ns
t_3	SCLK low time		18		ns
t_4	$\overline{\text{SYNC}}$ falling edge to SCLK falling edge setup time		15		ns
t_5	24 th /32 nd SCLK falling edge to $\overline{\text{SYNC}}$ rising edge		13		ns
t_6	$\overline{\text{SYNC}}$ high time	Digital slew rate control disabled	40		ns
t_7	Data setup time		8		ns
t_8	Data hold time		5		ns
t_9	$\overline{\text{SYNC}}$ rising edge to $\overline{\text{LDAC}}$ falling edge		33		ns
t_{10}	$\overline{\text{LDAC}}$ pulse width low		10		ns
t_{11}	$\overline{\text{LDAC}}$ falling edge to DAC output response time			50	ns
t_{12}	DAC output settling time		See section 5.3		μs
t_{13}	CLR high time		10		ns
t_{14}	CLR activation time			50	ns
t_{15}	SCLK rising edge to SDO valid			14	ns
t_{16}	$\overline{\text{SYNC}}$ rising edge to DAC output response time			50	ns
t_{17}	$\overline{\text{LDAC}}$ falling edge to $\overline{\text{SYNC}}$ rising edge		100		ns
t_{18}	RESET pulse width		10		ns
t_{19}	$\overline{\text{SYNC}}$ rising edge to CLR falling/rising edge		60		ns

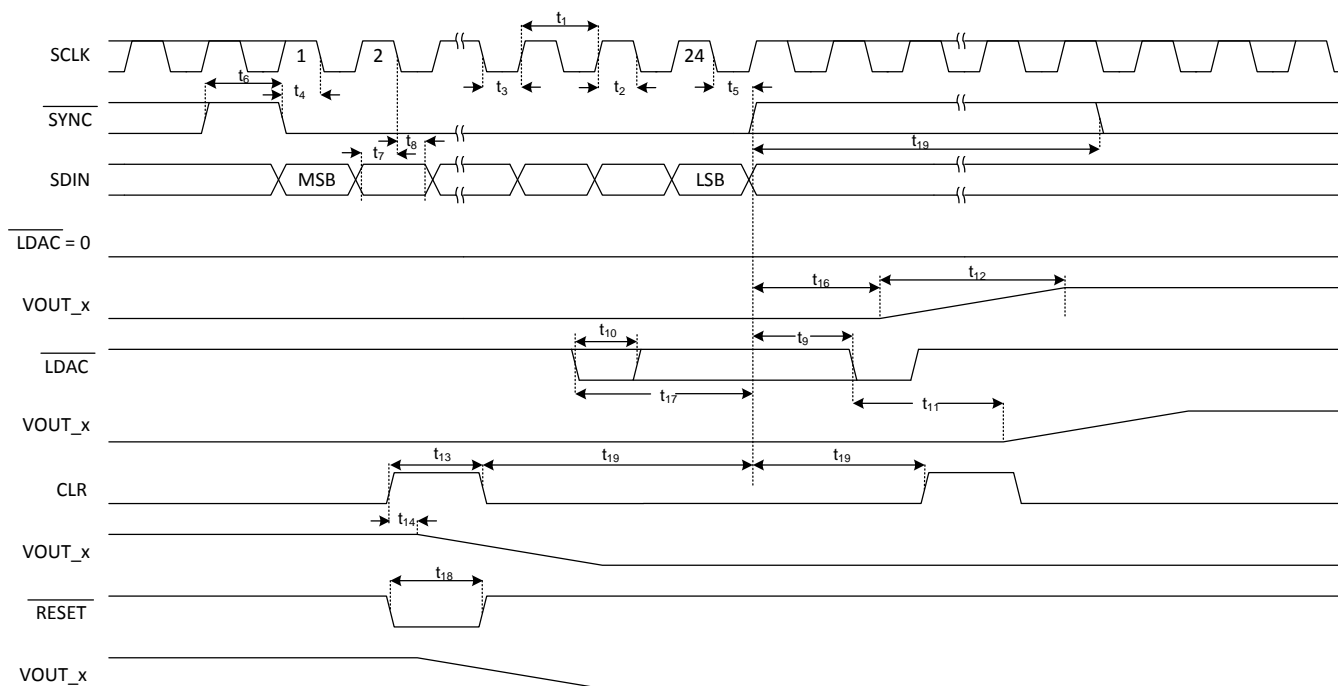
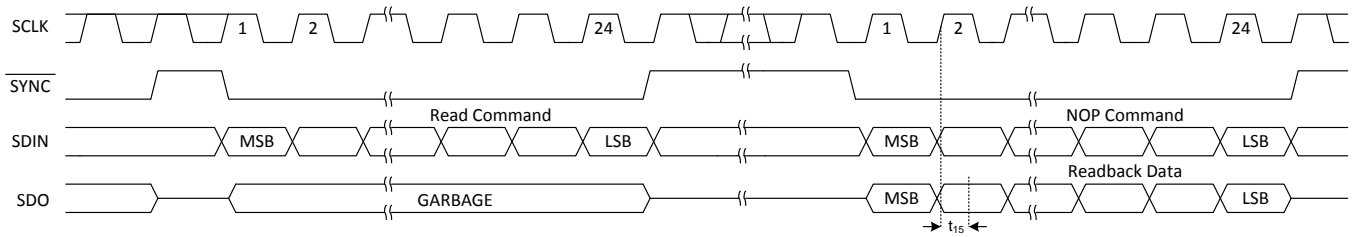

Figure 1. Write Mode Timing

Figure 2. Readback Mode Timing

7.7 Typical Characteristics

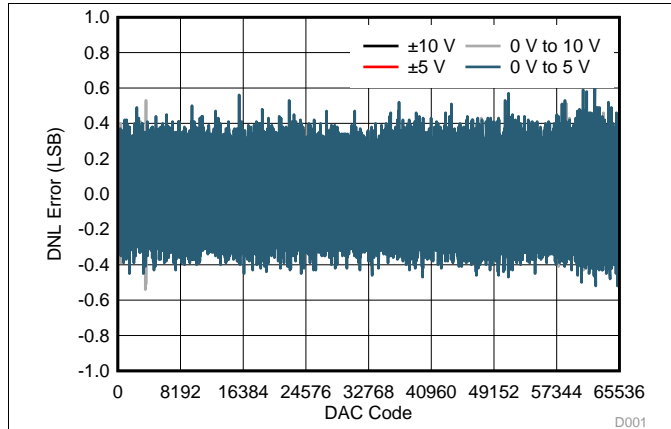

Figure 3. VOUT DNL vs Code (DC/DC Enabled)

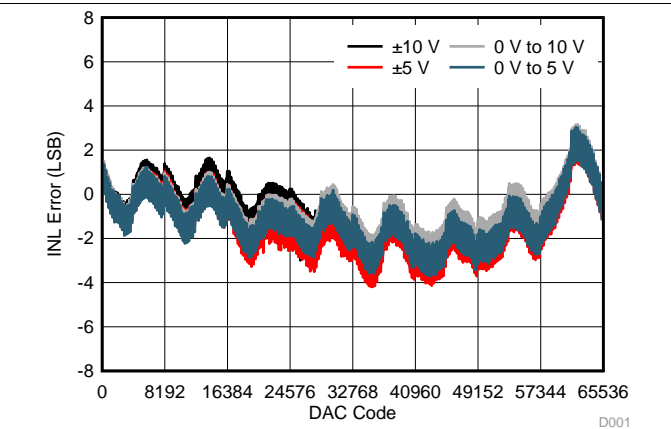

Figure 4. VOUT INL vs Code (DC/DC Enabled)

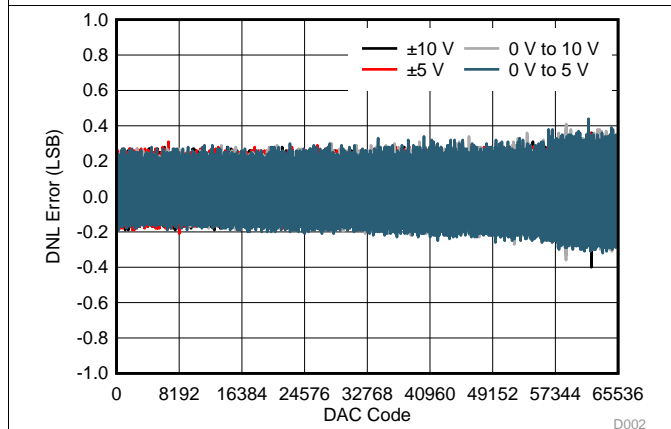

Figure 5. VOUT DNL vs Code (DC/DC Disabled)

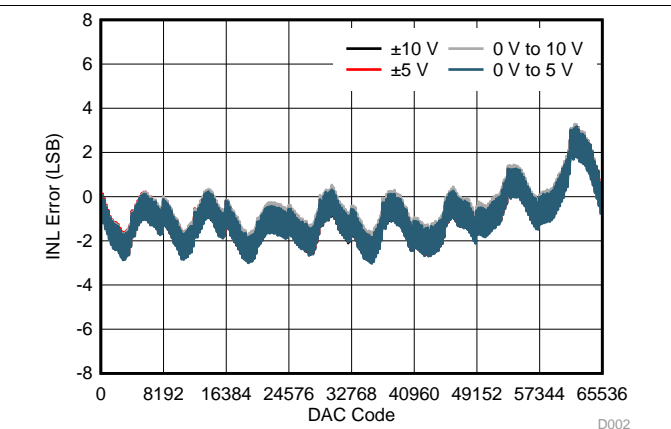

Figure 6. VOUT INL vs Code (DC/DC Disabled)

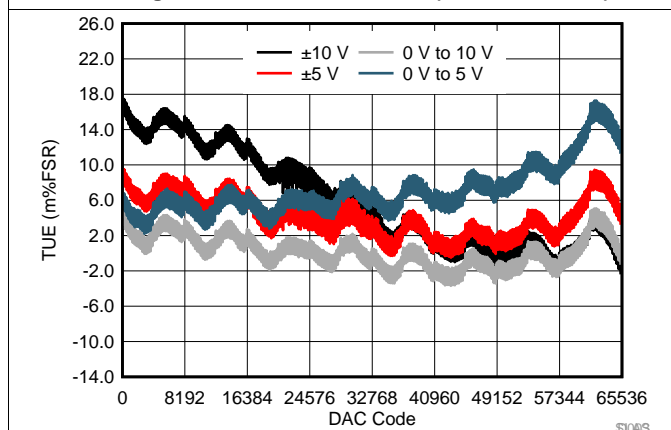

Figure 7. VOUT TUE vs Code (DC/DC Enabled)

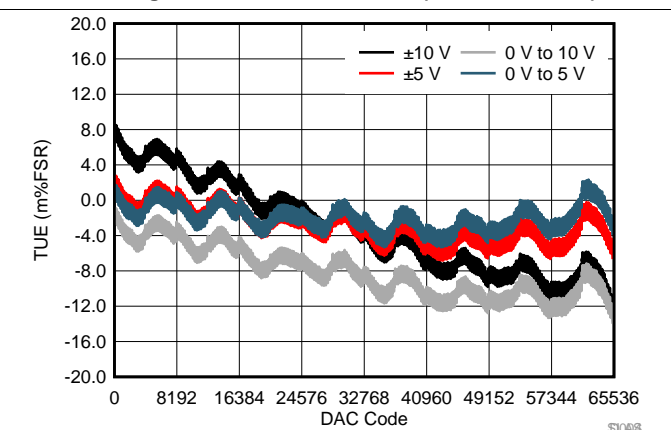

Figure 8. VOUT TUE vs Code (DC/DC Disabled)

Typical Characteristics (continued)

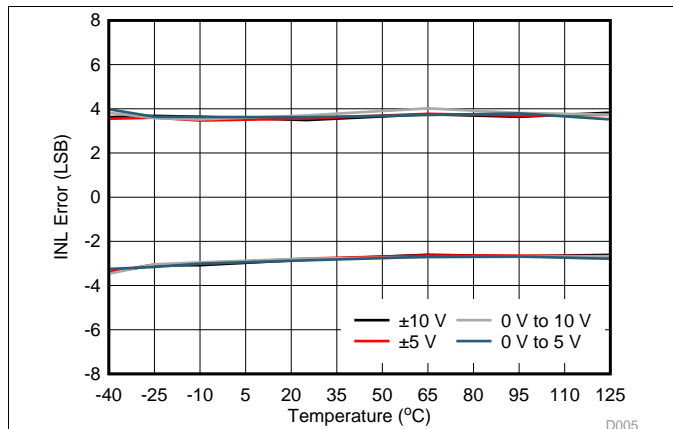

Figure 9. VOUT INL vs Temperature

D005

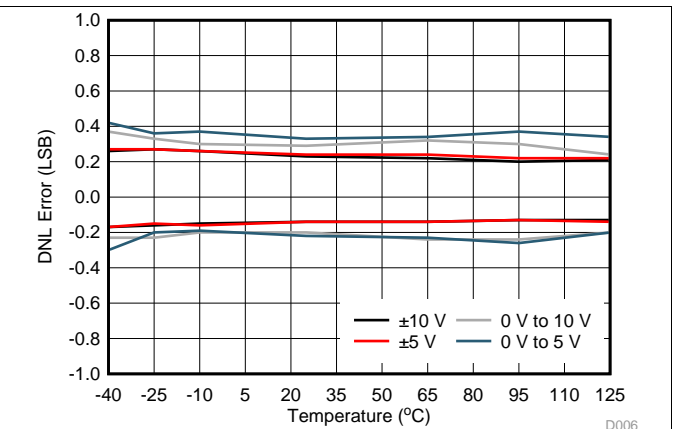

Figure 10. VOUT DNL vs Temperature

D006

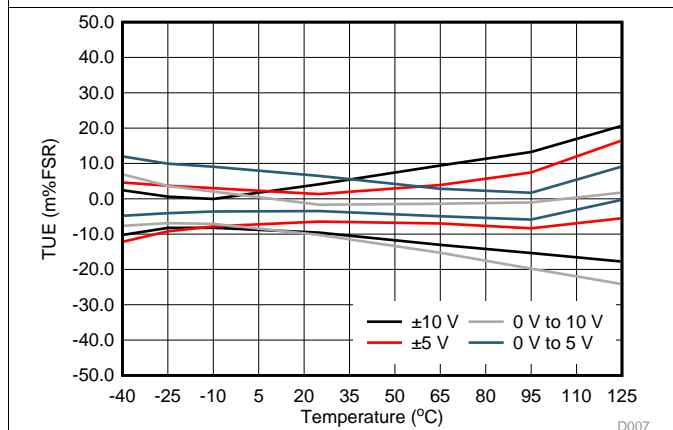

Figure 11. VOUT TUE vs Temperature

D007

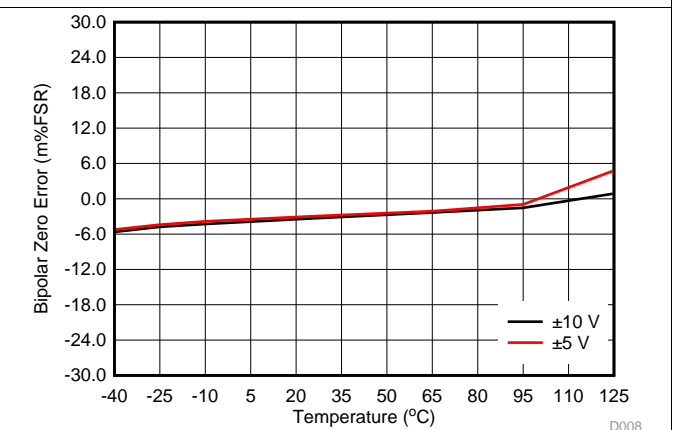

Figure 12. VOUT Bipolar Zero Error vs Temperature

D008

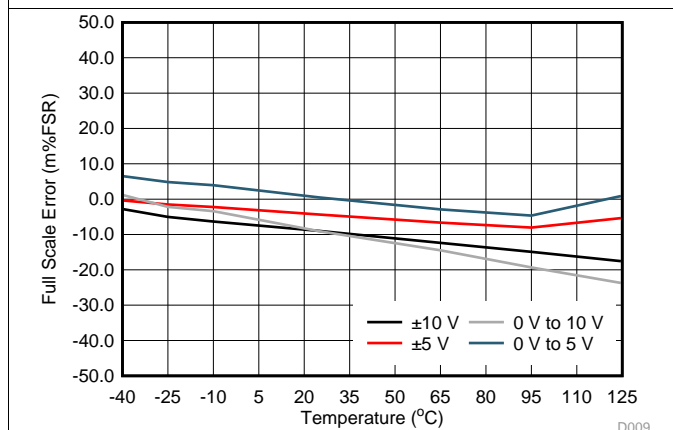

Figure 13. VOUT Full-Scale Error vs Temperature

D009

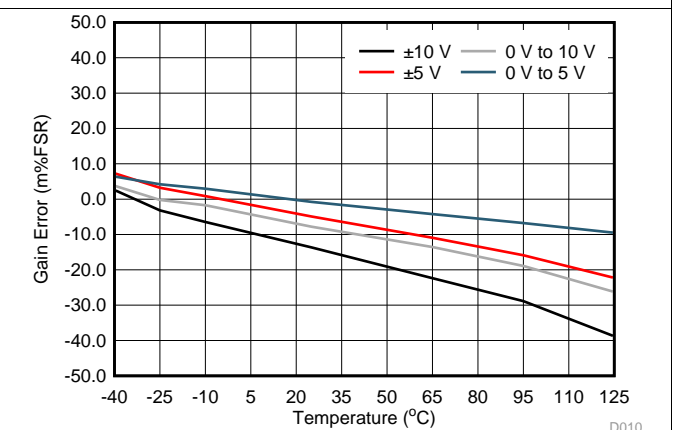

Figure 14. VOUT Gain Error vs Temperature

D010

Typical Characteristics (continued)

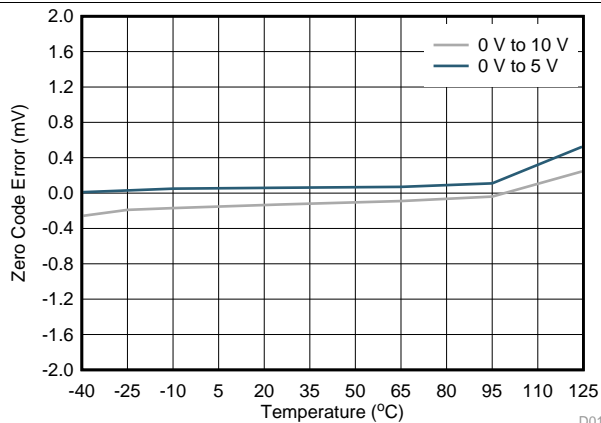

Figure 15. VOUT Zero-Code Error vs Temperature

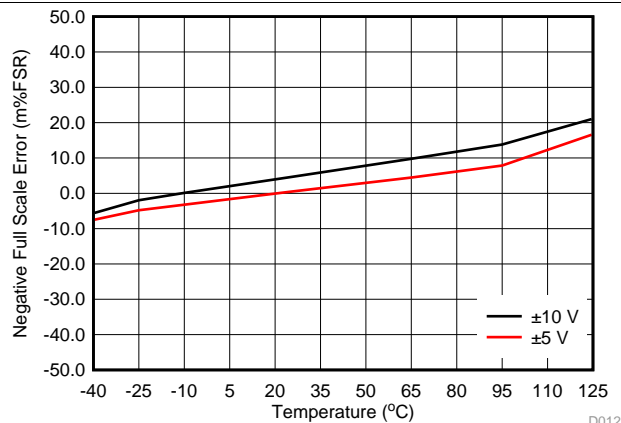

Figure 16. VOUT Negative Full-Scale Error vs Temperature

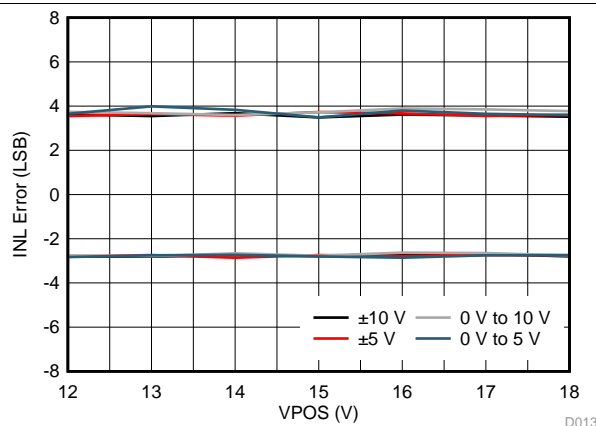

Figure 17. VOUT INL vs VPOS

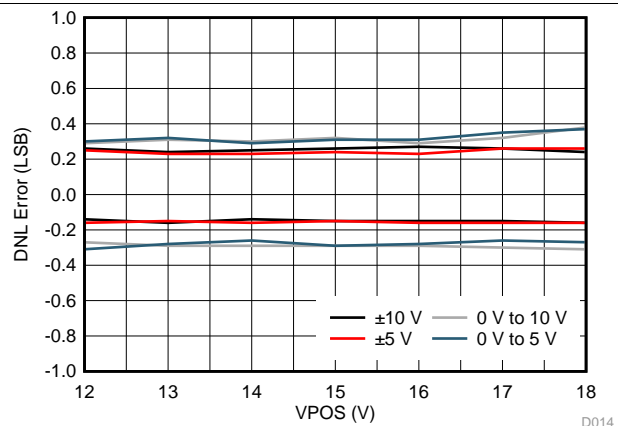

Figure 18. VOUT DNL vs VPOS

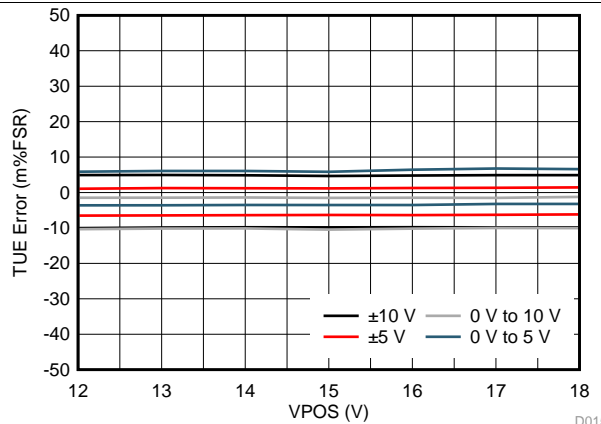

Figure 19. VOUT TUE vs VPOS

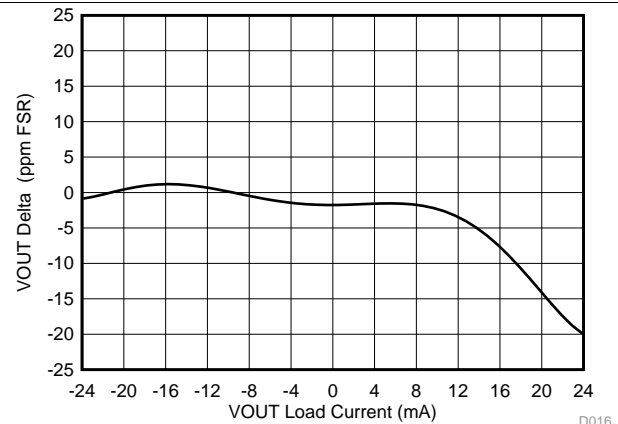
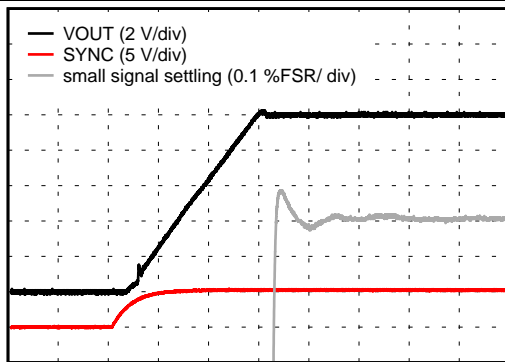

Figure 20. VOUT Load Regulation (SCLM = 11)

Typical Characteristics (continued)



Time (4 μ s/div)

D017

Figure 21. VOUT Settling Time, Rising Signal

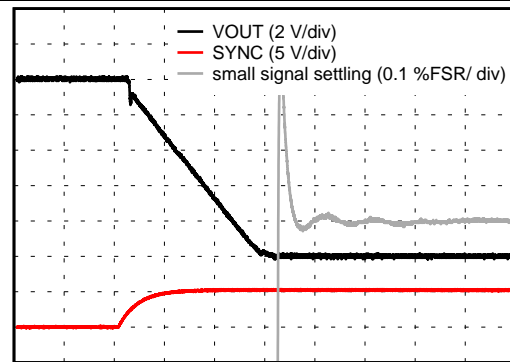

Time (4 μ s/div)

D018

Figure 22. VOUT Settling Time, Falling Signal

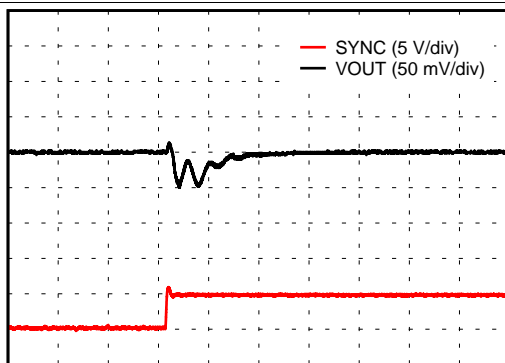

Time (0.8 μ s/div)

D020

Figure 23. VOUT Major-Carry Glitch, Positive

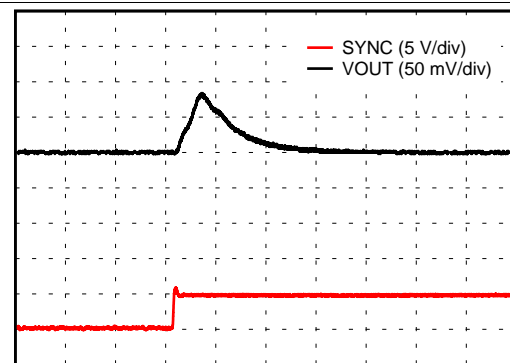

Time (0.8 μ s/div)

D021

Figure 24. VOUT Major-Carry Glitch, Negative

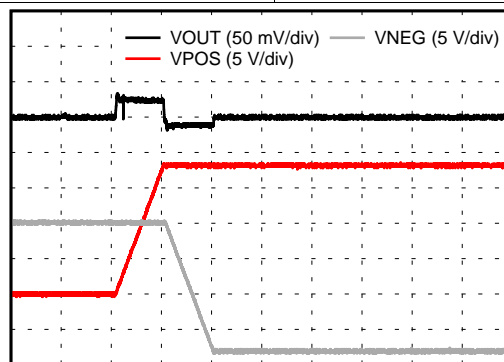

Time (1 ms/div)

D022

Figure 25. VOUT Power-On Glitch

Typical Characteristics (continued)

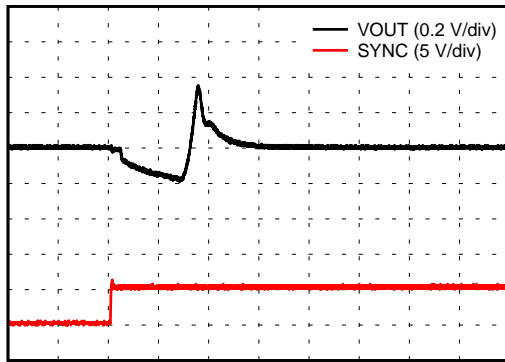

Figure 26. VOUT Output-Enable Glitch

D023

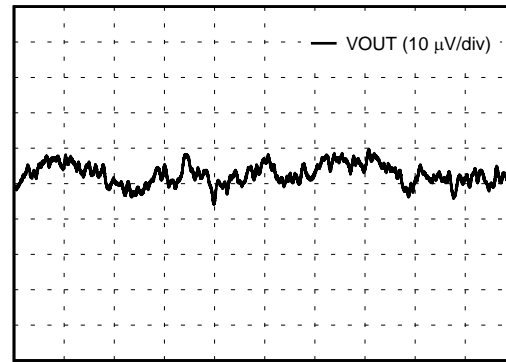

Figure 27. VOUT Noise (DC/DC Disabled)

D024

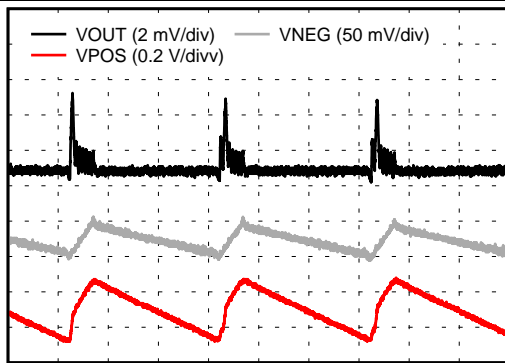

Figure 28. VOUT DC/DC Ripple (50kHz First-Order Low-Pass Filter)

D025

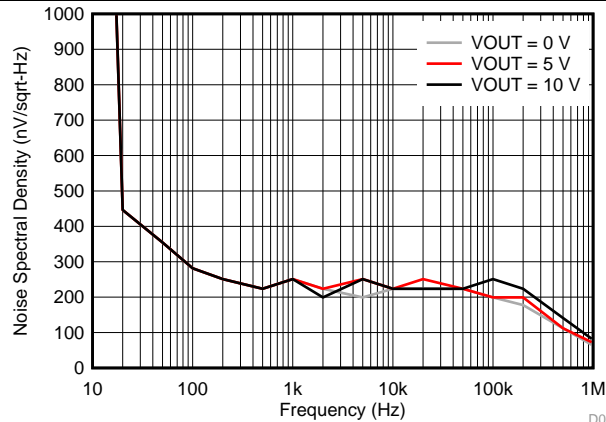

Figure 29. VOUT Noise Spectral Density (DC/DC Disabled)

D026

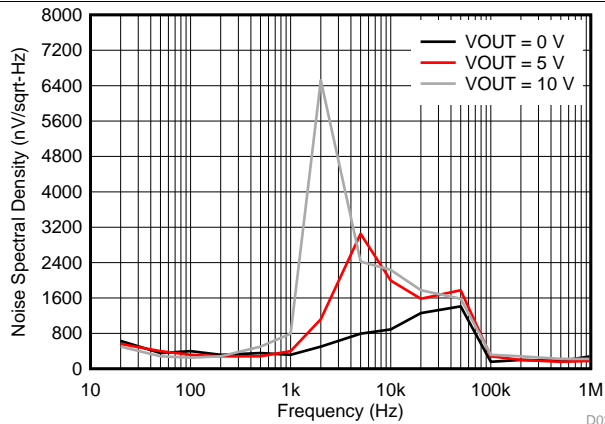

Figure 30. VOUT Noise Spectral Density (DC/DC Enabled)

D027

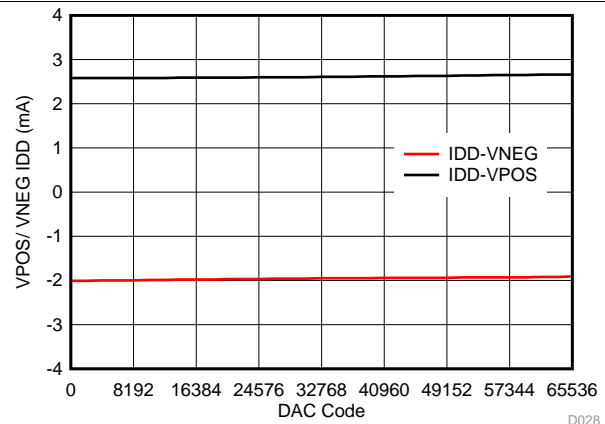
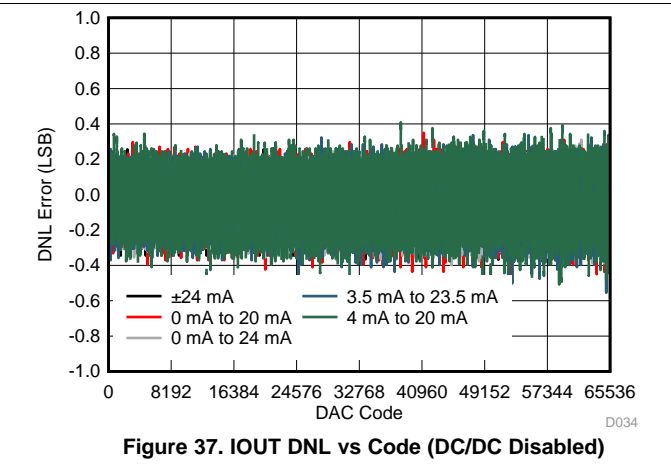
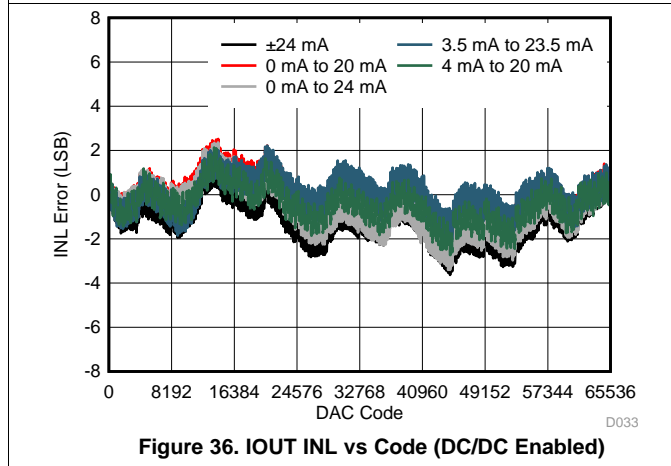
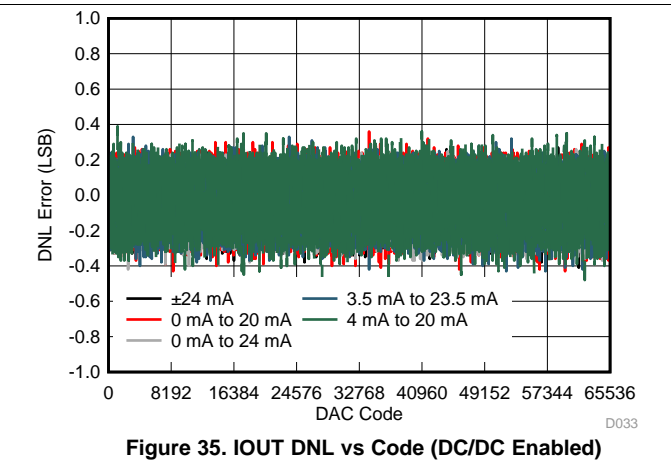
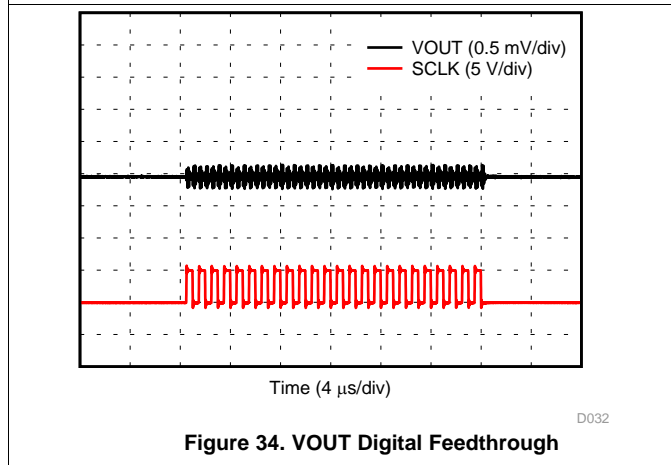
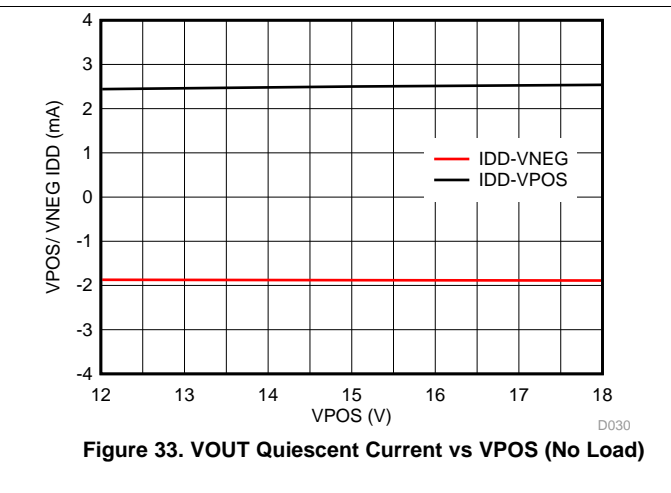
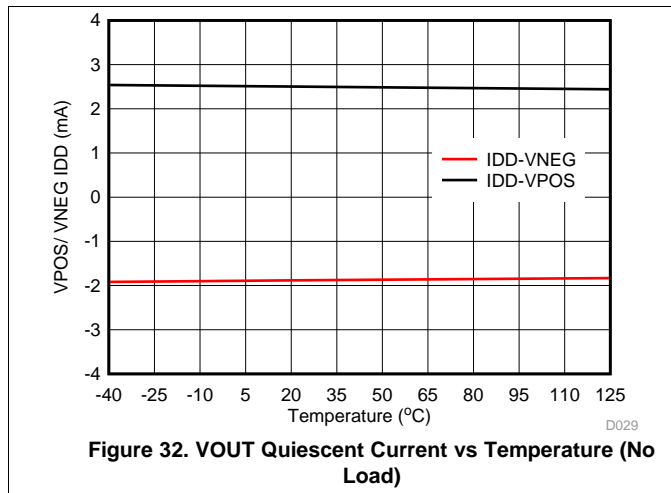

Figure 31. VOUT Quiescent Current vs Code (No Load)

D028

Typical Characteristics (continued)



Typical Characteristics (continued)

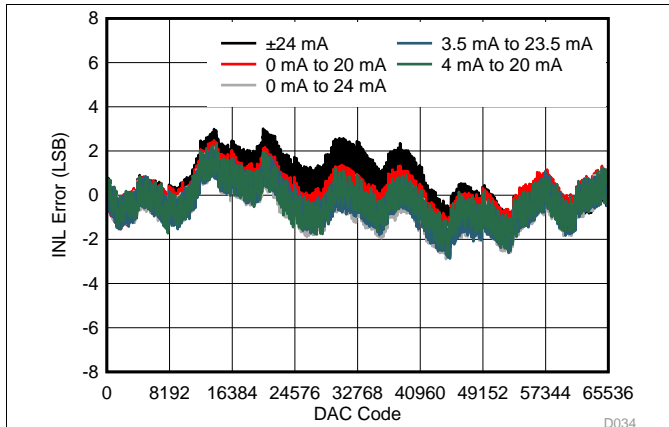

Figure 38. IOUT INL vs Code (DC/DC Disabled)

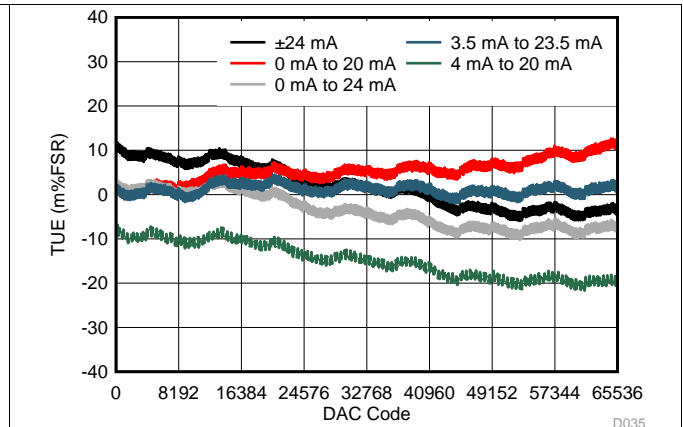

Figure 39. IOUT TUE vs Code (DC/DC Enabled)

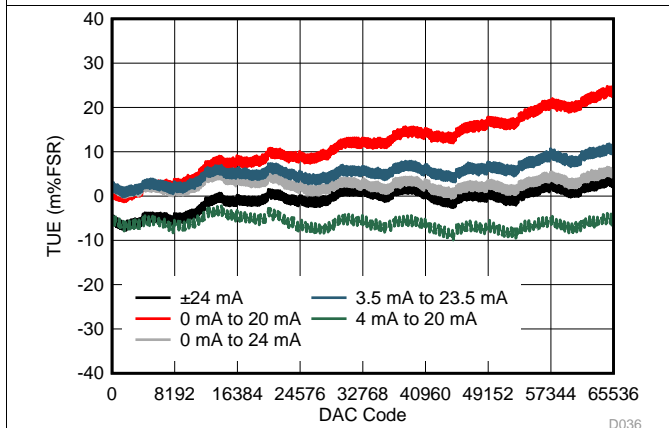

Figure 40. IOUT TUE vs Code (DC/DC Enabled)

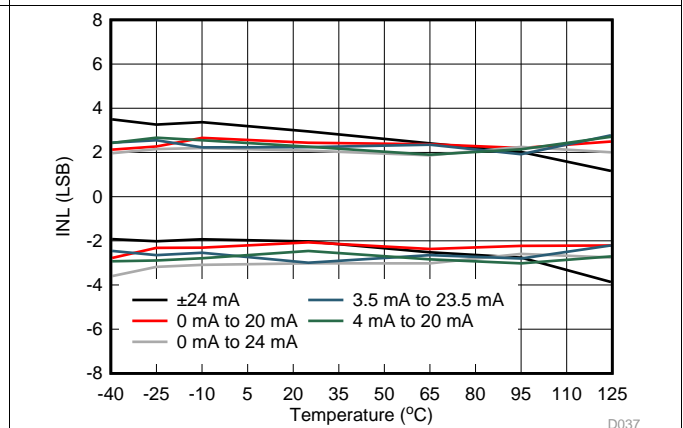

Figure 41. IOUT INL vs Temperature

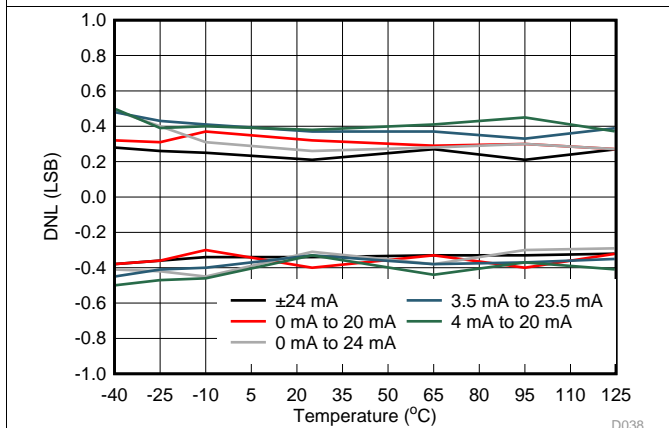

Figure 42. IOUT DNL vs Temperature

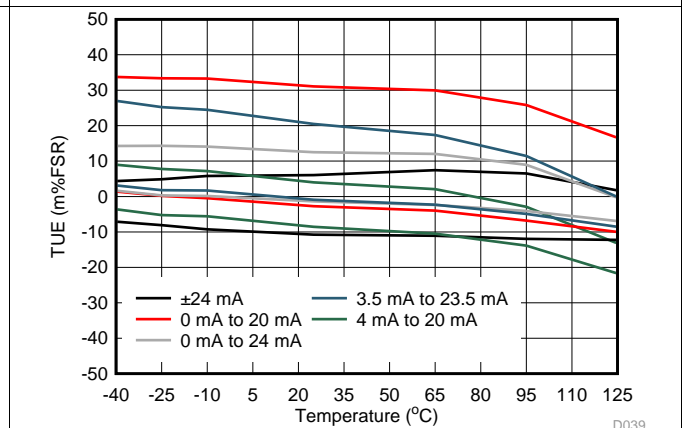

Figure 43. IOUT TUE vs Temperature

Typical Characteristics (continued)

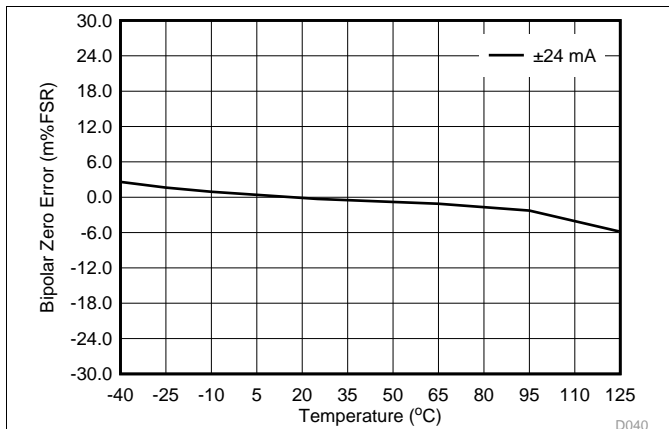

Figure 44. IOUT Bipolar Zero Error vs Temperature

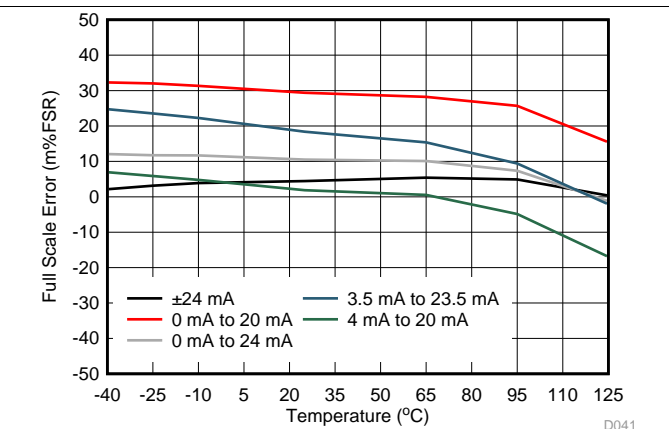

Figure 45. IOUT Full-Scale Error vs Temperature

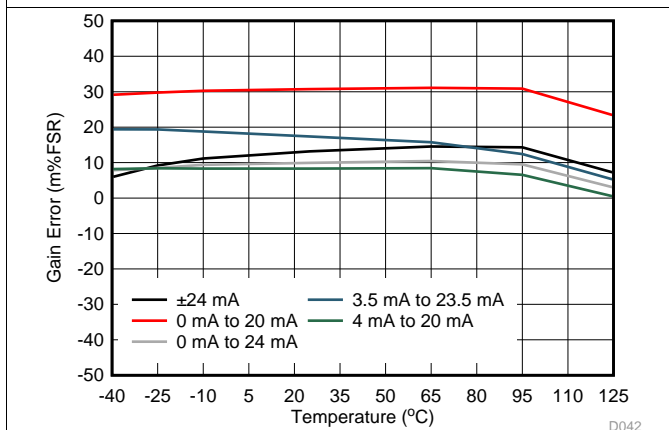

Figure 46. IOUT Gain Error vs Temperature

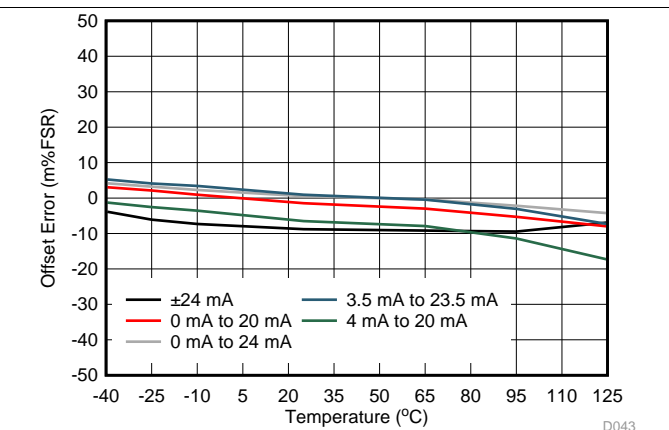

Figure 47. IOUT Offset Error vs Temperature

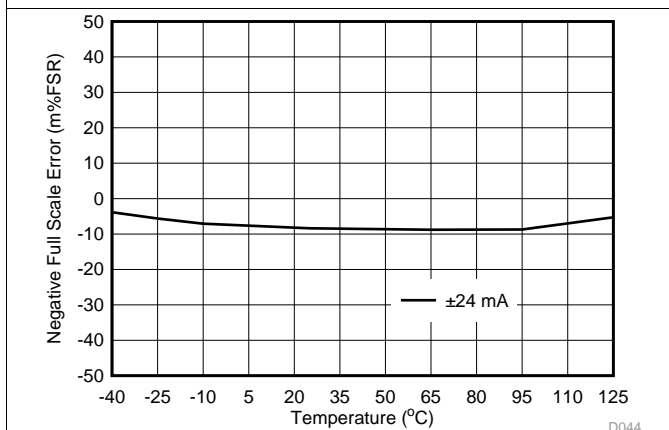

Figure 48. IOUT Negative Full-Scale Error vs Temperature

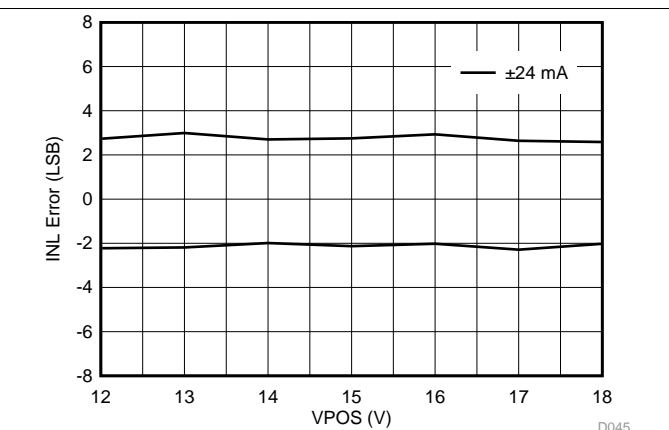

Figure 49. IOUT Bipolar Range INL vs VPOS

Typical Characteristics (continued)

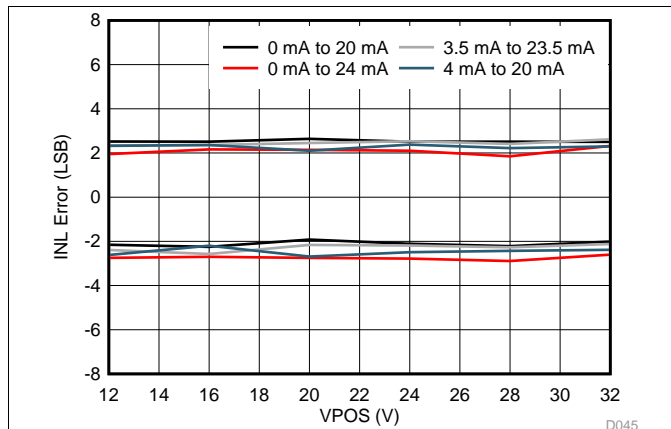

Figure 50. IOUT Unipolar Ranges INL vs VPOS

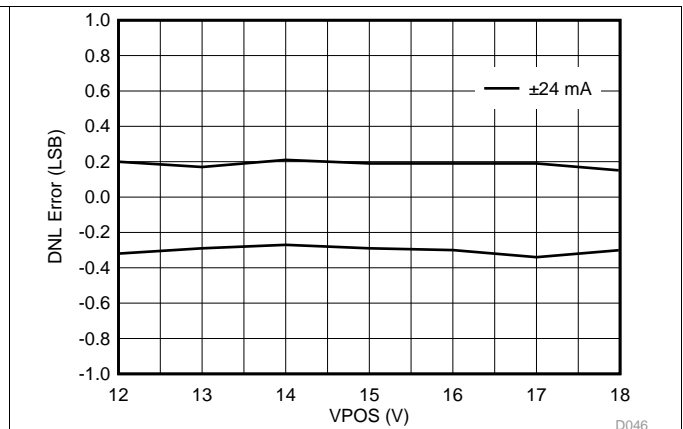

Figure 51. IOUT Bipolar Range DNL vs VPOS

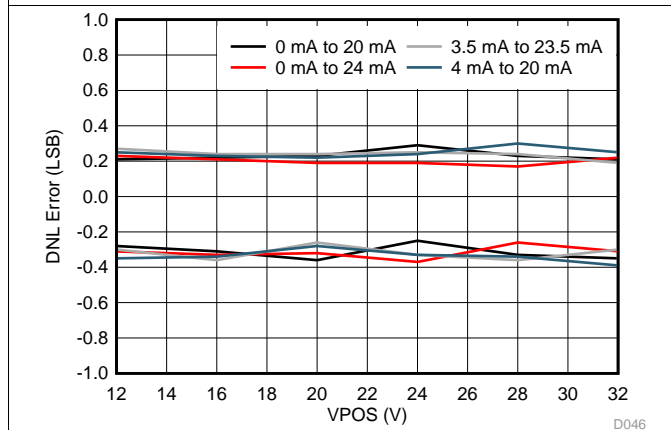

Figure 52. IOUT Unipolar Ranges DNL vs VPOS

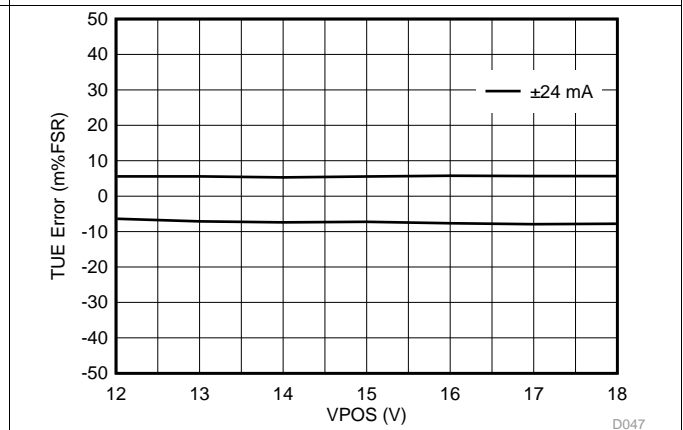

Figure 53. IOUT Bipolar Range TUE vs VPOS

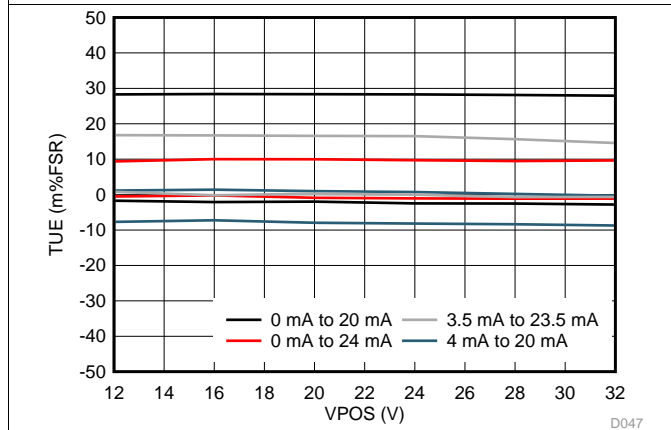

Figure 54. IOUT Unipolar Ranges TUE vs VPOS

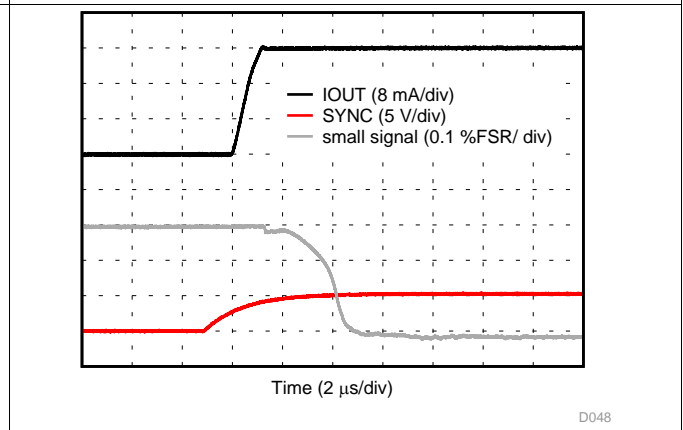
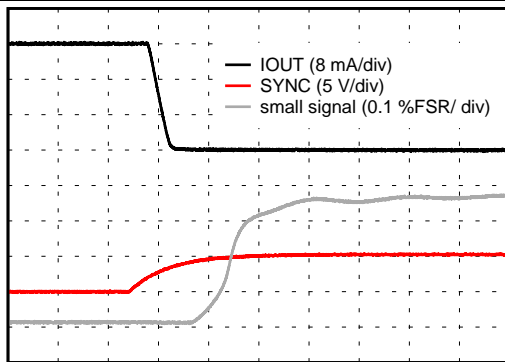

Figure 55. IOUT Settling Time, Rising Signal

Typical Characteristics (continued)



Time (2 μs/div)

D049

Figure 56. IOUT Settling Time, Falling Signal

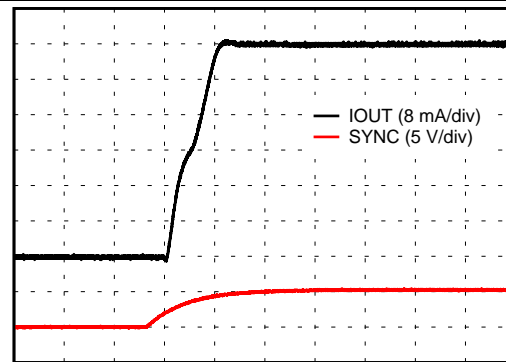

Time (2 μs/div)

D050

Figure 57. IOUT Settling Time, Bipolar Range, Rising Signal

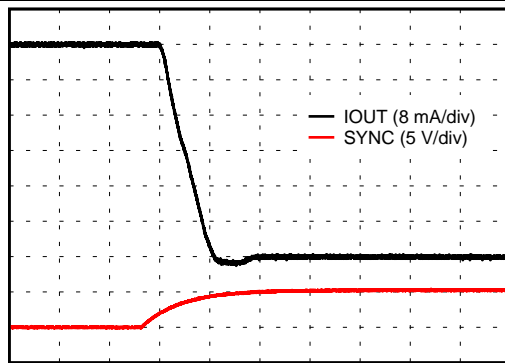

Time (2 μs/div)

D051

Figure 58. IOUT Settling Time, Bipolar Range, Falling Signal

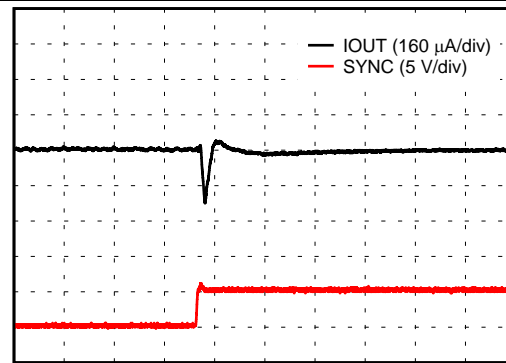

Time (800 ns/div)

D053

Figure 59. IOUT Major Carry Glitch, Positive

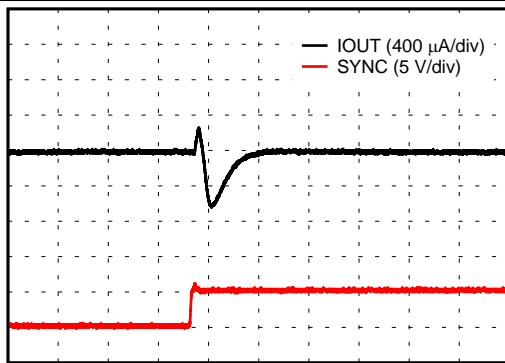

Time (800 ns/div)

D054

Figure 60. IOUT Major Carry Glitch, Negative

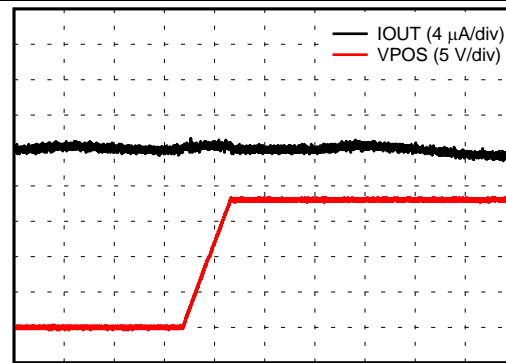

Time (1 ms/div)

D055

Figure 61. IOUT Power On Glitch

Typical Characteristics (continued)

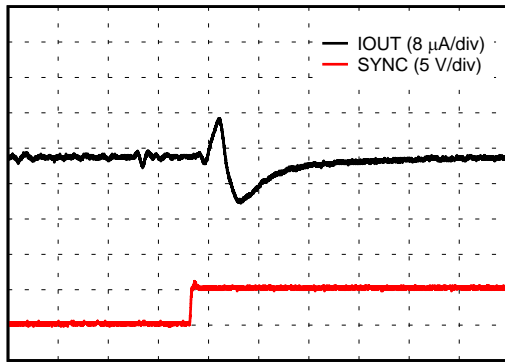

Figure 62. IOOUT Output Enable Glitch

D056

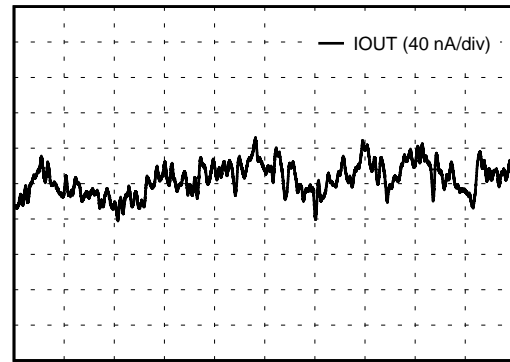

Figure 63. IOOUT Noise (DC/DC Disabled)

D057

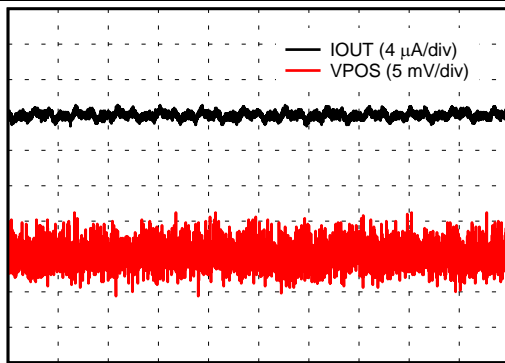

Figure 64. IOOUT DC/DC Ripple (50kHz First-Order Low-Pass Filter)

D058

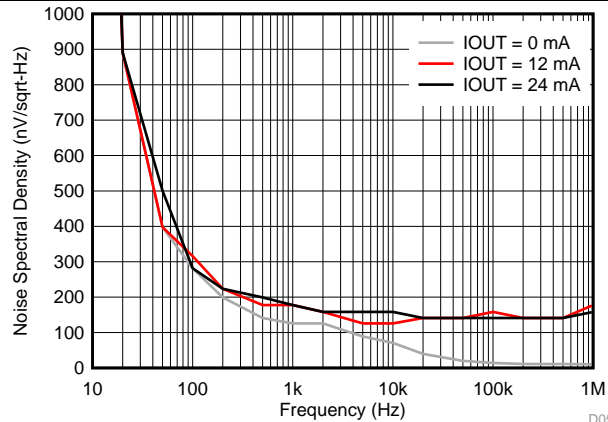

Figure 65. IOOUT Noise Spectral Density (DC/DC Disabled)

D059

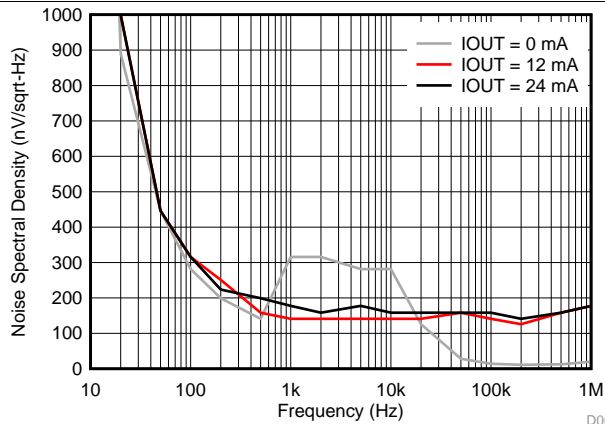

Figure 66. IOOUT Noise Spectral Density (DC/DC Enabled)

D060

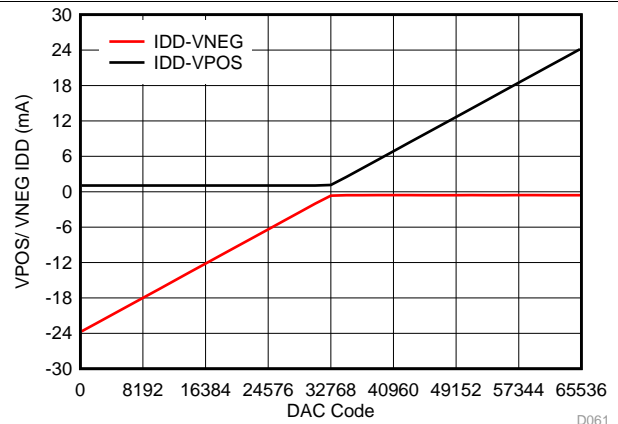

Figure 67. IOOUT Quiescent Current vs Code, Bipolar Range

D061

Typical Characteristics (continued)

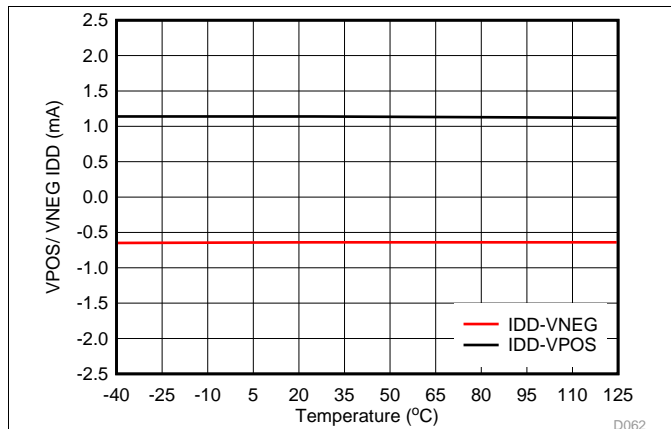

Figure 68. IOUT Quiescent Current vs Temperature

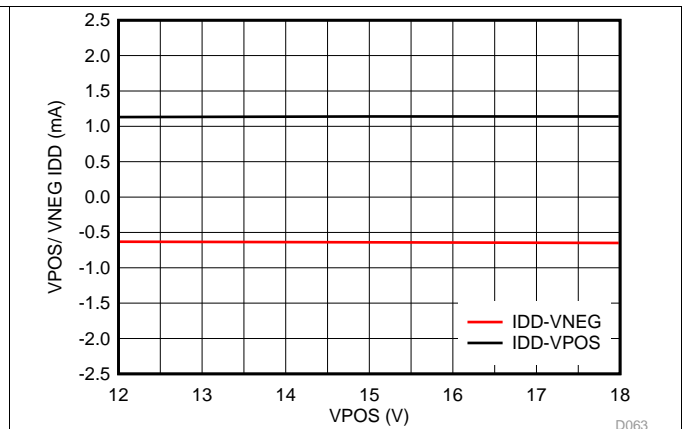

Figure 69. IOUT Quiescent Current vs VPOS

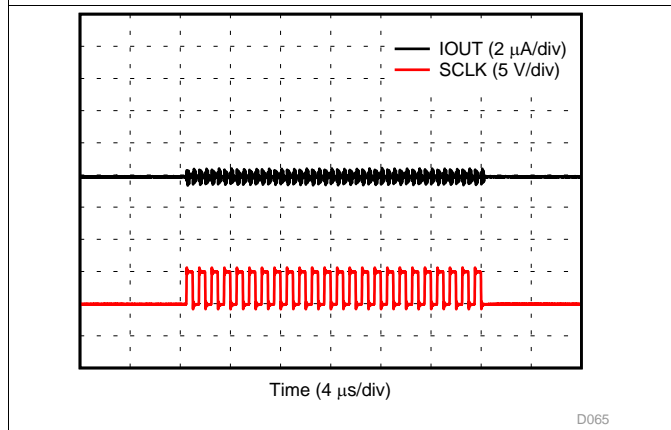

Figure 70. IOUT Digital Feed-Through

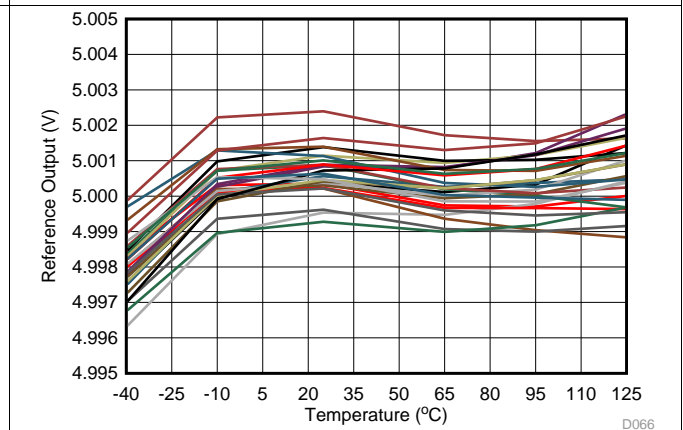

Figure 71. Internal Reference Voltage vs Temperature

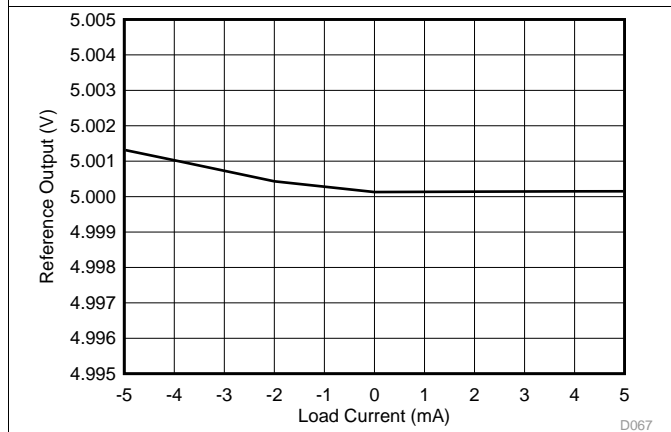

Figure 72. Internal Reference Voltage vs Load

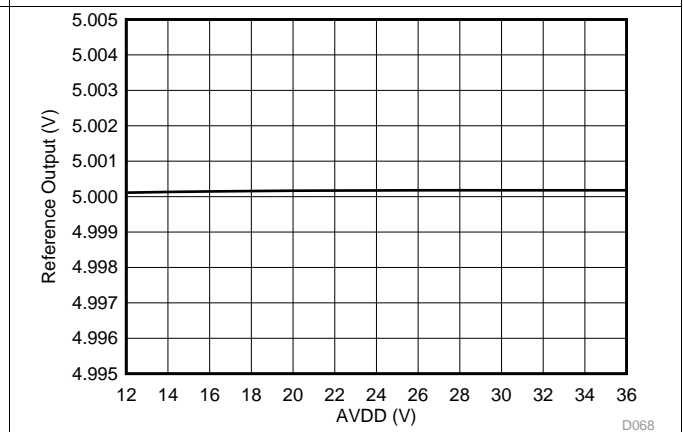

Figure 73. Internal Reference Voltage vs AVDD

Typical Characteristics (continued)

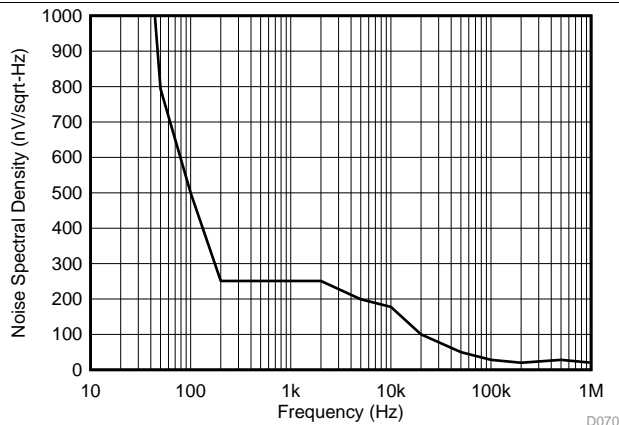

Figure 74. Internal Reference Voltage Noise Spectral Density (DC/DC Disabled)

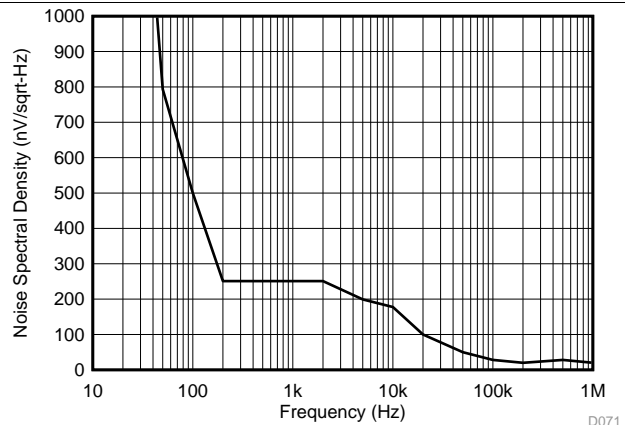

Figure 75. Internal Reference Voltage Noise Spectral Density (DC/DC Enabled)

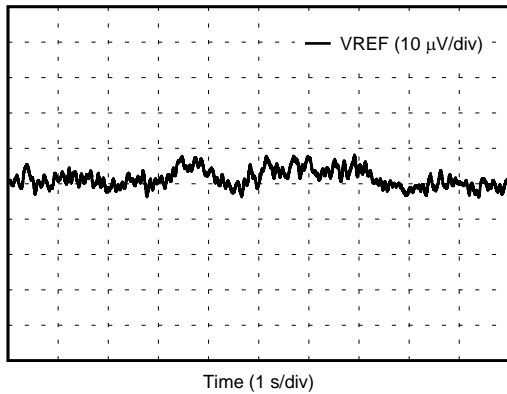

Figure 76. Internal Reference Voltage Noise (DC/DC Disabled)

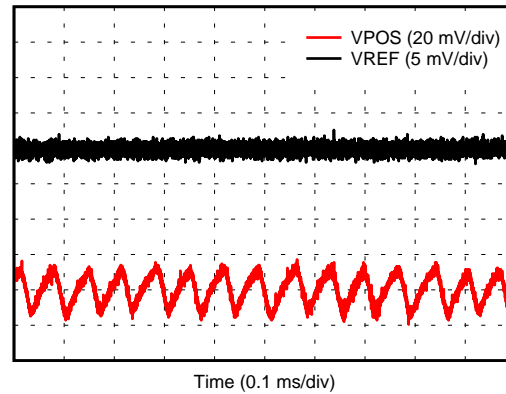

Figure 77. Internal Reference Voltage DC/DC Ripple

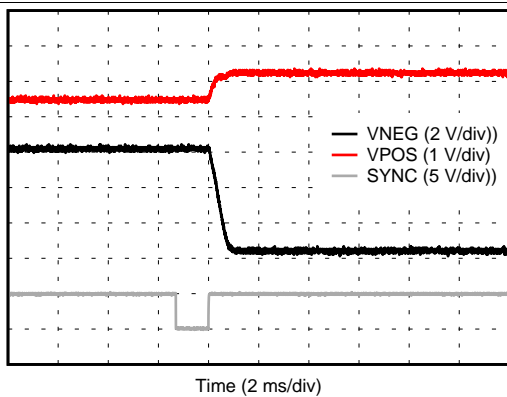

Figure 78. VPOS & VNEG Enable Settling Time

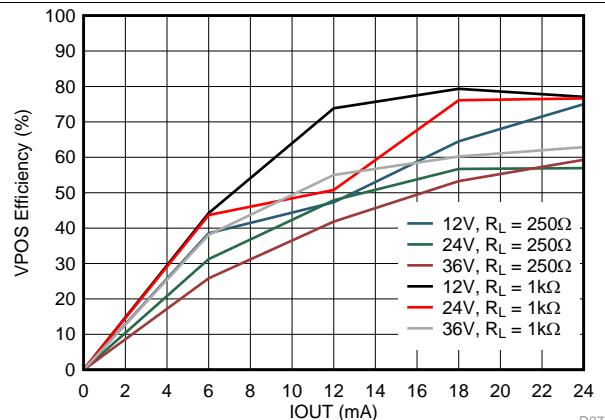

Figure 79. IOUV VPOS Efficiency

Typical Characteristics (continued)

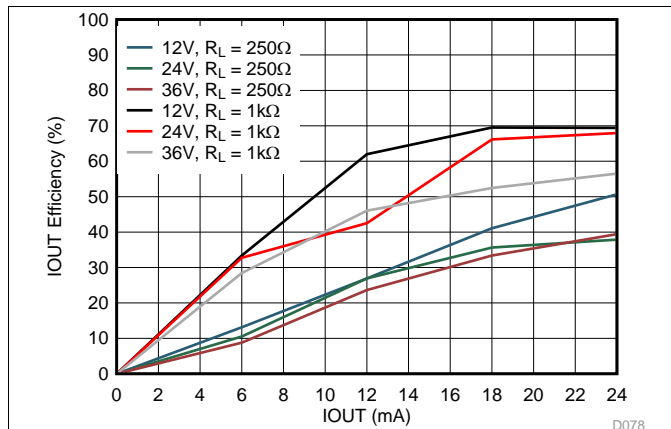

Figure 80. IOUT DC/DC Efficiency

D078

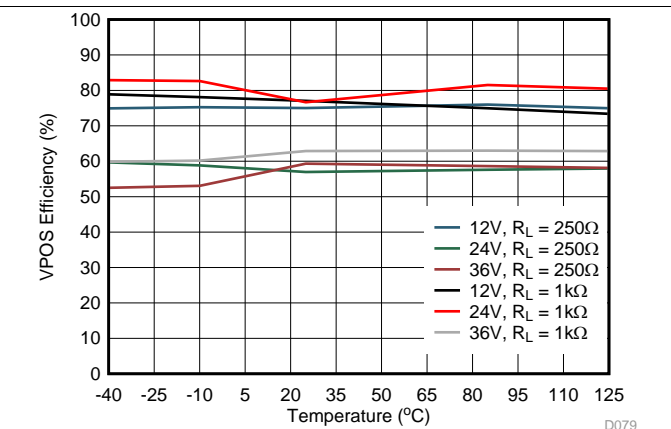

Figure 81. VPOS Efficiency vs Temperature

D079

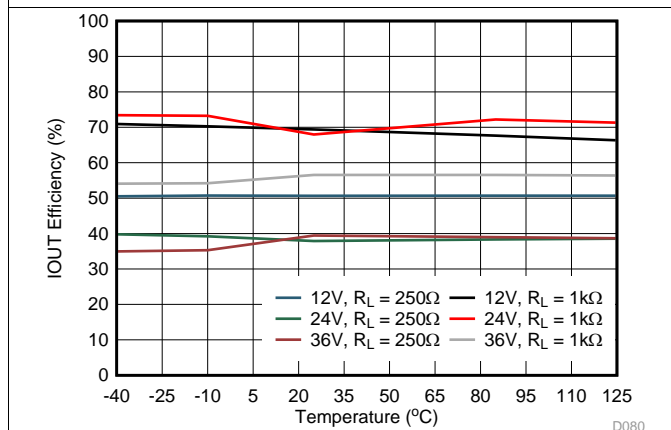

Figure 82. IOUT DC/DC Efficiency vs Temperature

D080

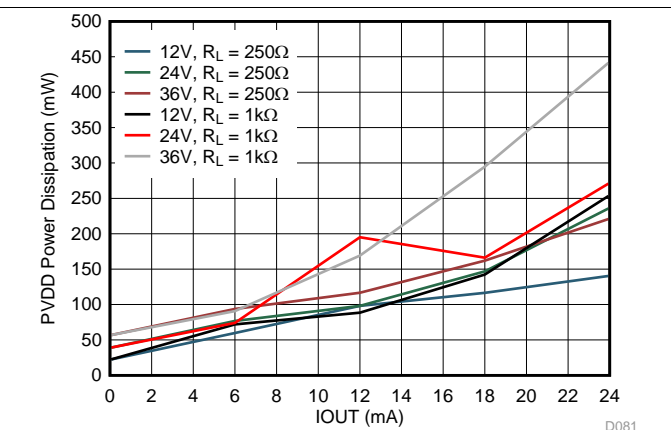

Figure 83. IOUT Power Dissipation vs Load

D081

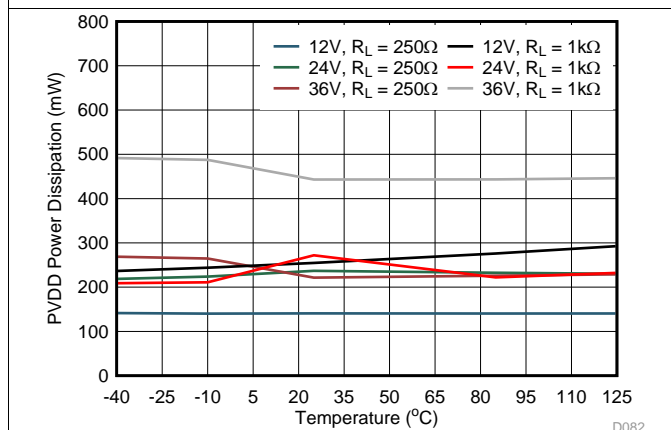

Figure 84. IOUT Power Dissipation vs Temperature

D082

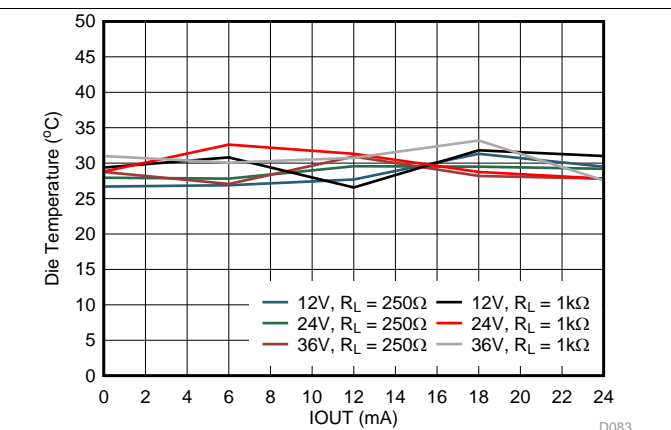

Figure 85. IOUT Die Temperature vs Load

D083

Typical Characteristics (continued)

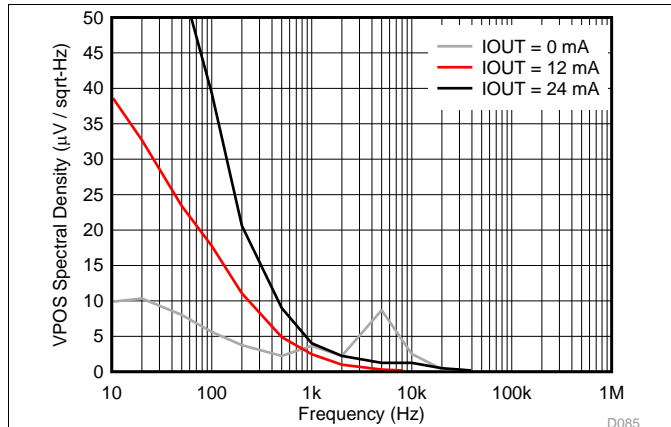

Figure 86. IOUT VPOS Noise Spectral Density

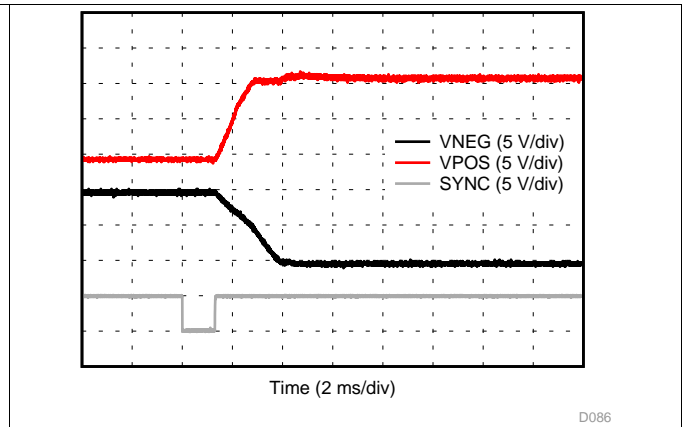

Figure 87. VOUT Enable VPOS and VNEG Settling Time

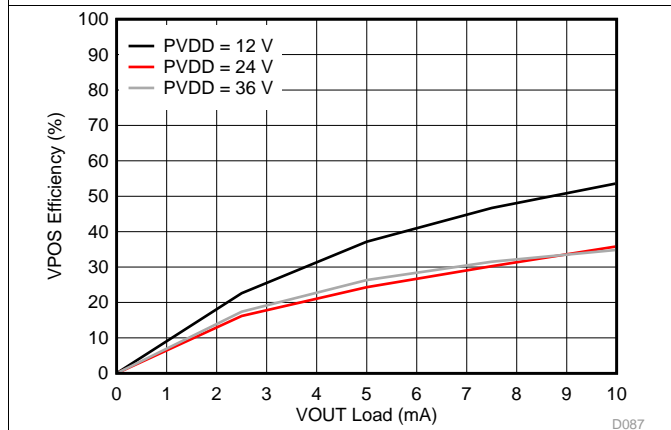

Figure 88. VOUT VPOS Efficiency vs Load

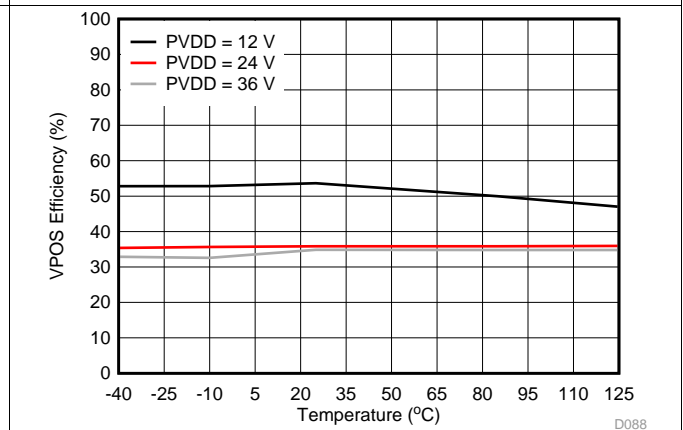

Figure 89. VOUT VPOS Efficiency vs Temperature

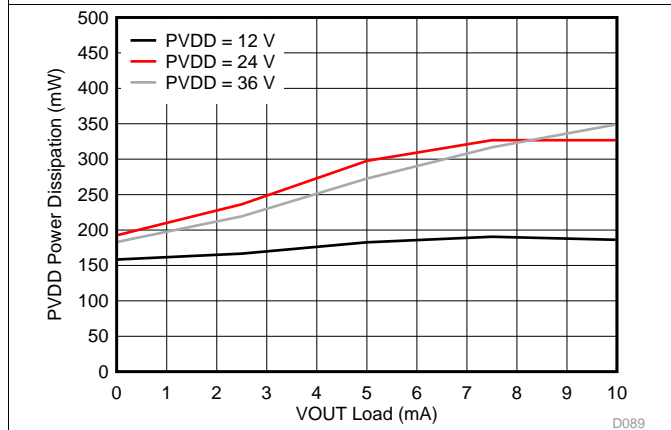

Figure 90. VOUT Power Dissipation vs Load

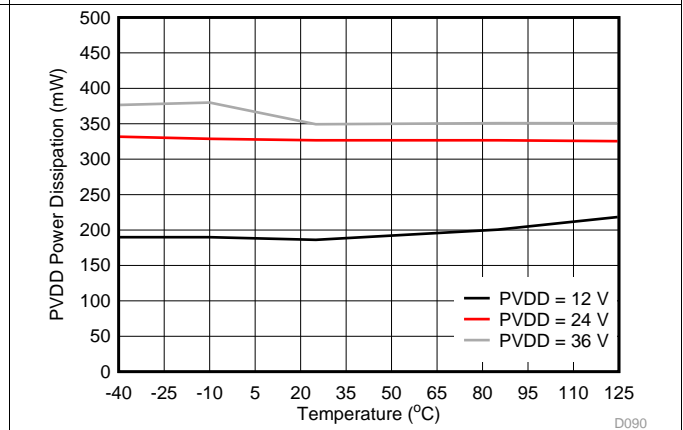

Figure 91. VOUT Power Dissipation vs Temperature

Typical Characteristics (continued)

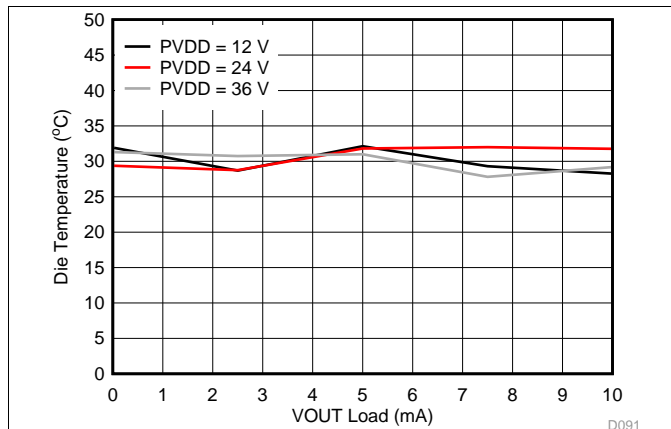

Figure 92. VOUT Die Temperature vs Load

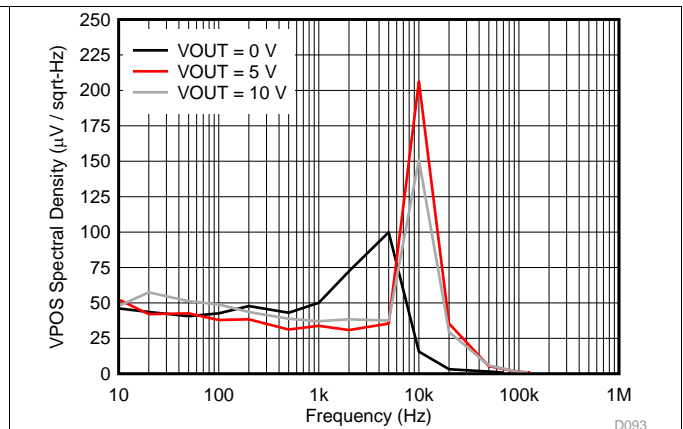

Figure 93. VOUT VPOS Noise Spectral Density

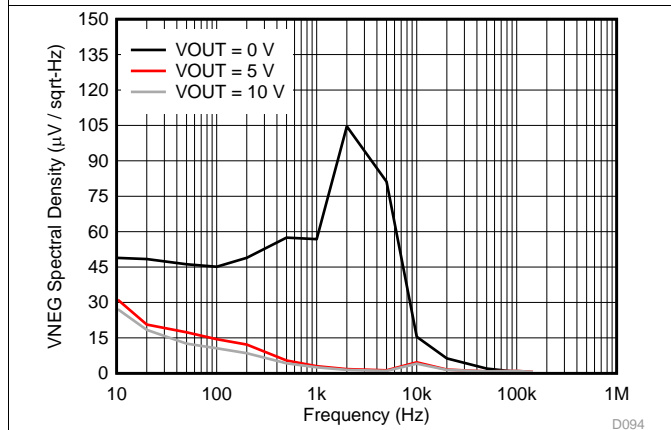

Figure 94. VPOS VNEG Noise Spectral Density

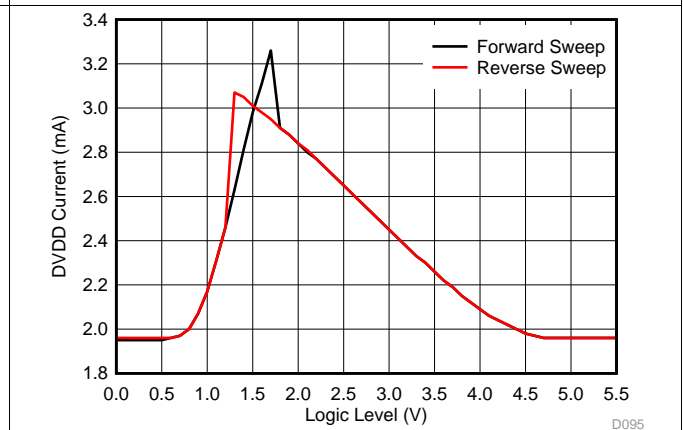

Figure 95. DVDD Iq vs Logic Level

8 Detailed Description

8.1 Overview

The DAC8771 consists of a resistor-string digital-to-analog converter (DAC) followed by buffer amplifiers. The output of the buffer drives the current output stage and the voltage output amplifier. The resistor-string section is simply a string of resistors, each of value R, from REFIN to GND, as [Functional Block Diagram](#) illustrates. This type of architecture ensures DAC monotonicity. The 16-bit binary digital code loaded to the DAC register determines at which node on the string the voltage is tapped off before being fed into the output amplifier. The current output stage converts the output from the string to current using a precision current source. The voltage output provides a voltage output to the external load. When the current output stage is disabled the IOOUT pin is Hi-Z. When the voltage output stage is disabled, the output impedance is controlled by the POC bit, by default set to 30 kΩ. After power-on, both output stages are disabled. The DAC8771 also contains a Buck-Boost converter which can be used to generate the power supply for the current output stage and voltage output amplifier.

8.2 Functional Block Diagram

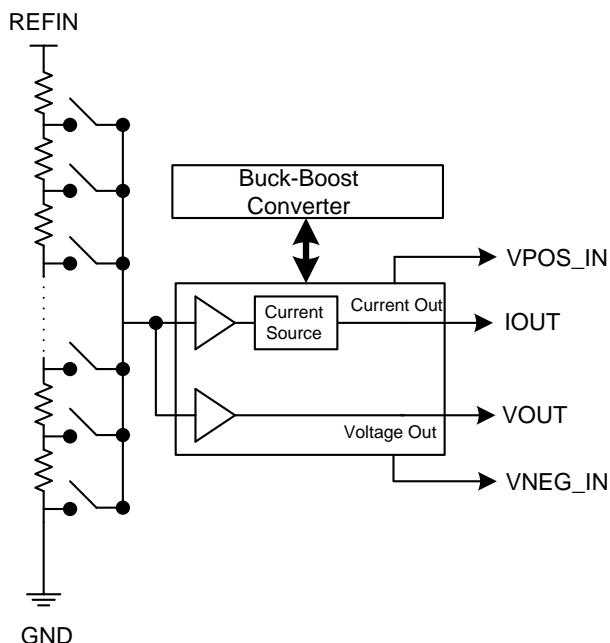

Copyright © 2018, Texas Instruments Incorporated

Figure 96. General Architecture

8.3 Feature Description

8.3.1 Current Output Stage

The current output stage consists of a pre-conditioner and a precision current source as shown in [Figure 97](#). This stage provides a current output according to the DAC code. The output range can be programmed as 0 mA - 20 mA, 0 mA - 24 mA, 4 mA - 20 mA, 3.5 mA - 23.5 mA, or ± 24 mA. In the current output mode, the maximum compliance voltage on pin IOOUT is between $(-|VNEG_IN| + 3\text{ V}) \leq |V_{IOOUT}| \leq (VPOS_IN - 3\text{ V})$. When in unipolar current output modes the low-side of the compliance voltage limit is replaced by GND. This compliance voltage is automatically maintained when the Buck-Boost converter is used to generate these supplies (see Buck-Boost Converter section). However, when using an external supply for VPOS_IN pin (Buck-Boost converter disabled), the VPOS_IN and VNEG_IN supplies should be chosen such that this compliance voltage is maintained.

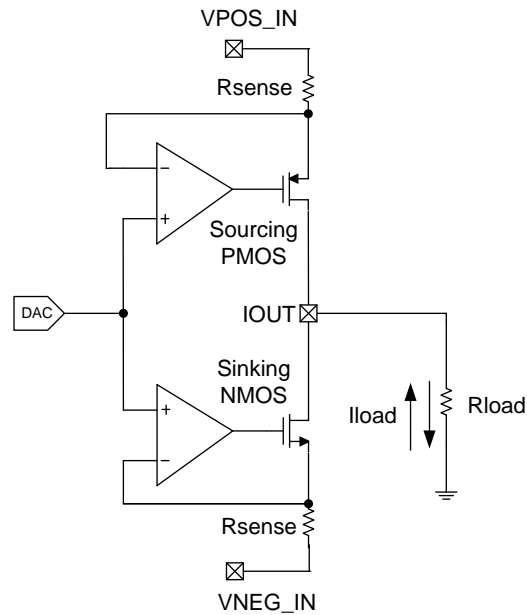
Feature Description (continued)

Copyright © 2018, Texas Instruments Incorporated

Figure 97. Current Output

The 16 bit data can be written to DAC8771 using address 0x05 (DAC data register, [Table 4](#) and [Table 5](#)).

For a 0-mA to 20-mA output range:

$$I_{OUT} = 20mA \times \left[\frac{CODE}{2^N} \right] \quad (1)$$

For a 0-mA to 24-mA output range:

$$I_{OUT} = 24mA \times \left[\frac{CODE}{2^N} \right] \quad (2)$$

For a 3.5-mA to 23.5-mA output range:

$$I_{OUT} = 20mA \times \left[\frac{CODE}{2^N} \right] + 3.5mA \quad (3)$$

For a 4-mA to 20-mA output range:

$$I_{OUT} = 16mA \times \left[\frac{CODE}{2^N} \right] + 4mA \quad (4)$$

For a -24-mA to 24-mA output range:

$$I_{OUT} = 40mA \times \left[\frac{CODE}{2^N} \right] - 20mA \quad (5)$$

Where:

- *CODE* is the decimal equivalent of the code loaded to the DAC.
- *N* is the bits of resolution; 16

Feature Description (continued)

8.3.2 Voltage Output Stage

The voltage output stage as conceptualized in [Figure 98](#) provides the voltage output according to the DAC code and the output range setting. The output range can be programmed as 0 V to +5 V or 0 V to +10 V for unipolar output mode, and ± 5 V or ± 10 V for bipolar output mode. In addition, an option is available to increase the output voltage range by 20%. The output current drive can be up to 34 mA. The output stage has short-circuit current protection that limits the output current to 16 mA, this limit can be changed to 8 mA, 20 mA or 24 mA via writing bits 15 and 14 of address 0x04. The minimum headroom and foot-room for the voltage output stage is automatically maintained when the Buck-Boost converter is used to generate these supplies. However, when using an external supply for VPOS_IN and VNEG_IN pin (Buck-Boost converter disabled) the minimum headroom and foot-room as per must be maintained. In this case, the [Recommended Operating Conditions](#) shows the maximum allowable difference between VPOS_IN and VNEG_IN.

The voltage output is designed to drive capacitive loads of up to 1 μ F. For loads greater than 20 nF, an external compensation capacitor must be connected between CCOMP and VOUT to keep the output voltage stable at the expense of reduced bandwidth and increased settling time. Note that, a step response (due to input code change) on the voltage output pin loaded with large capacitive load (> 20 nF) triggers the short circuit limit circuit of the output stage. This results in setting the short circuit alarm status bits. Therefore, it is recommended to use slew rate control for large step change, when the voltage output pin is loaded with high capacitive loads.

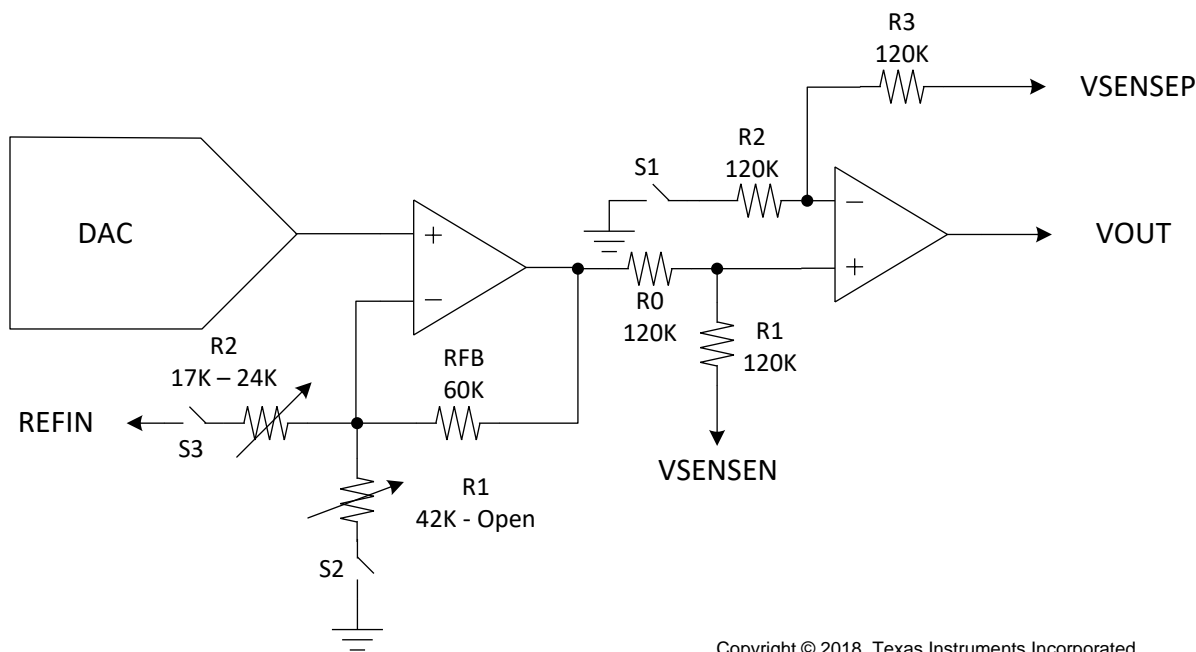

Copyright © 2018, Texas Instruments Incorporated

Figure 98. Voltage Output

The VSENSE pin is provided to enable sensing of the load. Ideally, it is connected to VOUT at the terminals. Additionally, it can also be used to connect remotely to points electrically "nearer" to the load. This allows the internal output amplifier to ensure that the correct voltage is applied across the load as long as headroom is available on the power supply. However, if this line is cut, the amplifier loop would be broken. Therefore, an optional resistor can be used between VOUT and VSENSE to prevent this.

The VSENSE pin can be used to sense the remote ground and offset the VOUT pin accordingly. The VSENSE pin can sense a maximum of ± 7 V difference from the GND pin of the DAC8771.

The 16 bit data can be written to DAC8771 as shown in DAC data registers, [Table 4](#) and [Table 5](#).

For unipolar output mode:

$$VOUT = VREFIN \times GAIN \times \left[\frac{CODE}{2^N} \right] \quad (6)$$

Feature Description (continued)

For bipolar output mode:

$$VOUT = VREFIN \times GAIN \times \left[\frac{CODE}{2^N} \right] - \frac{GAIN \times VREFIN}{2} \tag{7}$$

Where:

- *CODE* is the decimal equivalent of the code loaded to the DAC.
- *N* is the bits of resolution; 16
- *VREFIN* is the reference voltage; for internal reference, *VREFIN* = +5 V.
- *GAIN* is automatically selected for a desired voltage output range as shown in

8.3.3 Buck-Boost Converter

The DAC8771 includes a Buck-Boost Converter to minimize the power dissipation of the chip and provides significant system integration. This Buck-Boost converter is based on a Single Inductor Multiple Output (SIMO) architecture and requires a single inductor to simultaneously generate all the analog power supplies required by the chip. The Buck-Boost converter uses three on-chip switches (shown in [Figure 99](#)) which are synchronously controlled via current mode control logic. The DC/DC converter is designed to work in discontinuous conduction mode (DCM) with an external inductor of value 100 μH connected between LN and LP pins (see [Buck-Boost Converter External Component Selection](#) section). The peak inductor current internally is limited to a value of 0.5 A internally.

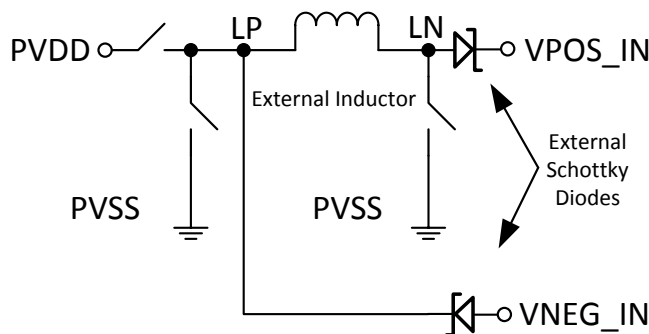

Figure 99. Buck-Boost Converter

The Buck-Boost converter employs a variable switching frequency technique. This technique increases the converter efficiency at all loads by automatically reducing the switching frequency at light loads and increasing it at heavy loads. At no load condition, the converter stops switching completely until the load capacitor discharges by a preset voltage. At this point, the converter automatically starts switching and recharges the load capacitor(s). In addition to saving power at all loads, this technique ensures low switching noise on the converter outputs at light loads. The minimum load capacitor for the Buck-Boost converter is 10 μF. This capacitor must be connected between the Schottky diode(s) and ground (0 V) for each arm of the Buck-Boost converter. The Buck-Boost converter, when enabled, generates ripples on the supply pins (VPOS_IN and VNEG_IN). This ripple is typically attenuated by the power supply rejection ratio of the output amplifiers (IOUT or VOUT) and appears as noise on the output pin of the amplifiers (IOUT and VOUT). A larger load capacitor in combination with additional filter (see application section) reduces the output ripple at the expense of increasing settling time of the converter output.

The input voltage to the Buck-Boost converter (pin PVDD) can vary from +12 V to +36 V. These outputs can be individually enabled or disabled via the user SPI interface (See Commands in [Table 4](#) and [Table 5](#)).

8.3.3.1 Buck-Boost Converter Outputs

The Buck-Boost converter can be used to provide power to the current output stage or the voltage output stage by enabling the Buck-Boost converter and connecting the power supplies as shown in [Figure 100](#). Additional passive filters can optionally be added between the Schottky diode and input supply pins (VPOS_IN and VNEG_IN) to attenuate the ripple feeding into the VPOS_IN and VNEG_IN pin.

Feature Description (continued)

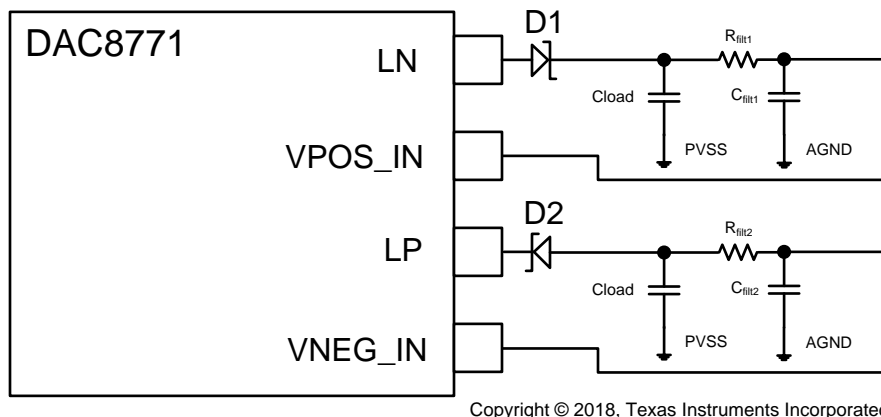

Figure 100. Buck-Boost Converter Positive and Negative Outputs

8.3.3.2 Selecting and Enabling Buck-Boost Converter

The analog outputs of the Buck-Boost converter can be enabled in two different ways: Current Output Mode or Voltage Output Mode. The positive/negative arm of the selected Buck-Boost converter can be enabled via writing to address 0x07 ([Configuration Buck-Boost Register \(address = 0x07\) \[reset = 0x0000\]](#)). Note that, VNEG_IN is internally shorted to GND when the negative arm of Buck-Boost converter is not enabled.

When used in voltage output mode, the Buck-Boost converter generates a constant ± 15.0 V for the positive and negative power supplies.

When used in current output mode the Buck-Boost converter generates the positive and negative power supply based on the RANGE setting, for example the negative power supply is only generated for ± 24 mA range.

The minimum voltage that the Buck-Boost converter can generate on the VPOS_IN pin in 4.96 V with a typical efficiency of 75% at PVDD = 12 V and a load current of 24 mA, thus significantly minimizing power dissipation on chip. The maximum voltage that the Buck-Boost converter can generate on the VPOS_IN pin is 32 V. Similarly, the minimum voltage that the Buck-Boost converter can generate on the VNEG_IN pin in -15.0 V. The maximum voltage that the Buck-Boost converter can generate on the VNEG_IN pin in -5.0 V

8.3.3.3 Configurable Clamp Feature and Current Output Settling Time

A large signal step on the output pin IOOUT (for example 0 mA to 24 mA) with a load of 1 K Ω would require that the respective Buck-Boost converter change the output voltage on the VPOS_IN pin from 4.0 V to 27 V. Thus, the current output settling time will be dominated by the settling time of the VPOS_IN voltage. A trade off can be made to reduce the settling time at the expense of power saving by increasing the minimum voltage that the respective Buck-Boost converter generates on the positive output.

The DAC8771 implements a configurable clamp feature. This feature allows multiple modes of operation based on CCLP[1:0] and HSCLMP bits ([Configuration Buck-Boost Register \(address = 0x07\) \[reset = 0x0000\]](#)).

8.3.3.3.1 Default Mode - CCLP[1:0] = "00"

This is the default mode of operation, CCLP[1:0] = "00" for Buck-Boost converter is to be in full tracking mode. The minimum voltage generated on VPOS_IN in this case is 4 V. The Buck-Boost converter varies the positive and negative outputs adaptively such that the voltage across these outputs and IOOUT pins is ≤ 3 V. This is accomplished by internally feeding back the voltage across the current output PMOS and NMOS to the respective Buck-Boost converter control circuit. For example, for a load current of 24 mA flowing through a load resistance of 1 K Ω , the generated voltage at the VPOS_IN pin will be around 27V.

8.3.3.3.2 Fixed Clamp Mode - CCLP[1:0] = "01"

In this mode of operation, the user can over-rides the default operation by writing "01" to CCLP[1:0]. The minimum voltage generated on VPOS_IN and VNEG_IN can be adjusted by writing to PCLMP[3:0] / NCLMP[3:0] (address 0x07).

Feature Description (continued)

8.3.3.3.3 Auto Learn Mode - CCLP[1:0] = "10"

In this mode, the device automatically senses the load on the current output terminal and sets the minimum voltage generated on VPOS_IN terminals to a fixed value. The value is calculated such that for any code change, the settling time is dependent only on the DAC settling time. For example, with a load of 250 Ω and a maximum current of 24 mA, the Buck-Boost output voltage is set as 9 - 12 V. This achieves the maximum power saving without sacrificing settling time because the Buck-Boost output is fixed.

In order to ensure the correct operation of auto-learn mode, following steps below must be followed.

1. The device must be enabled in full tracking mode, CCLP[1:0] = "00".
2. Current output is enabled and a code greater than 4000h should be written to the DAC.
3. Write CCLP[1:0] = "10" to enable auto learn mode.

At this point, the clamp register (PCLMP - address 0x07) is populated with the appropriate settings. The clamp status bit CLST (address 0x0B) is set once the clamp register is populated indicating the completion of this process. In this mode the PCLMP bits are read only. Typically, this process of sensing the load is done only once after power up. In order to re initiate this process, the CCLP bits must be rewritten with "10".

8.3.3.3.4 High Side Clamp (HSCLMP)

The default maximum positive voltage that the Buck-Boost converter can generate is 32 V. However, this voltage can be reduced to 26 V by writing '1' to HSCLMP bit (address 0x0E [Table 5](#)). Note that this feature can be enabled or disabled per channel by selecting the corresponding channel (address 0x03)

8.3.4 Analog Power Supply

The DAC8771 is designed to operate with a single power supply (12 V to 36 V) using integrated Buck-Boost converter. In this mode, pins PVDD and AVDD must be tied together and driven by the same power supply. VPOS_IN and VNEG_IN will be enabled as programmed by the device registers. It is recommended that DVDD is applied first to reduce output transients.

The DAC8771 can also be operated without using the integrated Buck-Boost converter. In this mode, pins PVDD, AVDD, and VPOS_IN must be tied together and driven by the same power supply (12 V to 33 V). In this mode in order to reduce output transients it is recommended that DVDD is applied first, followed by VPOS_IN / PVDD / AVDD and finally REFIN. Note that in this mode, the minimum required head room and foot room for the output amplifiers must be met.

[Recommended Operating Conditions](#) shows the maximum and minimum allowable limits for all the power supplies when DAC8771 is powered using external power supplies.

8.3.5 Digital Power Supply

The digital power supply to DAC8771 can be internally generated or externally supplied. This is determined by the status of DVDD_EN pin.

When the DVDD_EN pin is left floating, the voltage on DVDD pin is generated via an internal LDO. The typical value of the voltage generated on DVDD pin is 5 V. In this mode, the DVDD pin can also be used to power other digital components on the board. The maximum drive capability of this pin is 10mA. Please note that to ensure stability the minimum load capacitance on this pin is limited to 100 pF, where as the maximum load capacitance is limited to 0.2 μ F.

When the DVDD_EN pin is tied to 0V, the internal LDO is disabled and the DVDD pin must be powered via an external digital supply.

8.3.6 Internal Reference

The DAC8771 includes an integrated 5V reference with an initial accuracy of ± 10 mV maximum and a temperature drift coefficient of 10 ppm/ $^{\circ}$ C maximum. A buffered output capable of driving up to 5 mA is available on REFOUT. The internal reference for DAC8771 is disabled by default. To enable the internal reference, REF_EN bit on address 0x02h must be set to '1' ([Table 5](#)).

Feature Description (continued)

It is recommended to follow JEDEC standardized solder reflow parameters for surface mount devices, as is typically provided by most contract PCB assembly services. Failure to adhere to suggested JEDEC standards can result in excessively high temperatures in the solder process or excessive time exposed to high temperatures, which can induce mechanical stress on thin-packages, such as QFNs, resulting in parametric degradation in many band-gap reference topologies.

8.3.7 Power-On-Reset

The DAC8771 contain power on reset circuits which is based on AVDD and DVDD power supplies. After power-on, the power-on-reset circuit ensures that all registers are at their default values (Table 4). The current, voltage output DAC, and the Buck-Boost converter are disabled. The current output pin is in high impedance state.

The voltage output pin is in a 30kΩ-to-GND state; however, the VSENSEP pin is an open circuit. If the VOUT and VSENSEP pins are connected together, the VOUT pin would also be connected to GND through the same resistor. The VOUT pin connection to GND can be reconfigured to high-impedance through the POC bit. This resistor is disconnected when the voltage output is enabled. The Buck-Boost converter for each channel are powered off at power-on reset.

8.3.8 $\overline{\text{ALARM}}$ Pin

The DAC8771 contains an $\overline{\text{ALARM}}$ pin. When one or more of following events occur, the $\overline{\text{ALARM}}$ pin is pulled low:

1. The load on the IOUT pin is in open circuit (>500μsec); or
2. The voltage at IOUT, when enabled, reaches a level where the accuracy of the output current would be compromised (>500μsec). This condition is detected by monitoring internal voltage levels of the IOUT circuitry and will typically be below the specified compliance voltage minimum of 3V; or
3. The die temperature has exceeded +150°C; or
4. The SPI watchdog timer exceeded the timeout period (if enabled); or
5. The SPI frame error check (CRC) encountered an error (if enabled)
6. A short circuit current limit is reached (>500μsec) on any VOUT when enabled in voltage output mode
7. The Buck-Boost converter has reached the maximum output voltage (set by bit HSCLMP Table 5 address 0x0E)

When connecting the $\overline{\text{ALARM}}$ pins of multiple DAC8771 devices together, forming a wired-AND function, the host processor should read the status register of each device to know all the fault conditions that are present.

The $\overline{\text{ALARM}}$ pin continuously monitors the above mentioned conditions and returns to open drain condition if the alarm condition is removed (non-latched behavior - default). For condition (1) mentioned above and Buck-Boost converter used to power the DAC, the $\overline{\text{ALARM}}$ pin if pulled low due to the alarm condition will remain pulled low even after the alarm condition is removed (latched behavior). In this condition the alarm pin can be reset by

1. Resetting the corresponding fault bits in the status register (address 0x0B Table 5); or
2. Performing software reset (write to address 0x01 Table 5); or
3. Toggling hardware reset pin; or
4. Performing power on reset

Note that if the alarm action bits are programmed to "10" (AC_IOC[1:0]), the Buck-Boost converter and the current output amplifier are automatically disabled upon the event of open circuit on current output. In this case, the $\overline{\text{ALARM}}$ automatically resets to the default behavior (non-latched behavior).

8.3.9 Power GOOD bit

The Buck-Boost converter in DAC8771 has a read only bit called power good (PG) (address 0x0B Table 5). This bit is set to logic '1' when both of the following conditions are met

1. The VPOS_IN > 4V (if enabled) and
2. The VNEG_IN < -3V (if enabled)

Feature Description (continued)

The PG bit indicates the status of the outputs of the enabled Buck-Boost converter. For example, if the positive and negative outputs of the Buck-Boost converter are enabled, then the PGA bit is set to a logic '1' only after the positive output pins of the Buck-Boost converter are $\geq 4\text{ V}$ and the negative output pin of Buck-boost converter is $\leq -3\text{ V}$.

8.3.10 Status Register

Since, DAC8771 contains one $\overline{\text{ALARM}}$ pin for the entire chip, the status of individual fault condition can be checked using the status register. This register (see) consists of five types of $\overline{\text{ALARM}}$ status bits (Faults on current and voltage outputs , Over temperature condition, CRC errors, Watchdog timeout and Buck-Boost converter power good) and two status bit (User toggle, Auto Learn status). The device continuously monitors these conditions. When an alarm occurs, the $\overline{\text{ALARM}}$ pin is pulled low and the corresponding status bit is set ('1'). Whenever one of these status bits is set, it remains set until the user clears it by writing '1' to corresponding bit on address 0x0B. The status bit can also be cleared by performing a hardware reset, software reset, or power-on reset, note that it takes a minimum of 8 μsec for the status register to get reset. These bits are reasserted if the $\overline{\text{ALARM}}$ condition continues to exist in the next monitoring cycle.

8.3.11 Status Mask

The $\overline{\text{ALARM}}$ pin for DAC8771 is triggered by any of the alarm condition $\overline{\text{ALARM}}$ Pin . However, these different alarm conditions can be masked from creating the alarm signal at the pin by using the status mask register. The status mask register (address 0x0C) has the same bit order as the status register except that it can be set to mask any or all status bits that create the alarm signal.

8.3.12 Alarm Action

The DAC8771 implements an alarm action register (address 0x0D.). By writing to this register, the user can select the action that the device takes automatically in case of a specific alarm condition. If different setting are chosen for different alarm conditions, the following priority (high to low) is considered when taking action:

1. Over temperature alarm
2. Output fault alarm
3. CRC error/Watchdog timer fault alarm

This device also contains a 6 bit alarm code register (address 0x0E [Table 5](#)) which can be loaded to the DAC if the alarm action register is set to "01". Note that the alarm code, once set, remains set even if the alarm condition is removed. Also note that the alarm action change to the programmed code is a step function even if slew rate control is enabled.

8.3.13 Watchdog Timer

This feature is useful to ensure that communication between the host processor and the DAC8771 has not been lost. It can be enabled by setting the WEN (address 0x03) bit to '1', see . The watchdog timeout period can be set using the WPD[1:0] address 0x03) bits. The timer period is based off an internal oscillator with a typical value of 8 MHz

If enabled, the chip must have an SPI frame with 0x10 as the write address byte written to the device within the programmed timeout period. Otherwise, the $\overline{\text{ALARM}}$ pin asserts low and the WDT bit (address 0x0B) of the status register is set to '1'. The WDT bit is set to '0' with a software/hardware reset, or by disabling the watchdog timer (WEN = '0'), or powering down the device.

When using multiple DAC8771 devices in a daisy-chain configuration, the open-drain $\overline{\text{ALARM}}$ pins of all devices can be connected together to form a wired-AND network. The watchdog timer can be enabled in any number of the devices in the chain although enabling it in one device in the chain should be sufficient. The wired-AND $\overline{\text{ALARM}}$ pin may get pulled low because of the simultaneous presence of different trigger conditions in the devices in the daisy-chain. The host processor should read the status register of each device to know all the fault conditions present in the chain.

Feature Description (continued)

8.3.14 Programmable Slew Rate

The slew rate control feature allows the user to control the rate at which the output voltage or current changes. This feature is disabled by default and can be enabled for the selected channel by writing logic '1' to the SREN bit at address 0x04 (see). With the slew rate control feature disabled, the output changes smoothly at a rate limited by the output drive circuitry and the attached load.

With this feature enabled, the output does not slew directly between the two values. Instead, the output steps digitally at a rate defined by bits [2:0] (SR_STEP) and bits [3:0] (SRCLK_RATE) on address 0x04 (see). SR_RATE defines the rate at which the digital slew updates; SRCLK_STEP defines the amount by which the output value changes at each update. shows different settings for SRCLK_STEP and SR_RATE.

The time required for the output to slew over a given range can be expressed as [Equation 8](#):

$$\text{Slew Time} = \frac{\text{Output Change}}{\text{Step Size} \times \text{Update Clock Frequency} \times \text{LSB Size}} \quad (8)$$

Where:

- *Slew Time* is expressed in seconds
- *Output Change* is expressed in amps (A) for current output mode or volts (V) for voltage output mode

When the slew rate control feature is enabled, the output changes happen at the programmed slew rate. This configuration results in a staircase formation at the output. If the CLR pin is asserted, the output slews to the zero-scale value at the programmed slew rate. When a new DAC data is written, the output starts slewing to the new value at the slew rate determined by the current DAC code and the new DAC data. The update clock frequency for any given value is the same for all output ranges. The step size, however, varies across output ranges for a given value of step size because the LSB size is different for each output range.

Note that disabling the slew rate feature while the DAC is executing the slew rate command will abort the slew rate operation and the DAC output will stay at the last code after which the slew rate disable command was acknowledged.

8.3.15 HART Interface

On the DAC8771, digital communication such as HART can be modulated onto the current output signal.

If the RANGE (address 0x04) bits are programmed such that the IOUT is enabled, the external HART signal (ac voltage; 500 mV_{PP}, 1200 Hz and 2200 Hz) can be capacitively coupled in through the HARTIN pin and transferred to a current that is superimposed on the current output. The HARTIN pin has a typical input impedance of 20 kΩ to 30 kΩ, depending on the selected current output range, which together with the input capacitor used to couple the external HART signal into the HARTIN pin can be used to form a high-pass filter to attenuate frequencies below the HART bandpass region. In addition to this filter, an external passive filter is recommended to complete the filtering requirements of the HART specifications. [Figure 101](#) illustrates the output current vs time operation for a typical HART interface.

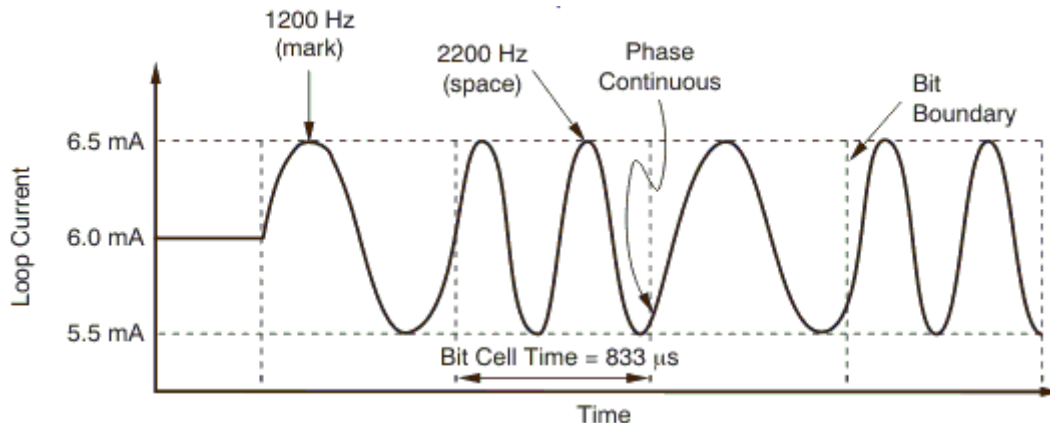
Feature Description (continued)

Note: DC current = 6 mA.

Figure 101. Output Current vs Time

The HART pin for the selected channel can be enabled by writing logic '1' to the HTEN bit at address 0x04 ([Table 4](#) and [Table 5](#)).

8.4 Device Functional Modes

8.4.1 Serial Peripheral Interface (SPI)

The device is controlled over a versatile four-wire serial interface (SDIN, SDO, SCLK, and $\overline{\text{SYNC}}$) that operates at clock rates of up to 25 MHz and is compatible with SPI, QSPI™, Microwire™, and digital signal processing (DSP) standards. The SPI communication command consists of a write address byte and a data word for a total of 24 bits (when CRC is disabled). The timing for the digital interface is shown in the timing section.

8.4.1.1 Stand-Alone Operation

The serial clock SCLK can be a continuous or a gated clock. When $\overline{\text{SYNC}}$ is high, the SCLK and SDIN signals are blocked and the SDO pin is in a HiZ state. Exactly 24 falling clock edges must be applied before $\overline{\text{SYNC}}$ is brought high. If $\overline{\text{SYNC}}$ is brought high before the 24th falling SCLK edge, then the data written are not transferred into the internal registers. If more than 24 falling SCLK edges are applied before $\overline{\text{SYNC}}$ is brought high, then the last 24 bits are used. The device internal registers are updated from the Shift Register on the rising edge of $\overline{\text{SYNC}}$. In order for another serial transfer to take place, $\overline{\text{SYNC}}$ must be brought low again.

8.4.1.2 Daisy-Chain Operation

For systems that contain more than one device, the SDO pin can be used to daisy-chain multiple devices together. Daisy-chain operation can be useful for system diagnostics and in reducing the number of serial interface lines. The daisy chain feature can be enabled by writing logic '0' to DSDO bit address 0x03 (), the SDO pin is set to HiZ when DSDO bit is set to 1. By connecting the SDO of the first device to the SDIN input of the next device in the chain, a multiple-device interface is constructed, as [Figure 102](#) illustrates.

Device Functional Modes (continued)

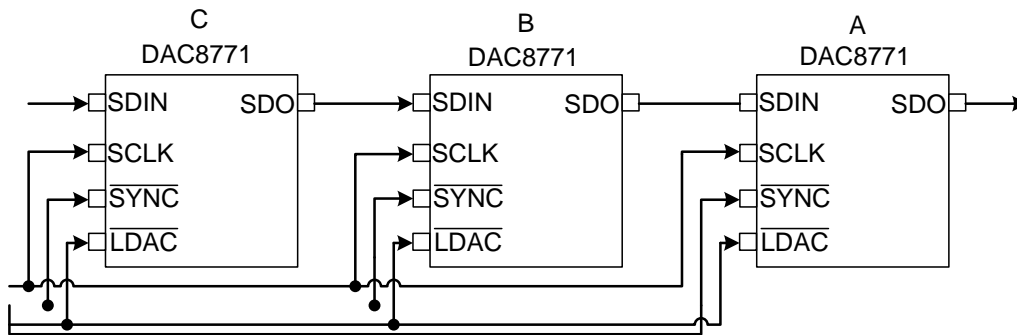

Figure 102. Three DAC8771s in Daisy-Chain Mode

The DAC8771 provides two modes for daisy-chain operation: normal and transparent. The TRN bit in the Reset config register determines which mode is used. In Normal mode (TRN bit = '0'), the data clocked into the SDIN pin are transferred into the shift register. The first falling edge of SYNC starts the operating cycle. SCLK is continuously applied to the SPI Shift Register when SYNC is low. If more than 24 clock pulses are applied, the data ripple out of the shift register and appear on the SDO line. These data are clocked out on the rising edge of SCLK and are valid on the falling edge. By connecting the SDO pin of the first device to the SDIN input of the next device in the chain, a multiple-device interface is constructed. Each device in the system requires 24 clock pulses. Therefore, the total number of clock cycles must equal $24 \times N$, where N is the total number of DAC8771s in the chain. When the serial transfer to all devices is complete, SYNC is taken high. This action latches the data from the SPI Shift registers to the device internal registers synchronously for each device in the daisy-chain, and prevents any further data from being clocked in. Note that a continuous SCLK source can only be used if SYNC is held low for the correct number of clock cycles. For gated clock mode, a burst clock containing the exact number of clock cycles must be used and SYNC must be taken high after the final clock in order to latch the data.

In Transparent mode (address 0x02h, TRN bit = '1' Table 5), the data clocked into SDIN are routed to the SDO pin directly; the Shift Register is bypassed. When SCLK is continuously applied with SYNC low, the data clocked into the SDIN pin appear on the SDO pin almost immediately (with approximately a 12 ns delay); there is no 24 clock delay, as there is in normal operating mode. While in Transparent mode, no data bits are clocked into the Shift Register, and the device does not receive any new data or commands. Putting the device into transparent mode eliminates the 24 clock delay from SDIN to SDO caused by the Shift Register, thus greatly speeding up the data transfer. For example, consider three DAC8771s (C, B, and A) in a daisy-chain configuration (Figure 102). The data from the SPI controller are transferred first to C, then to B, and finally to A. In normal daisy-chain operation, a total of 72 clocks are needed to transfer one word to A. However, if C and B are placed into Sleep mode, the first 24 data bits are directly transferred to A (through C and B); therefore, only 24 clocks are needed.

To wake the device up from transparent mode and return to normal operation, the hardware RESET pin must be toggled.

8.4.2 SPI Shift Register

The SPI Shift Register is 24 bits wide (refer to the Frame Error Checking section for 32-bit frame mode). The default 24-bit input frame consists of an 8-bit address byte followed by a 16-bit data word as shown in Table 1.

Table 1. Default SPI Frame

BIT 23:BIT 16	BIT 15:BIT 0
Address byte	Data word

8.4.3 Write Operation

A typical write to program a channel of the DAC8771 consists of writing to the following registers in the sequence shown in [Figure 12](#).

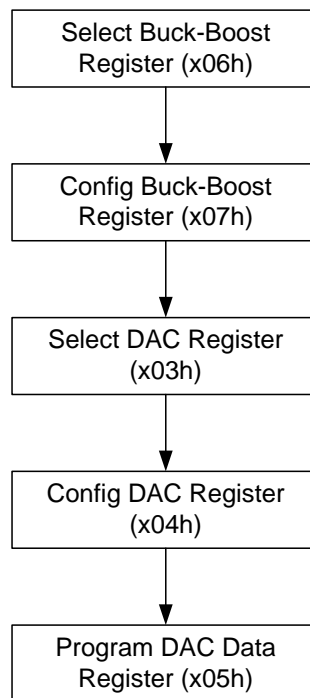

Figure 103. Typical Write to DAC8771

8.4.4 Read Operation

A read operation is accomplished when DB 23 is '1' (see [Table 2](#)). A no-operation (NOP) command should follow the read operation in order to clock out an addressed register. The read register value is output MSB first on SDO on successive falling edges of SCLK.

Table 2. Register Read Address Functions⁽¹⁾

ADDRESS BYTE	
DB23	DB 22: DB 16
Read/Write Bit	Register Addresses

(1) 'X' denotes *don't care* bits.

8.4.5 Updating the DAC Outputs and $\overline{\text{LDAC}}$ Pin

Depending on the status of both $\overline{\text{SYNC}}$ and $\overline{\text{LDAC}}$, and after data have been transferred into the DAC Data registers, the DAC outputs can be updated either in asynchronous mode or synchronous mode.

8.4.5.1 Asynchronous Mode

In this mode, the $\overline{\text{LDAC}}$ pin is set low before the rising edge of $\overline{\text{SYNC}}$. This action places the DAC8771 into Asynchronous mode, and the $\overline{\text{LDAC}}$ signal is ignored. The DAC latches are updated immediately when $\overline{\text{SYNC}}$ goes high.

8.4.5.2 Synchronous Mode

To use this mode, set $\overline{\text{LDAC}}$ high before the rising edge of $\overline{\text{SYNC}}$, and then take $\overline{\text{LDAC}}$ low after $\overline{\text{SYNC}}$ goes high. In this mode, when $\overline{\text{LDAC}}$ stays high, the DAC latch is not updated; therefore, the DAC output does not change. The DAC latch is updated by taking $\overline{\text{LDAC}}$ low any time after a certain delay from the rising edge of $\overline{\text{SYNC}}$ (see [Figure 1](#)). If this delay requirement is not satisfied, invalid data are loaded. Refer to the Timing Diagrams for details.

8.4.6 Hardware $\overline{\text{RESET}}$ Pin

When the $\overline{\text{RESET}}$ pin is low, the device is in hardware reset. All the analog outputs (VOUT_A to VOUT_D and IOUT_A to IOUT_D), all the registers except the POC register, and the DAC latches are set to the default reset values. In addition, the Gain and Zero Registers are loaded with default values, communication is disabled, and the signals on $\overline{\text{SYNC}}$ and SDIN are ignored (note that SDO is in a high-impedance state). When the $\overline{\text{RESET}}$ pin is high, the serial interface returns to normal operation and all the analog outputs (VOUT_A to VOUT_D and IOUT_A to IOUT_D) maintain the reset value until a new value is programmed.

8.4.7 Hardware CLR Pin

The CLR pin is an active high input that should be low for normal operation. When this pin is a logic '1', all the outputs are cleared to either zero-scale code or midscale code depending on the status of the CLSLx bit (see reset register). While CLR is high, all $\overline{\text{LDAC}}$ pulses are ignored. When CLR is taken low again, the DAC outputs remain cleared until new data is written to the DAC. The contents of the offset Registers, Gain Registers and DAC input registers are not affected by taking CLR high. Note that the clear action will result in the outputs clearing to the default value instantaneously even if slew rate control is enabled.

8.4.8 Frame Error Checking

If the DAC8771 is used in a noisy environment, error checking can be used to check the integrity of SPI data communication between the device and the host processor. This feature can be enabled by setting the CREN bit address 0x03 .

The frame error checking scheme is based on the CRC-8-ATM (HEC) polynomial $x^8 + x^2 + x + 1$ (that is, 10000111). When error checking is enabled, the SPI frame width is 32 bits, as shown in Table 3 . The normal 24-bit SPI data are appended with an 8-bit CRC polynomial by the host processor before feeding it to the device. For a register readback, the CRC polynomial is output on the SDO pins by the device as part of the 32 bit frame.

Note that the user has to start with the default 24 bit frame and enable frame error checking through the CREN bit and switch to the 32 bit frame. Alternatively, the user can use a 32 bit frame from the beginning and pad the 8 MSB bits as the device will only use the last 24 bits until the CRCEN bit is set. The frame length has to be carefully managed, especially when using daisy-chaining in combination with CRC checking to ensure correct operation.

Table 3. SPI Frame with Frame Error Checking Enabled

BIT 31:BIT 8	BIT 7:BIT 0
Normal SPI frame data	8-bit CRC polynomial

The DAC8771 decodes the 32-bit input frame data to compute the CRC remainder. If no error exists in the frame, the CRC remainder is zero. When the remainder is non-zero (that is, the input frame has single- or multiple-bit errors), the $\overline{\text{ALARM}}$ pin asserts low and the CRE bit of the status register (address 0x0B) is also set to '1'. Note that the $\overline{\text{ALARM}}$ pin can be asserted low for any of the different conditions as explained in the [ALARM Pin](#) section. The CRE bit is set to '0' with a software or hardware reset, or by disabling the frame error checking, or by powering down the device. In the case of a CRC error, the specific SPI frame is blocked from writing to the device.

Frame error checking can be enabled for any number of DAC8771 devices connected in a daisy-chain configuration. However, it is recommended to enable error checking for none or all devices in the chain. When connecting the $\overline{\text{ALARM}}$ pins of all combined devices, forming a wired-AND function, the host processor should read the status register of each device to know all the fault conditions present in the chain. For proper operation, the host processor must provide the correct number of SCLK cycles in each frame, taking care to identify whether or not error checking is enabled in each device in the daisy-chain.

8.4.9 DAC Data Calibration

The DAC8771 contains a dedicated user calibration register set. This feature allows the user to trim the system gain and offset errors. Both the voltage output and the current output have common user calibration registers available. The user calibration feature is disabled by default. To enable this feature, the CLEN bit (DB0) on address 0x08 must be set to logic '1' (see).

8.4.9.1 DAC Data Gain and Offset Calibration Registers

The DAC calibration register set includes one gain calibration and one offset calibration register (16 bits for DAC8771). The range of gain adjustment is typically $\pm 50\%$ of full-scale with 1 LSB per step. The power-on value of the gain register is 0x8000 which is equivalent to a gain of 1.0. The offset code adjustment is typically $\pm 32,768$ LSBs with 1 LSB per step. The input data format of the gain register is unsigned straight binary, and the input data format of the offset register is twos complement. The gain and offset calibration is described by [Equation 9](#).

$$CODE_OUT = \left[CODE \times \left(\frac{User_Gain + 2^{15}}{2^{16}} \right) + User_Zero \right] \quad (9)$$

Where:

- *CODE* is the decimal equivalent of the code loaded to the DAC.
- *VREFIN* is the reference voltage; for internal reference, *VREFIN* = +5.0 V.
- *GAIN* is automatically selected for a desired voltage output range as shown in
- *User_Offset* is the signed 16-bit code in the offset register.
- *User_GAIN* is the unsigned 16-bit code in the gain register.

It is important to note that this is a purely digital implementation and the output is still limited by the programmed value at both ends of the voltage or current output range. Therefore, the user must remember that the correction only makes sense for endpoints inside of the true device end points. If the user desires to correct more than just the actual device error, for example a system offset, the valid range for the adjustment would change accordingly and must be taken into account. This range is set by the RANGE bits as described in [Configuration DAC Register \(address = 0x04\) \[reset = 0x0000\]](#).

8.5 Register Maps

8.5.1 Register Maps

8.5.1.1 DAC8771 Commands

Table 4. Address Functions

ADDRESS BYTE	FUNCTION	READ/WRITE	PER CHANNEL	POWER-ON RESET VALUE
0x00	No operation (NOP)	Write	No	0x0000
0x01	Reset register	Read+Write	No	0x0000
0x02	Reset config register	Read+Write	No	0x0000
0x03	Select DAC register	Read+Write	No	0x0000
0x04	Configuration DAC register	Read+Write	Yes	0x0000
0x05	DAC data register	Read+Write	Yes	0x0000
0x06	Select Buck-Boost converter register	Read+Write	No	0x0000
0x07	Configuration Buck-Boost converter register	Read+Write	Yes	0x0000
0x08	DAC channel calibration enable register	Read+Write	Yes	0x0000
0x09	DAC channel gain calibration register	Read+Write	Yes	0x0000
0x0A	DAC channel offset calibration register	Read+Write	Yes	0x0000
0x0B	Status register	Read+Write	No	0x1000
0x0C	Status mask register	Read+Write	No	0x0000
0x0D	Alarm action register	Read+Write	No	0x0000
0x0E	User alarm code register	Read+Write	Yes	0x0000
0x0F	Reserved	N/A	N/A	N/A
0x10	Write watchdog timer reset	Write	No	0x0000
0x11	Device ID	Read	No	0x0000
0x12 - 0xFF	Reserved	N/A	N/A	N/A

Note that, in order to write to (or read from) a per channel address, corresponding Buck-Boost converter and DAC channel must be selected using commands 0x06 and 0x03.

8.5.1.2 Register Maps and Bit Functions
Table 5. Register Map

ADDRESS	BITS															
	15	14	13	12	11	10	9	8	7	6	5	4	3	2	1	0
0x01	x	x	x	x	x	x	x	x	x	x	x	x	x	x	x	RST
0x02	x	x	x	IDA	IDB	IDC	CLREN	x	x	x	x	REF_EN	TRN	CLR	POC	UBT
0x03	x	x	x	Reserved	Reserved	Reserved	CLSL	Reserved	Reserved	Reserved	CH	DSDO	CREN	WPD[1:0]		WEN
0x04	SCLIM[1:0]		HTEN	OTEN	SRCLK_RATE[3:0]				SR_STEP[2:0]			SREN	RANGE[3:0]			
0x05	DAC_DATA[15:0]															
0x06	x	x	x	x	x	x	x	x	x	x	x	x	Reserv ed	Reserv ed	Reserv ed	DC
0x07	x	x	x	x	CCLP[1:0]			PCLMP[3:0]			NCLMP[3:0]			PNSEL[1:0]		
0x08	x	x	x	x	x	x	x	x	x	x	x	x	x	x	x	CLEN
0x09	UGAIN[15:0]															
0x0A	UOFF[15:0]															
0x0B	x	x	x	CLST	WDT	DIDA	DIDB	DIDC	PG	UTGL	CRE	TMP	Reserv ed	Reserv ed	Reserv ed	F
0x0C	x	x	x	x	MWT	x	x	x	x	x	MCRE	MTMP	Reserv ed	Reserv ed	Reserv ed	MF
0x0D	x	x	x	x	x	x	x	x	AC_CRE_WDT[1:0]		AC_IOC[1:0]		AC_VSC[1:0]		AC_TMP[1:0]	
0x0E	ACODE[15:10]						HSLMP	0	x	x	x	x	x	x	x	x
0x10	x	x	x	x	x	x	x	x	x	x	x	x	x	x	x	RWD
0x11	x	x	x	x	x	x	x	x	x	x	x	x	x	DID[2:0]		

8.5.1.2.1 No Operation Register (address = 0x00) [reset = 0x0000]
Figure 104. No Operation Register

15	14	13	12	11	10	9	8
Reserved							
W							
7	6	5	4	3	2	1	0
Reserved							
W							

LEGEND: R/W = Read/Write; R = Read only; W = Write Only; -n = value after reset

Table 6. No Operation Field Descriptions

Bit	Field	Type	Reset	Description
15:10	Reserved	W	00000000 00000000	Reserved

8.5.1.2.2 Reset Register (address = 0x01) [reset = 0x0000]
Figure 105. Reset Register

15	14	13	12	11	10	9	8
Reserved							
R/W							
7	6	5	4	3	2	1	0
Reserved							RST
R/W							R/W

LEGEND: R/W = Read/Write; R = Read only; -n = value after reset

Table 7. Reset Register Field Descriptions

Bit	Field	Type	Reset	Description
15:1	Reserved	R/W	00000000 00000000	Reserved
0	RST	R/W	0	Reset. When set, it resets all registers except POC register bit to the respective power-on reset default value. After reset completes the RST bit clears

8.5.1.2.3 Reset Config Register (address = 0x02) [reset = 0x0000]
Figure 106. Reset Config Register

15	14	13	12	11	10	9	8
Reserved			IDA	IDB	IDC	CLRENA	Reserved
R/W			R/W	R/W	R/W	R/W	R/W
7	6	5	4	3	2	1	0
Reserved			REF_EN	TRN	CLR	POC	UBT
R/W			R/W	R/W	R/W	R/W	R/W

LEGEND: R/W = Read/Write; R = Read only; -n = value after reset

Table 8. Reset Config Register Field Descriptions

Bit	Field	Type	Reset	Description
15:13	Reserved	R/W	000	Reserved
12	IDA	R/W	0	User Bit 0 - Sets this user bit low. 1 - Sets this user bit high.
11	IDB	R/W	0	User Bit 0 - Sets this user bit low. 1 - Sets this user bit high.
10	IDC	R/W	0	User Bit 0 - Sets this user bit low. 1 - Sets this user bit high.
9	CLREN	R/W	0	Clear Enable 0 - DAC hardware and software clear is disabled 1 - DAC hardware and software clear is enabled
8:5	Reserved	R/W	0000	Reserved
4	REF_EN	R/W	0	Internal reference enable/disable 0 - Internal reference disabled (default) 1 - Internal reference enabled
3	TRN	R/W	0	Enable transparent mode (see section "daisy chain operation")
2	CLR	R/W	0	Active high, clears all DAC registers to either zero or full scale based on CLSL bit. After clear completes the CLR bit resets.
1	POC	R/W	0	Power-Off-Condition 0 - IOU to HIZ, VOUT to 30K-to-PBKG at power up, hardware or software reset (default) 1 - IOU and VOUT to HIZ at power up, hardware and software reset
0	UBT	R/W	0	User Bit - This bit can be used to check if the communication to the chip is working correctly by writing a known value to this bit and reading that value from the status register toggle bit. The toggle register bit UTGL (address 0x0B) is set to the same value as the UBT bit.

8.5.1.2.4 Select DAC Register (address = 0x03) [reset = 0x0000]
Figure 107. Select DAC Register

15	14	13	12	11	10	9	8
Reserved			Reserved	Reserved	Reserved	CLSLA	Reserved
R/W			R/W	R/W	R/W	R/W	R/W
7	6	5	4	3	2	1	0
Reserved	Reserved	CHA	DSDO	CREN	WPD[1:0]		WEN
R/W	R/W	R/W	R/W	R/W	R/W		R/W

LEGEND: R/W = Read/Write; R = Read only; -n = value after reset

Table 9. Select DAC Register Field Descriptions

Bit	Field	Type	Reset	Description
15:10	Reserved	R/W	000	Reserved
9	CLSLA	R/W	0	Clear Select 0 - DAC registers cleared to zero scale upon hardware or software clear (default) 1 - DAC registers cleared to mid scale upon hardware or software clear
8:6	Reserved	R/W	0	Reserved
5	CHA	R/W	0	Channel A selected
4	DSDO	R/W	0	Disable SDO - When set, this bit disables daisy chain operation and SDO pin is set to HiZ, enabled by default
3	CREN	R/W	0	Enable CRC - When set, this bit enables frame error checking, disabled by default
2:1	WPD[1:0]	R/W	00	Watchdog Timer Period 00 - 10 ms (typical) 01 - 51 ms (typical) 10 - 102 ms (typical) 11 - 204 ms (typical)
0	WEN	R/W	0	Enable Watchdog Timer - When set, this bit enables watchdog timer, disabled by default

8.5.1.2.5 Configuration DAC Register (address = 0x04) [reset = 0x0000]
Figure 108. Configuration DAC Register

15	14	13	12	11	10	9	8
SCLIM[1:0]		HTEN	OTEN	SRCLK_RATE[3:0]			
R/W		R/W	R/W	R/W			
7	6	5	4	3	2	1	0
SR_STEP[2:0]			SREN	RANGE[3:0]			
R/W			R/W	R/W			

LEGEND: R/W = Read/Write; R = Read only; -n = value after reset

Table 10. Configuration DAC Register Field Descriptions

Bit	Field	Type	Reset	Description
15:14	SCLIM[1:0]	R/W	00	Voltage output short circuit limit 00 - 22 mA (default). Actual value will be between the minimum and maximum values specified in Electrical Characteristics . 01 - 10 mA. Actual value will be between the minimum and maximum values specified in Electrical Characteristics . 10 - 26 mA. Actual value will be between the minimum and maximum values specified in Electrical Characteristics . 11 - 31 mA. Actual value will be between the minimum and maximum values specified in Electrical Characteristics .
13	HTEN	R/W	0	Enable HART - When set, this bit enables HART, disabled by default
12	OTEN	R/W	0	Output Enabled - When set, this bit enables DAC (Voltage or Current) outputs, disabled by default
11:8	SRCLK_RATE[3:0]	R/W	0000	Slew Clock Rate 0000 - DAC updates at 258,065 Hz (default) 0001 - DAC updates at 200,000 Hz 0010 - DAC updates at 153,845 Hz 0011 - DAC updates at 131,145 Hz 0100 - DAC updates at 115,940 Hz 0101 - DAC updates at 69,565 Hz 0110 - DAC updates at 37,560 Hz 0111 - DAC updates at 25,805 Hz 1000 - DAC updates at 20,150 Hz 1001 - DAC updates at 16,030 Hz 1010 - DAC updates at 10,295 Hz 1011 - DAC updates at 8,280 Hz 1100 - DAC updates at 6,900 Hz 1101 - DAC updates at 5,530 Hz 1110 - DAC updates at 4,240 Hz 1111 - DAC updates at 3,300 Hz
7:5	SR_STEP[2:0]	R/W	000	Slew Rate Step Size 000 - 1 LSB (default) 001 - 2 LSB 010 - 4 LSB 011 - 8 LSB 100 - 16 LSB 101 - 32 LSB 110 - 64 LSB 111 - 128 LSB
4	SREN	R/W	0	Slew Rate Enabled - When set, this bit enables slew rate feature, disabled by default

Table 10. Configuration DAC Register Field Descriptions (continued)

Bit	Field	Type	Reset	Description
3:0	RANGE[3:0]	R/W	0000	Range. Please note that upon changing the range, the DAC output changes based on CLSLA (Address 0x03) 0000 - Voltage output 0 to +5 V (default) 0001 - Voltage output 0 to +10 V 0010 - Voltage output ± 5 V 0011 - Voltage output ± 10 V 0100 - Current output 3.5 mA to 23.5 mA 0101 - Current output 0 to 20 mA 0110 - Current output 0 to 24 mA 0111 - Current output ± 24 mA 1000 - Voltage output 0 to +6 V 1001 - Voltage output 0 to +12 V 1010 - Voltage output ± 6 V 1011 - Voltage output ± 12 V 11xx - Current output 4 mA to 20 mA

8.5.1.2.6 DAC Data Register (address = 0x05) [reset = 0x0000]
Figure 109. DAC Data Register

15	14	13	12	11	10	9	8
DAC_DATA[15:8]							
R/W							
7	6	5	4	3	2	1	0
DAC_DATA[7:0]							
R/W							

LEGEND: R/W = Read/Write; R = Read only; -n = value after reset

Table 11. DAC Data Register Field Descriptions

Bit	Field	Type	Reset	Description
15:0	DAC_DATA[15:0]	R/W		16-bit DAC data

8.5.1.2.7 Select Buck-Boost Converter Register (address = 0x06) [reset = 0x0000]
Figure 110. Select Buck-Boost Converter Register

15	14	13	12	11	10	9	8
Reserved							
R/W							
7	6	5	4	3	2	1	0
Reserved			Reserved		Reserved	Reserved	DC
R/W			R/W		R/W	R/W	R/W

LEGEND: R/W = Read/Write; R = Read only; -n = value after reset

Table 12. Select Buck-Boost Converter Register Field Descriptions

Bit	Field	Type	Reset	Description
15:1	Reserved	R/W	00000000 0000	Reserved
0	DCA	R/W	0	Buck-Boost converter A selected

8.5.1.2.8 Configuration Buck-Boost Register (address = 0x07) [reset = 0x0000]
Figure 111. Configuration Buck-Boost Register

15	14	13	12	11	10	9	8
Reserved				CCLP[1:0]		PCLMP[3:2]	
R/W				R/W		R/W	
7	6	5	4	3	2	1	0
PCLMP[1:0]		NCLMP[3:0]				PNSEL[1:0]	
R/W		R/W				R/W	

LEGEND: R/W = Read/Write; R = Read only; -n = value after reset

Table 13. Configuration Buck-Boost Register Field Descriptions

Bit	Field	Type	Reset	Description
15:12	Reserved	R/W	0000	Reserved
11:10	CCLP[1:0]	R/W	00	Buck-Boost converter configurable clamp setting 00 - Buck-Boost converter in full tracking mode (default) 01 - User can write to PCLMP and NCLMP bits 10 - PCLMP bits are populated automatically to optimum value - "Auto Learn mode", User cannot write to PCLMP bits 11 - Invalid
9:6	PCLMP[3:0]	R/W	0000	Buck-Boost converter positive clamp setting, DAC output unloaded - Buck-Boost converter positive arm low side clamp
				Current Output Mode Voltage Output Mode
			0000	4.0 V (default) Invalid
			0001	5.0 V Invalid
			0010	6.0 V Invalid
			0011	9.0 V 9.0 V
			0100	11.0 V Invalid
			0101	12.0 V Invalid
			0110	13.0 V Invalid
			0111	14.0 V Invalid
			1000	15.0 V 15.0 V
			1001	18.0 V 18.0 V
			1010	20.0 V Invalid
			1011	23.0 V Invalid
			1100	25.0 V Invalid
			1101	27.0 V Invalid
			1110	30.0 V Invalid
			1111	32.0 V Invalid

Table 13. Configuration Buck-Boost Register Field Descriptions (continued)

Bit	Field	Type	Reset	Description		
5:2	NCLMP[3:0]	R/W	0000	Buck-Boost converter negative clamp setting, DAC output unloaded - Buck-Boost converter negative arm low side clamp		
				Current Output Mode	Voltage Output Mode	
				0000	–5.0 V	Invalid
				0001	–6.0 V	Invalid
				0010	–9.0 V	–9.0 V
				0011	–11.0 V	Invalid
				0100	–12.0 V	Invalid
				0101	–13.0 V	Invalid
				0110	–14.0 V	Invalid
				0111	–15.0 V	–15.0 V (default)
				1000	–18.0 V	Invalid
				1001	–18.0 V	–18.0 V
				101x	Invalid	Invalid
				11xx	Invalid	Invalid
1:0	PNSEL[1:0]	R/W	00	Enable Buck-Boost converter positive and negative arm 00 - Buck-Boost converter positive and negative arm disabled (default) 01 - Buck-Boost converter positive arm enabled and negative arm disabled 10 - Buck-Boost converter positive arm disabled and negative arm enabled 11 - Buck-Boost converter positive arm and negative arm enabled		

8.5.1.2.9 DAC Channel Calibration Enable Register (address = 0x08) [reset = 0x0000]
Figure 112. DAC Channel Calibration Enable Register

15	14	13	12	11	10	9	8
Reserved							
R/W							
7	6	5	4	3	2	1	0
Reserved							CLEN
R/W							R/W

LEGEND: R/W = Read/Write; R = Read only; -n = value after reset

Table 14. DAC Channel Calibration Enable Register Field Descriptions

Bit	Field	Type	Reset	Description
15:1	Reserved	R/W	00000000 00000000	Reserved
0	CLEN	R/W	0	Enable DAC calibration - When set, this bit enables DAC data calibration, disabled by default

8.5.1.2.10 DAC Channel Gain Calibration Register (address = 0x09) [reset = 0x0000]
Figure 113. DAC Channel Gain Calibration Register

15	14	13	12	11	10	9	8
UGAIN[15:8]							
R/W							
7	6	5	4	3	2	1	0
UGAIN[7:0]							
R/W							

LEGEND: R/W = Read/Write; R = Read only; -n = value after reset

Table 15. DAC Channel Gain Calibration Register Field Descriptions

Bit	Field	Type	Reset	Description
15:0	UGAIN[15:0]	R/W	00000000 00000000	16-bit user gain data

8.5.1.2.11 DAC Channel Offset Calibration Register (address = 0x0A) [reset = 0x0000]
Figure 114. DAC Channel Offset Calibration Register

15	14	13	12	11	10	9	8
UOFF[15:8]							
R/W							
7	6	5	4	3	2	1	0
UOFF[7:0]							
R/W							

LEGEND: R/W = Read/Write; R = Read only; -n = value after reset

Table 16. DAC Channel Offset Calibration Register Field Descriptions

Bit	Field	Type	Reset	Description
15:0	UOFF[15:0]	R/W	00000000 00000000	16-bit user offset data

8.5.1.2.12 Status Register (address = 0x0B) [reset = 0x1000]
Figure 115. Status Register

15	14	13	12	11	10	9	8
Reserved			CLST	WDT	DIDA	DIDB	DIDC
R/W			R/W	R/W	R/W	R/W	R/W
7	6	5	4	3	2	1	0
PG	UTGL	CRE	TMP	Reserved	Reserved	Reserved	F
R/W	R/W	R/W	R/W	R/W	R/W	R/W	R/W

LEGEND: R/W = Read/Write; R = Read only; -n = value after reset

Table 17. Status Register Field Descriptions

Bit	Field	Type	Reset	Description
15:13	Reserved	R/W	000	Reserved
12	CLST	R/W	1	Auto Learn status - Indicates that Auto Learn operation is finished
11	WDT	R/W	0	Watchdog timer fault - Indicates that watchdog timer fault has occurred
10	DIDA	R	0	Fixed at logical 1
9	DIDB	R	0	Fixed at logical 1
8	DIDC	R	0	Fixed at logical 1
7	PG	R/W	0	Buck-Boost power good - Indicates the power good condition on the Buck-Boost converter
6	UTGL	R/W	0	User toggle - Copy of user bit (UBT)
5	CRE	R/W	0	CRC error - Indicates CRC error condition
4	TMP	R/W	0	Over temperature - Indicates over temperature condition
3:1	Reserved	R/W	0	Reserved
0	F	R/W	0	DAC Fault - Indicates DAC fault condition

8.5.1.2.13 Status Mask Register (address = 0x0C) [reset = 0x0000]
Figure 116. Status Mask Register

15	14	13	12	11	10	9	8
Reserved				MWT	Reserved		
R/W				R/W	R/W		
7	6	5	4	3	2	1	0
Reserved		MCRE	MTMP	Reserved	Reserved	Reserved	MF
R/W		R/W	R/W	R/W	R/W	R/W	R/W

LEGEND: R/W = Read/Write; R = Read only; -n = value after reset

Table 18. Status Mask Register Field Descriptions

Bit	Field	Type	Reset	Description
15:12	Reserved	R/W	0000	Reserved
11	MWT	R/W	0	Mask WDT - When set, it masks the alarm pin from watchdog timer fault condition
10:6	Reserved	R/W	00000	Reserved
5	MCRE	R/W	0	CRC error - When set, it masks the alarm pin from CRC error condition
4	MTMP	R/W	0	Mask TMP - When set, it masks the alarm pin from over temperature condition
3:1	Reserved	R/W	0	Reserved
0	MFA	R/W	0	Mask F - When set, it masks the alarm pin from fault condition for the DAC output channel

8.5.1.2.14 Alarm Action Register (address = 0x0D) [reset = 0x0000]
Figure 117. Alarm Action Register

15	14	13	12	11	10	9	8
Reserved							
R/W							
7	6	5	4	3	2	1	0
AC_CRE_WDT[1:0]		AC_IOC[1:0]		AC_VSC[1:0]		AC_TMP[1:0]	
R/W		R/W		R/W		R/W	

LEGEND: R/W = Read/Write; R = Read only; -n = value after reset

Table 19. Alarm Action Register Field Descriptions

Bit	Field	Type	Reset	Description
15:8	Reserved	R/W	00000000	Reserved
7:6	AC_CRE_WDT[1:0]	R/W	00	Action CRC error and Watchdog timer fault circuit condition 00 - No action on Buck-Boost converter, no action on DAC (default) 01 - No action on Buck-Boost converter, respective user alarm code on all DAC 10 - All Buck-Boost converter and DAC disabled and remain disabled even after the alarm condition is removed. 11 - Invalid
5:4	AC_IOC[1:0]	R/W	00	Action current output open circuit condition 00 - No action on Buck-Boost converter, no action on DAC (default) 01 - No action on Buck-Boost converter, respective user alarm code on DAC(s) initiating the alarm 10 - All Buck-Boost converter and DAC disabled and remain disabled even after the alarm condition is removed. 11 - Invalid
3:2	AC_VSC[1:0]	R/W	00	Action voltage output short circuit condition 00 - No action on Buck-Boost converter, no action on DAC (default) 01 - No action on Buck-Boost converter, respective user alarm code on DAC(s) initiating the alarm 10 - All Buck-Boost converter and DAC disabled and remain disabled even after the alarm condition is removed. 11 - Invalid
1:0	AC_TMP[1:0]	R/W	00	Action over temperature condition 00 - No action on Buck-Boost converter, no action on DAC (default) 01 - No action on Buck-Boost converter, respective user alarm code on all DAC 10 - All Buck-Boost converter and DAC disabled and remain disabled even after the alarm condition is removed. 11 - Invalid

8.5.1.2.15 User Alarm Code Register (address = 0x0E) [reset = 0x0000]

Figure 118. User Alarm Code Register

15	14	13	12	11	10	9	8
ACODE[15:10]						HSCLMP	0
R/W						R/W	R/W
7	6	5	4	3	2	1	0
Reserved							
R/W							

LEGEND: R/W = Read/Write; R = Read only; -n = value after reset

Table 20. User Alarm Code Register Field Descriptions

Bit	Field	Type	Reset	Description
15:10	ACODE[15:10]	R/W	000000	6 bit alarm code data
9	HSCLMP	R/W	0	Buck-Boost positive output high side clamp 0 - Buck-Boost converter positive output high side clamp set to 32 V (default) 1 - Buck-Boost converter positive output high side clamp set to 26 V (default)
8	0	R/W	0	0
7:0	Reserved	R/W	00000000	Reserved

8.5.1.2.16 Reserved Register (address = 0x0F) [reset = N/A]

Figure 119. Reserved Register

15	14	13	12	11	10	9	8
Reserved							
R							
7	6	5	4	3	2	1	0
Reserved							
R							

LEGEND: R/W = Read/Write; R = Read only; -n = value after reset

Table 21. Reserved Register Field Descriptions

Bit	Field	Type	Reset	Description
15:0	Reserved	R	N/A	Reserved

8.5.1.2.17 Write Watchdog Timer Register (address = 0x10) [reset = 0x0000]

Figure 120. Write Watchdog Timer Register

15	14	13	12	11	10	9	8
Reserved							
R							
7	6	5	4	3	2	1	0
Reserved							RWD
R							W

LEGEND: R/W = Read/Write; R = Read only; W = Write only; -n = value after reset

Table 22. Write Watchdog Timer Register Field Descriptions

Bit	Field	Type	Reset	Description
15:1	Reserved	R	00000000 00000000	Reserved

Table 22. Write Watchdog Timer Register Field Descriptions (continued)

Bit	Field	Type	Reset	Description
0	RWD	W	0	Reset watchdog timer, this bit clears itself after resetting watch dog timer

8.5.1.2.18 Reserved Register (address 0x12 - 0xFF) [reset = N/A]
Figure 121. Reserved Register

15	14	13	12	11	10	9	8
Reserved							
R							
7	6	5	4	3	2	1	0
Reserved							
R							

LEGEND: R/W = Read/Write; R = Read only; -n = value after reset

Table 23. Reserved Register Field Descriptions

Bit	Field	Type	Reset	Description
15:0	Reserved	R	N/A	Reserved

9 Application and Implementation

NOTE

Information in the following applications sections is not part of the TI component specification, and TI does not warrant its accuracy or completeness. TI's customers are responsible for determining suitability of components for their purposes. Customers should validate and test their design implementation to confirm system functionality.

9.1 Application Information

9.1.1 Buck-Boost Converter External Component Selection

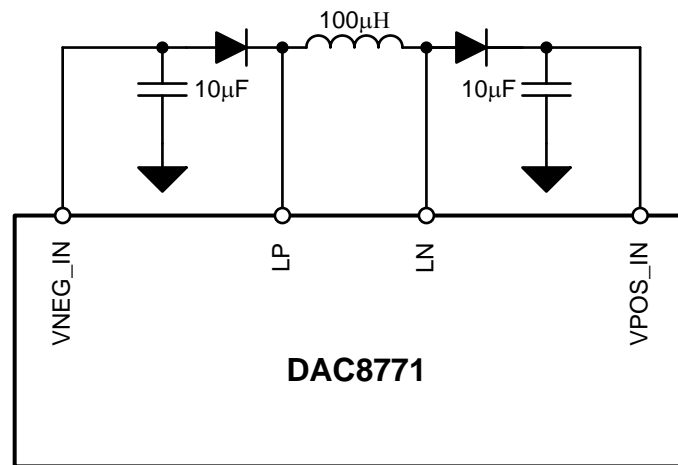

Copyright © 2018, Texas Instruments Incorporated

Figure 122. DAC8771 External Buck-Boost Components with Recommended Values

The buck-boost converter integrated in the DAC8771 requires three external passive components for operation: a single inductor along with two storage capacitors and two switching diodes, one for each VPOS_IN and VNEG_IN when active. If only one output is used, either VPOS_IN or VNEG_IN, the inactive output components may be removed and the respective inputs tied to ground. In order to meet the parametric performance outlined in the section for the voltage output, 500 mV of footroom is required on VNEG_IN.

The recommended value for the external inductor is 100 µH with at least 500 mA peak inductor current. Reducing the inductor value to as low as 80 µH is possible, though this will limit the buck-boost converter maximum input voltage to output voltage ratio, reduce efficiency, and increase ripple. Reducing the inductor below 80 µH will result in device damage. Peak inductor current should be rated at 500 mA or greater with 20% inductance tolerance at peak current. If peak inductor current for an inductor is violated the effective inductance is reduced, which will impact maximum input to output voltage ratio, efficiency, and ripple.

An output, or storage, X7R capacitor with value of 10 µF and voltage rating of 50 V is recommended though other values and dielectric materials may be used without damaging the DAC8771. Reducing capacitor value will increase buck-boost converter output ripple and reduced voltage rating will reduce effective capacitance at full-scale buck-boost converter outputs. X7R capacitors are rated for –55°C to 125°C operation with 15% maximum capacitance variance over temperature. Designs operating over reduced temperature spans and with loose efficiency requirements may use different dielectric material. C0G capacitor typically offer tighter capacitance variance but come in larger packages, but may be beneficial substitutes.

The external diode switches illustrated on the left and right side of the 100 µH inductor shown in [Figure 122](#) should be selected based on reverse voltage rating, reverse recovery time, leakage or parasitic capacitance, and current or power ratings. Breakdown voltage rating of at least 60 V is recommended to accommodate for the maximum voltage that may be across the diode when both VPOS and VNEG are both active during switching of the DC/DC. Minimal reverse recovery time and parasitic capacitance is recommended in order to preserve efficiency of the DC/DC. The external diode should be rated for at least 500 mA average forward current.

Application Information (continued)

9.1.2 Voltage and Current Outputs on a Shared Terminal

Figure 123 illustrates a simplified block diagram of the voltage output stages of the DAC8771.

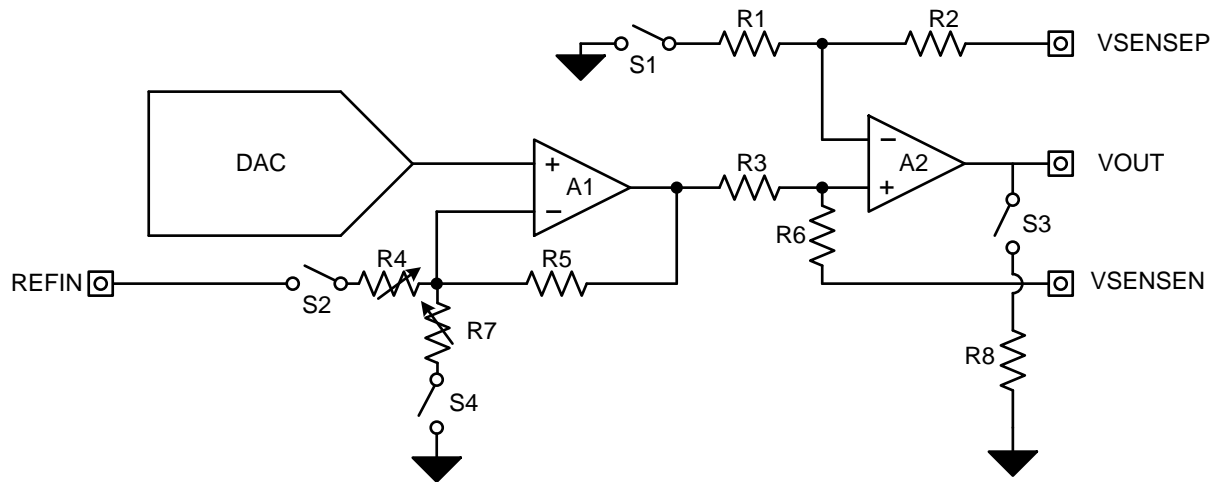

Copyright © 2018, Texas Instruments Incorporated

Figure 123. Simplified Block Diagram of Voltage Output Architecture

When designing for a shared voltage and current output terminal it is important to consider leakage paths that may corrupt the voltage or current output stages.

When the voltage output is active and the current output is inactive the IOUT pin becomes a high-impedance node and therefore does not significantly load the voltage output in a way that would degrade VOUT performance. When the voltage output is inactive and the current output is active switches S1, S2, and S4 all become open while switch S3 is controlled by the POC bit in the Reset Config Register. When the POC bit is set to a 0, the default value, switch S3 is closed when VOUT is disabled. This creates a leakage path with respect to the current output when the terminals are shared which will create a load dependent error. In order to reduce this error the POC bit can be set to a 1 which opens switch S3, effectively making the VOUT pin high-impedance and reducing the magnitude of leakage current.

9.1.3 Optimizing Current Output Settling Time with Auto-Learn Mode

When the buck-boost converter is active, power and heat dissipation of the device are at a minimum, however settling time of the current output is dominated by the slew rate of the buck-boost converter, which is significantly slower than the current output signal chain alone. When the buck-boost converter is bypassed settling time of the current output is minimized while power and heat dissipation are significant.

Auto-learn mode offers an alternative mode which allows the buck-boost converter to learn the size of the load and choose a clamped output value that does not change over the full range of the selected current output. This allows a balance between settling time and power dissipation. There are two options for entering auto-learn mode:

- Enable the buck-boost converter in full-tracking mode followed by enabling the current output. Until the DAC code 0x4000 is passed, settling time will be dominated by the buck-boost converter. After code 0x4000 is surpassed the buck-boost converter detects the load and sets the clamp value appropriately.
- Enable the buck-boost converter in clamp-mode with clamp value set to a greater voltage than required by the largest load the current output will be expected to drive, followed by enabling the current output. Enter full-tracking mode. In this case the clamp value is maintained without the buck-boost converter output changing, therefore settling time is set by the IOUT signal chain. After code 0x4000 is surpassed the buck-boost converter detects the load and adjusts the clamp value appropriately. At all times using this initialization procedure the settling time is defined by the IOUT signal chain.

Application Information (continued)

9.1.4 Protection for Industrial Transients

In order to successfully protect the DAC8771, or any integrated circuit, against industrial transient testing the internal structures and how they may behave when exposed to said signals must be understood. Figure 124 depicts a simplified representation of internal structures present on the device output pins which are represented as a pair of clamp-to-rail diodes connected to the VPOS_IN and VNEG_IN supply rails

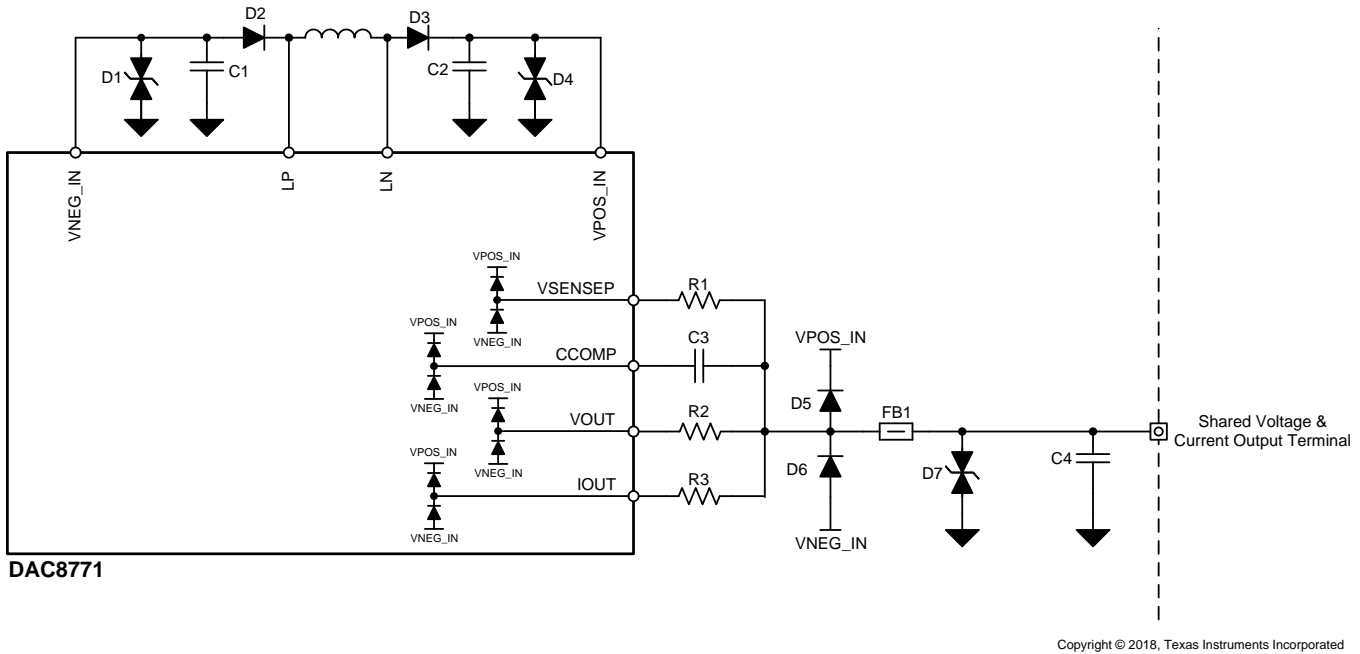

Figure 124. Simplified Block Diagram of Internal Structures and External Protection

When these internal structures are exposed to industrial transient testing, without the external protection components, the diode structures will become forward biased and conduct current. If the conducted current is too large, which is often true for high-voltage industrial transient tests, the structures will become permanently damaged and impact device functionality.

Both attenuation and diversion strategies are implemented to protect the internal structures as well as the device itself. Attenuation is realized by capacitor C4 which forms an R/C low-pass filter when interacting with the source impedance of the transient generator, ferrite bead FB1 also helps attenuate high-frequency current, along with both AC and DC current limiters realized by series pass elements R1, R2, and R3. Diversion is achieved by transient voltage suppressor (TVS) diode D7 and clamp-to-rail diodes D5 and D6. The combined effects of both strategies effectively limit the current flowing into the device and through the internal diode structures such that the device is not damaged and remains functional.

It is important to also include TVS diodes D1 and D4 at the VPOS_IN and VNEG_IN nodes in order to provide a discharge path for the energy that is going to be sent to these nodes through diodes D5, D6, and the internal diode structures. Without these diodes when current is diverted to these nodes, the DC/DC converter storage capacitors C1 and C2 will charge, and slowly increasing the voltage at these nodes.

9.1.5 Implementing HART with DAC8771

The DAC8771 features an internal resistor to convert a 500-mVpp HART FSK signal sourced by an external HART modem. These resistors are ratiometrically matched to the gain-setting resistors for the current output signal chain to ensure that a 500-mVpp input at the HART_IN pin is delivered as a 1-mApp signal at the IOUT pin regardless of which gain mode is selected.

An external capacitor, placed in series between the HART_IN pin and HART FSK source, is required to AC couple the HART FSK signal to the HART_IN pin. The recommended capacitance for this external capacitor is from 10 nF to 22 nF.

9.2 Typical Application

9.2.1 Single-Channel, Isolated, EMC and EMI Protected Analog Output Module with Adaptive Power Management

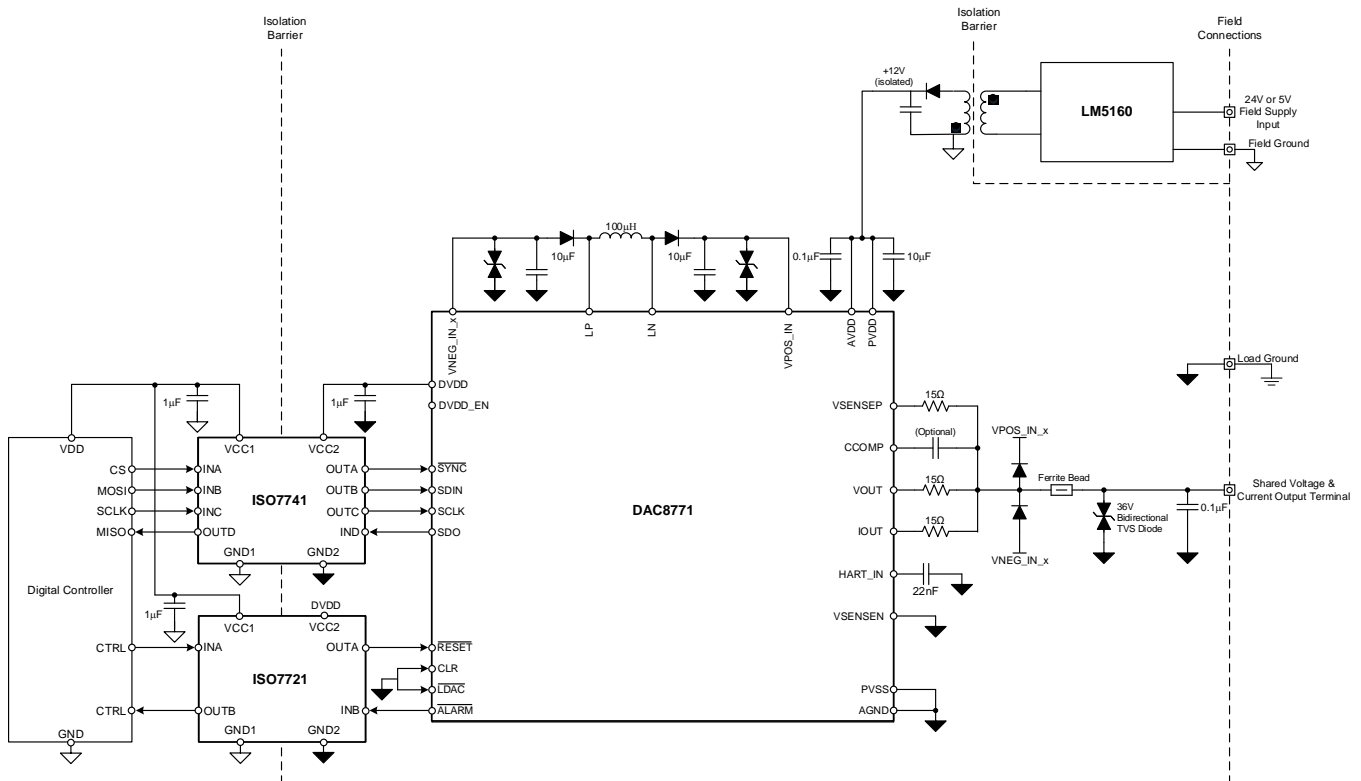

Figure 125. DAC8771 in Isolated Single-Channel PLC AO Module

9.2.2 Design Requirements

Analog I/O modules are used by programmable logic controllers (PLCs) to interface sensors, actuators, and other field instruments. These modules must meet stringent electrical specifications for both accuracy and robust protection. These outputs are typically current outputs based on the 4-mA to 20-mA range and derivatives or voltage outputs ranging from 0 V to 5 V, 0 V to 10 V, ± 5 V, and ± 10 V. Common error budgets accommodate 0.1% full-scale range total unadjusted error (% FSR TUE) at room temperature. Designs that desire stronger accuracy over temperature frequently implement calibration. Often the PLC back-plane provides access to a 12-V to 36-V analog supply from which a majority of analog supply voltages are derived.

Analog output modules are frequently multi-channel modules featuring either channel-to-channel isolation between each channel or group isolation where several channels share a common ground connection. As channel count increases it is desirable to maintain small form-factor requiring high levels of integration and reduced power dissipation in order to control heat inside of the PLC enclosure. This design example illustrates a single-channel with isolation, which could be extended for multiple channels to create a channel-to-channel isolated PLC AO module.

Therefore the design requirements are:

- Support of standard industrial automation voltage and current output spans
- Operation with standard industrial automation supply voltages from 12 V to 36 V
- Current and voltage outputs with TUE less than 0.1% at 25°C
- At minimum criteria B IEC61000-4 ESD, EFT, CI, and Surge immunity

Typical Application (continued)

9.2.3 Detailed Design Procedure

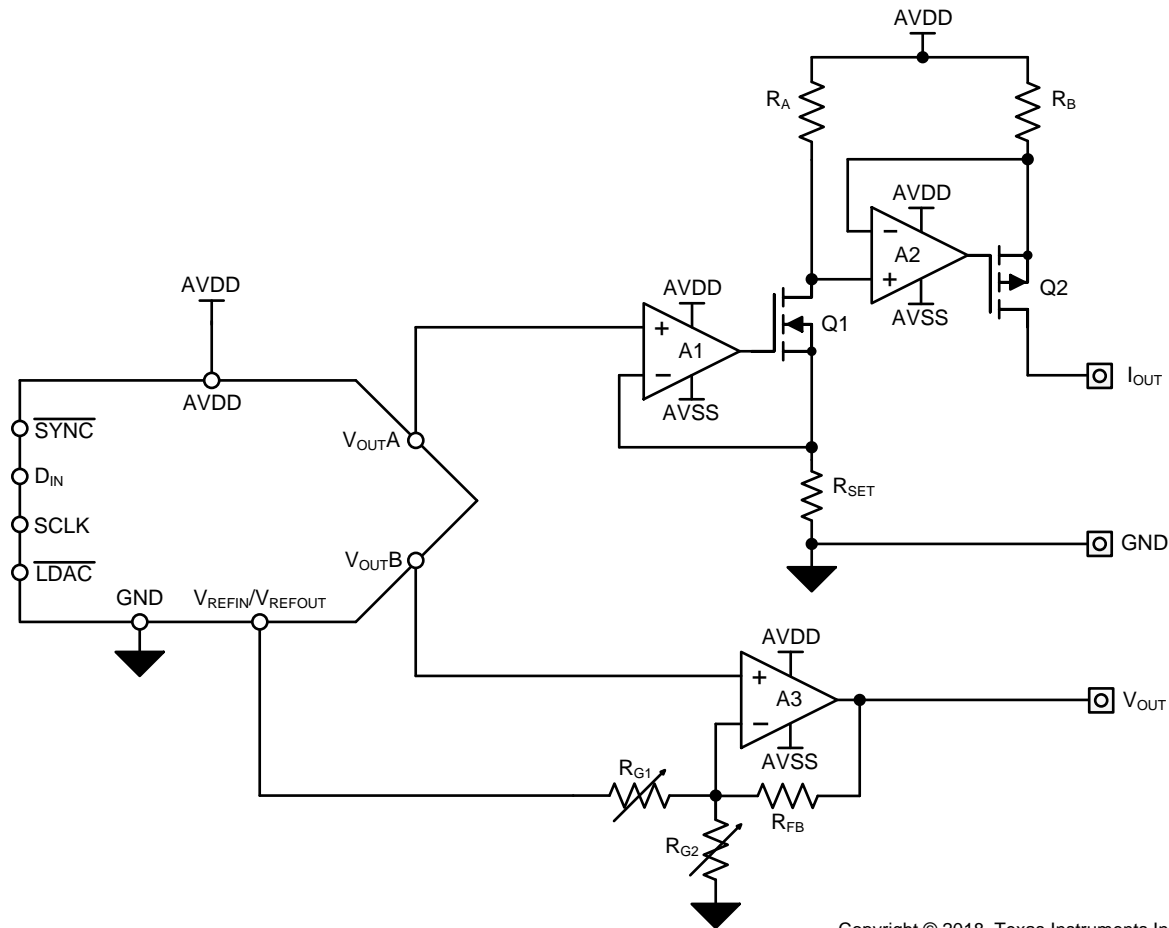

Copyright © 2018, Texas Instruments Incorporated

Figure 126. Generic Design for Typical PLC Current and Voltage Outputs

Figure 126 illustrates a common generic solution for realizing the desired voltage and current output spans for industrial automation applications.

The current output circuit is comprised of amplifiers A1 and A2, MOSFETs Q1 and Q2, and the three resistors RSET, RA, and RB. This two-stage current source enables the ground-referenced DAC output voltage to drive the high-side amplifier required for the current-source.

The voltage output circuit is composed of amplifier A3 and the resistor network consisting of RFB, RG1, and RG2. A3 operates as a modified summing amplifier, where the DAC controls the non-inverting input and inverting input has one path to GND and a second to VREF. This configuration allows the single-ended DAC to create both the unipolar 0-V to 5-V and 0-V to 10-V outputs and the bipolar ± 5 -V and ± 10 -V outputs by modifying the values of RG1 and RG2.

Though this generic circuit realizes the desired spans, both the voltage and current outputs have short-comings. The current output high-side supply voltage is typically 24 V, when driving low impedance loads with this supply voltage a considerable amount of power is dissipated on RB and Q2. This power dissipation results in increased heat which leads to drift errors for amplifiers A1 and A2 as well as the DAC, resistors, and the reference voltage. In order to reduce the power dissipation in the high-side voltage to current converter circuit a feedback system which monitors the voltage drop across Q2 and adaptively adjusts the high-side supply voltage can be implemented. This feedback system adjusts the high side supply voltage to the minimum supply required to keep Q2 in the linear region of operation, avoiding compliance voltage saturation, reducing power dissipation and heat to a minimum which helps maintain accuracy.

Typical Application (continued)

The generic voltage output circuit performs well but does not compensate for errors associated with excessive output impedance or differences in ground potential from the local PLC ground and the load ground. A modified circuit can be implemented which provides connections to sense errors associated with both output impedance voltage drops and differences in ground potentials, this circuit is shown in [Figure 123](#).

[Figure 125](#) illustrates the DAC8771 along with the LM5160 in a single-channel PLC analog output module. The DAC8771 includes the generic voltage and current output circuits along with buck-boost converter and feedback circuits for the current output and positive and negative sense connections for the voltage output circuit. The DAC8771 also includes an internal reference and internal LDO for supplying the field-side of a digital isolator along with the buck-boost converter generating the single or dual high voltage supplies required for the output circuits, all powered from a single supply.

The DAC8771 buck-boost converter operates at peak efficiency with 12-V input voltage with peak power consumption of approximately 250mW. The LM5160 circuit accepts a wide range of input voltages from just above 12 V to 30 V, providing coverage for most standard PLC supply voltages, and buck-converts this supply voltage to the optimal 12-V supply for the DAC8771. Cumulative power dissipation for the DAC8771 and LM5160 is under 550 mW.

Two ISO7641 devices implement galvanic isolation for all of the digital communication lines, though only a single ISO7641 is required for basic communication with the DAC8771 SPI compatible interface. An output protection circuit is included which is designed to provide immunity to the IEC61000-4 industrial transient and radiation test suite. The protection circuit includes transient voltage suppressor (TVS) diodes, clamp-to-rail steering diodes, and pass elements in the form of resistors and ferrite beads.

9.2.4 Application Curves

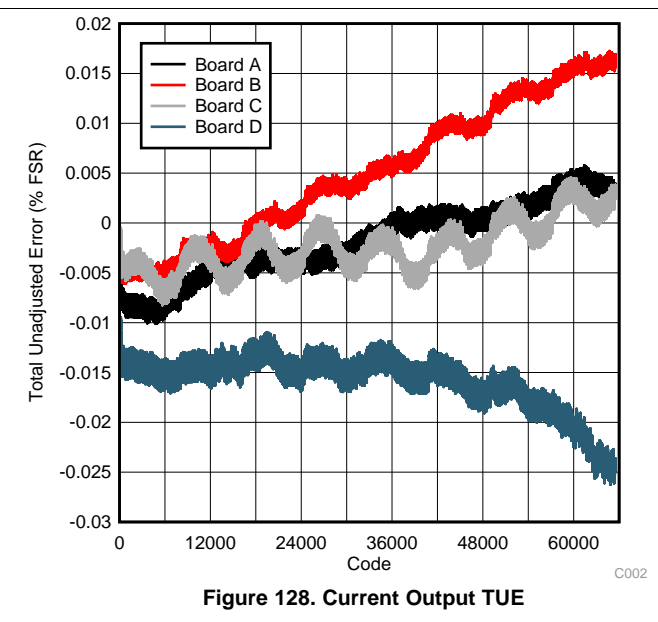
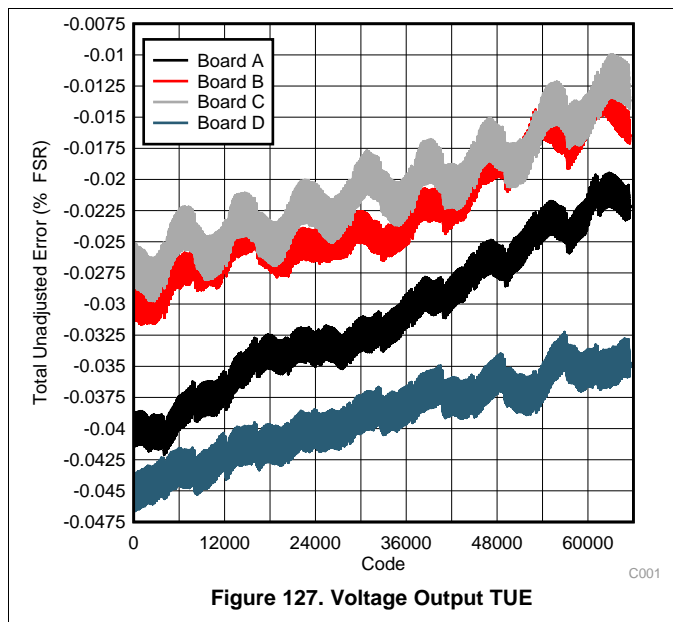

10 Power Supply Recommendations

There are three possible hardware power supply configurations for the DAC8771: the internal DC/DC provides both positive and negative supply voltages, the internal DC/DC provides only one of the supply voltages with an external supply provided on the other, or the internal DC/DC is not used at all and external supply voltages are provided for both positive and negative supply voltages. Simple illustrations for each case are as follows.

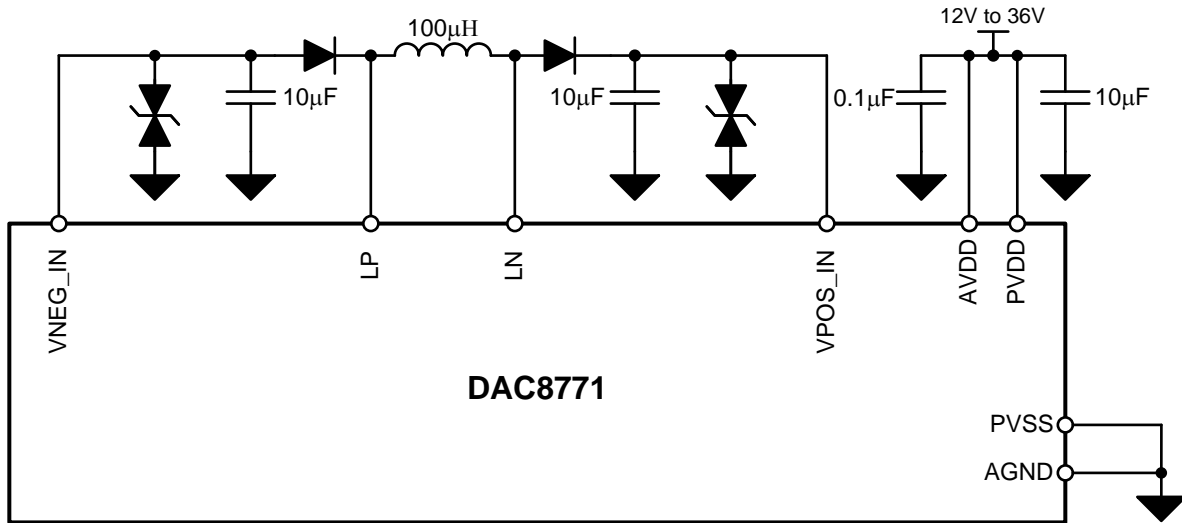

Copyright © 2018, Texas Instruments Incorporated

Figure 129. DAC8771 With Dual Supplies from Internal DC/DC

Figure 130 illustrates using a single supply from the DAC8771 internal DC/DC and the other supply from an external source. In this example the VNEG_IN supply is the input being supplied by an external supply, or ground for unipolar output spans. A similar scheme could be used if VPOS_IN was supplied by an external supply and VNEG_IN was supplied by the internal DC/DC.

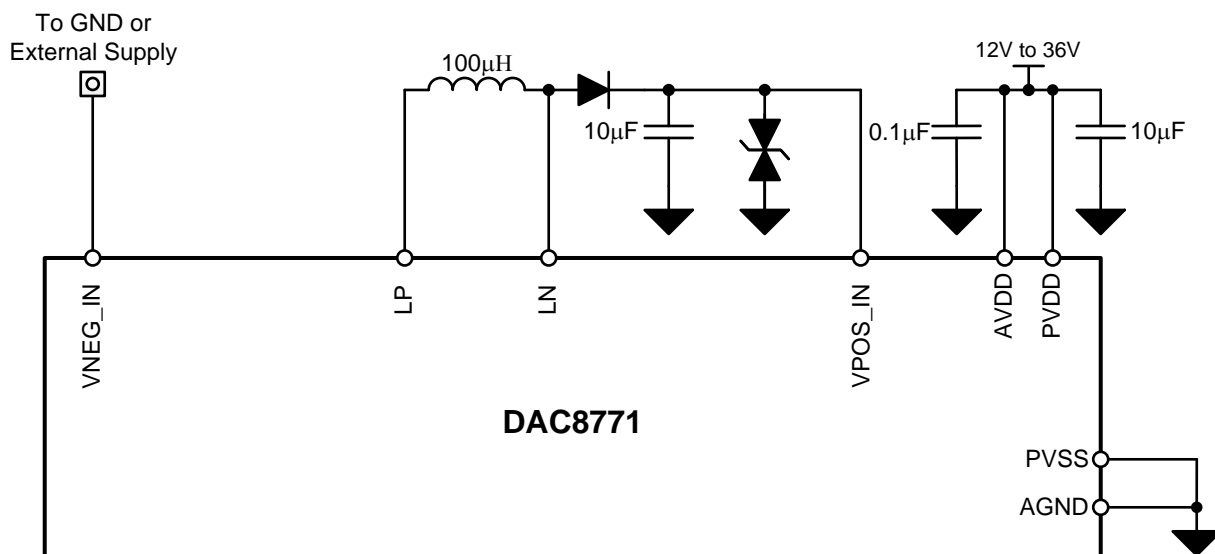

Copyright © 2018, Texas Instruments Incorporated

Figure 130. DAC8771 With Single Supply from Internal DC/DC

The scheme in [Figure 131](#) should be used if the internal DC/DC is not used at all and external supplies are selected for VPOS_IN and VNEG_IN. When using external supplies for VPOS_IN it is important that VPOS_IN, PVDD, and AVDD nodes are tied to the same voltage potential with the same ramp-rate

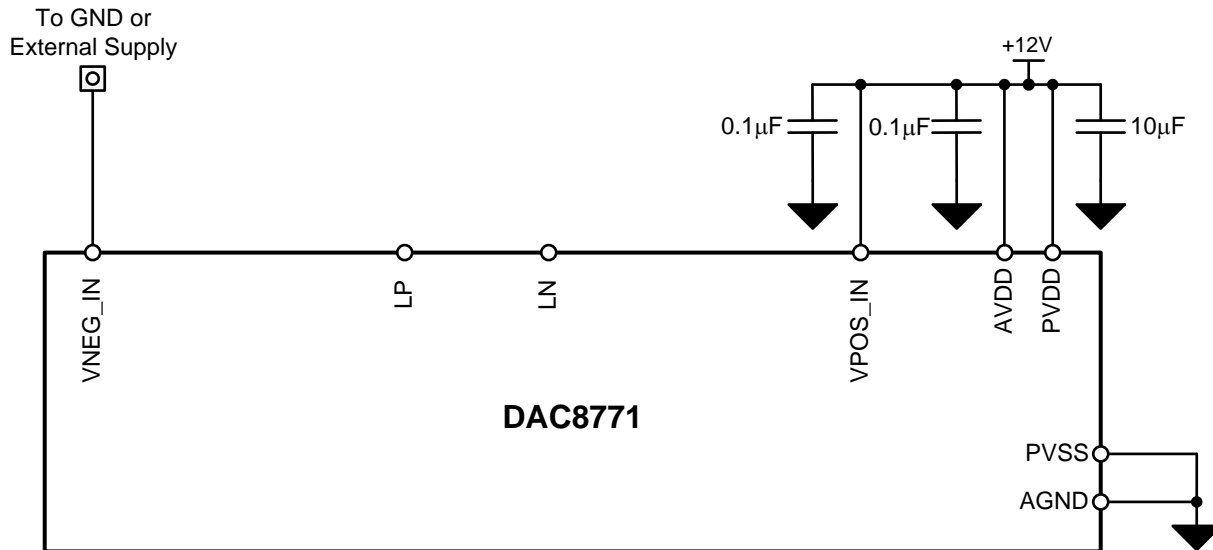

Copyright © 2018, Texas Instruments Incorporated

Figure 131. DAC8771 With External Supplies

11 Layout

11.1 Layout Guidelines

An example layout based on the design discussed in the [Typical Application](#) section is shown in the [Layout Example](#) section. [Figure 132](#) shows the top-layer of the design which illustrates all component placement as no components are placed on the bottom layer. [Figure 133](#) shows the internal power-layers for the internal buck-boost converter outputs.

The layer stack-up for this 4-layer example layout is shown below. A 4-layer design is not required, however provides optimal conditions for ground and power-supply planes. The solid ground plane beneath the majority of the signal traces, which are placed on the top layer, allows for a clean return path for sensitive analog traces and keeps them isolated from the internal power supply nets which will exhibit ripple from the DC/DC converter.

Table 24. Example Layout Layer Stack-Up

Signal Traces and Ground Fill
SOLID Ground Plane
Split Power Supply Plane for VPOS, VNEG, and DVDD
Signal Traces and Ground Fill

Traces for the DC/DC external components should be as low impedance, low inductance, and low capacitance as possible in order to maintain optimum performance. As such wide traces should be used to minimize inductance with minimal use of vias as vias contribute large inductance and capacitance to the trace. For this reason, it is recommended that all DC/DC components placed on the top layer.

The industrial transient protection circuit should be placed as close to the output connectors as possible to ensure that the return currents from these transients have a controlled path to exit the PCB which does not impact the analog circuitry.

Split ground planes for the DC/DC, digital, and analog grounds are not required but may be helpful to isolated ground return currents from cross-talk. If split ground planes are used, care should be taken to ensure that signal traces are only placed above or below the locations where their respective grounds are placed in order to mitigate unexpected return paths or coupling to the other ground planes. If a single ground plane is used, it is advisable to follow similar practices implementing a star-ground where the respective return currents interact with one another minimally. The example layout uses a single ground plane, based on measured results, performs similarly to an identical version with split ground planes.

The perimeter of the board is stitched with vias in order to enhance design performance against environments which may include radiated emissions. Additional vias are placed in critical areas nearby the design in order to place ground pours in between nodes to reduce cross-talk between adjacent traces.

Standard best-practices should be applied to the remaining components, including but not limited to, placing decoupling capacitors close to their respective pins and using wide traces or copper pours where possible, particularly for power traces where high current may flow.

11.2 Layout Example

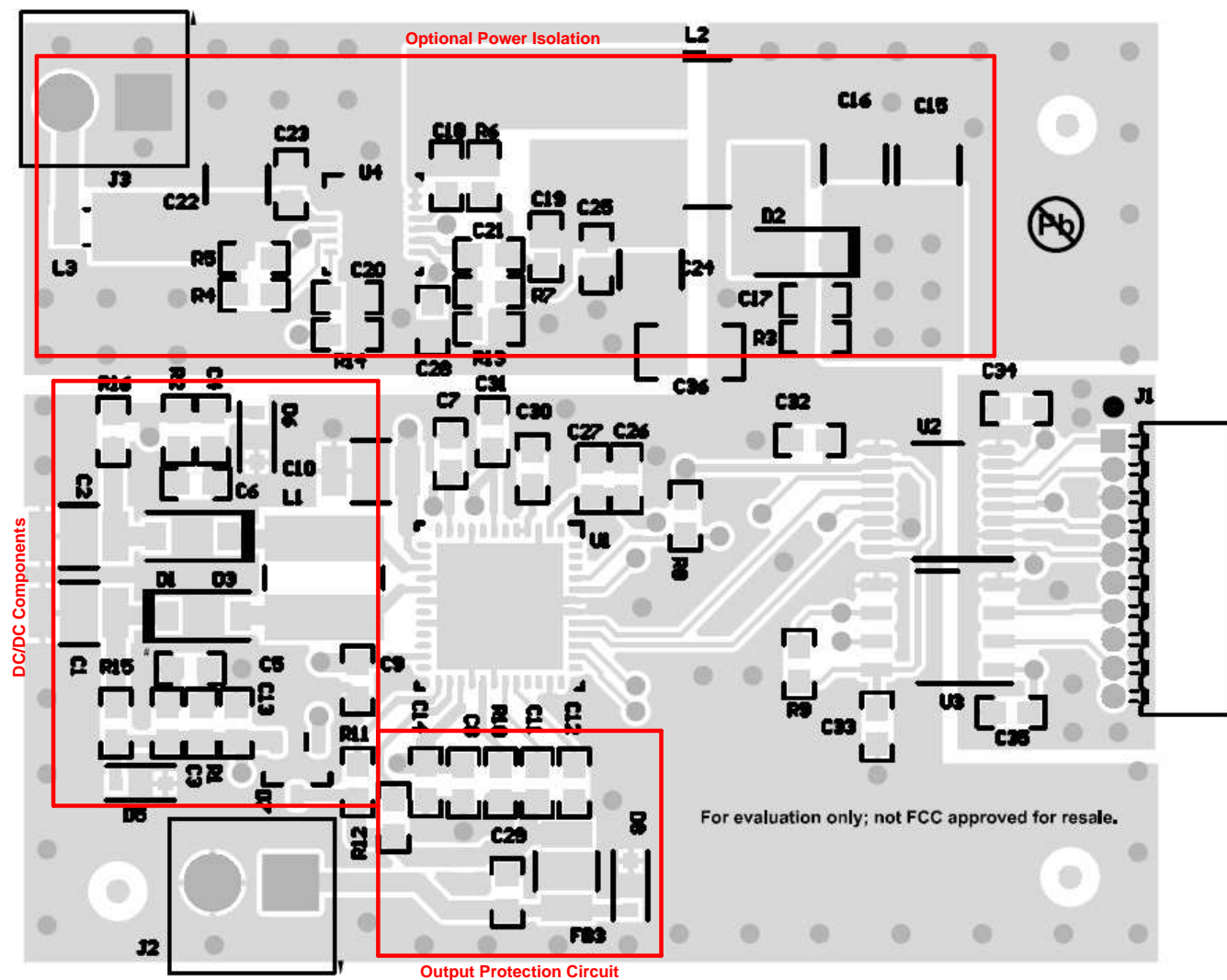

Figure 132. Application Example Layout

Layout Example (continued)

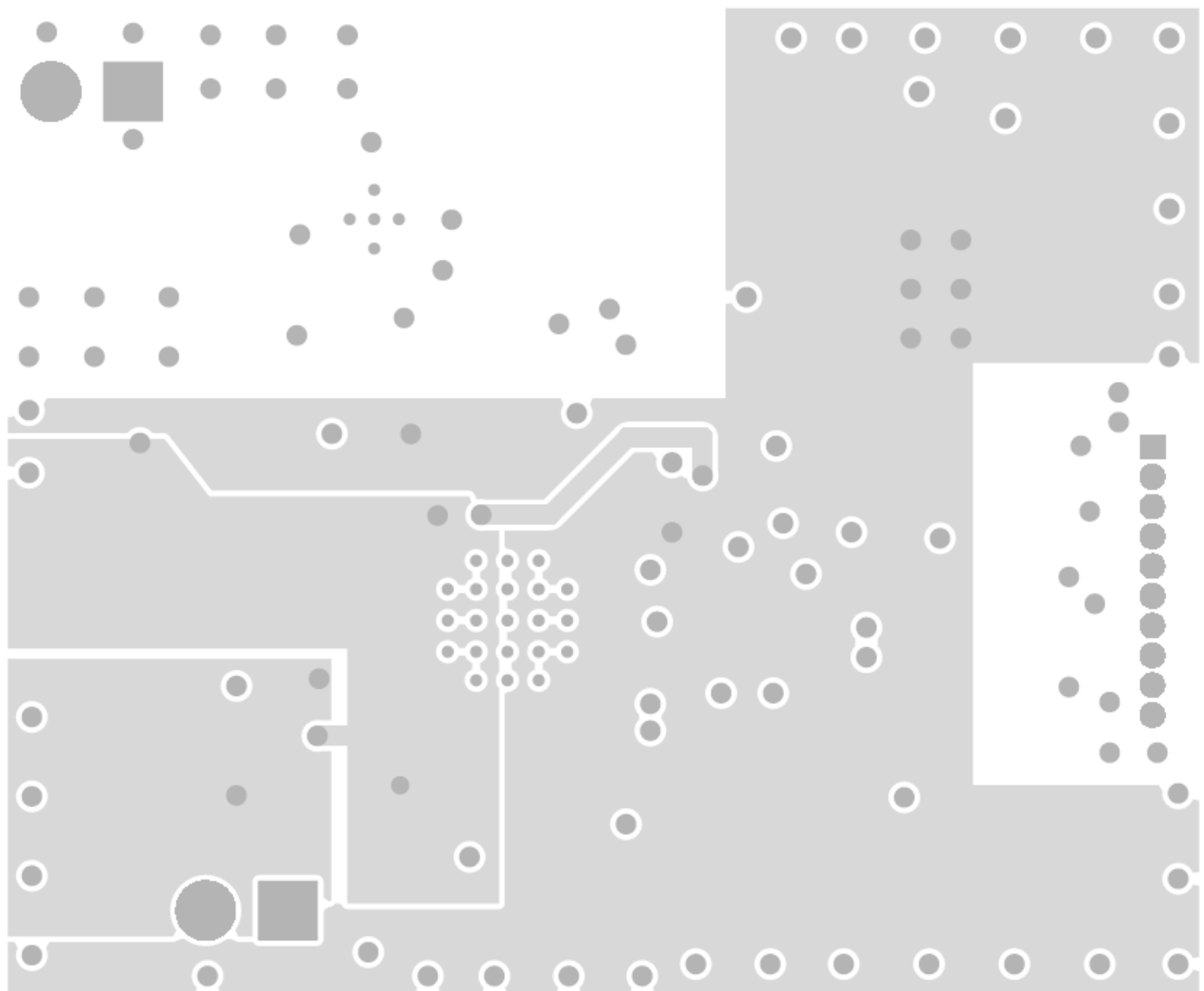

Figure 133. Example Design Internal Copper Pours

Layout Example (continued)

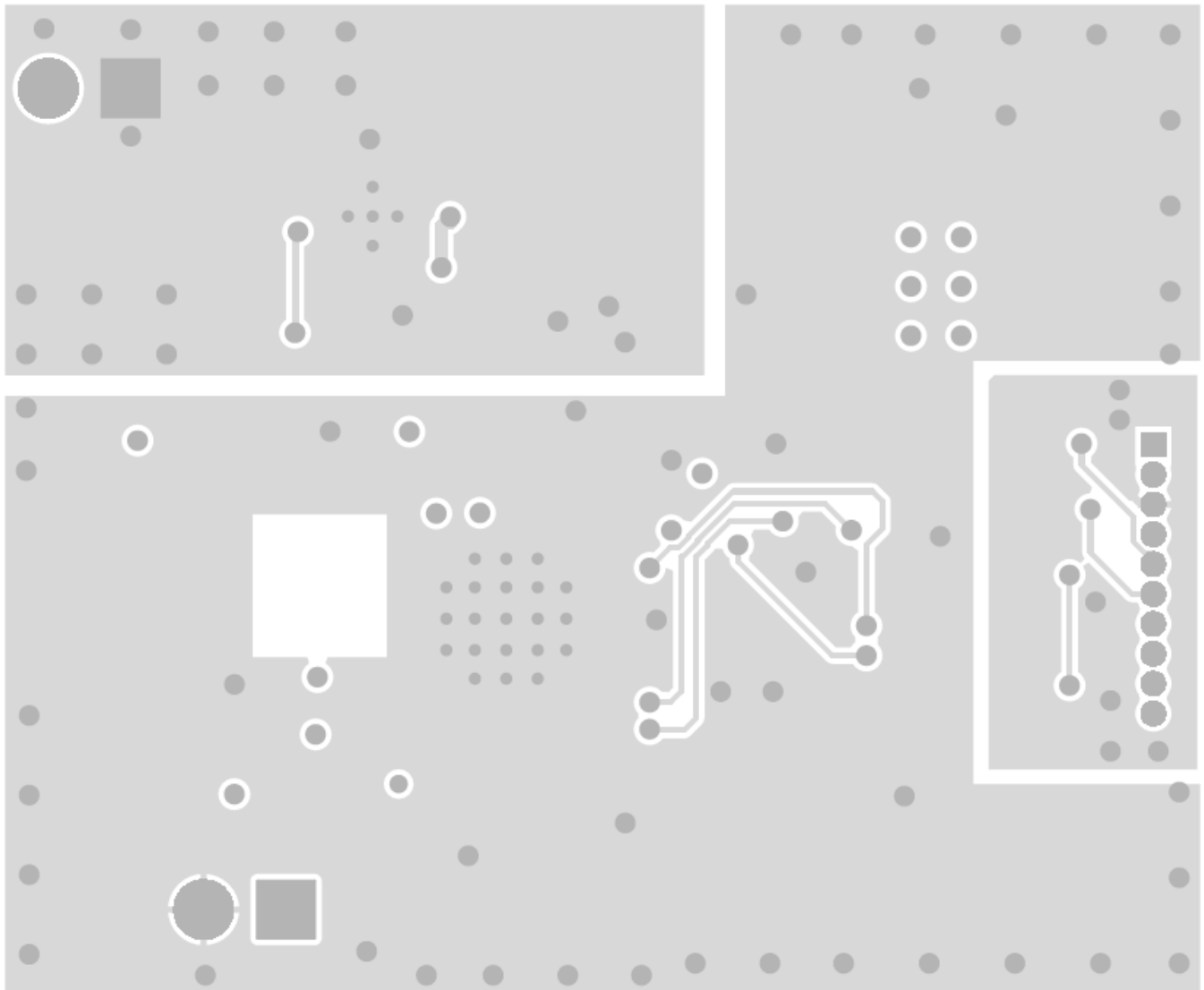

Figure 134. Example Design Bottom Layer

12 Device and Documentation Support

12.1 Device Support

12.1.1 Third-Party Products Disclaimer

TI'S PUBLICATION OF INFORMATION REGARDING THIRD-PARTY PRODUCTS OR SERVICES DOES NOT CONSTITUTE AN ENDORSEMENT REGARDING THE SUITABILITY OF SUCH PRODUCTS OR SERVICES OR A WARRANTY, REPRESENTATION OR ENDORSEMENT OF SUCH PRODUCTS OR SERVICES, EITHER ALONE OR IN COMBINATION WITH ANY TI PRODUCT OR SERVICE.

12.2 Documentation Support

12.2.1 Related Documentation

For related documentation see the following:

- *Semiconductor and IC Package Thermal Metrics* application report, [SPRA953](#)

12.3 Receiving Notification of Documentation Updates

To receive notification of documentation updates, navigate to the device product folder on ti.com. In the upper right corner, click on *Alert me* to register and receive a weekly digest of any product information that has changed. For change details, review the revision history included in any revised document.

12.4 Community Resources

The following links connect to TI community resources. Linked contents are provided "AS IS" by the respective contributors. They do not constitute TI specifications and do not necessarily reflect TI's views; see TI's [Terms of Use](#).

TI E2E™ Online Community *TI's Engineer-to-Engineer (E2E) Community*. Created to foster collaboration among engineers. At e2e.ti.com, you can ask questions, share knowledge, explore ideas and help solve problems with fellow engineers.

Design Support *TI's Design Support* Quickly find helpful E2E forums along with design support tools and contact information for technical support.

12.5 Trademarks

Microwire, E2E are trademarks of Texas Instruments.
 SPI, QSPI are trademarks of Motorola, Inc.
 All other trademarks are the property of their respective owners.

12.6 Electrostatic Discharge Caution



This integrated circuit can be damaged by ESD. Texas Instruments recommends that all integrated circuits be handled with appropriate precautions. Failure to observe proper handling and installation procedures can cause damage.

ESD damage can range from subtle performance degradation to complete device failure. Precision integrated circuits may be more susceptible to damage because very small parametric changes could cause the device not to meet its published specifications.

12.7 Glossary

[SLYZ022](#) — *TI Glossary*.

This glossary lists and explains terms, acronyms, and definitions.

13 Mechanical, Packaging, and Orderable Information

The following pages include mechanical, packaging, and orderable information. This information is the most current data available for the designated devices. This data is subject to change without notice and revision of this document. For browser-based versions of this data sheet, refer to the left-hand navigation.

PACKAGING INFORMATION

Orderable Device	Status (1)	Package Type	Package Drawing	Pins	Package Qty	Eco Plan (2)	Lead finish/ Ball material (6)	MSL Peak Temp (3)	Op Temp (°C)	Device Marking (4/5)	Samples
DAC8771RGZR	ACTIVE	VQFN	RGZ	48	2500	RoHS & Green	Call TI NIPDAU	Level-3-260C-168 HR	-40 to 125	DAC8771	Samples
DAC8771RGZT	ACTIVE	VQFN	RGZ	48	250	RoHS & Green	Call TI NIPDAU	Level-3-260C-168 HR	-40 to 125	DAC8771	Samples

(1) The marketing status values are defined as follows:

ACTIVE: Product device recommended for new designs.

LIFEBUY: TI has announced that the device will be discontinued, and a lifetime-buy period is in effect.

NRND: Not recommended for new designs. Device is in production to support existing customers, but TI does not recommend using this part in a new design.

PREVIEW: Device has been announced but is not in production. Samples may or may not be available.

OBSOLETE: TI has discontinued the production of the device.

(2) **RoHS:** TI defines "RoHS" to mean semiconductor products that are compliant with the current EU RoHS requirements for all 10 RoHS substances, including the requirement that RoHS substance do not exceed 0.1% by weight in homogeneous materials. Where designed to be soldered at high temperatures, "RoHS" products are suitable for use in specified lead-free processes. TI may reference these types of products as "Pb-Free".

RoHS Exempt: TI defines "RoHS Exempt" to mean products that contain lead but are compliant with EU RoHS pursuant to a specific EU RoHS exemption.

Green: TI defines "Green" to mean the content of Chlorine (Cl) and Bromine (Br) based flame retardants meet JS709B low halogen requirements of <=1000ppm threshold. Antimony trioxide based flame retardants must also meet the <=1000ppm threshold requirement.

(3) MSL, Peak Temp. - The Moisture Sensitivity Level rating according to the JEDEC industry standard classifications, and peak solder temperature.

(4) There may be additional marking, which relates to the logo, the lot trace code information, or the environmental category on the device.

(5) Multiple Device Markings will be inside parentheses. Only one Device Marking contained in parentheses and separated by a "~" will appear on a device. If a line is indented then it is a continuation of the previous line and the two combined represent the entire Device Marking for that device.

(6) Lead finish/Ball material - Orderable Devices may have multiple material finish options. Finish options are separated by a vertical ruled line. Lead finish/Ball material values may wrap to two lines if the finish value exceeds the maximum column width.

Important Information and Disclaimer:The information provided on this page represents TI's knowledge and belief as of the date that it is provided. TI bases its knowledge and belief on information provided by third parties, and makes no representation or warranty as to the accuracy of such information. Efforts are underway to better integrate information from third parties. TI has taken and continues to take reasonable steps to provide representative and accurate information but may not have conducted destructive testing or chemical analysis on incoming materials and chemicals. TI and TI suppliers consider certain information to be proprietary, and thus CAS numbers and other limited information may not be available for release.

In no event shall TI's liability arising out of such information exceed the total purchase price of the TI part(s) at issue in this document sold by TI to Customer on an annual basis.

TAPE AND REEL INFORMATION



QUADRANT ASSIGNMENTS FOR PIN 1 ORIENTATION IN TAPE



*All dimensions are nominal

Device	Package Type	Package Drawing	Pins	SPQ	Reel Diameter (mm)	Reel Width W1 (mm)	A0 (mm)	B0 (mm)	K0 (mm)	P1 (mm)	W (mm)	Pin1 Quadrant
DAC8771RGZR	VQFN	RGZ	48	2500	330.0	16.4	7.3	7.3	1.1	12.0	16.0	Q2
DAC8771RGZT	VQFN	RGZ	48	250	180.0	16.4	7.3	7.3	1.1	12.0	16.0	Q2

TAPE AND REEL BOX DIMENSIONS

*All dimensions are nominal

Device	Package Type	Package Drawing	Pins	SPQ	Length (mm)	Width (mm)	Height (mm)
DAC8771RGZR	VQFN	RGZ	48	2500	367.0	367.0	38.0
DAC8771RGZT	VQFN	RGZ	48	250	210.0	185.0	35.0

GENERIC PACKAGE VIEW

RGZ 48

VQFN - 1 mm max height

7 x 7, 0.5 mm pitch

PLASTIC QUADFLAT PACK- NO LEAD

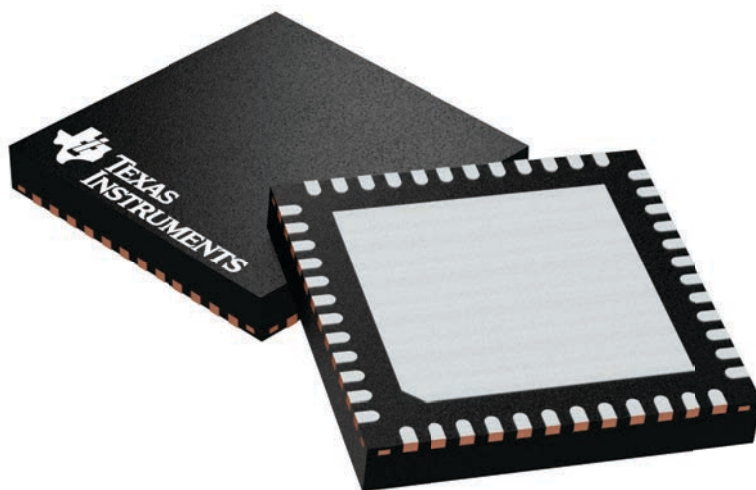

Images above are just a representation of the package family, actual package may vary.
Refer to the product data sheet for package details.

4224671/A

RGZ0048D

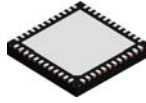

PACKAGE OUTLINE

VQFN - 1 mm max height

PLASTIC QUAD FLATPACK - NO LEAD

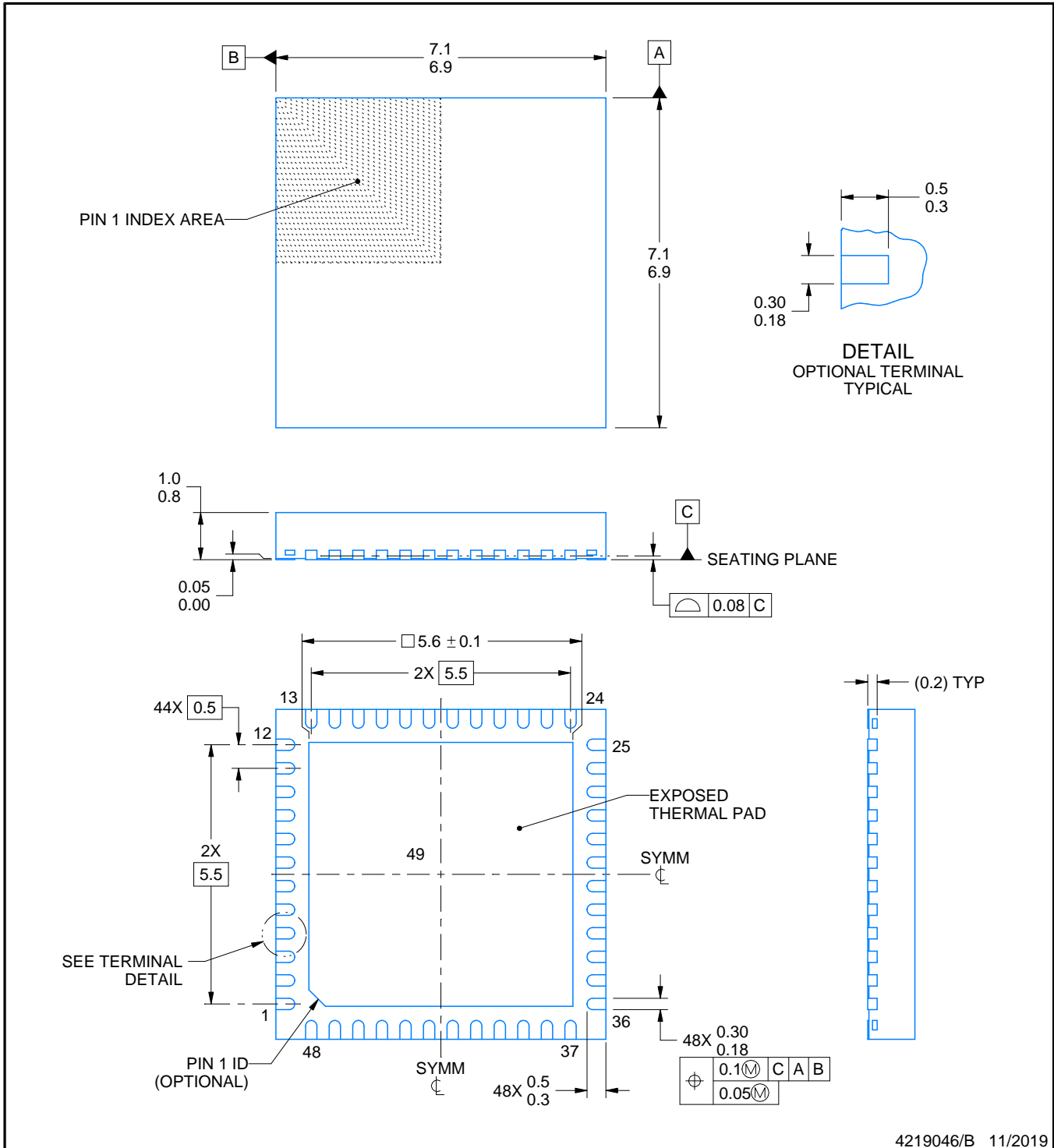

4219046/B 11/2019

NOTES:

1. All linear dimensions are in millimeters. Any dimensions in parenthesis are for reference only. Dimensioning and tolerancing per ASME Y14.5M.
2. This drawing is subject to change without notice.
3. The package thermal pad must be soldered to the printed circuit board for thermal and mechanical performance.

EXAMPLE BOARD LAYOUT

RGZ0048D

VQFN - 1 mm max height

PLASTIC QUAD FLATPACK - NO LEAD

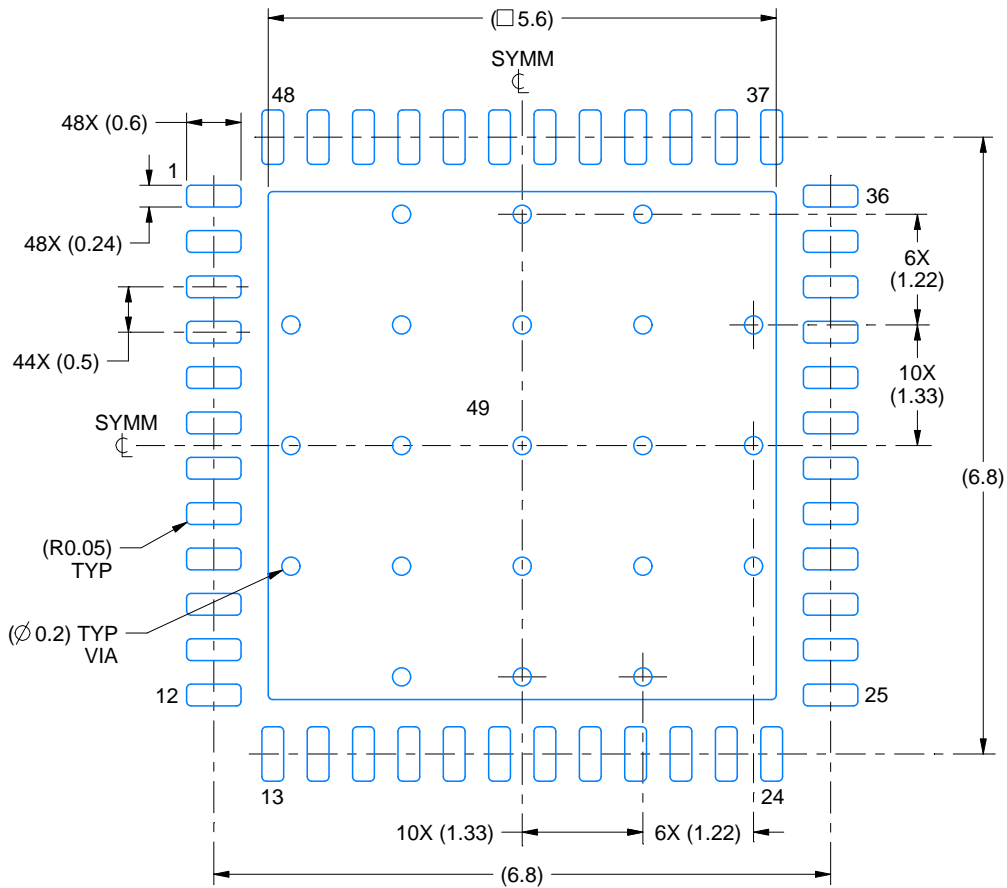

LAND PATTERN EXAMPLE
EXPOSED METAL SHOWN
SCALE:12X

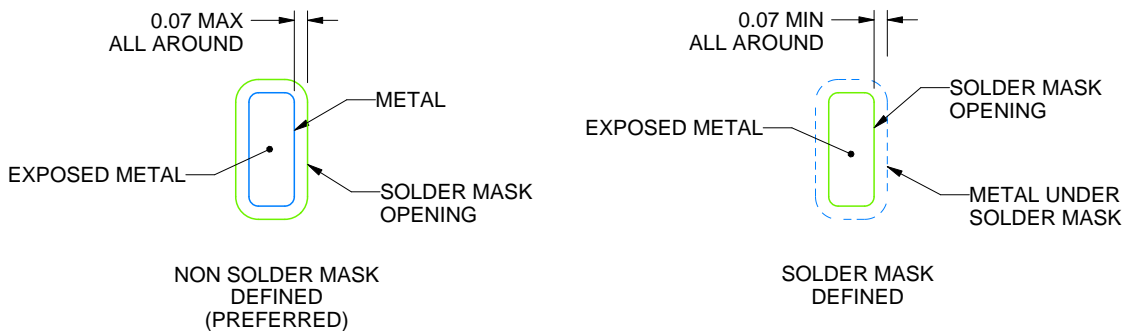

SOLDER MASK DETAILS

4219046/B 11/2019

NOTES: (continued)

4. This package is designed to be soldered to a thermal pad on the board. For more information, see Texas Instruments literature number SLUA271 (www.ti.com/lit/sl原因271).
5. Vias are optional depending on application, refer to device data sheet. If any vias are implemented, refer to their locations shown on this view. It is recommended that vias under paste be filled, plugged or tented.

IMPORTANT NOTICE AND DISCLAIMER

TI PROVIDES TECHNICAL AND RELIABILITY DATA (INCLUDING DATA SHEETS), DESIGN RESOURCES (INCLUDING REFERENCE DESIGNS), APPLICATION OR OTHER DESIGN ADVICE, WEB TOOLS, SAFETY INFORMATION, AND OTHER RESOURCES "AS IS" AND WITH ALL FAULTS, AND DISCLAIMS ALL WARRANTIES, EXPRESS AND IMPLIED, INCLUDING WITHOUT LIMITATION ANY IMPLIED WARRANTIES OF MERCHANTABILITY, FITNESS FOR A PARTICULAR PURPOSE OR NON-INFRINGEMENT OF THIRD PARTY INTELLECTUAL PROPERTY RIGHTS.

These resources are intended for skilled developers designing with TI products. You are solely responsible for (1) selecting the appropriate TI products for your application, (2) designing, validating and testing your application, and (3) ensuring your application meets applicable standards, and any other safety, security, regulatory or other requirements.

These resources are subject to change without notice. TI grants you permission to use these resources only for development of an application that uses the TI products described in the resource. Other reproduction and display of these resources is prohibited. No license is granted to any other TI intellectual property right or to any third party intellectual property right. TI disclaims responsibility for, and you will fully indemnify TI and its representatives against, any claims, damages, costs, losses, and liabilities arising out of your use of these resources.

TI's products are provided subject to [TI's Terms of Sale](#) or other applicable terms available either on [ti.com](https://www.ti.com) or provided in conjunction with such TI products. TI's provision of these resources does not expand or otherwise alter TI's applicable warranties or warranty disclaimers for TI products.

TI objects to and rejects any additional or different terms you may have proposed.

Mailing Address: Texas Instruments, Post Office Box 655303, Dallas, Texas 75265
Copyright © 2024, Texas Instruments Incorporated