

HDC3120-Q1 High-Accuracy (1%RH, 0.2°C) Analog Humidity and Temperature Sensor, With Low Long-Term Drift (0.19%RH/yr), and 4s RH% Response

1 Features

- AEC-Q100 qualified for automotive applications
 - Temperature Grade 1: -40°C to 125°C
 - Device HBM ESD Classification Level 2
 - Device CDM ESD Classification Level C4
- **Functional Safety-Capable**
 - [Documentation to aid functional safety system design](#)
- Relative humidity (RH) sensor:
 - Operating range: 0% to 100%RH
 - Accuracy: $\pm 1\%$ RH typical
 - Long-term drift: 0.19%RH/yr
 - Ratiometric Output: 10.0% to 90.0%V_{DD}
- Temperature sensor:
 - Operating range: -40°C to 125°C
 - Accuracy: $\pm 0.2^{\circ}\text{C}$ typical
 - Ratiometric Output: 12.3% to 87.7%V_{DD}
- NIST traceability
- Output Short Circuit Protection
- Integrated heater
- High capacitive load drive up to 47nF
- Low power: 250 μA typical active current
- Supply voltage: 1.62V to 5.50V

2 Applications

- **Automotive:**
 - [ADAS Systems](#)
 - [Automotive Cameras](#)
 - [Automotive LIDAR Modules](#)
 - [Electronic Power Steering Systems](#)

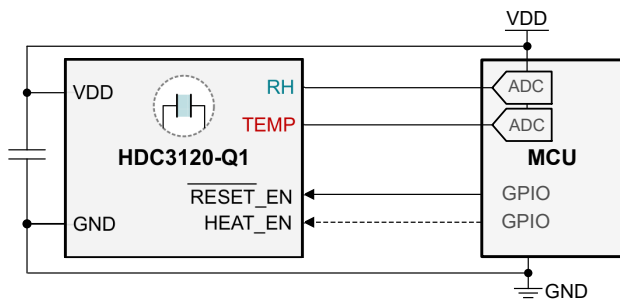

Figure 2-1. Typical Application

3 Description

The HDC3120-Q1 is an integrated, capacitive based relative humidity (RH) and temperature sensor where the relative humidity and temperature sensor results are represented as ratiometric analog output. Conversion of signals to the analog domain provides a robust design for applications requiring signal transmission over wire or other distance-based use cases. The device provides high accuracy measurements over a wide supply range (1.62V – 5.5V) and low power consumption while maintaining less than 0.19% long term drift per year. The HDC3120-Q1 is available in a compact 2.5mm × 2.5mm × 0.8mm WSON 8-pin package. Both the temperature and humidity sensors are 100% tested and calibrated on a production setup that is NIST traceable and verified with equipment that is calibrated to ISO/IEC 17025 standards.

Package Information

PART NUMBER	PACKAGE ⁽¹⁾	PACKAGE SIZE ⁽²⁾
HDC3120-Q1	WSON (8)	2.50mm × 2.50mm × 0.75mm

- (1) For more information, see [Section 11](#).
- (2) The package size (length × width) is a nominal value and includes pins, where applicable.

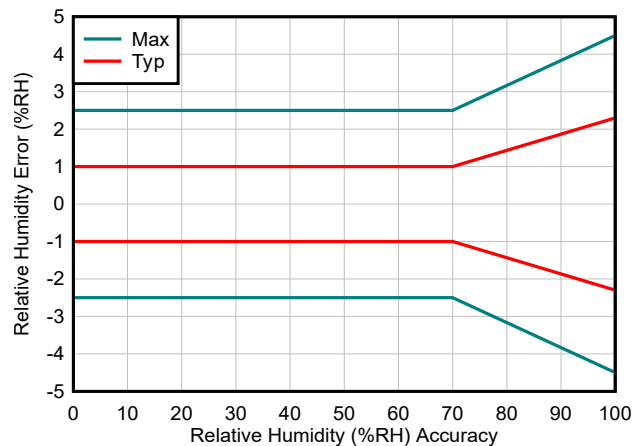

Relative Humidity (%RH) Accuracy



Table of Contents

1 Features	1	8 Application and Implementation	26
2 Applications	1	8.1 Application Information.....	26
3 Description	1	8.2 Typical Application.....	26
4 Device Comparison	3	8.3 Power Supply Recommendations.....	29
5 Pin Configuration and Functions	5	8.4 Layout.....	29
6 Specifications	6	8.5 Storage and PCB Assembly.....	31
6.1 Absolute Maximum Ratings.....	6	9 Device and Documentation Support	34
6.2 ESD Ratings.....	6	9.1 Documentation Support.....	34
6.3 Recommended Operating Conditions.....	6	9.2 Receiving Notification of Documentation Updates....	34
6.4 Thermal Information.....	6	9.3 Support Resources.....	34
6.5 Electrical Characteristics.....	7	9.4 Trademarks.....	34
6.6 Typical Characteristics.....	9	9.5 Electrostatic Discharge Caution.....	34
7 Detailed Description	13	9.6 Glossary.....	34
7.1 Overview.....	13	10 Revision History	34
7.2 Functional Block Diagram.....	13	11 Mechanical, Packaging, and Orderable Information	34
7.3 Feature Description.....	14		
7.4 Device Functional Modes.....	21		

4 Device Comparison

Table 4-1. TI Automotive Humidity Device Comparison

	HDC3120-Q1	HDC3020-Q1
Interface	Analog	Digital, I ² C
Relative Humidity (RH) Sensor		
Typ RH accuracy (%RH)	±1.0 (0 to 70%RH)	±0.5 (10 to 50%RH) ±1.0 (0 to 80%RH)
Max RH accuracy (%RH)	±2.5 (0 to 70%RH) ±4.0 (0 to 90%RH)	±2.0 (0 to 80%RH) ±3.0 (0 to 90%RH)
Hysteresis (%RH)	±0.8	
RH repeatability (%RH)	±0.02	
RH long-term drift (%RH/yr)	±0.19	
Operating range (%RH)	0 to 100	
RH response time (s)	4	
Temperature Sensor		
Typ temp accuracy (°C)	±0.1 (-10 to 60°C)	±0.1 (0 to 50°C)
Max temp accuracy (°C)	±0.3 (-10 to 60°C)	±0.2 (0 to 50°C)
Temp repeatability (°C)	±0.04	
Temp long-term drift (°C/yr)	±0.03	
Operating range (°C)	-40°C to 125°C	
Response time (s)	1.8	2.0
Electrical Specifications		
Supply voltage range (V)	1.62 to 5.5	
Typ avg current, 1Hz (µA)	250	1.3 (High) 0.7 (Low)
Sleep current (µA)	50 (Disabled)	0.360
I2C Addresses	-	4
On-Chip Heater		
Max Power (mW)	140	249
Heater Type	Fixed	Programmable
Protective Cover Options		
Removable Tape	Planned ⁽¹⁾	HDC3021-Q1
Permanent IP67 Filter	Planned ⁽¹⁾	HDC3022-Q1
Other Features		
NIST Traceable	Yes ⁽²⁾	Yes ⁽²⁾
Commercial Version	HDC3120	HDC3020
Package Dimensions (mm)	2.5×2.5×0.8	

(1) Contact TI to inquire about future protection options for HDC3120-Q1

(2) Contact TI for additional NIST information

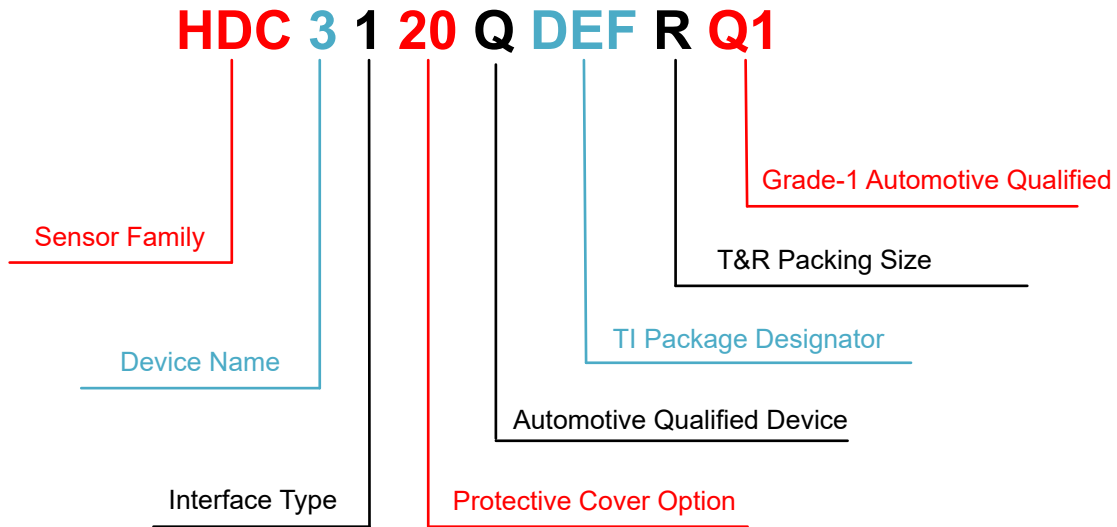

Figure 4-1. HDC3120-Q1 Device Nomenclature

Table 4-2. HDC3120-Q1 Nomenclature

Field Description	Field Detail
Sensor Family	HDC: Humidity Sensors
Generation	3: 3 rd Generation HDC Sensors
Interface Type	0: Digital, I2C 1: Analog, Ratiometric
Protective Cover Option	20: No protective cover 21: Removable tape cover 22: Permanent IP67 filter cover
Grade	Q: Automotive Qualified
TI Package Designator	DEF: 8-Pin DFN, 2.50mm × 2.50mm
T&R Packing Size	R: Large T&R, SPQ = 3,000 units
Automotive Grade Category	Q1: Automotive Grade-1

5 Pin Configuration and Functions

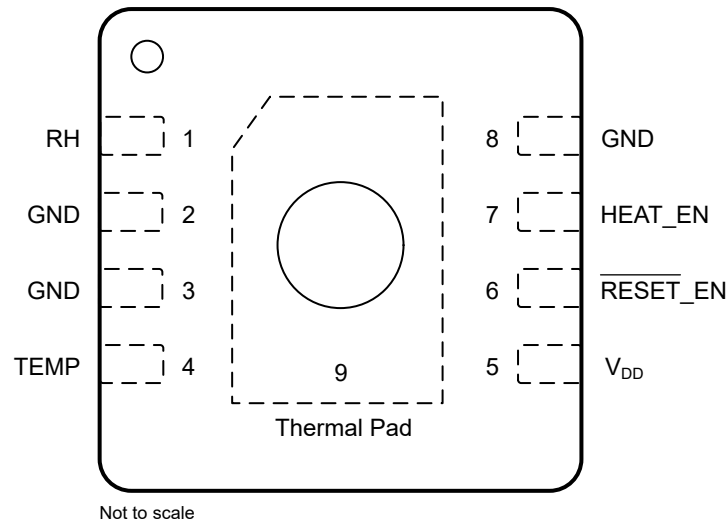

Figure 5-1. DEF Package 8-Pin WSON Transparent Top View

Table 5-1. Pin Functions

PIN		TYPE ⁽¹⁾	DESCRIPTION
NAME	NO.		
RH	1	O	Provides a ratiometric analog output voltage representing relative humidity (RH%). For details, see Section 7.3.3.1 .
GND	2,3,8	G	Ground/VSS. Connect all GND pins to ground for stable operation.
TEMP	4	O	Provides a ratiometric analog output voltage representing temperature. For details, see Section 7.3.3.2 .
V _{DD}	5	P	Supply Voltage, from 1.62V to 5.50V
$\overline{\text{RESET_EN}}$	6	I	Drives the device into reset/disable mode when pulled low for at least 1 μ s. The device includes a 51k Ω internal pull-up to V _{DD} . If unused, leave the pin floating, connect the pin directly to V _{DD} , or use an external pull-up resistor to V _{DD} . For details, see Section 7.3.2 .
HEAT_EN	7	O	Activates the on-chip heater when driven high. Leaving the pin floating can cause the heater to intermittently turn-on. If on-chip heater is not used, connect to GND. For details, see Section 7.4.1 .
Thermal Pad	9	G	Internally connected to GND. Depending on the system requirements, the pin can be soldered or left unsoldered. Soldering is not required for mechanical stability. Leaving the thermal pad unsoldered increases junction-to-board thermal resistance, which can help manage unwanted heat conduction between the device and the PCB. If the thermal pad is soldered, the thermal pad must be left floating or connected to GND.

(1) P=Power, G=Ground, I=Input, O=Output

6 Specifications

6.1 Absolute Maximum Ratings

Over operating free-air temperature range (unless otherwise noted)⁽¹⁾

		MIN	MAX	UNIT
V _{DD}	Applied Voltage on V _{DD} pin	-0.3	6.0	V
RESET_EN, HEAT_EN	Applied Voltage on RESET_EN and HEAT_EN pins	-0.3	V _{DD} + 0.3	V
V _{RH}	Voltage on RH pin	-0.3	V _{DD} + 0.3	V
V _{TEMP}	Voltage on TEMP pin	-0.3	V _{DD} + 0.3	V
T _J	Junction temperature	-55	150	°C
T _{stg}	Storage temperature	-65	150	°C

- (1) Operation outside the Absolute Maximum Ratings may cause permanent device damage. Absolute Maximum Ratings do not imply functional operation of the device at these or any other conditions beyond those listed under Recommended Operating Conditions. If used outside the Recommended Operating Conditions but within the Absolute Maximum Ratings, the device may not be fully functional, and this may affect device reliability, functionality, performance, and shorten the device lifetime.

6.2 ESD Ratings

			VALUE	UNIT
V _(ESD)	Electrostatic discharge	Human body model (HBM), per AEC Q100-002 ⁽¹⁾	±2000	V
		Charged device model (CDM), per AEC Q100-011	±750	

- (1) AEC Q100-002 indicates that HBM stressing must be in accordance with the ANSI/ESDA/JEDEC JS-001 specification.

6.3 Recommended Operating Conditions

PARAMETER		MIN	MAX	UNIT
V _{DD}	Supply voltage	1.62	5.5	V
T _{TEMP}	Operating free-air temperature for the Temperature Sensor	-40	125	°C
T _{RH}	Operating free-air temperature for the Relative Humidity Sensor ⁽¹⁾	-40	100	°C
T _{A-HEATER}	Operating free-air temperature for the Integrated Heater	-45	85	°C
RH _{OR}	Relative Humidity Sensor Operating Range (Non-condensing) ⁽¹⁾	0	100	%RH

- (1) Prolonged operation outside the recommended temperature operating conditions and/or at >80%RH with temperature in the higher recommended operating range can result in a shift of sensor reading, with slow recovery time. Note care needs to be taken when measuring RH at <0°C due to potential for frost. See Exposure to High Temperature and High Humidity Conditions for more details.

6.4 Thermal Information

THERMAL METRIC ⁽¹⁾		HDC3120-Q1 DEF (WSON) 8 PINS				UNIT
		THERMAL PAD SOLDERED		THERMAL PAD UNSOLDERED		
		HEATER OFF	HEATER ON	HEATER OFF	HEATER ON	
R _{θJA}	Junction-to-ambient thermal resistance	89.3	95.0	170.5	176.3	°C/W
R _{θJC(top)}	Junction-to-case (top) thermal resistance	58.0	62.0	82.9	122.7	°C/W
R _{θJB}	Junction-to-board thermal resistance	58.0	85.0	117.7	86.5	°C/W
Ψ _{JT}	Junction-to-top characterization parameter	12.4	15.7	21.5	25.2	°C/W
Ψ _{JB}	Junction-to-board characterization parameter	57.6	61.9	117.5	121.5	°C/W
R _{θJC(bot)}	Junction-to-case (bottom) thermal resistance	37.9	42.0	–	42.0	°C/W
M _T	Thermal Mass	5.7	5.7	5.7	5.7	mJ/°C

- (1) For more information about traditional and new thermal metrics, see the [Semiconductor and IC Package Thermal Metrics](#) application note.

6.5 Electrical Characteristics

$T_A = -40^\circ\text{C}$ to 125°C , $V_{DD} = 1.62\text{V}$ to 5.5V , $\text{OUT}_{RL} = 50\text{k}\Omega$ (unless otherwise noted); Typical specifications are at $T_A = 25^\circ\text{C}$ and $V_{DD} = 3.3\text{V}$ (unless otherwise noted)

PARAMETER		TEST CONDITIONS	MIN	TYP	MAX	UNIT
Relative Humidity Sensor						
RH _{RANGE}	RH Operating Range		0		100	%RH
RH _{ACC}	RH Accuracy ^{(1) (2)}	$T_A = 25^\circ\text{C}$; 10% to 70% RH		± 1.0	± 2.5	%RH
RH _{REP}	RH Repeatability	$T_A = 25^\circ\text{C}$; 10% to 90% RH. Integrated over 1 second at constant T_A		± 0.02		%RH
RH _{HYS}	RH Hysteresis ⁽³⁾			± 0.8		%RH
t_{63RH}	RH Response Time ⁽⁴⁾	$\tau = 63\%$ for step response from 10% to 90% RH, $T_A = 25^\circ\text{C}$ ⁽⁶⁾		4		s
RH _{LTD}	RH Long-term Drift ⁽⁵⁾			± 0.19		%RH/yr
LSB _{RH}	RH Resolution (1 LSB)	12-bit DAC output		0.0244		%RH
t_{ON-RH}	RH DAC Turn-On Time			17		ms
RH _{SENS}	RH Sensor Gain/ Sensitivity	$V_{DD} = 1.8\text{V}$		14.4		mV/%RH
		$V_{DD} = 2.5\text{V}$		20		
		$V_{DD} = 3.3\text{V}$		26.4		
		$V_{DD} = 5\text{V}$		40		
RH _{OFFSET}	RH Sensor Offset Voltage			$0.1 \times V_{DD}$		V
Temperature Sensor						
TEMP _{RANGE}	Temperature Operating Range		-40		125	$^\circ\text{C}$
TEMP _{ACC}	Temperature Accuracy	$-10^\circ\text{C} \leq T_A \leq 60^\circ\text{C}$, $V_{DD} \geq 2.5\text{V}$		± 0.1	± 0.3	$^\circ\text{C}$
		$-10^\circ\text{C} \leq T_A \leq 90^\circ\text{C}$, $V_{DD} \geq 2.5\text{V}$		± 0.15	± 0.4	
		$-40^\circ\text{C} \leq T_A \leq 125^\circ\text{C}$, $V_{DD} \geq 2.5\text{V}$		± 0.2	± 0.6	
		$-20^\circ\text{C} \leq T_A \leq 85^\circ\text{C}$, $V_{DD} = 1.62\text{V}$ to 5.5V		± 0.2	± 0.6	
		$-40^\circ\text{C} \leq T_A < 125^\circ\text{C}$, $V_{DD} = 1.62\text{V}$ to 5.5V		± 0.3	± 0.8	
TEMP _{REP}	Temperature Repeatability			± 0.04		$^\circ\text{C}$
TEMP _{HYS}	Temperature Hysteresis			± 0.02		$^\circ\text{C}$
t_{63TEMP}	Temperature Response Time (25 $^\circ\text{C}$ to 75 $^\circ\text{C}$) ^{(4) (7)}	Stirred Oil. Single layer Flex PCB 0.13mm thickness		0.61		s
		Stirred Oil. Single layer FR4 PCB 1.575mm thickness		1.78		s
		Still Air. Single layer Flex PCB 0.13mm thickness		12.91		s
TEMP _{LTD}	Temperature Long Term Drift				± 0.03	$^\circ\text{C}/\text{yr}$
LSB _{TEMP}	Temperature Resolution (1 LSB)	12-bit DAC output		0.0427		$^\circ\text{C}$
$t_{ON-TEMP}$	TEMP DAC Turn-On Time			11		ms
TEMP _{SENS}	Temperature Sensor Gain/ Sensitivity	$V_{DD} = 1.8\text{V}$		8.2		mV/ $^\circ\text{C}$
		$V_{DD} = 2.5\text{V}$		11.4		
		$V_{DD} = 3.3\text{V}$		15.1		
		$V_{DD} = 5\text{V}$		22.9		
TEMP _{OFFSET}	Temperature Sensor Offset Voltage			$0.306 \times V_{DD}$		V
Power Supply						
I _{DD}	Average Supply Current ($\overline{\text{RESET_EN}}$ = High)	RH, TEMP loading = 1 M Ω , $T_A = 25^\circ\text{C}$		250	370	μA
		RH, TEMP loading = 1 M Ω			480	μA
V _{POR}	Power-on Reset Threshold Voltage	Supply voltage rising		1.35	1.45	V

HDC3120-Q1

SNAS890A – FEBRUARY 2025 – REVISED JUNE 2025

 $T_A = -40^{\circ}\text{C}$ to 125°C , $V_{DD} = 1.62\text{V}$ to 5.5V , $\text{OUT}_{RL} = 50\text{k}\Omega$ (unless otherwise noted); Typical specifications are at $T_A = 25^{\circ}\text{C}$ and $V_{DD} = 3.3\text{V}$ (unless otherwise noted)

PARAMETER		TEST CONDITIONS	MIN	TYP	MAX	UNIT
V_{BOR}	Brownout Detect Threshold Voltage	Supply voltage falling	1.1	1.25		V
Enable and Reset						
$I_{DD_DISABLE}$	Average Supply Current - Disable Mode (RESET_EN = 0V)	$V_{DD} = 1.62\text{V}$		32	47	μA
		$V_{DD} = 3.3\text{V}$		64	95	
		$V_{DD} = 5.5\text{V}$		106	160	
$V_{OUT_DISABLE}$	TEMP and RH Pin Output Voltage in Disable Mode	RESET_EN = 0V		0.3	10	mV
t_{RESET_EN}	Minimum Duration of Reset Pulse		1			μs
R_{RESET_EN}	RESET_EN pin Internal Pull-up Resistance			51		k Ω
t_{ON}	RESET_EN Turn-On Time Delay	RESET_EN > V_{IH} to valid RH output		8		ms
		RESET_EN > V_{IH} to valid Temp output		13		ms
t_{OFF}	RESET_EN Turn-Off Time Delay			0.45		ms
Analog Output						
V_O	Output Voltage Range		$0.1 \times V_{DD}$		$0.9 \times V_{DD}$	V
V_{OUT0}	Power Up Default Output	Prior to first measurement			$0.1 \times V_{DD}$	V
C_L	Capacitive Load Drive Strength	No isolation resistor. Adequate phase margin with 45° or better			47	nF
R_L	Resistive Load Drive Strength		50			k Ω
I_{SC}	Short Circuit Current		-16	± 7	16	mA
t_{STL}	Settling Time	Step Size = $V_{DD}/2$. Settle to within $\pm 0.5\text{LSB}$. $C_{LOAD} = 1\text{nF}$		0.5		ms
t_{CONV}	ADC RH+Temp Conversion Time			13		ms
t_{PERIOD}	ADC Sampling Period			250		ms
On-Chip Heater						
$R_{25-HEAT}$	Heater Resistance			168.4		Ω
I_{HEAT}	Heater Current	$V_{DD} = 1.8\text{V}$		10		mA
		$V_{DD} = 3.3\text{V}$		19		
		$V_{DD} = 5\text{V}$		28		
P_{HEAT}	Heater Power	$V_{DD} = 1.8\text{V}$		18		mW
		$V_{DD} = 3.3\text{V}$		62		
		$V_{DD} = 5\text{V}$		138		
$t_{ON-HEAT}$	Heater Turn-On Time Delay			130		ms
$t_{OFF-HEAT}$	Heater Turn-Off Time Delay			0.45		ms
Logic Input						
V_{IH}	High Level Input Voltage	RESET_EN, HEAT_EN Pins		$0.7 \times V_{DD}$		V
V_{IL}	Low Level Input Voltage				$0.3 \times V_{DD}$	

- (1) Excludes hysteresis, long-term drift, and impact from device self-heating
- (2) Refer to [RH Accuracy vs. RH Set Point plot](#) for the rest of the RH% range
- (3) The hysteresis value is half of the largest difference between the RH measurement in a rising and falling RH environment. The value is measured between 10% and 90% RH range with a step size of 10%
- (4) Actual response times varies dependent on system thermal mass and air-flow
- (5) Based on THB (temperature humidity bias) testing using Arrhenius-Peck acceleration model. Excludes the impact of dust, gas phase solvents and other contaminants such as vapors from packaging materials, adhesives, or tapes, and more
- (6) Time for the RH output to change by 63% of the total RH change after a step change in environmental humidity
- (7) Time for the TEMP output to change by 63% of the total TEMP change after a step change in environmental temperature

6.6 Typical Characteristics

$T_A = 25^\circ\text{C}$, $V_{DD} = 1.62\text{V}$ to 5.5V (unless otherwise noted)

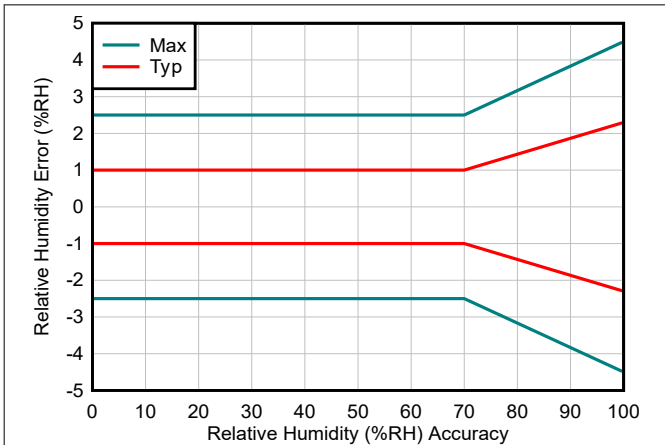

Figure 6-1. RH Accuracy vs RH Set Point ($V_{DD} = 1.62\text{V}-5.5\text{V}$)

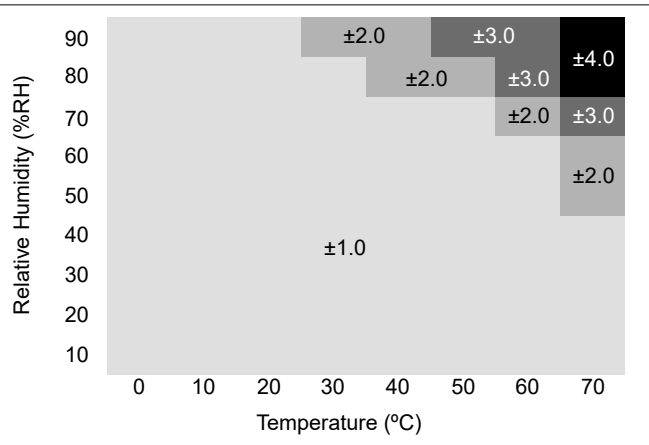

Figure 6-2. RH Typical Accuracy vs T_A Set Point

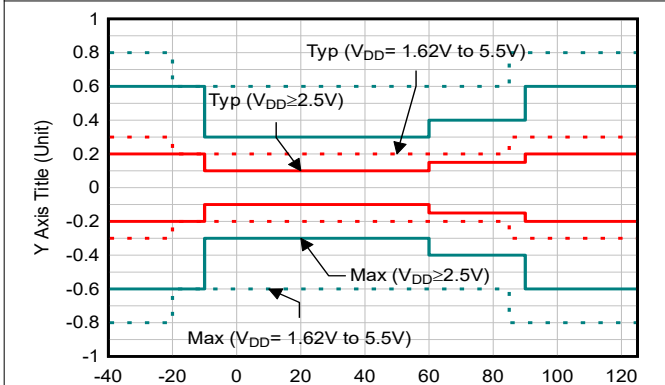

Figure 6-3. T_A Accuracy vs T_A Set Point

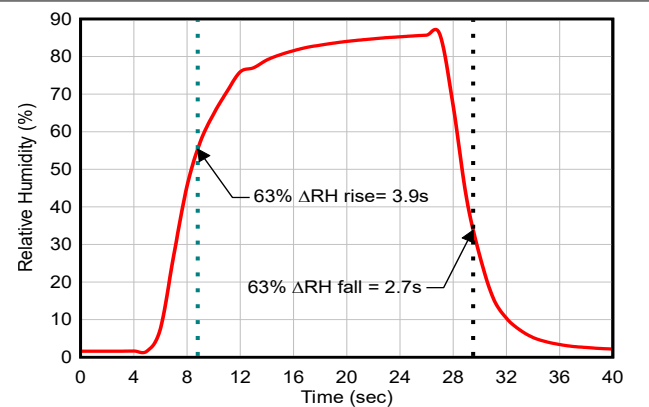

Figure 6-4. Relative Humidity Response Time

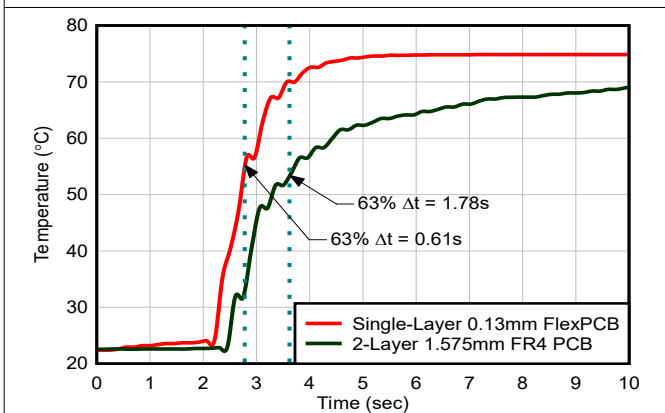

Figure 6-5. Thermal Response Time (Stirred Liquid)

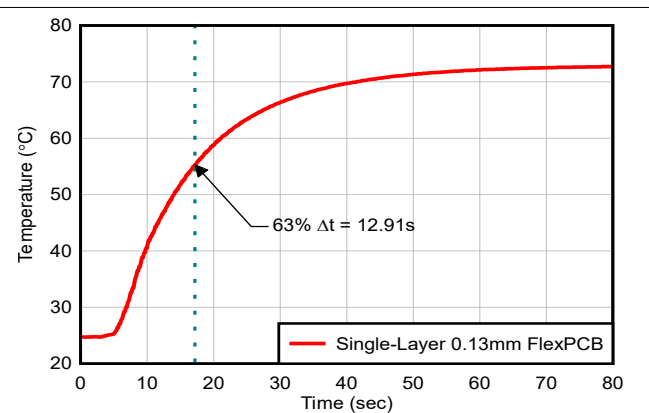

Figure 6-6. Thermal Response Time (Still Air)

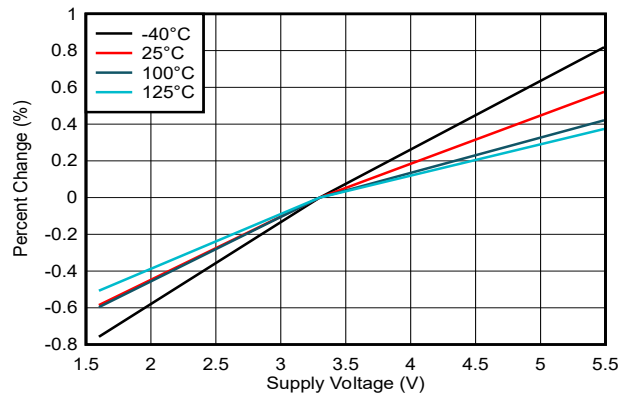

Figure 6-7. Sampling Time Variation vs Temperature

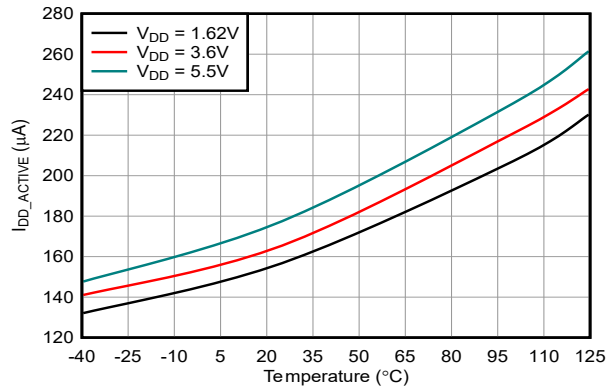

Figure 6-8. Active Current vs Temperature

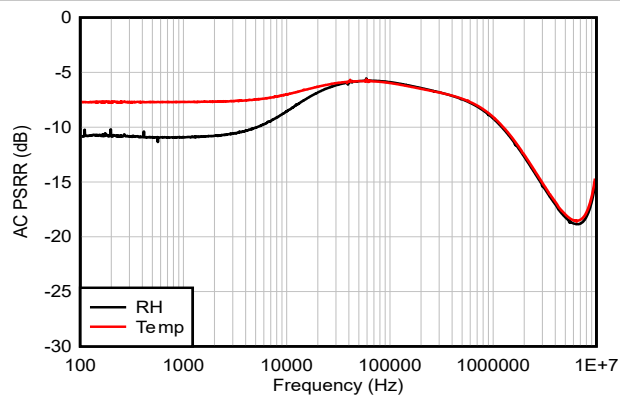

Figure 6-9. DAC PSR vs Frequency

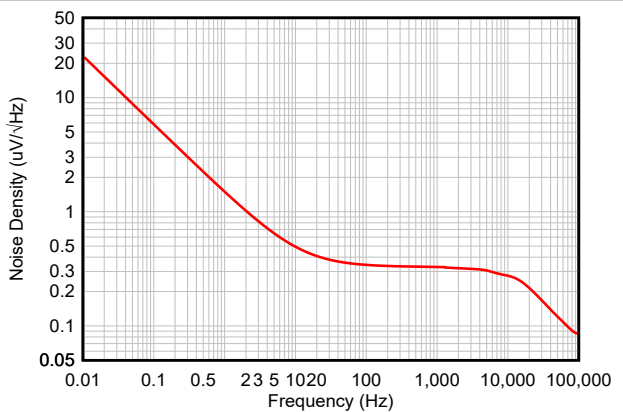

Figure 6-10. DAC Output Noise Density vs Frequency

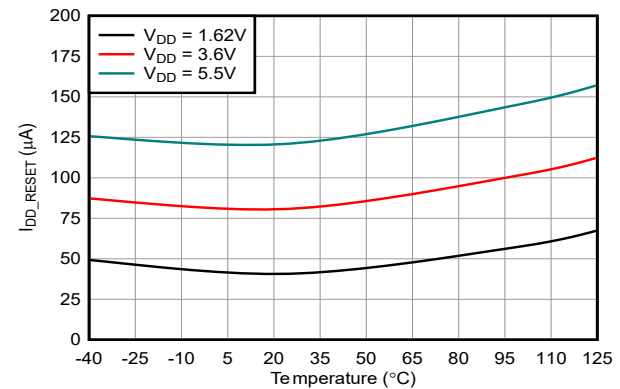

Figure 6-11. Disable Mode Current vs Temperature

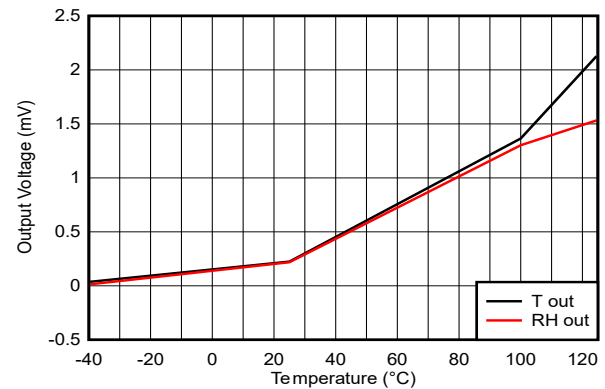

Figure 6-12. Disable Mode Output Voltage vs Temperature

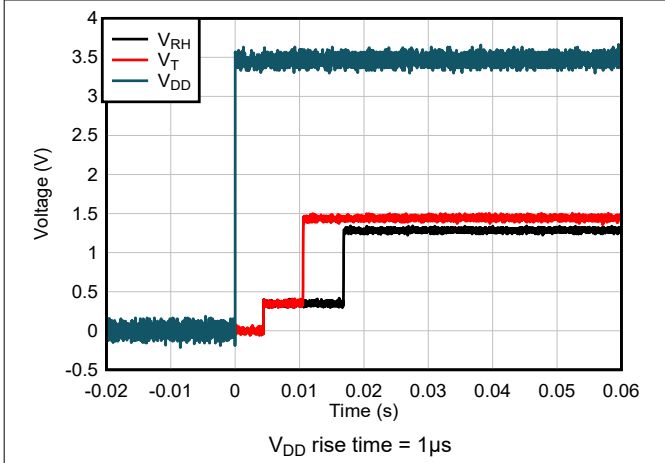

Figure 6-13. Start-up Response

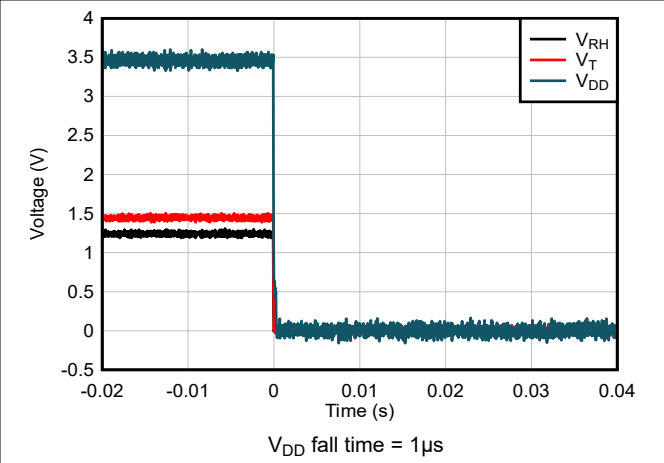

Figure 6-14. Power-down Response

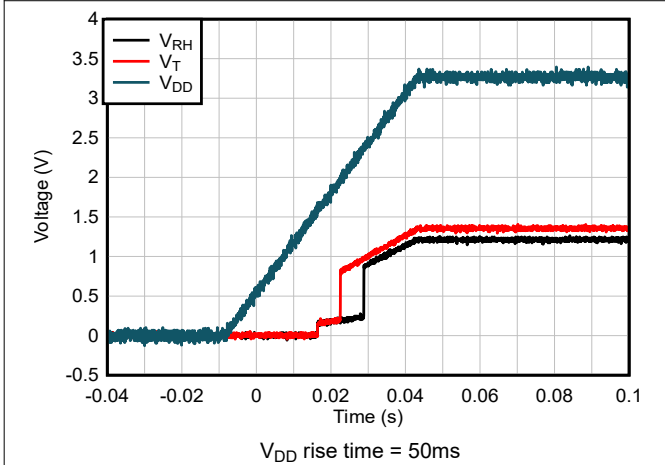

Figure 6-15. Start-up Response

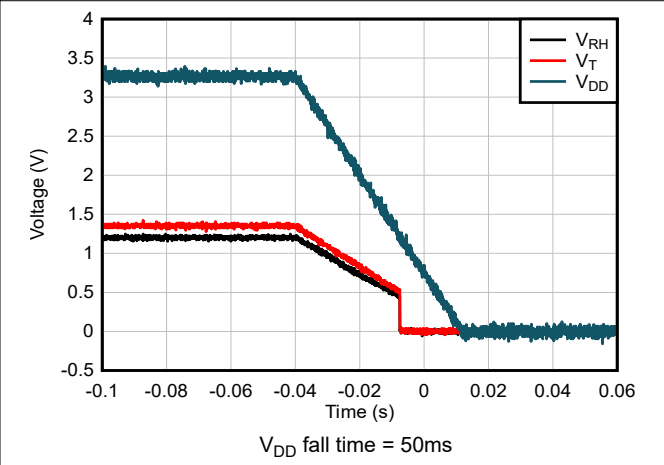

Figure 6-16. Power-down Response

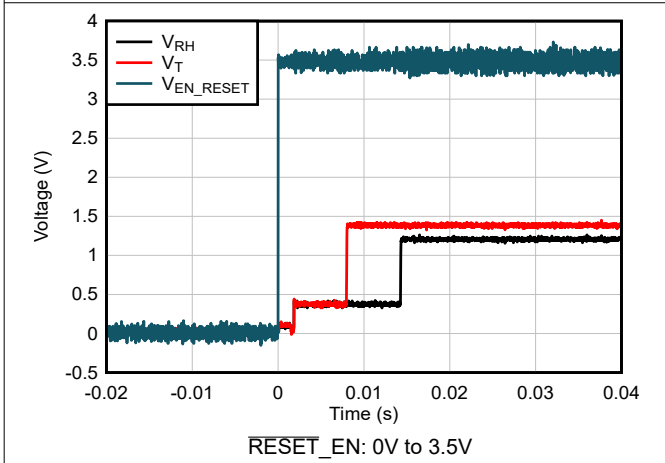

Figure 6-17. Enable Response

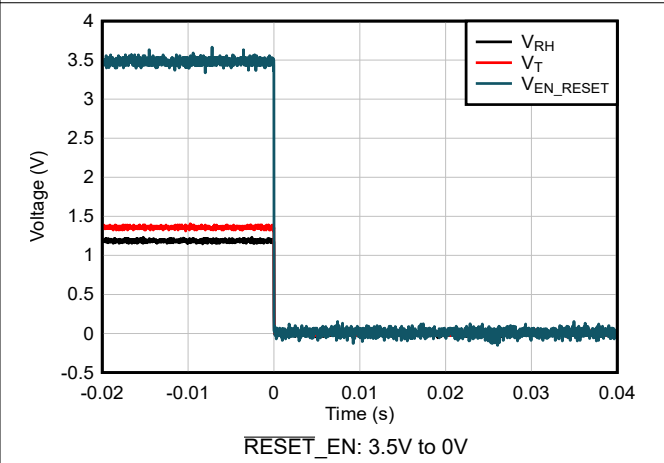

Figure 6-18. Disable Response

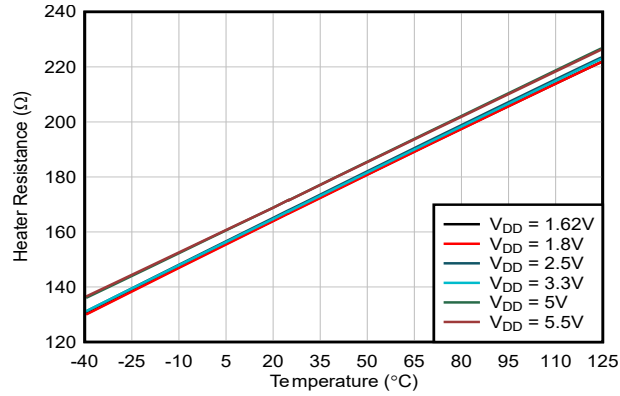

Figure 6-19. Heater Resistance vs Temperature

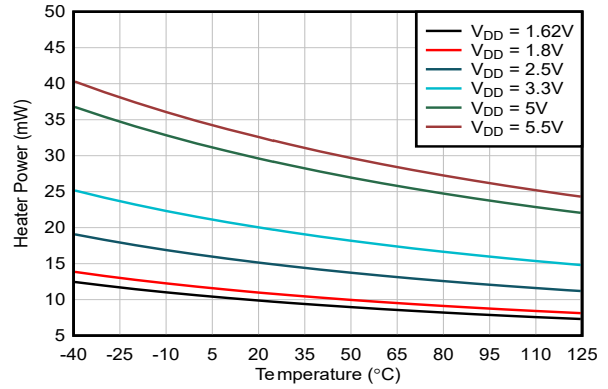

Figure 6-20. Heater Current vs Temperature

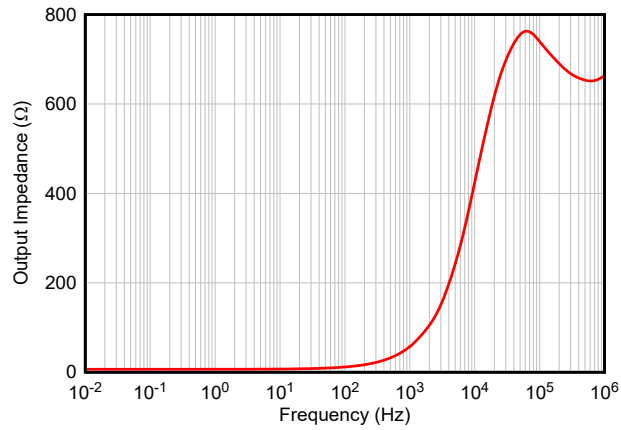

Figure 6-21. Output Impedance vs Frequency

7 Detailed Description

7.1 Overview

The HDC3120-Q1 is an analog output sensor that incorporates both humidity-sensing and temperature-sensing elements in a 2.50mm × 2.50mm, 8-pin WSON package. The output voltages of the HDC3120-Q1 are linearly proportional to the measured relative humidity and temperature. Both the temperature and humidity sensors are 100% tested and trimmed on a production setup that is NIST traceable and verified with equipment that is calibrated to ISO/IEC 17025 standards.

The device provides excellent measurement accuracy at very low power, consuming only 230µA during typical normal operation, and supports wide supply range of 1.62V to 5.5V. The device also features a $\overline{\text{RESET_EN}}$ pin that can be toggled low to keep the device in a low power state to reduce overall power consumption of the system. Upon releasing the $\overline{\text{RESET_EN}}$ pin, the device performs a complete reset before measurements are restarted.

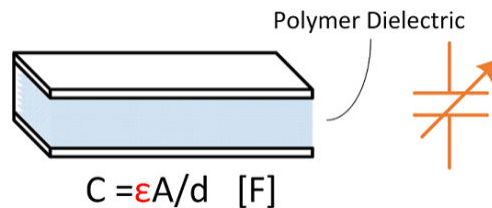

Figure 7-1. Capacitor With Polymer Dielectric

The HDC3120-Q1 measures relative humidity through variations in the capacitance of a polymer dielectric. The sensor consists of two conductive electrodes that adjoin a thin film polymer dielectric (see [Figure 7-1](#)). As humidity increases, the polymer begins to absorb water molecules from the surrounding (air) environment, which alters the dielectric constant of the capacitor sensor. The relationship between the capacitance and relative humidity is used to determine the humidity level.

As with most relative humidity sensors that include this type of technology, care must be taken to provide best device performance. This includes:

- Follow the correct storage and handling guidelines to provide the performance of the HDC3120-Q1 as specified. Special care must be taken to avoid chemical contamination or damage to the sensor during assembly, storage, or operation. See [Section 8.5.1](#) and [HDC3x Silicon User's Guide](#) for these guidelines.
- Reduce prolonged exposure to both high temperature and humidity extremes that can impact sensor accuracy.
- Follow the correct layout guidelines for best performance. See [Section 8.4.1](#) and [Optimizing Placement and Routing for Humidity Sensors](#) application note for these guidelines.
- Rehydration is required for polymer based humidity sensor like the HDC3120-Q1. Rehydration restores the baseline performance of the humidity sensor after high-temperature exposure, such as solder reflow.

7.2 Functional Block Diagram

Figure 7-2. Functional Block Diagram

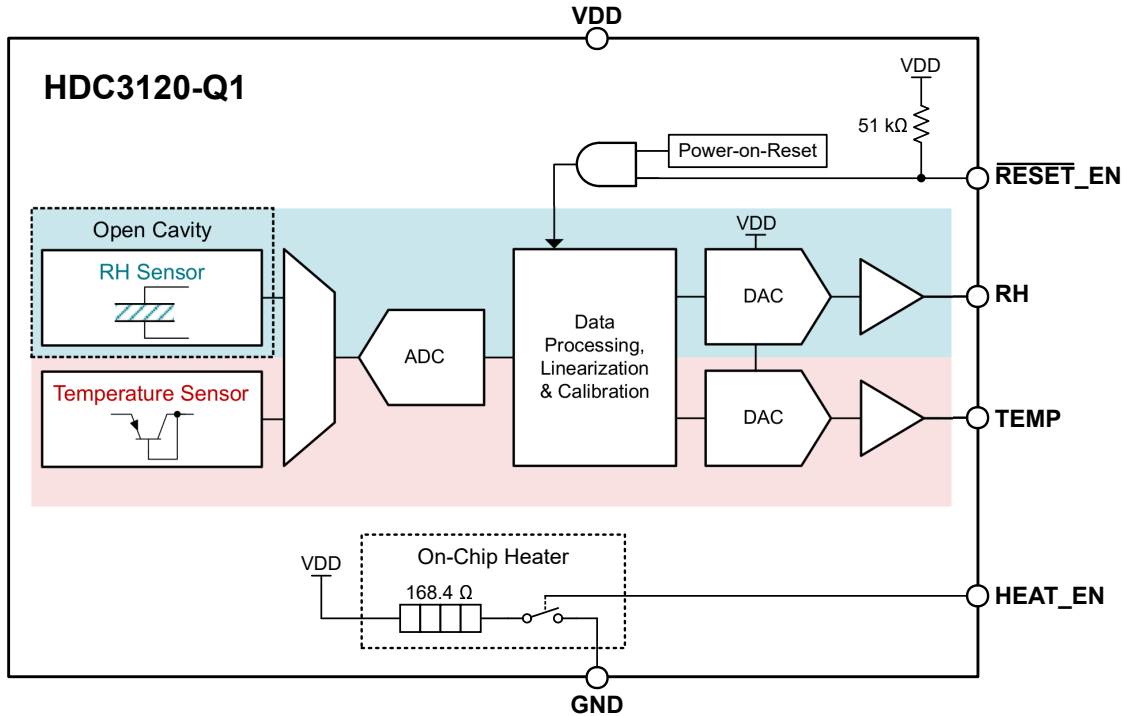

Figure 7-3. Functional Block Diagram

7.3 Feature Description

7.3.1 Device Power-Up

The HDC3120-Q1 includes a power-on reset (POR) function that controls the output voltage at power up. After the V_{DD} supply has been established ($V_{DD} > V_{POR}$), a POR event is issued. The POR causes the device to load the default settings from the memory and subsequently performs temperature and humidity measurements.

During the first humidity and temperature measurement, the DAC outputs are driven to a default level of $0.1 \times V_{DD}$. Each DAC channel remains at the default voltage level until the measurement is completed, which takes approximately RH_{PUR} for the humidity measurement and T_{PUR} for the temperature measurement. After the measurement is completed, the DAC outputs are driven to the voltage level corresponding to the measured humidity and temperature values. Figure 7-4 shows an example of the HDC3120-Q1 power-up behavior.

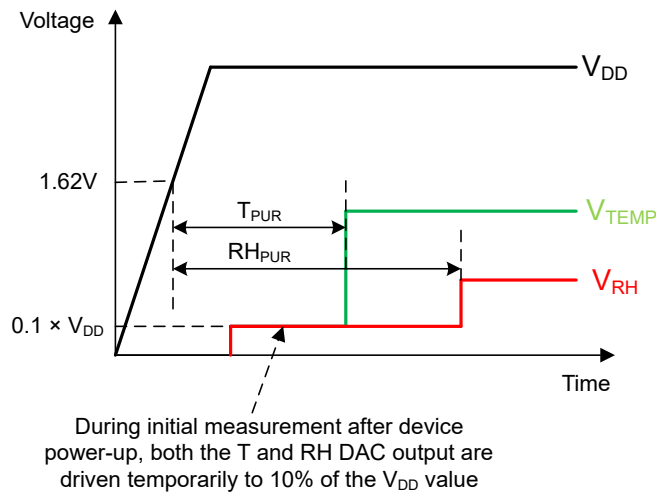

Figure 7-4. HDC3120-Q1 Power-Up Behavior

Note the POR circuit requires specific supply levels to discharge the internal capacitors and to reset the device on power up, as indicated in the following figure. To initiate a POR event, V_{DD} must be below the corresponding low thresholds (V_{BOR}) for a duration of at least t_{RESET_NPW} . If V_{DD} remains above the specified high threshold (V_{POR}), a POR event does not occur. When the V_{DD} drops below the high threshold V_{POR} but remain over the lower one (V_{BOR}), the device is situated in an undefined state, and does not necessarily reset under all specified temperature and power supply conditions.

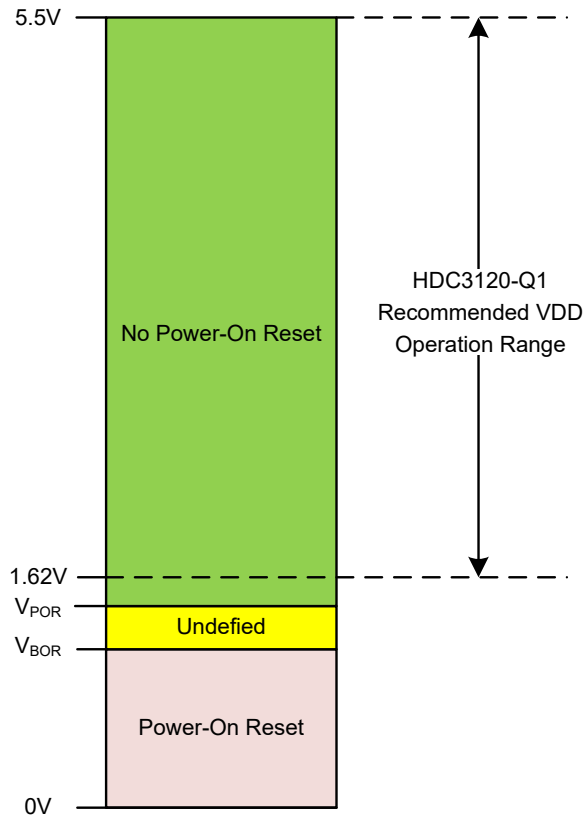

Figure 7-5. HDC3120-Q1 POR Circuit Thresholds

7.3.2 Device Disable and Enable

The HDC3120-Q1 can be disabled by setting the $\overline{RESET_EN}$ pin low (below V_{IL}). In this state, the RH and Temp DAC outputs move to a near-zero condition ($V_{OUT_DISABLE}$), and the device current consumption is significantly reduced to $I_{DD_DISABLE}$. The reduced current consumption helps conserve the system power if no sensor measurement is needed. The device disable sequence and the DAC output voltages are illustrated in [Figure 7-6](#).

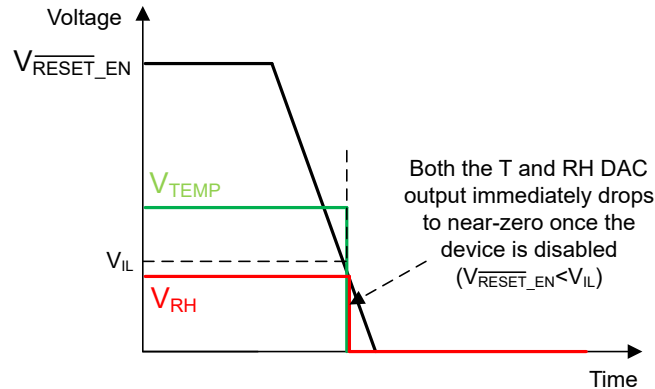

Figure 7-6. HDC3120-Q1 Disable Behavior

To enable the HDC3120-Q1, the $\overline{\text{RESET_EN}}$ pin needs to be set to high (above V_{IH}). The enabling sequence and the sensor output voltages behave similarly to the device power-up, as described in Section 7.3.1. After the $\overline{\text{RESET_EN}}$ pin is raised above V_{IH} , the device loads the default settings from the memory and subsequently performs temperature and humidity measurements. During the first temperature and humidity measurement, the DAC outputs are driven to a default level of $0.1 \times V_{DD}$. Each DAC channel remains at the default voltage level until the measurement is completed, which takes approximately RH_{PUR} for the humidity measurement and T_{PUR} for the temperature measurement. After the measurement is completed, the DAC outputs are driven to the voltage level corresponding to the measured humidity and temperature values. Figure 7-7 illustrates the HDC3120-Q1 enable sequence.

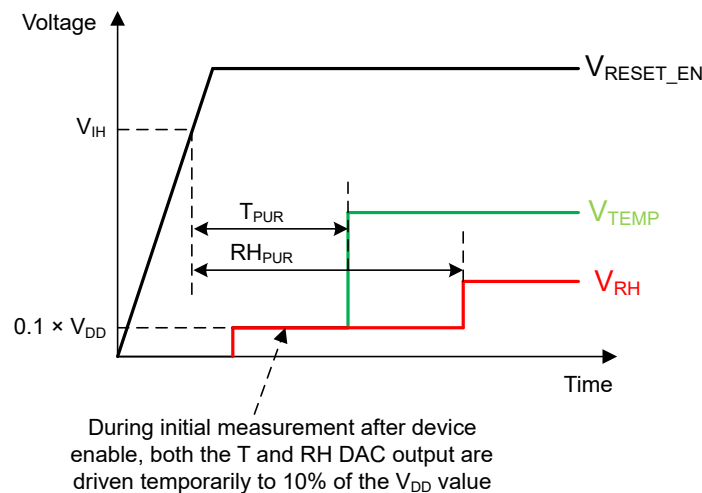

Figure 7-7. HDC3120-Q1 Enable Behavior

Note the HDC3120-Q1 $\overline{\text{RESET_EN}}$ pin has a weak 51k Ω internal pull-up to V_{DD} , thus the pin can be left floating if the RESET or the Disable functions are not utilized.

7.3.3 Conversion of the Signal Output

The HDC3120-Q1 has two analog ratiometric output voltages—one for temperature and one for relative humidity—that are ratiometric to the supply voltage (V_{DD}). In a ratiometric design, the output voltage scales proportionally with changes in V_{DD} . Any variation in supply voltage directly adjusts the sensor output. This architecture keeps the sensor readings accurate, even with supply fluctuations.

HDC3120-Q1 ratiometric architecture provides the benefit in applications that use the same reference or supply voltage for both the HDC3120-Q1 and the sampling ADC. When V_{DD} changes, the sensor offset and span shift together, verifying that the measured ratio remains constant. For instance, at 5.0V V_{DD} , the V_{RH} reads 0.5V

at 0% RH and 4.5V at 100% RH. If the supply drops 10% to 4.5V, those outputs become 0.45V and 4.05V, respectively, hence maintaining the same ratio.

A ratiometric design can help mitigate supply voltage errors as long as the measurement reference tracks the same supply. The outputs are linearly proportional to temperature and humidity and can be converted to physical units using transfer functions described in the following sections.

7.3.3.1 Relative Humidity (RH%) Measurement

The RH% can be calculated from the V_{RH} output voltage and the V_{DD} using the equation:

$$\%RH = -12.5 + 125 \times \frac{V_{RH}}{V_{DD}} = -\frac{10}{0.8} + \frac{100}{0.8} \times \frac{V_{RH}}{V_{DD}} \quad (1)$$

Figure 7-8 plots the calculated RH% as a function of normalized V_{RH}/V_{DD} :

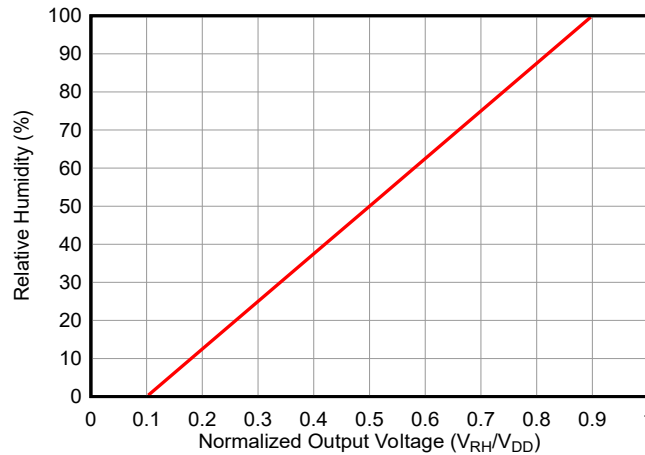

Figure 7-8. HDC3120-Q1 %RH Output Profile

Alternatively, to examine the voltage gain of the sensor for humidity measurements, the V_{RH} voltage can also be expressed as a function of V_{DD} and %RH in the following voltage sensitivity equation:

$$V_{RH} = V_{DD} \times \left[(\%RH) \times 8 \frac{mV}{\%RH} + 0.1 \right] \quad (2)$$

- **8mV/%RH** represents the gain of the sensor which scales with V_{DD} , showing voltage change per %RH.
- The voltage spans from **0.1 × V_{DD}** , the sensor offset at 0% RH, to **0.9 × V_{DD}** , representing 100% RH

Figure 7-9 illustrates the RH output voltage as a function of RH% at different V_{DD} levels. Figure 7-10 presents the same data, but with the RH output voltage normalized to V_{DD} .

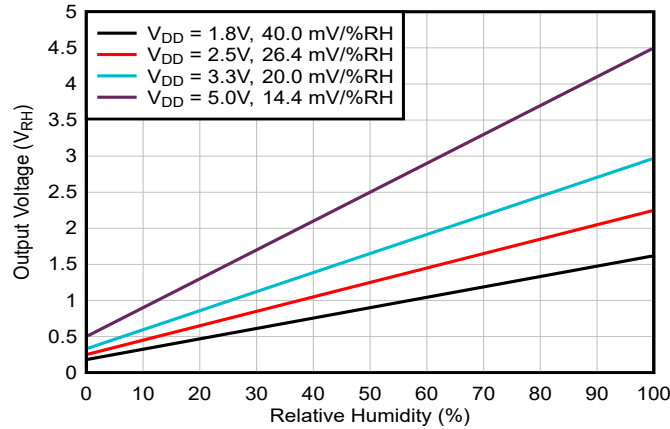

Figure 7-9. RH% Sensor Output (V_{RH}) vs RH%

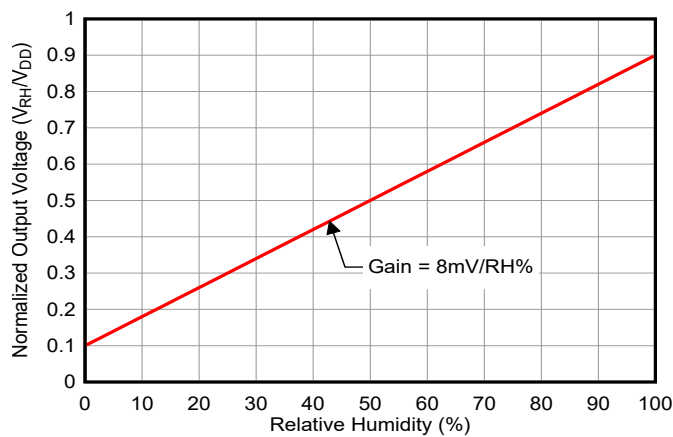

Figure 7-10. Normalized RH% Sensor Output (V_{RH}/V_{DD}) vs RH%

Table 7-1 provides some examples of the V_{RH} voltage reading at various %RH and V_{DD} levels. Note even though the V_{RH} voltage vary with V_{DD} at the same RH% level, V_{RH}/V_{DD} ratio remains constant, providing accurate measurements. This ratiometric design makes the HDC3120-Q1 sensor reading stable across supply variations.

Table 7-1. V_{RH} Voltage at Various %RH and V_{DD} Levels

	$V_{DD} = 1.8V$	$V_{DD} = 2.5V$	$V_{DD} = 3.3V$	$V_{DD} = 5.0V$	V_{RH}/V_{DD} Ratio
%RH= 0%	0.18	0.25	0.33	0.50	0.10
%RH= 25%	0.54	0.75	0.99	1.50	0.30
%RH= 50%	0.90	1.25	1.65	2.50	0.50
%RH= 85%	1.40	1.95	2.57	3.90	0.78
%RH= 100%	1.62	2.25	2.97	4.50	0.90
Sensor Gain	14.4mV/%RH	20mV/%RH	26.4mV/%RH	40.0mV/%RH	
Sensor Offset	180mV	250mV	330mV	500mV	

7.3.3.2 Temperature Measurement

The temperature in Celsius ($^{\circ}C$) or Fahrenheit ($^{\circ}F$) can be calculated from the V_{TEMP} output voltage and the V_{DD} using the following equations:

$$T(^{\circ}C) = -66.875 + 218.75 \times \frac{V_{TEMP}}{V_{DD}} = -45 - \frac{17.5}{0.8} + \frac{175}{0.8} \times \frac{V_{TEMP}}{V_{DD}} \quad (3)$$

$$T(^{\circ}\text{F}) = -88.375 + 393.75 \times \frac{V_{\text{TEMP}}}{V_{\text{DD}}} = -49 - \frac{31.5}{0.8} + \frac{315}{0.8} \times \frac{V_{\text{TEMP}}}{V_{\text{DD}}} \quad (4)$$

Figure 7-11 plots the calculated RH% as a function of normalized $V_{\text{TEMP}}/V_{\text{DD}}$:

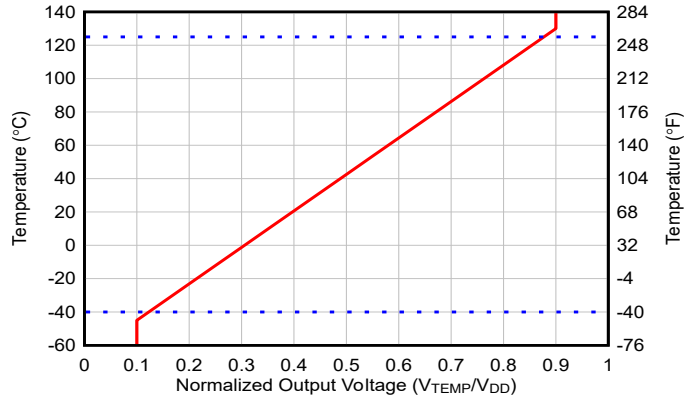

Figure 7-11. HDC3120-Q1 Temperature Output Profile

Alternatively, to examine the voltage gain of the sensor for temperature measurements, the V_{TEMP} voltage can also be expressed as a function of V_{DD} and temperature in the following voltage sensitivity equation:

$$V_{\text{TEMP}} = V_{\text{DD}} \times \left[T(^{\circ}\text{C}) \times 4.571 \frac{\text{mV}}{^{\circ}\text{C}} + 0.306 \right] \quad (5)$$

- **4.571mV/°C** represents the sensor gain which scales with V_{DD} , showing voltage change per °C.
- The voltage spans from **0.1 × V_{DD}**, the sensor offset at -45°C, to **0.9 × V_{DD}**, representing 130°C

Note

The V_{TEMP} output voltage rails out at temperature below -45°C (where the $V_{\text{TEMP}} = 0.1 \times V_{\text{DD}}$), and temperature above 130°C (where the $V_{\text{TEMP}} = 0.9 \times V_{\text{DD}}$).

Figure 7-12 illustrates the temperature output voltage as a function of temperature at different V_{DD} levels. Figure 7-13 presents the same data, but with the temperature output voltage normalized to V_{DD} .

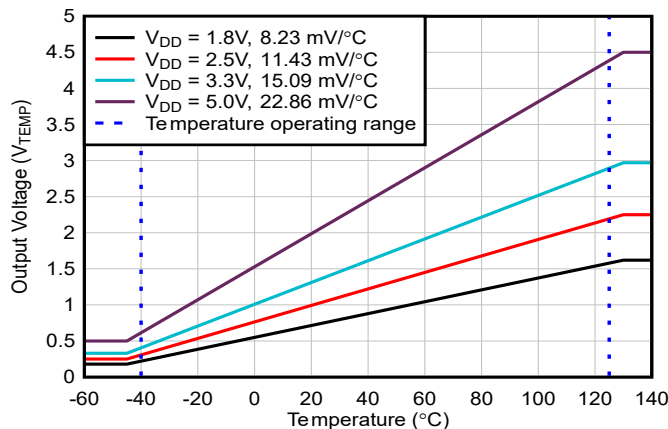

Figure 7-12. Temperature Sensor Output (V_{TEMP}) vs Temperature

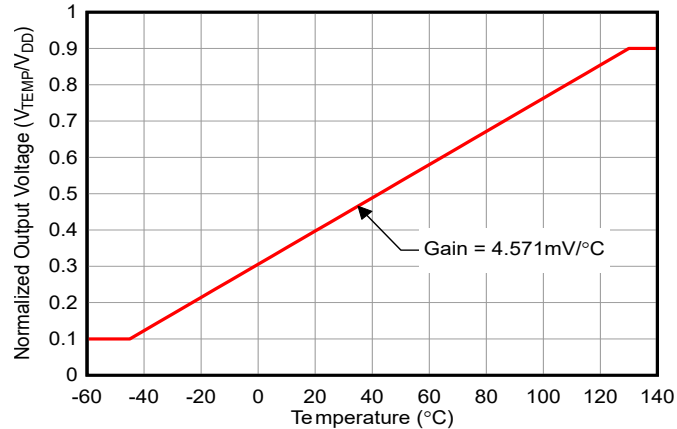

Figure 7-13. Normalized Temperature Sensor Output (V_{TEMP}) vs Temperature

Table 7-2 provides some examples of the V_{TEMP} voltage reading at various temperature and V_{DD} levels. Note even though the V_{TEMP} voltage vary with V_{DD} at the same temperature, V_{TEMP}/V_{DD} ratio remains constant, providing accurate measurements. This ratiometric design makes the sensor reading of the HDC3120-Q1 stable across supply variations.

Table 7-2. V_{TEMP} Voltage at Various Temperature and V_{DD} Levels

	$V_{DD} = 1.8V$	$V_{DD} = 2.5V$	$V_{DD} = 3.3V$	$V_{DD} = 5.0V$	V_{TEMP}/V_{DD} Ratio
Temp= -40°C	0.221	0.307	0.405	0.614	0.123
Temp= 0°C	0.550	0.764	1.009	1.529	0.306
Temp= 25°C	0.756	1.050	1.386	2.100	0.420
Temp= 85°C	1.250	1.735	2.291	3.471	0.694
Temp= 125°C	1.579	2.193	2.895	4.386	0.877
Sensor Gain	8.229mV/°C	11.429mV/°C	15.085mV/°C	22.857mV/°C	
Sensor Offset	550mV	764mV	1.009V	1.529V	

7.3.4 NIST Traceability and Unique ID

"NIST Traceability" refers to a chain of calibrations that links a measurement or test result back to the National Institute of Standards and Technology (NIST) standards. This means that the equipment or process used for measurement has been calibrated against a known and reliable standard, ultimately traceable to the fundamental standards of NIST.

The HDC3120-Q1 units are 100% tested on a production setup that is NIST traceable and verified with equipment that is calibrated to ISO/IEC 17025 accredited standards. This permits design of the HDC3120-Q1 into applications such as cold chain management, where the establishment of an unbroken chain of calibrations to known references is essential.

Each HDC3120-Q1 part has a unique ID assigned to the device. The unique ID contains vital information accessible only by Texas Instruments and allows every chip to be traceable to the production test data to see if there is a test parameter or fab process condition that can potentially cause a device failure. Please contact Texas Instruments directly for support.

7.3.5 Output Short Circuit Protection

The HDC3120-Q1 is designed to withstand a continuous short circuit condition to either V_{DD} or GND. In the event of a short circuit, the output current is limited to I_{SC} , preventing damage to the device. This feature provides robust operation and protects the HDC3120-Q1 from potential faults caused by unintended shorts.

7.4 Device Functional Modes

7.4.1 On-Chip Heater

The **HDC3120-Q1** includes an integrated on-chip heater designed to elevate the temperature sensor above ambient. This function serves multiple purposes: the function accelerates the drying of the humidity-sensing element and facilitates the outgassing of absorbed contaminants from the sensing polymer. By raising the sensor junction temperature, the heater can prevent or mitigate conditions that negatively impact sensor performance and long-term stability.

Key applications of the on-chip heater include:

- **Condensation Prevention:** Heating the sensor when ambient conditions approach the dew point can prevent condensation from forming on the sensor surface. This is especially critical when the sensor is not enclosed in a protective housing. Moisture ingress under the sensor package can lead to short circuits between exposed sensor pins, potentially causing permanent damage to the device or the user's system.
- **High-Humidity Stability:** In continuously high-humidity environments, periodic heating helps to evaporate residual moisture that can accumulate on the sensing element. This reduces long-term drift and maintains the accuracy of humidity measurements.
- **Contaminant Bake-Out:** The heater can be used for extended durations (up to several hours, depending on system constraints) to accelerate the removal of volatile organic compounds (VOCs) or other contaminants that can be absorbed by the sensing polymer. This process restores the sensor closer to the baseline behavior.
- **Device Self-Test:** Activating the heater can also serve as a basic functionality check. A measurable rise in temperature indicates that the sensor and heater circuitry are operational.

The on-chip heater plays a vital role in maintaining sensor performance under challenging environmental conditions by keeping the sensing element dry and uncontaminated when needed. For best performance, the heater is most effective at $V_{DD} \geq 2.5V$, with **3.3V or higher** recommended for achieving a temperature rise (ΔT) of more than **10°C**.

7.4.1.1 Operating Principle

The on-chip heater in the **HDC3120-Q1** is implemented as a resistive heating element integrated into the sensor die. The heater is controlled using the dedicated **HEAT_EN** pin. Driving **HEAT_EN** high enables the heater; driving the heater low disables the heater. To prevent accidental activation, **HEAT_EN** must not be left floating—tie this pin to ground if the heater function is unused.

When **HEAT_EN** is asserted (set high), a built-in startup delay of approximately **130ms** occurs before the heater current is applied. This delay verifies stable activation and prevents unintended heater operation due to spurious pulses or brief transients. When **HEAT_EN** is deasserted (set low), the heater turns off within **0.45ms**, quickly halting heat generation.

Note

While the heater is active, the sensor does **not** measure true ambient temperature or humidity. Instead, the temperature sensor reports the elevated junction temperature, and the relative humidity reading appears artificially lower due to the increased local temperature. After a heating cycle, the sensor requires time to cool and equilibrate with the environment before accurate RH/T measurements can resume.

For reliable humidity measurements following a heating cycle, allow a minimum of **30 seconds** recovery time in still air conditions. Actual recovery time depends on final heater temperature, airflow, and ambient thermal characteristics.

7.4.1.1.1 Heater Configuration Example

The table below illustrates a typical heater activation cycle, assuming a thermal response time ($T_{99.9\%}$) of 4s, a 1s hold time to allow for moisture evaporation or contaminant removal, and a 30s cool-down period to verify the sensor has fully re-equilibrated with ambient conditions before resuming accurate RH/T measurements.

Table 7-3. Heater Configuration Example

Time (ms)	Action
0	Final ambient RH/T reading completed
+1	HEAT_EN = High (1ms signal rise time)
+130	Heater current begins
+130 to +5,130	Heater hold (4 second warm-up + 1 sec hold)
+5,130.45	HEAT_EN = Low (heater turns off in 0.45ms)
+35,130.45	RH/T readings resume (after 30 sec cool-down)

7.4.1.2 Heater Electrical Behavior

The on-chip heater of the HDC3120-Q1 operates as a resistive element with a positive temperature coefficient (PTC)—its resistance increases with temperature. The heater resistance can be estimated using Equation 6 as a function of the junction temperature (T_J):

$$R_{\text{HEATER}}(T_J) \approx R_{25-\text{HEATER}} \cdot [1 + \alpha(T_J - 25^\circ\text{C})] \quad (6)$$

At 25 °C, the typical resistance ($R_{25-\text{HEATER}}$) is approximately 168.4 Ω , and the temperature coefficient α is roughly 0.00326 $^\circ\text{C}^{-1}$. When HEAT_EN is asserted, the heater draws current from V_{DD} according to Ohm's law: $I_{\text{HEATER}} \approx V_{DD} / R_{\text{HEATER}}$. Note while the resistance increases linearly with temperature, the actual junction temperature—and thus heater resistance—varies depending on environmental conditions, airflow, PCB layout, and duty cycle.

With the heater resistance estimated, the heater power can then be approximated using Equation 7:

$$P_{\text{HEATER}}(T_J) \approx \frac{V_{DD}^2}{R_{\text{HEATER}}(T_J)} \approx \frac{V_{DD}^2}{R_{25-\text{HEATER}} \cdot [1 + \alpha(T_J - 25^\circ\text{C})]} \quad (7)$$

Table 7-4 summarizes typical heater current and power values at 25 °C ambient. These values represent the initial heater power draw, prior to thermal ramp-up. Heater resistance increases as the die warms, so current draw decreases slightly over time during a heating cycle. However, during the initial 1–2 seconds, when the heater is still cool, the current draw is at the maximum.

Table 7-4. Estimated Heater Current and Power at 25 °C

Supply Voltage (VDD)	Heater Current (typ.)	Heater Power (typ.)
1.8 V	≈ 10 mA	≈ 18 mW
3.3 V	≈ 19 mA	≈ 62 mW
5.0 V	≈ 28 mA	≈ 138 mW
5.5 V (maximum)	≈ 30 mA	≈ 165 mW

Note

Due to these varying factors, estimating exact junction temperature from resistance or power is generally not practical. Therefore, users must focus on heater enable timing and system-level thermal behavior, rather than relying on theoretical resistance models.

Always design your power supply and system thermal envelope to accommodate the peak heater current observed during startup. This verifies stability and avoids brownout conditions, especially at higher V_{DD} levels.

7.4.1.3 Heater Temperature Increase

The heater induced temperature increase has high dependency on the power supply V_{DD} . Figure 7-14 illustrates the typical temperature increase profile at different power supply level. The data is captured on a 15mm × 15mm, 1.575mm FR4 PCB.

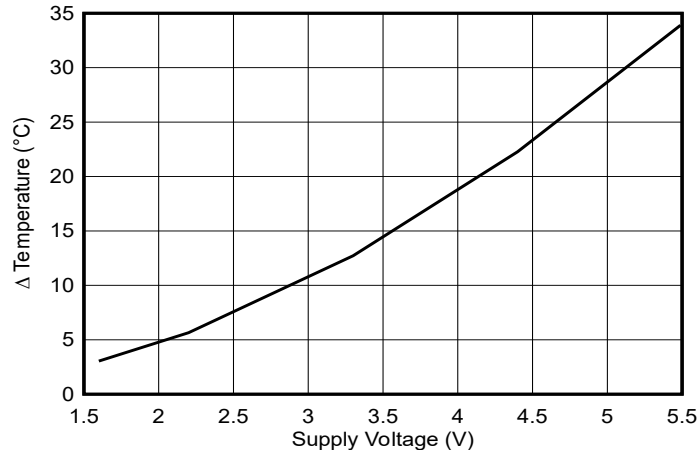

Figure 7-14. Heater Induced Temperature Increase vs Supply Voltage on a Rigid 1.575mm FR4 PCB

Figure 7-15 illustrates a temperature rise measurement example with the device mounted on a single-layer 1.575mm FR4 PCB, and the thermal pad left unsoldered. Depending on the power supply used, the sensor die is able to reach different temperatures.

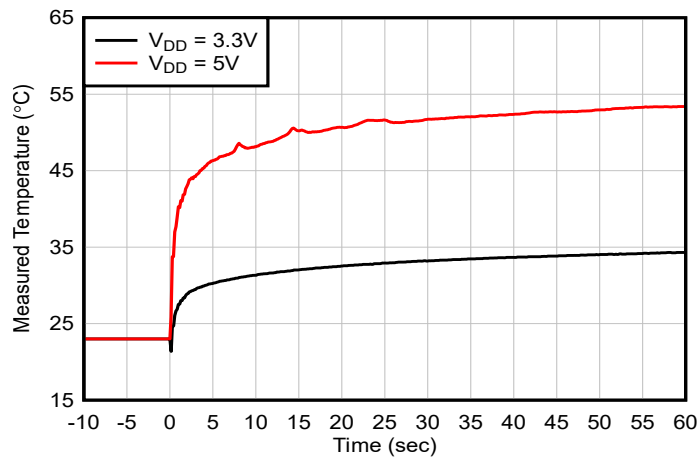

Figure 7-15. Heater Induced Temperature Increase on a Rigid PCB (1.575mm FR4)

To achieve higher heater temperatures, mount the device on a thin Flex PCB, which minimizes the impact of large PCB thermal mass. Figure 7-16 illustrates a temperature rise measurement example with the device mounted on a single-layer 0.13mm Flex PCB, and the thermal pad left unsoldered. With a high supply voltage of 5V applied to the device, the sensor die is able to reach approximately 100°C in ambient conditions.

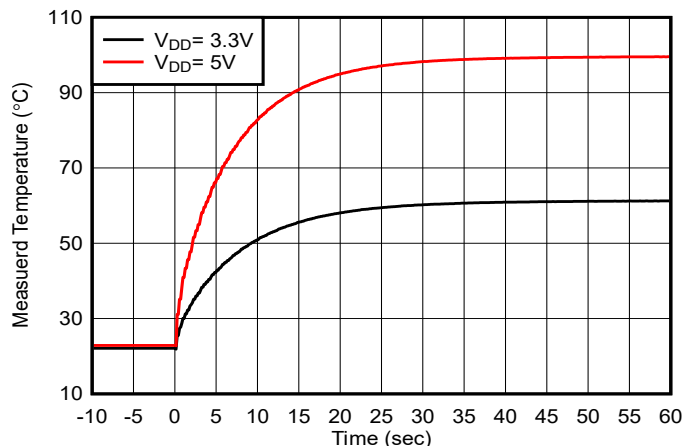

Figure 7-16. Heater Induced Temperature Increase on a FlexPCB (0.13mm Flex)

7.4.1.4 Heater Usage Guidelines

The on-chip heater in the HDC3120-Q1 can help remove condensation and accelerate drying in humid environments. However, to provide best performance and long-term reliability, the following precautions and best practices must be followed:

- **Sensor Measurements During Heating:**

When the heater is enabled:

- Temperature readings reflect the die's internal temperature, not ambient.
- Humidity readings appears artificially low due to localized heating.

These values are not valid for ambient sensing. After turning the heater off, sensor temperature and RH can take up to 30 seconds or more to return to equilibrium. RH readings can stabilize even more slowly. Wait for readings to settle before relying on post-heating measurements.

- **Power Supply Considerations:**

The heater increases the current draw of the device significantly:

- Typical heater current ranges from 10–30mA, depending on V_{DD}.
- Verify that your power supply and bypass capacitors can handle this surge without voltage droop. Sudden supply drops can trigger sensor resets or interfere with nearby circuitry.
- A local decoupling capacitor (e.g., 0.1μF + 1μF ceramic) is strongly recommended.

- **Condensation and Residue Risk:**

The heater evaporates water, but any dissolved minerals or contaminants in that water remains as solid residue on the sensor surface. Over time, this can degrade accuracy or slow response time.

- The heater **cannot** remove non-volatile residues.
- In environments prone to condensation or splashes, consider using a **protective membrane** to reduce contamination risks.
- For heavily contaminated units, manual cleaning or sensor replacement can be necessary.

- **Heater Duty Cycle and Sensor Aging:**

Frequent or prolonged heater usage can accelerate long-term aging of the humidity sensor:

- Occasional, condition-based use is recommended.
- Avoid running the heater continuously or at high duty cycles unless absolutely necessary.
- For best results, activate the heater only when condensation is detected or anticipated.

Texas Instruments has qualified the HDC3120-Q1 for typical heater use. However, excessive heater activation can lead to gradual performance shifts over time. For advanced applications needing precise control and feedback, consider the digital HDC3020 device.

8 Application and Implementation

Note

Information in the following applications sections is not part of the TI component specification, and TI does not warrant its accuracy or completeness. TI's customers are responsible for determining suitability of components for their purposes, as well as validating and testing their design implementation to confirm system functionality.

8.1 Application Information

The primary need for an analog output sensor over a digital output sensor is for applications where the simplest solution is required. Together with an external comparator, which shares the same supply source as HDC3120-Q1, and a resistor divider as a reference point, the device allows the designer to build the simplest local humidity and temperature control system without requiring a microprocessor and precise power supply.

8.2 Typical Application

An example application of a ADAS sensor monitoring system using the HDC3120-Q1 is shown below. The purpose of the humidity sensor to sense the humidity within the cabin of the vehicle. In this application, placing the humidity sensor on the same board as the main system controller is not possible. Wires must be used to connect the sensor board to the microcontroller board.

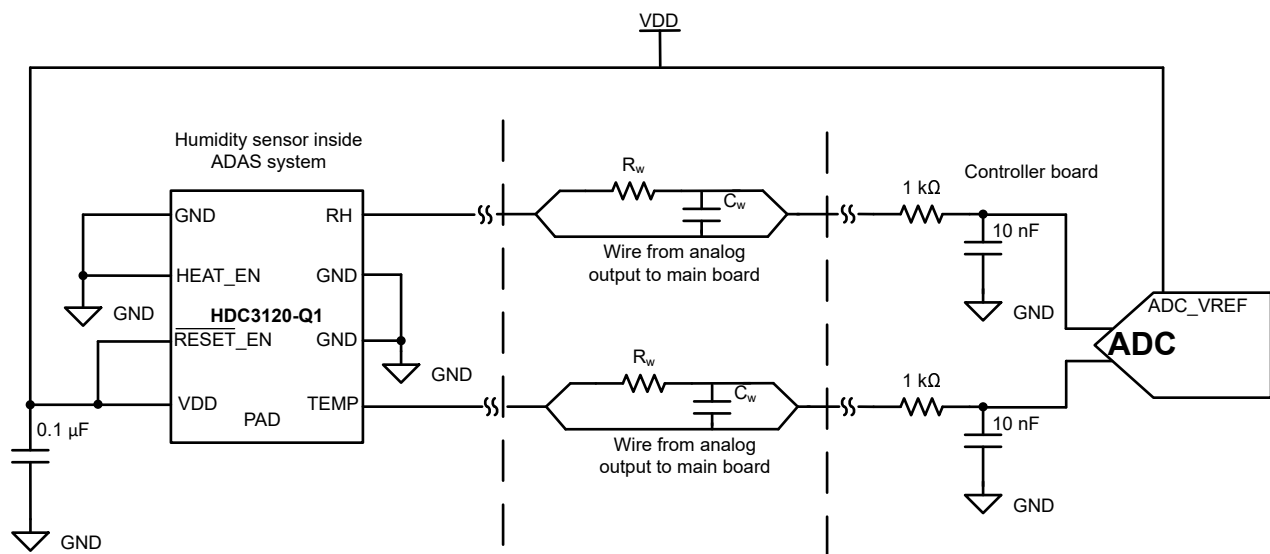

Figure 8-1. HDC3120-Q1 Connection to ADC

In the following figure, the cable capacitance and resistance are drawn to highlight that the HDC3120-Q1 is capable of driving capacitive loads up to 47nF. When connecting HDC3120-Q1 to an ADC, using an ADC with an external reference voltage is recommended, which must be tied to the same voltage supplying the HDC3120-Q1. The HDC3120-Q1 RH and Temperature outputs are ratiometric to the VDD of the device, so if there is a spike or noise on the VDD line, that noise can be seen on the outputs as well. By having the ADC reference voltage match the HDC3120-Q1 VDD, noise events occur for both ICs, which allows the ADC to match and eliminate the noise. On the analog outputs, implementing an RC filter near the ADC is recommended. The capacitor simultaneously helps to filter noise in the RC filter. The capacitor also serves as a charge repository for the ADC during sampling to prevent sampling glitches.

The RC filter values featured in the above circuit example are suggestions, and can be modified to meet the desired cutoff frequency. The output DACs for RH and Temp are strong outputs, capable of driving across long cables without the need for an external buffer amplifier. Take care to verify that the total load capacitance

remains less than 3μF for both cabling and filter capacitance. The R-C values selected also need to take into account what the chosen ADC can support and the desired sampling frequency.

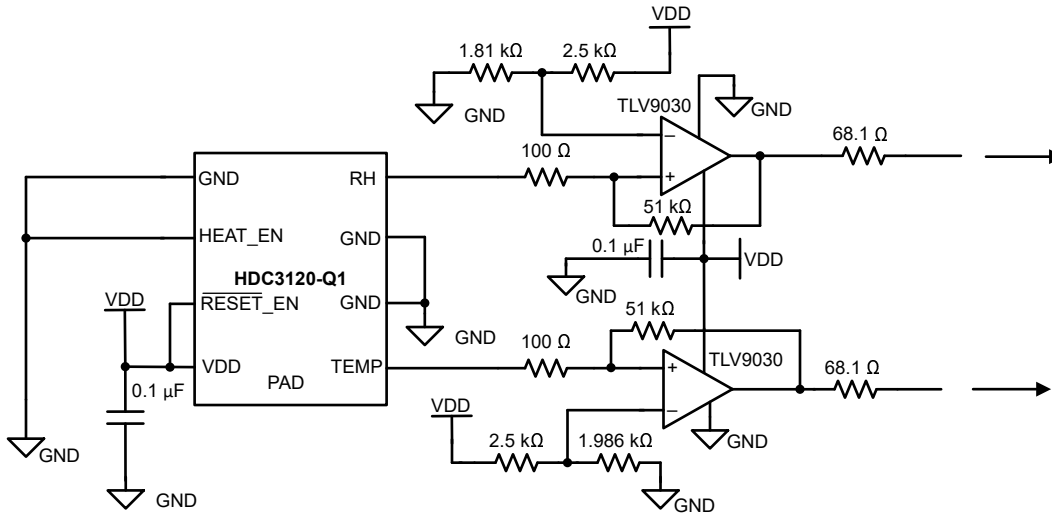

Figure 8-2. HDC3120-Q1 Connection to Comparator

In the above figure, the HDC3120-Q1 outputs are connected to a dual channel comparator to build a local temperature and humidity control system. The analog outputs of the HDC3120-Q1 are compared against a resistor divider reference. In this example, the resistor divider input for the RH output is set to a 90%RH threshold, and a 50°C threshold for the temperature output. For a 3.3V V_{DD}, the RH comparator voltage is set to 2.706V, and the Temp comparator voltage is set to 1.763V. So the comparators trips high if the RH exceeds 90%, or the temperature exceeds 50°C.

This circuit can be used to control fans in a system, or other system logic to protect against high temperature or high humidity conditions. The 51kΩ positive feedback resistors are needed to create comparator hysteresis. This is necessary to prevent the comparator "bouncing" when the HDC3120-Q1 output is close to the resistor divider control voltage.

The hysteresis levels can be set by changing the feedback resistors on each amplifier. In this example, the %RH output channel has a hysteresis of 5%. The hysteresis levels of a comparator can be set according to the instructions in [Comparator With and Without Hysteresis Circuit](#). For a 5%RH hysteresis, the comparator activates at 90%RH, and does not clear the output low until the RH of the HDC3120-Q1 drops below 85%RH. This is illustrated with the following figure:

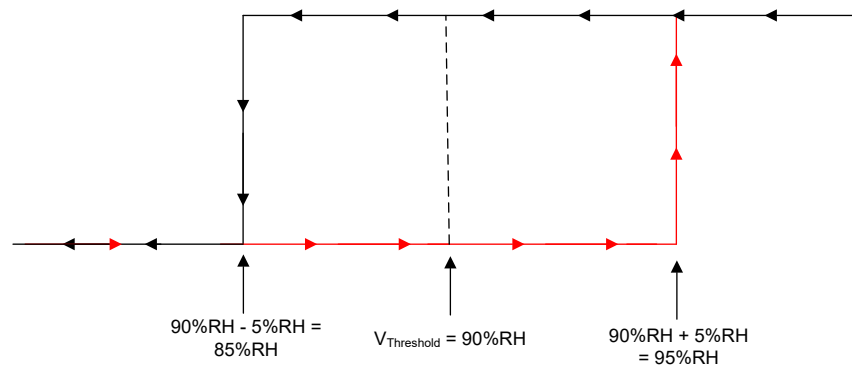

Figure 8-3. Comparator Circuit RH Hysteresis

8.2.1 Design Requirements

The accuracy of a RH and temperature measurement depends on the sensor accuracy and the setup of the sensing system. The HDC3120-Q1 senses relative humidity and temperature in the immediate environment, therefore matching the local conditions at the sensor to the monitored environment is important. Use one or more openings in the physical cover of the end product to obtain a good airflow even in static conditions. Refer to the PCB layout example which minimizes the thermal mass of the PCB in the region of the HDC3120-Q1, which can improve measurement response time and accuracy.

When designing with HDC3120-Q1, the following:

1. To correctly sense the ambient temperature and humidity, the HDC3120-Q1 must be positioned away from heat sources on the PCB.
2. Avoid condensing environments. Water condensation on the sensor surface can create inaccurate RH measurements. Furthermore, operation in such environments introduces a risk of water penetration under the package of the device, leading to potential short circuits between pins.
3. Avoid direct light to the sensor. Light can accelerate capacitor polymer aging and lead to increased RH drift over time. Direct light exposure can also lead to heating of the sensor, causing inaccurate measurements.
4. In enclosed applications, avoid placing the sensor in air "dead zones", where air flow is poor does not circulate the desired air to be measured. Sensors placed in a vertical mounting position relative to the ground yield better results than those in horizontal positions.
5. Avoid placing sensor in strong air flow areas (wind speeds above 1m/s), as this leads to increased Temperature and RH output noise.
6. Verify that the sensor temperature closely matches the ambient air temperature. In some cases, sensor temperature offset by 1°C can lead to 3% change of RH output error due to this mismatch.
7. Prevent dust from accumulating over time around or on top of the sensor. For dust-ridden or dirty environments, consider the digital HDC3022, which includes an IP67 rated filter. Sensors placed in a vertical mounting position yield more positive results than those in horizontal positions to minimize dust accumulation.
8. As the device produces ratiometric output, any noise coupled to the supply or ground voltages has an effect on the output of the device. As such, verify stable ground and supply are supplied to the device for best performance.

8.2.2 Detailed Design Procedure

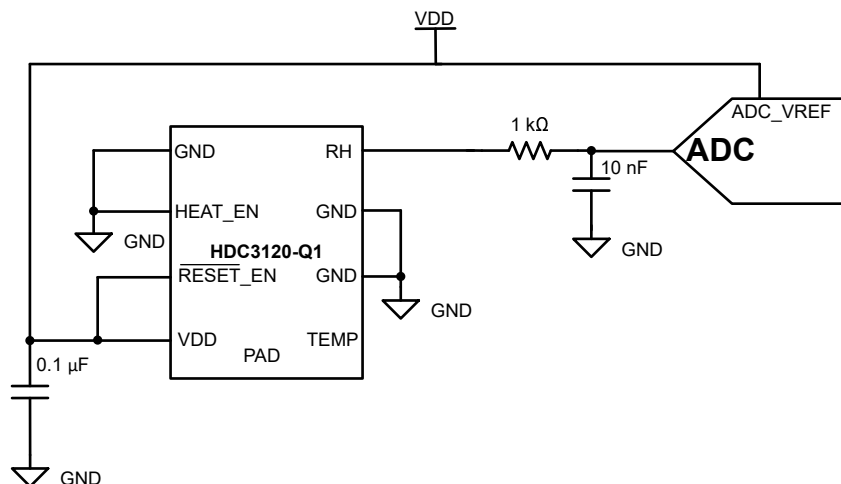

Figure 8-4. HDC3120-Q1 Connecting RH Analog Output to ADC Input

To best use the HDC3120-Q1, keep in mind that the RH and Temperature are analog outputs from a pair of buffered DACs. Hence, RH and Temperature have an LSB. Since the output of the HDC3120-Q1 is ratiometric to the V_{DD} supplied, LSB size varies with different V_{DD} levels. LSB size is calculated by the following formula:

$$1 \text{ LSB} = \frac{\text{FSR}}{2^n - 1} = \frac{0.8 \times V_{DD}}{4095} \quad (8)$$

The output DACs are 12 bits each, and the full-scale range (FSR) is 80% of V_{DD} (10% of V_{DD} is minimum output, 90% of V_{DD} is maximum output). For a nominal V_{DD} voltage of 3.3V, 1 LSB is 644.7 μ V. If a smaller LSB is required, V_{DD} needs to be lowered since as V_{DD} decreases, LSB size decreases proportionally.

To get started with the HDC3120-Q1, first identify the desired sensing conditions and the supply voltage and how the user wants to receive the analog output. For example, connecting to an ADC so that the analog outputs can be received by a microcontroller is a common use-case. In this example situation, the user needs to sense RH from 5% to 95%, in a temperature range of 10°C to 50°C, with a V_{DD} of 5V. A 5V voltage supply creates a DAC LSB of 977 μ V for both temperature and RH outputs.

Next, once the LSB is identified, the user must choose the ADC. In this case, the ADC must have a full scale range (FSR) that can satisfy between 10% and 90% of V_{DD} , so in this case, the FSR must satisfy a range of 500mV to 4.5V at a minimum. The HDC3120-Q1 has an automatic conversion rate of 4 measurements per second after start up, so the ADC must sample at least 4 times per second, but very fast sampling is not necessary. When choosing the ADC FSR, verify that the LSB size of the ADC is less than the LSB of the HDC3120. In this case, the LSB_{ADC} must be less than 977 μ V. Using the HDC3120-Q1 V_{DD} for the ADC reference voltage is recommended, so that noise on the sensor is matched on the ADC. This can impact the chosen ADC as well. If the desired V_{DD} is 5V, then the ADC needs to be able to accept a +5V reference voltage. So the ADC for this scenario needs a maximum LSB of 977 μ V and able to handle inputs up to 4.5V with a reference voltage of 5V.

To build on this, the [ADS1115](#) can be used to interface with HDC3120-Q1. The ADS1115 is a 16-bit ADC with customizable FSR. To satisfy the necessary voltage output range of the HDC3120-Q1, the largest FSR range needs to be chosen, ± 6.144 V. This option has an ADC LSB of 187.5 μ V. This LSB is still much less than the 977 μ V needed for 5V power supply, so this ADC choice satisfies the design needs. A 16-bit ADC is typically a good choice to pair with HDC3120-Q1 since the ADC LSBs is much smaller than the HDC3120-Q1 LSB.

After the ADC is chosen, the user must decide how to connect the HDC3120-Q1 to the ADC. The HDC3120-Q1 DAC output has an internal buffer, so there is no need for an external buffer amplifier to drive long cable lengths or lower the output impedance. Adding a capacitor to the input of an ADC to act as a charge bucket to prevent noise from ADC sampling and a resistor for stability and filtering is typically unnecessary. The HDC3120-Q1 can drive up to 3 μ F capacitive load, and because the HDC3120-Q1 has a 4Hz conversion rate, an RC circuit does not cause a signal slowdown issue, even with a large capacitor value.

8.3 Power Supply Recommendations

The HDC3120-Q1 supports a voltage supply range from 1.62V up to 5.50V. TI recommends a multilayer ceramic bypass X7R capacitor of 0.1 μ F between the V_{DD} and GND pins. If the user plans to use the heater, then the user must verify that the power supply and V_{DD} /GND traces can handle up to 50mA.

The HDC3120-Q1 analog outputs are ratiometric to the V_{DD} supplied to the device, and noise on the V_{DD} must be considered as well. Noise on V_{DD} signal creates noise on the analog output pins. This can manifest in mirrored noise signals on the outputs that are also seen on V_{DD} , and increased INL & DNL errors. The user must take care to keep the V_{DD} as low noise as possible to protect the signal integrity of the analog outputs.

8.4 Layout

8.4.1 Layout Guidelines

When doing PCB for humidity sensors, the most important concept to understand is that the junction temperature of the humidity sensor needs to match the ambient temperature as closely as possible. This is because to obtain an accurate relative humidity result, the temperature measured by the sensor needs to be of the ambient air since relative humidity is dependant on temperature. Practically, this means minimizing the thermal resistance between the HDC3120-Q1 and the ambient air, and maximizing the thermal resistance between the HDC3120-Q1 and PCB heat sources. To accomplish these goals, TI recommends to:

1. Isolate all heat sources from the HDC3120-Q1. This design means positioning the HDC3120-Q1 away from power intensive board components such as a battery, display, or microcontroller. Preferably, the only onboard component close to the HDC3120-Q1 is the supply bypass capacitor. See the [Layout Example](#) for more information.
2. Eliminate copper layers below and around the device (GND, V_{DD}) that are connected to other potentially heat generating components on the PCB or carry thermal energy from another source.
3. A small exposed backside copper layer that is not electrically connected to any signal can be placed underneath the HDC3120-Q1 (with the thermal pad soldered). Thermal vias can then be added to better thermally connect the HDC3120-Q1 package to the backside copper plane. The purpose of this copper plane is to provide another path for ambient air temperature to reach the HDC3120-Q1. The copper plane heats or cools as the plane is exposed to the ambient air, and then pass that temperature change through the thermal vias to the HDC3120-Q1. This way the HDC3120-Q1 is not only receiving the ambient air temperature through the package body on the topside of the PCB, but through conducted thermal transfer as well.
4. Use slots or a cutout around the device to reduce the thermal mass and obtain a quicker response time to sudden environmental changes.
 - The diameter of the routing in [Layout Example](#) is 6mm. There is not a recommendation on exactly how wide the slot-cut needs to be in the PCB, the user must verify that there is sufficient isolation of external thermal gradients present on the PCB. TI recommends placing as large of a slot-cut as possible around the HDC3120-Q1. Other representations of cutouts for thermal relief and additional layout guidelines and information can be found in the [Optimizing Placement and Routing for Humidity Sensors](#) application note.
5. Follow the Example Board Layout and Example Stencil Design that is illustrated in [Section 11](#).
 - TI recommends a multilayer ceramic bypass X7R capacitor of 0.1 μ F between the VDD and GND pins.
6. Soldering the package thermal pad to a board pad that is left electrically floating is generally best practice. However, the package thermal pad can be left unsoldered to minimize thermal leakage for maximum heater efficiency. See the [HDC3x Silicon User's Guide](#) for more information regarding when leaving the thermal pad unsoldered can be helpful for the user application.

8.4.2 Layout Example

The only component next to the device is the supply bypass capacitor. Since the relative humidity is dependent on the temperature, the HDC3120-Q1 must be positioned away from hot spots present on the board, such as a battery, display or micro-controller. The highlighted circular section around the HDC3120-Q1 is a cutout in the PCB. This means thermal energy from elsewhere on the PCB must transfer across air, which has a much higher thermal resistance than PCB materials. The PCB cutout helps thermally isolate the HDC3120-Q1 and hence provide more accurate ambient measurements.

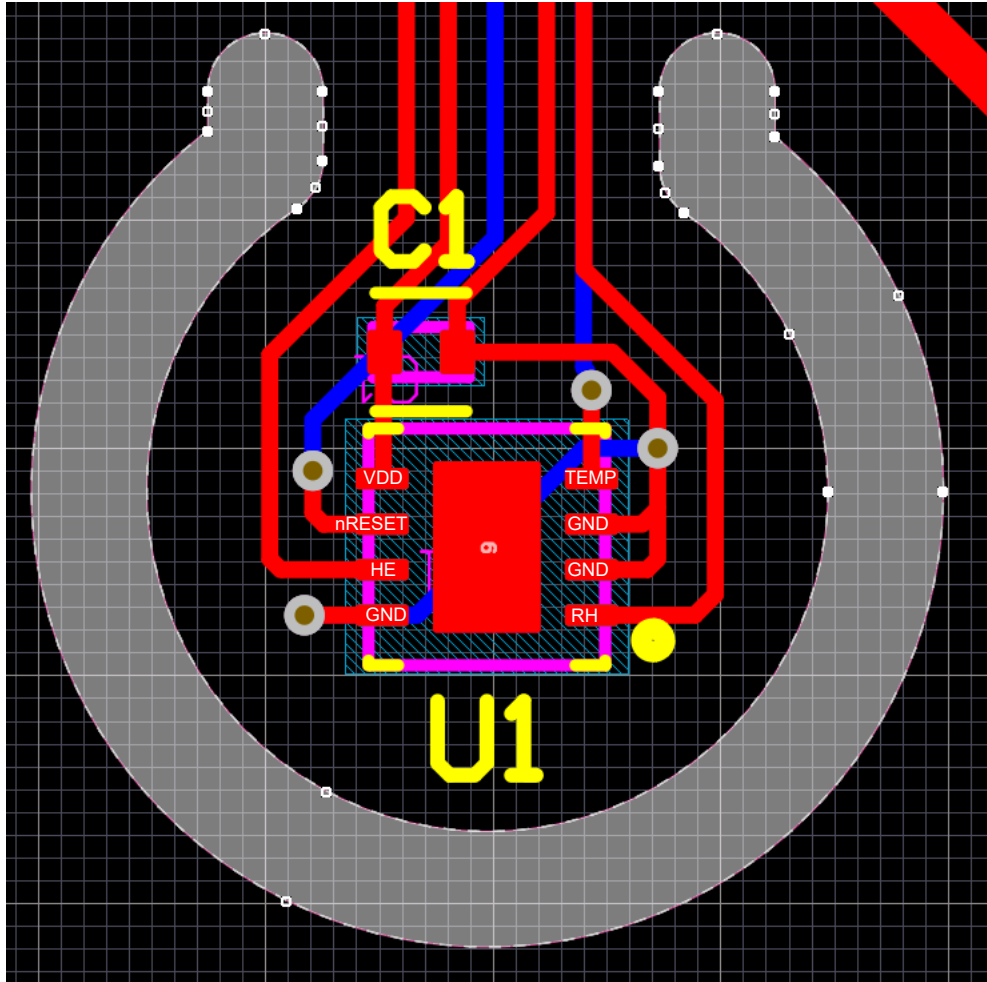

Figure 8-5. Layout Example

8.5 Storage and PCB Assembly

8.5.1 Storage and Handling

Polymer based humidity sensors, such as the HDC3120-Q1 must follow special guidelines regarding handling and storage that are not common with standard semiconductor devices. This section provides best practices to verify that the HDC3120-Q1 humidity sensor maintains accurate performance from production through end use. This section covers proper storage conditions, the importance of rehydration, recommended solder reflow processes, guidelines for safe rework, and methods for improving sensor performance after exposure to harsh conditions. See also the [HDC3x Silicon User's Guide](#).

8.5.2 Product Storage

Proper storage minimizes shifts in relative humidity (RH) accuracy and prevents contamination. HDC3120-Q1 has a MSL Level 1. For general details on storage duration and reflow profiles, refer to : [MSL Ratings and Reflow Profiles](#).

A typical recommended storage environment is 10°C to 35°C and 20% to 60% RH. Keep devices in sealed, controlled environments to protect against moisture and chemical contaminants. Keep the sensor shielded from UV/visible light and chemical vapors whenever possible.

In regards to packaging materials, polyethylene bags must be avoided (often blue, pink, or yellow) because the bags can emit harmful vapors. Use sealed, anti-static, moisture-barrier bags (metallic) to protect against excessive moisture and outgassing.

8.5.3 PCB Assembly Flow

Providing a clean, minimal-exposure assembly process protects the sensing element and preserves accuracy. When possible, place the HDC3120-Q1 sensor as one of the last components on the board to limit the number of solder reflow cycles and exposure to contaminants. Follow these guidelines for recommended soldering reflow procedures:

- **Reflow Profile:** Adhere to IPC/JEDEC J-STD-020 with a peak temperature not exceeding 260°C. For general reflow guidelines, refer to: [MSL Ratings and Reflow Profiles](#).
- **No-Clean Solder Paste:** Must be used for open-cavity devices (HDC3020, HDC3120, HDC3120-Q1 or HDC3021 after tape removal) because water or solvent rinses can leave contaminants on the sensing area. Also verify that the no-clean flux does not contain volatile chemicals that can outgas.
- **Impact on Sensor Accuracy:** High temperature can temporarily shift RH readings, this shift reduces over time as the sensor is exposed to typical indoor ambient conditions to absorb moisture, and typically recovered by rehydration.
- **Board wash:** For boards requiring washing, cover the sensor cavity during any washing. Do not wash the open cavity sensors without a protective cover (for example, HDC3120-Q1) water or solvents. Avoid ultrasonic cleaners or vibrations that can damage the sensor.

8.5.4 Rework Consideration

Multiple reflow cycles can degrade sensor performance. Ideally, restrict the sensor to a single reflow cycle. A second reflow is possible only if the sensing polymer remains clean and undamaged, no-clean paste is used, and peak temperature is under 260°C.

Hand or hot-air Rework is generally not recommended; if necessary, limit the exposure of the device to direct heat, and avoid contaminating fluxes. If any rework is performed, verify sensor accuracy under controlled humidity conditions after rework.

8.5.5 Sensitivity to Chemicals and Vapors

Humidity-sensing polymers can absorb various chemicals, leading to temporary or permanent accuracy shifts. Common contaminants include:

- Cleaning agents (ammonia, bleach, hydrogen peroxide)
- Adhesives, acidic or basic fumes, outgassing from packaging materials

Check relevant material safety data sheets (MSDS) for potential contaminants. Minimize damage by operating the sensor in controlled environments, limiting VOC exposure, and verifying the device is sealed or shielded from corrosive or high-concentration fumes.

Testing for specific chemicals and exposure profiles have been performed for some chemicals, for results and information on the chemicals testing done for the HDC3x humidity sensor family, refer to the [HDC3x Silicon User's Guide](#).

8.5.6 Exposure to High Temperature and High Humidity Conditions

Prolonged operation at extremes (high or low) relative humidities and/or temperatures can temporarily shift the RH output. Long exposure outside the recommended operating conditions at both extreme humidity and temperature can temporarily or permanently offset the RH output.

The recommended humidity operating range is 0 to 100% RH (non-condensing) over –20°C to 80°C. Operating beyond these ranges, or prolonged operation at certain extremes within these ranges (e.g. 85%RH at 80°C) can lead to:

- Gradual RH Offset: Extended exposure near 100% RH can temporarily shift readings.
- Slow Recovery: Return to normal ambient conditions typically resolves offsets over hours or days.
- Permanent Effects: Repeated or severe exposure can result in irreversible drift.

8.5.7 Recovering Sensor Performance: Bake and Rehydration Procedure

If the sensor experiences drift due to high humidity and temperature condition or chemical exposure, a targeted recovery process can help:

1. **Bake** at elevated temperature and low humidity (100°C at <5% RH) for 5–10 hours, this can help accelerate evaporation and hence enable removal of certain contaminants.
2. **Rehydrate** using one of the recommended re-hydration profiles described in the *Rehydration Recommendations* section, which can help bring the polymer to equilibrium, aiding in the recovery of baseline performance.
3. **Verify** the sensor output to confirm restoration of accuracy.

In certain cases, such as those involving corrosive chemicals or physical damage, full recovery is not always possible.

9 Device and Documentation Support

9.1 Documentation Support

9.1.1 Related Documentation

- Texas Instruments, [Humidity Sensor: Storage and Handling Guidelines](#), application note
- Texas Instruments, [Optimizing Placement and Routing for Humidity Sensors](#), application note
- Texas Instruments, [HDC3x Silicon User's Guide](#), user's guide
- Texas Instruments, [I²C Pullup Resistor Calculation](#), application note
- Texas Instruments, [85°C/85% RH Accelerated Life Test Impact on Humidity Sensors](#), white paper
- Texas Instruments, [Why long-term consistent performance matters for relative humidity sensors](#), technical article

9.2 Receiving Notification of Documentation Updates

To receive notification of documentation updates, navigate to the device product folder on ti.com. Click on *Notifications* to register and receive a weekly digest of any product information that has changed. For change details, review the revision history included in any revised document.

9.3 Support Resources

[TI E2E™ support forums](#) are an engineer's go-to source for fast, verified answers and design help — straight from the experts. Search existing answers or ask your own question to get the quick design help you need.

Linked content is provided "AS IS" by the respective contributors. They do not constitute TI specifications and do not necessarily reflect TI's views; see TI's [Terms of Use](#).

9.4 Trademarks

TI E2E™ is a trademark of Texas Instruments.

All trademarks are the property of their respective owners.

9.5 Electrostatic Discharge Caution



This integrated circuit can be damaged by ESD. Texas Instruments recommends that all integrated circuits be handled with appropriate precautions. Failure to observe proper handling and installation procedures can cause damage.

ESD damage can range from subtle performance degradation to complete device failure. Precision integrated circuits may be more susceptible to damage because very small parametric changes could cause the device not to meet its published specifications.

9.6 Glossary

[TI Glossary](#) This glossary lists and explains terms, acronyms, and definitions.

10 Revision History

NOTE: Page numbers for previous revisions may differ from page numbers in the current version.

Changes from Revision * (February 2025) to Revision A (May 2025)	Page
• Changed data sheet status from Advanced Information to Production Mixed.....	1

11 Mechanical, Packaging, and Orderable Information

The following pages include mechanical, packaging, and orderable information. This information is the most current data available for the designated devices. This data is subject to change without notice and revision of this document. For browser-based versions of this data sheet, refer to the left-hand navigation.



DEF0008A-C01

PACKAGE OUTLINE
WSON - 0.8 mm max height

PLASTIC SMALL OUTLINE - NO LEAD

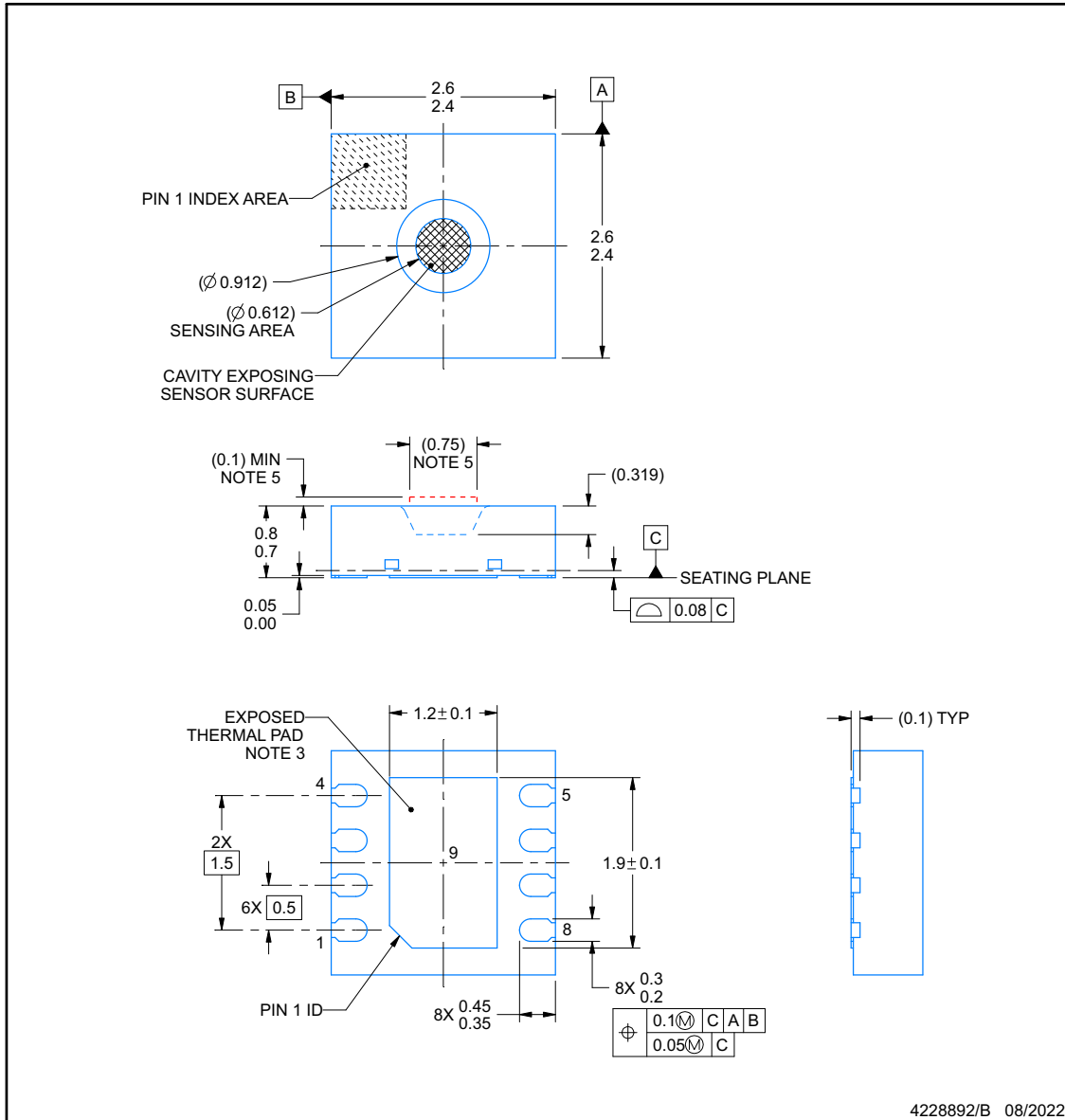

NOTES:

1. All linear dimensions are in millimeters. Any dimensions in parenthesis are for reference only. Dimensioning and tolerancing per ASME Y14.5M.
2. This drawing is subject to change without notice.
3. It is generally best practice to solder the package thermal pad to a board pad that is connected to ground, however to minimize thermal mass for maximum heater efficiency or to measure ambient temperature it may be left floating.
4. The pick and place nozzle internal diameter has to be between $\varnothing 0.915$ and $\varnothing 1.875$ mm.
5. Customers must maintain adequate clearance from this region to allow for proper functioning of the humidity sensor.

Figure 11-1. HDC3120-Q1 Package Outline Drawing

EXAMPLE BOARD LAYOUT

DEF0008A-C01

WSN - 0.8 mm max height

PLASTIC SMALL OUTLINE - NO LEAD

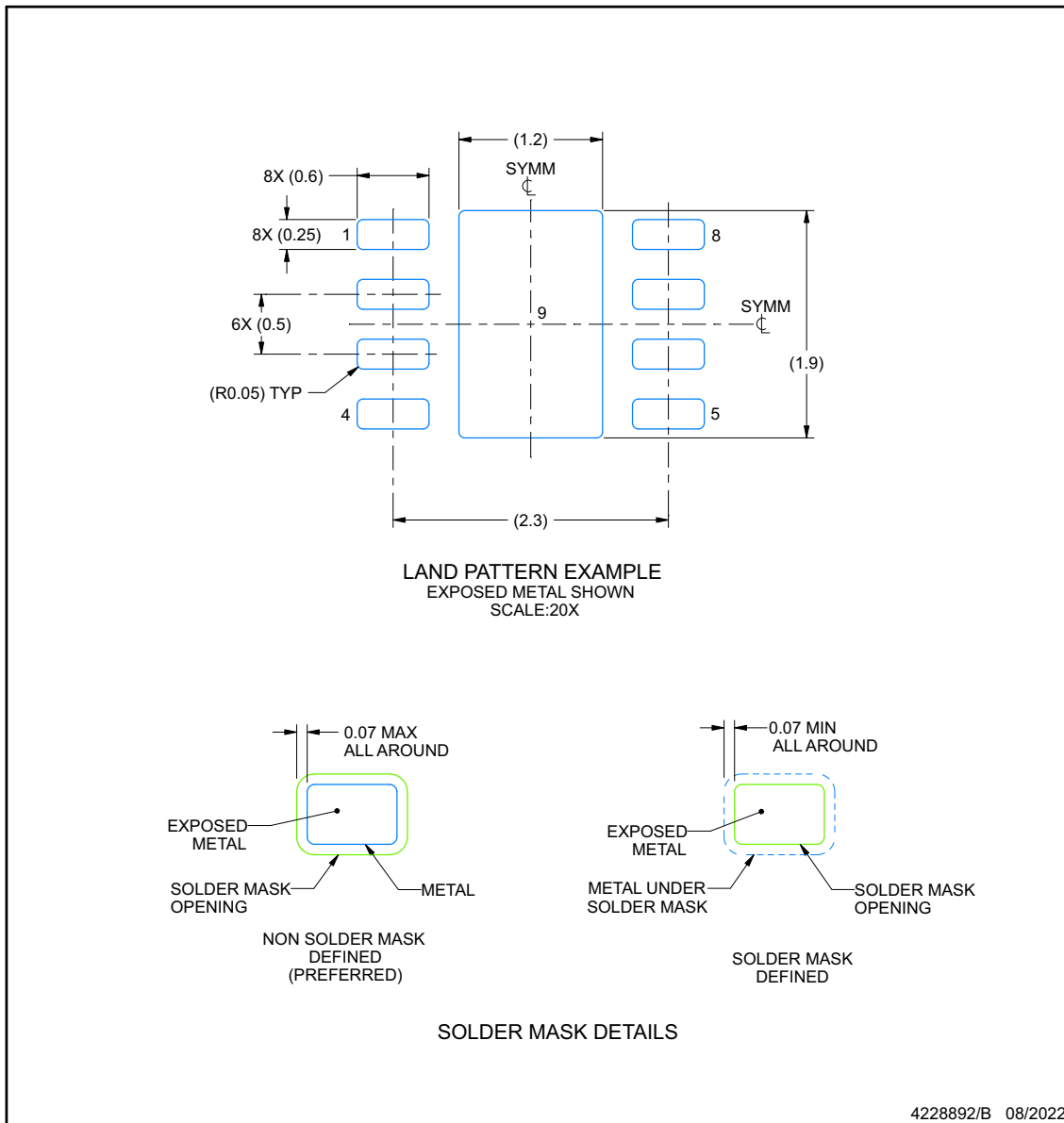

NOTES: (continued)

6. This package is designed to be soldered to a thermal pad on the board. For more information, see Texas Instruments literature number SLUA271 (www.ti.com/lit/sluea271).
7. Vias are optional depending on application, refer to device data sheet. If any vias are implemented, refer to their locations shown on this view. It is recommended that vias under paste be filled, plugged or tented.

Figure 11-2. HDC3120-Q1 Example Board Layout

EXAMPLE STENCIL DESIGN

DEF0008A-C01

WSON - 0.8 mm max height

PLASTIC SMALL OUTLINE - NO LEAD

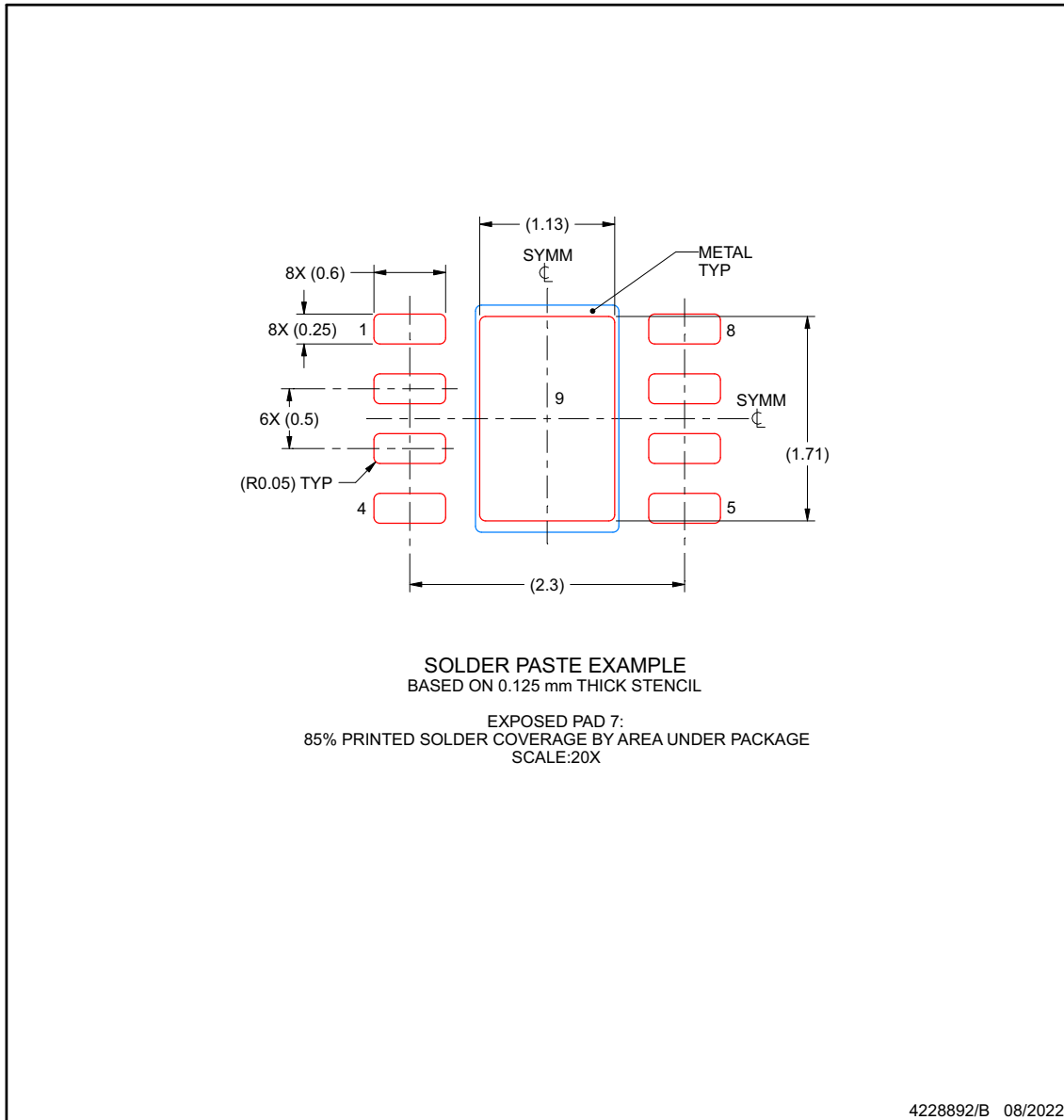

NOTES: (continued)

8. Laser cutting apertures with trapezoidal walls and rounded corners may offer better paste release. IPC-7525 may have alternate design recommendations.

PACKAGING INFORMATION

Orderable part number	Status (1)	Material type (2)	Package Pins	Package qty Carrier	RoHS (3)	Lead finish/ Ball material (4)	MSL rating/ Peak reflow (5)	Op temp (°C)	Part marking (6)
HDC3120QDEFRQ1	Active	Production	WSON (DEF) 8	3000 LARGE T&R	Yes	NIPDAU	Level-1-260C-UNLIM	-40 to 125	Y

(1) **Status:** For more details on status, see our [product life cycle](#).

(2) **Material type:** When designated, preproduction parts are prototypes/experimental devices, and are not yet approved or released for full production. Testing and final process, including without limitation quality assurance, reliability performance testing, and/or process qualification, may not yet be complete, and this item is subject to further changes or possible discontinuation. If available for ordering, purchases will be subject to an additional waiver at checkout, and are intended for early internal evaluation purposes only. These items are sold without warranties of any kind.

(3) **RoHS values:** Yes, No, RoHS Exempt. See the [TI RoHS Statement](#) for additional information and value definition.

(4) **Lead finish/Ball material:** Parts may have multiple material finish options. Finish options are separated by a vertical ruled line. Lead finish/Ball material values may wrap to two lines if the finish value exceeds the maximum column width.

(5) **MSL rating/Peak reflow:** The moisture sensitivity level ratings and peak solder (reflow) temperatures. In the event that a part has multiple moisture sensitivity ratings, only the lowest level per JEDEC standards is shown. Refer to the shipping label for the actual reflow temperature that will be used to mount the part to the printed circuit board.

(6) **Part marking:** There may be an additional marking, which relates to the logo, the lot trace code information, or the environmental category of the part.

Multiple part markings will be inside parentheses. Only one part marking contained in parentheses and separated by a "-" will appear on a part. If a line is indented then it is a continuation of the previous line and the two combined represent the entire part marking for that device.

Important Information and Disclaimer:The information provided on this page represents TI's knowledge and belief as of the date that it is provided. TI bases its knowledge and belief on information provided by third parties, and makes no representation or warranty as to the accuracy of such information. Efforts are underway to better integrate information from third parties. TI has taken and continues to take reasonable steps to provide representative and accurate information but may not have conducted destructive testing or chemical analysis on incoming materials and chemicals. TI and TI suppliers consider certain information to be proprietary, and thus CAS numbers and other limited information may not be available for release.

In no event shall TI's liability arising out of such information exceed the total purchase price of the TI part(s) at issue in this document sold by TI to Customer on an annual basis.

OTHER QUALIFIED VERSIONS OF HDC3120-Q1 :

- Catalog : [HDC3120](#)

NOTE: Qualified Version Definitions:

- Catalog - TI's standard catalog product

TAPE AND REEL INFORMATION

QUADRANT ASSIGNMENTS FOR PIN 1 ORIENTATION IN TAPE

*All dimensions are nominal

Device	Package Type	Package Drawing	Pins	SPQ	Reel Diameter (mm)	Reel Width W1 (mm)	A0 (mm)	B0 (mm)	K0 (mm)	P1 (mm)	W (mm)	Pin1 Quadrant
HDC3120QDEFRQ1	WSO8	DEF	8	3000	330.0	12.4	2.75	2.75	1.3	8.0	12.0	Q1

TAPE AND REEL BOX DIMENSIONS

*All dimensions are nominal

Device	Package Type	Package Drawing	Pins	SPQ	Length (mm)	Width (mm)	Height (mm)
HDC3120QDEFRQ1	WSON	DEF	8	3000	356.0	338.0	48.0

IMPORTANT NOTICE AND DISCLAIMER

TI PROVIDES TECHNICAL AND RELIABILITY DATA (INCLUDING DATASHEETS), DESIGN RESOURCES (INCLUDING REFERENCE DESIGNS), APPLICATION OR OTHER DESIGN ADVICE, WEB TOOLS, SAFETY INFORMATION, AND OTHER RESOURCES "AS IS" AND WITH ALL FAULTS, AND DISCLAIMS ALL WARRANTIES, EXPRESS AND IMPLIED, INCLUDING WITHOUT LIMITATION ANY IMPLIED WARRANTIES OF MERCHANTABILITY, FITNESS FOR A PARTICULAR PURPOSE OR NON-INFRINGEMENT OF THIRD PARTY INTELLECTUAL PROPERTY RIGHTS.

These resources are intended for skilled developers designing with TI products. You are solely responsible for (1) selecting the appropriate TI products for your application, (2) designing, validating and testing your application, and (3) ensuring your application meets applicable standards, and any other safety, security, regulatory or other requirements.

These resources are subject to change without notice. TI grants you permission to use these resources only for development of an application that uses the TI products described in the resource. Other reproduction and display of these resources is prohibited. No license is granted to any other TI intellectual property right or to any third party intellectual property right. TI disclaims responsibility for, and you fully indemnify TI and its representatives against any claims, damages, costs, losses, and liabilities arising out of your use of these resources.

TI's products are provided subject to [TI's Terms of Sale](#), [TI's General Quality Guidelines](#), or other applicable terms available either on [ti.com](#) or provided in conjunction with such TI products. TI's provision of these resources does not expand or otherwise alter TI's applicable warranties or warranty disclaimers for TI products. Unless TI explicitly designates a product as custom or customer-specified, TI products are standard, catalog, general purpose devices.

TI objects to and rejects any additional or different terms you may propose.

Copyright © 2026, Texas Instruments Incorporated

Last updated 10/2025