

LMx24, LMx24x, LMx24xx, LM2902, LM2902x, LM2902xx, LM2902xxx Quadruple Operational Amplifiers

1 Features

- New [LM324B](#) and [LM2902B](#)
- B versions are drop-in replacements for all versions of LM224, LM324, and LM2902
- Improved specifications of B version
 - Supply range: 3V to 36V (B, BA versions)
 - Low input offset voltage: $\pm 2\text{mV}$ (BA version) / 3mV (B version)
 - ESD rating: 2kV (HBM), 1.5kV (CDM)
 - EMI rejection: integrated RF and EMI filter
 - Low input bias current: 50nA maximum (across -40°C to 125°C)
- Common-mode input voltage range includes V_-
- Input voltage differential can be driven up to supply voltage
- For dual B versions, see [LM358B](#) and [LM2904B](#)

2 Applications

- [Merchant network and server power supply units](#)
- [Multi-function printers](#)
- [Power supplies and mobile chargers](#)
- [Desktop PC and motherboard](#)
- [Indoor and outdoor air conditioners](#)
- [Washers, dryers, and refrigerators](#)
- [AC inverters, string inverters, central inverters, and voltage frequency drives](#)
- [Uninterruptible power supplies](#)

3 Description

The [LM324B](#) and [LM2902B](#) devices are the next-generation versions of the industry-standard operational amplifiers (op amps) LM324 and LM2902, which include four high-voltage (36V) op amps. These devices provide outstanding value for cost-sensitive applications,

with features including low offset ($600\mu\text{V}$, typical), common-mode input range to ground, and high differential input voltage capability.

The LM324B and LM2902B are unity-gain stable and achieve a low offset voltage maximum of 3mV (2mV maximum for LM324BA and LM2902BA) and quiescent current of $240\mu\text{A}$ per amplifier (typical). High ESD (2kV HBM and 1.5kV CDM) and integrated EMI and RF filters enable the LM324B and LM2902B devices to be used in the most rugged, environmentally challenging applications.

The LM324B and LM2902B can drop-in replace all versions of the LM224, LM324, and LM2902 devices.

Package Information

| PART NUMBER ⁽¹⁾ | PACKAGE | PACKAGE SIZE ⁽²⁾ |
|--|----------------|-----------------------------|
| LM324B ⁽³⁾ , LM324BA ⁽³⁾ , LM2902B ⁽³⁾ , LM2902BA ⁽³⁾ , LM324xx, LM224xx, LM124, LM2902xxx | D (SOIC, 14) | 8.65mm × 6mm |
| LM324B, LM324BA, LM2902B, LM2902BA, LM324xx, LM124, LM2902xxx | PW (TSSOP, 14) | 5mm × 6.4mm |
| LM324xx, LM224xx, LM2902xxx | N (PDIP, 14) | 19.3mm × 9.4mm |
| LM324, LM324A, LM324K, LM324KA, LM2902, LM2902K | NS (SOP, 14) | 10.3mm × 7.8mm |
| LM324A, LM2902K | DB (SSOP, 14) | 6.2mm × 7.8mm |
| LM124A | J (CDIP, 14) | 19.56mm × 6.67mm |
| | W (CFP, 14) | 9.21mm × 6.3mm |
| | FK (LCCC, 20) | 8.89mm × 8.89mm |
| LM324B ⁽³⁾ , LM2902B ⁽³⁾ | RTE (WQFN, 16) | 3mm × 3mm |

- (1) For more information, see [Section 11](#).
- (2) The package size (length × width) is a nominal value and includes pins, where applicable.
- (3) This product is preview only.

Family Comparison

| SPECIFICATION | LM324B LM324BA | LM2902B LM2902BA | LM324 LM324A | LM324K LM324KA | LM2902 | LM2902K LM2902KV LM2902KAV | LM224 LM224A | LM224K LM224KA | LM124 LM124A | Units |
|---|---|---|---|---|------------------------|--|---|---|---|-------|
| Supply voltage | 3 to 36 | 3 to 36 | 3 to 30 | 3 to 30 | 3 to 26 | 3 to 26 (K) 3 to 30 (KV, KAV) | 3 to 30 | 3 to 30 | 3 to 30 | V |
| Offset voltage (max, 25°C) | ± 3 ± 2 | ± 3 ± 2 | ± 7 ± 3 | ± 7 ± 3 | ± 7 | ± 7 (K, KV) ± 2 (KAV) | ± 5 ± 3 | ± 5 ± 3 | ± 5 ± 2 | mV |
| Input bias current at 25 °C (typ / max) | 10 / 35 | 10 / 35 | 20 / 250 15 / 100 | 20 / 250 15 / 100 | 20 / 250 | 20 / 250 | 20 / 150 15 / 80 | 20 / 150 15 / 80 | 20 / 150 – / 50 | nA |
| ESD (HBM) | 2000 | 2000 | 500 | 2000 | 500 | 2000 | 500 | 2000 | 500 | V |
| Operating ambient temperature | -40 to 85 | -40 to 125 | 0 to 70 | 0 to 70 | -40 to 125 | -40 to 125 | -25 to 85 | -25 to 85 | -55 to 125 | °C |



Table of Contents

| | | | |
|---|----------|--|-----------|
| 1 Features | 1 | 6 Parameter Measurement Information | 21 |
| 2 Applications | 1 | 7 Detailed Description | 21 |
| 3 Description | 1 | 7.1 Overview..... | 21 |
| 4 Pin Configuration and Functions | 3 | 7.2 Functional Block Diagram..... | 22 |
| 5 Specifications | 5 | 7.3 Feature Description..... | 23 |
| 5.1 Absolute Maximum Ratings..... | 5 | 7.4 Device Functional Modes..... | 23 |
| 5.2 ESD Ratings..... | 5 | 8 Application and Implementation | 24 |
| 5.3 Recommended Operating Conditions..... | 5 | 8.1 Application Information..... | 24 |
| 5.4 Thermal Information..... | 6 | 8.2 Typical Application..... | 24 |
| 5.5 Electrical Characteristics - LM324B and LM324BA.... | 7 | 8.3 Power Supply Recommendations..... | 25 |
| 5.6 Electrical Characteristics - LM2902B and LM2902BA..... | 9 | 8.4 Layout..... | 25 |
| 5.7 Electrical Characteristics for LM324, LM324K, LM224, LM224K, and LM124..... | 11 | 9 Device and Documentation Support | 27 |
| 5.8 Electrical Characteristics for LM2902, LM2902K, LM2902KV and LM2902KAV..... | 12 | 9.1 Receiving Notification of Documentation Updates...27 | |
| 5.9 Electrical Characteristics for LM324A, LM324KA, LM224A, LM224KA, and LM124A..... | 13 | 9.2 Support Resources..... | 27 |
| 5.10 Operating Conditions..... | 13 | 9.3 Trademarks..... | 27 |
| 5.11 Typical Characteristics..... | 14 | 9.4 Electrostatic Discharge Caution..... | 27 |
| 5.12 Typical Characteristics: All Devices Except B and BA Versions..... | 20 | 9.5 Glossary..... | 27 |
| | | 10 Revision History | 27 |
| | | 11 Mechanical, Packaging, and Orderable Information | 28 |
| | | 11.1 Package Option Addendum..... | 29 |
| | | 11.2 Tape and Reel Information..... | 30 |

4 Pin Configuration and Functions

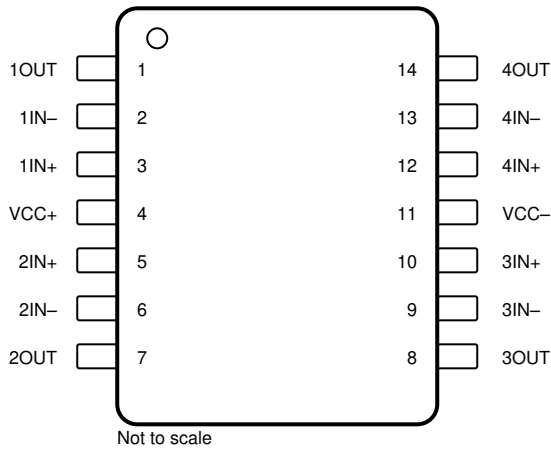

Figure 4-1. D, DB, J, N, NS, PW, and W Packages, 14-Pin SOIC, SSOP, CDIP, PDIP, SO, TSSOP, and CFP (Top View)

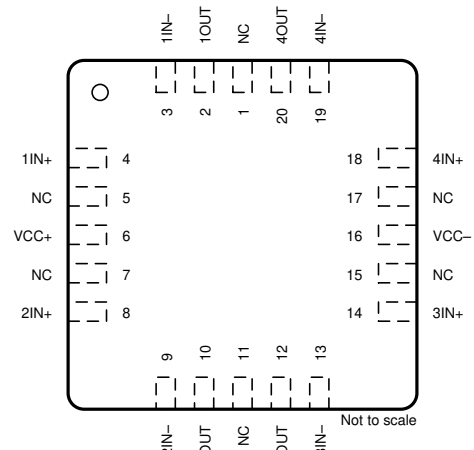
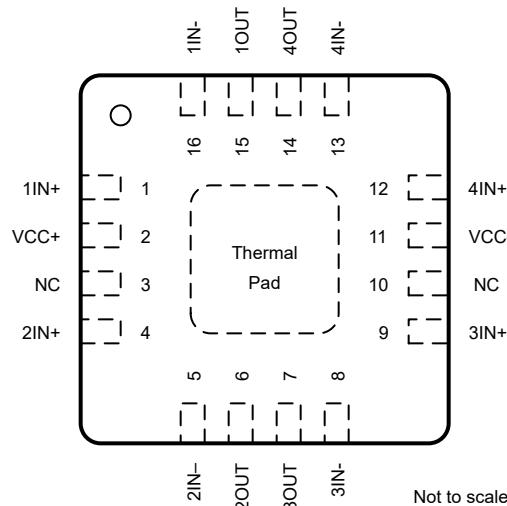

Figure 4-2. FK Package, 20-Pin LCCC (Top View)



NOTE: RTE package is preview only

Figure 4-3. RTE Package, 16-Pin WQFN (Top View)

Table 4-1. Pin Functions

| NAME | PIN | | | TYPE ⁽¹⁾ | DESCRIPTION |
|------|------|--|------|---------------------|----------------|
| | LCCC | SOIC, TSSOP, PDIP, SSOP, SO, CDIP, and CFP | WQFN | | |
| 1IN- | 3 | 2 | 16 | I | Negative input |
| 1IN+ | 4 | 3 | 1 | I | Positive input |
| 1OUT | 2 | 1 | 15 | O | Output |
| 2IN- | 9 | 6 | 5 | I | Negative input |
| 2IN+ | 8 | 5 | 4 | I | Positive input |

Table 4-1. Pin Functions (continued)

| NAME | PIN | | | TYPE ⁽¹⁾ | DESCRIPTION |
|------------------|------------------------|---|-------|---------------------|--|
| | LCCC | SOIC, TSSOP, PDIP, SSOP, SO, CDIP, and CFP | WQFN | | |
| 2OUT | 10 | 7 | 6 | O | Output |
| 3IN– | 13 | 9 | 8 | I | Negative input |
| 3IN+ | 14 | 10 | 9 | I | Positive input |
| 3OUT | 12 | 8 | 7 | O | Output |
| 4IN– | 19 | 13 | 13 | I | Negative input |
| 4IN+ | 18 | 12 | 12 | I | Positive input |
| 4OUT | 20 | 14 | 14 | O | Output |
| V _{CC–} | 16 | 11 | 11 | — | Negative (lowest) supply or ground (for single-supply operation) |
| NC | 1, 5, 7, 11, 15, 17 | — | 3, 10 | — | Do not connect |
| V _{CC+} | 6 | 4 | 2 | — | Positive (highest) supply |

(1) I = input, O = output

5 Specifications

5.1 Absolute Maximum Ratings

over operating free-air temperature range (unless otherwise noted)⁽¹⁾

| | LM324B, LM324BA, LM2902B, LM2902BA | | LM2902 | | LM324xx, LM224xx, LM2902xxx, LM124x | | UNIT |
|--|---------------------------------------|-----|-----------|-----|--|-----|------|
| | MIN | MAX | MIN | MAX | MIN | MAX | |
| Supply voltage, V_{CC} ⁽²⁾ | 40 | | 26 | | 32 | | V |
| Differential input voltage, V_{ID} ⁽³⁾ | ±40 | | ±26 | | ±32 | | V |
| Input voltage, V_I (either input) | -0.3 | 40 | -0.3 | 26 | -0.3 | 32 | V |
| Duration of output short circuit (one amplifier) to ground at (or below) $T_A = 25^\circ\text{C}$, $V_{CC} \leq 15\text{ V}$ ⁽⁴⁾ | Unlimited | | Unlimited | | Unlimited | | |
| Operating virtual junction temperature, T_J | 150 | | 150 | | 150 | | °C |
| Case temperature for 60 seconds | FK package | | | | 260 | | °C |
| Lead temperature 1.6 mm (1/16 inch) from case for 60 seconds | J or W package | | 300 | | 300 | | °C |
| Storage temperature, T_{stg} | -65 | 150 | -65 | 150 | -65 | 150 | °C |

- Stresses beyond those listed under *Absolute Maximum Ratings* may cause permanent damage to the device. These are stress ratings only, and functional operation of the device at these or any other conditions beyond those indicated under *Recommended Operating Conditions* is not implied. Exposure to absolute-maximum-rated conditions for extended periods may affect device reliability.
- All voltage values (except differential voltages and V_{CC} specified for the measurement of I_{OS}) are with respect to the network GND.
- Differential voltages are at $IN+$, with respect to $IN-$.
- Short circuits from outputs to V_{CC} can cause excessive heating and eventual destruction.

5.2 ESD Ratings

| | | | VALUE | UNIT |
|---|-------------------------|---|-------|------|
| LM324B, LM324BA, LM2902B, LM2902BA, LM224K, LM224KA, LM324K, LM324KA, LM2902K, LM2902KV, LM2902KAV | | | | |
| $V_{(ESD)}$ | Electrostatic discharge | Human-body model (HBM), per ANSI/ESDA/JEDEC JS-001 ⁽¹⁾ | ±2000 | V |
| | | Charged-device model (CDM), per JEDEC specification JESD22-C101 | ±1000 | |
| LM124, LM124A, LM224, LM224A, LM324, LM324A, LM2902 | | | | |
| $V_{(ESD)}$ | Electrostatic discharge | Human-body model (HBM), per ANSI/ESDA/JEDEC JS-001 ⁽¹⁾ | ±500 | V |
| | | Charged-device model (CDM), per JEDEC specification JESD22-C101 | ±1000 | |

- JEDEC document JEP155 states that 500-V HBM allows safe manufacturing with a standard ESD control process.

5.3 Recommended Operating Conditions

over operating free-air temperature range (unless otherwise noted)

| | LM324B, LM324BA, LM2902B, LM2902BA | | LM2902 | | LM324xx, LM224xx, LM2902xxx, LM124x | | UNIT |
|--------------------------------------|---------------------------------------|--------------|--------|--------------|--|--------------|------|
| | MIN | MAX | MIN | MAX | MIN | MAX | |
| V_{CC} Supply voltage | 3 | 36 | 3 | 26 | 3 | 30 | V |
| V_{CM} Common-mode voltage | 0 | $V_{CC} - 2$ | 0 | $V_{CC} - 2$ | 0 | $V_{CC} - 2$ | V |
| T_A Operating free air temperature | LM124x | | | | -55 | 125 | °C |
| | LM2902xxx, LM2902Bx | -40 | 125 | -40 | 125 | | |
| | LM324Bx | -40 | 85 | | | | |
| | LM224xx | | | | -25 | 85 | |
| | LM324xx | | | | 0 | 70 | |

5.4 Thermal Information

| THERMAL METRIC ⁽¹⁾ | LMx24, LM2902 | | | | | | LMx24 | | | UNIT |
|--|---------------|-----------|----------|---------|------------|---------------------------|-----------|----------|---------|------|
| | D (SOIC) | DB (SSOP) | N (PDIP) | NS (SO) | PW (TSSOP) | RTE (WQFN) ⁽⁵⁾ | FK (LCCC) | J (CDIP) | W (CFP) | |
| | 14 PINS | 14 PINS | 14 PINS | 14 PINS | 14 PINS | 16 PINS | 20 PINS | 14 PINS | 14 PINS | |
| R _{θJA} ^{(2) (3)} Junction-to-ambient thermal resistance | 86 | 86 | 80 | 76 | 113 | TBD | — | — | — | °C/W |
| R _{θJC} ⁽⁴⁾ Junction-to-case (top) thermal resistance | — | — | — | — | — | TBD | 5.61 | 15.05 | 14.65 | °C/W |

- (1) For more information about traditional and new thermal metrics, see the [Semiconductor and IC Package Thermal Metrics](#) application note.
- (2) Short circuits from outputs to VCC can cause excessive heating and eventual destruction.
- (3) Maximum power dissipation is a function of T_{J(max)}, R_{θJA}, and T_A. The maximum allowable power dissipation at any allowable ambient temperature is P_D = (T_{J(max)} – T_A)/R_{θJA}. Operating at the absolute maximum T_J of 150°C can affect reliability.
- (4) Maximum power dissipation is a function of T_{J(max)}, R_{θJA}, and T_C. The maximum allowable power dissipation at any allowable case temperature is P_D = (T_{J(max)} – T_C)/R_{θJC}. Operating at the absolute maximum T_J of 150°C can affect reliability.
- (5) This package is preview only.

5.5 Electrical Characteristics - LM324B and LM324BA

For $V_S = (V+) - (V-) = 5\text{ V to }36\text{ V}$ ($\pm 2.5\text{ V to } \pm 18\text{ V}$), at $T_A = 25^\circ\text{C}$, $V_{CM} = V_{OUT} = V_S / 2$, and $R_L = 10\text{ k}\Omega$ connected to $V_S / 2$ (unless otherwise noted)

| PARAMETER | | TEST CONDITIONS | | MIN | TYP | MAX | UNIT |
|----------------------------|--|---|---|---|---|---------------|--------------------------------------|
| OFFSET VOLTAGE | | | | | | | |
| V_{OS} | Input offset voltage | LM324B | | | ± 0.6 | ± 3.0 | mV |
| | | | $T_A = -40^\circ\text{C to }85^\circ\text{C}$ | | | ± 4.0 | |
| V_{OS} | Input offset voltage | LM324BA | | | ± 0.3 | ± 2 | mV |
| | | | $T_A = -40^\circ\text{C to }85^\circ\text{C}$ | | | 2.5 | |
| dV_{OS}/dT | Input offset voltage drift | $R_S = 0\ \Omega$ | $T_A = -40^\circ\text{C to }85^\circ\text{C}$ | | ± 7 | | $\mu\text{V}/^\circ\text{C}$ |
| PSRR | Input offset voltage versus power supply | | | 65 | 100 | | dB |
| | Channel separation | $f = 1\text{ kHz to }20\text{ kHz}$ | | | 120 | | dB |
| INPUT VOLTAGE RANGE | | | | | | | |
| V_{CM} | Common-mode voltage range | $V_S = 3\text{ V to }36\text{ V}$ | | V_- | | $(V+) - 1.5$ | V |
| | | $V_S = 5\text{ V to }36\text{ V}$ | | $T_A = -40^\circ\text{C to }85^\circ\text{C}$ | V_- | | |
| CMRR | Common-mode rejection ratio | $(V_-) \leq V_{CM} \leq (V+) - 1.5\text{ V}$ | $V_S = 3\text{ V to }36\text{ V}$ | | 70 | 80 | dB |
| | | $(V_-) \leq V_{CM} \leq (V+) - 2\text{ V}$ | $V_S = 5\text{ V to }36\text{ V}$ | $T_A = -40^\circ\text{C to }85^\circ\text{C}$ | 65 | 80 | |
| INPUT BIAS CURRENT | | | | | | | |
| I_B | Input bias current | | | | -10 | -35 | nA |
| | | | | $T_A = -40^\circ\text{C to }85^\circ\text{C}$ | | | |
| dI_{OS}/dT | Input offset current drift | | $T_A = -40^\circ\text{C to }85^\circ\text{C}$ | | 10 | | $\text{pA}/^\circ\text{C}$ |
| I_{OS} | Input offset current | | | | ± 0.5 | ± 4 | nA |
| | | | | $T_A = -40^\circ\text{C to }85^\circ\text{C}$ | | | |
| dI_{OS}/dT | Input offset current drift | | $T_A = -40^\circ\text{C to }85^\circ\text{C}$ | | 10 | | $\text{pA}/^\circ\text{C}$ |
| NOISE | | | | | | | |
| E_N | Input voltage noise | $f = 0.1\text{ to }10\text{ Hz}$ | | | 3 | | μV_{PP} |
| e_N | Input voltage noise density | $R_S = 100\ \Omega, V_I = 0\text{ V}, f = 1\text{ kHz}$ (see Figure 7-2 for test circuit) | | | 35 | | $\text{nV}/\sqrt{\text{Hz}}$ |
| INPUT CAPACITANCE | | | | | | | |
| Z_{ID} | Differential | | | | $10 \parallel 0.1$ | | $\text{M}\Omega \parallel \text{pF}$ |
| Z_{ICM} | Common-mode | | | | $4 \parallel 1.5$ | | $\text{G}\Omega \parallel \text{pF}$ |
| OPEN-LOOP GAIN | | | | | | | |
| A_{OL} | Open-loop voltage gain | $V_S = 15\text{ V}, V_O = 1\text{ V to }11\text{ V}, R_L \geq 10\text{ k}\Omega$, connected to (V_-) | | | 50 | 100 | V/mV |
| | | | | $T_A = -40^\circ\text{C to }85^\circ\text{C}$ | 25 | | |
| FREQUENCY RESPONSE | | | | | | | |
| GBW | Gain-bandwidth product | $R_L = 1\text{ M}\Omega, C_L = 20\text{ pF}$ (see Figure 7-1 for test circuit) | | | 1.2 | | MHz |
| SR | Slew rate | $R_L = 1\text{ M}\Omega, C_L = 30\text{ pF}, V_I = \pm 10\text{ V}$ (see Figure 7-1 for test circuit) | | | 0.5 | | $\text{V}/\mu\text{s}$ |
| θ_m | Phase margin | $G = +1, R_L = 10\text{ k}\Omega, C_L = 20\text{ pF}$ | | | 56 | | $^\circ$ |
| t_s | Settling time | To 0.1%, $V_S = 5\text{ V}, 2\text{-V Step}, G = +1, C_L = 100\text{ pF}$ | | | 4 | | μs |
| | Overload recovery time | $V_{IN} \times \text{gain} > V_S$ | | | 10 | | μs |
| THD+N | Total harmonic distortion + noise | $G = +1, f = 1\text{ kHz}, V_O = 3.53\text{ }V_{RMS}, V_S = 36\text{ V}, R_L = 100\text{ k}\Omega, I_{OUT} \leq 50\ \mu\text{A}, \text{BW} = 80\text{ kHz}$ | | | 0.001% | | |
| OUTPUT | | | | | | | |
| V_O | Voltage output swing from rail | Positive Rail (V+) | | $I_{OUT} = -50\ \mu\text{A}$ | 1.35 | 1.5 | V |
| V_O | | | | $I_{OUT} = -1\text{ mA}$ | 1.4 | 1.6 | V |
| V_O | | | | $I_{OUT} = -5\text{ mA}$ | 1.5 | 1.75 | V |
| V_O | | Negative Rail (V-) | | $I_{OUT} = 50\ \mu\text{A}$ | 100 | 150 | mV |
| V_O | | | | $I_{OUT} = 1\text{ mA}$ | 0.75 | 1 | V |
| V_O | | | | $V_S = 5\text{ V}, R_L \leq 10\text{ k}\Omega$ connected to (V_-) | $T_A = -40^\circ\text{C to }85^\circ\text{C}$ | 5 | 20 |
| I_O | Output current | $V_S = 15\text{ V}; V_O = V_-; V_{ID} = 1\text{ V}$ | Source | | -20 ⁽¹⁾ | -30 | mA |
| | | | | $T_A = -40^\circ\text{C to }85^\circ\text{C}$ | -10 ⁽¹⁾ | | mA |
| | | $V_S = 15\text{ V}; V_O = V_+; V_{ID} = -1\text{ V}$ | Sink | | 10 ⁽¹⁾ | 20 | mA |
| | | | | $T_A = -40^\circ\text{C to }85^\circ\text{C}$ | 5 ⁽¹⁾ | | mA |
| | | $V_{ID} = -1\text{ V}; V_O = (V_-) + 200\text{ mV}$ | | 50 | 85 | μA | |
| I_{SC} | Short-circuit current | $V_S = 20\text{ V}, (V+) = 10\text{ V}, (V-) = -10\text{ V}, V_O = 0\text{ V}$ | | | ± 40 | ± 60 | mA |
| C_{LOAD} | Capacitive load drive | | | | 100 | | pF |

5.5 Electrical Characteristics - LM324B and LM324BA (continued)

For $V_S = (V+) - (V-) = 5\text{ V to }36\text{ V}$ ($\pm 2.5\text{ V to } \pm 18\text{ V}$), at $T_A = 25^\circ\text{C}$, $V_{CM} = V_{OUT} = V_S / 2$, and $R_L = 10\text{ k}\Omega$ connected to $V_S / 2$ (unless otherwise noted)

| PARAMETER | | TEST CONDITIONS | | MIN | TYP | MAX | UNIT |
|---------------------|---------------------------------|--|---|-----|-----|-----|---------------|
| R_O | Open-loop output impedance | $f = 1\text{ MHz}$, $I_O = 0\text{ A}$ | | | 300 | | Ω |
| POWER SUPPLY | | | | | | | |
| I_Q | Quiescent current per amplifier | $V_S = 5\text{ V}$; $I_O = 0\text{ A}$ | $T_A = -40^\circ\text{C to }85^\circ\text{C}$ | | 240 | 300 | μA |
| | | $V_S = 36\text{ V}$; $I_O = 0\text{ A}$ | $T_A = -40^\circ\text{C to }85^\circ\text{C}$ | | 350 | 750 | μA |

(1) Specified by design and characterization only.

5.6 Electrical Characteristics - LM2902B and LM2902BA

For $V_S = (V_+) - (V_-) = 5\text{ V to }36\text{ V}$ ($\pm 2.5\text{ V to } \pm 18\text{ V}$), at $T_A = 25^\circ\text{C}$, $V_{CM} = V_{OUT} = V_S / 2$, and $R_L = 10\text{ k}\Omega$ connected to $V_S / 2$ (unless otherwise noted)

| PARAMETER | | TEST CONDITIONS | | MIN | TYP | MAX | UNIT |
|----------------------------|--|---|---|--|--------------------|---------------|--------------------------------------|
| OFFSET VOLTAGE | | | | | | | |
| V_{OS} | Input offset voltage | LM2902B | | | ± 0.6 | ± 3.0 | mV |
| | | | $T_A = -40^\circ\text{C to }125^\circ\text{C}$ | | | ± 4.0 | |
| V_{OS} | Input offset voltage | LM2902BA | | | ± 0.3 | ± 2 | mV |
| | | | $T_A = -40^\circ\text{C to }125^\circ\text{C}$ | | | 2.5 | |
| dV_{OS}/dT | Input offset voltage drift | $R_S = 0\ \Omega$ | $T_A = -40^\circ\text{C to }125^\circ\text{C}$ | | ± 7 | | $\mu\text{V}/^\circ\text{C}$ |
| PSRR | Input offset voltage versus power supply | | | 65 | 100 | | dB |
| | Channel separation | $f = 1\text{ kHz to }20\text{ kHz}$ | | | 120 | | dB |
| INPUT VOLTAGE RANGE | | | | | | | |
| V_{CM} | Common-mode voltage range | $V_S = 3\text{ V to }36\text{ V}$ | | V_- | | $(V_+) - 1.5$ | V |
| | | $V_S = 5\text{ V to }36\text{ V}$ | | $T_A = -40^\circ\text{C to }125^\circ\text{C}$ | V_- | | |
| CMRR | Common-mode rejection ratio | $(V_-) \leq V_{CM} \leq (V_+) - 1.5\text{ V}$ | $V_S = 3\text{ V to }36\text{ V}$ | | 70 | 80 | dB |
| | | $(V_-) \leq V_{CM} \leq (V_+) - 2\text{ V}$ | $V_S = 5\text{ V to }36\text{ V}$ | $T_A = -40^\circ\text{C to }125^\circ\text{C}$ | 65 | 80 | |
| INPUT BIAS CURRENT | | | | | | | |
| I_B | Input bias current | | | | -10 | -35 | nA |
| | | | | $T_A = -40^\circ\text{C to }125^\circ\text{C}$ | | | |
| dI_{OS}/dT | Input offset current drift | | | | 10 | | $\text{pA}/^\circ\text{C}$ |
| I_{OS} | Input offset current | | | | ± 0.5 | ± 4 | nA |
| | | | | $T_A = -40^\circ\text{C to }125^\circ\text{C}$ | | | |
| dI_{OS}/dT | Input offset current drift | | | | 10 | | $\text{pA}/^\circ\text{C}$ |
| NOISE | | | | | | | |
| E_N | Input voltage noise | $f = 0.1\text{ to }10\text{ Hz}$ | | | 3 | | μV_{PP} |
| e_N | Input voltage noise density | $R_S = 100\ \Omega, V_I = 0\text{ V}, f = 1\text{ kHz}$ (see Figure 7-2 for test circuit) | | | 35 | | $\text{nV}/\sqrt{\text{Hz}}$ |
| INPUT CAPACITANCE | | | | | | | |
| Z_{ID} | Differential | | | | $10 \parallel 0.1$ | | $\text{M}\Omega \parallel \text{pF}$ |
| Z_{ICM} | Common-mode | | | | $4 \parallel 1.5$ | | $\text{G}\Omega \parallel \text{pF}$ |
| OPEN-LOOP GAIN | | | | | | | |
| A_{OL} | Open-loop voltage gain | $V_S = 15\text{ V}, V_O = 1\text{ V to }11\text{ V}, R_L \geq 10\text{ k}\Omega$, connected to (V_-) | | | 50 | 100 | V/mV |
| | | | | $T_A = -40^\circ\text{C to }125^\circ\text{C}$ | 25 | | |
| FREQUENCY RESPONSE | | | | | | | |
| GBW | Gain-bandwidth product | $R_L = 1\text{ M}\Omega, C_L = 20\text{ pF}$ (see Figure 7-1 for test circuit) | | | 1.2 | | MHz |
| SR | Slew rate | $R_L = 1\text{ M}\Omega, C_L = 30\text{ pF}, V_I = \pm 10\text{ V}$ (see Figure 7-1 for test circuit) | | | 0.5 | | $\text{V}/\mu\text{s}$ |
| θ_m | Phase margin | $G = +1, R_L = 10\text{ k}\Omega, C_L = 20\text{ pF}$ | | | 56 | | $^\circ$ |
| t_s | Settling time | To 0.1%, $V_S = 5\text{ V}, 2\text{-V Step}, G = +1, C_L = 100\text{ pF}$ | | | 4 | | μs |
| | Overload recovery time | $V_{IN} \times \text{gain} > V_S$ | | | 10 | | μs |
| THD+N | Total harmonic distortion + noise | $G = +1, f = 1\text{ kHz}, V_O = 3.53\text{ }V_{RMS}, V_S = 36\text{ V}, R_L = 100\text{ k}\Omega, I_{OUT} \leq 50\ \mu\text{A}, \text{BW} = 80\text{ kHz}$ | | | 0.001% | | |
| OUTPUT | | | | | | | |
| V_O | Voltage output swing from rail | Positive Rail (V_+) | | $I_{OUT} = -50\ \mu\text{A}$ | 1.35 | 1.5 | V |
| V_O | | | | $I_{OUT} = -1\text{ mA}$ | 1.4 | 1.6 | V |
| V_O | | | | $I_{OUT} = -5\text{ mA}$ | 1.5 | 1.75 | V |
| V_O | | Negative Rail (V_-) | | $I_{OUT} = 50\ \mu\text{A}$ | 100 | 150 | mV |
| V_O | | | | $I_{OUT} = 1\text{ mA}$ | 0.75 | 1 | V |
| V_O | | | $V_S = 5\text{ V}, R_L \leq 10\text{ k}\Omega$ connected to (V_-) | $T_A = -40^\circ\text{C to }125^\circ\text{C}$ | 5 | 20 | mV |
| I_O | Output current | $V_S = 15\text{ V}; V_O = V_-; V_{ID} = 1\text{ V}$ | Source | | -20 ⁽¹⁾ | -30 | mA |
| | | | | $T_A = -40^\circ\text{C to }125^\circ\text{C}$ | -10 ⁽¹⁾ | | mA |
| | | $V_S = 15\text{ V}; V_O = V_+; V_{ID} = -1\text{ V}$ | Sink | | 10 ⁽¹⁾ | 20 | mA |
| | | | | $T_A = -40^\circ\text{C to }125^\circ\text{C}$ | 5 ⁽¹⁾ | | mA |
| | | $V_{ID} = -1\text{ V}; V_O = (V_-) + 200\text{ mV}$ | | 50 | 85 | μA | |
| I_{SC} | Short-circuit current | $V_S = 20\text{ V}, (V_+) = 10\text{ V}, (V_-) = -10\text{ V}, V_O = 0\text{ V}$ | | | ± 40 | ± 60 | mA |
| C_{LOAD} | Capacitive load drive | | | | 100 | | pF |

5.6 Electrical Characteristics - LM2902B and LM2902BA (continued)

For $V_S = (V+) - (V-) = 5\text{ V to }36\text{ V}$ ($\pm 2.5\text{ V to } \pm 18\text{ V}$), at $T_A = 25^\circ\text{C}$, $V_{CM} = V_{OUT} = V_S / 2$, and $R_L = 10\text{ k}\Omega$ connected to $V_S / 2$ (unless otherwise noted)

| PARAMETER | | TEST CONDITIONS | | MIN | TYP | MAX | UNIT |
|---------------------|---------------------------------|--|---|-----|-----|-----|---------------|
| R_O | Open-loop output impedance | $f = 1\text{ MHz}$, $I_O = 0\text{ A}$ | | | 300 | | Ω |
| POWER SUPPLY | | | | | | | |
| I_Q | Quiescent current per amplifier | $V_S = 5\text{ V}$; $I_O = 0\text{ A}$ | $T_A = -40^\circ\text{C to } 125^\circ\text{C}$ | | 240 | 300 | μA |
| | | $V_S = 36\text{ V}$; $I_O = 0\text{ A}$ | $T_A = -40^\circ\text{C to } 125^\circ\text{C}$ | | | 750 | μA |

(1) Specified by design and characterization only.

5.7 Electrical Characteristics for LM324, LM324K, LM224, LM224K, and LM124

at specified free-air temperature, $V_{CC} = 5\text{ V}$ (unless otherwise noted)

| PARAMETER | TEST CONDITIONS ⁽¹⁾ | | T_A ⁽²⁾ | LM124, LM224, LM224K | | | LM324, LM324K | | | UNIT |
|--|--|------------------------------|----------------------|----------------------|--------------------|-----|---------------------|--------------------|-----|---------------|
| | | | | MIN | TYP ⁽³⁾ | MAX | MIN | TYP ⁽³⁾ | MAX | |
| V_{IO} Input offset voltage | $V_{CC} = 5\text{ V to MAX}, V_{IC} = V_{ICRmin}, V_O = 1.4\text{ V}$ | | 25°C | 3 5 | | | 3 7 | | | mV |
| | | | Full range | 7 | | | 9 | | | |
| I_{IO} Input offset current | $V_O = 1.4\text{ V}$ | | 25°C | 2 30 | | | 2 50 | | | nA |
| | | | Full range | 100 | | | 150 | | | |
| I_{IB} Input bias current | $V_O = 1.4\text{ V}$ | | 25°C | -20 -150 | | | -20 -250 | | | nA |
| | | | Full range | -300 | | | -500 | | | |
| V_{ICR} Common-mode input voltage range | $V_{CC} = 5\text{ V to MAX}$ | | 25°C | 0 to $V_{CC} - 1.5$ | | | 0 to $V_{CC} - 1.5$ | | | V |
| | | | Full range | 0 to $V_{CC} - 2$ | | | 0 to $V_{CC} - 2$ | | | |
| V_{OH} High-level output voltage | $R_L = 2\text{ k}\Omega$ | | 25°C | $V_{CC} - 1.5$ | | | $V_{CC} - 1.5$ | | | V |
| | $V_{CC} = \text{MAX}$ | $R_L = 2\text{ k}\Omega$ | Full range | 26 | | | 26 | | | |
| | | $R_L \geq 10\text{ k}\Omega$ | Full range | 27 28 | | | 27 28 | | | |
| V_{OL} Low-level output voltage | $R_L \leq 10\text{ k}\Omega$ | | Full range | 5 20 | | | 5 20 | | | mV |
| A_{VD} Large-signal differential voltage amplification | $V_{CC+} = 15\text{ V}, V_O = 1\text{ V to } 11\text{ V}, R_L \geq 2\text{ k}\Omega$ | | 25°C | 50 100 | | | 25 100 | | | V/mV |
| | | | Full range | 25 | | | 15 | | | |
| CMRR Common-mode rejection ratio | $V_{IC} = V_{ICRmin}$ | | 25°C | 70 80 | | | 65 80 | | | dB |
| k_{SVR} Supply-voltage rejection ratio ($\Delta V_{CC}/\Delta V_{IO}$) | | | 25°C | 65 100 | | | 65 100 | | | dB |
| V_{O1}/V_{O2} Crosstalk attenuation | $f = 1\text{ kHz to } 20\text{ kHz}$ | | 25°C | 120 | | | 120 | | | dB |
| I_O Output current | $V_{CC} = 15\text{ V}, V_{ID} = 1\text{ V}, V_O = 0$ | Source | 25°C | -20 -30 -60 | | | -20 -30 -60 | | | mA |
| | | | Full range | -10 | | | -10 | | | |
| | $V_{CC} = 15\text{ V}, V_{ID} = -1\text{ V}, V_O = 15\text{ V}$ | Sink | 25°C | 10 20 | | | 10 20 | | | |
| | | | Full range | 5 | | | 5 | | | |
| | $V_{ID} = -1\text{ V}, V_O = 200\text{ mV}$ | | 25°C | 12 30 | | | 12 30 | | | μA |
| I_{OS} Short-circuit output current | V_{CC} at 5 V, $V_O = 0$, V_{CC} at -5 V | | 25°C | $\pm 40 \pm 60$ | | | $\pm 40 \pm 60$ | | | mA |
| I_{CC} Supply current (four amplifiers) | $V_O = 2.5\text{ V}, \text{ no load}$ | | Full range | 0.7 1.2 | | | 0.7 1.2 | | | mA |
| | $V_{CC} = \text{MAX}, V_O = 0.5 V_{CC}, \text{ no load}$ | | Full range | 1.4 3 | | | 1.4 3 | | | |

- (1) All characteristics are measured under open-loop conditions, with zero common-mode input voltage, unless otherwise specified. MAX V_{CC} for testing purposes is 26 V for LM2902 and 30 V for the others.
- (2) Full range is -55°C to $+125^\circ\text{C}$ for LM124, -25°C to $+85^\circ\text{C}$ for LM224, and 0°C to 70°C for LM324.
- (3) All typical values are at $T_A = 25^\circ\text{C}$.

5.8 Electrical Characteristics for LM2902, LM2902K, LM2902KV and LM2902KAV

at specified free-air temperature, $V_{CC} = 5\text{ V}$ (unless otherwise noted)

| PARAMETER | TEST CONDITIONS ⁽¹⁾ | | T_A ⁽²⁾ | LM2902, LM2902K | | | LM2902KV, LM2902KAV | | | UNIT | | |
|--|--|------------------------------|----------------------|---------------------|--------------------|----------|---------------------|--------------------|------------------------------|---------------|-----|----|
| | | | | MIN | TYP ⁽³⁾ | MAX | MIN | TYP ⁽³⁾ | MAX | | | |
| V_{IO} Input offset voltage | $V_{CC} = 5\text{ V to MAX}$, $V_{IC} = V_{ICRmin}$, $V_O = 1.4\text{ V}$ | Non-A-suffix devices | 25°C | 3 | | 7 | 3 | | 7 | mV | | |
| | | | Full range | 10 | | | 10 | | | | | |
| | | A-suffix devices | 25°C | | | | 1 | | 2 | | | |
| | | | Full range | | | | 4 | | | | | |
| $\Delta V_{IO}/\Delta T$ Input offset voltage temperature drift | $R_S = 0\ \Omega$ | | Full range | | | | 7 | | $\mu\text{V}/^\circ\text{C}$ | | | |
| I_{IO} Input offset current | $V_O = 1.4\text{ V}$ | | 25°C | 2 | | 50 | 2 | | 50 | nA | | |
| | | | Full range | 300 | | | 150 | | | | | |
| $\Delta I_{IO}/\Delta T$ Input offset voltage temperature drift | | | Full range | | | | 10 | | $\text{pA}/^\circ\text{C}$ | | | |
| I_{IB} Input bias current | $V_O = 1.4\text{ V}$ | | 25°C | -20 | | -250 | -20 | | -250 | nA | | |
| | | | Full range | -500 | | | -500 | | | | | |
| V_{ICR} Common-mode input voltage range | $V_{CC} = 5\text{ V to MAX}$ | | 25°C | 0 to $V_{CC} - 1.5$ | | | 0 to $V_{CC} - 1.5$ | | | V | | |
| | | | Full range | 0 to $V_{CC} - 2$ | | | 0 to $V_{CC} - 2$ | | | | | |
| V_{OH} High-level output voltage | $R_L = 10\text{ k}\Omega$ | | 25°C | $V_{CC} - 1.5$ | | | $V_{CC} - 1.5$ | | | V | | |
| | $V_{CC} = \text{MAX}$ | $R_L = 2\text{ k}\Omega$ | Full range | 22 | | | 26 | | | | | |
| | | $R_L \geq 10\text{ k}\Omega$ | Full range | 23 | | 24 | 27 | | | | | |
| V_{OL} Low-level output voltage | $R_L \leq 10\text{ k}\Omega$ | | Full range | 5 | | 20 | 5 | | 20 | mV | | |
| A_{VD} Large-signal differential voltage amplification | $V_{CC} = 15\text{ V}$, $V_O = 1\text{ V to }11\text{ V}$, $R_L \geq 2\text{ k}\Omega$ | | 25°C | 25 | | 100 | 25 | | 100 | V/mV | | |
| | | | Full range | 15 | | | 15 | | | | | |
| CMRR Common-mode rejection ratio | $V_{IC} = V_{ICRmin}$ | | 25°C | 50 | | 80 | 60 | | 80 | dB | | |
| k_{SVR} Supply-voltage rejection ratio ($\Delta V_{CC}/\Delta V_{IO}$) | | | 25°C | 50 | | 100 | 60 | | 100 | dB | | |
| V_{O1}/V_{O2} Crosstalk attenuation | $f = 1\text{ kHz to }20\text{ kHz}$ | | 25°C | 120 | | | 120 | | | dB | | |
| I_O Output current | $V_{CC} = 15\text{ V}$, $V_{ID} = 1\text{ V}$, $V_O = 0$ | Source | 25°C | -20 | | -30 | -60 | -20 | | -30 | -60 | mA |
| | | | Full range | -10 | | | -10 | | | | | |
| | $V_{CC} = 15\text{ V}$, $V_{ID} = -1\text{ V}$, $V_O = 15\text{ V}$ | Sink | 25°C | 10 | | 20 | 10 | | 20 | | | |
| | | | Full range | 5 | | | 5 | | | | | |
| | $V_{ID} = -1\text{ V}$, $V_O = 200\text{ mV}$ | | 25°C | 30 | | | 12 | | 40 | μA | | |
| I_{OS} Short-circuit output current | V_{CC} at 5 V, $V_O = 0$, V_{CC} at -5 V | | 25°C | ± 40 | | ± 60 | ± 40 | | ± 60 | mA | | |
| I_{CC} Supply current (four amplifiers) | $V_O = 2.5\text{ V}$, no load | | Full range | 0.7 | | 1.2 | 0.7 | | 1.2 | mA | | |
| | $V_{CC} = \text{MAX}$, $V_O = 0.5 V_{CC}$, no load | | Full range | 1.4 | | 3 | 1.4 | | 3 | | | |

- (1) All characteristics are measured under open-loop conditions, with zero common-mode input voltage, unless otherwise specified. MAX V_{CC} for testing purposes is 26 V for LM2902 and 32 V for LM2902V.
- (2) Full range is -40°C to $+125^\circ\text{C}$ for LM2902.
- (3) All typical values are at $T_A = 25^\circ\text{C}$.

5.9 Electrical Characteristics for LM324A, LM324KA, LM224A, LM224KA, and LM124A

at specified free-air temperature, $V_{CC} = 5\text{ V}$ (unless otherwise noted)

| PARAMETER | TEST CONDITIONS ⁽¹⁾ | T_A ⁽²⁾ | LM124A | | | LM224A, LM224KA | | | LM324A, LM324KA | | | UNIT | |
|--|--|----------------------|---------------------|--------------------|----------|---------------------|--------------------|----------|---------------------|--------------------|----------|---------------|----|
| | | | MIN | TYP ⁽³⁾ | MAX | MIN | TYP ⁽³⁾ | MAX | MIN | TYP ⁽³⁾ | MAX | | |
| V_{IO} Input offset voltage | $V_{CC} = 5\text{ V to }30\text{ V}$, $V_{IC} = V_{ICRmin}$, $V_O = 1.4\text{ V}$ | 25°C | | | 2 | | 2 | 3 | | 2 | 3 | mV | |
| | | Full range | | | 4 | | | 4 | | | 5 | | |
| I_{IO} Input offset current | $V_O = 1.4\text{ V}$ | 25°C | | | 10 | | 2 | 15 | | 2 | 30 | nA | |
| | | Full range | | | 30 | | | 30 | | | 75 | | |
| I_{IB} Input bias current | $V_O = 1.4\text{ V}$ | 25°C | | | -50 | | -15 | -80 | | -15 | -100 | nA | |
| | | Full range | | | -100 | | | -100 | | | -200 | | |
| V_{ICR} Common-mode input voltage range | $V_{CC} = 30\text{ V}$ | 25°C | 0 to $V_{CC} - 1.5$ | | | 0 to $V_{CC} - 1.5$ | | | 0 to $V_{CC} - 1.5$ | | | V | |
| | | Full range | 0 to $V_{CC} - 2$ | | | 0 to $V_{CC} - 2$ | | | 0 to $V_{CC} - 2$ | | | | |
| V_{OH} High-level output voltage | $R_L = 2\text{ k}\Omega$ $V_{CC} = 30\text{ V}$ | 25°C | $V_{CC} - 1.5$ | | | $V_{CC} - 1.5$ | | | $V_{CC} - 1.5$ | | | V | |
| | | Full range | 26 | | | 26 | | | 26 | | | | |
| | | Full range | 27 | | | 27 | 28 | | 27 | 28 | | | |
| V_{OL} Low-level output voltage | $R_L \leq 10\text{ k}\Omega$ | Full range | | | 20 | | 5 | 20 | | 5 | 20 | mV | |
| A_{VD} Large-signal differential voltage amplification | $V_{CC} = 15\text{ V}$, $V_O = 1\text{ V to }11\text{ V}$, $R_L \geq 2\text{ k}\Omega$ | 25°C | 50 | 100 | | 50 | 100 | | 25 | 100 | | V/mV | |
| | | Full range | 25 | | | 25 | | | 15 | | | | |
| CMRR Common-mode rejection ratio | $V_{IC} = V_{ICRmin}$ | 25°C | 70 | | | 70 | 80 | | 65 | 80 | | dB | |
| k_{SVR} Supply-voltage rejection ratio ($\Delta V_{CC} / \Delta V_{IO}$) | | 25°C | 65 | | | 65 | 100 | | 65 | 100 | | dB | |
| V_{O1} / V_{O2} Crosstalk attenuation | $f = 1\text{ kHz to }20\text{ kHz}$ | 25°C | | 120 | | | 120 | | | 120 | | dB | |
| I_O Output current | $V_{CC} = 15\text{ V}$, $V_{ID} = 1\text{ V}$, $V_O = 0$ | Source | 25°C | -20 | | | -20 | -30 | -60 | -20 | -30 | -60 | mA |
| | | | Full range | -10 | | | -10 | | | -10 | | | |
| | $V_{CC} = 15\text{ V}$, $V_{ID} = -1\text{ V}$, $V_O = 15\text{ V}$ | Sink | 25°C | 10 | | | 10 | 20 | | 1 | 20 | | |
| | | | Full range | 5 | | | 5 | | | 5 | | | |
| | $V_{ID} = -1\text{ V}$, $V_O = 200\text{ mV}$ | 25°C | 12 | | | 12 | 30 | | 12 | 30 | | μA | |
| I_{OS} Short-circuit output current | V_{CC} at 5 V, V_{CC} at -5 V, $V_O = 0$ | 25°C | | ± 40 | ± 60 | | ± 40 | ± 60 | | ± 40 | ± 60 | mA | |
| I_{CC} Supply current (four amplifiers) | $V_O = 2.5\text{ V}$, no load | Full range | | 0.7 | 1.2 | | 0.7 | 1.2 | | 0.7 | 1.2 | mA | |
| | $V_{CC} = 30\text{ V}$, $V_O = 15\text{ V}$, no load | Full range | | 1.4 | 3. | | 1.4 | 3. | | 1.4 | 3. | | |

- (1) All characteristics are measured under open-loop conditions, with zero common-mode input voltage, unless otherwise specified.
(2) Full range is -55°C to $+125^\circ\text{C}$ for LM124A, -25°C to $+85^\circ\text{C}$ for LM224A, and 0°C to 70°C for LM324A.
(3) All typical values are at $T_A = 25^\circ\text{C}$.

5.10 Operating Conditions

$V_{CC} = \pm 15\text{ V}$, $T_A = 25^\circ\text{C}$

| PARAMETER | TEST CONDITIONS | TYP | UNIT |
|--------------------------------------|--|-----|------------------------------|
| SR Slew rate at unity gain | $R_L = 1\text{ M}\Omega$, $C_L = 30\text{ pF}$, $V_I = \pm 10\text{ V}$ (see Figure 6-1) | 0.5 | $\text{V}/\mu\text{s}$ |
| B_1 Unity-gain bandwidth | $R_L = 1\text{ M}\Omega$, $C_L = 20\text{ pF}$ (see Figure 6-1) | 1.2 | MHz |
| V_n Equivalent input noise voltage | $R_S = 100\ \Omega$, $V_I = 0\text{ V}$, $f = 1\text{ kHz}$ (see Figure 6-2) | 35 | $\text{nV}/\sqrt{\text{Hz}}$ |

5.11 Typical Characteristics

This typical characteristics section is applicable for LM324B and LM2902B. Typical characteristics data in this section was taken with $T_A = 25^\circ\text{C}$, $V_S = 36\text{ V}$ ($\pm 18\text{ V}$), $V_{CM} = V_S / 2$, $R_{LOAD} = 10\text{ k}\Omega$ connected to $V_S / 2$ (unless otherwise noted).

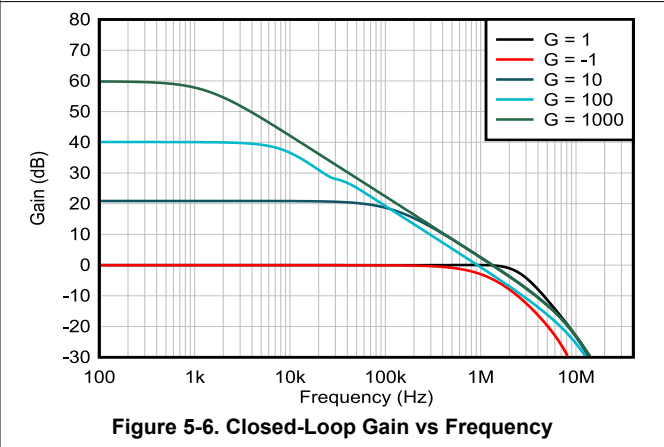
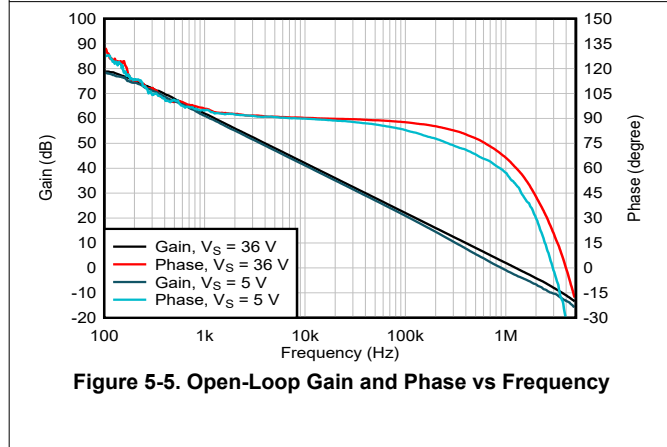
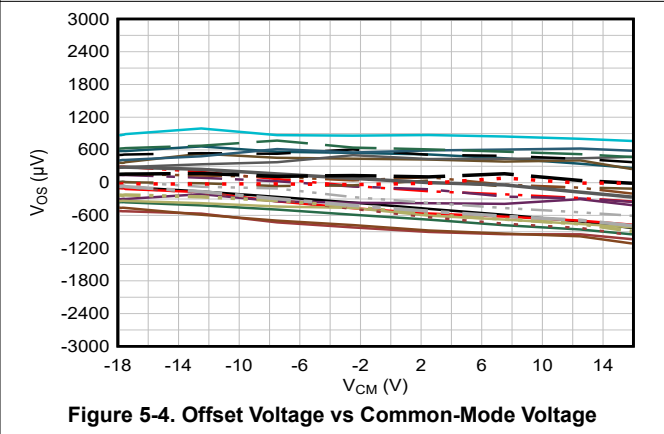
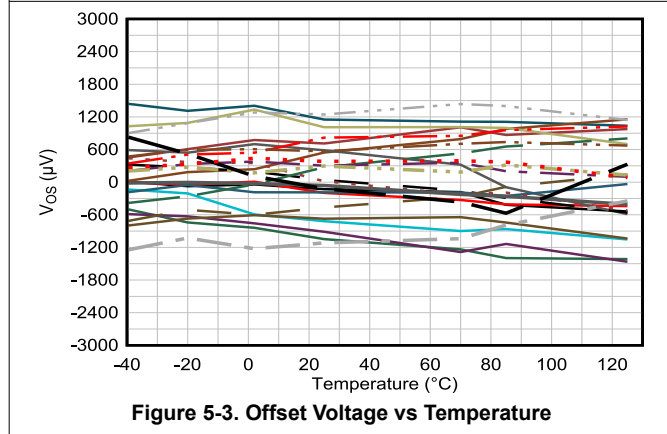
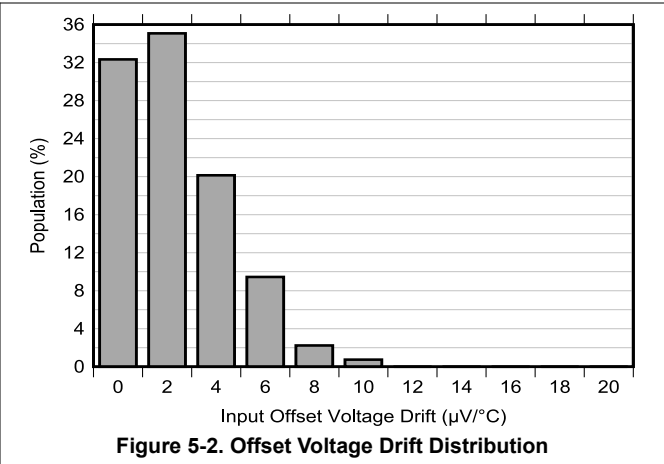
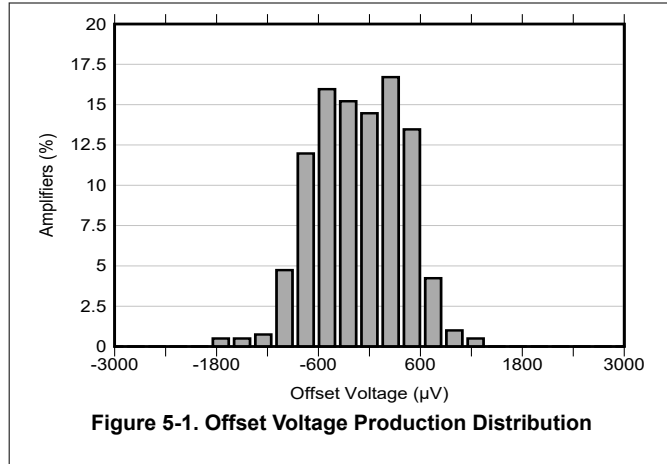

5.11 Typical Characteristics (continued)

This typical characteristics section is applicable for LM324B and LM2902B. Typical characteristics data in this section was taken with $T_A = 25^\circ\text{C}$, $V_S = 36\text{ V}$ ($\pm 18\text{ V}$), $V_{CM} = V_S / 2$, $R_{LOAD} = 10\text{ k}\Omega$ connected to $V_S / 2$ (unless otherwise noted).

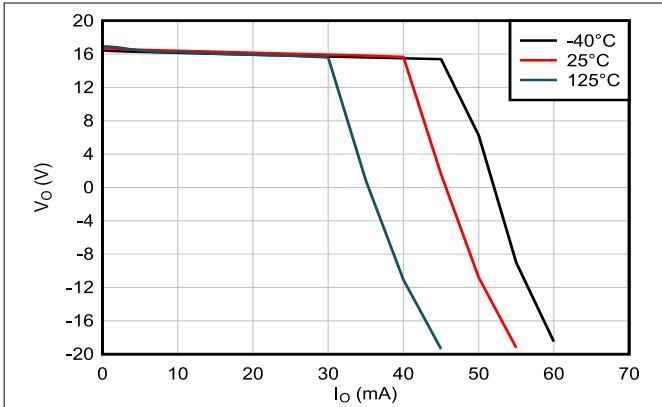

Figure 5-7. Output Voltage Swing vs Output Current (Sourcing)

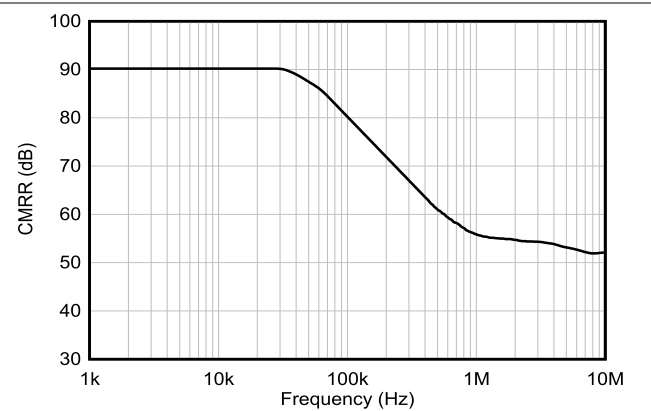

Figure 5-8. CMRR vs Frequency

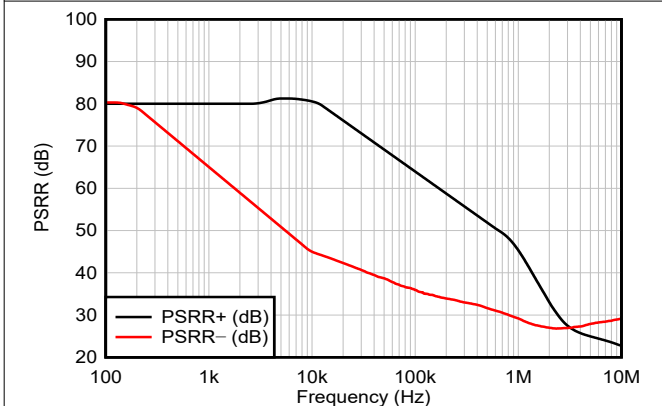

Figure 5-9. PSRR vs Frequency

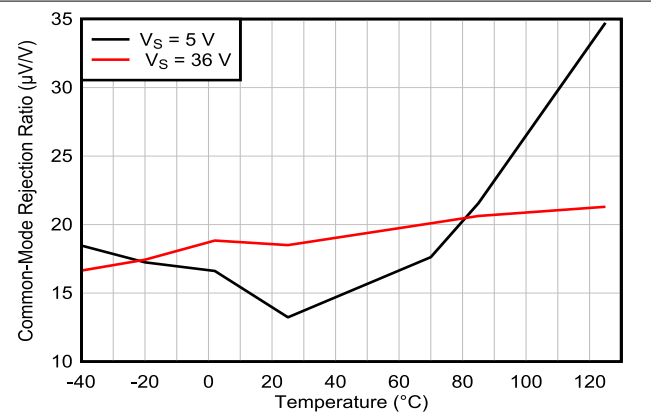

Figure 5-10. Common-Mode Rejection Ratio vs Temperature

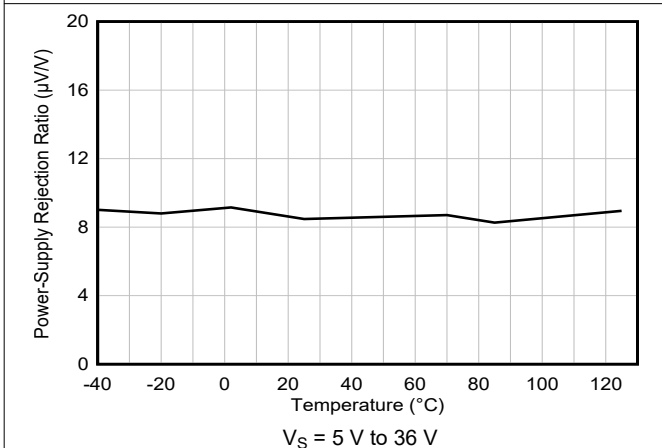

Figure 5-11. Power Supply Rejection Ratio vs Temperature

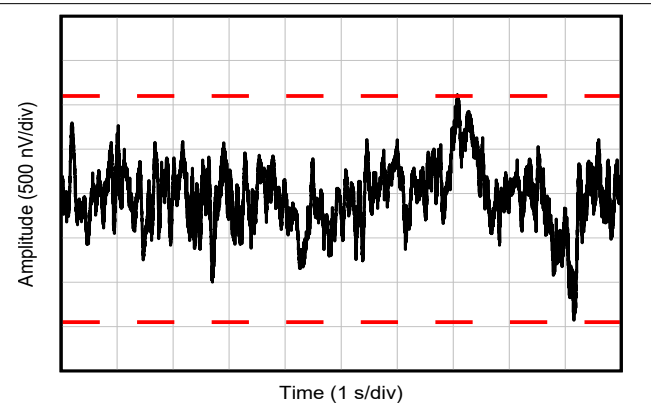

Figure 5-12. 0.1-Hz to 10-Hz Noise

5.11 Typical Characteristics (continued)

This typical characteristics section is applicable for LM324B and LM2902B. Typical characteristics data in this section was taken with $T_A = 25^\circ\text{C}$, $V_S = 36\text{ V}$ ($\pm 18\text{ V}$), $V_{CM} = V_S / 2$, $R_{LOAD} = 10\text{ k}\Omega$ connected to $V_S / 2$ (unless otherwise noted).

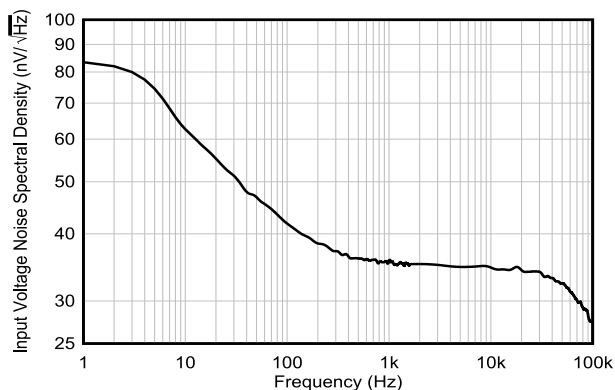
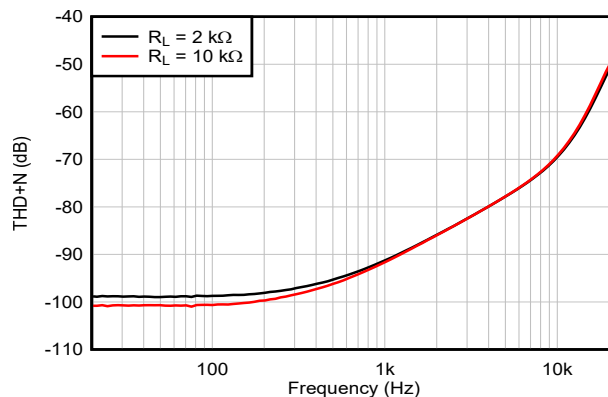
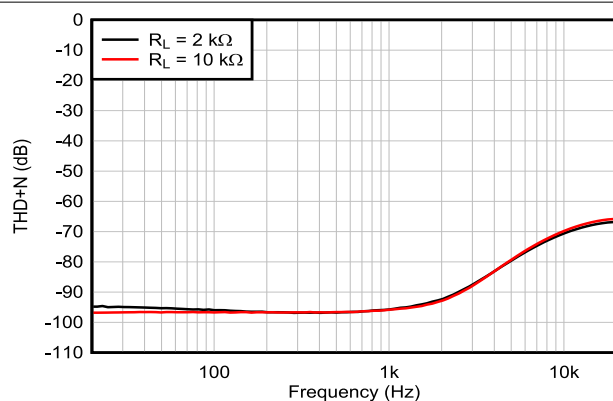

Figure 5-13. Input Voltage Noise Spectral Density vs Frequency



$G = 1$, $f = 1\text{ kHz}$, $BW = 80\text{ kHz}$,
 $V_{OUT} = 10\text{ V}_{PP}$, R_L connected to V_-

Figure 5-14. THD+N Ratio vs Frequency, $G = 1$



$G = -1$, $f = 1\text{ kHz}$, $BW = 80\text{ kHz}$,
 $V_{OUT} = 10\text{ V}_{PP}$, R_L connected to V_-
 See [Section 6](#)

Figure 5-15. THD+N Ratio vs Frequency, $G = -1$

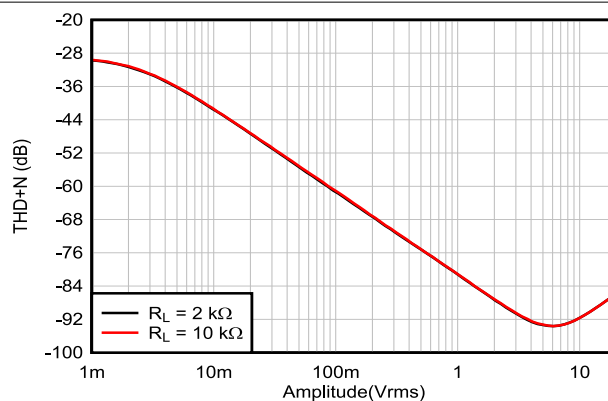

$G = 1$, $f = 1\text{ kHz}$, $BW = 80\text{ kHz}$,
 R_L connected to V_-

Figure 5-16. THD+N vs Output Amplitude, $G = 1$

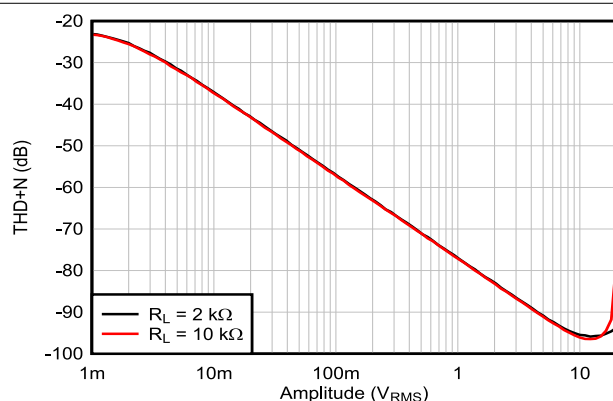

$G = -1$, $f = 1\text{ kHz}$, $BW = 80\text{ kHz}$,
 R_L connected to V_-
 See [Section 6](#)

Figure 5-17. THD+N vs Output Amplitude, $G = -1$

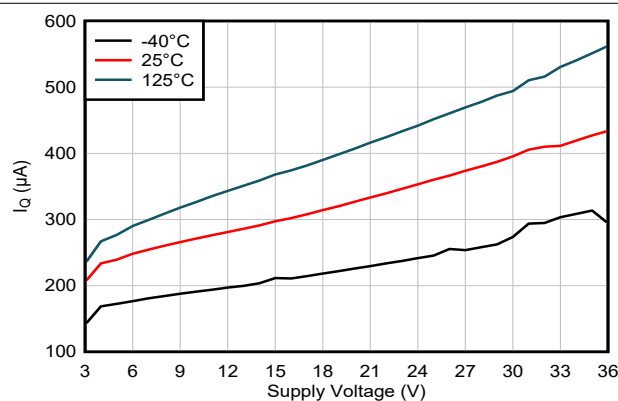

Figure 5-18. Quiescent Current vs Supply Voltage

5.11 Typical Characteristics (continued)

This typical characteristics section is applicable for LM324B and LM2902B. Typical characteristics data in this section was taken with $T_A = 25^\circ\text{C}$, $V_S = 36\text{ V}$ ($\pm 18\text{ V}$), $V_{CM} = V_S / 2$, $R_{LOAD} = 10\text{ k}\Omega$ connected to $V_S / 2$ (unless otherwise noted).

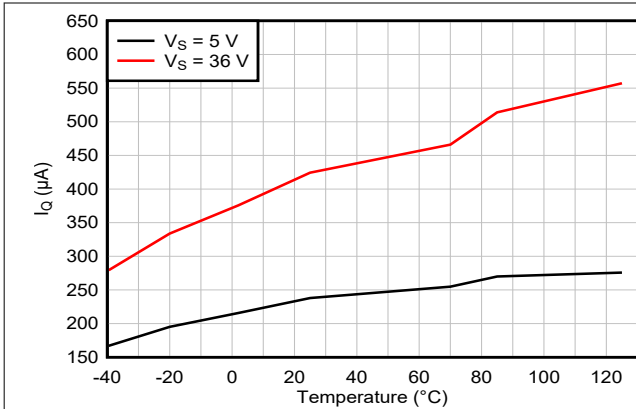

Figure 5-19. Quiescent Current vs Temperature

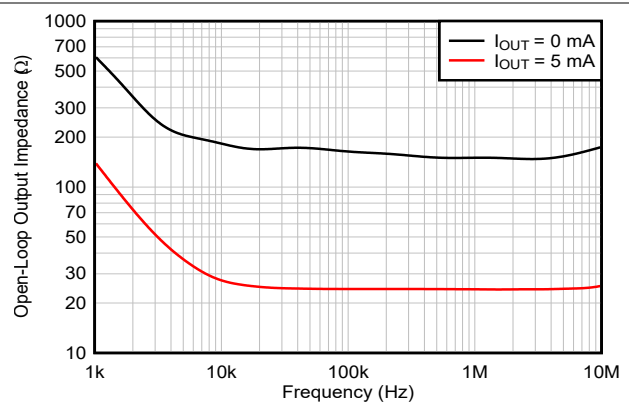
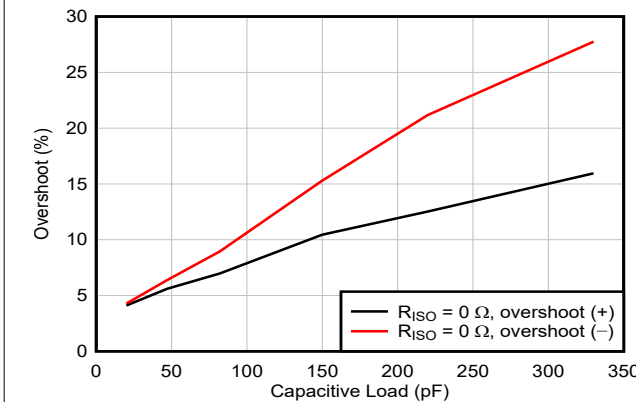
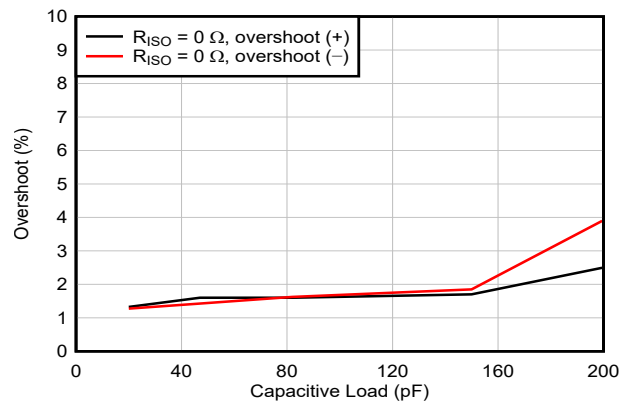

Figure 5-20. Open-Loop Output Impedance vs Frequency



$G = 1$, 100-mV output step, $R_L = \text{open}$

Figure 5-21. Small-Signal Overshoot vs Capacitive Load



$G = -1$, 100-mV output step, $R_L = \text{open}$

Figure 5-22. Small-Signal Overshoot vs Capacitive Load

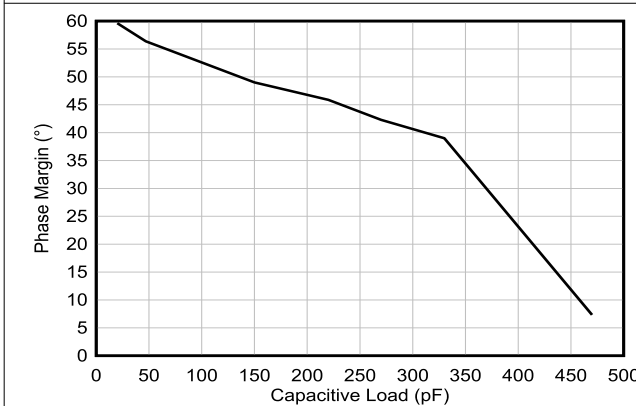

$G = +1$, $R_L = 10\text{ k}\Omega$, $C_L = 20\text{ pF}$

Figure 5-23. Phase Margin vs Capacitive Load

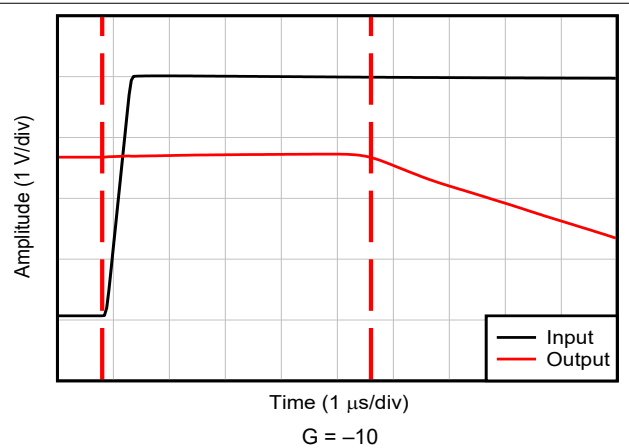

$G = -10$

Figure 5-24. Overload Recovery (Positive Rail)

5.11 Typical Characteristics (continued)

This typical characteristics section is applicable for LM324B and LM2902B. Typical characteristics data in this section was taken with $T_A = 25^\circ\text{C}$, $V_S = 36\text{ V}$ ($\pm 18\text{ V}$), $V_{CM} = V_S / 2$, $R_{LOAD} = 10\text{ k}\Omega$ connected to $V_S / 2$ (unless otherwise noted).

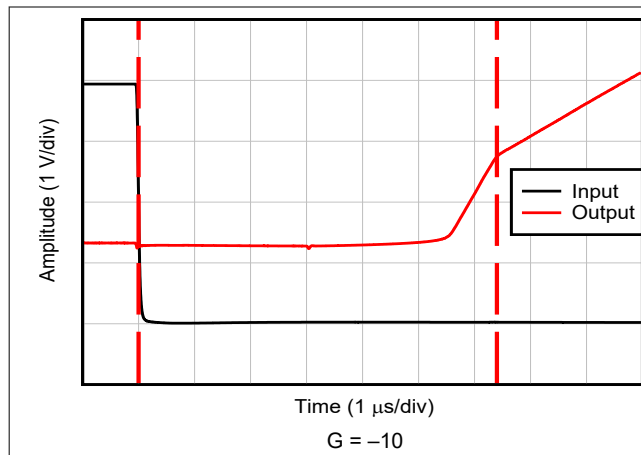

Figure 5-25. Overload Recovery (Negative Rail)

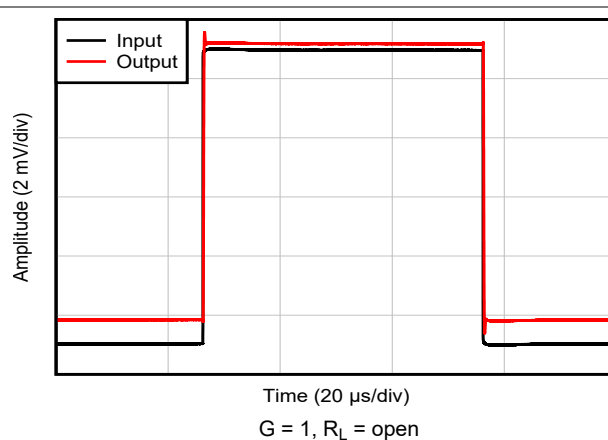

Figure 5-26. Small-Signal Step Response, $G = 1$

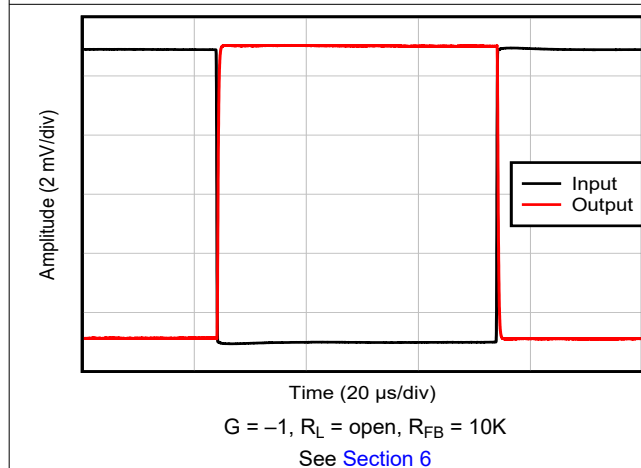

Figure 5-27. Small-Signal Step Response, $G = -1$

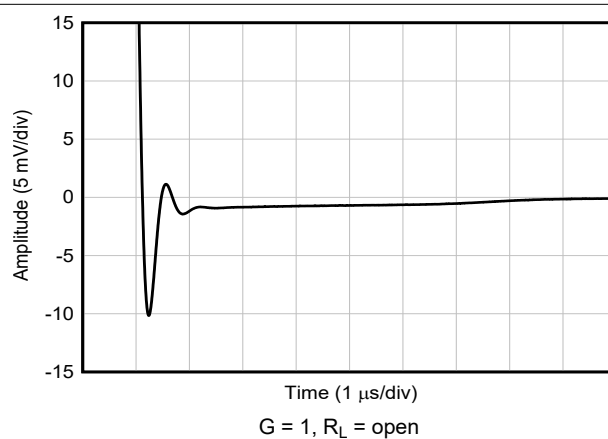

Figure 5-28. Large-Signal Step Response (Falling)

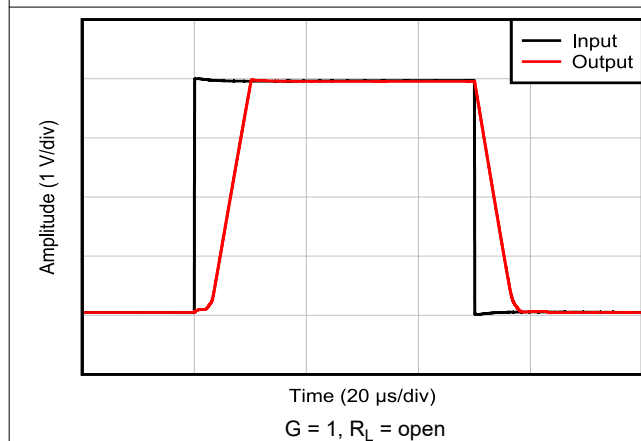

Figure 5-29. Large-Signal Step Response, $G = 1$

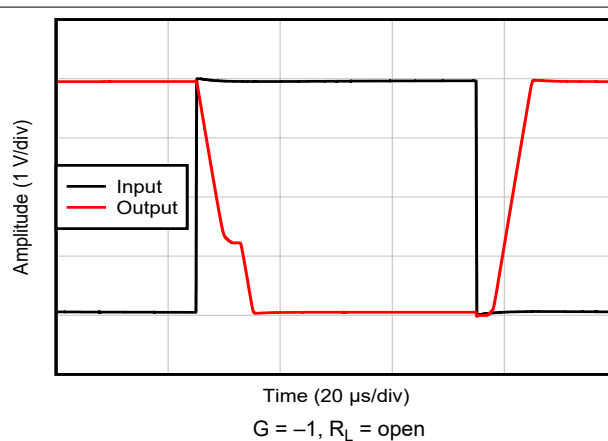

Figure 5-30. Large-Signal Step Response, $G = -1$

5.11 Typical Characteristics (continued)

This typical characteristics section is applicable for LM324B and LM2902B. Typical characteristics data in this section was taken with $T_A = 25^\circ\text{C}$, $V_S = 36\text{ V}$ ($\pm 18\text{ V}$), $V_{CM} = V_S / 2$, $R_{LOAD} = 10\text{ k}\Omega$ connected to $V_S / 2$ (unless otherwise noted).

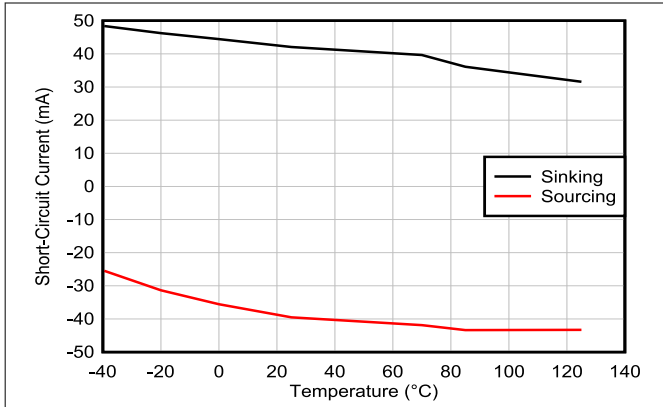

Figure 5-31. Short-Circuit Current vs Temperature

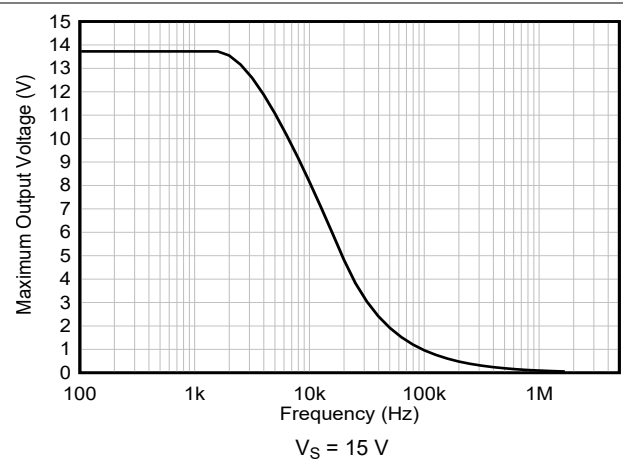

Figure 5-32. Maximum Output Voltage vs Frequency

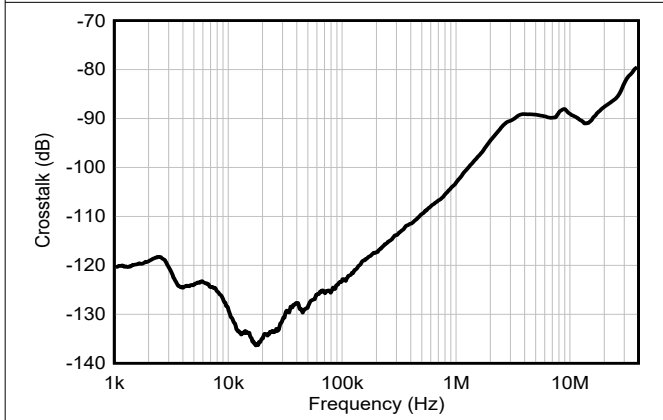

Figure 5-33. Channel Separation vs Frequency

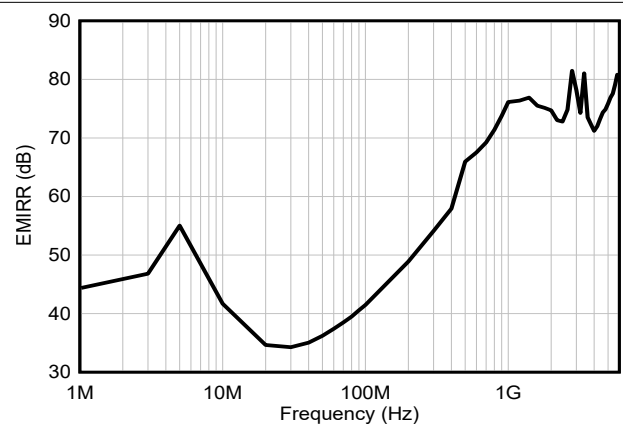

Figure 5-34. EMIRR (Electromagnetic Interference Rejection Ratio) vs Frequency

5.12 Typical Characteristics: All Devices Except B and BA Versions

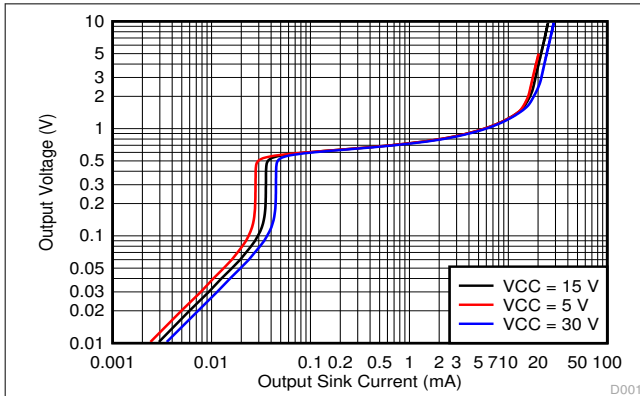

Figure 5-35. Output Sinking Characteristics

D001

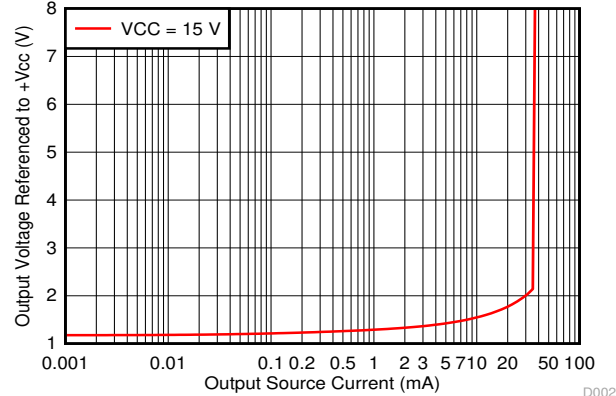

Figure 5-36. Output Sourcing Characteristics

D002

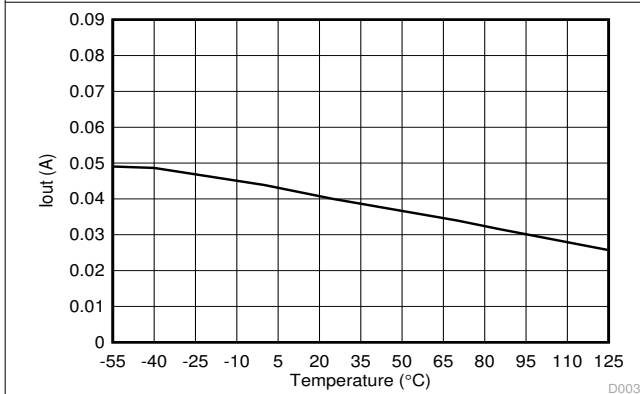

Figure 5-37. Source Current Limiting

D003

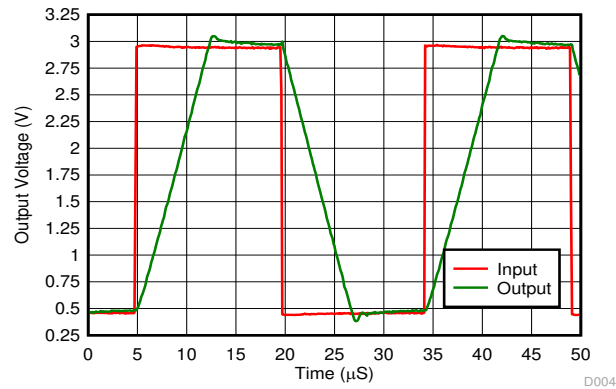

Figure 5-38. Voltage Follower Large Signal Response (50 pF)

D004

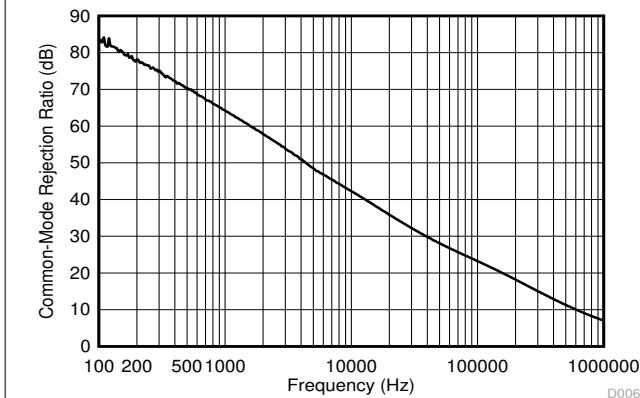

Figure 5-39. Common-Mode Rejection Ratio

D006

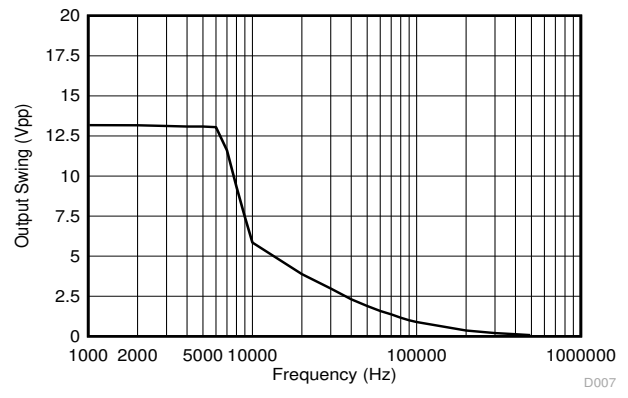

Figure 5-40. Maximum Output Swing vs. Frequency
(VCC = 15 V)

D007

6 Parameter Measurement Information

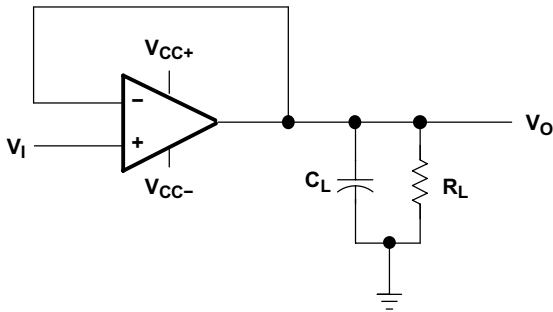

Figure 6-1. Unity-Gain Amplifier

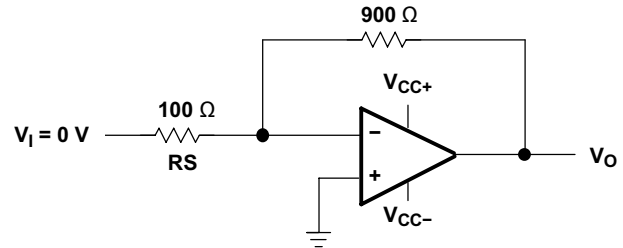

Figure 6-2. Noise-Test Circuit

7 Detailed Description

7.1 Overview

These devices consist of four independent high-gain frequency-compensated operational amplifiers that are designed specifically to operate from a single supply over a wide range of voltages. Operation from split supplies is also possible if the difference between the two supplies is 3 V to 36 V (B and BA versions), 3 V to 26 V (for LM2902 devices), or 3 V to 30 V (for all other devices), and V_{CC} is at least 1.5 V more positive than the input common-mode voltage. The low supply-current drain is independent of the magnitude of the supply voltage.

Applications include transducer amplifiers, DC amplification blocks, and all the conventional operational-amplifier circuits that can be more easily implemented in single-supply-voltage systems. For example, the LM324B and LM2902B devices can be operated directly from the standard 5-V supply that is used in digital systems and provides the required interface electronics, without requiring additional ± 15 -V supplies.

7.2 Functional Block Diagram

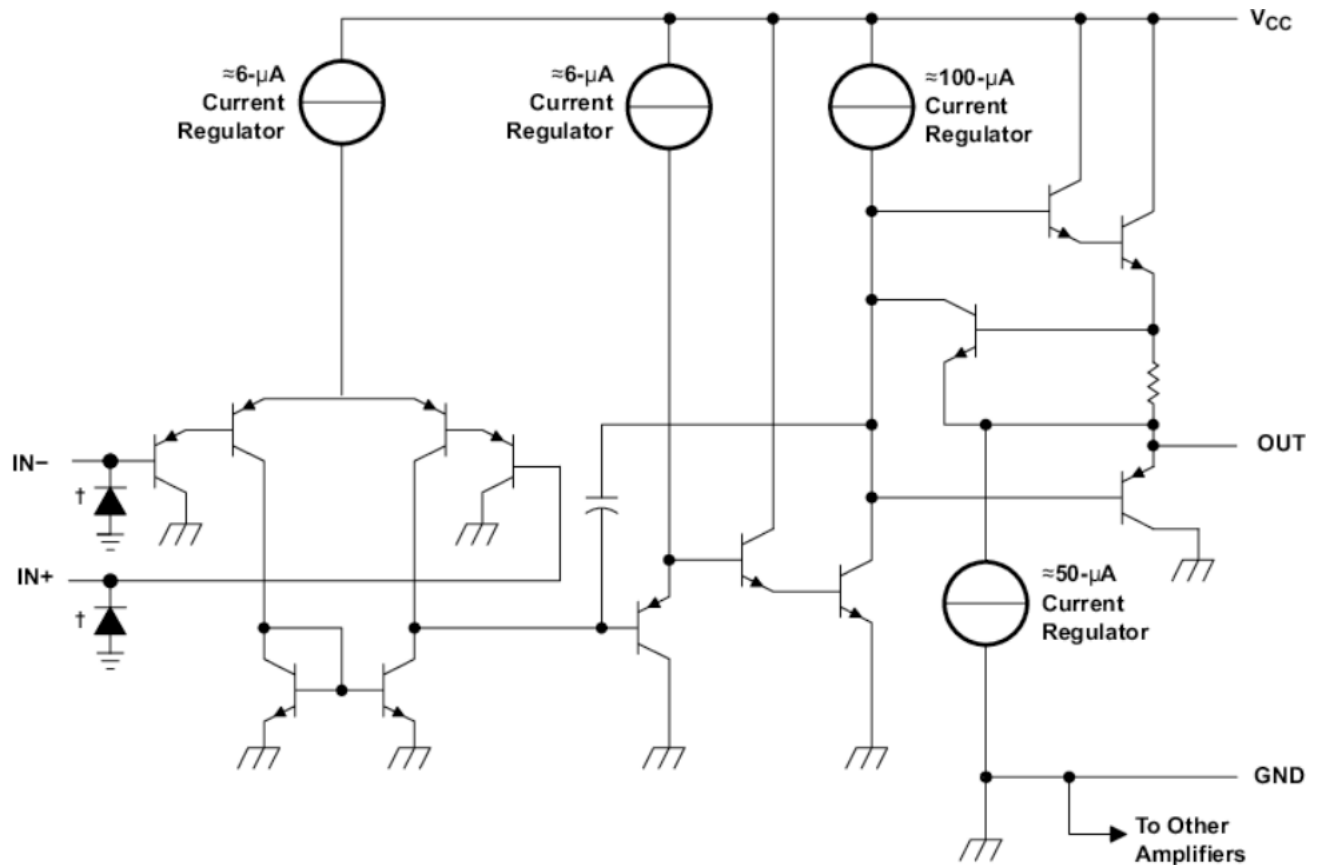

| COMPONENT COUNT (total device) | |
|-----------------------------------|----|
| Epi-FET | 1 |
| Transistors | 95 |
| Diodes | 4 |
| Resistors | 11 |
| Capacitors | 4 |

ESD protection cells - available on B, BA, and K versions only

7.3 Feature Description

7.3.1 Unity-Gain Bandwidth

Gain bandwidth product is found by multiplying the measured bandwidth of an amplifier by the gain at which that bandwidth was measured. These devices have a high gain bandwidth of 1.2 MHz.

7.3.2 Slew Rate

The slew rate is the rate at which an operational amplifier can change the output when there is a change on the input. These devices have a 0.5-V/ μ s slew rate.

7.3.3 Input Common Mode Range

The valid common mode range is from device ground to $V_{CC} - 1.5$ V ($V_{CC} - 2$ V across temperature). Inputs may exceed V_{CC} up to the maximum V_{CC} without device damage. At least one input must be in the valid input common mode range for output to be correct phase. If both inputs exceed valid range, then output phase is undefined. If either input is less than -0.3 V, then input current should be limited to 1 mA and output phase is undefined.

7.4 Device Functional Modes

These devices are powered on when the supply is connected. This device can be operated as a single supply operational amplifier or dual supply amplifier depending on the application.

8 Application and Implementation

Note

Information in the following applications sections is not part of the TI component specification, and TI does not warrant its accuracy or completeness. TI's customers are responsible for determining suitability of components for their purposes, as well as validating and testing their design implementation to confirm system functionality.

8.1 Application Information

The LMx24 and LM2902 operational amplifiers are useful in a wide range of signal conditioning applications. Inputs can be powered before VCC for flexibility in multiple supply circuits.

8.2 Typical Application

A typical application for an operational amplifier in an inverting amplifier. This amplifier takes a positive voltage on the input, and makes it a negative voltage of the same magnitude. In the same manner, it also makes negative voltages positive.

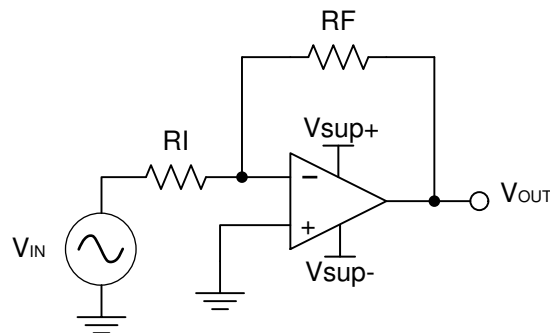

Figure 8-1. Application Schematic

8.2.1 Design Requirements

The supply voltage must be chosen such that it is larger than the input voltage range and output range. For instance, this application will scale a signal of ± 0.5 V to ± 1.8 V. Setting the supply at ± 12 V is sufficient to accommodate this application.

8.2.2 Detailed Design Procedure

Determine the gain required by the inverting amplifier using [Equation 1](#) and [Equation 2](#):

$$A_V = \frac{V_{OUT}}{V_{IN}} \quad (1)$$

$$A_V = \frac{1.8}{-0.5} = -3.6 \quad (2)$$

Once the desired gain is determined, choose a value for R_I or R_F . Choosing a value in the $k\Omega$ range is desirable because the amplifier circuit uses currents in the mA range. This choice makes sure that the part does not draw too much current. This example chooses $10\text{ k}\Omega$ for R_I , which means $36\text{ k}\Omega$ is used for R_F . This was determined by [Equation 3](#).

$$A_V = \frac{R_F}{R_I} \quad (3)$$

8.2.3 Application Curve

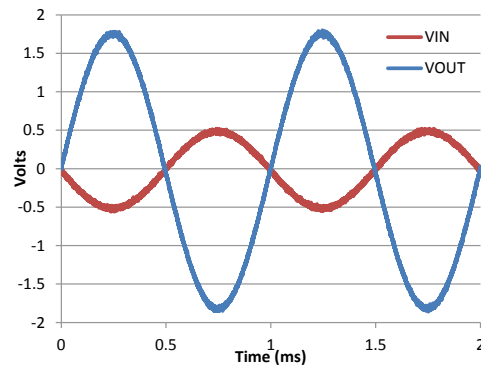

Figure 8-2. Input and Output Voltages of the Inverting Amplifier

8.3 Power Supply Recommendations

CAUTION

Supply voltages larger than 32 V for a single supply, or outside the range of ± 16 V for a dual supply can permanently damage the device (see the [Section 5.1](#)).

Place 0.1- μ F bypass capacitors close to the power-supply pins to reduce errors coupling in from noisy or high impedance power supplies. For more detailed information on bypass capacitor placement, refer to the [Section 8.4](#).

8.4 Layout

8.4.1 Layout Guidelines

For best operational performance of the device, use good PCB layout practices, including:

- Noise can propagate into analog circuitry through the power pins of the circuit as a whole, as well as the operational amplifier. Bypass capacitors are used to reduce the coupled noise by providing low impedance power sources local to the analog circuitry.
 - Connect low-ESR, 0.1- μ F ceramic bypass capacitors between each supply pin and ground, placed as close to the device as possible. A single bypass capacitor from V+ to ground is applicable for single supply applications.
- Separate grounding for analog and digital portions of circuitry is one of the simplest and most-effective methods of noise suppression. One or more layers on multilayer PCBs are usually devoted to ground planes. A ground plane helps distribute heat and reduces EMI noise pickup. Make sure to physically separate digital and analog grounds, paying attention to the flow of the ground current.
- To reduce parasitic coupling, run the input traces as far away from the supply or output traces as possible. If it is not possible to keep them separate, it is much better to cross the sensitive trace perpendicular as opposed to in parallel with the noisy trace.
- Place the external components as close to the device as possible. Keeping RF and RG close to the inverting input minimizes parasitic capacitance, as shown in [Section 8.4.2](#).
- Keep the length of input traces as short as possible. Always remember that the input traces are the most sensitive part of the circuit.
- Consider a driven, low-impedance guard ring around the critical traces. A guard ring can significantly reduce leakage currents from nearby traces that are at different potentials.

8.4.2 Layout Examples

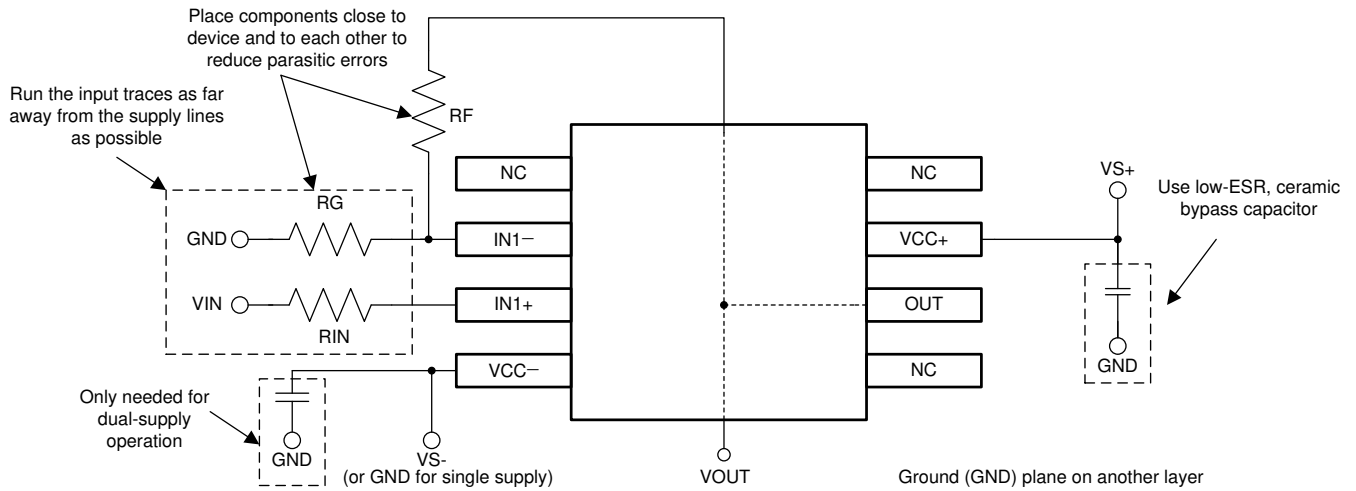

Figure 8-3. Operational Amplifier Board Layout for Noninverting Configuration

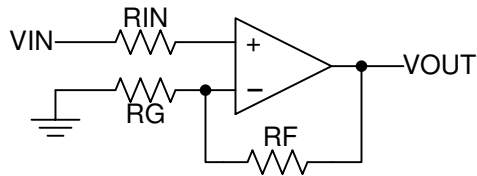

Figure 8-4. Operational Amplifier Schematic for Noninverting Configuration

9 Device and Documentation Support

9.1 Receiving Notification of Documentation Updates

To receive notification of documentation updates, navigate to the device product folder on ti.com. Click on *Notifications* to register and receive a weekly digest of any product information that has changed. For change details, review the revision history included in any revised document.

9.2 Support Resources

[TI E2E™ support forums](#) are an engineer's go-to source for fast, verified answers and design help — straight from the experts. Search existing answers or ask your own question to get the quick design help you need.

Linked content is provided "AS IS" by the respective contributors. They do not constitute TI specifications and do not necessarily reflect TI's views; see TI's [Terms of Use](#).

9.3 Trademarks

TI E2E™ is a trademark of Texas Instruments.
All trademarks are the property of their respective owners.

9.4 Electrostatic Discharge Caution



This integrated circuit can be damaged by ESD. Texas Instruments recommends that all integrated circuits be handled with appropriate precautions. Failure to observe proper handling and installation procedures can cause damage.

ESD damage can range from subtle performance degradation to complete device failure. Precision integrated circuits may be more susceptible to damage because very small parametric changes could cause the device not to meet its published specifications.

9.5 Glossary

[TI Glossary](#) This glossary lists and explains terms, acronyms, and definitions.

10 Revision History

NOTE: Page numbers for previous revisions may differ from page numbers in the current version.

| Changes from Revision AB (November 2023) to Revision AC (March 2024) | Page |
|--|------|
| • Added preview note to the WQFN-16 package pinout..... | 3 |
| • Added LM324BIRTER and LM2902BIRTER preview information to the <i>Mechanical, Packaging, and Orderable Information</i> section..... | 28 |

| Changes from Revision AA (September 2023) to Revision AB (November 2023) | Page |
|--|------|
| • Changed the status of LM324BA and LM2902BA from: preview to: active..... | 1 |

| Changes from Revision Z (April 2023) to Revision AA (September 2023) | Page |
|--|------|
| • Removed preview note from TSSOP-14 BA devices in <i>Device Information</i> table..... | 1 |
| • Changed the format of the <i>Package Information</i> table to include package lead size..... | 1 |

| Changes from Revision Y (October 2022) to Revision Z (April 2023) | Page |
|--|------|
| • Added WQFN-16 package in the <i>Package Information</i> table..... | 1 |
| • Added WQFN-16 package details to <i>Pin Configuration and Functions</i> section..... | 3 |

- Added additional graphs for LM324Bx and LM2902Bx to *Typical Characteristics* 14

Changes from Revision X (May 2022) to Revision Y (October 2022) Page

- Removed preview note from TSSOP-14 B devices in *Device Information* table..... 1
- Updated *Description* information..... 1
- Updated LM324B and LM324BA *Electrical Characteristics* table for RTM revision..... 7
- Updated LM2902B and LM2902BA *Electrical Characteristics* table for RTM revision..... 9
- Added graphs for LM324Bx and LM2902Bx to *Typical Characteristics* 14

Changes from Revision W (March 2015) to Revision X (May 2022) Page

- Updated *Features* to include the B and BA versions..... 1
- Added application links to *Applications* section..... 1
- Corrected available packages in the *Device Information* table..... 1
- Added B and BA versions to *Device Information* table..... 1
- Updated package images in the *Pin Configuration and Functions* section to new format - no specification changes..... 3
- Renamed GND and Vcc to Vcc- and Vcc+, respectively, in the *Pin Functions* table 3
- Added B and BA versions to *Absolute Maximum Ratings* table 5
- Added the B and BA versions to the *ESD Ratings* table 5
- Added B and BA versions to *Recommended Operating Conditions* table 5
- Added the *Electrical Characteristics - LM324B and LM324BA* table 7
- Added the *Electrical Characteristics - LM2902B and LM2902BA* table..... 9
- Removed *Documentation Support* and *Related Links* in the *Device and Documentation Support* section..... 27

Changes from Revision V (January 2014) to Revision W (March 2014) Page

- Added *Applications* 1
- Added *Device Information* table..... 1
- Added *Mechanical, Packaging, and Orderable Information* section..... 28

Changes from Revision U (August 2010) to Revision V (January 2014) Page

- Updated document to new TI data sheet format - no specification changes..... 1
- Updated *Features* 1
- Updated *Features* 1
- Removed *Ordering Information* table..... 3
- Added *Pin Functions* table 3

11 Mechanical, Packaging, and Orderable Information

The following pages include mechanical packaging and orderable information. This information is the most current data available for the designated devices. This data is subject to change without notice and revision of this document. For browser based versions of this data sheet, refer to the left hand navigation.

11.1 Package Option Addendum

Packaging Information

| Orderable Device | Status ⁽¹⁾ | Package Type | Package Drawing | Pins | Package Qty | Eco Plan ⁽²⁾ | Lead/Ball Finish ⁽⁶⁾ | MSL Peak Temp ⁽³⁾ | Op Temp (°C) | Device Marking ^{(4) (5)} |
|------------------|-----------------------|--------------|-----------------|------|-------------|-------------------------|---------------------------------|------------------------------|--------------|-----------------------------------|
| LM324BIRTER | PREVIEW | WQFN | RTE | 16 | 5000 | RoHS & Green | NIPDAU | Level-1-260C-UNLIM | -40 to 125 | LM324B |
| LM2902BIRTER | PREVIEW | WQFN | RTE | 16 | 5000 | RoHS & Green | NIPDAU | Level-1-260C-UNLIM | -40 to 125 | L2902B |

- (1) The marketing status values are defined as follows:
ACTIVE: Product device recommended for new designs.
LIFEBUY: TI has announced that the device will be discontinued, and a lifetime-buy period is in effect.
NRND: Not recommended for new designs. Device is in production to support existing customers, but TI does not recommend using this part in a new design.
PRE_PROD Unannounced device, not in production, not available for mass market, nor on the web, samples not available.
PREVIEW: Device has been announced but is not in production. Samples may or may not be available.
OBSOLETE: TI has discontinued the production of the device.
- (2) Eco Plan - The planned eco-friendly classification: Pb-Free (RoHS), Pb-Free (RoHS Exempt), or Green (RoHS & no Sb/Br) - please check www.ti.com/productcontent for the latest availability information and additional product content details.
TBD: The Pb-Free/Green conversion plan has not been defined.
Pb-Free (RoHS): TI's terms "Lead-Free" or "Pb-Free" mean semiconductor products that are compatible with the current RoHS requirements for all 6 substances, including the requirement that lead not exceed 0.1% by weight in homogeneous materials. Where designed to be soldered at high temperatures, TI Pb-Free products are suitable for use in specified lead-free processes.
Pb-Free (RoHS Exempt): This component has a RoHS exemption for either 1) lead-based flip-chip solder bumps used between the die and package, or 2) lead-based die adhesive used between the die and leadframe. The component is otherwise considered Pb-Free (RoHS compatible) as defined above.
Green (RoHS & no Sb/Br): TI defines "Green" to mean Pb-Free (RoHS compatible), and free of Bromine (Br) and Antimony (Sb) based flame retardants (Br or Sb do not exceed 0.1% by weight in homogeneous material).
- (3) MSL, Peak Temp. -- The Moisture Sensitivity Level rating according to the JEDEC industry standard classifications, and peak solder temperature.
- (4) There may be additional marking, which relates to the logo, the lot trace code information, or the environmental category on the device.
- (5) Multiple Device markings will be inside parentheses. Only one Device Marking contained in parentheses and separated by a "~" will appear on a device. If a line is indented then it is a continuation of the previous line and the two combined represent the entire Device Marking for that device.
- (6) Lead/Ball Finish - Orderable Devices may have multiple material finish options. Finish options are separated by a vertical ruled line. Lead/Ball Finish values may wrap to two lines if the finish value exceeds the maximum column width.

Important Information and Disclaimer: The information provided on this page represents TI's knowledge and belief as of the date that it is provided. TI bases its knowledge and belief on information provided by third parties, and makes no representation or warranty as to the accuracy of such information. Efforts are underway to better integrate information from third parties. TI has taken and continues to take reasonable steps to provide representative and accurate information but may not have conducted destructive testing or chemical analysis on incoming materials and chemicals. TI and TI suppliers consider certain information to be proprietary, and thus CAS numbers and other limited information may not be available for release.

In no event shall TI's liability arising out of such information exceed the total purchase price of the TI part(s) at issue in this document sold by TI to Customer on an annual basis.

11.2 Tape and Reel Information

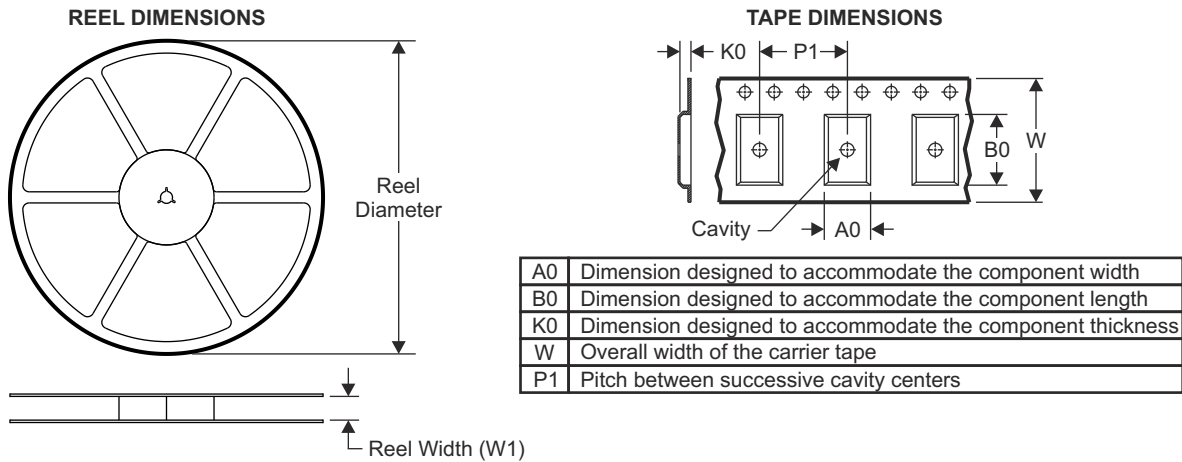

QUADRANT ASSIGNMENTS FOR PIN 1 ORIENTATION IN TAPE

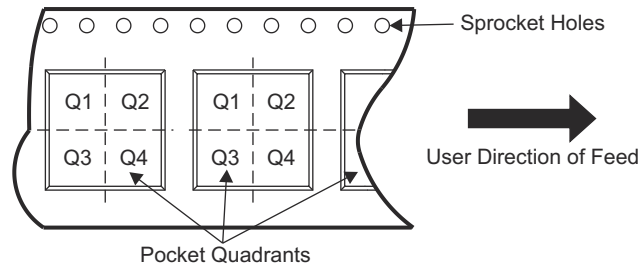

| Device | Package Type | Package Drawing | Pins | SPQ | Reel Diameter (mm) | Reel Width W1 (mm) | A0 (mm) | B0 (mm) | K0 (mm) | P1 (mm) | W (mm) | Pin1 Quadrant |
|--------------|--------------|-----------------|------|------|--------------------|--------------------|---------|---------|---------|---------|--------|---------------|
| LM324BIRTER | WQFN | RTE | 16 | 5000 | 330 | 12.4 | 3.3 | 3.3 | 1.1 | 8 | 12 | Q2 |
| LM2902BIRTER | WQFN | RTE | 16 | 5000 | 330 | 12.4 | 3.3 | 3.3 | 1.1 | 8 | 12 | Q2 |

TAPE AND REEL BOX DIMENSIONS



| Device | Package Type | Package Drawing | Pins | SPQ | Length (mm) | Width (mm) | Height (mm) |
|--------------|--------------|-----------------|------|------|-------------|------------|-------------|
| LM324BIRTER | WQFN | RTE | 16 | 5000 | 367.0 | 367.0 | 35.0 |
| LM2902BIRTER | WQFN | RTE | 16 | 5000 | 367.0 | 367.0 | 35.0 |

RTE0016C



PACKAGE OUTLINE

WQFN - 0.8 mm max height

PLASTIC QUAD FLATPACK - NO LEAD

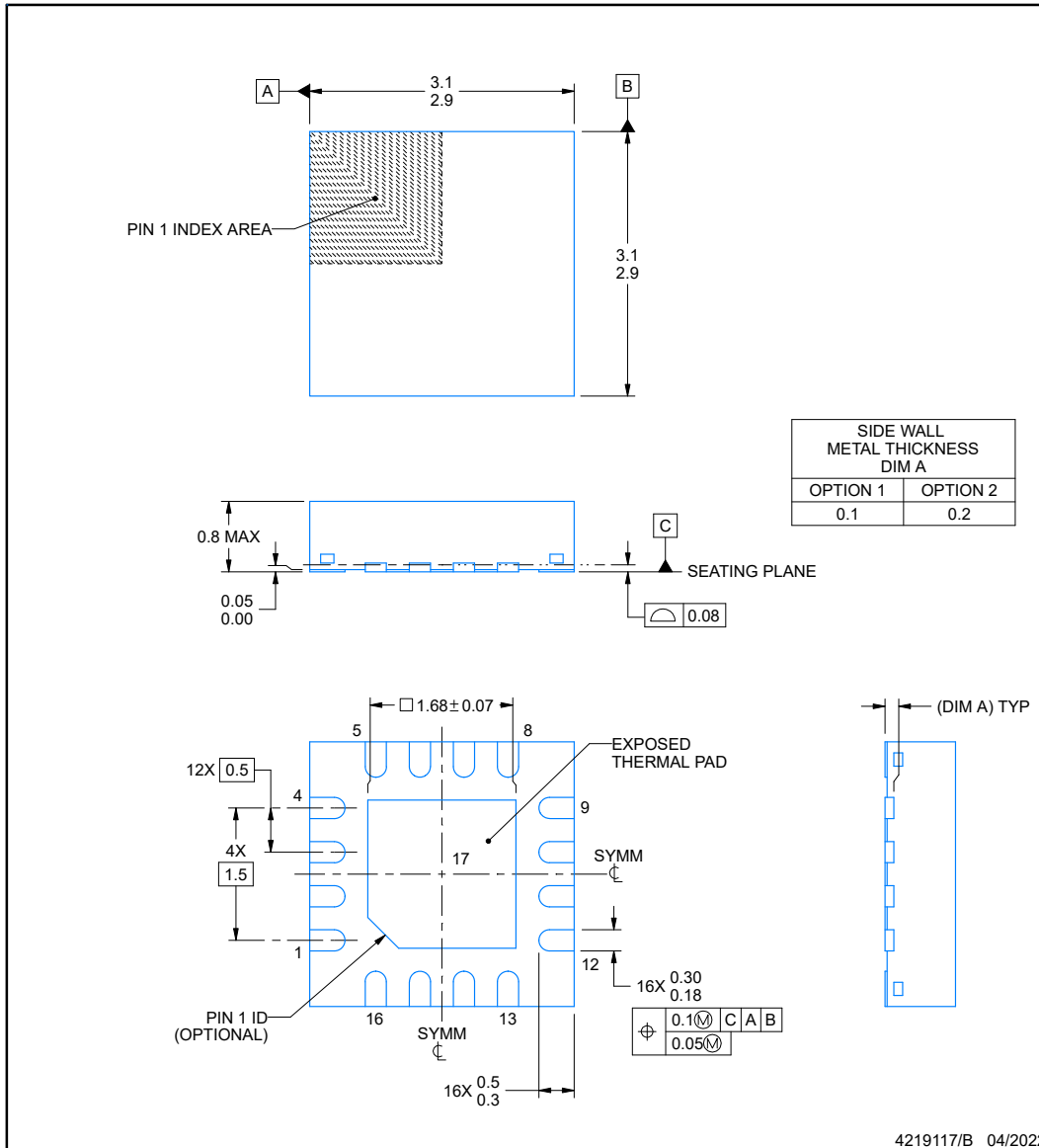

NOTES:

1. All linear dimensions are in millimeters. Any dimensions in parenthesis are for reference only. Dimensioning and tolerancing per ASME Y14.5M.
2. This drawing is subject to change without notice.
3. The package thermal pad must be soldered to the printed circuit board for thermal and mechanical performance.

EXAMPLE BOARD LAYOUT

RTE0016C

WQFN - 0.8 mm max height

PLASTIC QUAD FLATPACK - NO LEAD

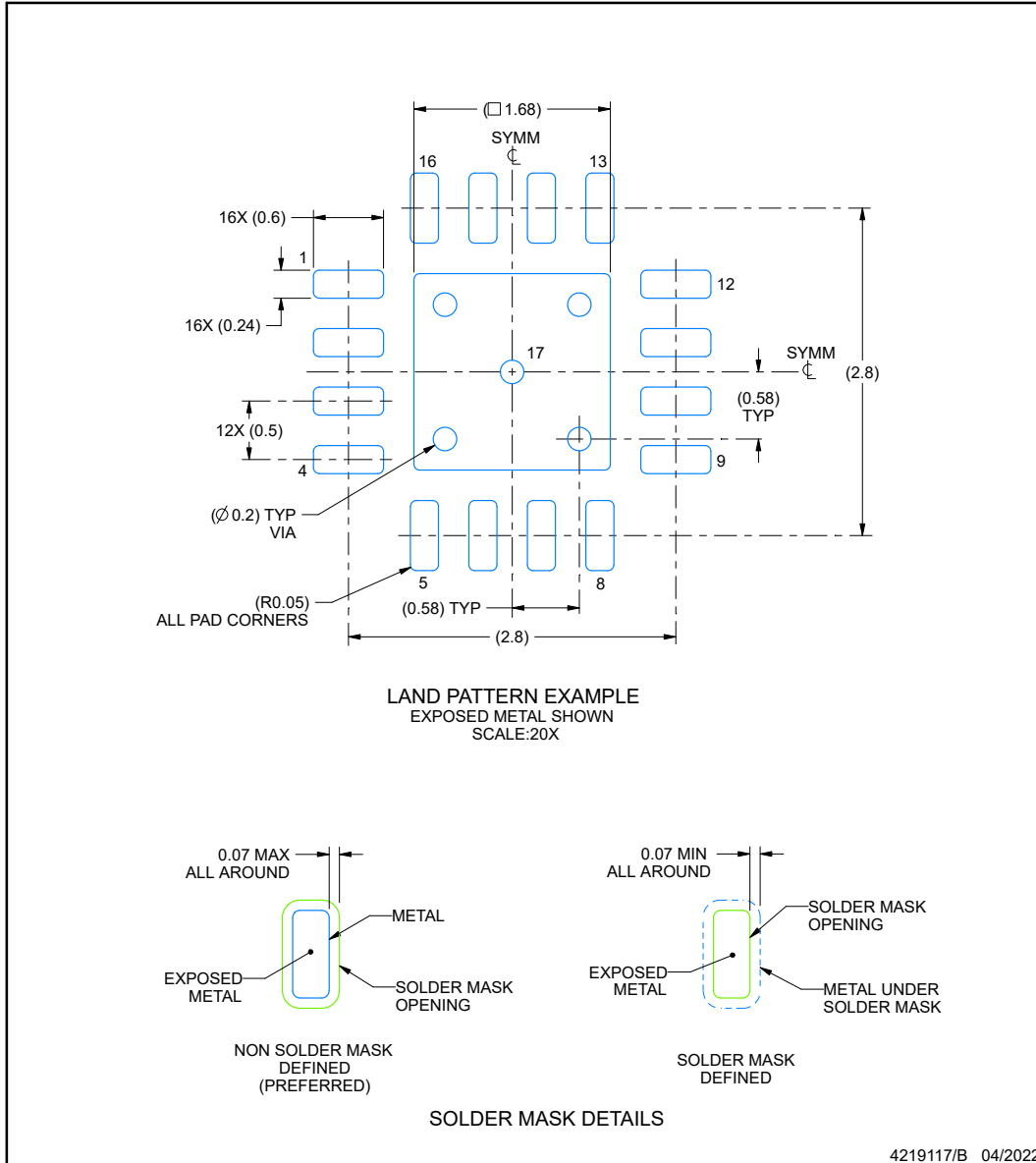

NOTES: (continued)

- This package is designed to be soldered to a thermal pad on the board. For more information, see Texas Instruments literature number SLUA271 (www.ti.com/lit/sluea271).
- Vias are optional depending on application, refer to device data sheet. If any vias are implemented, refer to their locations shown on this view. It is recommended that vias under paste be filled, plugged or tented.

EXAMPLE STENCIL DESIGN

RTE0016C

WQFN - 0.8 mm max height

PLASTIC QUAD FLATPACK - NO LEAD

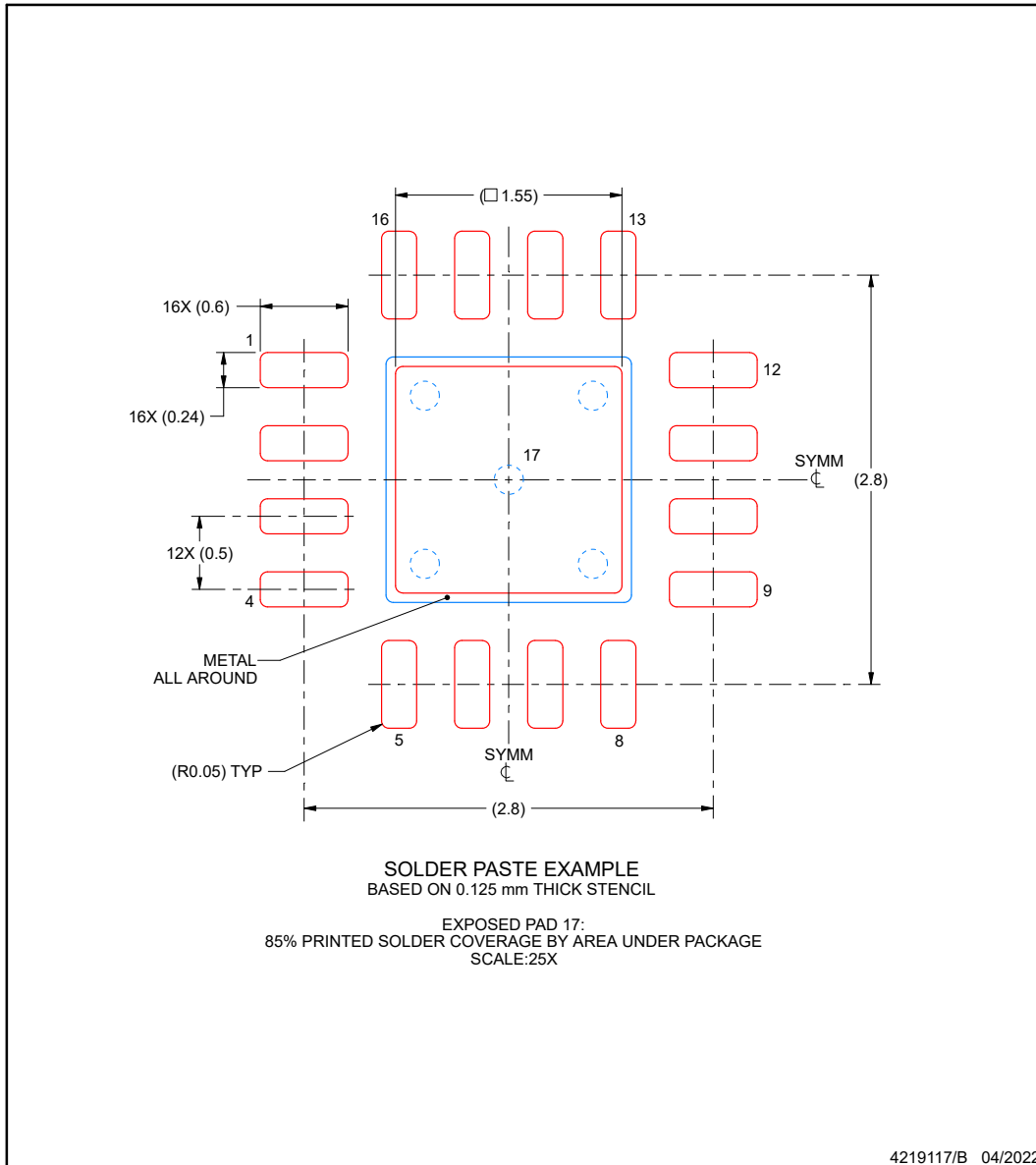

NOTES: (continued)

6. Laser cutting apertures with trapezoidal walls and rounded corners may offer better paste release. IPC-7525 may have alternate design recommendations.

PACKAGING INFORMATION

| Orderable Device | Status (1) | Package Type | Package Drawing | Pins | Package Qty | Eco Plan (2) | Lead finish/ Ball material (6) | MSL Peak Temp (3) | Op Temp (°C) | Device Marking (4/5) | Samples |
|------------------|---------------|--------------|-----------------|------|-------------|------------------|--------------------------------------|----------------------|--------------|------------------------------------|-------------------------|
| 5962-7704301VCA | ACTIVE | CDIP | J | 14 | 25 | Non-RoHS & Green | SNPB | N / A for Pkg Type | -55 to 125 | 5962-7704301VC A LM124JQMLV | Samples |
| 5962-9950403V9B | ACTIVE | XCEPT | KGD | 0 | 100 | RoHS & Green | Call TI | N / A for Pkg Type | -55 to 125 | | Samples |
| 5962-9950403VCA | ACTIVE | CDIP | J | 14 | 25 | Non-RoHS & Green | SNPB | N / A for Pkg Type | -55 to 125 | 5962-9950403VC A LM124AJQMLV | Samples |
| 77043012A | ACTIVE | LCCC | FK | 20 | 55 | Non-RoHS & Green | SNPB | N / A for Pkg Type | -55 to 125 | 77043012A LM124FKB | Samples |
| 7704301CA | ACTIVE | CDIP | J | 14 | 25 | Non-RoHS & Green | SNPB | N / A for Pkg Type | -55 to 125 | 7704301CA LM124JB | Samples |
| 7704301DA | ACTIVE | CFP | W | 14 | 25 | Non-RoHS & Green | SNPB | N / A for Pkg Type | -55 to 125 | 7704301DA LM124WB | Samples |
| 77043022A | ACTIVE | LCCC | FK | 20 | 55 | Non-RoHS & Green | SNPB | N / A for Pkg Type | -55 to 125 | 77043022A LM124AFKB | Samples |
| 7704302CA | ACTIVE | CDIP | J | 14 | 25 | Non-RoHS & Green | SNPB | N / A for Pkg Type | -55 to 125 | 7704302CA LM124AJB | Samples |
| 7704302DA | ACTIVE | CFP | W | 14 | 25 | Non-RoHS & Green | SNPB | N / A for Pkg Type | -55 to 125 | 7704302DA LM124AWB | Samples |
| JM38510/11005BCA | ACTIVE | CDIP | J | 14 | 25 | Non-RoHS & Green | SNPB | N / A for Pkg Type | -55 to 125 | JM38510 /11005BCA | Samples |
| LM124AFKB | ACTIVE | LCCC | FK | 20 | 55 | Non-RoHS & Green | SNPB | N / A for Pkg Type | -55 to 125 | 77043022A LM124AFKB | Samples |
| LM124AJ | ACTIVE | CDIP | J | 14 | 25 | Non-RoHS & Green | SNPB | N / A for Pkg Type | -55 to 125 | LM124AJ | Samples |
| LM124AJB | ACTIVE | CDIP | J | 14 | 25 | Non-RoHS & Green | SNPB | N / A for Pkg Type | -55 to 125 | 7704302CA LM124AJB | Samples |
| LM124AWB | ACTIVE | CFP | W | 14 | 25 | Non-RoHS & Green | SNPB | N / A for Pkg Type | -55 to 125 | 7704302DA LM124AWB | Samples |
| LM124D | OBSOLETE | SOIC | D | 14 | | TBD | Call TI | Call TI | -55 to 125 | LM124 | |
| LM124DR | ACTIVE | SOIC | D | 14 | 2500 | RoHS & Green | NIPDAU | Level-1-260C-UNLIM | -55 to 125 | LM124 | Samples |
| LM124DRG4 | ACTIVE | SOIC | D | 14 | 2500 | RoHS & Green | NIPDAU | Level-1-260C-UNLIM | -55 to 125 | LM124 | Samples |

| Orderable Device | Status (1) | Package Type | Package Drawing | Pins | Package Qty | Eco Plan (2) | Lead finish/ Ball material (6) | MSL Peak Temp (3) | Op Temp (°C) | Device Marking (4/5) | Samples |
|------------------|---------------|--------------|-----------------|------|-------------|------------------|--------------------------------------|----------------------|--------------|-------------------------|-------------------------|
| LM124FKB | ACTIVE | LCCC | FK | 20 | 55 | Non-RoHS & Green | SNPB | N / A for Pkg Type | -55 to 125 | 77043012A LM124FKB | Samples |
| LM124J | ACTIVE | CDIP | J | 14 | 25 | Non-RoHS & Green | SNPB | N / A for Pkg Type | -55 to 125 | LM124J | Samples |
| LM124JB | ACTIVE | CDIP | J | 14 | 25 | Non-RoHS & Green | SNPB | N / A for Pkg Type | -55 to 125 | 7704301CA LM124JB | Samples |
| LM124W | ACTIVE | CFP | W | 14 | 25 | Non-RoHS & Green | SNPB | N / A for Pkg Type | -55 to 125 | LM124W | Samples |
| LM124WB | ACTIVE | CFP | W | 14 | 25 | Non-RoHS & Green | SNPB | N / A for Pkg Type | -55 to 125 | 7704301DA LM124WB | Samples |
| LM224AD | OBSOLETE | SOIC | D | 14 | | TBD | Call TI | Call TI | -25 to 85 | LM224A | |
| LM224ADR | ACTIVE | SOIC | D | 14 | 2500 | RoHS & Green | NIPDAU SN | Level-1-260C-UNLIM | -25 to 85 | LM224A | Samples |
| LM224ADRE4 | ACTIVE | SOIC | D | 14 | 2500 | RoHS & Green | NIPDAU | Level-1-260C-UNLIM | -25 to 85 | LM224A | Samples |
| LM224ADRG4 | ACTIVE | SOIC | D | 14 | 2500 | RoHS & Green | NIPDAU | Level-1-260C-UNLIM | -25 to 85 | LM224A | Samples |
| LM224AN | ACTIVE | PDIP | N | 14 | 25 | RoHS & Green | NIPDAU | N / A for Pkg Type | -25 to 85 | LM224AN | Samples |
| LM224D | OBSOLETE | SOIC | D | 14 | | TBD | Call TI | Call TI | -25 to 85 | LM224 | |
| LM224DR | ACTIVE | SOIC | D | 14 | 2500 | RoHS & Green | NIPDAU SN | Level-1-260C-UNLIM | -25 to 85 | LM224 | Samples |
| LM224DRG4 | ACTIVE | SOIC | D | 14 | 2500 | RoHS & Green | NIPDAU | Level-1-260C-UNLIM | -25 to 85 | LM224 | Samples |
| LM224KAD | OBSOLETE | SOIC | D | 14 | | TBD | Call TI | Call TI | -25 to 85 | LM224KA | |
| LM224KADR | ACTIVE | SOIC | D | 14 | 2500 | RoHS & Green | NIPDAU | Level-1-260C-UNLIM | -25 to 85 | LM224KA | Samples |
| LM224KADRG4 | ACTIVE | SOIC | D | 14 | 2500 | TBD | Call TI | Call TI | -25 to 85 | | Samples |
| LM224KAN | ACTIVE | PDIP | N | 14 | 25 | RoHS & Green | NIPDAU | N / A for Pkg Type | -25 to 85 | LM224KAN | Samples |
| LM224KDR | ACTIVE | SOIC | D | 14 | 2500 | RoHS & Green | NIPDAU | Level-1-260C-UNLIM | -25 to 85 | LM224K | Samples |
| LM224KN | ACTIVE | PDIP | N | 14 | 25 | RoHS & Green | NIPDAU | N / A for Pkg Type | -25 to 85 | LM224KN | Samples |
| LM224N | ACTIVE | PDIP | N | 14 | 25 | RoHS & Green | NIPDAU | N / A for Pkg Type | -25 to 85 | LM224N | Samples |
| LM224NE4 | ACTIVE | PDIP | N | 14 | 25 | TBD | Call TI | Call TI | -25 to 85 | | Samples |

| Orderable Device | Status (1) | Package Type | Package Drawing | Pins | Package Qty | Eco Plan (2) | Lead finish/ Ball material (6) | MSL Peak Temp (3) | Op Temp (°C) | Device Marking (4/5) | Samples |
|------------------|---------------|--------------|-----------------|------|-------------|-----------------|--------------------------------------|----------------------|--------------|-------------------------|-------------------------|
| LM2902BAIPWR | ACTIVE | TSSOP | PW | 14 | 3000 | RoHS & Green | NIPDAU | Level-1-260C-UNLIM | -40 to 125 | L2902BA | Samples |
| LM2902BIPWR | ACTIVE | TSSOP | PW | 14 | 3000 | RoHS & Green | NIPDAU | Level-1-260C-UNLIM | -40 to 125 | LM2902B | Samples |
| LM2902D | OBSOLETE | SOIC | D | 14 | | TBD | Call TI | Call TI | -40 to 125 | LM2902 | |
| LM2902DR | ACTIVE | SOIC | D | 14 | 2500 | RoHS & Green | NIPDAU SN | Level-1-260C-UNLIM | -40 to 125 | LM2902 | Samples |
| LM2902DRE4 | ACTIVE | SOIC | D | 14 | 2500 | RoHS & Green | NIPDAU | Level-1-260C-UNLIM | -40 to 125 | LM2902 | Samples |
| LM2902DRG4 | ACTIVE | SOIC | D | 14 | 2500 | RoHS & Green | NIPDAU | Level-1-260C-UNLIM | -40 to 125 | LM2902 | Samples |
| LM2902KAVQDR | ACTIVE | SOIC | D | 14 | 2500 | RoHS & Green | NIPDAU | Level-1-260C-UNLIM | -40 to 125 | L2902KA | Samples |
| LM2902KAVQPWR | ACTIVE | TSSOP | PW | 14 | 2000 | RoHS & Green | NIPDAU | Level-1-260C-UNLIM | -40 to 125 | L2902KA | Samples |
| LM2902KAVQPWRG4 | ACTIVE | TSSOP | PW | 14 | 2000 | RoHS & Green | NIPDAU | Level-1-260C-UNLIM | -40 to 125 | L2902KA | Samples |
| LM2902KD | OBSOLETE | SOIC | D | 14 | | TBD | Call TI | Call TI | -40 to 125 | LM2902K | |
| LM2902KDB | ACTIVE | SSOP | DB | 14 | 80 | RoHS & Green | NIPDAU | Level-1-260C-UNLIM | -40 to 125 | L2902K | Samples |
| LM2902KDR | ACTIVE | SOIC | D | 14 | 2500 | RoHS & Green | NIPDAU | Level-1-260C-UNLIM | -40 to 125 | LM2902K | Samples |
| LM2902KN | ACTIVE | PDIP | N | 14 | 25 | RoHS & Green | NIPDAU | N / A for Pkg Type | -40 to 125 | LM2902KN | Samples |
| LM2902KNSR | ACTIVE | SO | NS | 14 | 2000 | RoHS & Green | NIPDAU | Level-1-260C-UNLIM | -40 to 125 | LM2902K | Samples |
| LM2902KNSRG4 | ACTIVE | SO | NS | 14 | 2000 | RoHS & Green | NIPDAU | Level-1-260C-UNLIM | -40 to 125 | LM2902K | Samples |
| LM2902KPW | OBSOLETE | TSSOP | PW | 14 | | TBD | Call TI | Call TI | -40 to 125 | L2902K | |
| LM2902KPWR | ACTIVE | TSSOP | PW | 14 | 2000 | RoHS & Green | NIPDAU | Level-1-260C-UNLIM | -40 to 125 | L2902K | Samples |
| LM2902KVQDR | ACTIVE | SOIC | D | 14 | 2500 | RoHS & Green | NIPDAU | Level-1-260C-UNLIM | -40 to 125 | L2902KV | Samples |
| LM2902KVQPWR | ACTIVE | TSSOP | PW | 14 | 2000 | RoHS & Green | NIPDAU | Level-1-260C-UNLIM | -40 to 125 | L2902KV | Samples |
| LM2902N | ACTIVE | PDIP | N | 14 | 25 | RoHS & Green | NIPDAU SN | N / A for Pkg Type | -40 to 125 | LM2902N | Samples |
| LM2902NSR | ACTIVE | SO | NS | 14 | 2000 | RoHS & Green | NIPDAU | Level-1-260C-UNLIM | -40 to 125 | LM2902 | Samples |
| LM2902PW | OBSOLETE | TSSOP | PW | 14 | | TBD | Call TI | Call TI | -40 to 125 | L2902 | |

| Orderable Device | Status (1) | Package Type | Package Drawing | Pins | Package Qty | Eco Plan (2) | Lead finish/ Ball material (6) | MSL Peak Temp (3) | Op Temp (°C) | Device Marking (4/5) | Samples |
|------------------|---------------|--------------|-----------------|------|-------------|-----------------|--------------------------------------|----------------------|--------------|-------------------------|-------------------------|
| LM2902PWR | ACTIVE | TSSOP | PW | 14 | 2000 | RoHS & Green | NIPDAU SN | Level-1-260C-UNLIM | -40 to 125 | L2902 | Samples |
| LM2902PWRE4 | ACTIVE | TSSOP | PW | 14 | 2000 | RoHS & Green | NIPDAU | Level-1-260C-UNLIM | -40 to 125 | L2902 | Samples |
| LM2902PWRG4 | ACTIVE | TSSOP | PW | 14 | 2000 | RoHS & Green | NIPDAU | Level-1-260C-UNLIM | -40 to 125 | L2902 | Samples |
| LM324AD | OBSOLETE | SOIC | D | 14 | | TBD | Call TI | Call TI | 0 to 70 | LM324A | |
| LM324ADB | ACTIVE | SSOP | DB | 14 | 2000 | RoHS & Green | NIPDAU | Level-1-260C-UNLIM | 0 to 70 | LM324A | Samples |
| LM324ADR | ACTIVE | SOIC | D | 14 | 2500 | RoHS & Green | NIPDAU SN | Level-1-260C-UNLIM | 0 to 70 | LM324A | Samples |
| LM324AN | ACTIVE | PDIP | N | 14 | 25 | RoHS & Green | NIPDAU | N / A for Pkg Type | 0 to 70 | LM324AN | Samples |
| LM324ANSR | ACTIVE | SO | NS | 14 | 2000 | RoHS & Green | NIPDAU | Level-1-260C-UNLIM | 0 to 70 | LM324A | Samples |
| LM324ANSRG4 | ACTIVE | SO | NS | 14 | 2000 | RoHS & Green | NIPDAU | Level-1-260C-UNLIM | 0 to 70 | LM324A | Samples |
| LM324APW | OBSOLETE | TSSOP | PW | 14 | | TBD | Call TI | Call TI | 0 to 70 | L324A | |
| LM324APWR | ACTIVE | TSSOP | PW | 14 | 2000 | RoHS & Green | NIPDAU SN | Level-1-260C-UNLIM | 0 to 70 | L324A | Samples |
| LM324APWRG4 | ACTIVE | TSSOP | PW | 14 | 2000 | RoHS & Green | NIPDAU | Level-1-260C-UNLIM | 0 to 70 | L324A | Samples |
| LM324BAIPWR | ACTIVE | TSSOP | PW | 14 | 3000 | RoHS & Green | NIPDAU | Level-1-260C-UNLIM | -40 to 85 | L324BA | Samples |
| LM324BIPWR | ACTIVE | TSSOP | PW | 14 | 3000 | RoHS & Green | NIPDAU | Level-1-260C-UNLIM | -40 to 85 | LM324B | Samples |
| LM324D | OBSOLETE | SOIC | D | 14 | | TBD | Call TI | Call TI | 0 to 70 | LM324 | |
| LM324DR | ACTIVE | SOIC | D | 14 | 2500 | RoHS & Green | NIPDAU SN | Level-1-260C-UNLIM | 0 to 70 | LM324 | Samples |
| LM324DRE4 | ACTIVE | SOIC | D | 14 | 2500 | RoHS & Green | NIPDAU | Level-1-260C-UNLIM | 0 to 70 | LM324 | Samples |
| LM324DRG4 | ACTIVE | SOIC | D | 14 | 2500 | RoHS & Green | NIPDAU | Level-1-260C-UNLIM | 0 to 70 | LM324 | Samples |
| LM324KAD | OBSOLETE | SOIC | D | 14 | | TBD | Call TI | Call TI | 0 to 70 | LM324KA | |
| LM324KADR | ACTIVE | SOIC | D | 14 | 2500 | RoHS & Green | NIPDAU | Level-1-260C-UNLIM | 0 to 70 | LM324KA | Samples |
| LM324KADRG4 | ACTIVE | SOIC | D | 14 | 2500 | TBD | Call TI | Call TI | 0 to 70 | | Samples |
| LM324KAN | ACTIVE | PDIP | N | 14 | 25 | RoHS & Green | NIPDAU | N / A for Pkg Type | 0 to 70 | LM324KAN | Samples |

| Orderable Device | Status (1) | Package Type | Package Drawing | Pins | Package Qty | Eco Plan (2) | Lead finish/ Ball material (6) | MSL Peak Temp (3) | Op Temp (°C) | Device Marking (4/5) | Samples |
|------------------|---------------|--------------|-----------------|------|-------------|------------------|--------------------------------------|----------------------|--------------|-------------------------|-------------------------|
| LM324KANSR | ACTIVE | SO | NS | 14 | 2000 | RoHS & Green | NIPDAU | Level-1-260C-UNLIM | 0 to 70 | LM324KA | Samples |
| LM324KAPW | OBSOLETE | TSSOP | PW | 14 | | TBD | Call TI | Call TI | 0 to 70 | L324KA | |
| LM324KAPWR | ACTIVE | TSSOP | PW | 14 | 2000 | RoHS & Green | NIPDAU | Level-1-260C-UNLIM | 0 to 70 | L324KA | Samples |
| LM324KDR | ACTIVE | SOIC | D | 14 | 2500 | RoHS & Green | NIPDAU | Level-1-260C-UNLIM | 0 to 70 | LM324K | Samples |
| LM324KN | ACTIVE | PDIP | N | 14 | 25 | RoHS & Green | NIPDAU | N / A for Pkg Type | 0 to 70 | LM324KN | Samples |
| LM324KNSR | ACTIVE | SO | NS | 14 | 2000 | RoHS & Green | NIPDAU | Level-1-260C-UNLIM | 0 to 70 | LM324K | Samples |
| LM324KPW | OBSOLETE | TSSOP | PW | 14 | | TBD | Call TI | Call TI | 0 to 70 | L324K | |
| LM324KPWR | ACTIVE | TSSOP | PW | 14 | 2000 | RoHS & Green | NIPDAU | Level-1-260C-UNLIM | 0 to 70 | L324K | Samples |
| LM324N | ACTIVE | PDIP | N | 14 | 25 | RoHS & Green | NIPDAU SN | N / A for Pkg Type | 0 to 70 | LM324N | Samples |
| LM324NSR | ACTIVE | SO | NS | 14 | 2000 | RoHS & Green | NIPDAU | Level-1-260C-UNLIM | 0 to 70 | LM324 | Samples |
| LM324NSRE4 | ACTIVE | SO | NS | 14 | 2000 | RoHS & Green | NIPDAU | Level-1-260C-UNLIM | 0 to 70 | LM324 | Samples |
| LM324NSRG4 | ACTIVE | SO | NS | 14 | 2000 | RoHS & Green | NIPDAU | Level-1-260C-UNLIM | 0 to 70 | LM324 | Samples |
| LM324PW | OBSOLETE | TSSOP | PW | 14 | | TBD | Call TI | Call TI | 0 to 70 | L324 | |
| LM324PWR | ACTIVE | TSSOP | PW | 14 | 2000 | RoHS & Green | NIPDAU SN | Level-1-260C-UNLIM | 0 to 70 | L324 | Samples |
| LM324PWRE4 | ACTIVE | TSSOP | PW | 14 | 2000 | RoHS & Green | NIPDAU | Level-1-260C-UNLIM | 0 to 70 | L324 | Samples |
| LM324PWRG4 | ACTIVE | TSSOP | PW | 14 | 2000 | RoHS & Green | NIPDAU | Level-1-260C-UNLIM | 0 to 70 | L324 | Samples |
| M38510/11005BCA | ACTIVE | CDIP | J | 14 | 25 | Non-RoHS & Green | SNPB | N / A for Pkg Type | -55 to 125 | JM38510 /11005BCA | Samples |
| PLM2902BIDR | ACTIVE | SOIC | D | 14 | 3000 | TBD | Call TI | Call TI | -40 to 125 | | Samples |
| PLM324BIDR | ACTIVE | SOIC | D | 14 | 3000 | TBD | Call TI | Call TI | -40 to 85 | | Samples |

(1) The marketing status values are defined as follows:

ACTIVE: Product device recommended for new designs.

LIFEBUY: TI has announced that the device will be discontinued, and a lifetime-buy period is in effect.

NRND: Not recommended for new designs. Device is in production to support existing customers, but TI does not recommend using this part in a new design.

PREVIEW: Device has been announced but is not in production. Samples may or may not be available.

OBSOLETE: TI has discontinued the production of the device.

(2) **RoHS:** TI defines "RoHS" to mean semiconductor products that are compliant with the current EU RoHS requirements for all 10 RoHS substances, including the requirement that RoHS substance do not exceed 0.1% by weight in homogeneous materials. Where designed to be soldered at high temperatures, "RoHS" products are suitable for use in specified lead-free processes. TI may reference these types of products as "Pb-Free".

RoHS Exempt: TI defines "RoHS Exempt" to mean products that contain lead but are compliant with EU RoHS pursuant to a specific EU RoHS exemption.

Green: TI defines "Green" to mean the content of Chlorine (Cl) and Bromine (Br) based flame retardants meet JS709B low halogen requirements of <=1000ppm threshold. Antimony trioxide based flame retardants must also meet the <=1000ppm threshold requirement.

(3) MSL, Peak Temp. - The Moisture Sensitivity Level rating according to the JEDEC industry standard classifications, and peak solder temperature.

(4) There may be additional marking, which relates to the logo, the lot trace code information, or the environmental category on the device.

(5) Multiple Device Markings will be inside parentheses. Only one Device Marking contained in parentheses and separated by a "~" will appear on a device. If a line is indented then it is a continuation of the previous line and the two combined represent the entire Device Marking for that device.

(6) Lead finish/Ball material - Orderable Devices may have multiple material finish options. Finish options are separated by a vertical ruled line. Lead finish/Ball material values may wrap to two lines if the finish value exceeds the maximum column width.

Important Information and Disclaimer:The information provided on this page represents TI's knowledge and belief as of the date that it is provided. TI bases its knowledge and belief on information provided by third parties, and makes no representation or warranty as to the accuracy of such information. Efforts are underway to better integrate information from third parties. TI has taken and continues to take reasonable steps to provide representative and accurate information but may not have conducted destructive testing or chemical analysis on incoming materials and chemicals. TI and TI suppliers consider certain information to be proprietary, and thus CAS numbers and other limited information may not be available for release.

In no event shall TI's liability arising out of such information exceed the total purchase price of the TI part(s) at issue in this document sold by TI to Customer on an annual basis.

OTHER QUALIFIED VERSIONS OF LM124, LM124-SP, LM124M, LM2902, LM2902B, LM2902BA :

- Catalog : [LM124](#), [LM124](#)

- Automotive : [LM2902-Q1](#), [LM2902B-Q1](#), [LM2902BA-Q1](#)

- Enhanced Product : [LM2902-EP](#)

- Military : [LM124M](#), [LM124M](#)

- Space : [LM124-SP](#), [LM124-SP](#)

NOTE: Qualified Version Definitions:

- Catalog - TI's standard catalog product
- Automotive - Q100 devices qualified for high-reliability automotive applications targeting zero defects
- Enhanced Product - Supports Defense, Aerospace and Medical Applications
- Military - QML certified for Military and Defense Applications
- Space - Radiation tolerant, ceramic packaging and qualified for use in Space-based application

TAPE AND REEL INFORMATION



QUADRANT ASSIGNMENTS FOR PIN 1 ORIENTATION IN TAPE



*All dimensions are nominal

| Device | Package Type | Package Drawing | Pins | SPQ | Reel Diameter (mm) | Reel Width W1 (mm) | A0 (mm) | B0 (mm) | K0 (mm) | P1 (mm) | W (mm) | Pin1 Quadrant |
|-----------------|--------------|-----------------|------|------|--------------------|--------------------|---------|---------|---------|---------|--------|---------------|
| LM124DR | SOIC | D | 14 | 2500 | 330.0 | 16.4 | 6.5 | 9.0 | 2.1 | 8.0 | 16.0 | Q1 |
| LM224ADR | SOIC | D | 14 | 2500 | 330.0 | 16.4 | 6.5 | 9.0 | 2.1 | 8.0 | 16.0 | Q1 |
| LM224ADRG4 | SOIC | D | 14 | 2500 | 330.0 | 16.4 | 6.5 | 9.0 | 2.1 | 8.0 | 16.0 | Q1 |
| LM224ADRG4 | SOIC | D | 14 | 2500 | 330.0 | 16.4 | 6.5 | 9.0 | 2.1 | 8.0 | 16.0 | Q1 |
| LM224DR | SOIC | D | 14 | 2500 | 330.0 | 16.4 | 6.5 | 9.0 | 2.1 | 8.0 | 16.0 | Q1 |
| LM224DRG4 | SOIC | D | 14 | 2500 | 330.0 | 16.4 | 6.5 | 9.0 | 2.1 | 8.0 | 16.0 | Q1 |
| LM224KADR | SOIC | D | 14 | 2500 | 330.0 | 16.4 | 6.5 | 9.0 | 2.1 | 8.0 | 16.0 | Q1 |
| LM224KADR | SOIC | D | 14 | 2500 | 330.0 | 16.4 | 6.5 | 9.0 | 2.1 | 8.0 | 16.0 | Q1 |
| LM2902BAIPWR | TSSOP | PW | 14 | 3000 | 330.0 | 12.4 | 6.9 | 5.6 | 1.6 | 8.0 | 12.0 | Q1 |
| LM2902BIPWR | TSSOP | PW | 14 | 3000 | 330.0 | 12.4 | 6.9 | 5.6 | 1.6 | 8.0 | 12.0 | Q1 |
| LM2902DR | SOIC | D | 14 | 2500 | 330.0 | 16.4 | 6.5 | 9.0 | 2.1 | 8.0 | 16.0 | Q1 |
| LM2902DRG4 | SOIC | D | 14 | 2500 | 330.0 | 16.4 | 6.5 | 9.0 | 2.1 | 8.0 | 16.0 | Q1 |
| LM2902KAVQPWR | TSSOP | PW | 14 | 2000 | 330.0 | 12.4 | 6.9 | 5.6 | 1.6 | 8.0 | 12.0 | Q1 |
| LM2902KAVQPWRG4 | TSSOP | PW | 14 | 2000 | 330.0 | 12.4 | 6.9 | 5.6 | 1.6 | 8.0 | 12.0 | Q1 |
| LM2902KADR | SOIC | D | 14 | 2500 | 330.0 | 16.4 | 6.5 | 9.0 | 2.1 | 8.0 | 16.0 | Q1 |
| LM2902KNSR | SO | NS | 14 | 2000 | 330.0 | 16.4 | 8.2 | 10.5 | 2.5 | 12.0 | 16.0 | Q1 |

| Device | Package Type | Package Drawing | Pins | SPQ | Reel Diameter (mm) | Reel Width W1 (mm) | A0 (mm) | B0 (mm) | K0 (mm) | P1 (mm) | W (mm) | Pin1 Quadrant |
|--------------|--------------|-----------------|------|------|--------------------|--------------------|---------|---------|---------|---------|--------|---------------|
| LM2902KPWR | TSSOP | PW | 14 | 2000 | 330.0 | 12.4 | 6.9 | 5.6 | 1.6 | 8.0 | 12.0 | Q1 |
| LM2902KVQPWR | TSSOP | PW | 14 | 2000 | 330.0 | 12.4 | 6.9 | 5.6 | 1.6 | 8.0 | 12.0 | Q1 |
| LM2902NSR | SO | NS | 14 | 2000 | 330.0 | 16.4 | 8.2 | 10.5 | 2.5 | 12.0 | 16.0 | Q1 |
| LM2902PWR | TSSOP | PW | 14 | 2000 | 330.0 | 12.4 | 6.9 | 5.6 | 1.6 | 8.0 | 12.0 | Q1 |
| LM2902PWRG4 | TSSOP | PW | 14 | 2000 | 330.0 | 12.4 | 6.9 | 5.6 | 1.6 | 8.0 | 12.0 | Q1 |
| LM324ADBR | SSOP | DB | 14 | 2000 | 330.0 | 16.4 | 8.35 | 6.6 | 2.4 | 12.0 | 16.0 | Q1 |
| LM324ADR | SOIC | D | 14 | 2500 | 330.0 | 16.4 | 6.5 | 9.0 | 2.1 | 8.0 | 16.0 | Q1 |
| LM324ANSR | SO | NS | 14 | 2000 | 330.0 | 16.4 | 8.2 | 10.5 | 2.5 | 12.0 | 16.0 | Q1 |
| LM324APWR | TSSOP | PW | 14 | 2000 | 330.0 | 12.4 | 6.9 | 5.6 | 1.6 | 8.0 | 12.0 | Q1 |
| LM324APWRG4 | TSSOP | PW | 14 | 2000 | 330.0 | 12.4 | 6.9 | 5.6 | 1.6 | 8.0 | 12.0 | Q1 |
| LM324BAIPWR | TSSOP | PW | 14 | 3000 | 330.0 | 12.4 | 6.9 | 5.6 | 1.6 | 8.0 | 12.0 | Q1 |
| LM324BIPWR | TSSOP | PW | 14 | 3000 | 330.0 | 12.4 | 6.9 | 5.6 | 1.6 | 8.0 | 12.0 | Q1 |
| LM324DR | SOIC | D | 14 | 2500 | 330.0 | 16.4 | 6.5 | 9.0 | 2.1 | 8.0 | 16.0 | Q1 |
| LM324DR | SOIC | D | 14 | 2500 | 330.0 | 16.4 | 6.5 | 9.0 | 2.1 | 8.0 | 16.0 | Q1 |
| LM324DRG4 | SOIC | D | 14 | 2500 | 330.0 | 16.4 | 6.5 | 9.0 | 2.1 | 8.0 | 16.0 | Q1 |
| LM324DRG4 | SOIC | D | 14 | 2500 | 330.0 | 16.4 | 6.5 | 9.0 | 2.1 | 8.0 | 16.0 | Q1 |
| LM324KADR | SOIC | D | 14 | 2500 | 330.0 | 16.4 | 6.5 | 9.0 | 2.1 | 8.0 | 16.0 | Q1 |
| LM324KANSR | SO | NS | 14 | 2000 | 330.0 | 16.4 | 8.2 | 10.5 | 2.5 | 12.0 | 16.0 | Q1 |
| LM324KAPWR | TSSOP | PW | 14 | 2000 | 330.0 | 12.4 | 6.9 | 5.6 | 1.6 | 8.0 | 12.0 | Q1 |
| LM324KDR | SOIC | D | 14 | 2500 | 330.0 | 16.4 | 6.5 | 9.0 | 2.1 | 8.0 | 16.0 | Q1 |
| LM324KNSR | SO | NS | 14 | 2000 | 330.0 | 16.4 | 8.2 | 10.5 | 2.5 | 12.0 | 16.0 | Q1 |
| LM324KPWR | TSSOP | PW | 14 | 2000 | 330.0 | 12.4 | 6.9 | 5.6 | 1.6 | 8.0 | 12.0 | Q1 |
| LM324NSR | SO | NS | 14 | 2000 | 330.0 | 16.4 | 8.2 | 10.5 | 2.5 | 12.0 | 16.0 | Q1 |
| LM324PWR | TSSOP | PW | 14 | 2000 | 330.0 | 12.4 | 6.9 | 5.6 | 1.6 | 8.0 | 12.0 | Q1 |
| LM324PWRG4 | TSSOP | PW | 14 | 2000 | 330.0 | 12.4 | 6.9 | 5.6 | 1.6 | 8.0 | 12.0 | Q1 |

TAPE AND REEL BOX DIMENSIONS

*All dimensions are nominal

| Device | Package Type | Package Drawing | Pins | SPQ | Length (mm) | Width (mm) | Height (mm) |
|-----------------|--------------|-----------------|------|------|-------------|------------|-------------|
| LM124DR | SOIC | D | 14 | 2500 | 350.0 | 350.0 | 43.0 |
| LM224ADR | SOIC | D | 14 | 2500 | 356.0 | 356.0 | 35.0 |
| LM224ADRG4 | SOIC | D | 14 | 2500 | 356.0 | 356.0 | 35.0 |
| LM224ADRG4 | SOIC | D | 14 | 2500 | 340.5 | 336.1 | 32.0 |
| LM224DR | SOIC | D | 14 | 2500 | 356.0 | 356.0 | 35.0 |
| LM224DRG4 | SOIC | D | 14 | 2500 | 356.0 | 356.0 | 35.0 |
| LM224KADR | SOIC | D | 14 | 2500 | 356.0 | 356.0 | 35.0 |
| LM224KDR | SOIC | D | 14 | 2500 | 356.0 | 356.0 | 35.0 |
| LM2902BAIPWR | TSSOP | PW | 14 | 3000 | 356.0 | 356.0 | 35.0 |
| LM2902BIPWR | TSSOP | PW | 14 | 3000 | 356.0 | 356.0 | 35.0 |
| LM2902DR | SOIC | D | 14 | 2500 | 333.2 | 345.9 | 28.6 |
| LM2902DRG4 | SOIC | D | 14 | 2500 | 340.5 | 336.1 | 32.0 |
| LM2902KAVQPWR | TSSOP | PW | 14 | 2000 | 356.0 | 356.0 | 35.0 |
| LM2902KAVQPWRG4 | TSSOP | PW | 14 | 2000 | 367.0 | 367.0 | 35.0 |
| LM2902KDR | SOIC | D | 14 | 2500 | 356.0 | 356.0 | 35.0 |
| LM2902KNSR | SO | NS | 14 | 2000 | 356.0 | 356.0 | 35.0 |
| LM2902KPWR | TSSOP | PW | 14 | 2000 | 356.0 | 356.0 | 35.0 |
| LM2902KVQPWR | TSSOP | PW | 14 | 2000 | 356.0 | 356.0 | 35.0 |

| Device | Package Type | Package Drawing | Pins | SPQ | Length (mm) | Width (mm) | Height (mm) |
|-------------|--------------|-----------------|------|------|-------------|------------|-------------|
| LM2902NSR | SO | NS | 14 | 2000 | 356.0 | 356.0 | 35.0 |
| LM2902PWR | TSSOP | PW | 14 | 2000 | 356.0 | 356.0 | 35.0 |
| LM2902PWRG4 | TSSOP | PW | 14 | 2000 | 356.0 | 356.0 | 35.0 |
| LM324ADBR | SSOP | DB | 14 | 2000 | 356.0 | 356.0 | 35.0 |
| LM324ADR | SOIC | D | 14 | 2500 | 356.0 | 356.0 | 35.0 |
| LM324ANSR | SO | NS | 14 | 2000 | 356.0 | 356.0 | 35.0 |
| LM324APWR | TSSOP | PW | 14 | 2000 | 356.0 | 356.0 | 35.0 |
| LM324APWRG4 | TSSOP | PW | 14 | 2000 | 356.0 | 356.0 | 35.0 |
| LM324BAIPWR | TSSOP | PW | 14 | 3000 | 356.0 | 356.0 | 35.0 |
| LM324BIPWR | TSSOP | PW | 14 | 3000 | 356.0 | 356.0 | 35.0 |
| LM324DR | SOIC | D | 14 | 2500 | 356.0 | 356.0 | 35.0 |
| LM324DR | SOIC | D | 14 | 2500 | 333.2 | 345.9 | 28.6 |
| LM324DRG4 | SOIC | D | 14 | 2500 | 340.5 | 336.1 | 32.0 |
| LM324DRG4 | SOIC | D | 14 | 2500 | 356.0 | 356.0 | 35.0 |
| LM324KADR | SOIC | D | 14 | 2500 | 356.0 | 356.0 | 35.0 |
| LM324KANSR | SO | NS | 14 | 2000 | 356.0 | 356.0 | 35.0 |
| LM324KAPWR | TSSOP | PW | 14 | 2000 | 356.0 | 356.0 | 35.0 |
| LM324KDR | SOIC | D | 14 | 2500 | 356.0 | 356.0 | 35.0 |
| LM324KNSR | SO | NS | 14 | 2000 | 356.0 | 356.0 | 35.0 |
| LM324KPWR | TSSOP | PW | 14 | 2000 | 356.0 | 356.0 | 35.0 |
| LM324NSR | SO | NS | 14 | 2000 | 356.0 | 356.0 | 35.0 |
| LM324PWR | TSSOP | PW | 14 | 2000 | 356.0 | 356.0 | 35.0 |
| LM324PWRG4 | TSSOP | PW | 14 | 2000 | 356.0 | 356.0 | 35.0 |

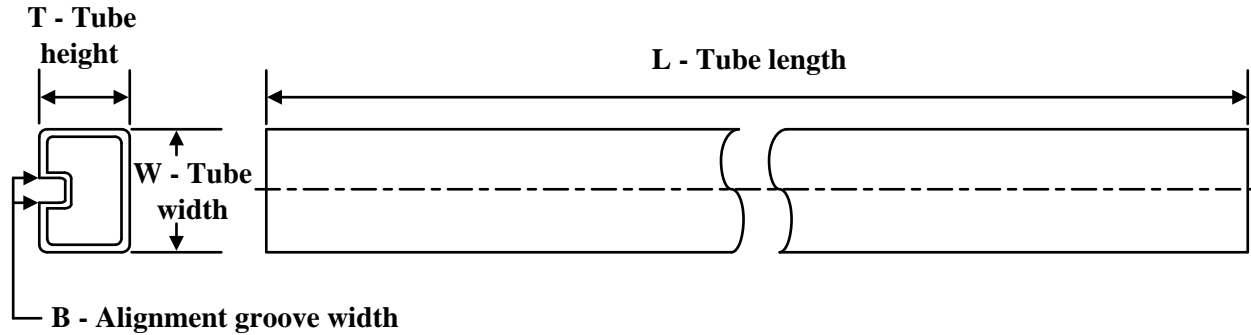
TUBE

*All dimensions are nominal

| Device | Package Name | Package Type | Pins | SPQ | L (mm) | W (mm) | T (µm) | B (mm) |
|-----------------|--------------|--------------|------|-----|--------|--------|--------|--------|
| 5962-9950403VCA | J | CDIP | 14 | 25 | 506.98 | 15.24 | 13440 | NA |
| 77043012A | FK | LCCC | 20 | 55 | 506.98 | 12.06 | 2030 | NA |
| 7704301DA | W | CFP | 14 | 25 | 506.98 | 26.16 | 6220 | NA |
| 77043022A | FK | LCCC | 20 | 55 | 506.98 | 12.06 | 2030 | NA |
| 7704302DA | W | CFP | 14 | 25 | 506.98 | 26.16 | 6220 | NA |
| LM124AFKB | FK | LCCC | 20 | 55 | 506.98 | 12.06 | 2030 | NA |
| LM124AWB | W | CFP | 14 | 25 | 506.98 | 26.16 | 6220 | NA |
| LM124FKB | FK | LCCC | 20 | 55 | 506.98 | 12.06 | 2030 | NA |
| LM124W | W | CFP | 14 | 25 | 506.98 | 26.16 | 6220 | NA |
| LM124WB | W | CFP | 14 | 25 | 506.98 | 26.16 | 6220 | NA |
| LM224AN | N | PDIP | 14 | 25 | 506 | 13.97 | 11230 | 4.32 |
| LM224KAN | N | PDIP | 14 | 25 | 506 | 13.97 | 11230 | 4.32 |
| LM224KN | N | PDIP | 14 | 25 | 506 | 13.97 | 11230 | 4.32 |
| LM224N | N | PDIP | 14 | 25 | 506 | 13.97 | 11230 | 4.32 |
| LM2902KDB | DB | SSOP | 14 | 80 | 530 | 10.5 | 4000 | 4.1 |
| LM2902KN | N | PDIP | 14 | 25 | 506 | 13.97 | 11230 | 4.32 |
| LM2902N | N | PDIP | 14 | 25 | 506.1 | 9 | 600 | 5.4 |
| LM2902N | N | PDIP | 14 | 25 | 506 | 13.97 | 11230 | 4.32 |
| LM324AN | N | PDIP | 14 | 25 | 506 | 13.97 | 11230 | 4.32 |
| LM324AN | N | PDIP | 14 | 25 | 506 | 13.97 | 11230 | 4.32 |
| LM324KAN | N | PDIP | 14 | 25 | 506 | 13.97 | 11230 | 4.32 |
| LM324KAN | N | PDIP | 14 | 25 | 506 | 13.97 | 11230 | 4.32 |
| LM324KN | N | PDIP | 14 | 25 | 506 | 13.97 | 11230 | 4.32 |
| LM324KN | N | PDIP | 14 | 25 | 506 | 13.97 | 11230 | 4.32 |
| LM324N | N | PDIP | 14 | 25 | 506 | 13.97 | 11230 | 4.32 |
| LM324N | N | PDIP | 14 | 25 | 506.1 | 9 | 600 | 5.4 |
| LM324N | N | PDIP | 14 | 25 | 506 | 13.97 | 11230 | 4.32 |
| LM324N | N | PDIP | 14 | 25 | 506 | 13.97 | 11230 | 4.32 |

GENERIC PACKAGE VIEW

RTE 16

WQFN - 0.8 mm max height

3 x 3, 0.5 mm pitch

PLASTIC QUAD FLATPACK - NO LEAD

This image is a representation of the package family, actual package may vary.
Refer to the product data sheet for package details.



4225944/A

MECHANICAL DATA

NS (R-PDSO-G)**

PLASTIC SMALL-OUTLINE PACKAGE

14-PINS SHOWN



- NOTES:
- A. All linear dimensions are in millimeters.
 - B. This drawing is subject to change without notice.
 - C. Body dimensions do not include mold flash or protrusion, not to exceed 0,15.

W (R-GDFP-F14)

CERAMIC DUAL FLATPACK



- NOTES:
- A. All linear dimensions are in inches (millimeters).
 - B. This drawing is subject to change without notice.
 - C. This package can be hermetically sealed with a ceramic lid using glass frit.
 - D. Index point is provided on cap for terminal identification only.
 - E. Falls within MIL STD 1835 GDFP1-F14

DB0014A

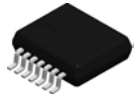

PACKAGE OUTLINE

SSOP - 2 mm max height

SMALL OUTLINE PACKAGE



4220762/A 05/2024

NOTES:

- All linear dimensions are in millimeters. Any dimensions in parenthesis are for reference only. Dimensioning and tolerancing per ASME Y14.5M.
- This drawing is subject to change without notice.
- This dimension does not include mold flash, protrusions, or gate burrs. Mold flash, protrusions, or gate burrs shall not exceed 0.15 mm per side.
- Reference JEDEC registration MO-150.

EXAMPLE BOARD LAYOUT

DB0014A

SSOP - 2 mm max height

SMALL OUTLINE PACKAGE



LAND PATTERN EXAMPLE
EXPOSED METAL SHOWN
SCALE: 10X

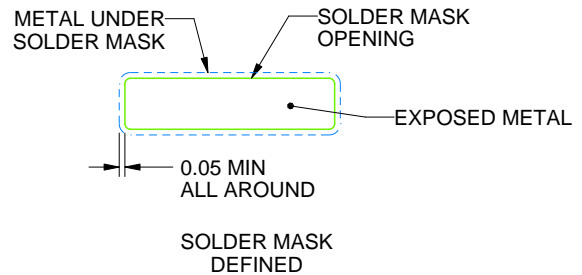
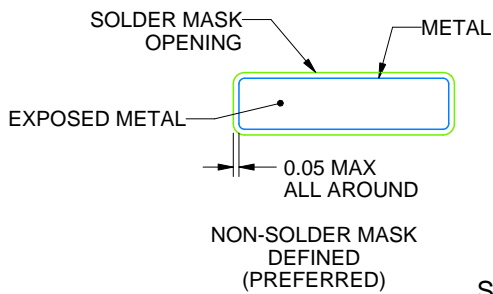

SOLDER MASK DETAILS

4220762/A 05/2024

NOTES: (continued)

5. Publication IPC-7351 may have alternate designs.
6. Solder mask tolerances between and around signal pads can vary based on board fabrication site.

EXAMPLE STENCIL DESIGN

DB0014A

SSOP - 2 mm max height

SMALL OUTLINE PACKAGE



SOLDER PASTE EXAMPLE
BASED ON 0.125 mm THICK STENCIL
SCALE: 10X

4220762/A 05/2024

NOTES: (continued)

7. Laser cutting apertures with trapezoidal walls and rounded corners may offer better paste release. IPC-7525 may have alternate design recommendations.
8. Board assembly site may have different recommendations for stencil design.

GENERIC PACKAGE VIEW

FK 20

LCCC - 2.03 mm max height

8.89 x 8.89, 1.27 mm pitch

LEADLESS CERAMIC CHIP CARRIER

This image is a representation of the package family, actual package may vary.
Refer to the product data sheet for package details.



4229370VA\

J 14

GENERIC PACKAGE VIEW
CDIP - 5.08 mm max height
CERAMIC DUAL IN LINE PACKAGE



Images above are just a representation of the package family, actual package may vary.
Refer to the product data sheet for package details.

4040083-5/G

J0014A



PACKAGE OUTLINE

CDIP - 5.08 mm max height

CERAMIC DUAL IN LINE PACKAGE



4214771/A 05/2017

NOTES:

1. All controlling linear dimensions are in inches. Dimensions in brackets are in millimeters. Any dimension in brackets or parenthesis are for reference only. Dimensioning and tolerancing per ASME Y14.5M.
2. This drawing is subject to change without notice.
3. This package is hermetically sealed with a ceramic lid using glass frit.
4. Index point is provided on cap for terminal identification only and on press ceramic glass frit seal only.
5. Falls within MIL-STD-1835 and GDIP1-T14.

EXAMPLE BOARD LAYOUT

J0014A

CDIP - 5.08 mm max height

CERAMIC DUAL IN LINE PACKAGE



LAND PATTERN EXAMPLE
NON-SOLDER MASK DEFINED
SCALE: 5X





4214771/A 05/2017

D (R-PDSO-G14)

PLASTIC SMALL OUTLINE



- NOTES:
- A. All linear dimensions are in inches (millimeters).
 - B. This drawing is subject to change without notice.
 -  Body length does not include mold flash, protrusions, or gate burrs. Mold flash, protrusions, or gate burrs shall not exceed 0.006 (0,15) each side.
 -  Body width does not include interlead flash. Interlead flash shall not exceed 0.017 (0,43) each side.
 - E. Reference JEDEC MS-012 variation AB.

D (R-PDSO-G14)

PLASTIC SMALL OUTLINE



- NOTES:
- All linear dimensions are in millimeters.
 - This drawing is subject to change without notice.
 - Publication IPC-7351 is recommended for alternate designs.
 - Laser cutting apertures with trapezoidal walls and also rounding corners will offer better paste release. Customers should contact their board assembly site for stencil design recommendations. Refer to IPC-7525 for other stencil recommendations.
 - Customers should contact their board fabrication site for solder mask tolerances between and around signal pads.

N (R-PDIP-T**)

PLASTIC DUAL-IN-LINE PACKAGE

16 PINS SHOWN



- NOTES:
- A. All linear dimensions are in inches (millimeters).
 - B. This drawing is subject to change without notice.
 - C Falls within JEDEC MS-001, except 18 and 20 pin minimum body length (Dim A).
 - D The 20 pin end lead shoulder width is a vendor option, either half or full width.

4040049/E 12/2002

IMPORTANT NOTICE AND DISCLAIMER

TI PROVIDES TECHNICAL AND RELIABILITY DATA (INCLUDING DATA SHEETS), DESIGN RESOURCES (INCLUDING REFERENCE DESIGNS), APPLICATION OR OTHER DESIGN ADVICE, WEB TOOLS, SAFETY INFORMATION, AND OTHER RESOURCES "AS IS" AND WITH ALL FAULTS, AND DISCLAIMS ALL WARRANTIES, EXPRESS AND IMPLIED, INCLUDING WITHOUT LIMITATION ANY IMPLIED WARRANTIES OF MERCHANTABILITY, FITNESS FOR A PARTICULAR PURPOSE OR NON-INFRINGEMENT OF THIRD PARTY INTELLECTUAL PROPERTY RIGHTS.

These resources are intended for skilled developers designing with TI products. You are solely responsible for (1) selecting the appropriate TI products for your application, (2) designing, validating and testing your application, and (3) ensuring your application meets applicable standards, and any other safety, security, regulatory or other requirements.

These resources are subject to change without notice. TI grants you permission to use these resources only for development of an application that uses the TI products described in the resource. Other reproduction and display of these resources is prohibited. No license is granted to any other TI intellectual property right or to any third party intellectual property right. TI disclaims responsibility for, and you will fully indemnify TI and its representatives against, any claims, damages, costs, losses, and liabilities arising out of your use of these resources.

TI's products are provided subject to [TI's Terms of Sale](#) or other applicable terms available either on [ti.com](https://www.ti.com) or provided in conjunction with such TI products. TI's provision of these resources does not expand or otherwise alter TI's applicable warranties or warranty disclaimers for TI products.

TI objects to and rejects any additional or different terms you may have proposed.

Mailing Address: Texas Instruments, Post Office Box 655303, Dallas, Texas 75265
Copyright © 2024, Texas Instruments Incorporated