

LM4938 Boomer™ Audio Power Amplifier Series Stereo 2W Audio Power Amplifiers with DC Volume Control and Selectable Gain

Check for Samples: [LM4938](#)

FEATURES

- Improved Click and Pop Circuitry Virtually Eliminates Noise During Turn On/Off Transitions
- DC Volume Control Interface
- System Beep Detect
- Stereo Switchable Bridged/Single-Ended Power Amplifiers
- Selectable Internal/External Gain and Bass Boost
- Thermal Shutdown Protection Circuitry
- Unity Gain Stable

APPLICATIONS

- Flat Panel Displays
- Portable and Desktop Computers
- Multimedia Monitors
- Portable Radios, PDAs, and Portable TVs

KEY SPECIFICATIONS

- P_O at 1% THD+N
 - into 3 Ω : 2.2W (typ)
 - into 4 Ω : 2.0W (typ)
 - into 8 Ω : 1.3W (typ)
- Single-ended mode
 - THD+N at 92mW into 32 Ω : 1.0% (typ)
- Shutdown Current: 0.5 μ A (typ)

DESCRIPTION

The LM4938 is a monolithic integrated circuit that provides DC volume control, and stereo bridged audio power amplifiers capable of producing 2W into 4 Ω with less than 1.0% THD or 2.2W into 3 Ω with less than 1.0% THD.

Boomer audio integrated circuits were designed specifically to provide high quality audio while requiring a minimum amount of external components. The LM4938 incorporates a DC volume control, stereo bridged audio power amplifiers and a selectable gain or bass boost, making it optimally suited for multimedia monitors, portable radios, desktop, and portable computer applications.

The LM4938 features an externally controlled, low-power consumption shutdown mode, and both a power amplifier and headphone mute for maximum system flexibility and performance.

Note 1: When properly mounted to the circuit board, LM4938MH will deliver 2W into 4 Ω . See [Application Information](#) section [HTSSOP PACKAGE PCB MOUNTING CONSIDERATIONS](#) for more information.

Note 2: An LM4938MH that has been properly mounted to the circuit board and forced-air cooled will deliver 2.2W into 3 Ω .



Please be aware that an important notice concerning availability, standard warranty, and use in critical applications of Texas Instruments semiconductor products and disclaimers thereto appears at the end of this data sheet.

Boomer is a trademark of Texas Instruments.

All other trademarks are the property of their respective owners.

Block Diagram

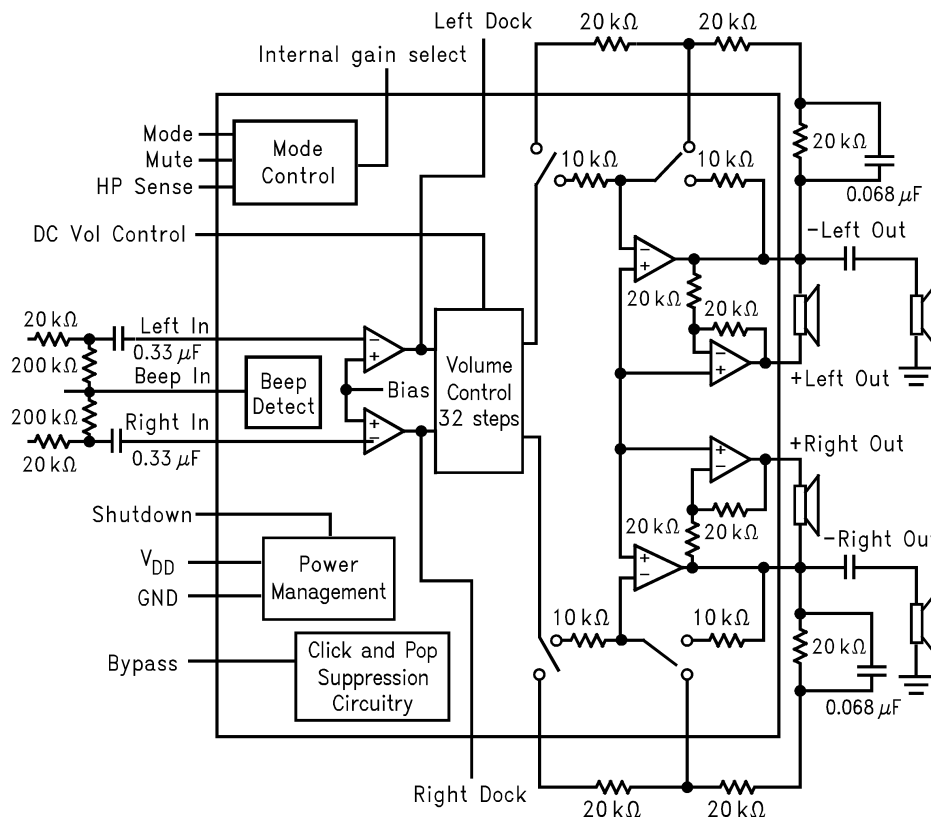
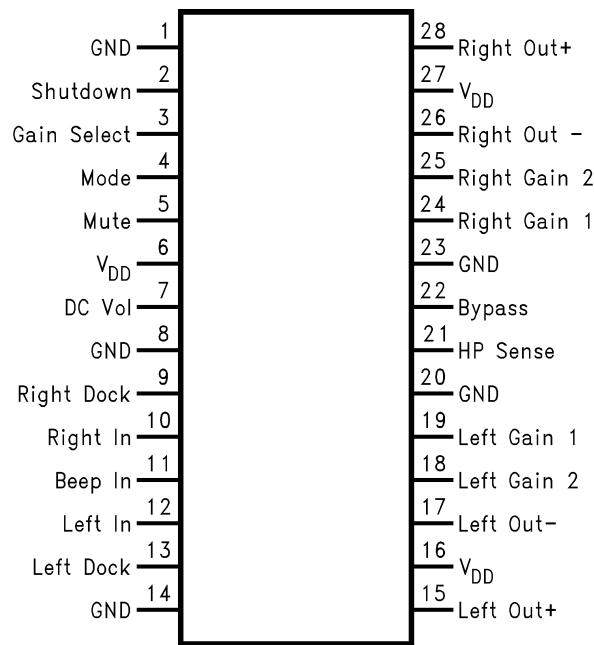

Figure 1. LM4938 Block Diagram

Connection Diagram



**Figure 2. HTSSOP Package (Top View)
See Package Number PWP0028A for HTSSOP**



These devices have limited built-in ESD protection. The leads should be shorted together or the device placed in conductive foam during storage or handling to prevent electrostatic damage to the MOS gates.

Absolute Maximum Ratings⁽¹⁾⁽²⁾

Supply Voltage		6.0V	
Storage Temperature		-65°C to +150°C	
Input Voltage		-0.3V to $V_{DD} + 0.3V$	
Power Dissipation ⁽³⁾		Internally limited	
ESD Susceptibility ⁽⁴⁾		2000V	
ESD Susceptibility ⁽⁵⁾		200V	
Junction Temperature		150°C	
Soldering Information	Small Outline Package	Vapor Phase (60 sec.)	215°C
		Infrared (15 sec.)	220°C
θ_{JC} (typ) - PWP0028A		2°C/W	
θ_{JA} (typ) - PWP0028A (HTSSOP) ⁽⁶⁾		41°C/W	
θ_{JA} (typ) - PWP0028A (HTSSOP) ⁽⁷⁾		54°C/W	
θ_{JA} (typ) - PWP0028A (HTSSOP) ⁽⁸⁾		59°C/W	
θ_{JA} (typ) - PWP0028A(HTSSOP) ⁽⁹⁾		93°C/W	

- (1) *Absolute Maximum Ratings* indicate limits beyond which damage to the device may occur. *Operating Ratings* indicate conditions for which the device is functional, but do not ensure specific performance limits. *Electrical Characteristics* state DC and AC electrical specifications under particular test conditions which ensure specific performance limits. This assumes that the device is within the Operating Ratings. Specifications are not ensured for parameters where no limit is given, however, the typical value is a good indication of device performance.
- (2) If Military/Aerospace specified devices are required, please contact the Texas Instruments Sales Office/ Distributors for availability and specifications.
- (3) The maximum power dissipation must be derated at elevated temperatures and is dictated by T_{JMAX} , θ_{JA} , and the ambient temperature T_A . The maximum allowable power dissipation is $P_{DMAX} = (T_{JMAX} - T_A) / \theta_{JA}$. For the LM4938, $T_{JMAX} = 150^\circ\text{C}$, and the typical junction-to-ambient thermal resistance for each package can be found in the [Absolute Maximum Ratings](#)⁽⁰⁾ section above.
- (4) Human body model, 100pF discharged through a 1.5k Ω resistor.
- (5) Machine Model, 200pF – 220pF discharged through all pins.
- (6) The θ_{JA} given is for an PWP0028A package whose HTSSOP is soldered to an exposed 2in² piece of 1 ounce printed circuit board copper.
- (7) The θ_{JA} given is for an PWP0028A package whose HTSSOP is soldered to a 2in² piece of 1 ounce printed circuit board copper on a bottom side layer through 21 8mil vias.
- (8) The θ_{JA} given is for an PWP0028A package whose HTSSOP is soldered to an exposed 1in² piece of 1 ounce printed circuit board copper.
- (9) The θ_{JA} given is for an PWP0028A package whose HTSSOP is not soldered to any copper.

Operating Ratings

Temperature Range	$T_{MIN} \leq T_A \leq T_{MAX}$	$-20^\circ\text{C} \leq T_A \leq 85^\circ\text{C}$
Supply Voltage		$2.7V \leq V_{DD} \leq 5.5V$

Electrical Characteristics for Entire IC⁽¹⁾⁽²⁾

The following specifications apply for $V_{DD} = 5V$ unless otherwise noted. Limits apply for $T_A = 25^\circ C$.

Symbol	Parameter	Conditions	LM4938		Units (Limits)
			Typical ⁽³⁾	Limit ⁽⁴⁾	
V_{DD}	Supply Voltage			2.7	V (min)
				5.5	V (max)
I_{DD}	Quiescent Power Supply Current	$V_{IN} = 0V, I_O = 0A$	11	30	mA (max)
I_{SD}	Shutdown Current	$V_{shutdown} = V_{DD}$	0.5	2.0	μA (max)
V_{IH}	Headphone Sense High Input Voltage			4	V (min)
V_{IL}	Headphone Sense Low Input Voltage			0.8	V (max)

- (1) All voltages are measured with respect to the ground pins, unless otherwise specified. All specifications are tested using the typical application as shown in [Figure 1](#).
- (2) *Absolute Maximum Ratings* indicate limits beyond which damage to the device may occur. *Operating Ratings* indicate conditions for which the device is functional, but do not ensure specific performance limits. *Electrical Characteristics* state DC and AC electrical specifications under particular test conditions which ensure specific performance limits. This assumes that the device is within the Operating Ratings. Specifications are not ensured for parameters where no limit is given, however, the typical value is a good indication of device performance.
- (3) Typicals are measured at $25^\circ C$ and represent the parametric norm.
- (4) Limits are specified to Texas Instruments' AOQL (Average Outgoing Quality Level). Datasheet min/max specification limits are specified by design, test, or statistical analysis.

Electrical Characteristics for Volume Attenuators⁽¹⁾⁽²⁾

The following specifications apply for $V_{DD} = 5V$. Limits apply for $T_A = 25^\circ C$.

Symbol	Parameter	Conditions	LM4938		Units (Limits)
			Typical ⁽³⁾	Limit ⁽⁴⁾	
C_{RANGE}	Attenuator Range	Gain accuracy with $V_{DCVol} = 5V$, No Load	± 0.5	± 0.75	dB (max)
		Gain accuracy with $V_{DCVol} < 0.5V$, No Load	± 2		dB (max)
		Attenuation with $V_{DCVol} = 0V$ (BM & SE)	89	75	dB (min)
A_M	Mute Attenuation	$V_{mute} = 5V$, Bridged Mode (BM)	89	78	dB (min)
		$V_{mute} = 5V$, Single-Ended Mode (SE)		78	dB (min)

- (1) All voltages are measured with respect to the ground pins, unless otherwise specified. All specifications are tested using the typical application as shown in [Figure 1](#).
- (2) *Absolute Maximum Ratings* indicate limits beyond which damage to the device may occur. *Operating Ratings* indicate conditions for which the device is functional, but do not ensure specific performance limits. *Electrical Characteristics* state DC and AC electrical specifications under particular test conditions which ensure specific performance limits. This assumes that the device is within the Operating Ratings. Specifications are not ensured for parameters where no limit is given, however, the typical value is a good indication of device performance.
- (3) Typicals are measured at $25^\circ C$ and represent the parametric norm.
- (4) Limits are specified to Texas Instruments' AOQL (Average Outgoing Quality Level). Datasheet min/max specification limits are specified by design, test, or statistical analysis.

Electrical Characteristics for Bridged Mode Operation⁽¹⁾⁽²⁾

The following specifications apply for $V_{DD} = 5V$, unless otherwise noted. Limits apply for $T_A = 25^\circ C$.

Symbol	Parameter	Conditions	LM4938		Units (Limits)
			Typical ⁽³⁾	Limit ⁽⁴⁾	
V_{OS}	Output Offset Voltage	$V_{IN} = 0V$, No Load	5	± 50	mV (max)
P_O	Output Power	THD + N = 1.0%; $f = 1kHz$ $R_L = 3\Omega^{(5)}$	2.2		W
		THD + N = 1.0%; $f = 1kHz$ $R_L = 4\Omega^{(6)}$	2		W
		THD = 1% (max); $f = 1kHz$ $R_L = 8\Omega$	1.3	1.0	W (min)
		THD+N = 10%; $f = 1kHz$; $R_L = 8\Omega$	1.5		W
THD+N	Total Harmonic Distortion + Noise	$P_O = 0.4W$, $f = 1kHz$, $R_L = 8\Omega$, $A_{VD} = 2$	0.05		%
PSRR	Power Supply Rejection Ratio	$C_B = 1.0\mu F$, $f = 120Hz$, $V_{RIPPLE} = 200mV_{rms}$; $R_L = 8\Omega$, Floating	78		dB
		$C_B = 1.0\mu F$, $f = 120Hz$, $V_{RIPPLE} = 200mV_{rms}$; $R_L = 8\Omega$, Terminated	60		dB
SNR	Signal to Noise Ratio	$V_{DD} = 5V$, $P_{OUT} = 1.2W$, $R_L = 8\Omega$, A- Wtd Filter, 1kHz	100		dB
X_{talk}	Channel Separation	$f = 1kHz$, $C_B = 1.0\mu F$, 1W	76		dB

- (1) All voltages are measured with respect to the ground pins, unless otherwise specified. All specifications are tested using the typical application as shown in [Figure 1](#).
- (2) *Absolute Maximum Ratings* indicate limits beyond which damage to the device may occur. *Operating Ratings* indicate conditions for which the device is functional, but do not ensure specific performance limits. *Electrical Characteristics* state DC and AC electrical specifications under particular test conditions which ensure specific performance limits. This assumes that the device is within the Operating Ratings. Specifications are not ensured for parameters where no limit is given, however, the typical value is a good indication of device performance.
- (3) Typicals are measured at $25^\circ C$ and represent the parametric norm.
- (4) Limits are specified to Texas Instruments' AOQL (Average Outgoing Quality Level). Datasheet min/max specification limits are specified by design, test, or statistical analysis.
- (5) When driving 3 Ω loads from a 5V supply the LM4938MH must be mounted to the circuit board and forced-air cooled.
- (6) When driving 4 Ω loads from a 5V supply the LM4938MH must be mounted to the circuit board.

Electrical Characteristics for Single-Ended Mode Operation⁽¹⁾⁽²⁾

The following specifications apply for $V_{DD} = 5V$. Limits apply for $T_A = 25^\circ C$.

Symbol	Parameter	Conditions	LM4938		Units (Limits)
			Typical ⁽³⁾	Limit ⁽⁴⁾	
P_O	Output Power	THD = 1.0%; $f = 1kHz$; $R_L = 32\Omega$	92		mW
THD+N	Total Harmonic Distortion + Noise	$V_{OUT} = 1V_{RMS}$, $f = 1kHz$, $R_L = 10k\Omega$, $A_{VD} = 1$	0.065		%
PSRR	Power Supply Rejection Ratio	$C_B = 1.0\mu F$, $f = 120Hz$, $V_{RIPPLE} = 200$ mV_{rms} , Floating	63		dB
		$C_B = 1.0\mu F$, $f = 120Hz$, $V_{RIPPLE} = 200$ mV_{rms} , Terminated	59		dB
SNR	Signal to Noise Ratio	$P_{OUT} = 75mW$, $R_L = 32\Omega$, A-Wtd Filter	100		dB
X_{talk}	Channel Separation	$f = 1kHz$, $C_B = 1.0\mu F$	73		dB

- (1) All voltages are measured with respect to the ground pins, unless otherwise specified. All specifications are tested using the typical application as shown in [Figure 1](#).
- (2) *Absolute Maximum Ratings* indicate limits beyond which damage to the device may occur. *Operating Ratings* indicate conditions for which the device is functional, but do not ensure specific performance limits. *Electrical Characteristics* state DC and AC electrical specifications under particular test conditions which ensure specific performance limits. This assumes that the device is within the Operating Ratings. Specifications are not ensured for parameters where no limit is given, however, the typical value is a good indication of device performance.
- (3) Typicals are measured at $25^\circ C$ and represent the parametric norm.
- (4) Limits are specified to Texas Instruments' AOQL (Average Outgoing Quality Level). Datasheet min/max specification limits are specified by design, test, or statistical analysis.

Truth Table for Logic Inputs⁽⁵⁾

Gain Sel	Mode	Headphone Sense	Mute	Shutdown	Output Stage Set To	DC Volume	Output Stage Configuration
0	0	0	0	0	Internal Gain	Fixed	BTL
0	0	1	0	0	Internal Gain	Fixed	SE
0	1	0	0	0	Internal Gain	Adjustable	BTL
0	1	1	0	0	Internal Gain	Adjustable	SE
1	0	0	0	0	External Gain	Fixed	BTL
1	0	1	0	0	External Gain	Fixed	SE
1	1	0	0	0	External Gain	Adjustable	BTL
1	1	1	0	0	External Gain	Adjustable	SE
X	X	X	1	0	Muted	X	Muted
X	X	X	X	1	Shutdown	X	X

- (5) If system beep is detected on the Beep In pin, the system beep will be passed through the bridged amplifier regardless of the logic of the Mute and HP sense pins.

Typical Performance Characteristics

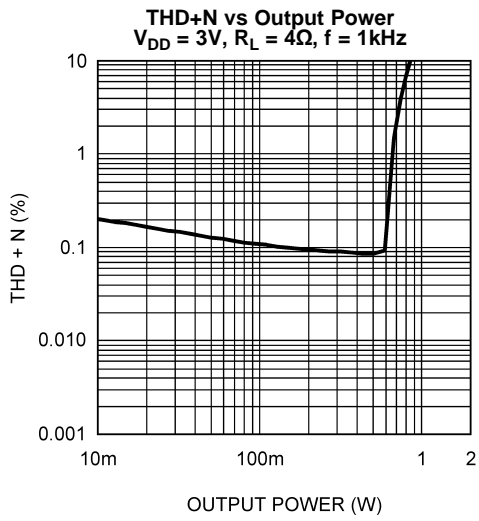

Figure 4.

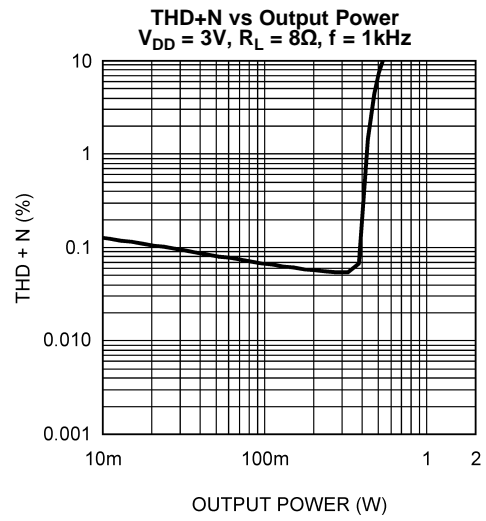

Figure 5.

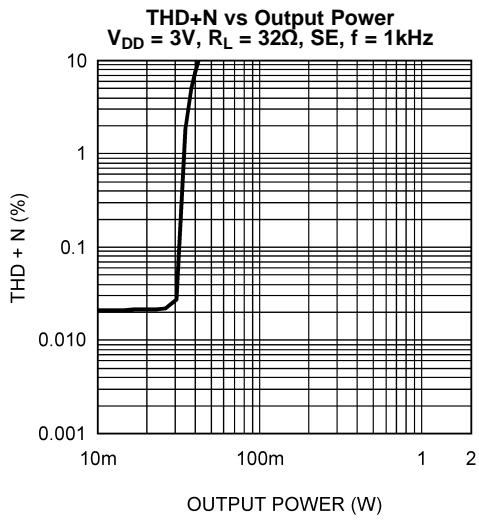

Figure 6.

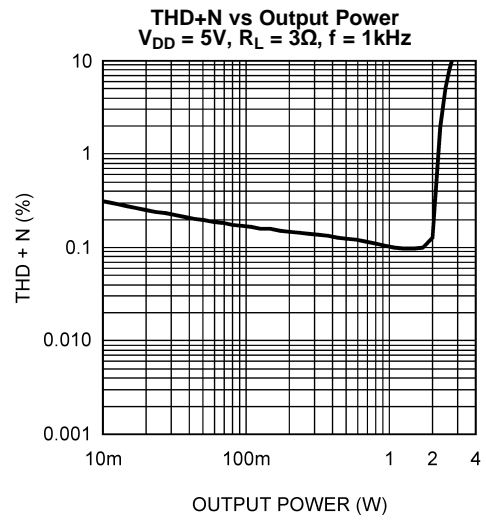

Figure 7.

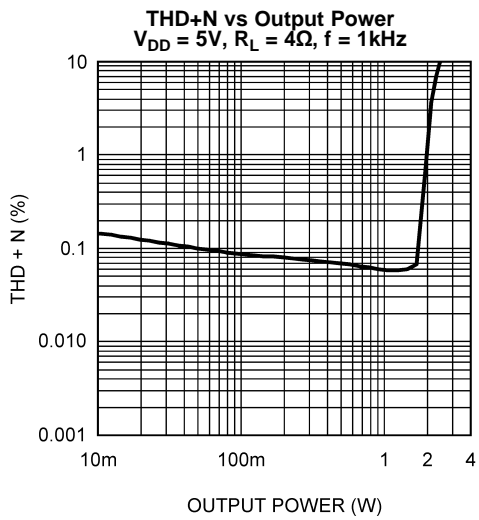

Figure 8.

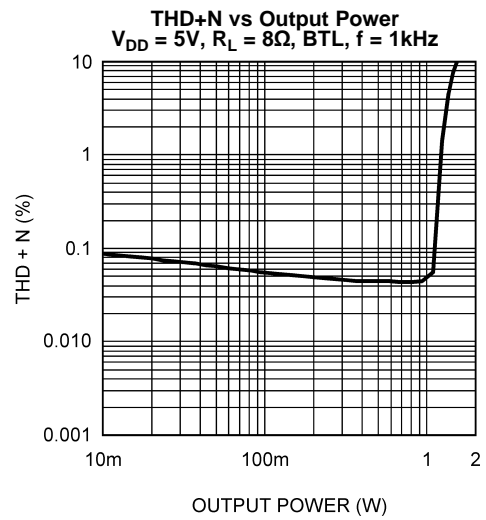

Figure 9.

Typical Performance Characteristics (continued)

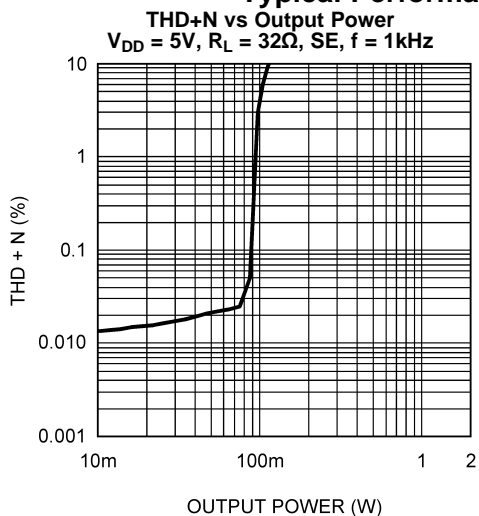

Figure 10.

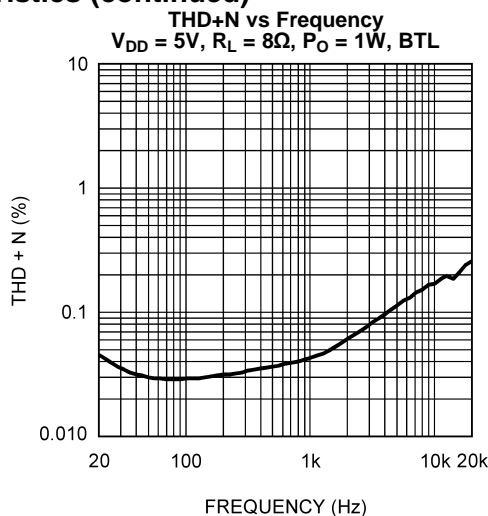

Figure 11.

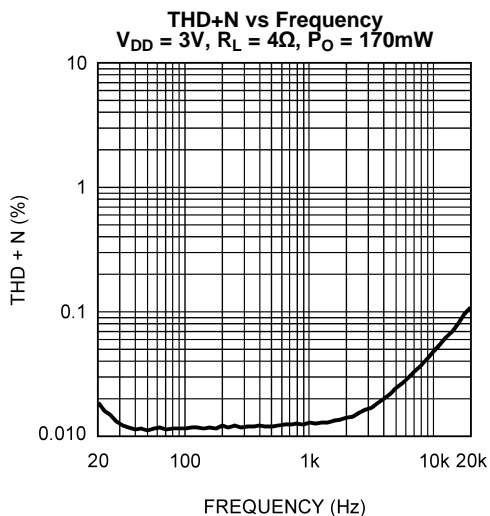

Figure 12.

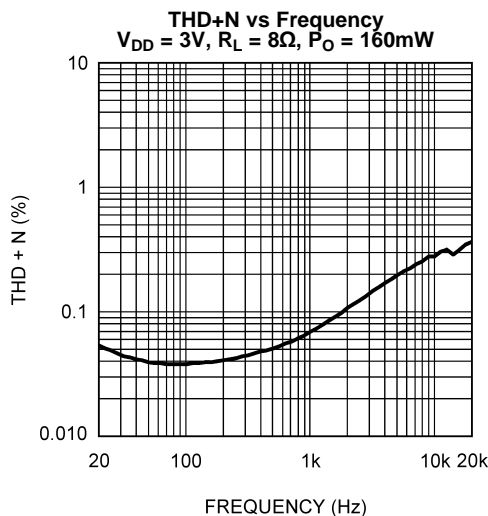

Figure 13.

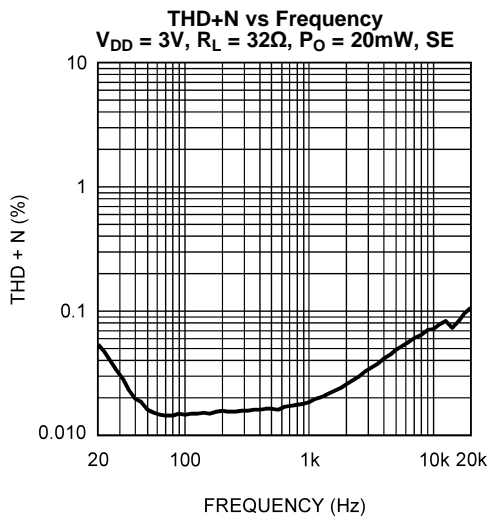

Figure 14.

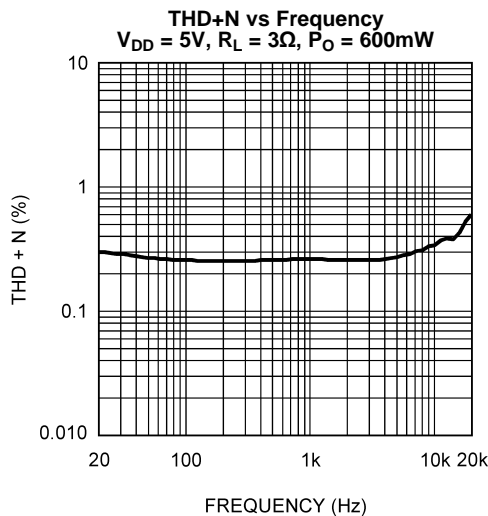

Figure 15.

Typical Performance Characteristics (continued)

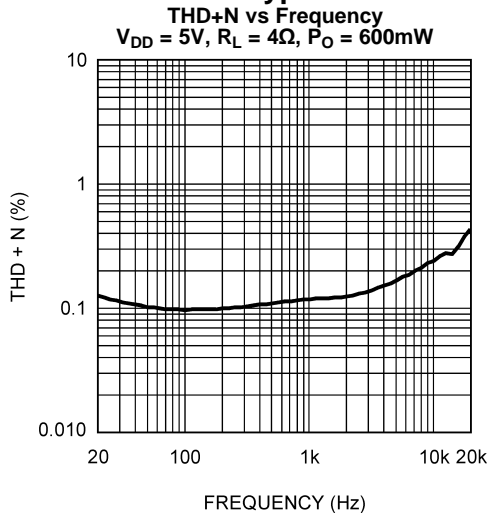

Figure 16.

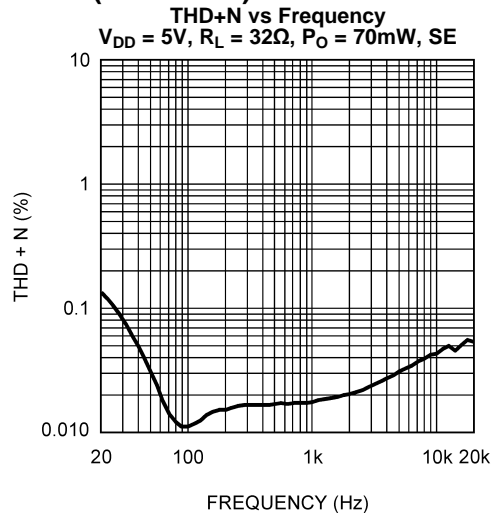

Figure 17.

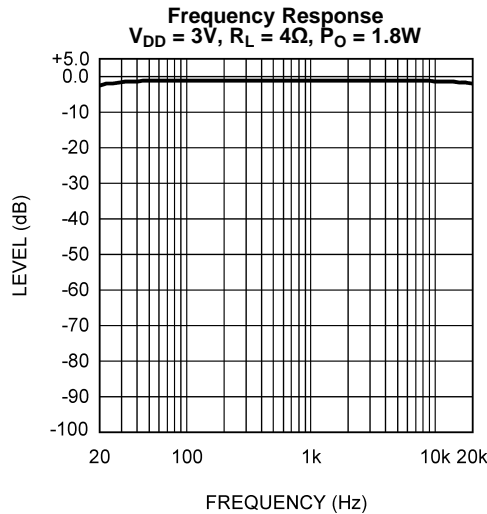

Figure 18.

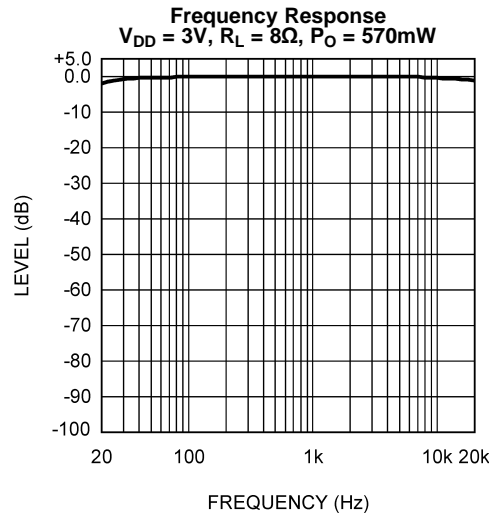

Figure 19.

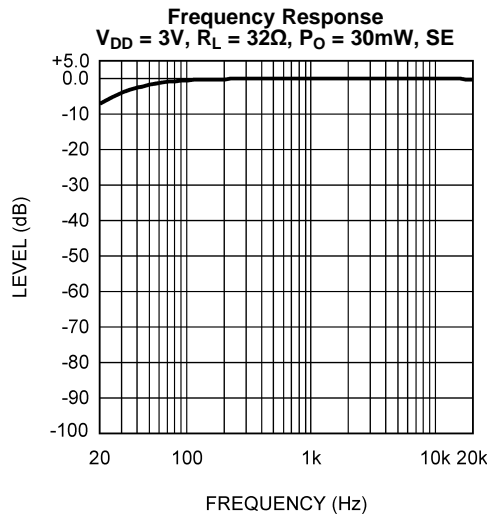

Figure 20.

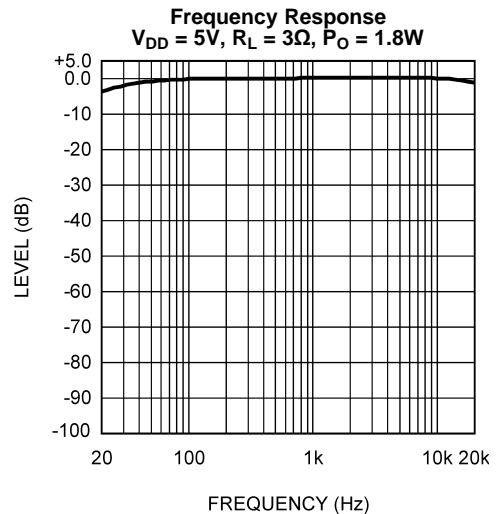

Figure 21.

Typical Performance Characteristics (continued)

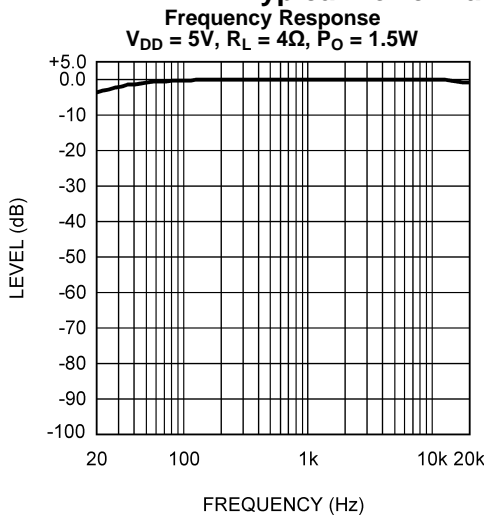

Figure 22.

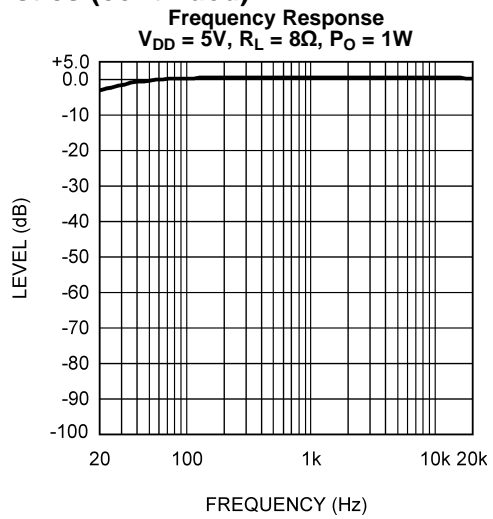

Figure 23.

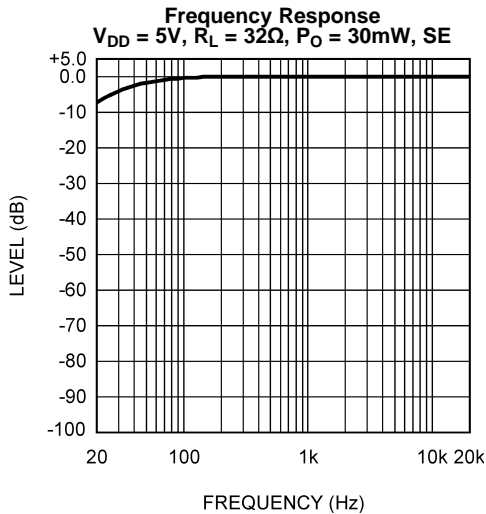

Figure 24.

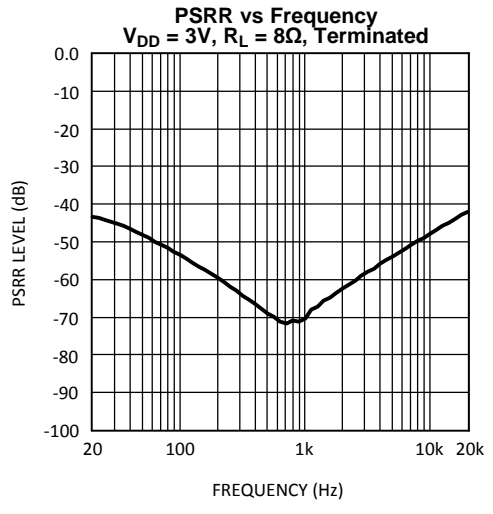

Figure 25.

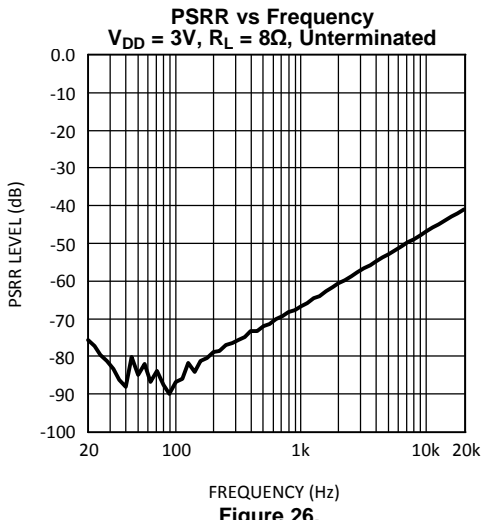

Figure 26.

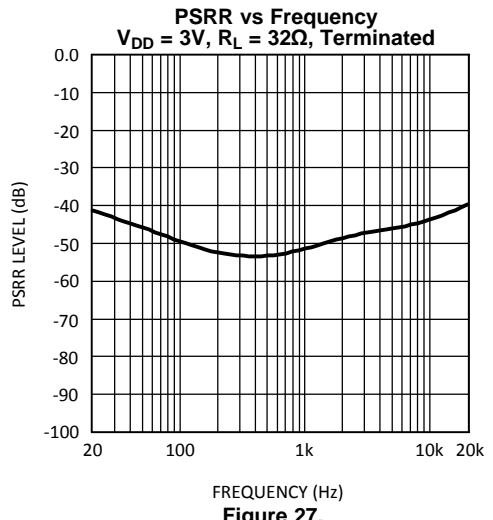

Figure 27.

Typical Performance Characteristics (continued)

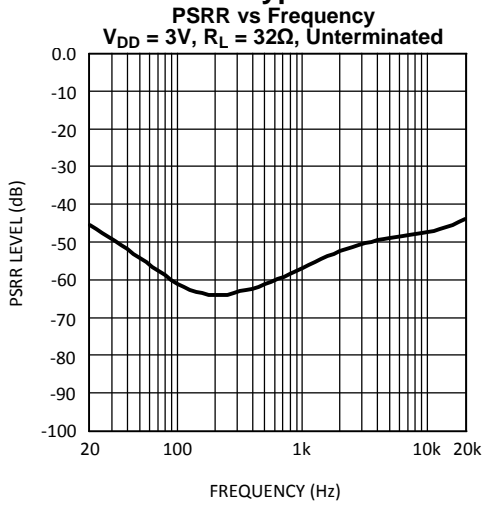

Figure 28.

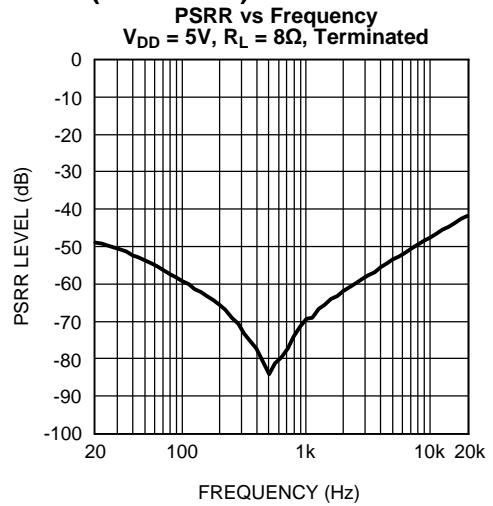

Figure 29.

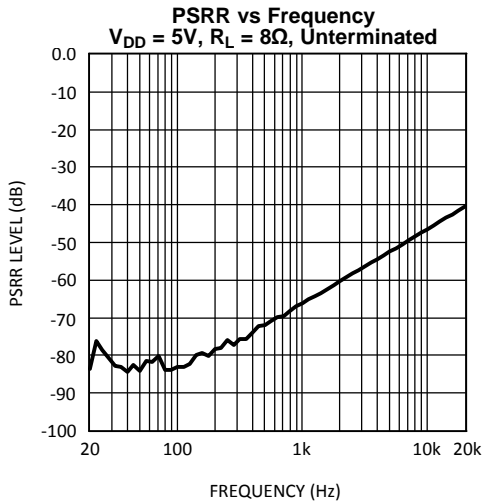

Figure 30.

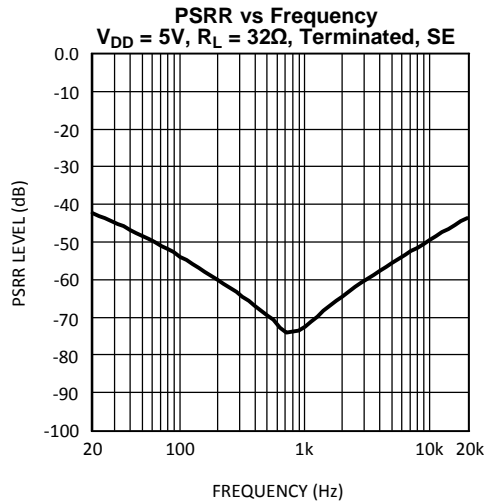

Figure 31.

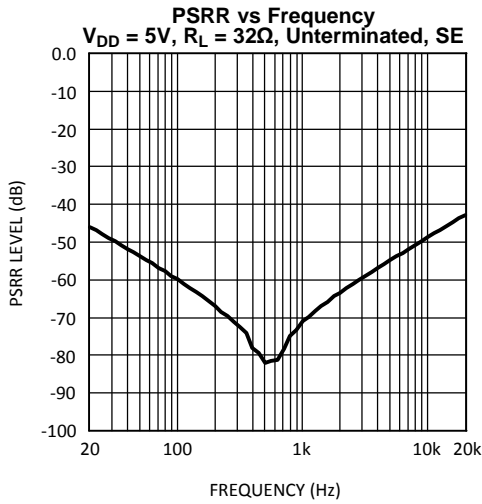

Figure 32.

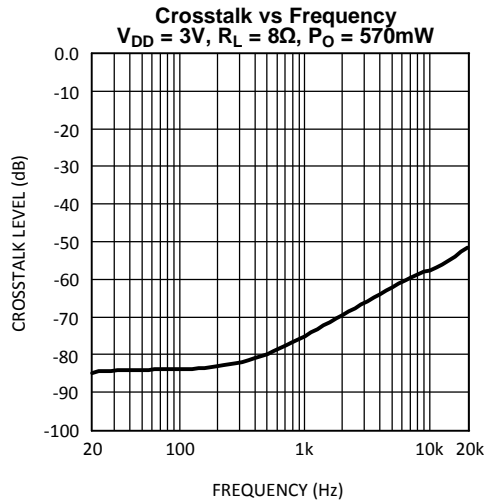

Figure 33.

Typical Performance Characteristics (continued)

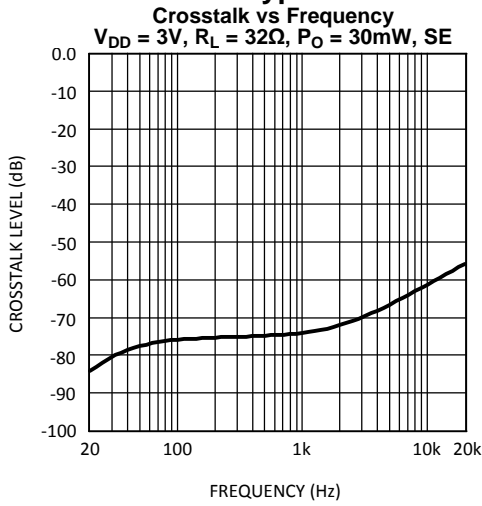

Figure 34.

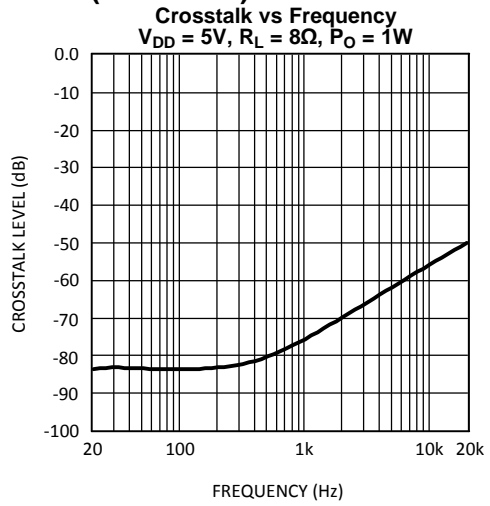

Figure 35.

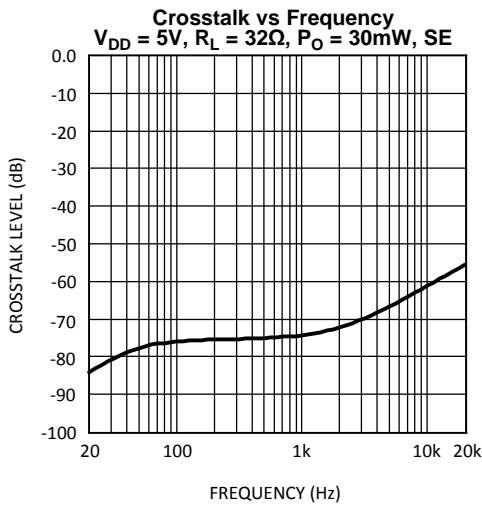

Figure 36.

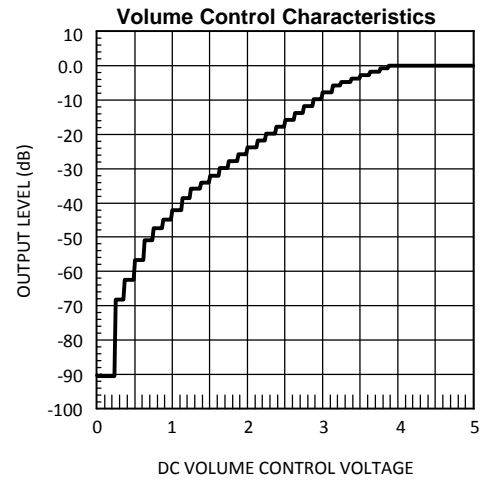

Figure 37.

Typical Performance Characteristics (continued)

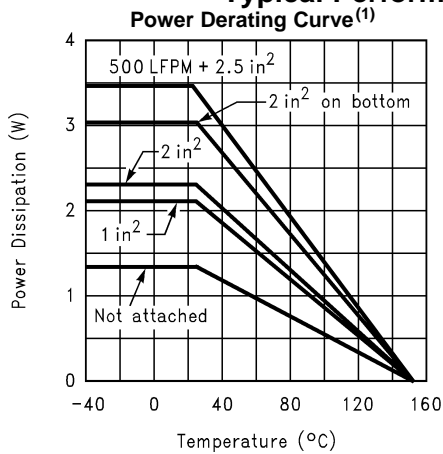

Figure 38.

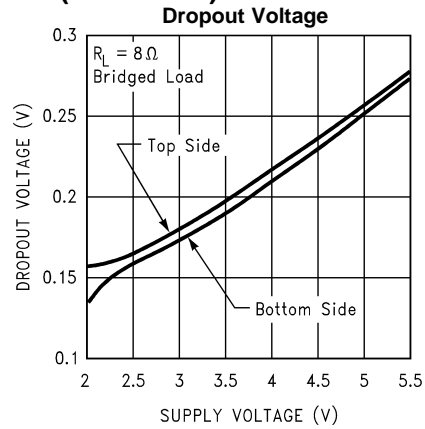

Figure 39.

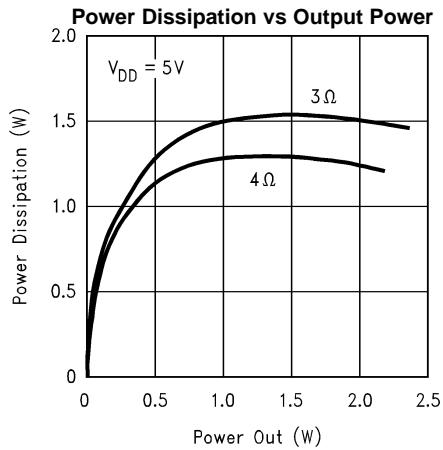

Figure 40.

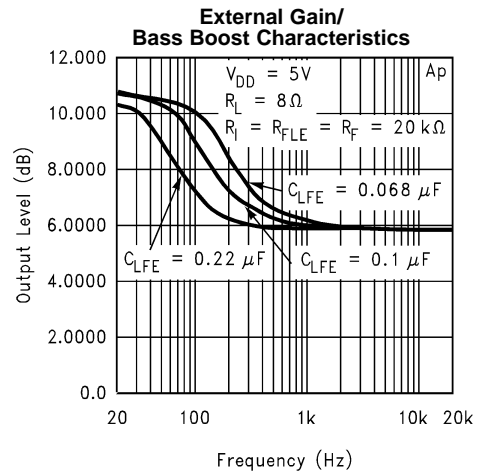

Figure 41.

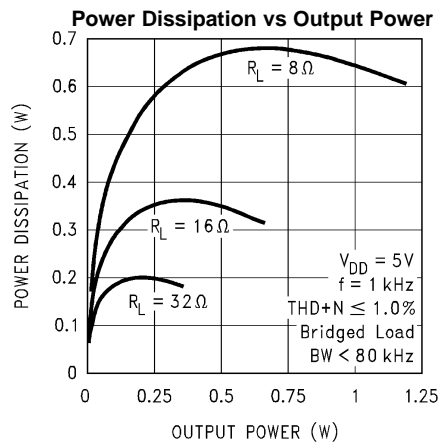

Figure 42.

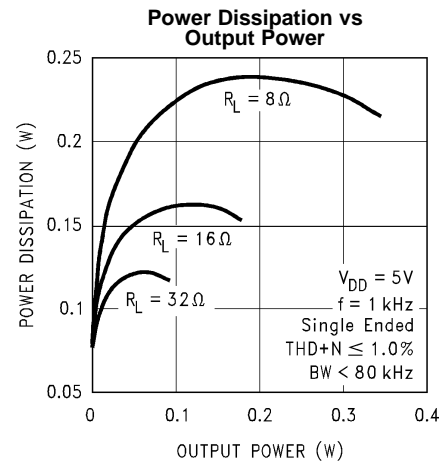

Figure 43.

- (1) These curves show the thermal dissipation ability of the LM4938MH at different ambient temperatures given these conditions:
500LFPM + 2in²: The part is soldered to a 2in², 1 oz. copper plane with 500 linear feet per minute of forced-air flow across it.
2in²on bottom: The part is soldered to a 2in², 1oz. copper plane that is on the bottom side of the PC board through 21 8 mil vias.
2in²: The part is soldered to a 2in², 1oz. copper plane.
1in²: The part is soldered to a 1in², 1oz. copper plane.
Not Attached: The part is not soldered down and is not forced-air cooled.

Typical Performance Characteristics (continued)

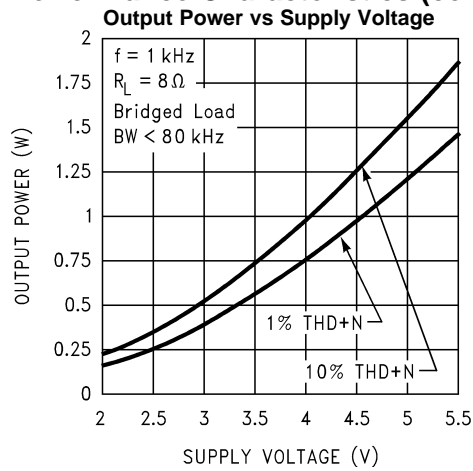

Figure 44.

APPLICATION INFORMATION

HTSSOP PACKAGE PCB MOUNTING CONSIDERATIONS

The LM4938's HTSSOP (die attach paddle) package (MH) provides a low thermal resistance between the die and the PCB to which the part is mounted and soldered. This allows rapid heat transfer from the die to the surrounding PCB copper traces, ground plane and, finally, surrounding air. The result is a low voltage audio power amplifier that produces 2.0W at $\leq 1\%$ THD with a 4 Ω load. This high power is achieved through careful consideration of necessary thermal design. Failing to optimize thermal design may compromise the LM4938's high power performance and activate unwanted, though necessary, thermal shutdown protection.

The MH package must have its exposed DAP soldered to a grounded copper pad on the PCB. The DAP's PCB copper pad is connected to a large grounded plane of continuous unbroken copper. This plane forms a thermal mass heat sink and radiation area. Place the heat sink area on either outside plane in the case of a two-sided PCB, or on an inner layer of a board with more than two layers. Connect the DAP copper pad to the inner layer or backside copper heat sink area with 32(4x8) (MH) vias. The via diameter should be 0.012in–0.013in with a 1.27mm pitch. Ensure efficient thermal conductivity by plating-through and solder-filling the vias.

Best thermal performance is achieved with the largest practical copper heat sink area. If the heatsink and amplifier share the same PCB layer, a nominal 2.5in² (min) area is necessary for 5V operation with a 4 Ω load. Heatsink areas not placed on the same PCB layer as the LM4938 MH package should be 5in² (min) for the same supply voltage and load resistance. The last two area recommendations apply for 25°C ambient temperature. Increase the area to compensate for ambient temperatures above 25°C. In systems using cooling fans, the LM4938MH can take advantage of forced air cooling. With an air flow rate of 450 linear-feet per minute and a 2.5in² exposed copper or 5.0in² inner layer copper plane heatsink, the LM4938MH can continuously drive a 3 Ω load to full power. In all circumstances and conditions, the junction temperature must be held below 150°C to prevent activating the LM4938's thermal shutdown protection. The LM4938's power de-rating curve in the [Typical Performance Characteristics](#) shows the maximum power dissipation versus temperature. Example PCB layouts for the HTSSOP are shown in the **Demonstration Board Layout** section. Further detailed and specific information concerning PCB layout, fabrication, and mounting a package is available in Texas Instruments' AN1187.

PCB LAYOUT AND SUPPLY REGULATION CONSIDERATIONS FOR DRIVING 3 Ω AND 4 Ω LOADS

Power dissipated by a load is a function of the voltage swing across the load and the load's impedance. As load impedance decreases, load dissipation becomes increasingly dependent on the interconnect (PCB trace and wire) resistance between the amplifier output pins and the load's connections. Residual trace resistance causes a voltage drop, which results in power dissipated in the trace and not in the load as desired. For example, 0.1 Ω trace resistance reduces the output power dissipated by a 4 Ω load from 2.1W to 2.0W. This problem of decreased load dissipation is exacerbated as load impedance decreases. Therefore, to maintain the highest load dissipation and widest output voltage swing, PCB traces that connect the output pins to a load must be as wide as possible.

Poor power supply regulation adversely affects maximum output power. A poorly regulated supply's output voltage decreases with increasing load current. Reduced supply voltage causes decreased headroom, output signal clipping, and reduced output power. Even with tightly regulated supplies, trace resistance creates the same effects as poor supply regulation. Therefore, making the power supply traces as wide as possible helps maintain full output voltage swing.

BRIDGE CONFIGURATION EXPLANATION

As shown in [Figure 3](#), the LM4938 output stage consists of two pairs of operational amplifiers, forming a two-channel (channel A and channel B) stereo amplifier. (Though the following discusses channel A, it applies equally to channel B.)

[Figure 3](#) shows that the first amplifier's negative (-) output serves as the second amplifier's input. This results in both amplifiers producing signals identical in magnitude, but 180° out of phase. Taking advantage of this phase difference, a load is placed between –OUTA and +OUTA and driven differentially (commonly referred to as “bridge mode”). This results in a differential gain of

$$A_{VD} = 2 * (R_f/R_i) \quad (1)$$

Bridge mode amplifiers are different from single-ended amplifiers that drive loads connected between a single amplifier's output and ground. For a given supply voltage, bridge mode has a distinct advantage over the single-ended configuration: **its differential output doubles the voltage swing across the load.** This produces four times the output power when compared to a single-ended amplifier under the same conditions. This increase in attainable output power assumes that the amplifier is not current limited or that the output signal is not clipped. To ensure minimum output signal clipping when choosing an amplifier's closed-loop gain, refer to the [AUDIO POWER AMPLIFIER DESIGN](#) section.

Another advantage of the differential bridge output is no net DC voltage across the load. This is accomplished by biasing channel A's and channel B's outputs at half-supply. This eliminates the coupling capacitor that single supply, single-ended amplifiers require. Eliminating an output coupling capacitor in a single-ended configuration forces a single-supply amplifier's half-supply bias voltage across the load. This increases internal IC power dissipation and may permanently damage loads such as speakers.

POWER DISSIPATION

Power dissipation is a major concern when designing a successful single-ended or bridged amplifier. [Equation 2](#) states the maximum power dissipation point for a single-ended amplifier operating at a given supply voltage and driving a specified output load.

$$P_{\text{DMAX}} = (V_{\text{DD}})^2 / (2\pi^2 R_L) \quad \text{Single-Ended} \quad (2)$$

However, a direct consequence of the increased power delivered to the load by a bridge amplifier is higher internal power dissipation for the same conditions.

The LM4938 has two operational amplifiers per channel. The maximum internal power dissipation per channel operating in the bridge mode is four times that of a single-ended amplifier. From [Equation 3](#)), assuming a 5V power supply and a 4Ω load, the maximum single channel power dissipation is 1.27W or 2.54W for stereo operation.

$$P_{\text{DMAX}} = 4 * (V_{\text{DD}})^2 / (2\pi^2 R_L) \quad \text{Bridge Mode} \quad (3)$$

The LM4938's power dissipation is twice that given by [Equation 2](#) or [Equation 3](#) when operating in the single-ended mode or bridge mode, respectively. Twice the maximum power dissipation point given by [Equation 3](#) must not exceed the power dissipation given by [Equation 4](#):

$$P_{\text{DMAX}}' = (T_{\text{JMAX}} - T_A) / \theta_{\text{JA}} \quad (4)$$

The LM4938's $T_{\text{JMAX}} = 150^\circ\text{C}$. In the MH package soldered to a DAP pad that expands to a copper area of 2in^2 on a PCB, the LM4938MH's θ_{JA} is $41^\circ\text{C}/\text{W}$. At any given ambient temperature T_A , use [Equation 4](#) to find the maximum internal power dissipation supported by the IC packaging. Rearranging [Equation 4](#) and substituting P_{DMAX} for P_{DMAX}' results in [Equation 5](#). This equation gives the maximum ambient temperature that still allows maximum stereo power dissipation without violating the LM4938's maximum junction temperature.

$$T_A = T_{\text{JMAX}} - 2 * P_{\text{DMAX}} \theta_{\text{JA}} \quad (5)$$

For a typical application with a 5V power supply and an 4Ω load, the maximum ambient temperature that allows maximum stereo power dissipation without exceeding the maximum junction temperature is approximately 45°C for the MH package.

$$T_{\text{JMAX}} = P_{\text{DMAX}} \theta_{\text{JA}} + T_A \quad (6)$$

[Equation 6](#) gives the maximum junction temperature T_{JMAX} . If the result violates the LM4938's 150°C T_{JMAX} , reduce the maximum junction temperature by reducing the power supply voltage or increasing the load resistance. Further allowance should be made for increased ambient temperatures.

The above examples assume that a device is a surface mount part operating around the maximum power dissipation point. Since internal power dissipation is a function of output power, higher ambient temperatures are allowed as output power or duty cycle decreases.

If the result of [Equation 2](#) is greater than that of [Equation 3](#), then decrease the supply voltage, increase the load impedance, or reduce the ambient temperature. If these measures are insufficient, a heat sink can be added to reduce θ_{JA} . The heat sink can be created using additional copper area around the package, with connections to the ground pin(s), supply pin and amplifier output pins. External, solder attached SMT heatsinks such as the Thermalloy 7106D can also improve power dissipation. When adding a heat sink, the θ_{JA} is the sum of θ_{JC} , θ_{CS} , and θ_{SA} . (θ_{JC} is the junction-to-case thermal impedance, θ_{CS} is the case-to-sink thermal impedance, and θ_{SA} is the sink-to-ambient thermal impedance.) Refer to the [Typical Performance Characteristics](#) curves for power dissipation information at lower output power levels.

POWER SUPPLY BYPASSING

As with any power amplifier, proper supply bypassing is critical for low noise performance and high power supply rejection. Applications that employ a 5V regulator typically use a 10 μF in parallel with a 0.1 μF filter capacitor to stabilize the regulator's output, reduce noise on the supply line, and improve the supply's transient response. However, their presence does not eliminate the need for a local 1.0 μF tantalum bypass capacitance connected between the LM4938's supply pins and ground. Do not substitute a ceramic capacitor for the tantalum. Doing so may cause oscillation. Keep the length of leads and traces that connect capacitors between the LM4938's power supply pin and ground as short as possible. Connecting a 1 μF capacitor, C_B , between the BYPASS pin and ground improves the internal bias voltage's stability and the amplifier's PSRR. The PSRR improvements increase as the BYPASS pin capacitor value increases. Too large a capacitor, however, increases turn-on time and can compromise the amplifier's click and pop performance. The selection of bypass capacitor values, especially C_B , depends on desired PSRR requirements, click and pop performance (as explained in the following section, [SELECTING PROPER EXTERNAL COMPONENTS](#)), system cost, and size constraints.

SELECTING PROPER EXTERNAL COMPONENTS

Optimizing the LM4938's performance requires properly selecting external components. Though the LM4938 operates well when using external components with wide tolerances, best performance is achieved by optimizing component values.

The LM4938 is unity-gain stable, giving a designer maximum design flexibility. The gain should be set to no more than a given application requires. This allows the amplifier to achieve minimum THD+N and maximum signal-to-noise ratio. These parameters are compromised as the closed-loop gain increases. However, low gain circuits demand input signals with greater voltage swings to achieve maximum output power. Fortunately, many signal sources such as audio CODECs have outputs of 1 V_{RMS} (2.83 $V_{\text{P-P}}$). Please refer to the [AUDIO POWER AMPLIFIER DESIGN](#) section for more information on selecting the proper gain.

INPUT CAPACITOR VALUE SELECTION

Amplifying the lowest audio frequencies requires a high value input coupling capacitor (0.33 μF in [Figure 3](#)), but high value capacitors can be expensive and may compromise space efficiency in portable designs. In many cases, however, the speakers used in portable systems, whether internal or external, have little ability to reproduce signals below 150 Hz. Applications using speakers with this limited frequency response reap little improvement by using a large input capacitor.

Besides effecting system cost and size, the input coupling capacitor has an affect on the LM4938's click and pop performance. When the supply voltage is first applied, a transient (pop) is created as the charge on the input capacitor changes from zero to a quiescent state. The magnitude of the pop is directly proportional to the input capacitor's size. Higher value capacitors need more time to reach a quiescent DC voltage (usually $V_{\text{DD}}/2$) when charged with a fixed current. The amplifier's output charges the input capacitor through the feedback resistor, R_f . Thus, pops can be minimized by selecting an input capacitor value that is no higher than necessary to meet the desired -6dB frequency.

As shown in [Figure 3](#), the input resistor (R_{IR} , $R_{\text{IL}} = 20\text{k}$) (and the input capacitor (C_{IR} , $C_{\text{IL}} = 0.33\mu\text{F}$) produce a -6dB high pass filter cutoff frequency that is found using [Equation 7](#).

$$f_{-6\text{ dB}} = \frac{1}{2\pi R_{\text{IN}} C_1} \quad (7)$$

As an example when using a speaker with a low frequency limit of 150Hz, the input coupling capacitor, using [Equation 7](#), is 0.053 μF . The 0.33 μF input coupling capacitor shown in [Figure 3](#) allows the LM4938 to drive a high efficiency, full range speaker whose response extends below 30Hz.

OPTIMIZING CLICK AND POP REDUCTION PERFORMANCE

The LM4938 contains circuitry that minimizes turn-on and shutdown transients or "clicks and pops". For this discussion, turn-on refers to either applying the power supply voltage or when the shutdown mode is deactivated. While the power supply is ramping to its final value, the LM4938's internal amplifiers are configured as unity gain buffers. An internal current source changes the voltage of the BYPASS pin in a controlled, linear manner. Ideally, the input and outputs track the voltage applied to the BYPASS pin. The gain of the internal amplifiers remains

unity until the voltage on the BYPASS pin reaches $1/2 V_{DD}$. As soon as the voltage on the BYPASS pin is stable, the device becomes fully operational. Although the BYPASS pin current cannot be modified, changing the size of C_B alters the device's turn-on time and the magnitude of “clicks and pops”. Increasing the value of C_B reduces the magnitude of turn-on pops. However, this presents a tradeoff: as the size of C_B increases, the turn-on time increases. There is a linear relationship between the size of C_B and the turn-on time.

DOCKING STATION INTERFACE

Applications such as notebook computers can take advantage of a docking station to connect to external devices such as monitors or audio/visual equipment that sends or receives line level signals. The LM4938 has two outputs, Right Dock and Left Dock, which connect to outputs of the internal input amplifiers that drive the volume control inputs. These input amplifiers can drive loads of $>1k\Omega$ (such as powered speakers) with a rail-to-rail signal. Since the output signal present on the RIGHT DOCK and LEFT DOCK pins is biased to $V_{DD}/2$, coupling capacitors should be connected in series with the load when using these outputs. Typical values for the output coupling capacitors are $0.33\mu F$ to $1.0\mu F$. If polarized coupling capacitors are used, connect their “+” terminals to the respective output pin, see [Figure 3](#).

Since the DOCK outputs precede the internal volume control, the signal amplitude will be equal to the input signal's magnitude and cannot be adjusted. However, the input amplifier's closed-loop gain can be adjusted using external resistors. These $20k$ resistors (R_{FR} , R_{FL}) are shown in [Figure 3](#) and they set each input amplifier's gain to -1. Use [Equation 7](#) to determine the input and feedback resistor values for a desired gain.

$$-A_{VR} = R_{FR}/R_{IR} \text{ and } -A_{VL} = R_{FL}/R_{IL} \quad (8)$$

Adjusting the input amplifier's gain sets the minimum gain for that channel. Although the single ended output of the Bridge Output Amplifiers can be used to drive line level outputs, it is recommended that the R & L Dock Outputs simpler signal path be used for better performance.

BEEP DETECT FUNCTION

Computers and notebooks produce a system “beep” signal that drives a small speaker. The speaker's auditory output signifies that the system requires user attention or input. To accommodate this system alert signal, the LM4938's beep input pin is a mono input that accepts the beep signal. Internal level detection circuitry at this input monitors the beep signal's magnitude. When a signal level greater than $V_{DD}/2$ is detected on the BEEP IN pin, the bridge output amplifiers are enabled. The beep signal is amplified and applied to the load connected to the output amplifiers. A valid beep signal will be applied to the load even when MUTE is active. Use the input resistors connected between the BEEP IN pin and the stereo input pins to accommodate different beep signal amplitudes. These resistors (R_{BEEP}) are shown as $200k\Omega$ devices in [Figure 3](#). Use higher value resistors to reduce the gain applied to the beep signal. The resistors must be used to pass the beep signal to the stereo inputs. The BEEP IN pin is used only to detect the beep signal's magnitude: it does not pass the signal to the output amplifiers. The LM4938's shutdown mode must be deactivated before a system alert signal is applied to BEEP IN pin.

If the “Beep” feature is not needed, remove the two Beep Resistors ($200k$) and Beep input capacitor ($.33\mu f$). Then, tie the Beep input pin (#11) to ground. Note that the Beep Circuit is designed to operate with only a square wave input from a control source.

MICRO-POWER SHUTDOWN

The voltage applied to the SHUTDOWN pin controls the LM4938's shutdown function. Activate micro-power shutdown by applying V_{DD} to the SHUTDOWN pin. When active, the LM4938's micro-power shutdown feature turns off the amplifier's bias circuitry, reducing the supply current. The logic threshold is typically $V_{DD}/2$. The low $0.5 \mu A$ typical shutdown current is achieved by applying a voltage that is as near as V_{DD} as possible to the SHUTDOWN pin. A voltage that is less than V_{DD} may increase the shutdown current.

There are a few ways to control the micro-power shutdown. These include using a single-pole, single-throw switch, a microprocessor, or a microcontroller. When using a switch, connect an external 10kΩ pull-up resistor between the SHUTDOWN pin and V_{DD} . Connect the switch between the SHUTDOWN pin and ground. Select normal amplifier operation by closing the switch. Opening the switch connects the SHUTDOWN pin to V_{DD} through the pull-up resistor, activating micro-power shutdown. The switch and resistor ensure that the SHUTDOWN pin will not float. This prevents unwanted state changes. In a system with a microprocessor or a microcontroller, use a digital output to apply the control voltage to the SHUTDOWN pin. Driving the SHUTDOWN pin with active circuitry eliminates the need for a pull up resistor.

MODE FUNCTION

The LM4938's MODE function has 2 states controlled by the voltage applied to the MODE pin. Mode 0, selected by applying 0V to the MODE pin, forces the LM4938 to effectively function as a "line-out," unity-gain amplifier. Mode 1, which uses the internal DC controlled volume control is selected by applying V_{DD} to the MODE pin. This mode sets the amplifier's gain according to the DC voltage applied to the DC VOL CONTROL pin. Unanticipated gain behavior can be prevented by connecting the MODE pin to V_{DD} or ground. Note: Do not let the mode pin float.

MUTE FUNCTION

The LM4938 mutes the amplifier and DOCK outputs when V_{DD} is applied to the MUTE pin. Even while muted, the LM4938 will amplify a system alert (beep) signal whose magnitude satisfies the BEEP DETECT circuitry. Applying 0V to the MUTE pin returns the LM4938 to normal, unmuted operation. Prevent unanticipated mute behavior by connecting the MUTE pin to V_{DD} or ground. Do not let the mute pin float.

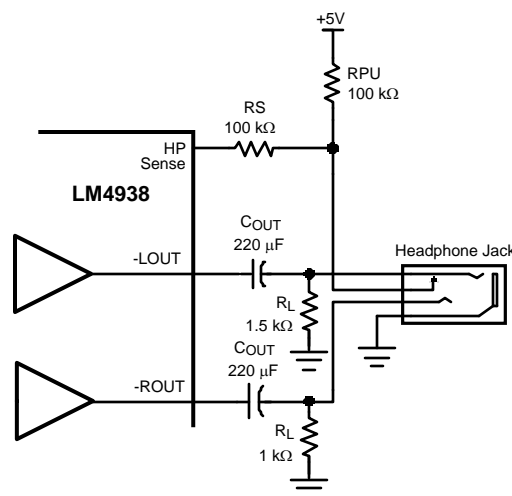

Figure 45. Headphone Sensing Circuit

HP SENSE FUNCTION (Head Phone In)

Applying a voltage between 4V and V_{DD} to the LM4938's HP-IN headphone control pin turns off the amps that drive the Left out "+" and Right out "+" pins. This action mutes a bridged-connected load. Quiescent current consumption is reduced when the IC is in this single-ended mode.

Figure 45 shows the implementation of the LM4938's headphone control function. With no headphones connected to the headphone jack, the R1-R2 voltage divider sets the voltage applied to the HP SENSE pin at approximately 50mV. This 50mV puts the LM4938 into bridged mode operation. The output coupling capacitor blocks the amplifier's half supply DC voltage, protecting the headphones.

The HP-IN threshold is set at 4V. While the LM4938 operates in bridged mode, the DC potential across the load is essentially 0V. Therefore, even in an ideal situation, the output swing cannot cause a false single-ended trigger. Connecting headphones to the headphone jack disconnects the headphone jack contact pin from R2 and allows R1 to pull the HP Sense pin up to V_{DD} through R4. This enables the headphone function, turns off both of the "+" output amplifiers, and mutes the bridged speaker. The remaining single-ended amplifiers then drive the headphones, whose impedance is in parallel with resistors R2 and R3. These resistors have negligible effect on the LM4938's output drive capability since the typical impedance of headphones is 32Ω.

Figure 45 also shows the suggested headphone jack electrical connections. The jack is designed to mate with a three-wire plug. The plug's tip and ring should each carry one of the two stereo output signals, whereas the sleeve should carry the ground return. A headphone jack with one control pin contact is sufficient to drive the HP-IN pin when connecting headphones.

A microprocessor or a switch can replace the headphone jack contact pin. When a microprocessor or switch applies a voltage greater than 4V to the HP-IN pin, a bridge-connected speaker is muted and the single ended output amplifiers 1A and 2A will drive a pair of headphones.

GAIN SELECT FUNCTION (Bass Boost)

The LM4938 features selectable gain, using either internal or external feedback resistors. Either set of feedback resistors set the gain of the output amplifiers. The voltage applied to the GAIN SELECT pin controls which gain is selected. Applying V_{DD} to the GAIN SELECT pin selects the external gain mode. Applying 0V to the GAIN SELECT pin selects the internally set unity gain.

In some cases a designer may want to improve the low frequency response of the bridged amplifier or incorporate a bass boost feature. This bass boost can be useful in systems where speakers are housed in small enclosures. A resistor, R_{LFE} , and a capacitor, C_{LFE} , in parallel, can be placed in series with the feedback resistor of the bridged amplifier as seen in Figure 46.

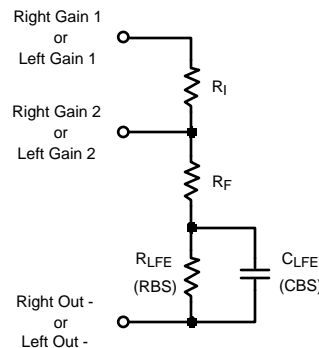

Figure 46. Low Frequency Enhancement

At low, frequencies C_{LFE} is a virtual open circuit and at high frequencies, its nearly zero ohm impedance shorts R_{LFE} . The result is increased bridge-amplifier gain at low frequencies. The combination of R_{LFE} and C_{LFE} form a -6dB corner frequency at

$$f_c = 1/(2\pi R_{LFE} C_{LFE}) \quad (9)$$

The bridged-amplifier low frequency differential gain is:

$$A_{VD} = 2(R_F + R_{LFE}) / R_i \quad (10)$$

Using the component values shown in Figure 1 ($R_F = 20k\Omega$, $R_{LFE} = 20k\Omega$, and $C_{LFE} = 0.068\mu F$), a first-order, -6dB pole is created at 120Hz. Assuming $R_i = 20k\Omega$, the low frequency differential gain is 4. The input (C_i) and output (C_o) capacitor values must be selected for a low frequency response that covers the range of frequencies affected by the desired bass-boost operation.

DC VOLUME CONTROL

The LM4938 has an internal stereo volume control whose setting is a function of the DC voltage applied to the DC VOL CONTROL pin.

The LM4938 volume control consists of 31 steps that are individually selected by a variable DC voltage level on the volume control pin. The range of the steps, controlled by the DC voltage, are from 0dB - 89dB. Each gain step corresponds to a specific input voltage range, as shown in [VOLUME CONTROL TABLE](#).

To minimize the effect of noise on the volume control pin, which can affect the selected gain level, hysteresis has been implemented. The amount of hysteresis corresponds to half of the step width, as shown in Volume Control Characterization Graph (DS200133-40).

For highest accuracy, the voltage shown in the 'recommended voltage' column of the table is used to select a desired gain. This recommended voltage is exactly halfway between the two nearest transitions to the next highest or next lowest gain levels.

The gain levels are 1dB/step from 0dB to -6dB, 2dB/step from -6dB to -36dB, 3dB/step from -36dB to -47dB, 4dB/step from -47dB to -51dB, 5dB/step from -51dB to -66dB, and 12dB to the last step at -89dB.

VOLUME CONTROL TABLE

Gain (dB)	Voltage Range (% of Vdd)			Voltage Range (Vdd = 5)			Voltage Range (Vdd = 3)		
	Low	High	Recommended	Low	High	Recommended	Low	High	Recommended
0	77.5%	100.00%	100.000%	3.875	5.000	5.000	2.325	3.000	3.000
-1	75.0%	78.5%	76.875%	3.750	3.938	3.844	2.250	2.363	2.306
-2	72.5%	76.25%	74.375%	3.625	3.813	3.719	2.175	2.288	2.231
-3	70.0%	73.75%	71.875%	3.500	3.688	3.594	2.100	2.213	2.156
-4	67.5%	71.25%	69.375%	3.375	3.563	3.469	2.025	2.138	2.081
-5	65.0%	68.75%	66.875%	3.250	3.438	3.344	1.950	2.063	2.006
-6	62.5%	66.25%	64.375%	3.125	3.313	3.219	1.875	1.988	1.931
-8	60.0%	63.75%	61.875%	3.000	3.188	3.094	1.800	1.913	1.856
-10	57.5%	61.25%	59.375%	2.875	3.063	2.969	1.725	1.838	1.781
-12	55.0%	58.75%	56.875%	2.750	2.938	2.844	1.650	1.763	1.706
-14	52.5%	56.25%	54.375%	2.625	2.813	2.719	1.575	1.688	1.631
-16	50.0%	53.75%	51.875%	2.500	2.688	2.594	1.500	1.613	1.556
-18	47.5%	51.25%	49.375%	2.375	2.563	2.469	1.425	1.538	1.481
-20	45.0%	48.75%	46.875%	2.250	2.438	2.344	1.350	1.463	1.406
-22	42.5%	46.25%	44.375%	2.125	2.313	2.219	1.275	1.388	1.331
-24	40.0%	43.75%	41.875%	2.000	2.188	2.094	1.200	1.313	1.256
-26	37.5%	41.25%	39.375%	1.875	2.063	1.969	1.125	1.238	1.181
-28	35.0%	38.75%	36.875%	1.750	1.938	1.844	1.050	1.163	1.106
-30	32.5%	36.25%	34.375%	1.625	1.813	1.719	0.975	1.088	1.031
-32	30.0%	33.75%	31.875%	1.500	1.688	1.594	0.900	1.013	0.956
-34	27.5%	31.25%	29.375%	1.375	1.563	1.469	0.825	0.937	0.881
-36	25.0%	28.75%	26.875%	1.250	1.438	1.344	0.750	0.862	0.806
-39	22.5%	26.25%	24.375%	1.125	1.313	1.219	0.675	0.787	0.731
-42	20.0%	23.75%	21.875%	1.000	1.188	1.094	0.600	0.712	0.656
-45	17.5%	21.25%	19.375%	0.875	1.063	0.969	0.525	0.637	0.581
-47	15.0%	18.75%	16.875%	0.750	0.937	0.844	0.450	0.562	0.506
-51	12.5%	16.25%	14.375%	0.625	0.812	0.719	0.375	0.487	0.431
-56.5	10.0%	13.75%	11.875%	0.500	0.687	0.594	0.300	0.412	0.356
-62.5	7.5%	11.25%	9.375%	0.375	0.562	0.469	0.225	0.337	0.281
-68.5	5.0%	8.75%	6.875%	0.250	0.437	0.344	0.150	0.262	0.206
-89	0.0%	6.25%	0.000%	0.000	0.312	0.000	0.000	0.187	0.000

AUDIO POWER AMPLIFIER DESIGN

Audio Amplifier Design: Driving 1W into an 8Ω Load

The following are the desired operational parameters:

Power Output:	1 W _{RMS}
Load Impedance:	8Ω
Input Level:	1 V _{RMS}
Input Impedance:	20 kΩ
Bandwidth:	100 Hz–20 kHz ± 0.25 dB

The design begins by specifying the minimum supply voltage necessary to obtain the specified output power. One way to find the minimum supply voltage is to use the Output Power vs Supply Voltage curve in the [Typical Performance Characteristics](#) section. Another way, using [Equation 10](#), is to calculate the peak output voltage necessary to achieve the desired output power for a given load impedance. To account for the amplifier's dropout voltage, two additional voltages, based on the Dropout Voltage vs Supply Voltage in the [Typical Performance Characteristics](#) curves, must be added to the result obtained by [Equation 10](#). The result is [Equation 11](#).

$$V_{\text{outpeak}} = \sqrt{(2R_L P_O)} \quad (11)$$

$$V_{DD} \geq (V_{\text{OUTPEAK}} + (V_{\text{ODTOP}} + V_{\text{ODBOT}})) \quad (12)$$

The Output Power vs Supply Voltage graph for an 8Ω load indicates a minimum supply voltage of 4.6V. This is easily met by the commonly used 5V supply voltage. The additional voltage creates the benefit of headroom, allowing the LM4938 to produce peak output power in excess of 1W without clipping or other audible distortion. The choice of supply voltage must also not create a situation that violates of maximum power dissipation as explained above in the [POWER DISSIPATION](#) section.

After satisfying the LM4938's power dissipation requirements, the minimum differential gain needed to achieve 1W dissipation in an 8Ω load is found using [Equation 12](#).

$$A_{VD} \geq \sqrt{(P_O R_L)} / (V_{IN}) = V_{\text{orms}} / V_{\text{inrms}} \quad (13)$$

Thus, a minimum overall gain of 2.83 allows the LM4938's to reach full output swing and maintain low noise and THD+N performance.

The last step in this design example is setting the amplifier's –6dB frequency bandwidth. To achieve the desired ±0.25dB pass band magnitude variation limit, the low frequency response must extend to at least one-fifth the lower bandwidth limit and the high frequency response must extend to at least five times the upper bandwidth limit. The gain variation for both response limits is 0.17dB, well within the ±0.25dB desired limit. The results are an

$$f_L = 100\text{Hz}/5 = 20\text{Hz} \quad (14)$$

and an

$$f_H = 20\text{kHz} \times 5 = 100\text{kHz} \quad (15)$$

As mentioned in the [SELECTING PROPER EXTERNAL COMPONENTS](#) section, R_i (Right & Left) and C_i (Right & Left) create a highpass filter that sets the amplifier's lower bandpass frequency limit. Find the input coupling capacitor's value using [Equation 14](#).

$$C_i \geq 1 / (2\pi R_i f_L) \quad (16)$$

The result is

$$1 / (2\pi * 20\text{k}\Omega * 20\text{Hz}) = 0.397\mu\text{F} \quad (17)$$

Use a 0.39μF capacitor, the closest standard value.

The product of the desired high frequency cutoff (100kHz in this example) and the differential gain A_{VD}, determines the upper passband response limit. With A_{VD} = 3 and f_H = 100kHz, the closed-loop gain bandwidth product (GBWP) is 300kHz. This is less than the LM4938's 3.5MHz GBWP. With this margin, the amplifier can be used in designs that require more differential gain while avoiding performance, restricting bandwidth limitations.

Recommended Printed Circuit Board Layout

The following figures show the recommended PC board layouts for the LM4938MH. This circuit is designed for use with an external 5V supply and 4Ω speakers.

This circuit board is easy to use. Apply 5V and ground to the board's V_{DD} and GND pads, respectively. Connect 4Ω speakers between the board's -OUTA and +OUTA and OUTB and +OUTB pads.

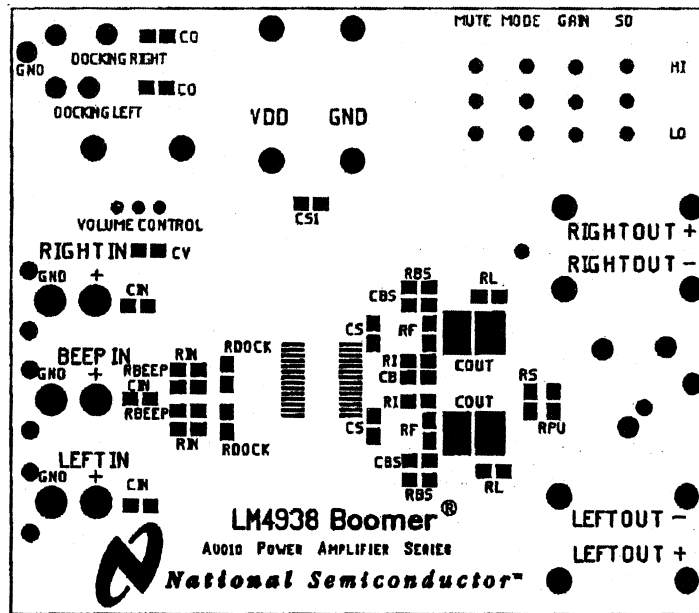

Figure 47. Top Layer Silkscreen

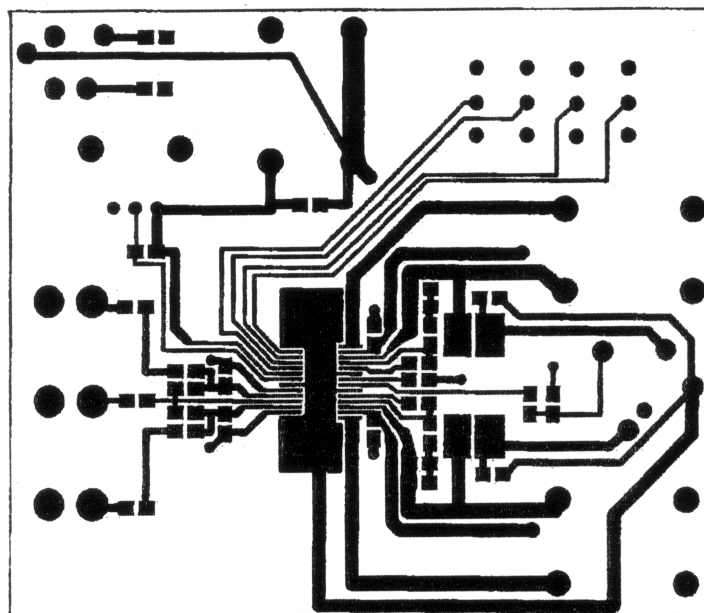

Figure 48. Top Layer TSSOP

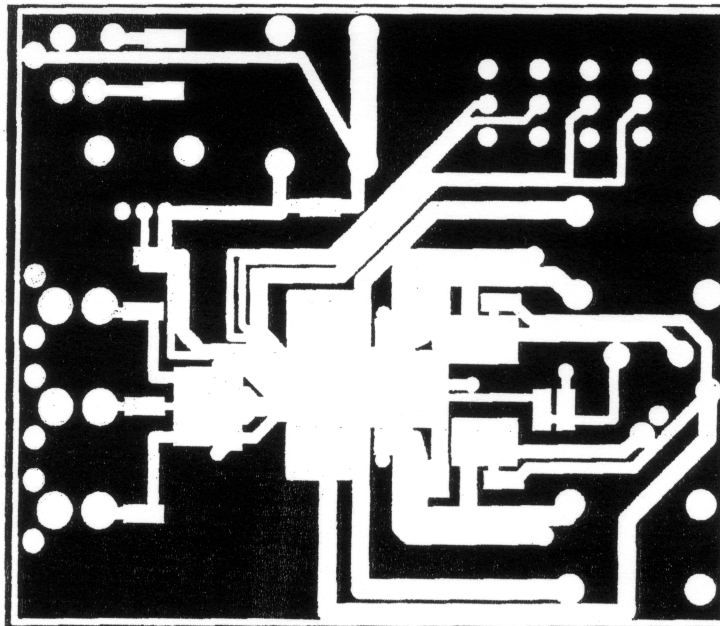

Figure 49. Inner Layer (2)

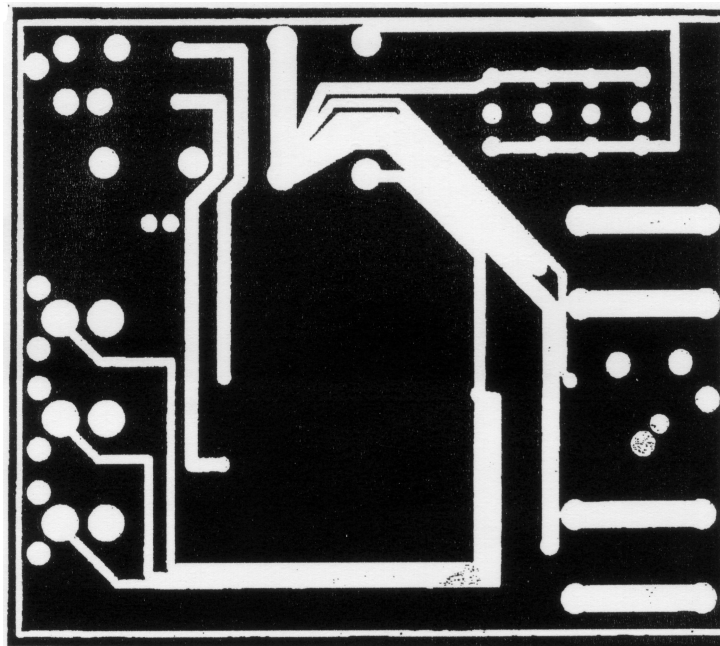

Figure 50. Inner Layer (3)

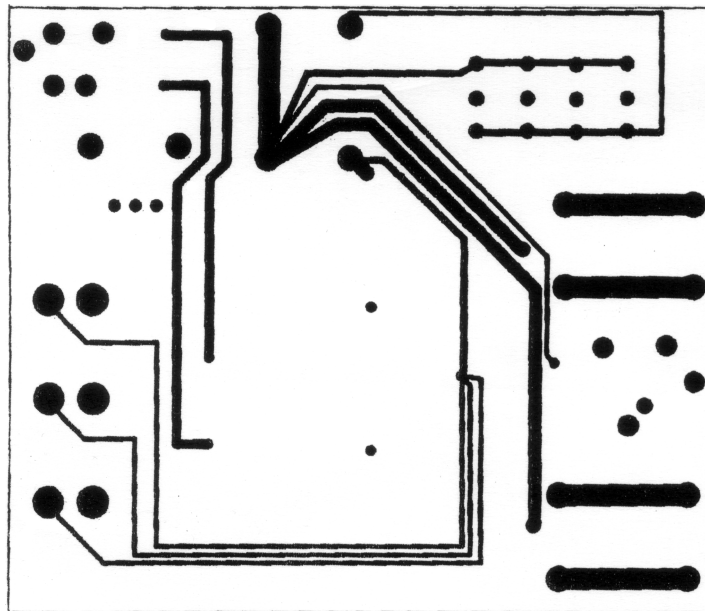

Figure 51. Bottom Layer TSSOP

Analog Audio LM4938 TSSOP Eval Board
Assembly Part Number: 980011373-100
Revision: A
Bill of Material

Item	Part Number	Part Description	Qty	Ref Designator	Remark
1	551011373-001	LM4938 Eval Board PCB etch 001	1		
10	482911373-001	LM4938 TSSOP	1		
20	151911368-001	Cer Cap 0.068 μ F 50V 10% 1206	2	CBS	
25	152911368-001	Tant Cap 0.1 μ F 10V 10% Size = A 3216	3	CS, CS, CV	
26	152911368-002	Tant Cap 0.33 μ F 10V 10% Size = A 3216	3	CIN	
27	152911368-003	Tant Cap 1 μ F 16V 10% Size = A 3216	3	CB, CO1, CO2	
28	152911368-004	Tant Cap 10 μ F 10V 10% Size = C 6032	1	CS1	
29	152911368-005	Tant Cap 220 μ F 16V 10% Size = D 7343	2	CoutL, R	
30	472911368-001	Res 1.5K Ohm 1/8W 1% 1206	2	RL	
31	472911368-002	Res 20K Ohm 1/8W 1% 1206	10	RIN(4), RF(2), RDOCK(2), RBS(2)	
32	472911368-003	Res 100K Ohm 1/8W 1% 1206	2	RPU, RS	
33	472911368-004	Res 200K Ohm 1/16W 1% 0603	2	RBEEP	
40	131911368-001	Stereo Headphone Jack W/ Switch	1		Mouser # 161-3500
41	131911368-002	Slide Switch	4	mute, mode, Gain, SD	Mouser # 10SP003
42	131911368-003	Potentiometer	1	Volume Control	Mouser # 317-2090-100K
43	131911368-004	RCA Jack	3	Right-In, Beep-In, Left-In	Mouser # 16PJ097
44	131911368-005	Banana Jack, Black	3		Mouser # ME164-6219
45	131911368-006	Banana Jack, Red	3		Mouser # ME164-6218

Revision History

Rev	Date	Description
1.0	7/15/05	Added f = 1kHz to the titles on A2, A3, A4, A5, A6, A7, and A8. Re-released D/S to the WEB.
B	5/03/13	Changed layout of National Data Sheet to TI format.

PACKAGING INFORMATION

Orderable Device	Status (1)	Package Type	Package Drawing	Pins	Package Qty	Eco Plan (2)	Lead finish/ Ball material (6)	MSL Peak Temp (3)	Op Temp (°C)	Device Marking (4/5)	Samples
LM4938MH/NOPB	ACTIVE	HTSSOP	PWP	28	48	RoHS & Green	SN	Level-1-260C-UNLIM	-20 to 85	LM4938MH	Samples
LM4938MHX/NOPB	ACTIVE	HTSSOP	PWP	28	2500	RoHS & Green	SN	Level-1-260C-UNLIM	-20 to 85	LM4938MH	Samples

(1) The marketing status values are defined as follows:

ACTIVE: Product device recommended for new designs.

LIFEBUY: TI has announced that the device will be discontinued, and a lifetime-buy period is in effect.

NRND: Not recommended for new designs. Device is in production to support existing customers, but TI does not recommend using this part in a new design.

PREVIEW: Device has been announced but is not in production. Samples may or may not be available.

OBSOLETE: TI has discontinued the production of the device.

(2) **RoHS:** TI defines "RoHS" to mean semiconductor products that are compliant with the current EU RoHS requirements for all 10 RoHS substances, including the requirement that RoHS substance do not exceed 0.1% by weight in homogeneous materials. Where designed to be soldered at high temperatures, "RoHS" products are suitable for use in specified lead-free processes. TI may reference these types of products as "Pb-Free".

RoHS Exempt: TI defines "RoHS Exempt" to mean products that contain lead but are compliant with EU RoHS pursuant to a specific EU RoHS exemption.

Green: TI defines "Green" to mean the content of Chlorine (Cl) and Bromine (Br) based flame retardants meet JS709B low halogen requirements of <=1000ppm threshold. Antimony trioxide based flame retardants must also meet the <=1000ppm threshold requirement.

(3) MSL, Peak Temp. - The Moisture Sensitivity Level rating according to the JEDEC industry standard classifications, and peak solder temperature.

(4) There may be additional marking, which relates to the logo, the lot trace code information, or the environmental category on the device.

(5) Multiple Device Markings will be inside parentheses. Only one Device Marking contained in parentheses and separated by a "~" will appear on a device. If a line is indented then it is a continuation of the previous line and the two combined represent the entire Device Marking for that device.

(6) Lead finish/Ball material - Orderable Devices may have multiple material finish options. Finish options are separated by a vertical ruled line. Lead finish/Ball material values may wrap to two lines if the finish value exceeds the maximum column width.

Important Information and Disclaimer:The information provided on this page represents TI's knowledge and belief as of the date that it is provided. TI bases its knowledge and belief on information provided by third parties, and makes no representation or warranty as to the accuracy of such information. Efforts are underway to better integrate information from third parties. TI has taken and continues to take reasonable steps to provide representative and accurate information but may not have conducted destructive testing or chemical analysis on incoming materials and chemicals. TI and TI suppliers consider certain information to be proprietary, and thus CAS numbers and other limited information may not be available for release.

In no event shall TI's liability arising out of such information exceed the total purchase price of the TI part(s) at issue in this document sold by TI to Customer on an annual basis.

TAPE AND REEL INFORMATION

QUADRANT ASSIGNMENTS FOR PIN 1 ORIENTATION IN TAPE

*All dimensions are nominal

Device	Package Type	Package Drawing	Pins	SPQ	Reel Diameter (mm)	Reel Width W1 (mm)	A0 (mm)	B0 (mm)	K0 (mm)	P1 (mm)	W (mm)	Pin1 Quadrant
LM4938MHX/NOPB	HTSSOP	PWP	28	2500	330.0	16.4	6.95	10.0	1.7	8.0	16.0	Q1

TAPE AND REEL BOX DIMENSIONS



*All dimensions are nominal

Device	Package Type	Package Drawing	Pins	SPQ	Length (mm)	Width (mm)	Height (mm)
LM4938MHX/NOPB	HTSSOP	PWP	28	2500	356.0	356.0	35.0

TUBE

*All dimensions are nominal

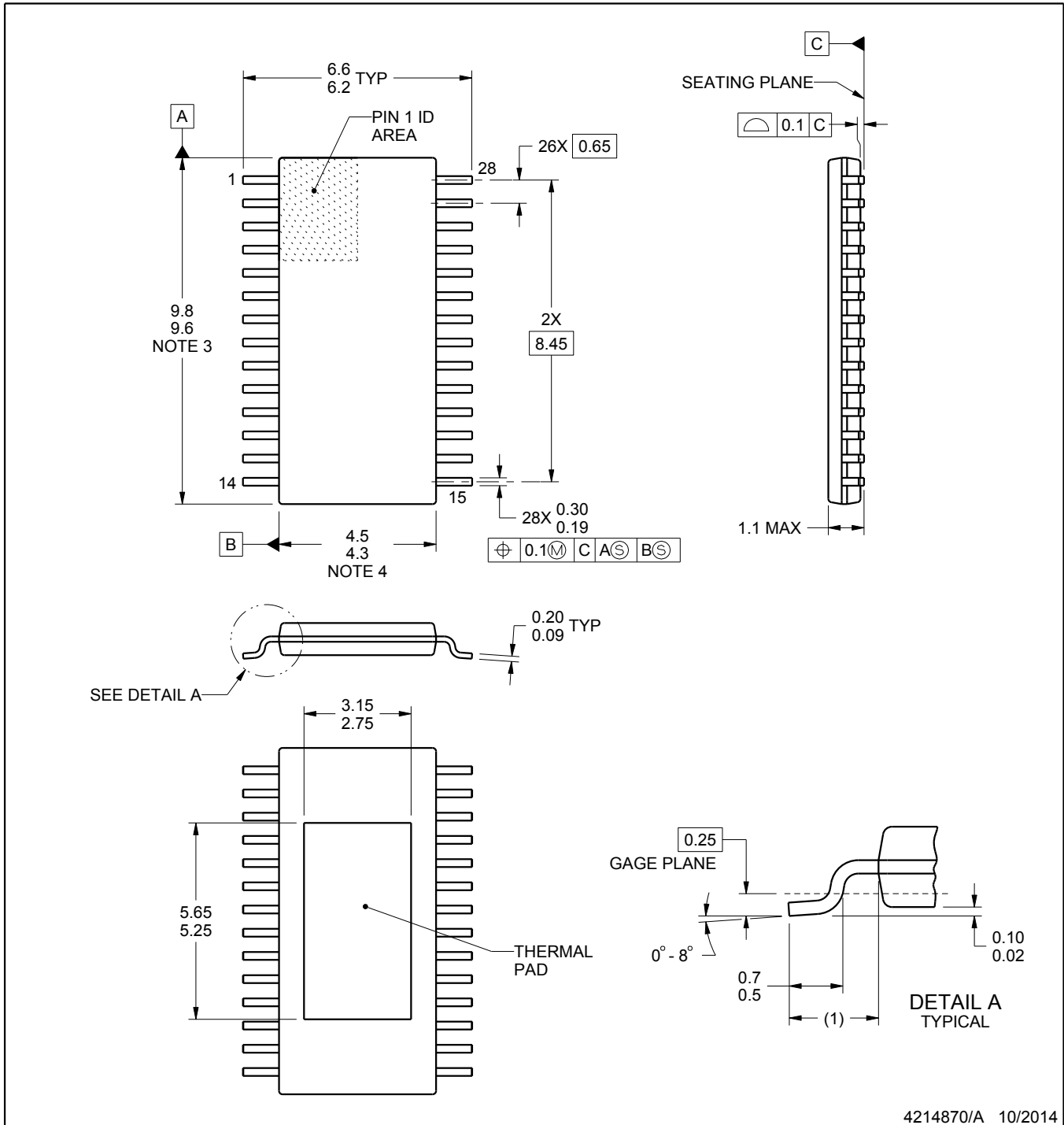
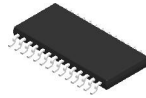
Device	Package Name	Package Type	Pins	SPQ	L (mm)	W (mm)	T (μm)	B (mm)
LM4938MH/NOPB	PWP	HTSSOP	28	48	495	8	2514.6	4.06



4214870/A 10/2014

NOTES:

PowerPAD is a trademark of Texas Instruments.

1. All linear dimensions are in millimeters. Any dimensions in parenthesis are for reference only. Dimensioning and tolerancing per ASME Y14.5M.
2. This drawing is subject to change without notice.
3. This dimension does not include mold flash, protrusions, or gate burrs. Mold flash, protrusions, or gate burrs shall not exceed 0.15 mm, per side.
4. This dimension does not include interlead flash. Interlead flash shall not exceed 0.25 mm, per side.
5. Reference JEDEC registration MO-153, variation AET.

EXAMPLE STENCIL DESIGN

PWP0028A

PowerPAD™ - 1.1 mm max height

PLASTIC SMALL OUTLINE

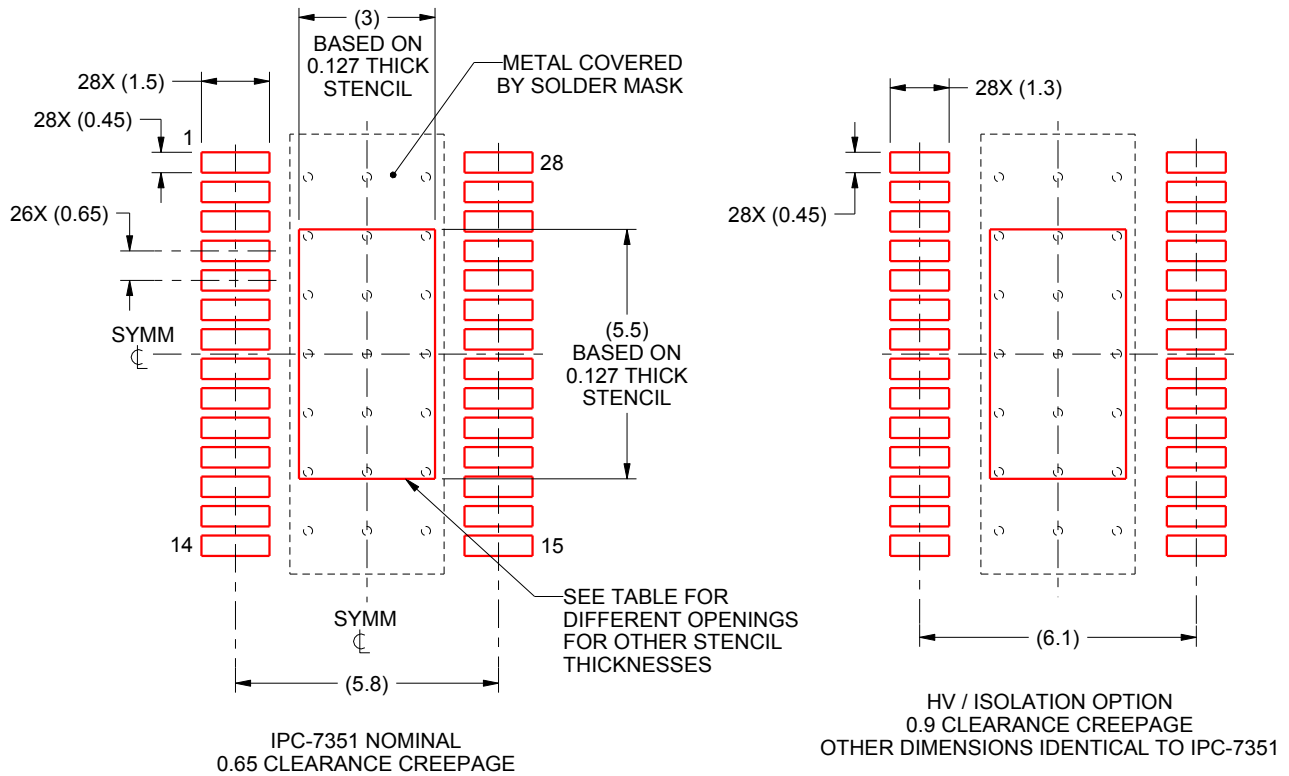

SOLDER PASTE EXAMPLE
 EXPOSED PAD
 100% PRINTED SOLDER COVERAGE AREA
 SCALE:6X

STENCIL THICKNESS	SOLDER STENCIL OPENING
0.1	3.55 X 6.37
0.127	3.0 X 5.5 (SHOWN)
0.152	2.88 X 5.16
0.178	2.66 X 4.77

4214870/A 10/2014

NOTES: (continued)

- 10. Laser cutting apertures with trapezoidal walls and rounded corners may offer better paste release. IPC-7525 may have alternate design recommendations.
- 11. Board assembly site may have different recommendations for stencil design.

IMPORTANT NOTICE AND DISCLAIMER

TI PROVIDES TECHNICAL AND RELIABILITY DATA (INCLUDING DATA SHEETS), DESIGN RESOURCES (INCLUDING REFERENCE DESIGNS), APPLICATION OR OTHER DESIGN ADVICE, WEB TOOLS, SAFETY INFORMATION, AND OTHER RESOURCES "AS IS" AND WITH ALL FAULTS, AND DISCLAIMS ALL WARRANTIES, EXPRESS AND IMPLIED, INCLUDING WITHOUT LIMITATION ANY IMPLIED WARRANTIES OF MERCHANTABILITY, FITNESS FOR A PARTICULAR PURPOSE OR NON-INFRINGEMENT OF THIRD PARTY INTELLECTUAL PROPERTY RIGHTS.

These resources are intended for skilled developers designing with TI products. You are solely responsible for (1) selecting the appropriate TI products for your application, (2) designing, validating and testing your application, and (3) ensuring your application meets applicable standards, and any other safety, security, regulatory or other requirements.

These resources are subject to change without notice. TI grants you permission to use these resources only for development of an application that uses the TI products described in the resource. Other reproduction and display of these resources is prohibited. No license is granted to any other TI intellectual property right or to any third party intellectual property right. TI disclaims responsibility for, and you will fully indemnify TI and its representatives against, any claims, damages, costs, losses, and liabilities arising out of your use of these resources.

TI's products are provided subject to [TI's Terms of Sale](#) or other applicable terms available either on [ti.com](https://www.ti.com) or provided in conjunction with such TI products. TI's provision of these resources does not expand or otherwise alter TI's applicable warranties or warranty disclaimers for TI products.

TI objects to and rejects any additional or different terms you may have proposed.

Mailing Address: Texas Instruments, Post Office Box 655303, Dallas, Texas 75265
Copyright © 2024, Texas Instruments Incorporated