

# LMR16006Y-Q1 SIMPLE SWITCHER® Buck Regulators With High-Efficiency ECO Mode

## 1 Features

- LMR16006Y-Q1 is an Automotive Grade Product that is a AEC-Q100 Grade 1 Qualified (-40°C to +125°C Operating Junction Temperature)
- Input Voltage Range 4 V to 40 V with Transient Up to 65 V
- Output Current up to 600 mA
- 2.1 MHz Switching Frequency
- Ultra Low 28  $\mu$ A Standby Current in ECO Mode
- 1  $\mu$ A Shutdown Current
- High Duty Cycle Operation Supported
- ADJ, Fixed 3.3 V and Fixed 5 V Output Option
- Internal Compensation
- High Voltage Enable Input
- Internal Soft Start
- Over Current Protection
- Over Temperature Protection
- Small Overall Solution Size (SOT-6L Package)

## 2 Applications

- Automotive
- Battery Powered Equipment
- Industrial Distributed Power Systems
- Portable Handheld Instruments
- Portable Media Players
- Aftermarket Automotive Accessories: Video, GPS, Entertainment

## 4 Simplified Schematic

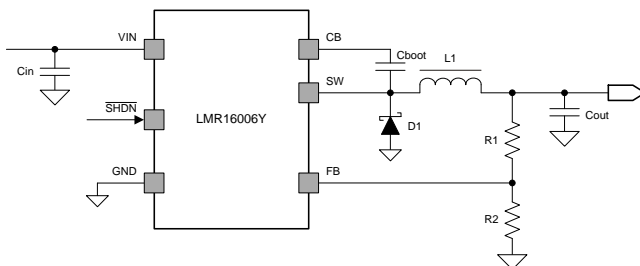

## 3 Description

The LMR16006Y-Q1 is a PWM DC-DC buck (step-down) regulator. It is suitable for a wide range of application from industrial to automotive for power conditioning from an unregulated source. The regulator's standby current is 28  $\mu$ A in ECO mode, which is suitable for battery operating systems. An ultra-low 1  $\mu$ A shutdown current can further prolong battery life. Operating frequency is fixed at 2.1 MHz allowing the use of small external components while still being able to have low output ripple voltage. Soft-start and compensation circuits are implemented internally, which allows the device to be used with minimized external components. The LMR16006Y-Q1 is optimized for up to 600 mA load currents. It has a 0.765 V typical feedback voltage. The device has built-in protection features such as pulse by pulse current limit, thermal sensing and shutdown due to excessive power dissipation. The LMR16006Y-Q1 is available in a low profile SOT-6L package (2.9 mm x 1.6 mm).

### Device Information<sup>(1)</sup>

PART NUMBER	PACKAGE	OUTPUT VOLTAGE
LMR16006YQ	SOT (6)	Adjustable
LMR16006YQ3		Fixed 3.3 V
LMR16006YQ5		Fixed 5 V

(1) For all available packages, see the orderable addendum at the end of the datasheet.

### Efficiency vs Output Current ( $f_{SW}$ = 2.1 MHz, $V_{OUT}$ = 3.3 V)

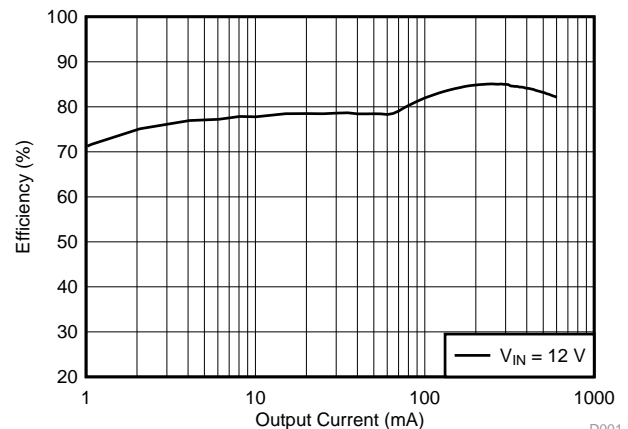

D001



## Table of Contents

<b>1 Features</b> .....	<b>1</b>	8.3 Feature Description .....	<b>8</b>
<b>2 Applications</b> .....	<b>1</b>	8.4 Device Functional Modes .....	<b>9</b>
<b>3 Description</b> .....	<b>1</b>	<b>9 Application and Implementation</b> .....	<b>10</b>
<b>4 Simplified Schematic</b> .....	<b>1</b>	9.1 Application Information .....	<b>10</b>
<b>5 Revision History</b> .....	<b>2</b>	9.2 Typical Application .....	<b>10</b>
<b>6 Pin Configuration and Functions</b> .....	<b>3</b>	<b>10 Power Supply Recommendations</b> .....	<b>14</b>
<b>7 Specifications</b> .....	<b>4</b>	<b>11 Layout</b> .....	<b>15</b>
7.1 Absolute Maximum Ratings .....	<b>4</b>	11.1 Layout Guidelines .....	<b>15</b>
7.2 ESD Ratings .....	<b>4</b>	11.2 Layout Example .....	<b>15</b>
7.3 Recommended Operating Conditions .....	<b>4</b>	<b>12 Device and Documentation Support</b> .....	<b>16</b>
7.4 Thermal Information .....	<b>4</b>	12.1 Related Documentation .....	<b>16</b>
7.5 Electrical Characteristics .....	<b>5</b>	12.2 Community Resources .....	<b>16</b>
7.6 Switching Characteristics .....	<b>5</b>	12.3 Trademarks .....	<b>16</b>
7.7 Typical Characteristics .....	<b>6</b>	12.4 Electrostatic Discharge Caution .....	<b>16</b>
<b>8 Detailed Description</b> .....	<b>7</b>	12.5 Glossary .....	<b>16</b>
8.1 Overview .....	<b>7</b>	<b>13 Mechanical, Packaging, and Orderable Information</b> .....	<b>16</b>
8.2 Functional Block Diagram .....	<b>7</b>		

## 5 Revision History

DATE	REVISION	NOTES
June 2015	*	Initial release.

## 6 Pin Configuration and Functions

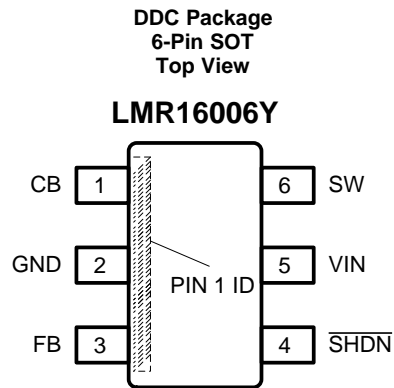

### Pin Functions

PIN		I/O	DESCRIPTION
NAME	NUMBER		
CB	1	I	Switch FET gate bias voltage. Connect $C_{boot}$ capacitor between CB and SW.
GND	2	G	Ground connection.
FB	3	I	Feedback Input. Set feedback voltage divider ratio with $V_{OUT} = V_{FB} (1 + (R1/R2))$ .
$\overline{\text{SHDN}}$	4	I	Enable and disable input (high voltage tolerant). Internal pull-up current source. Pull below 1.25 V to disable. Float to enable. Establish input undervoltage lockout with two resistor divider.
VIN	5	I	Power input voltage pin. Input for internal supply and drain node input for internal high-side MOSFET.
SW	6	O	Switch node. Connect to inductor, diode, and $C_{boot}$ capacitor.

## 7 Specifications

### 7.1 Absolute Maximum Ratings <sup>(1)</sup>

		MIN	MAX	UNIT
Input voltages	V <sub>IN</sub> to GND	-0.3	65	V
	$\overline{\text{SHDN}}$ to GND	-0.3	65	
	FB to GND	-0.3	7	
	CB to SW	-0.3	7	
Output voltages	SW to GND	-1	60	V
	SW to GND less than 30 ns transients	-2	60	
T <sub>J</sub> Operation junction temperature		-40	150	°C
Storage temperature, T <sub>stg</sub>		-55	165	°C

(1) Stresses beyond those listed under *Absolute Maximum Ratings* may cause permanent damage to the device. These are stress ratings only, which do not imply functional operation of the device at these or any other conditions beyond those indicated under *Recommended Operating Conditions*. Exposure to absolute-maximum-rated conditions for extended periods may affect device reliability.

### 7.2 ESD Ratings

		VALUE	UNIT
V <sub>(ESD)</sub> Electrostatic discharge	Human-body model (HBM), per AEC Q100-002 <sup>(1)</sup>	±2000	V
	Charged-device model (CDM), per AEC Q100-011	±500	

(1) AEC Q100-002 indicates that HBM stressing shall be in accordance with the ANSI/ESDA/JEDEC JS-001 specification.

### 7.3 Recommended Operating Conditions

over operating free-air temperature range (unless otherwise noted) <sup>(1)</sup>

		MIN	MAX	UNIT
Buck regulator	V <sub>IN</sub>	4	40	V
	CB	4	46	
	CB to SW	-0.3	6	
	SW	-1	40	
	FB	0	5.5	
Control	$\overline{\text{SHDN}}$	0	40	
Temperature	Operating junction temperature range, T <sub>J</sub>	-40	125	°C

(1) Stresses beyond those listed under *Absolute Maximum Ratings* may cause permanent damage to the device. These are stress ratings only, which do not imply functional operation of the device at these or any other conditions beyond those indicated under *Recommended Operating Conditions*. Exposure to absolute-maximum-rated conditions for extended periods may affect device reliability.

### 7.4 Thermal Information

over operating free-air temperature range (unless otherwise noted)

THERMAL METRIC <sup>(1)</sup>		LMR16006Y-Q1	UNIT
		DDC (SOT)	
		(6 PINS)	
R <sub>θJA</sub>	Junction-to-ambient thermal resistance	102	°C/W
R <sub>θJctop</sub>	Junction-to-case (top) thermal resistance	36.9	
R <sub>θJB</sub>	Junction-to board characterization parameter	28.4	

(1) All numbers apply for packages soldered directly onto a 3" x 3" PC board with 2 oz. copper on 4 layers in still air in accordance to JEDEC standards. Thermal resistance varies greatly with layout, copper thickness, number of layers in PCB, power distribution, number of thermal vias, board size, ambient temperature, and air flow.

## 7.5 Electrical Characteristics

Limits apply over the recommended operating junction temperature ( $T_J$ ) range of  $-40^{\circ}\text{C}$  to  $+125^{\circ}\text{C}$ , unless otherwise stated. Minimum and Maximum limits are specified through test, design or statistical correlation. Typical values represent the most likely parametric norm at  $T_J = 25^{\circ}\text{C}$ , and are provided for reference purposes only. Unless otherwise specified, the following conditions apply:  $V_{IN} = \overline{\text{SHDN}} = 12\text{ V}$ .

PARAMETER		TEST CONDITIONS	MIN	TYP	MAX	UNIT
<b><math>V_{IN}</math> (INPUT POWER SUPPLY)</b>						
$V_{IN}$	Operating input voltage		4		40	V
$I_{\text{SHDN}}$	Shutdown supply current	$V_{\text{EN}} = 0\text{ V}$		1	3	$\mu\text{A}$
$I_Q$	Operating quiescent current (non-switching)	no load, $V_{IN} = 12\text{ V}$		28		$\mu\text{A}$
UVLO	Undervoltage lockout thresholds	Rising threshold			4	V
		Falling threshold	3			
<b><math>\overline{\text{SHDN}}</math></b>						
$V_{\text{SHDN\_Thre}}$	Rising $\overline{\text{SHDN}}$ Threshold Voltage		1.05	1.25	1.38	V
$I_{\text{SHDN}}$	Input current	$\overline{\text{SHDN}} = 2.3\text{ V}$		-4.2		$\mu\text{A}$
		$\overline{\text{SHDN}} = 0.9\text{ V}$		-1		
$I_{\text{SHDN\_HYS}}$	Hysteresis current			-3		$\mu\text{A}$
<b>HIGH-SIDE MOSFET</b>						
$R_{\text{DS\_ON}}$	On-resistance	$V_{IN} = 12\text{ V}$ , CB to SW = 5.8 V		900		m $\Omega$
<b>VOLTAGE REFERENCE (FB PIN)</b>						
$V_{\text{FB}}$	Feedback voltage		0.747	0.765	0.782	V
$V_{\text{OUT}}$	Output voltage	Fixed 3.3 V output version	3.201	3.3	3.399	V
		Fixed 5 V output version	4.85	5	5.15	V
<b>CURRENT LIMIT</b>						
$I_{\text{LIMIT}}$	Peak current limit	$V_{IN} = 12\text{ V}$ , $T_J = 25^{\circ}\text{C}$		1200	1700	mA
<b>THERMAL PERFORMANCE</b>						
$T_{\text{SHDN}}^{(1)}$	Thermal shutdown threshold			170		$^{\circ}\text{C}$
$T_{\text{HYS}}^{(1)}$	Hysteresis			10		$^{\circ}\text{C}$

(1) Ensured by design.

## 7.6 Switching Characteristics

over operating free-air temperature range (unless otherwise noted)

PARAMETER		TEST CONDITIONS	MIN	TYP	MAX	UNIT
<b>SW (SW PIN)</b>						
$f_{\text{SW}}$	Switching frequency		1785	2100	2415	kHz
$T_{\text{ON\_MIN}}^{(1)}$	Minimum turn-on time	$f_{\text{SW}} = 2.1\text{ MHz}$		80		ns
$D_{\text{MAX}}$	Maximum duty cycle			97%		

(1) Ensured by design.

## 7.7 Typical Characteristics

Unless otherwise specified the following conditions apply:  $V_{IN} = 12\text{ V}$ ,  $f_{SW} = 2100\text{ kHz}$ ,  $L1 = 6.8\text{ }\mu\text{H}$ ,  $C_{out} = 10\text{ }\mu\text{F}$ ,  $T_A = 25^\circ\text{C}$ .

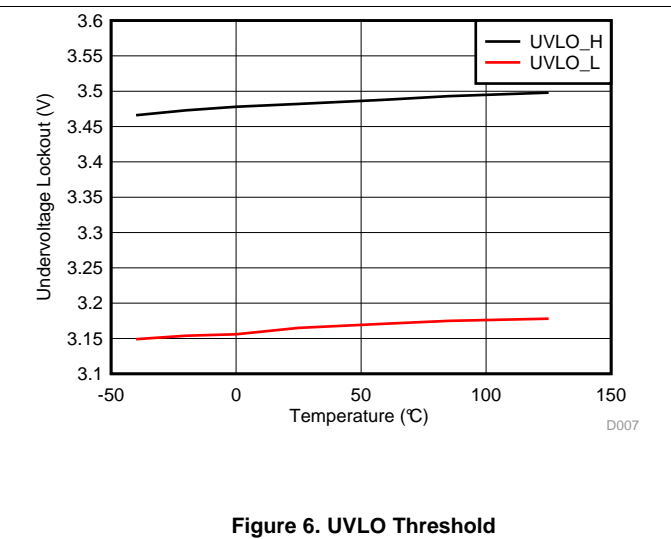
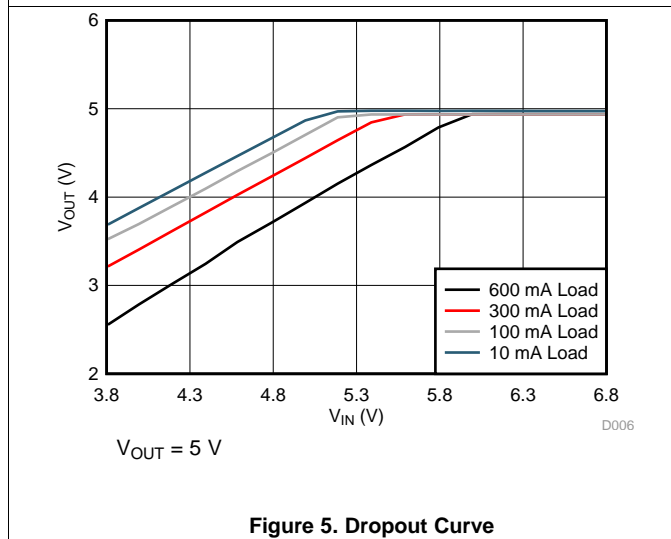
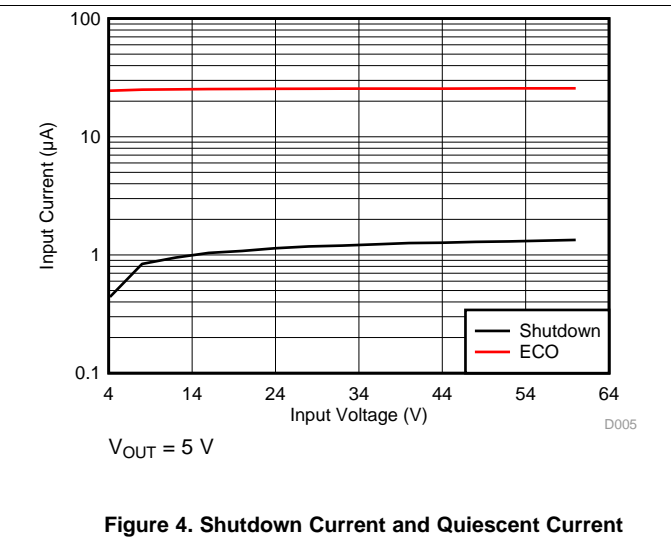
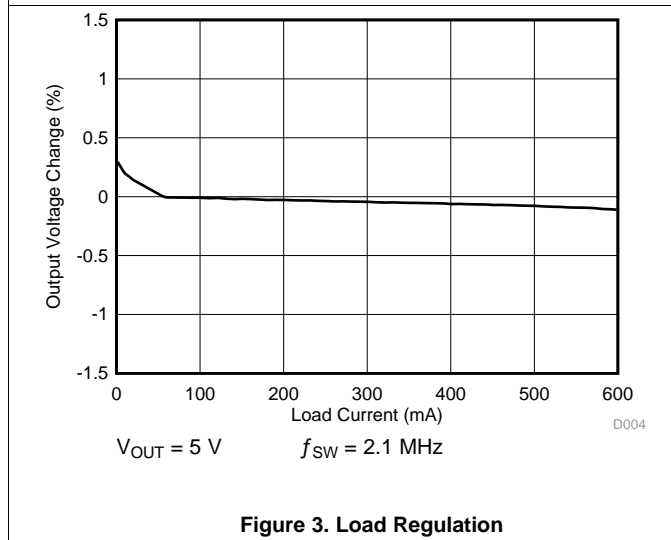
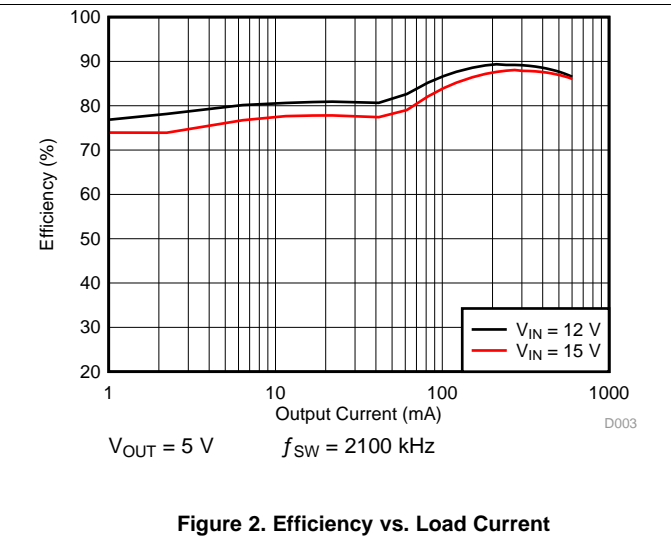
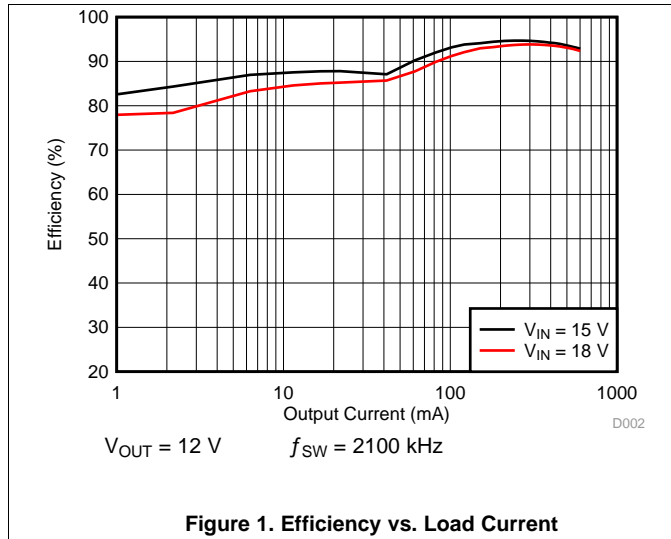



## 8.3 Feature Description

### 8.3.1 Fixed Frequency PWM Control

The LMR16006Y-Q1 implements peak current mode control. The output voltage is compared through external resistors on the FB pin to an internal voltage reference by an error amplifier which drives the internal COMP node. An internal oscillator initiates the turn on of the high side power switch. The error amplifier output is compared to the high side power switch current. When the power switch current reaches the level set by the internal COMP voltage, the power switch is turned off. The internal COMP node voltage will increase and decrease as the output current increases and decreases. The device implements a current limit by clamping the COMP node voltage to a maximum level.

### 8.3.2 Bootstrap Voltage (CB)

The LMR16006Y-Q1 has an integrated boot regulator, and requires a small ceramic capacitor between the CB and SW pins to provide the gate drive voltage for the high side MOSFET. The CB capacitor is refreshed when the high side MOSFET is off and the low side diode conducts. To improve drop out, the LMR16006Y-Q1 is designed to operate at 97% duty cycle as long as the CB to SW pin voltage is greater than 3 V. When the voltage from CB to SW drops below 3 V, the high side MOSFET is turned off using an UVLO circuit which allows the low side diode to conduct and refresh the charge on the CB capacitor. Since the supply current sourced from the CB capacitor is low, the high side MOSFET can remain on for more switching cycles than are required to refresh the capacitor, thus the effective duty cycle of the switching regulator is high. Attention must be taken in maximum duty cycle applications with light load. To ensure SW can be pulled to ground to refresh the CB capacitor, an internal circuit will charge the CB capacitor when the load is light or the device is working in dropout condition.

### 8.3.3 Output Voltage Setting

The output voltage is set using the feedback pin and a resistor divider connected to the output as shown on the front page schematic. The feedback pin voltage 0.765 V, so the ratio of the feedback resistors sets the output voltage according to the following equation:  $V_{OUT} = 0.765 \text{ V} (1 + (R1/R2))$ . Typically R2 will be given as 1 k $\Omega$  to 100 k $\Omega$  for a starting value. To solve for R1 given R2 and  $V_{OUT}$  use  $R1 = R2 ((V_{OUT}/0.765 \text{ V}) - 1)$ .

### 8.3.4 Enable $\overline{\text{SHDN}}$ and VIN Undervoltage Lockout

LMR16006Y-Q1  $\overline{\text{SHDN}}$  pin is a high voltage tolerant input with an internal pull up circuit. The device can be enabled even if the  $\overline{\text{SHDN}}$  pin is floating. The regulator can also be turned on using 1.23 V or higher logic signals. If the use of a higher voltage is desired due to system or other constraints, a 100 k $\Omega$  or larger resistor is recommended between the applied voltage and the  $\overline{\text{SHDN}}$  pin to protect the device. When  $\overline{\text{SHDN}}$  is pulled down to 0 V, the chip is turned off and enters the lowest shutdown current mode. In shutdown mode the supply current will be decreased to approximately 1  $\mu\text{A}$ . If the shutdown function is not to be used the  $\overline{\text{SHDN}}$  pin may be tied to  $V_{IN}$  via 100 k $\Omega$  resistor. The maximum voltage to the  $\overline{\text{SHDN}}$  pin should not exceed 60 V. LMR16006Y-Q1 has an internal UVLO circuit to shutdown the output if the input voltage falls below an internally fixed UVLO threshold level. This ensures that the regulator is not latched into an unknown state during low input voltage conditions. The regulator will power up when the input voltage exceeds the voltage level. If there is a requirement for a higher UVLO voltage, the  $\overline{\text{SHDN}}$  can be used to adjust the system UVLO by using external resistors.

### 8.3.5 Current Limit

The LMR16006Y-Q1 implements current mode control which uses the internal COMP voltage to turn off the high side MOSFET on a cycle-by-cycle basis. Each cycle the switch current and internal COMP voltage are compared, when the peak switch current intersects the COMP voltage, the high side switch is turned off. During overcurrent conditions that pull the output voltage low, the error amplifier will respond by driving the COMP node high, increasing the switch current. The error amplifier output is clamped internally, which functions as a switch current limit.



## Feature Description (continued)

### 8.3.6 Overvoltage Transient Protection

The LMR16006Y-Q1 incorporates an overvoltage transient protection (OVTP) circuit to minimize voltage overshoot when recovering from output fault conditions or strong unload transients on power supply designs with low value output capacitance. For example, when the power supply output is overloaded the error amplifier compares the actual output voltage to the internal reference voltage. If the FB pin voltage is lower than the internal reference voltage for a considerable time, the output of the error amplifier will respond by clamping the error amplifier output to a high voltage. Thus, requesting the maximum output current. Once the condition is removed, the regulator output rises and the error amplifier output transitions to the steady state duty cycle. In some applications, the power supply output voltage can respond faster than the error amplifier output can respond, this actuality leads to the possibility of an output overshoot. The OVTP feature minimizes the output overshoot, when using a low value output capacitor, by implementing a circuit to compare the FB pin voltage to OVTP threshold which is 108% of the internal voltage reference. If the FB pin voltage is greater than the OVTP threshold, the high side MOSFET is disabled preventing current from flowing to the output and minimizing output overshoot. When the FB voltage drops lower than the OVTP threshold, the high side MOSFET is allowed to turn on at the next clock cycle.

### 8.3.7 Thermal Shutdown

The device implements an internal thermal shutdown to protect itself if the junction temperature exceeds 170°C(typ). The thermal shutdown forces the device to stop switching when the junction temperature exceeds the thermal trip threshold. Once the junction temperature decreases below 160°C(typ), the device reinitiates the power up sequence.

## 8.4 Device Functional Modes

### 8.4.1 Continuous Conduction Mode

The LMR16006Y-Q1 steps the input voltage down to a lower output voltage. In continuous conduction mode (when the inductor current never reaches zero at CCM), the buck regulator operates in two cycles. The power switch is connected between  $V_{IN}$  and SW. In the first cycle of operation the transistor is closed and the diode is reverse biased. Energy is collected in the inductor and the load current is supplied by  $C_{out}$  and the rising current through the inductor. During the second cycle the transistor is open and the diode is forward biased due to the fact that the inductor current cannot instantaneously change direction. The energy stored in the inductor is transferred to the load and output capacitor. The ratio of these two cycles determines the output voltage. The output voltage is defined approximately as:  $D = V_{OUT}/V_{IN}$  and  $D' = (1-D)$  where D is the duty cycle of the switch, D and D' will be required for design calculations.

### 8.4.2 ECO Mode

The LMR16006Y-Q1 operates in ECO mode at light load currents to improve efficiency by reducing switching and gate drive losses. The LMR16006Y-Q1 is designed so that if the output voltage is within regulation and the peak switch current at the end of any switching cycle is below the sleep current threshold,  $I_{INDUCTOR} \leq 80$  mA, the device enters ECO mode. For ECO mode operation, the LMR16006Y-Q1 senses peak current, not average or load current, so the load current where the device enters ECO mode is dependent on  $V_{IN}$ ,  $V_{OUT}$  and the output inductor value. When the load current is low and the output voltage is within regulation, the device enters an ECO mode and draws only 28  $\mu$ A input quiescent current.

## 9 Application and Implementation

### NOTE

Information in the following applications sections is not part of the TI component specification, and TI does not warrant its accuracy or completeness. TI's customers are responsible for determining suitability of components for their purposes. Customers should validate and test their design implementation to confirm system functionality.

### 9.1 Application Information

The LMR16006Y-Q1 is a step down DC-to-DC regulator. It is typically used to convert a higher DC voltage to a lower DC voltage with a maximum output current of 600 mA. [Detailed Design Procedure](#) can be used to select components for the LMR16006Y-Q1.

### 9.2 Typical Application

Figure 7 shows typical application where user can adjust output by R1 and R2.

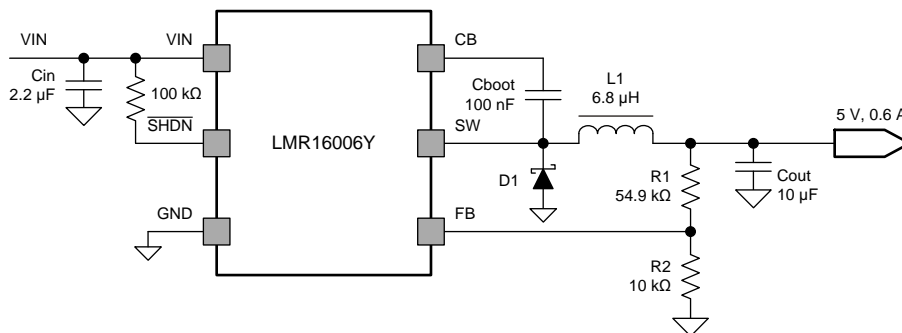

Figure 7. Application Circuit, 5 V Output

#### 9.2.1 Design Requirements

Example requirements for typical buck regulators with high-efficiency applications:

Table 1. Design Requirements

DESIGN PARAMETER		EXAMPLE VALUE
Input voltage, $V_{IN}$		9 V to 16 V, typical 12 V
Output voltage, $V_{OUT}$		5 V $\pm$ 3%
Maximum output current $I_{O\_max}$		0.6 A
Minimum output current $I_{O\_min}$		0.03 A
Transient response 0.03 A to 0.6 A		5%
Output voltage ripple		1%
Switching frequency $f_{SW}$		2.1 MHz
Target during Load Transient	Overvoltage peak value	106% of output voltage
	Undervoltage value	91% of output voltage

#### 9.2.2 Detailed Design Procedure

This example details the design of a high frequency switching regulator using ceramic output capacitors. A few parameters must be known in order to start the design process. These parameters are typically determined at the system level:

### 9.2.2.1 Output Inductor Selection

The most critical parameters for the inductor are the inductance, peak current and the DC resistance. The inductance is related to the peak-to-peak inductor ripple current, the input and the output voltages. Since the ripple current increases with the input voltage, the maximum input voltage is always used to determine the inductance. To calculate the minimum value of the output inductor, use [Equation 1](#).  $K_{IND}$  is a coefficient that represents the amount of inductor ripple current relative to the maximum output current. A reasonable value is setting the ripple current to be 30%-40% of the DC output current. For this design example, the minimum inductor value is calculated to be 6.82  $\mu\text{H}$ , and a nearest standard value was chosen: 6.8  $\mu\text{H}$ . For the output filter inductor, it is important that the RMS current and saturation current ratings not be exceeded. The RMS and peak inductor current can be found from [Equation 3](#) and [Equation 4](#). The inductor ripple current is 0.074 A, and the RMS current is 0.60 A. As the equation set demonstrates, lower ripple currents will reduce the output voltage ripple of the regulator but will require a larger value of inductance. A good starting point for most applications is 6.8  $\mu\text{H}$  with a 1.6 A current rating. Using a rating near 1.6 A will enable the LMR16006Y-Q1 to current limit without saturating the inductor. This is preferable to the LMR16006Y-Q1 going into thermal shutdown mode and the possibility of damaging the inductor if the output is shorted to ground or other long-term overload.

$$L_{o\ min} = \frac{V_{in\ max} - V_{out}}{I_o \times K_{IND}} \times \frac{V_{out}}{V_{in\ max} \times f_{sw}} \quad (1)$$

$$I_{ripple} = \frac{V_{out} \times (V_{in\ max} - V_{out})}{V_{in\ max} \times L_o \times f_{sw}} \quad (2)$$

$$I_{L-RMS} = \sqrt{I_o^2 + \frac{1}{12} I_{ripple}^2} \quad (3)$$

$$I_{L-peak} = I_o + \frac{I_{ripple}}{2} \quad (4)$$

### 9.2.2.2 Output Capacitor Selection

The selection of  $C_{out}$  is mainly driven by three primary considerations. The output capacitor will determine the modulator pole, the output voltage ripple, and how the regulator responds to a large change in load current. The output capacitance needs to be selected based on the most stringent of these three criteria.

The desired response to a large change in the load current is the first criteria. The regulator usually needs two or more clock cycles for the control loop to see the change in load current and output voltage and adjust the duty cycle to react to the change. The output capacitance must be large enough to supply the difference in current for 2 clock cycles while only allowing a tolerable amount of droop in the output voltage. [Equation 5](#) shows the minimum output capacitance necessary to accomplish this. The transient load response is specified as a 3% change in  $V_{OUT}$  for a load step from 0.03 A to 0.6 A (full load),  $\Delta I_{OUT} = 0.6 - 0.03 = 0.57$  A and  $\Delta V_{OUT} = 0.03 \times 5 = 0.15$  V. Using these numbers gives a minimum capacitance of 3.62  $\mu\text{F}$ . For ceramic capacitors, the ESR is usually small enough to ignore in this calculation. Aluminum electrolytic and tantalum capacitors have higher ESR that should be taken into account.

The stored energy in the inductor will produce an output voltage overshoot when the load current rapidly decreases. The output capacitor must also be sized to absorb energy stored in the inductor when transitioning from a high load current to a lower load current. [Equation 6](#) is used to calculate the minimum capacitance to keep the output voltage overshoot to a desired value. Where  $L$  is the value of the inductor,  $I_{OH}$  is the output current under heavy load,  $I_{OL}$  is the output under light load,  $V_f$  is the final peak output voltage, and  $V_i$  is the initial capacitor voltage. For this example, the worst case load step will be from 0.6 A to 0.03 A. The output voltage will increase during this load transition and the stated maximum in our specification is 3% of the output voltage. This will make  $V_{o\_overshoot} = 1.03 \times 5 = 5.15$  V.  $V_i$  is the initial capacitor voltage which is the nominal output voltage of 5 V. Using these numbers in [Equation 6](#) yields a minimum capacitance of 1.6  $\mu\text{F}$ .

[Equation 7](#) calculates the minimum output capacitance needed to meet the output voltage ripple specification. Where  $f_{sw}$  is the switching frequency,  $V_{o\_ripple}$  is the maximum allowable output voltage ripple, and  $I_{L\_ripple}$  is the inductor ripple current. [Equation 7](#) yields 95 nF.

[Equation 8](#) calculates the maximum ESR an output capacitor can have to meet the output voltage ripple specification. [Equation 8](#) indicates the ESR should be less than 623 m $\Omega$ .

Additional capacitance de-ratings for aging, temperature and dc bias should be factored in which will increase this minimum value. For this example, 10  $\mu\text{F}$  ceramic capacitors will be used. Capacitors in the range of 4.7  $\mu\text{F}$ -100  $\mu\text{F}$  are a good starting point with an ESR of 0.7  $\Omega$  or less.

$$C_{out} > \frac{2 \times \Delta I_{out}}{f_{sw} \times \Delta V_{out}} \quad (5)$$

$$C_{out} > L_o \times \frac{(I_{oh}^2 - I_{ol}^2)}{(V_f^2 - V_i^2)} \quad (6)$$

$$C_{out} > \frac{1}{8 \times f_{sw}} \times \frac{1}{\frac{V_{o\_ripple}}{I_{L\_ripple}}} \quad (7)$$

$$R_{ESR} < \frac{V_{o\_ripple}}{I_{L\_ripple}} \quad (8)$$

### 9.2.2.3 Schottky Diode Selection

The breakdown voltage rating of the diode is preferred to be 25% higher than the maximum input voltage. In the target application, the current rating for the diode should be equal or greater to the maximum output current for best reliability in most applications. In cases where the input voltage is not much greater than the output voltage the average diode current is lower. In this case it is possible to use a diode with a lower average current rating, approximately  $(1-D) \times I_{OUT}$ . However the peak current rating should be higher than the maximum load current. A 0.5 A to 1 A rated diode is a good starting point.

### 9.2.2.4 Input Capacitor Selection

A low ESR ceramic capacitor is needed between the VIN pin and ground pin. This capacitor prevents large switching voltage transients from appearing at the input. Use a 1  $\mu\text{F}$ -10  $\mu\text{F}$  value with X5R or X7R dielectric. Depending on construction, a ceramic capacitor's value can decrease up to 50% of its nominal value when rated voltage is applied. Consult with the capacitor manufactures data sheet for information on capacitor derating over voltage and temperature. The capacitor must also have a ripple current rating greater than the maximum input current ripple of the LMR16006Y-Q1. The input ripple current can be calculated using below [Equation 9](#).

For this example design, one 2.2  $\mu\text{F}$ , 50 V capacitor is selected. The input capacitance value determines the input ripple voltage of the regulator. The input voltage ripple can be calculated using [Equation 10](#). Using the design example values,  $I_{OUT\_max} = 0.6$  A,  $C_{in} = 2.2$   $\mu\text{F}$ ,  $f_{SW} = 2100$  kHz, yields an input voltage ripple of 33 mV and a rms input ripple current of 0.3 A.

$$I_{cirms} = I_{out} \times \sqrt{\frac{V_{out}}{V_{in\ min}} \times \frac{(V_{in\ min} - V_{out})}{V_{in\ min}}} \quad (9)$$

$$\Delta V_{in} = \frac{I_{out\ max} \times 0.25}{C_{in} \times f_{sw}} \quad (10)$$

### 9.2.2.5 Bootstrap Capacitor Selection

A 0.1  $\mu\text{F}$  ceramic capacitor or larger is recommended for the bootstrap capacitor ( $C_{BOOT}$ ). For applications where the input voltage is close to output voltage a larger capacitor is recommended, generally 0.1  $\mu\text{F}$  to 1  $\mu\text{F}$  to ensure plenty of gate drive for the internal switches and a consistently low  $R_{DS(on)}$ . A ceramic capacitor with an X7R or X5R grade dielectric with a voltage rating of 10 V or higher is recommended because of the stable characteristics over temperature and voltage.

### 9.2.3 Application Curves

Unless otherwise specified the following conditions apply:  $V_{IN} = 12\text{ V}$ ,  $f_{SW} = 2100\text{ kHz}$ ,  $L1 = 6.8\text{ }\mu\text{H}$ ,  $C_{OUT} = 10\text{ }\mu\text{F}$ ,  $T_A = 25^\circ\text{C}$ .

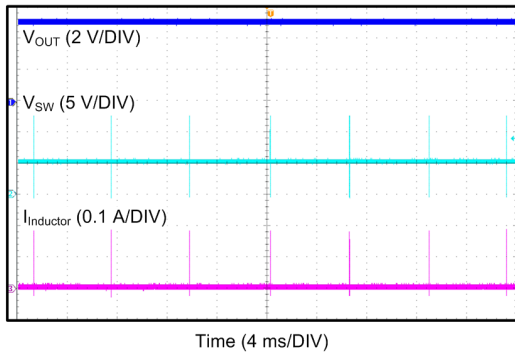

$V_{OUT} = 5\text{ V}$        $I_{OUT} = 0\text{ mA}$

Figure 8. Steady State Waveform

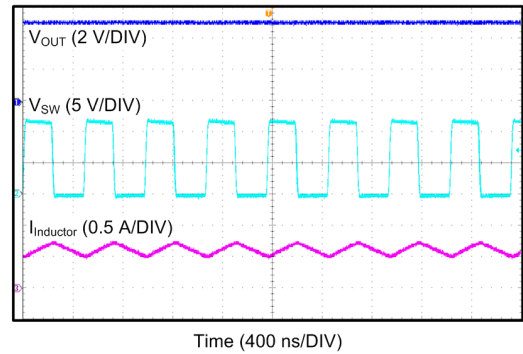

$V_{OUT} = 5\text{ V}$        $I_{OUT} = 600\text{ mA}$

Figure 9. Steady State Waveform

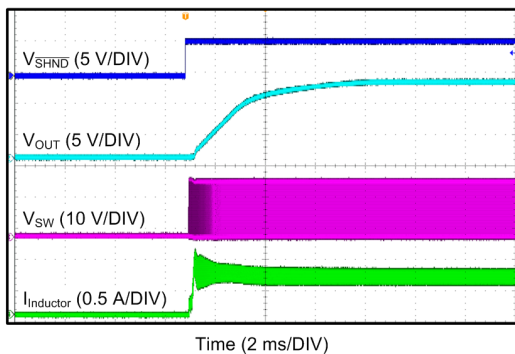

$V_{IN} = 15\text{ V}$        $V_{OUT} = 12\text{ V}$        $I_{OUT} = 600\text{ mA}$

Figure 10. Start-Up

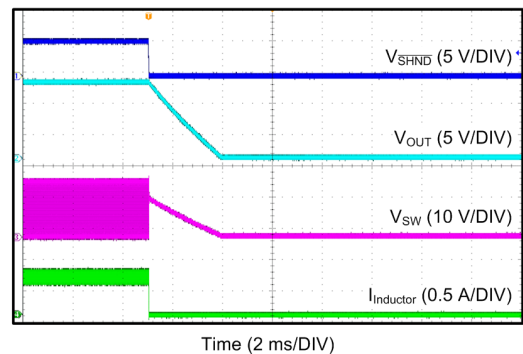

$V_{IN} = 15\text{ V}$        $V_{OUT} = 12\text{ V}$        $I_{OUT} = 600\text{ mA}$

Figure 11. Shutdown

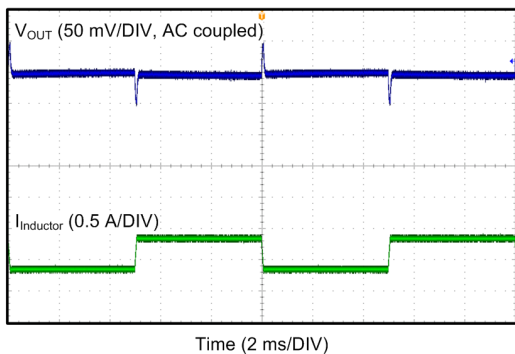

$V_{IN} = 12\text{ V}$        $V_{OUT} = 5\text{ V}$        $I_{OUT} = 600\text{ mA}$

Figure 12. Load Transient from 0.1 A to 0.6 A

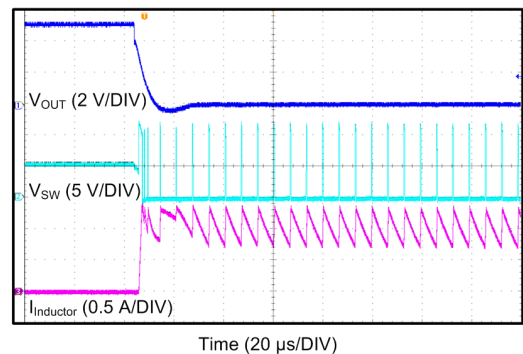

$V_{IN} = 12\text{ V}$        $V_{OUT} = 5\text{ V}$

Figure 13. Short Circuit Entry

### 9.2.4 Additional Application Circuit

Figure 14 shows the typical application circuit with a fixed output.

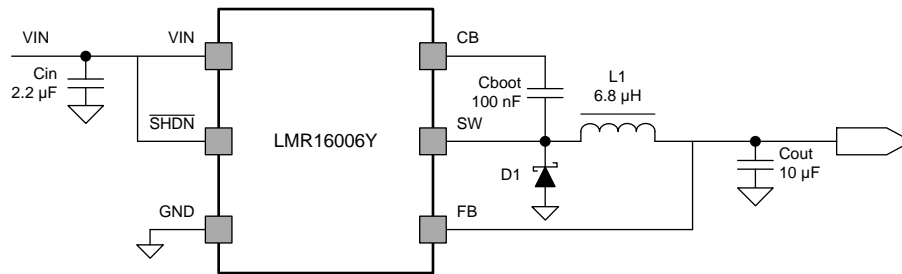

**Figure 14. LMR16006Y-Q1 Application Circuit, Fixed Output**

## 10 Power Supply Recommendations

The LMR16006Y-Q1 is designed to operate from an input voltage supply range between 4 V and 60 V. This input supply should be able to withstand the maximum input current and maintain a voltage above 4 V. The resistance of the input supply rail should be low enough that an input current transient does not cause a high enough drop at the LMR16006Y-Q1 supply voltage that can cause a false UVLO fault triggering and system reset. If the input supply is located more than a few inches from the LMR16006Y-Q1, additional bulk capacitance may be required in addition to the ceramic input capacitors.

## 11 Layout

### 11.1 Layout Guidelines

Layout is a critical portion of good power supply design. The following guidelines will help users design a PCB with the best power conversion performance, thermal performance, and minimized generation of unwanted EMI.

1. The feedback network, resistors R1 and R2, should be kept close to the FB pin, and away from the inductor to minimize coupling noise into the feedback pin.
2. The input bypass capacitor  $C_{in}$  must be placed close to the  $V_{IN}$  pin. This will reduce copper trace resistance which effects input voltage ripple of the IC.
3. The inductor L1 should be placed close to the SW pin to reduce magnetic and electrostatic noise.
4. The output capacitor,  $C_{out}$  should be placed close to the junction of L1 and the diode D1. The L1, D1, and  $C_{out}$  trace should be as short as possible to reduce conducted and radiated noise and increase overall efficiency.
5. The ground connection for the diode,  $C_{in}$ , and  $C_{out}$  should be as small as possible and tied to the system ground plane in only one spot (preferably at the  $C_{out}$  ground point) to minimize conducted noise in the system ground plane.
6. For more detail on switching power supply layout considerations see AN-1149 *Layout Guidelines for Switching Power Supplies* [SNVA021](#)

### 11.2 Layout Example

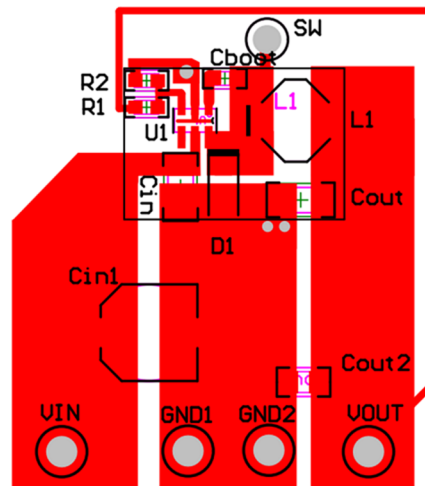

Figure 15. Layout

## 12 Device and Documentation Support

### 12.1 Related Documentation

AN-1149 *Layout Guidelines for Switching Power Supplies* ([SNVA021](#)).

### 12.2 Community Resources

The following links connect to TI community resources. Linked contents are provided "AS IS" by the respective contributors. They do not constitute TI specifications and do not necessarily reflect TI's views; see TI's [Terms of Use](#).

**TI E2E™ Online Community** *TI's Engineer-to-Engineer (E2E) Community*. Created to foster collaboration among engineers. At [e2e.ti.com](#), you can ask questions, share knowledge, explore ideas and help solve problems with fellow engineers.

**Design Support** *TI's Design Support* Quickly find helpful E2E forums along with design support tools and contact information for technical support.

### 12.3 Trademarks

E2E is a trademark of Texas Instruments.  
 SIMPLE SWITCHER is a registered trademark of TI .  
 All other trademarks are the property of their respective owners.

### 12.4 Electrostatic Discharge Caution



These devices have limited built-in ESD protection. The leads should be shorted together or the device placed in conductive foam during storage or handling to prevent electrostatic damage to the MOS gates.

### 12.5 Glossary

[SLYZ022](#) — *TI Glossary*.

This glossary lists and explains terms, acronyms, and definitions.

## 13 Mechanical, Packaging, and Orderable Information

The following pages include mechanical, packaging, and orderable information. This information is the most current data available for the designated devices. This data is subject to change without notice and revision of this document. For browser-based versions of this data sheet, refer to the left-hand navigation.



**PACKAGING INFORMATION**

Orderable Device	Status (1)	Package Type	Package Drawing	Pins	Package Qty	Eco Plan (2)	Lead finish/ Ball material (6)	MSL Peak Temp (3)	Op Temp (°C)	Device Marking (4/5)	Samples
LMR16006YQ3DDCRQ1	ACTIVE	SOT-23-THIN	DDC	6	3000	RoHS & Green	NIPDAU	Level-1-260C-UNLIM	-40 to 125	Q32Y	<a href="#">Samples</a>
LMR16006YQ3DDCTQ1	ACTIVE	SOT-23-THIN	DDC	6	250	RoHS & Green	NIPDAU	Level-1-260C-UNLIM	-40 to 125	Q32Y	<a href="#">Samples</a>
LMR16006YQ5DDCRQ1	ACTIVE	SOT-23-THIN	DDC	6	3000	RoHS & Green	NIPDAU	Level-1-260C-UNLIM	-40 to 125	Q52Y	<a href="#">Samples</a>
LMR16006YQ5DDCTQ1	ACTIVE	SOT-23-THIN	DDC	6	250	RoHS & Green	NIPDAU	Level-1-260C-UNLIM	-40 to 125	Q52Y	<a href="#">Samples</a>
LMR16006YQDDCRQ1	ACTIVE	SOT-23-THIN	DDC	6	3000	RoHS & Green	NIPDAU	Level-1-260C-UNLIM	-40 to 125	Q02Y	<a href="#">Samples</a>
LMR16006YQDDCTQ1	ACTIVE	SOT-23-THIN	DDC	6	250	RoHS & Green	NIPDAU	Level-1-260C-UNLIM	-40 to 125	Q02Y	<a href="#">Samples</a>

(1) The marketing status values are defined as follows:

**ACTIVE:** Product device recommended for new designs.

**LIFEBUY:** TI has announced that the device will be discontinued, and a lifetime-buy period is in effect.

**NRND:** Not recommended for new designs. Device is in production to support existing customers, but TI does not recommend using this part in a new design.

**PREVIEW:** Device has been announced but is not in production. Samples may or may not be available.

**OBSOLETE:** TI has discontinued the production of the device.

(2) **RoHS:** TI defines "RoHS" to mean semiconductor products that are compliant with the current EU RoHS requirements for all 10 RoHS substances, including the requirement that RoHS substance do not exceed 0.1% by weight in homogeneous materials. Where designed to be soldered at high temperatures, "RoHS" products are suitable for use in specified lead-free processes. TI may reference these types of products as "Pb-Free".

**RoHS Exempt:** TI defines "RoHS Exempt" to mean products that contain lead but are compliant with EU RoHS pursuant to a specific EU RoHS exemption.

**Green:** TI defines "Green" to mean the content of Chlorine (Cl) and Bromine (Br) based flame retardants meet JS709B low halogen requirements of <=1000ppm threshold. Antimony trioxide based flame retardants must also meet the <=1000ppm threshold requirement.

(3) MSL, Peak Temp. - The Moisture Sensitivity Level rating according to the JEDEC industry standard classifications, and peak solder temperature.

(4) There may be additional marking, which relates to the logo, the lot trace code information, or the environmental category on the device.

(5) Multiple Device Markings will be inside parentheses. Only one Device Marking contained in parentheses and separated by a "~" will appear on a device. If a line is indented then it is a continuation of the previous line and the two combined represent the entire Device Marking for that device.

(6) Lead finish/Ball material - Orderable Devices may have multiple material finish options. Finish options are separated by a vertical ruled line. Lead finish/Ball material values may wrap to two lines if the finish value exceeds the maximum column width.

**Important Information and Disclaimer:** The information provided on this page represents TI's knowledge and belief as of the date that it is provided. TI bases its knowledge and belief on information provided by third parties, and makes no representation or warranty as to the accuracy of such information. Efforts are underway to better integrate information from third parties. TI has taken and continues to take reasonable steps to provide representative and accurate information but may not have conducted destructive testing or chemical analysis on incoming materials and chemicals. TI and TI suppliers consider certain information to be proprietary, and thus CAS numbers and other limited information may not be available for release.

In no event shall TI's liability arising out of such information exceed the total purchase price of the TI part(s) at issue in this document sold by TI to Customer on an annual basis.

**TAPE AND REEL INFORMATION**

**QUADRANT ASSIGNMENTS FOR PIN 1 ORIENTATION IN TAPE**

\*All dimensions are nominal

Device	Package Type	Package Drawing	Pins	SPQ	Reel Diameter (mm)	Reel Width W1 (mm)	A0 (mm)	B0 (mm)	K0 (mm)	P1 (mm)	W (mm)	Pin1 Quadrant
LMR16006YQ3DDCRQ1	SOT-23-THIN	DDC	6	3000	178.0	8.4	3.2	3.2	1.4	4.0	8.0	Q3
LMR16006YQ3DDCTQ1	SOT-23-THIN	DDC	6	250	178.0	8.4	3.2	3.2	1.4	4.0	8.0	Q3
LMR16006YQ5DDCRQ1	SOT-23-THIN	DDC	6	3000	178.0	8.4	3.2	3.2	1.4	4.0	8.0	Q3
LMR16006YQ5DDCTQ1	SOT-23-THIN	DDC	6	250	178.0	8.4	3.2	3.2	1.4	4.0	8.0	Q3
LMR16006YQDDCRQ1	SOT-23-THIN	DDC	6	3000	178.0	8.4	3.2	3.2	1.4	4.0	8.0	Q3
LMR16006YQDDCTQ1	SOT-23-THIN	DDC	6	250	178.0	8.4	3.2	3.2	1.4	4.0	8.0	Q3

**TAPE AND REEL BOX DIMENSIONS**

\*All dimensions are nominal

Device	Package Type	Package Drawing	Pins	SPQ	Length (mm)	Width (mm)	Height (mm)
LMR16006YQ3DDCRQ1	SOT-23-THIN	DDC	6	3000	208.0	191.0	35.0
LMR16006YQ3DDCTQ1	SOT-23-THIN	DDC	6	250	208.0	191.0	35.0
LMR16006YQ5DDCRQ1	SOT-23-THIN	DDC	6	3000	208.0	191.0	35.0
LMR16006YQ5DDCTQ1	SOT-23-THIN	DDC	6	250	208.0	191.0	35.0
LMR16006YQDDCRQ1	SOT-23-THIN	DDC	6	3000	208.0	191.0	35.0
LMR16006YQDDCTQ1	SOT-23-THIN	DDC	6	250	208.0	191.0	35.0



# EXAMPLE BOARD LAYOUT

DDC0006A

SOT-23 - 1.1 max height

SMALL OUTLINE TRANSISTOR

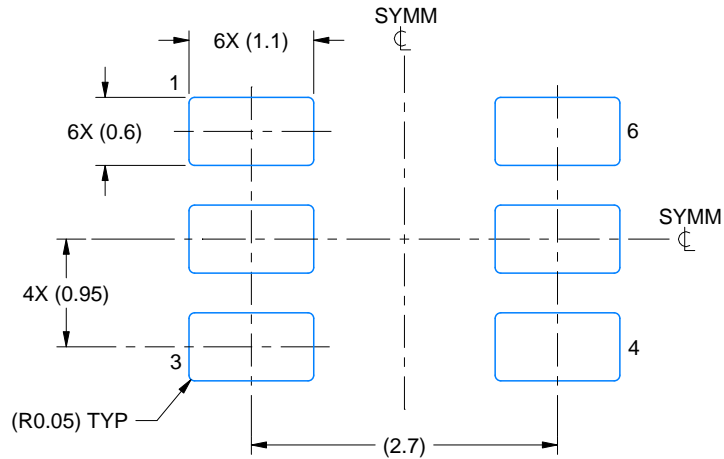

LAND PATTERN EXAMPLE  
EXPLODED METAL SHOWN  
SCALE:15X

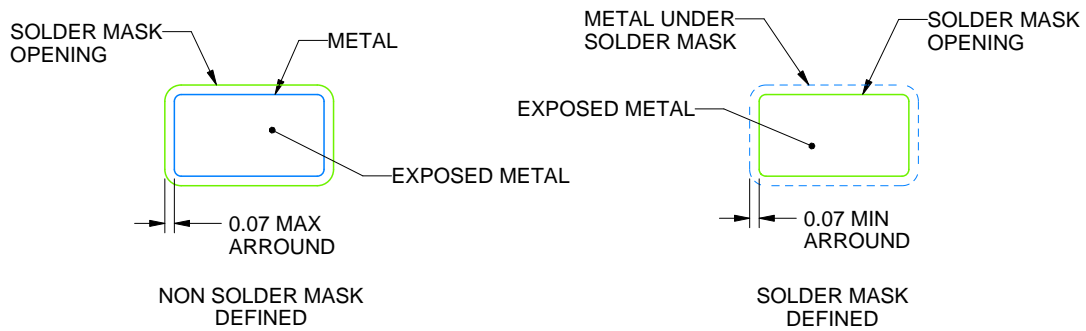

SOLDEMASK DETAILS

4214841/D 06/2024

NOTES: (continued)

- 4. Publication IPC-7351 may have alternate designs.
- 5. Solder mask tolerances between and around signal pads can vary based on board fabrication site.

# EXAMPLE STENCIL DESIGN

DDC0006A

SOT-23 - 1.1 max height

SMALL OUTLINE TRANSISTOR

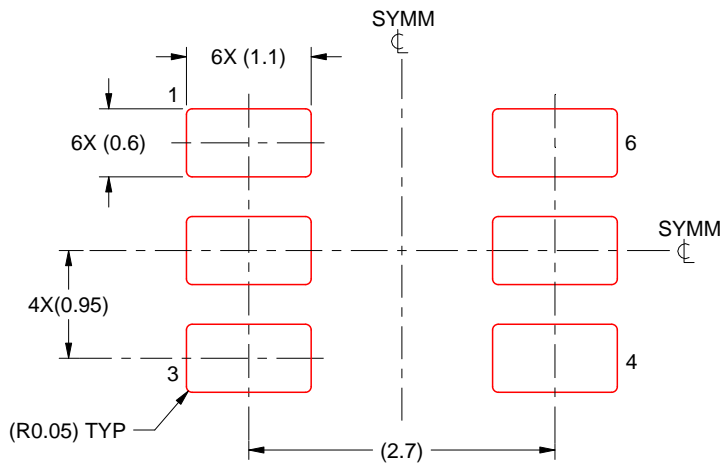

SOLDER PASTE EXAMPLE  
BASED ON 0.125 THICK STENCIL  
SCALE:15X

4214841/D 06/2024

NOTES: (continued)

6. Laser cutting apertures with trapezoidal walls and rounded corners may offer better paste release. IPC-7525 may have alternate design recommendations.
7. Board assembly site may have different recommendations for stencil design.

## IMPORTANT NOTICE AND DISCLAIMER

TI PROVIDES TECHNICAL AND RELIABILITY DATA (INCLUDING DATA SHEETS), DESIGN RESOURCES (INCLUDING REFERENCE DESIGNS), APPLICATION OR OTHER DESIGN ADVICE, WEB TOOLS, SAFETY INFORMATION, AND OTHER RESOURCES "AS IS" AND WITH ALL FAULTS, AND DISCLAIMS ALL WARRANTIES, EXPRESS AND IMPLIED, INCLUDING WITHOUT LIMITATION ANY IMPLIED WARRANTIES OF MERCHANTABILITY, FITNESS FOR A PARTICULAR PURPOSE OR NON-INFRINGEMENT OF THIRD PARTY INTELLECTUAL PROPERTY RIGHTS.

These resources are intended for skilled developers designing with TI products. You are solely responsible for (1) selecting the appropriate TI products for your application, (2) designing, validating and testing your application, and (3) ensuring your application meets applicable standards, and any other safety, security, regulatory or other requirements.

These resources are subject to change without notice. TI grants you permission to use these resources only for development of an application that uses the TI products described in the resource. Other reproduction and display of these resources is prohibited. No license is granted to any other TI intellectual property right or to any third party intellectual property right. TI disclaims responsibility for, and you will fully indemnify TI and its representatives against, any claims, damages, costs, losses, and liabilities arising out of your use of these resources.

TI's products are provided subject to [TI's Terms of Sale](#) or other applicable terms available either on [ti.com](https://www.ti.com) or provided in conjunction with such TI products. TI's provision of these resources does not expand or otherwise alter TI's applicable warranties or warranty disclaimers for TI products.

TI objects to and rejects any additional or different terms you may have proposed.

Mailing Address: Texas Instruments, Post Office Box 655303, Dallas, Texas 75265  
Copyright © 2024, Texas Instruments Incorporated