

FEATURES

- **Controlled Baseline**
 - One Assembly/Test Site, One Fabrication Site
- **Enhanced Diminishing Manufacturing Sources (DMS) Support**
- **Enhanced Product-Change Notification**
- **Qualification Pedigree ⁽¹⁾**
- **Complete Pulse-Width Modulation (PWM) Power-Control Circuitry**
- **Completely Synchronized Operation**
- **Internal Undervoltage Lockout Protection**
- **Wide Supply-Voltage Range**
- **Internal Short-Circuit Protection**
- **Oscillator Frequency . . . 500 kHz Max**
- **Variable Dead Time Provides Control Over Total Range**
- **Internal Regulator Provides a Stable 2.5-V Reference Supply**

(1) Component qualification in accordance with JEDEC and industry standards to ensure reliable operation over an extended temperature range. This includes, but is not limited to, Highly Accelerated Stress Test (HAST) or biased 85/85, temperature cycle, autoclave or unbiased HAST, electromigration, bond intermetallic life, and mold compound life. Such qualification testing should not be viewed as justifying use of this component beyond specified performance and environmental limits.

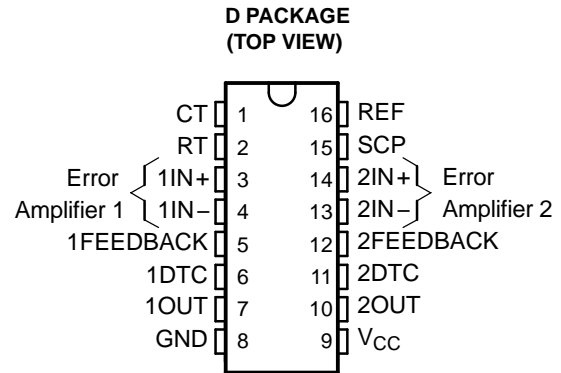

DESCRIPTION/ORDERING INFORMATION

The TL1451A-EP incorporates on a single monolithic chip all the functions required in the construction of two pulse-width modulation (PWM) control circuits. Designed primarily for power-supply control, the TL1451A-EP contains an on-chip 2.5-V regulator, two error amplifiers, an adjustable oscillator, two dead-time comparators, undervoltage lockout circuitry, and dual common-emitter output transistor circuits.

The uncommitted output transistors provide common-emitter output capability for each controller. The internal amplifiers exhibit a common-mode voltage range from 1.04 V to 1.45 V. The dead-time control (DTC) comparator has no offset unless externally altered and can provide 0% to 100% dead time. The on-chip oscillator can be operated by terminating RT and CT. During low V_{CC} conditions, the undervoltage lockout control circuit feature locks the outputs off until the internal circuitry is operational.

The TL1451A-EP is characterized for operation from -55°C to 125°C .

ORDERING INFORMATION

T_A	PACKAGE ⁽¹⁾		ORDERABLE PART NUMBER	TOP-SIDE MARKING
-55°C to 125°C	SOIC – D	Tape and reel	TL1451AMDREP	TL1451EPG4

(1) Package drawings, standard packing quantities, thermal data, symbolization, and PCB design guidelines are available at www.ti.com/sc/package.



Please be aware that an important notice concerning availability, standard warranty, and use in critical applications of Texas Instruments semiconductor products and disclaimers thereto appears at the end of this data sheet.

FUNCTIONAL BLOCK DIAGRAM

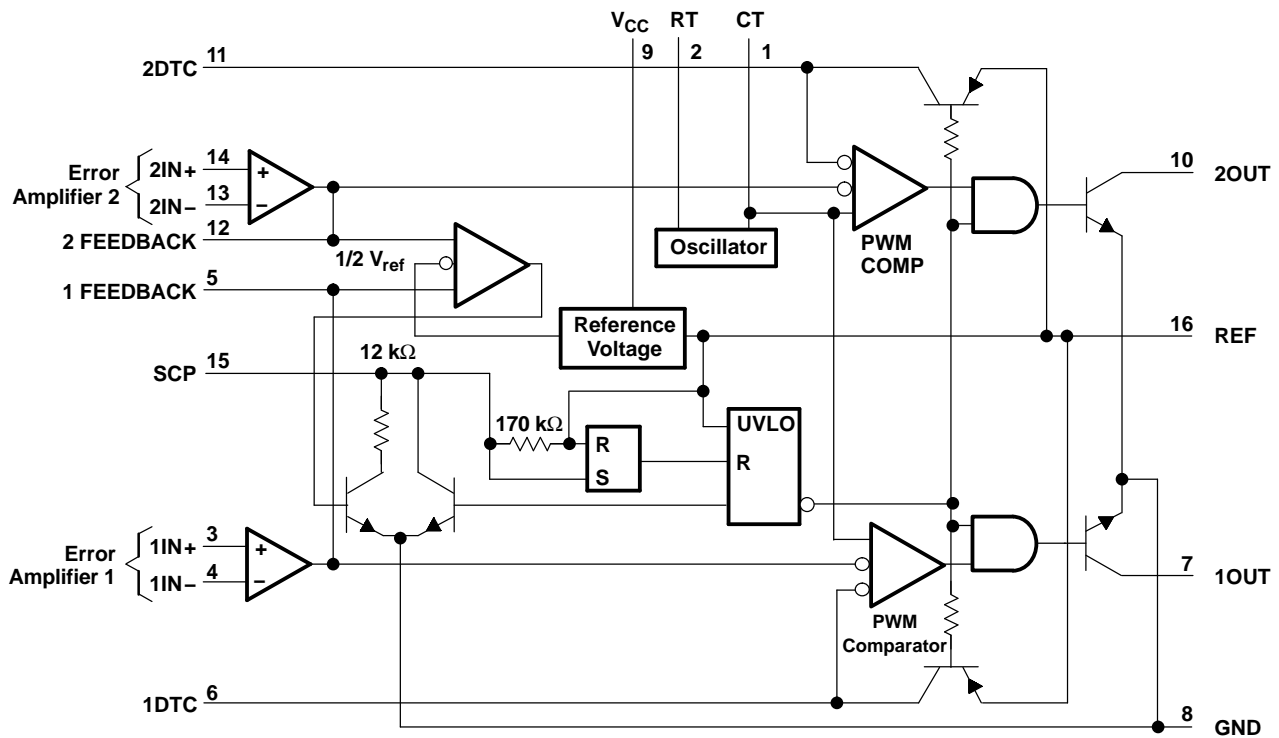

COMPONENT COUNT

Resistors	65
Capacitors	8
Transistors	105
JFETs	18

Absolute Maximum Ratings⁽¹⁾

over operating free-air temperature range

			MIN	MAX	UNIT
V _{CC}	Supply voltage			51	V
V _I	Amplifier input voltage			20	V
V _O	Collector output voltage			51	V
I _O	Collector output current			21	mA
	Continuous power total dissipation		See Dissipation Rating Table		
T _A	Operating free-air temperature range	M suffix	-55	125	°C
T _{stg}	Storage temperature range		-65	150	°C
	Lead temperature	1,6 mm (1/16 in) from case for 10 s		260	°C

(1) Stresses beyond those listed under "absolute maximum ratings" may cause permanent damage to the device. These are stress ratings only, and functional operation of the device at these or any other conditions beyond those indicated under "recommended operating conditions" is not implied. Exposure to absolute-maximum-rated conditions for extended periods may affect device reliability.

Dissipation Ratings

PACKAGE	$T_A \leq 25^\circ\text{C}$ POWER RATING	DERATING FACTOR ABOVE $T_A = 25^\circ\text{C}$	$T_A = 70^\circ\text{C}$ POWER RATING	$T_A = 85^\circ\text{C}$ POWER RATING	$T_A = 125^\circ\text{C}$ POWER RATING
D	1088 mW	8.7 mW/°C	696 mW	566 mW	218 mW

Recommended Operating Conditions

		MIN	MAX	UNIT
V_{CC}	Supply voltage	3.6	50	V
V_I	Amplifier input voltage	1.05	1.45	V
V_O	Collector output voltage		50	V
I_O	Collector output current		20	mA
	Current into feedback terminal		45	μA
R_F	Feedback resistor	100		k Ω
C_T	Timing capacitor	150	15000	pF
R_T	Timing resistor	5.1	100	k Ω
	Oscillator frequency	1	500	kHz
T_A	Operating free-air temperature			°C
				M suffix
		-55	125	

Reference Section Electrical Characteristics

over recommended operating free-air temperature range, $V_{CC} = 6\text{ V}$, $f = 200\text{ kHz}$ (unless otherwise noted)

PARAMETER	TEST CONDITIONS		MIN	TYP ⁽¹⁾	MAX	UNIT
Output voltage (pin 16)	$I_O = 1\text{ mA}$	$T_A = 25^\circ\text{C}$	2.4	2.5	2.6	V
		$T_A = \text{MIN and } 125^\circ\text{C}$	2.35	2.46	2.65	
Output voltage change with temperature				-0.63%	$\pm 4\%$ ⁽²⁾	
Input voltage regulation	$V_{CC} = 3.6\text{ V to } 40\text{ V}$	$T_A = 25^\circ\text{C}$		2	12.5	mV
		$T_A = 125^\circ\text{C}$		0.7	15	
		$T_A = \text{MIN}$		0.3	30	
Output voltage regulation	$I_O = 0.1\text{ mA to } 1\text{ mA}$	$T_A = 25^\circ\text{C}$		1	7.5	mV
		$T_A = 125^\circ\text{C}$		0.3	14	
		$T_A = \text{MIN}$		0.3	20	
Short-circuit output current	$V_O = 0$		3	10	30	mA

- (1) All typical values are at $T_A = 25^\circ\text{C}$, unless otherwise indicated.
 (2) These parameters are not production tested.

Undervoltage Lockout Section Electrical Characteristics

over recommended operating free-air temperature range, $V_{CC} = 6\text{ V}$, $f = 200\text{ kHz}$ (unless otherwise noted)

PARAMETER	TEST CONDITIONS	MIN	TYP ⁽¹⁾	MAX	UNIT
Upper threshold voltage (V_{CC})	$T_A = 25^\circ\text{C}$		2.72		V
	$T_A = 125^\circ\text{C}$		1.7		
	$T_A = \text{MIN}$		3.15		
Lower threshold voltage (V_{CC})	$T_A = 25^\circ\text{C}$		2.6		V
	$T_A = 125^\circ\text{C}$		1.65		
	$T_A = \text{MIN}$		3.09		
Hysteresis (V_{CC})	$T_A = 25^\circ\text{C}$	80	120		mV
	$T_A = 125^\circ\text{C}$	10	50		
	$T_A = \text{MIN}$	10	60		
Reset threshold voltage (V_{CC})	$T_A = 25^\circ\text{C}$	1.5			V
	$T_A = 125^\circ\text{C}$	0.95			
	$T_A = \text{MIN}$	1.5			

(1) All typical values are at $T_A = 25^\circ\text{C}$, unless otherwise indicated.

Short-Circuit Protection Control Section Electrical Characteristics

over recommended operating free-air temperature range, $V_{CC} = 6\text{ V}$, $f = 200\text{ kHz}$ (unless otherwise noted)

PARAMETER	TEST CONDITIONS	MIN	TYP ⁽¹⁾	MAX	UNIT
Input threshold voltage (SCP)	$T_A = 25^\circ\text{C}$	650	700	750	mV
	$T_A = 125^\circ\text{C}$	400	478	650	
	$T_A = \text{MIN}$	800	880	950	
Standby voltage (SCP)		140	185	230	mV
Latched input voltage (SCP)	$T_A = 25^\circ\text{C}$		60	120	mV
	$T_A = 125^\circ\text{C}$		70	120	
	$T_A = \text{MIN}$		60	120	
Equivalent timing resistance			170		k Ω
Comparator threshold voltage (FEEDBACK)			1.18		V

(1) All typical values are at $T_A = 25^\circ\text{C}$, unless otherwise indicated.

Oscillator Section Electrical Characteristics

over recommended operating free-air temperature range, $V_{CC} = 6\text{ V}$, $f = 200\text{ kHz}$ (unless otherwise noted)

PARAMETER	TEST CONDITIONS	MIN	TYP ⁽¹⁾	MAX	UNIT
Frequency	$C_T = 330\text{ pF}$, $R_T = 10\text{ k}\Omega$	$T_A = 25^\circ\text{C}$	200		kHz
		$T_A = 125^\circ\text{C}$	195		
		$T_A = \text{MIN}$	193		
Standard deviation of frequency	$C_T = 330\text{ pF}$, $R_T = 10\text{ k}\Omega$		2%		
Frequency change with voltage	$V_{CC} = 3.6\text{ V to }40\text{ V}$	$T_A = 25^\circ\text{C}$	1%		
		$T_A = 125^\circ\text{C}$	1%		
		$T_A = \text{MIN}$	3%		
Frequency change with temperature			1.37%	$\pm 10\%$ ⁽²⁾	

(1) All typical values are at $T_A = 25^\circ\text{C}$, unless otherwise indicated.

(2) These parameters are not production tested.

Dead-Time Control Section Electrical Characteristics

 over recommended operating free-air temperature range, $V_{CC} = 6\text{ V}$, $f = 200\text{ kHz}$ (unless otherwise noted)

PARAMETER	TEST CONDITIONS	MIN	TYP ⁽¹⁾	MAX	UNIT
Input bias current (DTC)	$T_A = 25^\circ\text{C}$			1	μA
	$T_A = \text{MIN}$ and 125°C			3	
Latch mode (source) current (DTC)		-80	-145		μA
Latched input voltage (DTC)	$T_A = 25^\circ\text{C}$	2.3			V
	$T_A = 125^\circ\text{C}$	2.22	2.32		
	$T_A = \text{MIN}$	2.28	2.4		
Input threshold voltage at $f = 10\text{ kHz}$ (DTC)	Zero duty cycle		2.05	2.25 ⁽²⁾	V
	Maximum duty cycle	1.2 ⁽²⁾	1.45		

 (1) All typical values are at $T_A = 25^\circ\text{C}$, unless otherwise indicated.

(2) These parameters are not production tested.

Error-Amplifier Section Electrical Characteristics

 over recommended operating free-air temperature range, $V_{CC} = 6\text{ V}$, $f = 200\text{ kHz}$ (unless otherwise noted)

PARAMETER	TEST CONDITIONS	MIN	TYP ⁽¹⁾	MAX	UNIT
Input offset voltage	$V_O (\text{FEEDBACK}) = 1.25\text{ V}$	$T_A = 25^\circ\text{C}$		± 7	mV
		$T_A = 125^\circ\text{C}$		± 10	
		$T_A = \text{MIN}$		± 12	
Input offset current	$V_O (\text{FEEDBACK}) = 1.25\text{ V}$	$T_A = 25^\circ\text{C}$		± 100	nA
		$T_A = 125^\circ\text{C}$		± 100	
		$T_A = \text{MIN}$		± 200	
Input bias current	$V_O (\text{FEEDBACK}) = 1.25\text{ V}$	$T_A = 25^\circ\text{C}$	160	500	nA
		$T_A = 125^\circ\text{C}$	100	500	
		$T_A = \text{MIN}$	142	700	
Common-mode input voltage range	$V_{CC} = 3.6\text{ V}$ to 40 V	1.05 to 1.45			V
Open-loop voltage amplification	$R_F = 200\text{ k}\Omega$	$T_A = 25^\circ\text{C}$	70	80	dB
		$T_A = 125^\circ\text{C}$	70	80	
		$T_A = \text{MIN}$	64	80	
Unity-gain bandwidth			1.5		MHz
Common-mode rejection ratio		60	80		dB
Positive output voltage swing		2			V
Negative output voltage swing				1	V
Output (sink) current (FEEDBACK)	$V_{ID} = -0.1\text{ V}$, $V_O = 1.25\text{ V}$	$T_A = 25^\circ\text{C}$	0.5	1.6	mA
		$T_A = 125^\circ\text{C}$	0.4	1.8	
		$T_A = \text{MIN}$	0.3	1.7	
Output (source) current (FEEDBACK)	$V_{ID} = 0.1\text{ V}$, $V_O = 1.25\text{ V}$	$T_A = 25^\circ\text{C}$	-45	-70	μA
		$T_A = 125^\circ\text{C}$	-25	-50	
		$T_A = \text{MIN}$	-15	-70	

 (1) All typical values are at $T_A = 25^\circ\text{C}$, unless otherwise indicated.

Output Section Electrical Characteristics

over recommended operating free-air temperature range, $V_{CC} = 6\text{ V}$, $f = 200\text{ kHz}$ (unless otherwise noted)

PARAMETER	TEST CONDITIONS	MIN	TYP ⁽¹⁾	MAX	UNIT
Collector off-state current	$V_O = 50\text{ V}$			10	μA
Output saturation voltage	$T_A = 25^\circ\text{C}$		1.2	2	V
	$T_A = 125^\circ\text{C}$		1.6	2.4	
	$T_A = \text{MIN}$		1.36	2.2	
Short-circuit output current	$V_O = 6\text{ V}$		90		mA

(1) All typical values are at $T_A = 25^\circ\text{C}$, unless otherwise indicated.

PWM Comparator Section Electrical Characteristics

over recommended operating free-air temperature range, $V_{CC} = 6\text{ V}$, $f = 200\text{ kHz}$ (unless otherwise noted)

PARAMETER	TEST CONDITIONS	MIN	TYP ⁽¹⁾	MAX	UNIT
Input threshold voltage at $f = 10\text{ kHz}$ (FEEDBACK)	Zero duty cycle		2.05	2.25 ⁽²⁾	V
	Maximum duty cycle	1.2 ⁽²⁾	1.45		

(1) All typical values are at $T_A = 25^\circ\text{C}$, unless otherwise indicated.

(2) These parameters are not production tested.

Total Device Electrical Characteristics

over recommended operating free-air temperature range, $V_{CC} = 6\text{ V}$, $f = 200\text{ kHz}$ (unless otherwise noted)

PARAMETER	TEST CONDITIONS	MIN	TYP ⁽¹⁾	MAX	UNIT
Standby supply current	Off-state		1.3	1.8	mA
Average supply current	$R_T = 10\text{ k}\Omega$		1.7	2.4	mA

(1) All typical values are at $T_A = 25^\circ\text{C}$, unless otherwise indicated.

PARAMETER MEASUREMENT INFORMATION

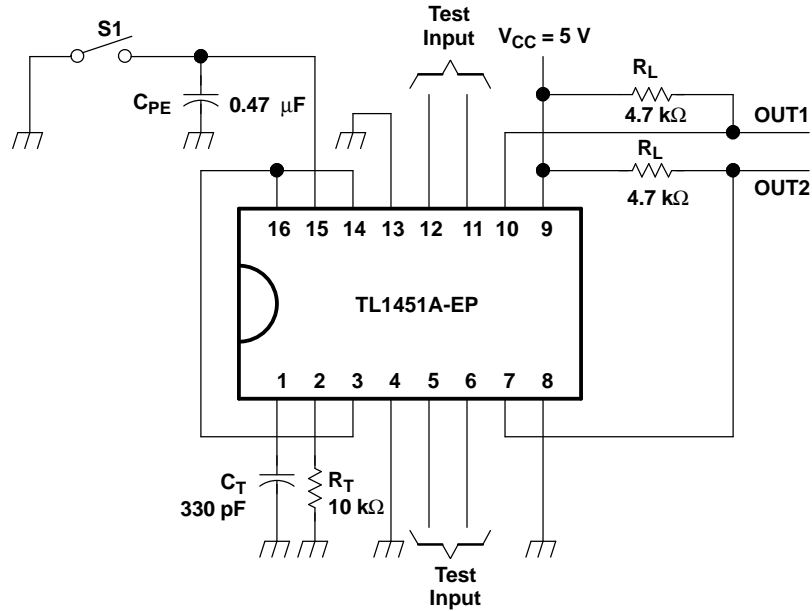
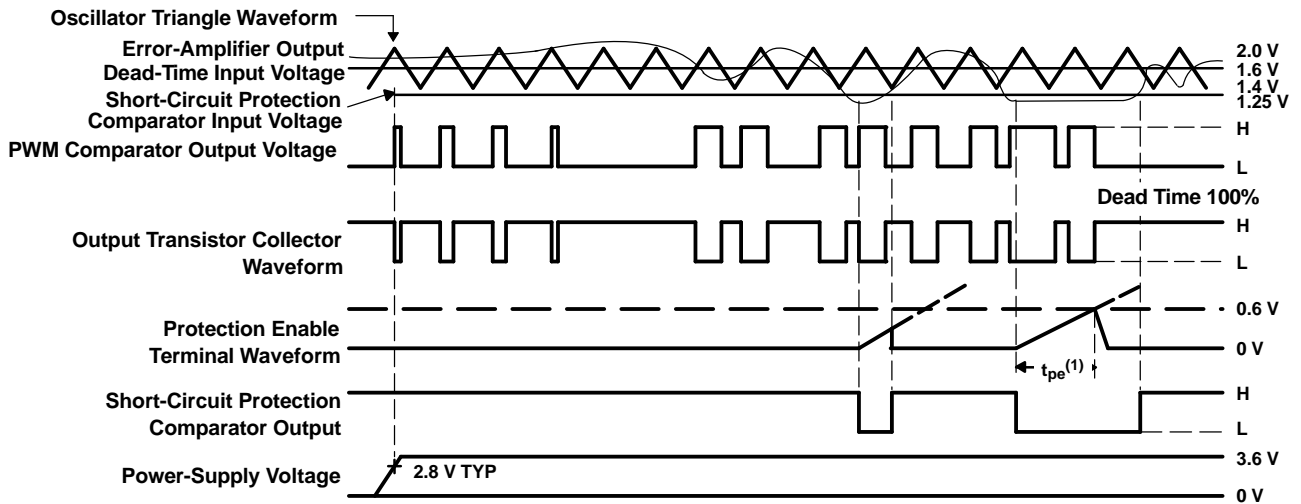

Figure 1. Test Circuit



(1) Protection enable time, $t_{pe} = (0.051 \times 10^6 \times C_{pe})$ in seconds

Figure 2. TL1451A-EP Timing

TYPICAL CHARACTERISTICS

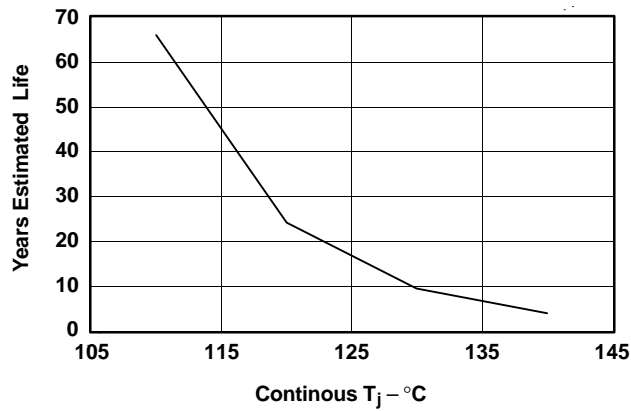

Figure 3. Estimated Deviced Life at Elevated Temperatures for Wirebond Voiding Fail Mode

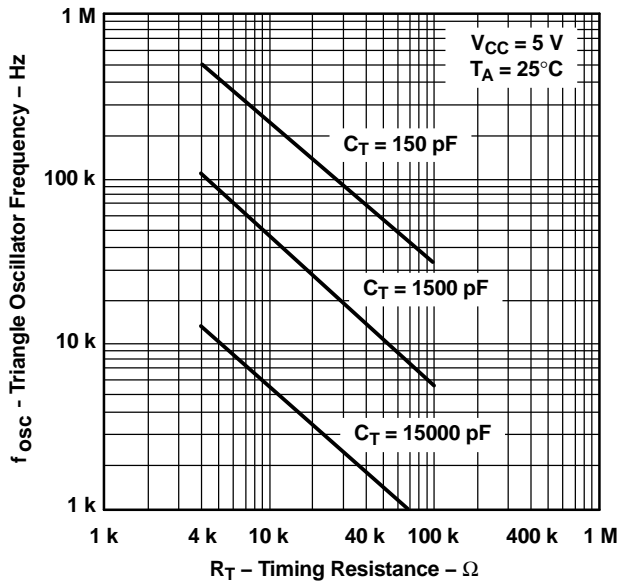

Figure 4. Triangle Oscillator Frequency vs Timing Resistance

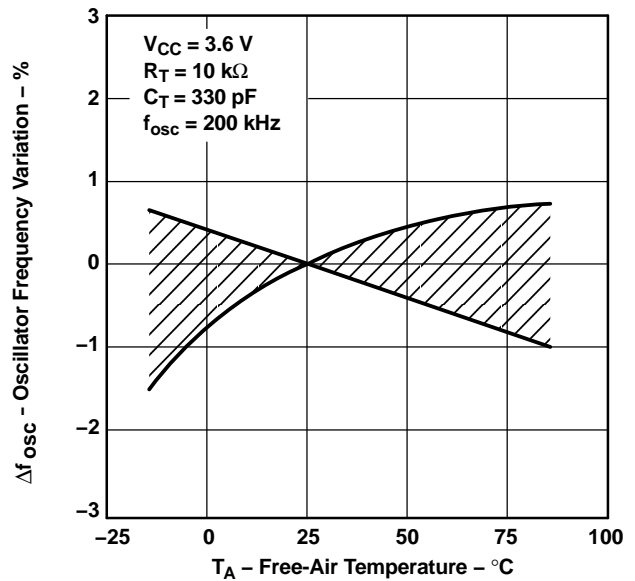

Figure 5. Oscillator Frequency Variation vs Free-Air Temperature

TYPICAL CHARACTERISTICS (continued)

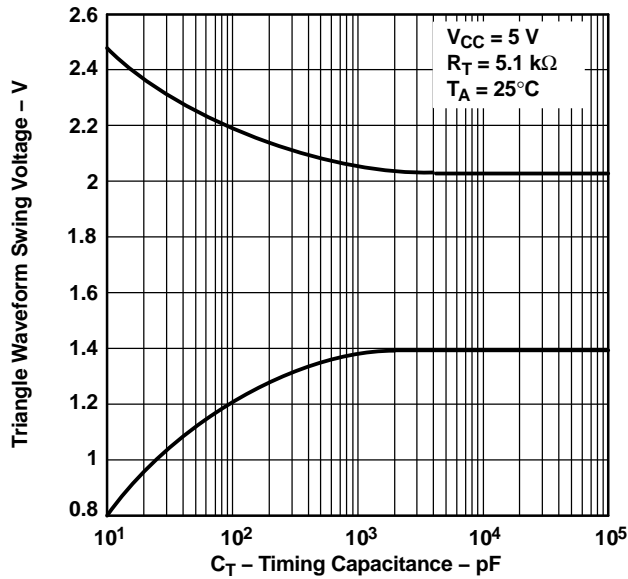

Figure 6. Triangle Waveform Swing Voltage vs Timing Capacitance

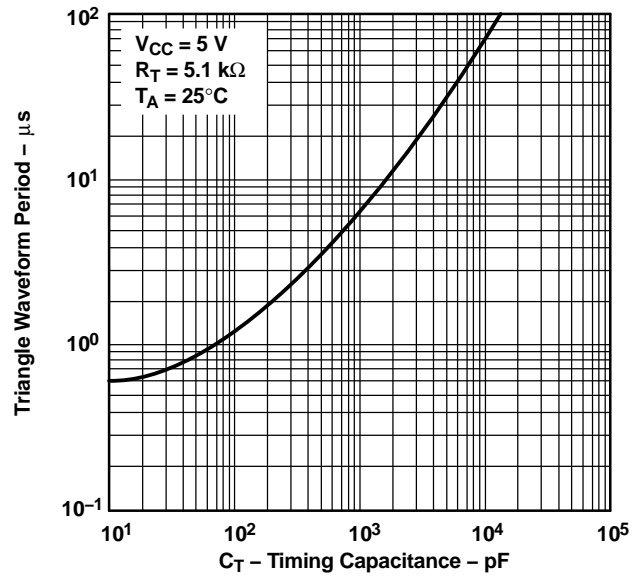

Figure 7. Triangle Waveform Period vs Timing Capacitance

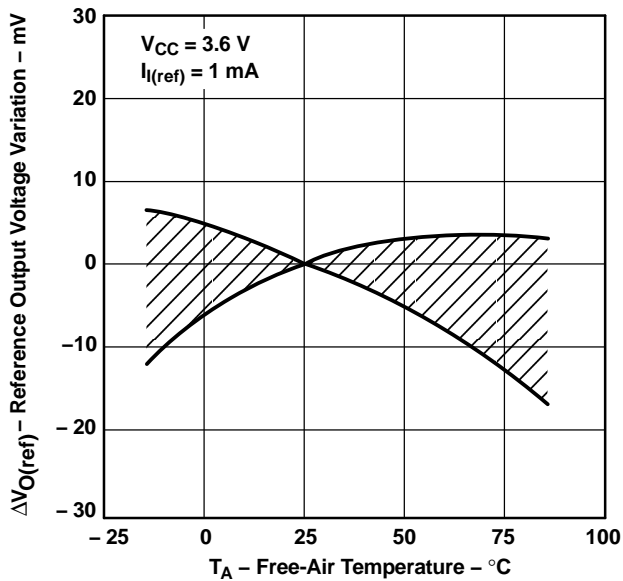

Figure 8. Reference Output Voltage Variation vs Free-Air Temperature

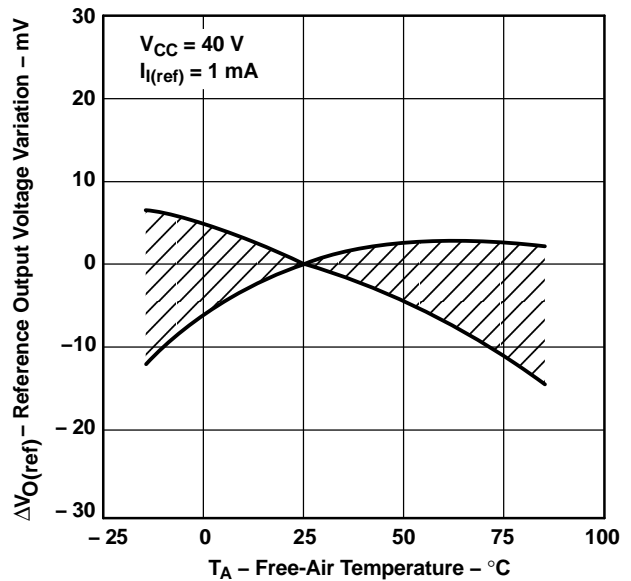

Figure 9. Reference Output Voltage Variation vs Free-Air Temperature

TYPICAL CHARACTERISTICS (continued)

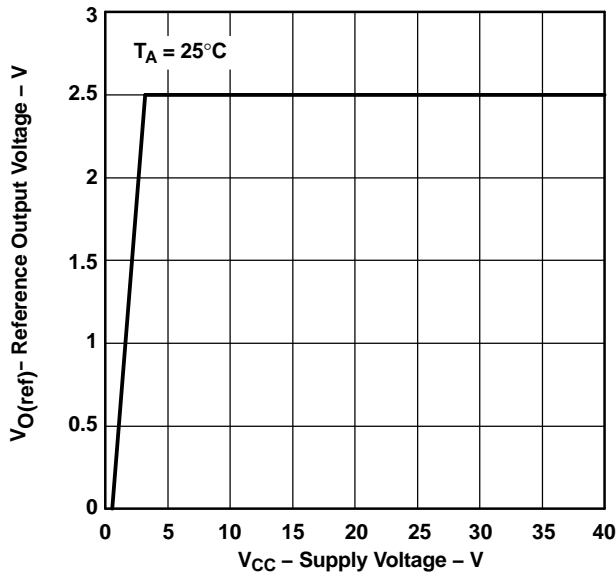

Figure 10. Reference Output Voltage vs Supply Voltage

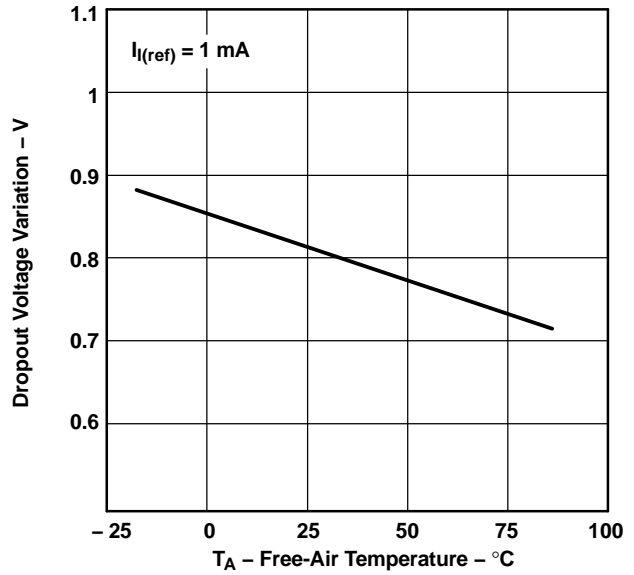

Figure 11. Dropout Voltage Variation vs Free-air Temperature

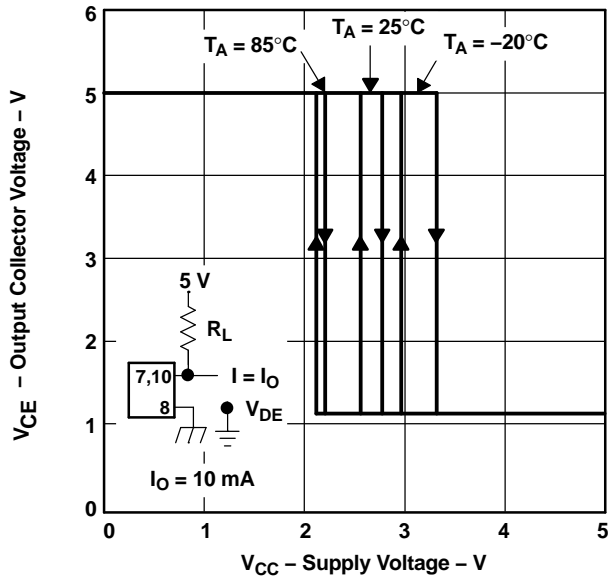

Figure 12. Undervoltage Lockout Hysteresis Characteristics

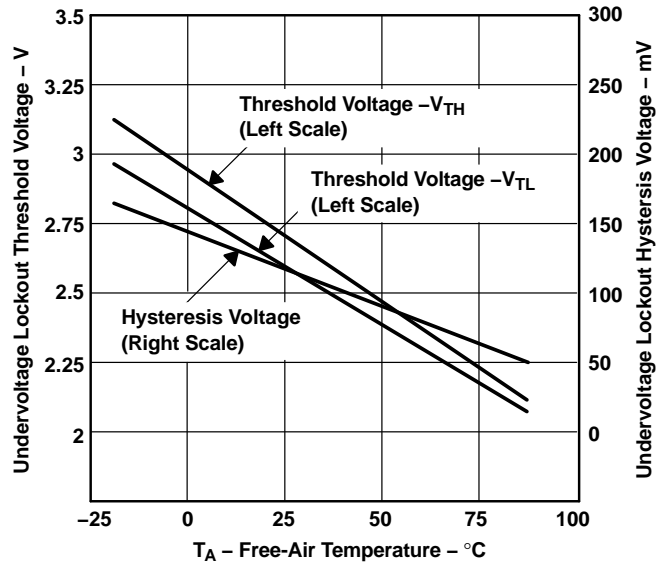

Figure 13. Undervoltage Lockout Characteristics

TYPICAL CHARACTERISTICS (continued)

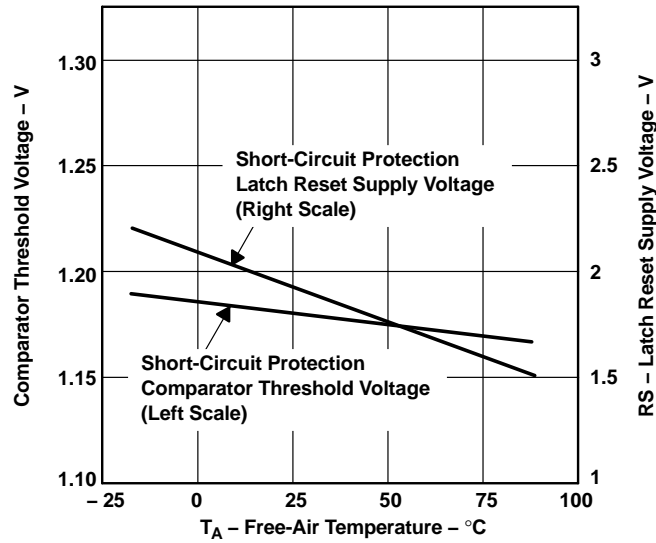

Figure 14. Short-Circuit Protection Characteristics

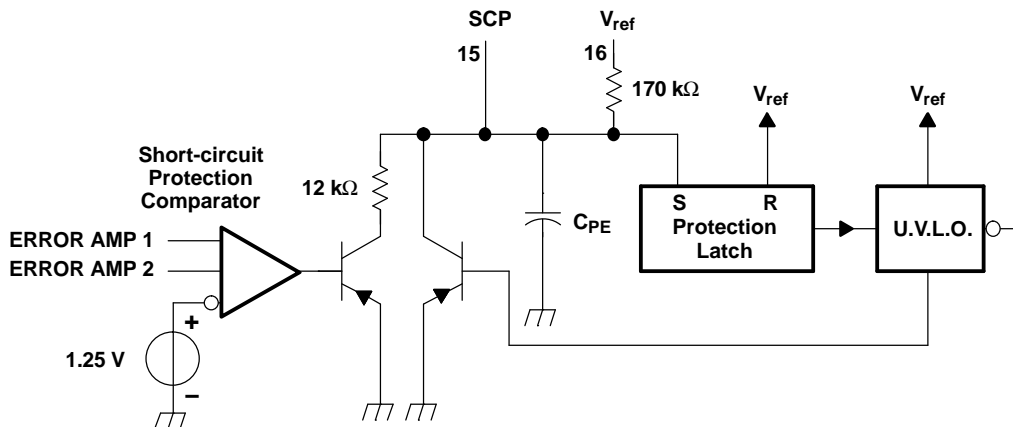
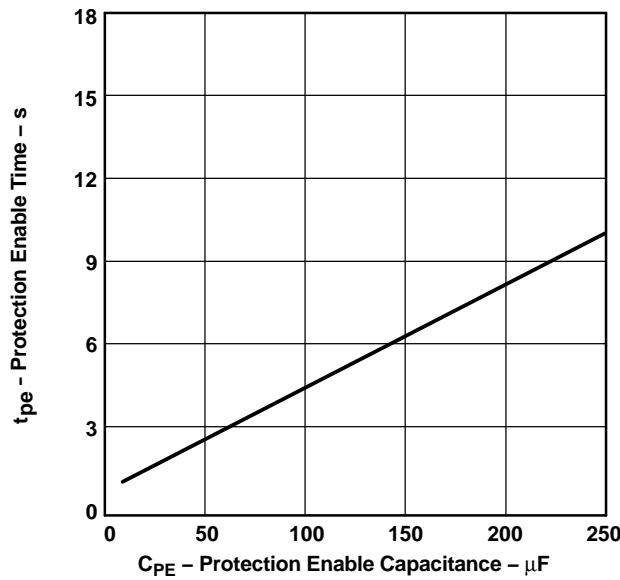

Figure 15. Protection Enable Time vs Protection Enable Capacitance

TYPICAL CHARACTERISTICS (continued)

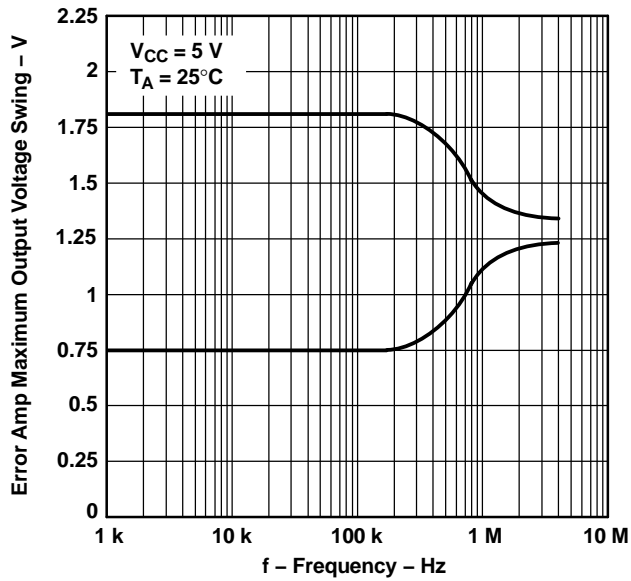

Figure 16. Error Amplifier Maximum Output Voltage Swing vs Frequency

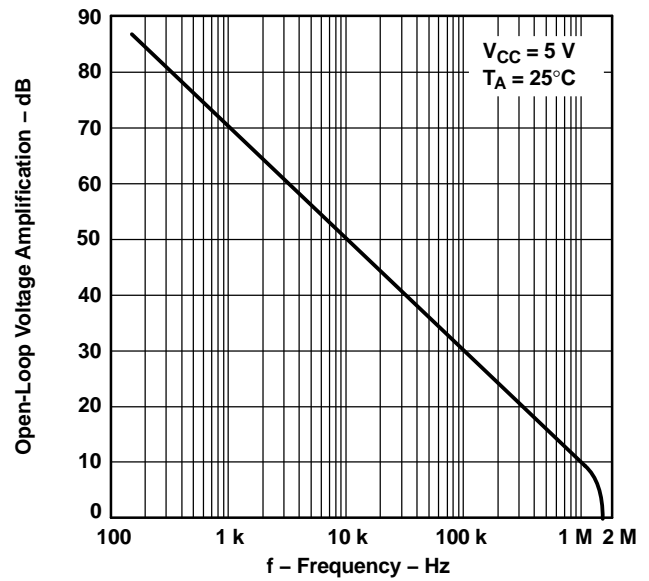

Figure 17. Open-Loop Voltage Amplification vs Frequency

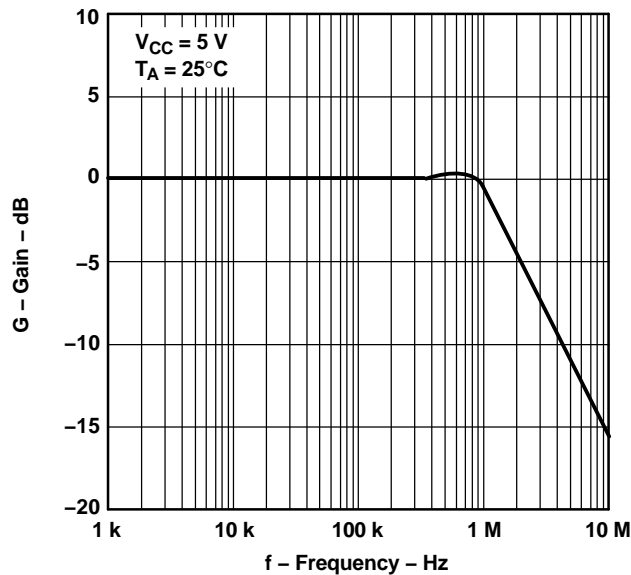

Figure 18. Gain (Amplifier in Unity-Gain Configuration vs Frequency)

TYPICAL CHARACTERISTICS (continued)

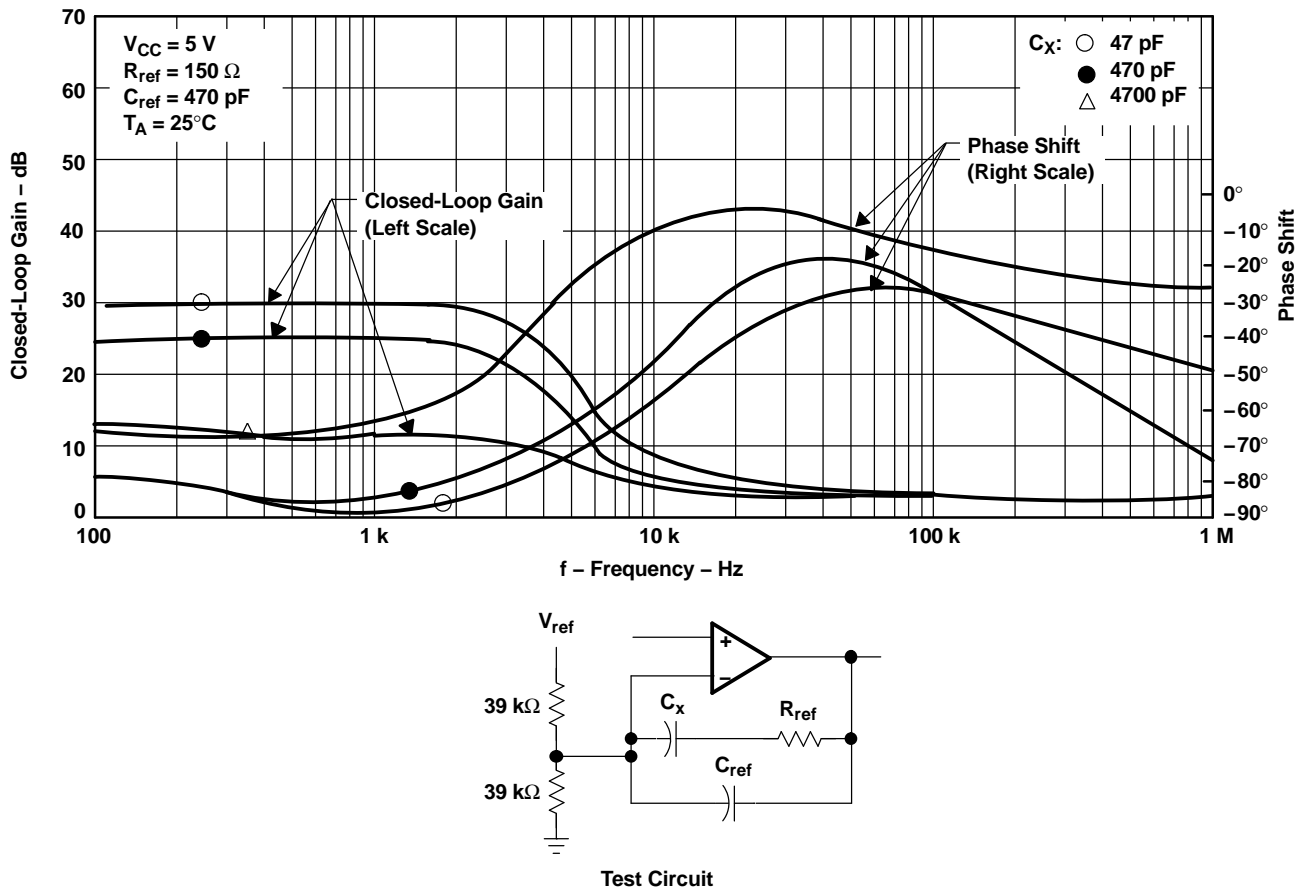
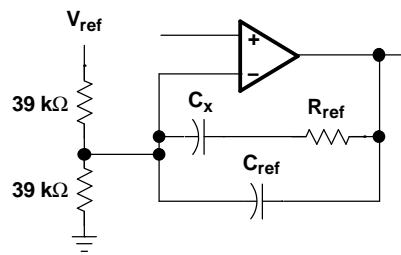
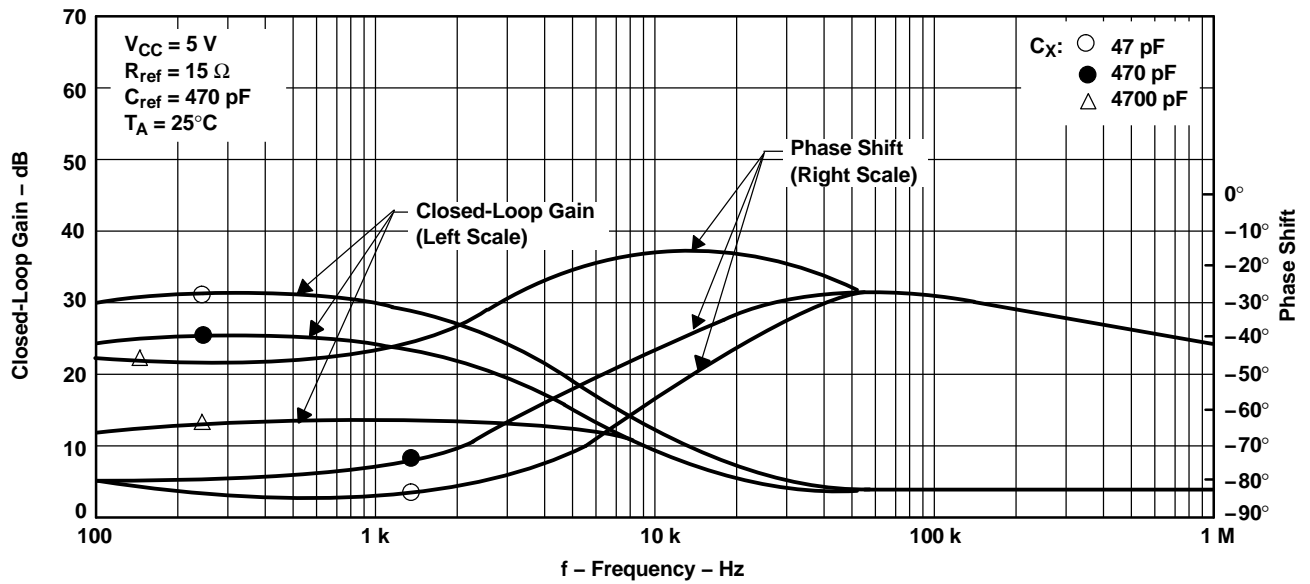

Figure 19. Closed-Loop Gain and Phase Shift vs Frequency

TYPICAL CHARACTERISTICS (continued)



Test Circuit

Figure 20. Closed-Loop Gain and Phase Shift vs Frequency

TYPICAL CHARACTERISTICS (continued)

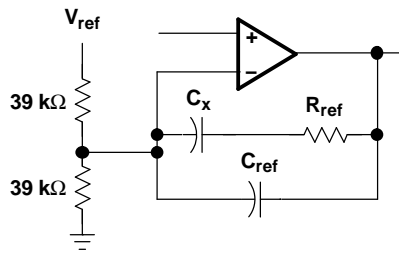
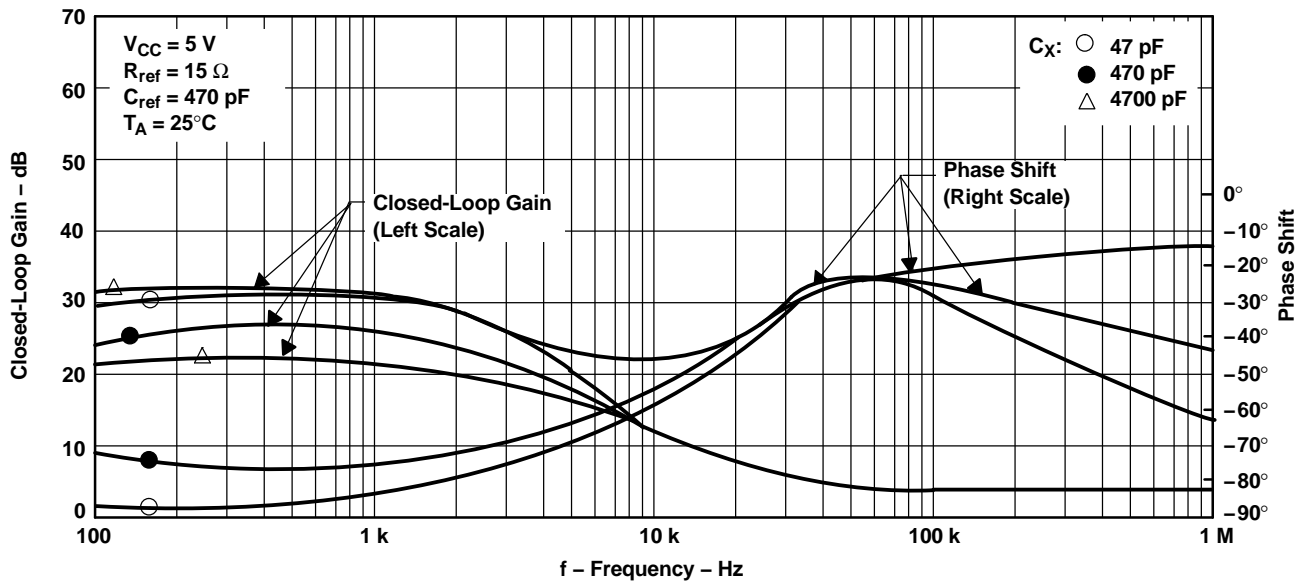

Test Circuit

Figure 21. Closed-Loop Gain and Phase Shift vs Frequency

TYPICAL CHARACTERISTICS (continued)

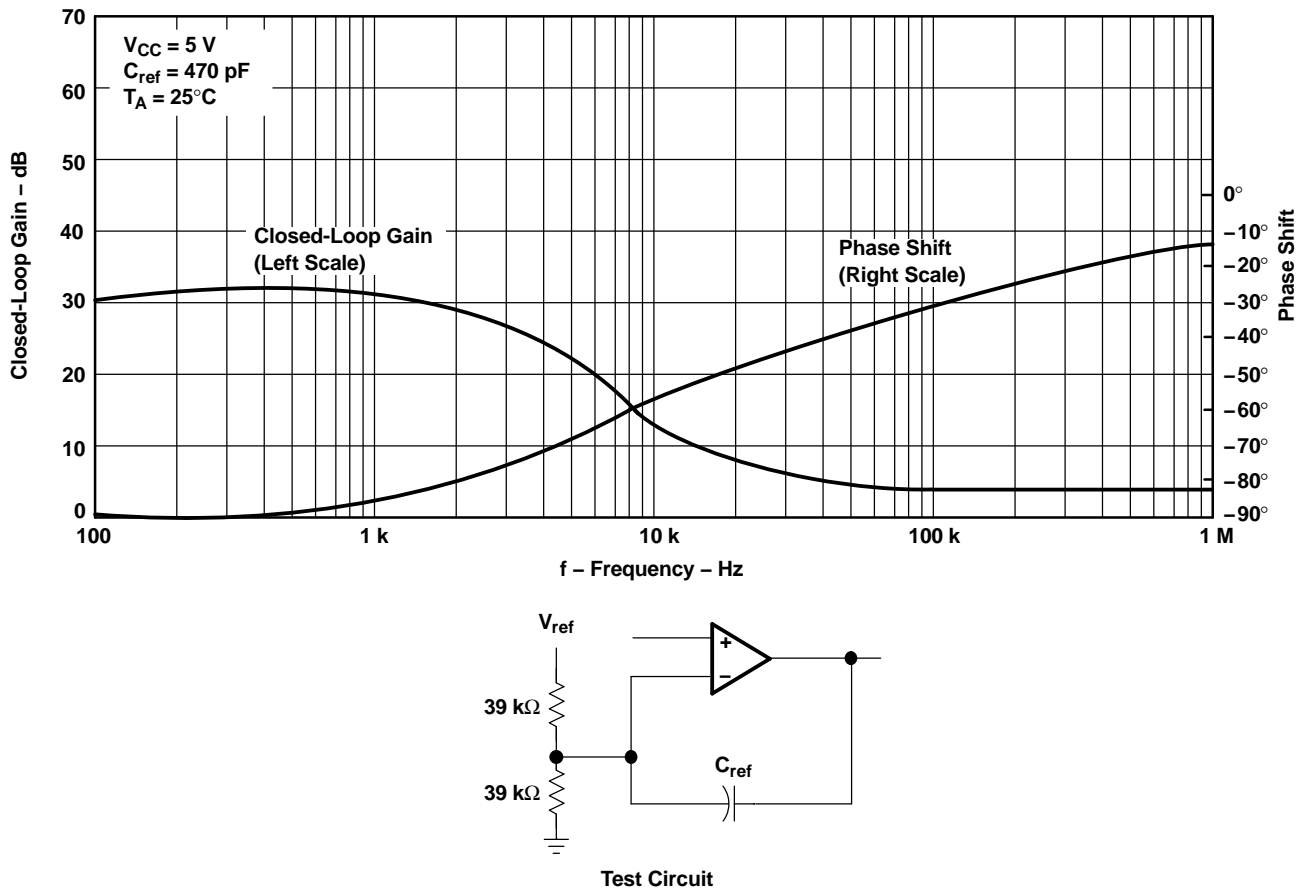

Figure 22. Closed-Loop Gain and Phase Shift vs Frequency

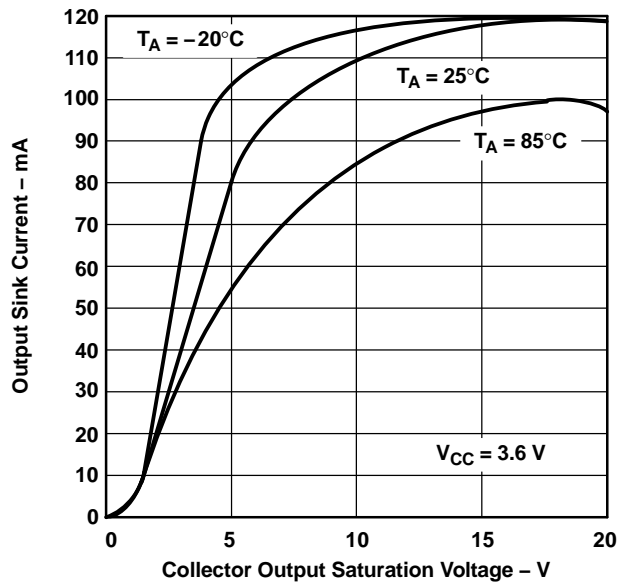

Figure 23. Output Sink Current vs Collector Output Saturation Voltage

TYPICAL CHARACTERISTICS (continued)

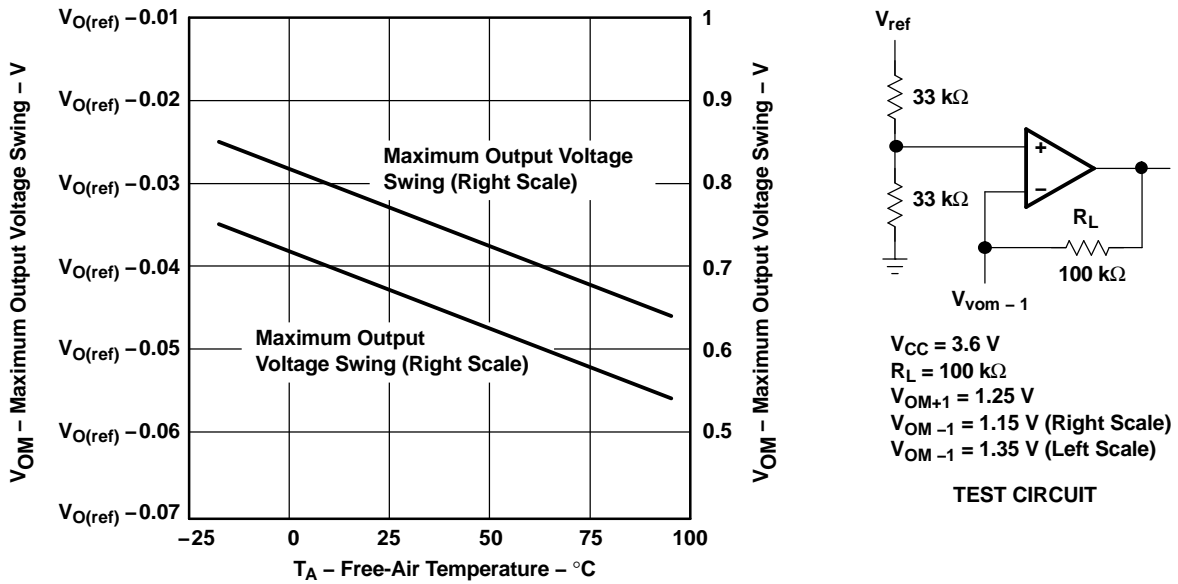

Figure 24. Maximum Output Voltage Swing vs Free-Air Temperature

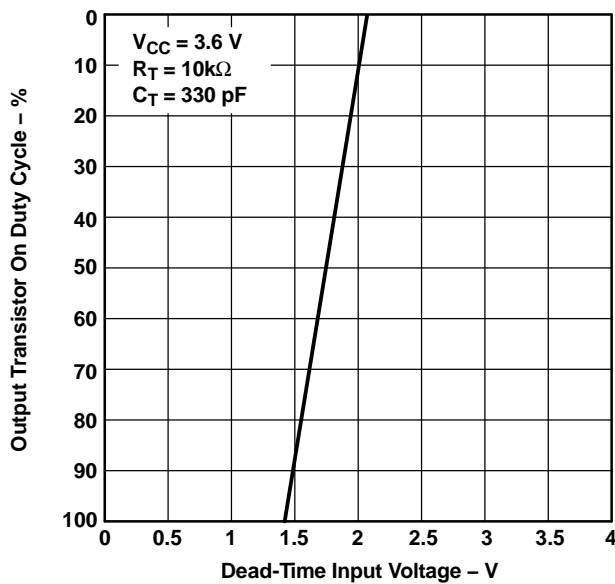

Figure 25. Output Transistor On Duty Cycle vs Dead-Time Input Voltage

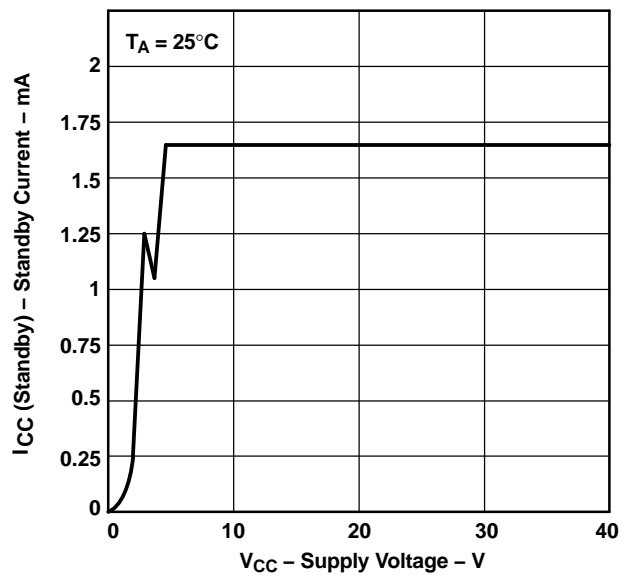

Figure 26. Standby Current vs Supply Voltage

TYPICAL CHARACTERISTICS (continued)

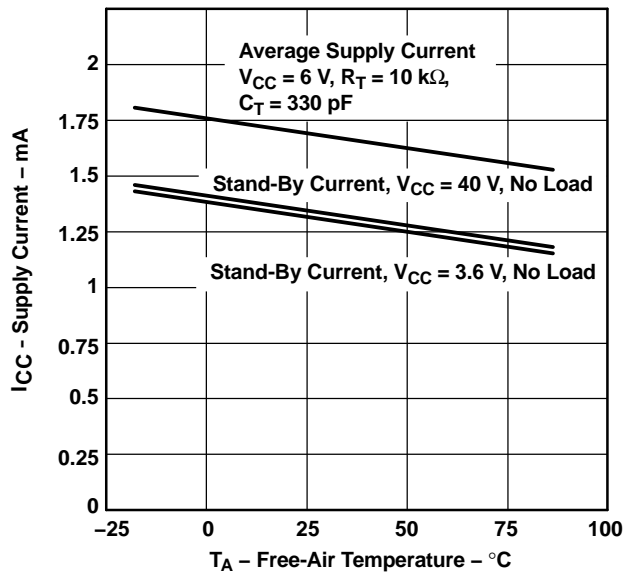

Figure 27. Standby Current vs Free-Air Temperature

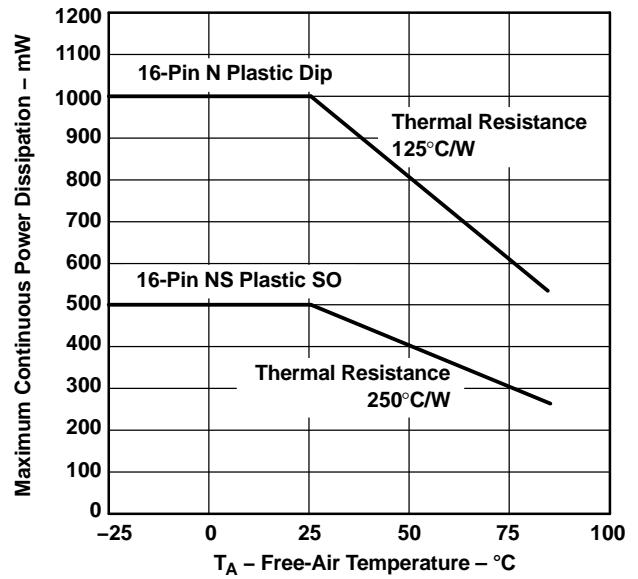

Figure 28. Maximum Continuous Power Dissipation vs Free-Air Temperature

APPLICATION INFORMATION

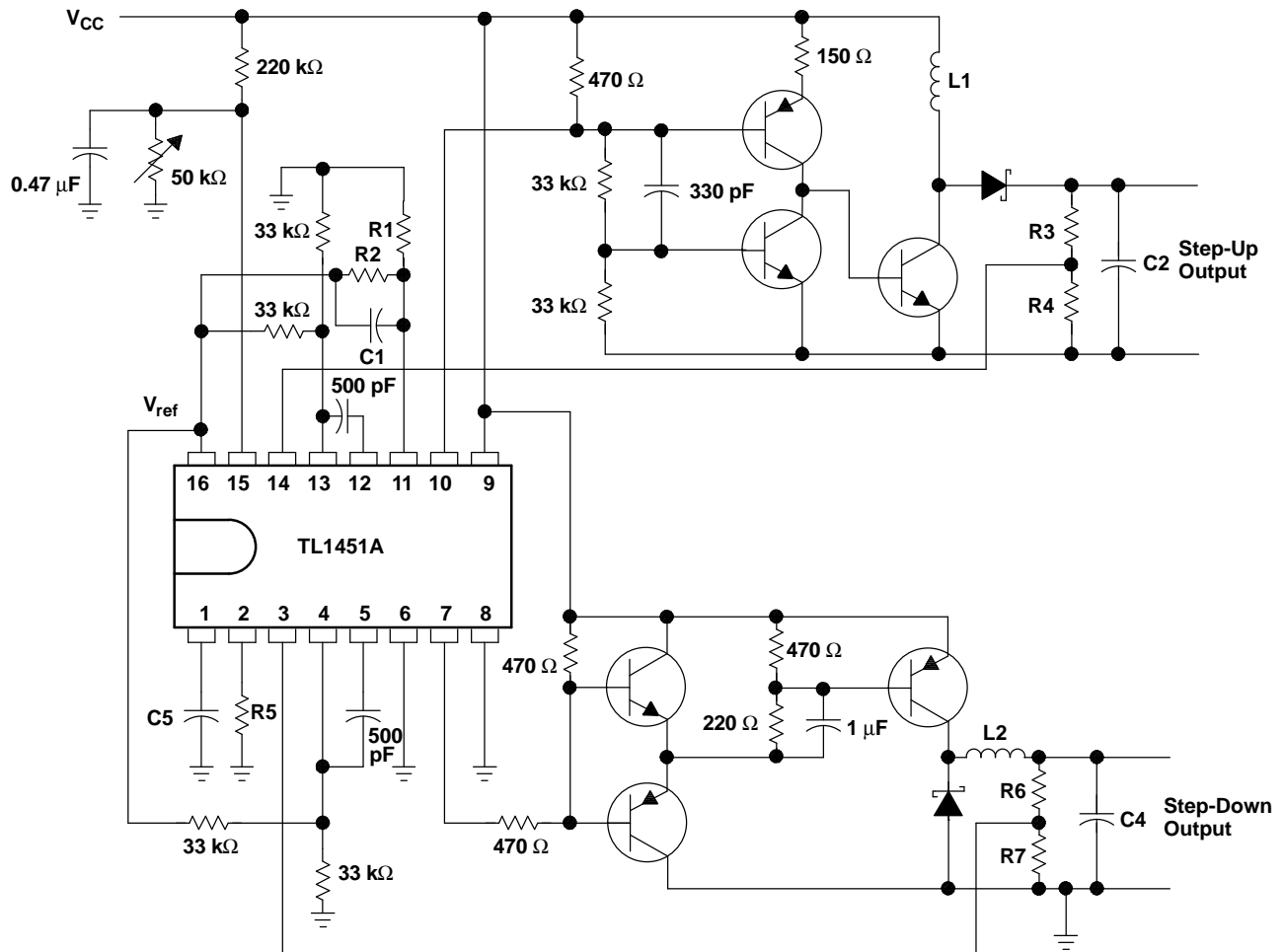

Figure 29. High-Speed Dual Switching Regulator

PACKAGING INFORMATION

Orderable Device	Status (1)	Package Type	Package Drawing	Pins	Package Qty	Eco Plan (2)	Lead finish/ Ball material (6)	MSL Peak Temp (3)	Op Temp (°C)	Device Marking (4/5)	Samples
TL1451AMDREP	ACTIVE	SOIC	D	16	2500	RoHS & Green	NIPDAU	Level-1-260C-UNLIM	-55 to 125	TL1451EP	Samples
V62/06611-01XE	ACTIVE	SOIC	D	16	2500	RoHS & Green	NIPDAU	Level-1-260C-UNLIM	-55 to 125	TL1451EP	Samples

(1) The marketing status values are defined as follows:

ACTIVE: Product device recommended for new designs.

LIFEBUY: TI has announced that the device will be discontinued, and a lifetime-buy period is in effect.

NRND: Not recommended for new designs. Device is in production to support existing customers, but TI does not recommend using this part in a new design.

PREVIEW: Device has been announced but is not in production. Samples may or may not be available.

OBSOLETE: TI has discontinued the production of the device.

(2) **RoHS:** TI defines "RoHS" to mean semiconductor products that are compliant with the current EU RoHS requirements for all 10 RoHS substances, including the requirement that RoHS substance do not exceed 0.1% by weight in homogeneous materials. Where designed to be soldered at high temperatures, "RoHS" products are suitable for use in specified lead-free processes. TI may reference these types of products as "Pb-Free".

RoHS Exempt: TI defines "RoHS Exempt" to mean products that contain lead but are compliant with EU RoHS pursuant to a specific EU RoHS exemption.

Green: TI defines "Green" to mean the content of Chlorine (Cl) and Bromine (Br) based flame retardants meet JS709B low halogen requirements of <=1000ppm threshold. Antimony trioxide based flame retardants must also meet the <=1000ppm threshold requirement.

(3) MSL, Peak Temp. - The Moisture Sensitivity Level rating according to the JEDEC industry standard classifications, and peak solder temperature.

(4) There may be additional marking, which relates to the logo, the lot trace code information, or the environmental category on the device.

(5) Multiple Device Markings will be inside parentheses. Only one Device Marking contained in parentheses and separated by a "~" will appear on a device. If a line is indented then it is a continuation of the previous line and the two combined represent the entire Device Marking for that device.

(6) Lead finish/Ball material - Orderable Devices may have multiple material finish options. Finish options are separated by a vertical ruled line. Lead finish/Ball material values may wrap to two lines if the finish value exceeds the maximum column width.

Important Information and Disclaimer:The information provided on this page represents TI's knowledge and belief as of the date that it is provided. TI bases its knowledge and belief on information provided by third parties, and makes no representation or warranty as to the accuracy of such information. Efforts are underway to better integrate information from third parties. TI has taken and continues to take reasonable steps to provide representative and accurate information but may not have conducted destructive testing or chemical analysis on incoming materials and chemicals. TI and TI suppliers consider certain information to be proprietary, and thus CAS numbers and other limited information may not be available for release.

In no event shall TI's liability arising out of such information exceed the total purchase price of the TI part(s) at issue in this document sold by TI to Customer on an annual basis.

OTHER QUALIFIED VERSIONS OF TL1451A-EP :

- Catalog: [TL1451A](#)
- Automotive: [TL1451A-Q1](#)

NOTE: Qualified Version Definitions:

- Catalog - TI's standard catalog product
- Automotive - Q100 devices qualified for high-reliability automotive applications targeting zero defects

TAPE AND REEL INFORMATION

QUADRANT ASSIGNMENTS FOR PIN 1 ORIENTATION IN TAPE

*All dimensions are nominal

Device	Package Type	Package Drawing	Pins	SPQ	Reel Diameter (mm)	Reel Width W1 (mm)	A0 (mm)	B0 (mm)	K0 (mm)	P1 (mm)	W (mm)	Pin1 Quadrant
TL1451AMDREP	SOIC	D	16	2500	330.0	16.4	6.5	10.3	2.1	8.0	16.0	Q1

TAPE AND REEL BOX DIMENSIONS

*All dimensions are nominal

Device	Package Type	Package Drawing	Pins	SPQ	Length (mm)	Width (mm)	Height (mm)
TL1451AMDREP	SOIC	D	16	2500	350.0	350.0	43.0

D (R-PDSO-G16)

PLASTIC SMALL OUTLINE



4040047-6/M 06/11

- NOTES:
- A. All linear dimensions are in inches (millimeters).
 - B. This drawing is subject to change without notice.
 -  C. Body length does not include mold flash, protrusions, or gate burrs. Mold flash, protrusions, or gate burrs shall not exceed 0.006 (0,15) each side.
 -  D. Body width does not include interlead flash. Interlead flash shall not exceed 0.017 (0,43) each side.
 - E. Reference JEDEC MS-012 variation AC.

IMPORTANT NOTICE AND DISCLAIMER

TI PROVIDES TECHNICAL AND RELIABILITY DATA (INCLUDING DATA SHEETS), DESIGN RESOURCES (INCLUDING REFERENCE DESIGNS), APPLICATION OR OTHER DESIGN ADVICE, WEB TOOLS, SAFETY INFORMATION, AND OTHER RESOURCES "AS IS" AND WITH ALL FAULTS, AND DISCLAIMS ALL WARRANTIES, EXPRESS AND IMPLIED, INCLUDING WITHOUT LIMITATION ANY IMPLIED WARRANTIES OF MERCHANTABILITY, FITNESS FOR A PARTICULAR PURPOSE OR NON-INFRINGEMENT OF THIRD PARTY INTELLECTUAL PROPERTY RIGHTS.

These resources are intended for skilled developers designing with TI products. You are solely responsible for (1) selecting the appropriate TI products for your application, (2) designing, validating and testing your application, and (3) ensuring your application meets applicable standards, and any other safety, security, regulatory or other requirements.

These resources are subject to change without notice. TI grants you permission to use these resources only for development of an application that uses the TI products described in the resource. Other reproduction and display of these resources is prohibited. No license is granted to any other TI intellectual property right or to any third party intellectual property right. TI disclaims responsibility for, and you will fully indemnify TI and its representatives against, any claims, damages, costs, losses, and liabilities arising out of your use of these resources.

TI's products are provided subject to [TI's Terms of Sale](#) or other applicable terms available either on [ti.com](https://www.ti.com) or provided in conjunction with such TI products. TI's provision of these resources does not expand or otherwise alter TI's applicable warranties or warranty disclaimers for TI products.

TI objects to and rejects any additional or different terms you may have proposed.

Mailing Address: Texas Instruments, Post Office Box 655303, Dallas, Texas 75265
Copyright © 2023, Texas Instruments Incorporated