

TPD6F002 Six-Channel EMI Filter for LCD Display and FPD-Link

1 Features

- Six-Channel EMI Filtering for Data Ports
 - –57-dB Crosstalk Attenuation at 100 MHz
 - –35-dB Insertion Loss at 800 MHz
 - –3-dB Bandwidth at 100 MHz
- Robust ESD Protection Exceeds IEC 61000-4-2 (Level 4)
 - ±20-kV IEC 61000-4-2 Contact Discharge
 - ±30-kV IEC 61000-4-2 Air-Gap Discharge
- Pi-Style (C-R-C) Filter Configuration (R = 100 Ω, C_{TOTAL} = 34 pF)
- Low Leakage Current: 20 nA (Maximum)
- Space-Saving WSON Package (3 mm × 1.35 mm)

2 Applications

- LCD Display Interface
- GPIO
- Memory Interface
- Data Lines at Flex Cables
- FPD-Link

3 Description

The TPD6F002 device is a highly-integrated device that provides a six-channel Electromagnetic Interference (EMI) filter and a TVS based ESD protection diode array. The low-pass filter array suppresses EMI/RFI emissions for data ports subject to electromagnetic interference. The TVS diode array is rated to dissipate ESD strikes above the maximum level specified in the IEC 61000-4-2 international standard. The high level of integration, combined with its small easy-to-route DSV package, allows this device to provide great circuit protection for LCD displays, memory interfaces, GPIO lines, and FPD-Link.

Device Information⁽¹⁾

PART NUMBER	PACKAGE	BODY SIZE (NOM)
TPD6F002	WSON (12)	3.00 mm × 1.35 mm

(1) For all available packages, see the orderable addendum at the end of the data sheet.

Equivalent Schematic Representation

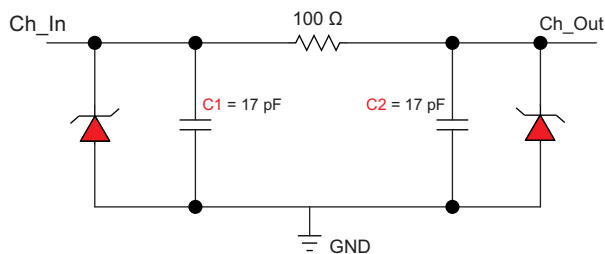

Copyright © 2016, Texas Instruments Incorporated



Table of Contents

1 Features 1 2 Applications 1 3 Description 1 4 Revision History 2 5 Pin Configuration and Functions 3 6 Specifications 3 6.1 Absolute Maximum Ratings 3 6.2 ESD Ratings 3 6.3 Recommended Operating Conditions 3 6.4 Thermal Information 4 6.5 Electrical Characteristics 4 6.6 Typical Characteristics 5 7 Detailed Description 6 7.1 Overview 6 7.2 Functional Block Diagram 6	7.3 Feature Description 6 7.4 Device Functional Modes 6 8 Application and Implementation 7 8.1 Application Information 7 8.2 Typical Application 7 9 Power Supply Recommendations 9 10 Layout 9 10.1 Layout Guidelines 9 10.2 Layout Example 9 11 Device and Documentation Support 10 11.1 Community Resources 10 11.2 Trademarks 10 11.3 Electrostatic Discharge Caution 10 11.4 Glossary 10 12 Mechanical, Packaging, and Orderable Information 10
--	---

4 Revision History

NOTE: Page numbers for previous revisions may differ from page numbers in the current version.

Changes from Revision A (November 2009) to Revision B	Page
<ul style="list-style-type: none"> • Added <i>ESD Ratings</i> table, <i>Feature Description</i> section, <i>Device Functional Modes</i>, <i>Application and Implementation</i> section, <i>Power Supply Recommendations</i> section, <i>Layout</i> section, <i>Device and Documentation Support</i> section, and <i>Mechanical, Packaging, and Orderable Information</i> section. 	1
<ul style="list-style-type: none"> • Removed <i>Ordering Information</i> table 	1

5 Pin Configuration and Functions

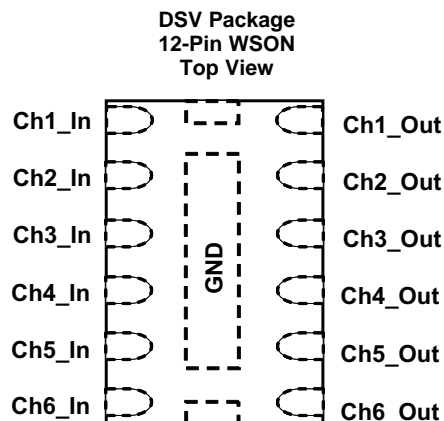

Pin Functions

PIN		TYPE	DESCRIPTION
NAME	NO.		
ChX_In	1, 2, 3, 4, 5, 6	I/O	ESD-protected channel, connected to corresponding ChX_Out
ChX_Out	7, 8, 9, 10, 11, 12	I/O	ESD-protected channel, connected to corresponding ChX_Inx
GND	GND	G	Ground

6 Specifications

6.1 Absolute Maximum Ratings

over operating free-air temperature range (unless otherwise noted)⁽¹⁾

		MIN	MAX	UNIT
V _{IO}	I/O to GND		6	V
	Lead temperature (soldering, 10 s)		300	°C
T _J	Junction temperature		150	°C
T _{stg}	Storage temperature	-65	150	°C

(1) Stresses beyond those listed under *Absolute Maximum Ratings* may cause permanent damage to the device. These are stress ratings only, which do not imply functional operation of the device at these or any other conditions beyond those indicated under *Recommended Operating Conditions*. Exposure to absolute-maximum-rated conditions for extended periods may affect device reliability.

6.2 ESD Ratings

		VALUE	UNIT
V _(ESD)	Electrostatic discharge	Human-body model ⁽¹⁾	±15000
		IEC 61000-4-2 contact discharge	±20000
		IEC 61000-4-2 air-gap discharge	±30000

(1) JEDEC document JEP155 states that 500-V HBM allows safe manufacturing with a standard ESD control process.

6.3 Recommended Operating Conditions

over operating free-air temperature range (unless otherwise noted)

		MIN	MAX	UNIT
V _{IO}	Input pin voltage	0	5.5	V
T _A	Operating free-air temperature	-40	85	°C

6.4 Thermal Information

THERMAL METRIC ⁽¹⁾		TPD6F002	
		DSV (WSON)	
		12 PINS	
			UNIT
$R_{\theta JA}$	Junction-to-ambient thermal resistance	120.7	°C/W
$R_{\theta JC(top)}$	Junction-to-case (top) thermal resistance	104.4	°C/W
$R_{\theta JB}$	Junction-to-board thermal resistance	78.5	°C/W
Ψ_{JT}	Junction-to-top characterization parameter	13	°C/W
Ψ_{JB}	Junction-to-board characterization parameter	77.7	°C/W
$R_{\theta JC(bot)}$	Junction-to-case (bottom) thermal resistance	66.5	°C/W

(1) For more information about traditional and new thermal metrics, see the *Semiconductor and IC Package Thermal Metrics* application report, [SPRA953](#).

6.5 Electrical Characteristics

$T_A = -40^\circ\text{C}$ to 85°C (Unless otherwise noted)

PARAMETER		TEST CONDITIONS	MIN	TYP ⁽¹⁾	MAX	UNIT
V_{BR}	DC breakdown voltage	$I_{IO} = 10 \mu\text{A}$	6			V
R	Resistance		85	100	115	Ω
C	Capacitance (C1 or C2)	$V_{IO} = 2.5 \text{ V}$		17		pF
I_{IO}	Channel leakage current	$V_{IO} = 3.3 \text{ V}$		1	20	nA
f_c	Cutoff frequency	$Z_{SOURCE} = 50 \Omega$, $Z_{LOAD} = 50 \Omega$		100		MHz

(1) Typical values are at $T_A = 25^\circ\text{C}$.

6.6 Typical Characteristics

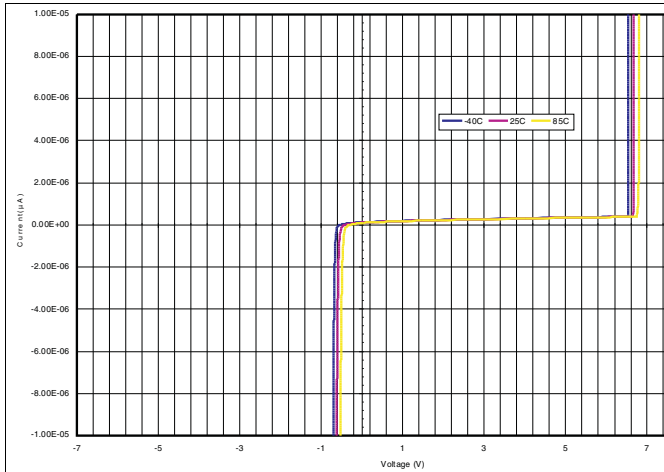

Figure 1. DC Voltage-Current Sweep Across Input, Output Pins

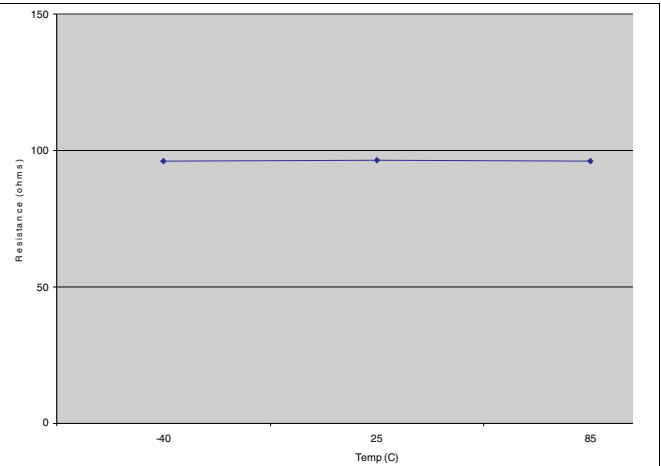
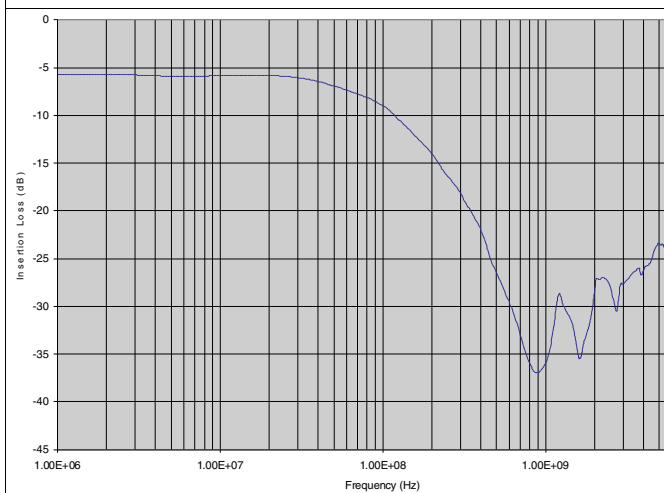

Figure 2. Series Resistance vs Temperature



T_A = 25°C, DC Bias = 0 V, 50 Ω Environment

Figure 3. TPD6F002 Typical Insertion-Loss Characteristics

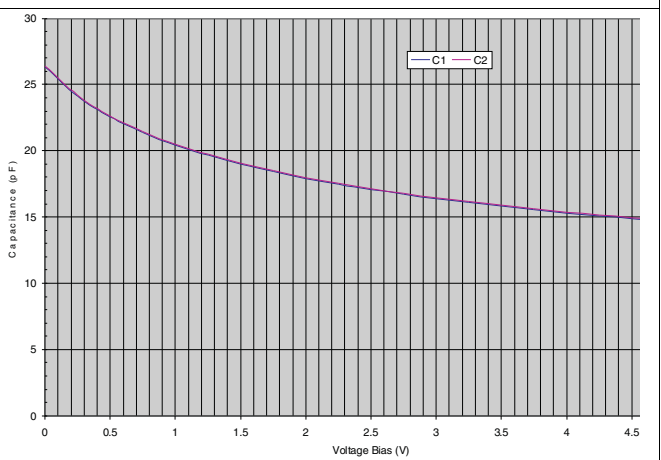

Figure 4. Capacitance (C1 or C2) vs Bias Voltage

7 Detailed Description

7.1 Overview

The TPD6F002 is a highly-integrated ESD protection and EMI filtering device intended for use where small size and ease of routing are important. Common applications include LCD display interfaces, memory interfaces, GPIO lines, and FPD-Link.

7.2 Functional Block Diagram

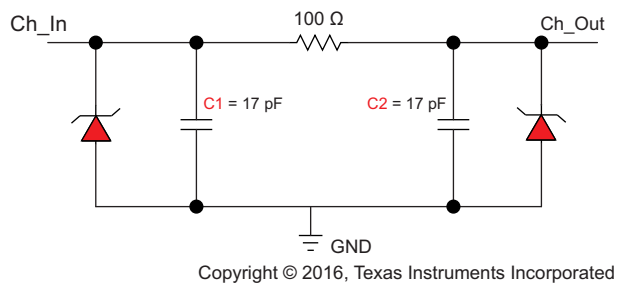

7.3 Feature Description

7.3.1 Six-Channel EMI Filtering

This device provides six channels for EMI filtering of data lines with the following parameters:

- –57-dB Crosstalk Attenuation at 100 MHz
- –35-dB Insertion Loss at 800 MHz
- –3-dB Bandwidth at 100 MHz

7.3.2 Pi-Style Filter Configuration

This device has a pi-style filtering configuration composed of a series resistor and two capacitors in parallel with the I/O pins. The typical resistor value is 100 Ω and the typical capacitor values are 17 pF each.

7.3.3 Robust ESD Protection

The ESD protection on all pins exceeds the IEC 61000-4-2 level 4 standard. Contact ESD is rated at ±20 kV and Air-gap ESD is rated at ±30 kV.

7.3.4 Low Leakage Current

The I/O pins feature an ultra-low leakage current of 20 nA (maximum) with a bias of 3.3 V

7.3.5 Space-Saving WSON Package

The layout of this device makes it easy to add protection to existing layouts. The packages offer flow-through routing which requires minimal changes to existing layout for addition of these devices. Additionally, the device offers a small, space-saving package that takes a minimal footprint on the board.

7.4 Device Functional Modes

The TPD6F002 is a passive integrated circuit that passively filters EMI and triggers when voltages are above V_{BR} or below the lower diode voltage (–0.6 V). During ESD events, voltages as high as ±30 kV (air) can be directed to ground through the internal diode network. Once the voltages on the protected line fall below the trigger levels, the device reverts to passive.

8 Application and Implementation

NOTE

Information in the following applications sections is not part of the TI component specification, and TI does not warrant its accuracy or completeness. TI's customers are responsible for determining suitability of components for their purposes. Customers should validate and test their design implementation to confirm system functionality.

8.1 Application Information

The TPD6F002 offers highly-integrated ESD protection and EMI filtering for 6 channels per device. Take care during implementation to make sure that this device fits the application appropriately.

8.2 Typical Application

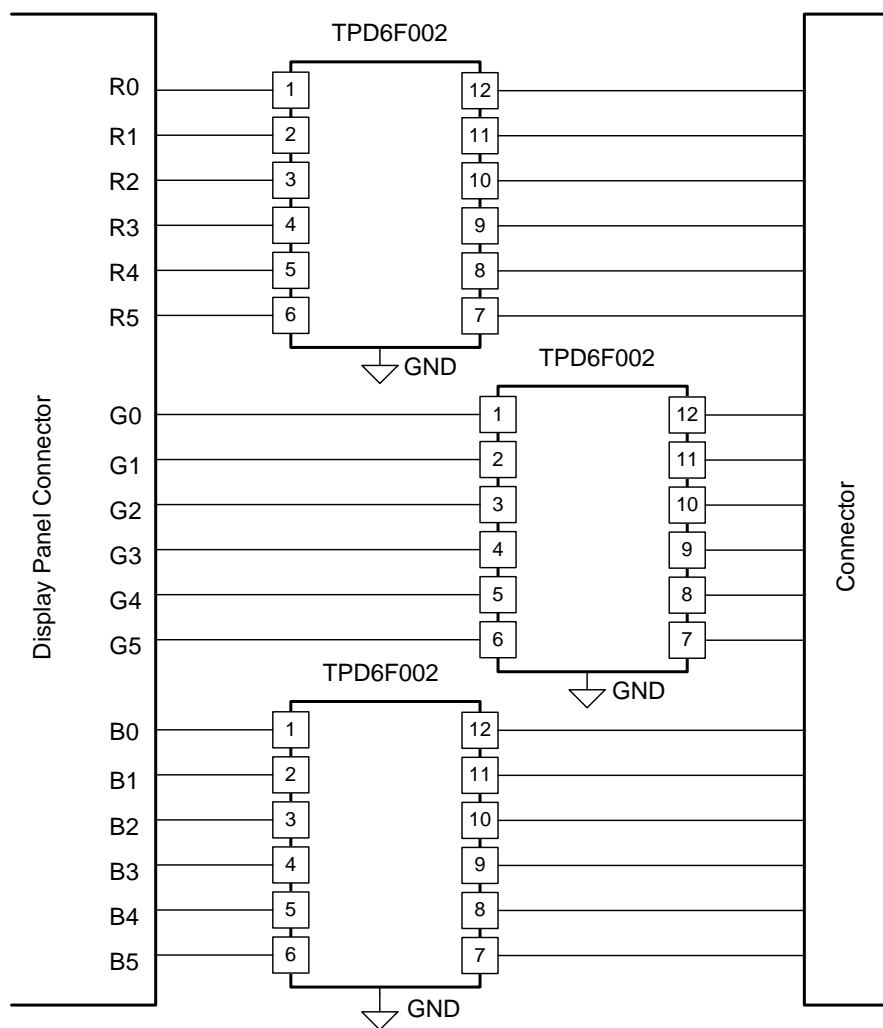

Copyright © 2016, Texas Instruments Incorporated

Figure 5. Display Panel Schematic

8.2.1 Design Requirements

For this design example, three TPD6F002 devices are being used in an 18-bit display panel application. This provides a complete ESD and EMI protection solution for the display connector.

Table 1 lists the parameters for this display panel application.

Table 1. Design Parameters

DESIGN PARAMETER	VALUE
Signal range on all pins except GND	0 V to 5 V
Operating Frequency	50 MHz

8.2.2 Detailed Design Procedure

To begin the design process, some design parameters must be decided; the designer must know the following:

- Signal range of all the protected lines
- Operating frequency
- Crosstalk response

8.2.2.1 Signal Range on All Protected Lines

The TPD6F002 has 6 identical protection channels for signal lines. All I/O pins support a signal range from 0 to 5.5 V.

8.2.2.2 Operating Frequency

The TPD6F002 has a 100-MHz, –3-dB bandwidth, which supports the operating frequency for this display.

8.2.2.3 Crosstalk Response

The TPD6F002 has a –57-dB crosstalk attenuation at 100 MHz, sufficient for this display.

8.2.3 Application Curve

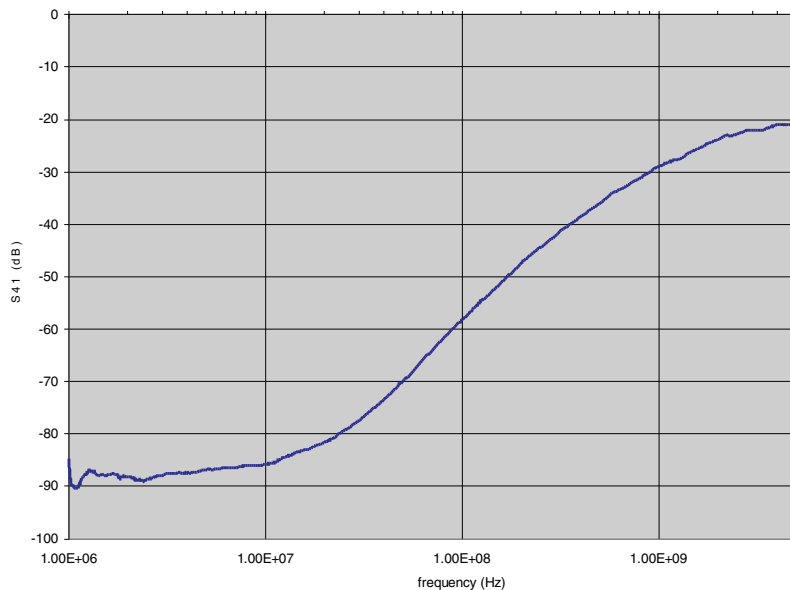

Figure 6. Channel-to-Channel Crosstalk

9 Power Supply Recommendations

This device is a passive EMI and ESD device so there is no need to power it. Take care not to violate the recommended V_{IO} specification (5.5 V) to ensure the device functions properly.

10 Layout

10.1 Layout Guidelines

- The optimum placement is as close to the connector as possible.
 - EMI during an ESD event can couple from the trace being struck to other nearby unprotected traces, resulting in early system failures.
 - The PCB designer needs to minimize the possibility of EMI coupling by keeping any unprotected traces away from the protected traces which are between the TVS and the connector.
- Route the protected traces as straight as possible.
- Eliminate any sharp corners on the protected traces between the TVS and the connector by using rounded corners with the largest radii possible.
 - Electric fields tend to build up on corners, increasing EMI coupling.

10.2 Layout Example

This application is typical of an 18-bit RGB display panel layout.

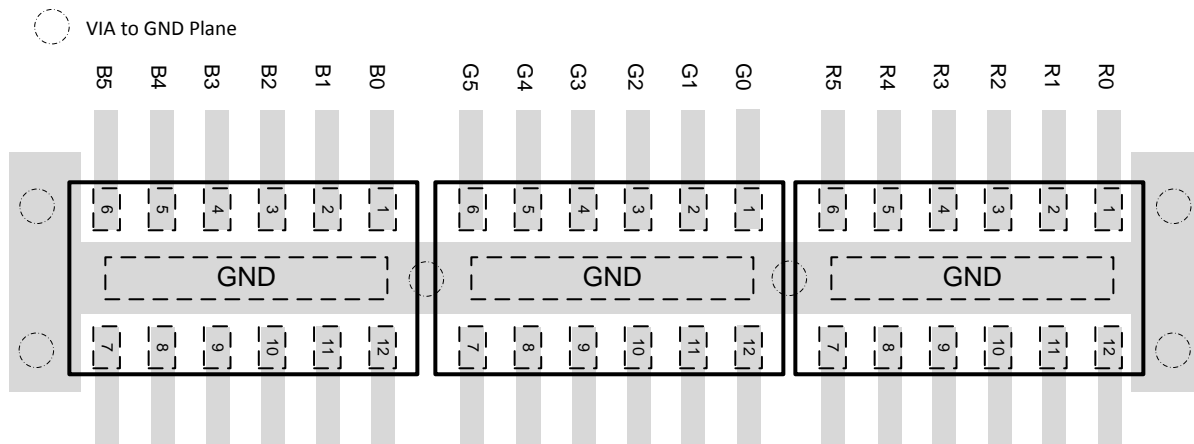

Figure 7. Typical RGB Display Layout

11 Device and Documentation Support

11.1 Community Resources

The following links connect to TI community resources. Linked contents are provided "AS IS" by the respective contributors. They do not constitute TI specifications and do not necessarily reflect TI's views; see TI's [Terms of Use](#).

TI E2E™ Online Community *TI's Engineer-to-Engineer (E2E) Community*. Created to foster collaboration among engineers. At e2e.ti.com, you can ask questions, share knowledge, explore ideas and help solve problems with fellow engineers.

Design Support *TI's Design Support* Quickly find helpful E2E forums along with design support tools and contact information for technical support.

11.2 Trademarks

E2E is a trademark of Texas Instruments.
All other trademarks are the property of their respective owners.

11.3 Electrostatic Discharge Caution



This integrated circuit can be damaged by ESD. Texas Instruments recommends that all integrated circuits be handled with appropriate precautions. Failure to observe proper handling and installation procedures can cause damage.

ESD damage can range from subtle performance degradation to complete device failure. Precision integrated circuits may be more susceptible to damage because very small parametric changes could cause the device not to meet its published specifications.

11.4 Glossary

[SLYZ022](#) — *TI Glossary*.

This glossary lists and explains terms, acronyms, and definitions.

12 Mechanical, Packaging, and Orderable Information

The following pages include mechanical, packaging, and orderable information. This information is the most current data available for the designated devices. This data is subject to change without notice and revision of this document. For browser-based versions of this data sheet, refer to the left-hand navigation.

PACKAGING INFORMATION

Orderable Device	Status (1)	Package Type	Package Drawing	Pins	Package Qty	Eco Plan (2)	Lead finish/ Ball material (6)	MSL Peak Temp (3)	Op Temp (°C)	Device Marking (4/5)	Samples
TPD6F002DSVR	ACTIVE	SON	DSV	12	3000	RoHS & Green	NIPDAU	Level-1-260C-UNLIM	-40 to 85	3NS	Samples

(1) The marketing status values are defined as follows:

ACTIVE: Product device recommended for new designs.

LIFEBUY: TI has announced that the device will be discontinued, and a lifetime-buy period is in effect.

NRND: Not recommended for new designs. Device is in production to support existing customers, but TI does not recommend using this part in a new design.

PREVIEW: Device has been announced but is not in production. Samples may or may not be available.

OBSOLETE: TI has discontinued the production of the device.

(2) **RoHS:** TI defines "RoHS" to mean semiconductor products that are compliant with the current EU RoHS requirements for all 10 RoHS substances, including the requirement that RoHS substance do not exceed 0.1% by weight in homogeneous materials. Where designed to be soldered at high temperatures, "RoHS" products are suitable for use in specified lead-free processes. TI may reference these types of products as "Pb-Free".

RoHS Exempt: TI defines "RoHS Exempt" to mean products that contain lead but are compliant with EU RoHS pursuant to a specific EU RoHS exemption.

Green: TI defines "Green" to mean the content of Chlorine (Cl) and Bromine (Br) based flame retardants meet JS709B low halogen requirements of <=1000ppm threshold. Antimony trioxide based flame retardants must also meet the <=1000ppm threshold requirement.

(3) MSL, Peak Temp. - The Moisture Sensitivity Level rating according to the JEDEC industry standard classifications, and peak solder temperature.

(4) There may be additional marking, which relates to the logo, the lot trace code information, or the environmental category on the device.

(5) Multiple Device Markings will be inside parentheses. Only one Device Marking contained in parentheses and separated by a "-" will appear on a device. If a line is indented then it is a continuation of the previous line and the two combined represent the entire Device Marking for that device.

(6) Lead finish/Ball material - Orderable Devices may have multiple material finish options. Finish options are separated by a vertical ruled line. Lead finish/Ball material values may wrap to two lines if the finish value exceeds the maximum column width.

Important Information and Disclaimer:The information provided on this page represents TI's knowledge and belief as of the date that it is provided. TI bases its knowledge and belief on information provided by third parties, and makes no representation or warranty as to the accuracy of such information. Efforts are underway to better integrate information from third parties. TI has taken and continues to take reasonable steps to provide representative and accurate information but may not have conducted destructive testing or chemical analysis on incoming materials and chemicals. TI and TI suppliers consider certain information to be proprietary, and thus CAS numbers and other limited information may not be available for release.

In no event shall TI's liability arising out of such information exceed the total purchase price of the TI part(s) at issue in this document sold by TI to Customer on an annual basis.

OTHER QUALIFIED VERSIONS OF TPD6F002 :

- Automotive: [TPD6F002-Q1](#)

NOTE: Qualified Version Definitions:

- Automotive - Q100 devices qualified for high-reliability automotive applications targeting zero defects

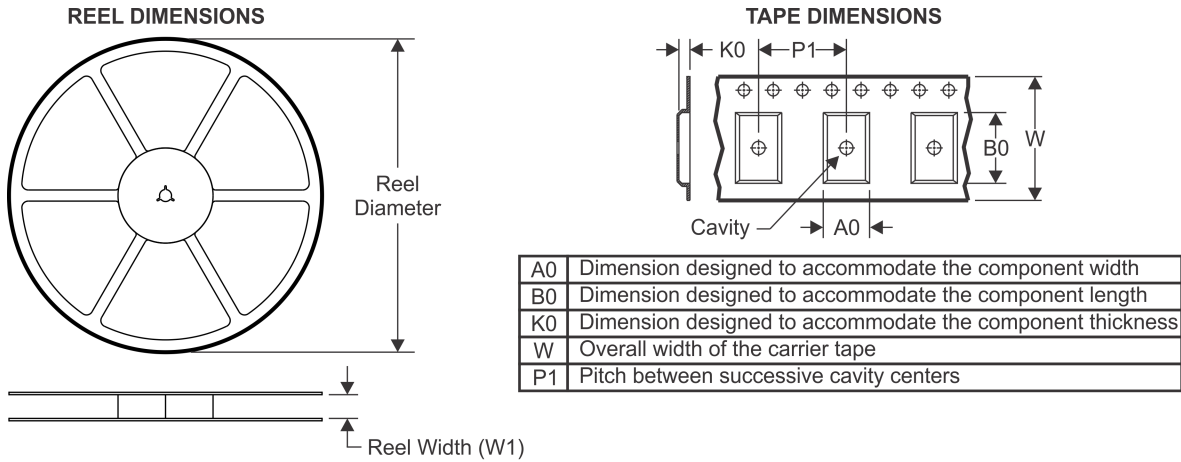
TAPE AND REEL INFORMATION

QUADRANT ASSIGNMENTS FOR PIN 1 ORIENTATION IN TAPE

*All dimensions are nominal

Device	Package Type	Package Drawing	Pins	SPQ	Reel Diameter (mm)	Reel Width W1 (mm)	A0 (mm)	B0 (mm)	K0 (mm)	P1 (mm)	W (mm)	Pin1 Quadrant
TPD6F002DSVR	SON	DSV	12	3000	180.0	8.4	1.74	3.33	1.05	4.0	8.0	Q1

TAPE AND REEL BOX DIMENSIONS



*All dimensions are nominal

Device	Package Type	Package Drawing	Pins	SPQ	Length (mm)	Width (mm)	Height (mm)
TPD6F002DSVR	SON	DSV	12	3000	183.0	183.0	20.0

DSV (R-PWSON-N12)

PLASTIC SMALL OUTLINE NO-LEAD

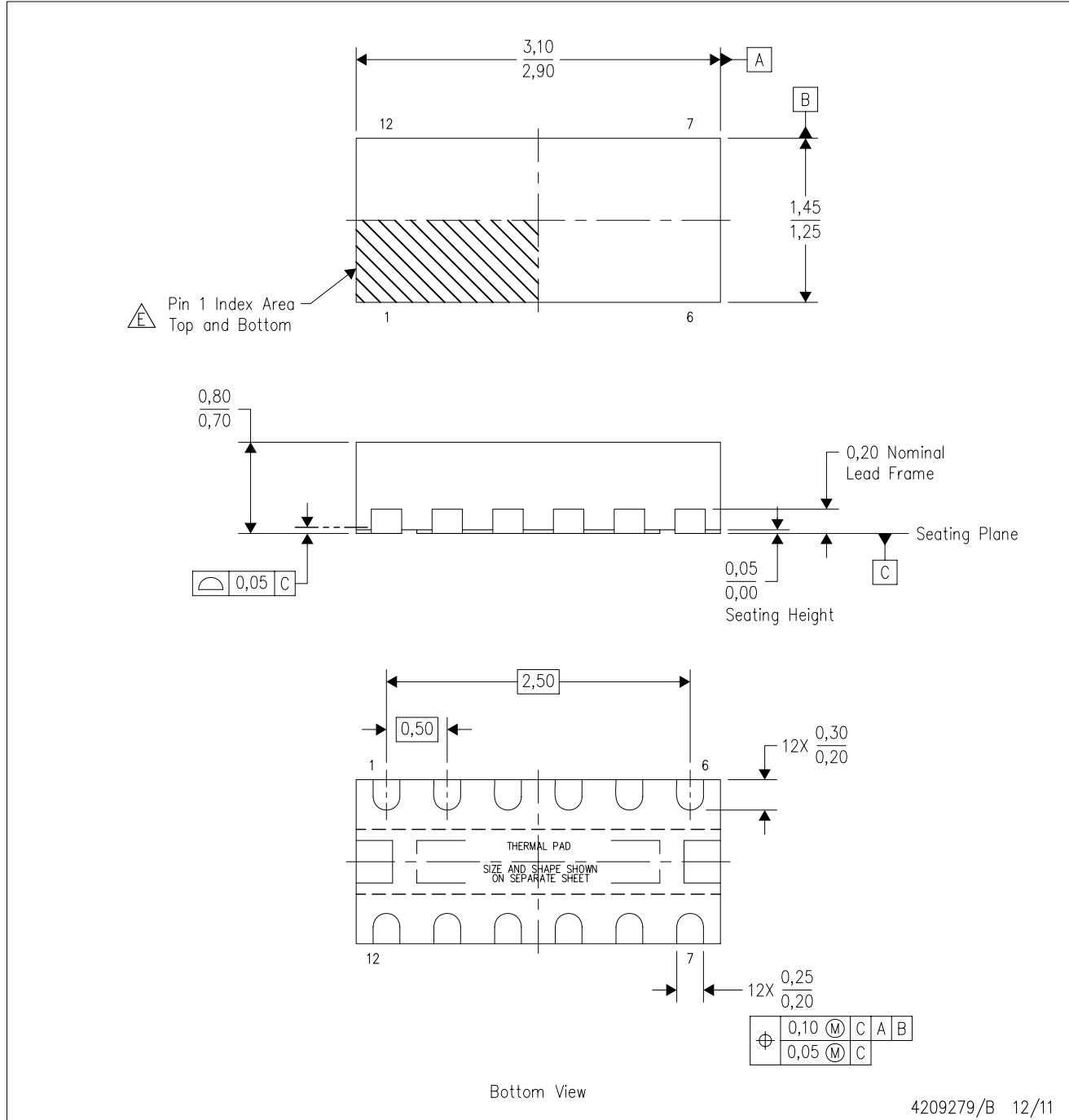

4209279/B 12/11

- NOTES:
- All linear dimensions are in millimeters. Dimensioning and tolerancing per ASME Y14.5M-1994.
 - This drawing is subject to change without notice.
 - SON (Small Outline No-Lead) package configuration.
 - The package thermal pad must be soldered to the board for thermal and mechanical performance.
 - See the additional figure in the Product Data Sheet for details regarding the exposed thermal pad features and dimensions.
- F Pin 1 identifiers are located on both top and bottom of the package and within the zone indicated. The Pin 1 identifiers are either a molded, marked, or metal feature.

THERMAL PAD MECHANICAL DATA

DSV (R-PWSON-N12)

PLASTIC SMALL OUTLINE NO-LEAD

THERMAL INFORMATION

This package incorporates an exposed thermal pad that is designed to be attached directly to an external heatsink. The thermal pad must be soldered directly to the printed circuit board (PCB). After soldering, the PCB can be used as a heatsink. In addition, through the use of thermal vias, the thermal pad can be attached directly to the appropriate copper plane shown in the electrical schematic for the device, or alternatively, can be attached to a special heatsink structure designed into the PCB. This design optimizes the heat transfer from the integrated circuit (IC).

For information on the Quad Flatpack No-Lead (QFN) package and its advantages, refer to Application Report, QFN/SON PCB Attachment, Texas Instruments Literature No. SLUA271. This document is available at www.ti.com.

The exposed thermal pad dimensions for this package are shown in the following illustration.

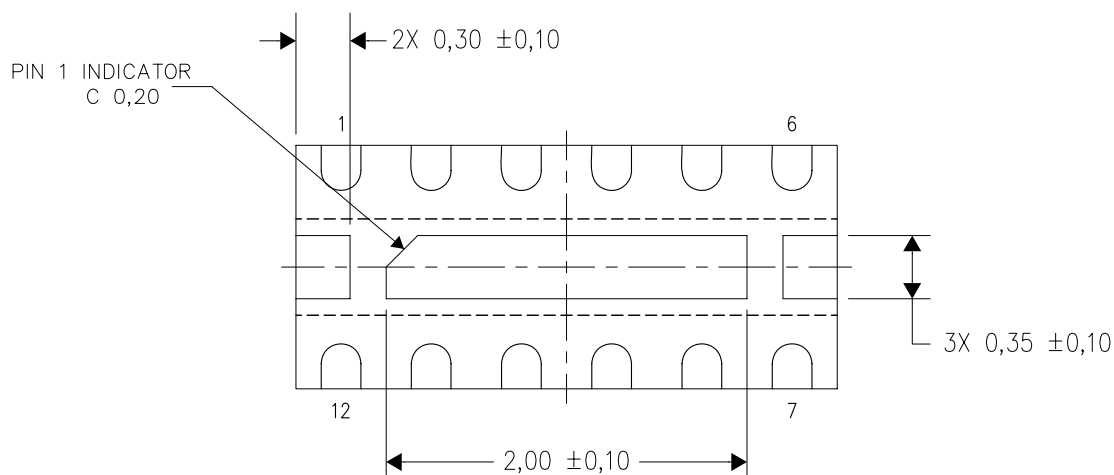

Bottom View

Exposed Thermal Pad Dimensions

4209318/B 12/11

NOTE: All linear dimensions are in millimeters

DSV (R-PWSON-N12)

PLASTIC SMALL OUTLINE NO-LEAD

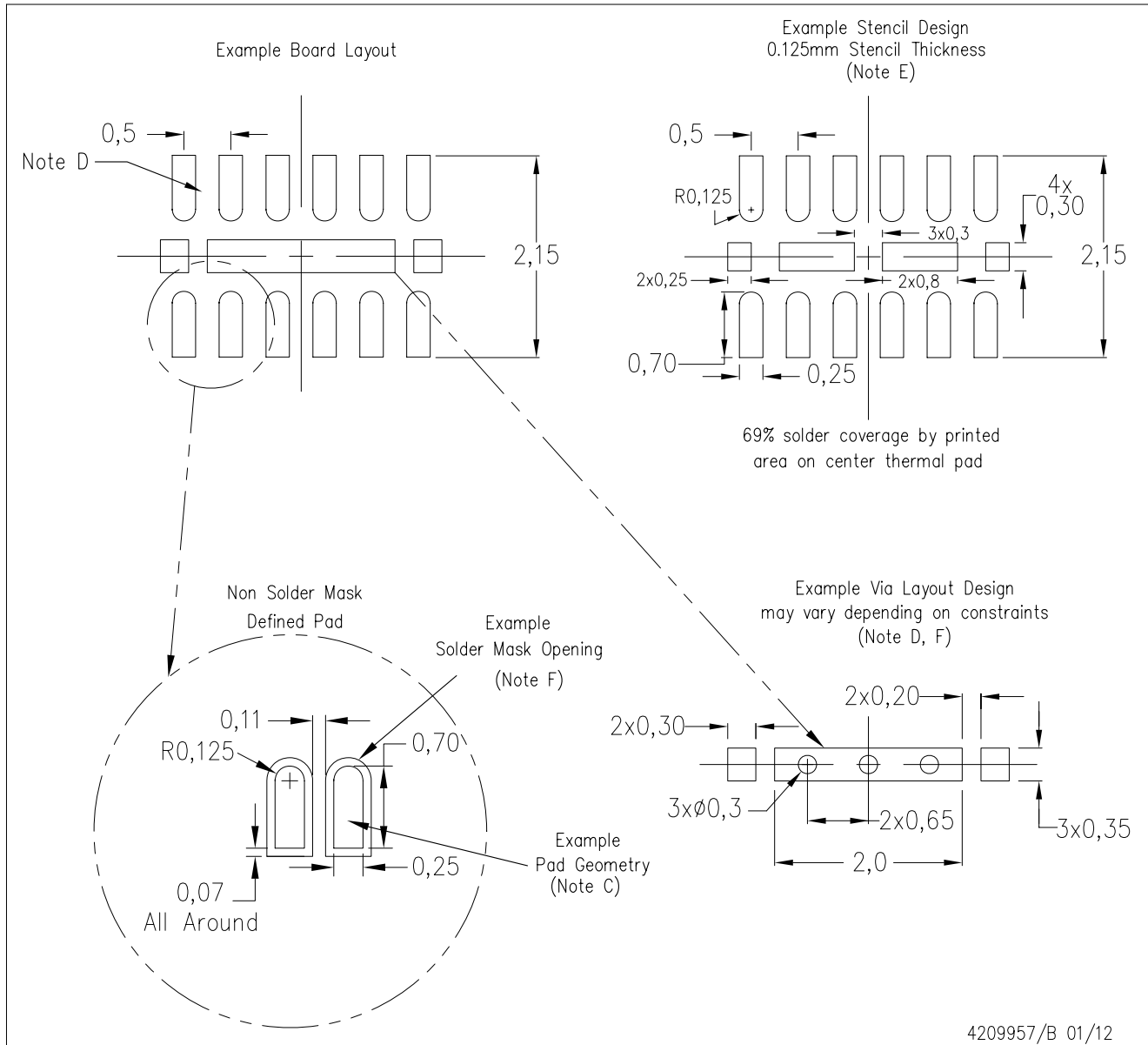

- NOTES:
- All linear dimensions are in millimeters.
 - This drawing is subject to change without notice.
 - Publication IPC-7351 is recommended for alternate designs.
 - This package is designed to be soldered to a thermal pad on the board. Refer to Application Note, Quad Flat-Pack Packages, Texas Instruments Literature No. SLUA271, and also the Product Data Sheets for specific thermal information, via requirements, and recommended board layout. These documents are available at www.ti.com <<http://www.ti.com>>.
 - Laser cutting apertures with trapezoidal walls and also rounding corners will offer better paste release. Customers should contact their board assembly site for stencil design recommendations. Refer to IPC 7525 for stencil design considerations.
 - Customers should contact their board fabrication site for minimum solder mask web tolerances between signal pads.

IMPORTANT NOTICE AND DISCLAIMER

TI PROVIDES TECHNICAL AND RELIABILITY DATA (INCLUDING DATASHEETS), DESIGN RESOURCES (INCLUDING REFERENCE DESIGNS), APPLICATION OR OTHER DESIGN ADVICE, WEB TOOLS, SAFETY INFORMATION, AND OTHER RESOURCES "AS IS" AND WITH ALL FAULTS, AND DISCLAIMS ALL WARRANTIES, EXPRESS AND IMPLIED, INCLUDING WITHOUT LIMITATION ANY IMPLIED WARRANTIES OF MERCHANTABILITY, FITNESS FOR A PARTICULAR PURPOSE OR NON-INFRINGEMENT OF THIRD PARTY INTELLECTUAL PROPERTY RIGHTS.

These resources are intended for skilled developers designing with TI products. You are solely responsible for (1) selecting the appropriate TI products for your application, (2) designing, validating and testing your application, and (3) ensuring your application meets applicable standards, and any other safety, security, or other requirements. These resources are subject to change without notice. TI grants you permission to use these resources only for development of an application that uses the TI products described in the resource. Other reproduction and display of these resources is prohibited. No license is granted to any other TI intellectual property right or to any third party intellectual property right. TI disclaims responsibility for, and you will fully indemnify TI and its representatives against, any claims, damages, costs, losses, and liabilities arising out of your use of these resources.

TI's products are provided subject to TI's Terms of Sale (www.ti.com/legal/termsofsale.html) or other applicable terms available either on ti.com or provided in conjunction with such TI products. TI's provision of these resources does not expand or otherwise alter TI's applicable warranties or warranty disclaimers for TI products.

Mailing Address: Texas Instruments, Post Office Box 655303, Dallas, Texas 75265
Copyright © 2020, Texas Instruments Incorporated