

## TPS3123 Ultra-Low Voltage Processor Supervisory Circuits

### 1 Features

- Minimum supply voltage of 0.9V
- Supply voltage supervision range:
  - 1.2V, 1.5V, 1.8V (TPS312x)
  - 3V (TPS3125 devices only)
  - Other versions on request
- Power-on reset generator with fixed delay time of 180ms
- Manual reset input (TPS3123/5/6/8)
- Watchdog timer retriggers the  $\overline{\text{RESET}}$  output at  $V_{\text{DD}} \geq V_{\text{IT}}$ .
- Supply current of 14 $\mu\text{A}$  (typical)
- Small SOT23-5 package
- Temperature range of  $-40^{\circ}\text{C}$  to  $+85^{\circ}\text{C}$
- Reset output available in Push-Pull (Active-Low and High) and Open-Drain (Active-Low)

### 2 Applications

- [Portable / battery-powered equipment](#)
- [Wireless communication systems](#)
- [Industrial automation](#)
- [Servers](#)
- [Building automation](#)

### 3 Description

The TPS312x family of voltage supervisory circuits provides voltage monitoring down to 1.2V rails and timing supervision, primarily for DSP and processor-based systems. All devices in the family monitor the power rail and assert  $\overline{\text{RESET}}$  output when the power rail is under the threshold voltage target ( $V_{\text{IT}}$ ). The threshold voltage is programmed into the device to minimize external components. Built-

in hysteresis prevents false triggering. The  $\overline{\text{RESET}}$  output is not valid for supply voltage ( $V_{\text{DD}}$ ) under 0.9V. The TPS312x family includes devices with active high output for use as disable during malfunction and active-low outputs for most systems where high output indicates properly functioning system.

The TPS3123/3124/3128 also include the watchdog timer functionality to monitor timely digital pulses from the processor and issue an alert if the expected pulse does not arrive on time due to potential software freeze or hang. Such integration of supply rail monitoring and the watch dog timer feature is very helpful in always on systems, such as Factory Automation and Communications Infrastructure.

In addition the TPS3123/5/6/8 devices incorporate a manual reset input, MR, to force RESET triggered by an event unrelated to the voltage rail monitoring of the pulses monitored by the watch dog timer. A low level at MR causes RESET to become active. The TPS3124 devices do not have the input MR, but include a high-level output RESET same as the TPS3125 and TPS3126 devices.

All devices in the family are available in a 5-pin SOT23-5 package and are characterized for operation over a temperature range of  $-40^{\circ}\text{C}$  to  $+85^{\circ}\text{C}$ .

PART NUMBER	PACKAGE (1)	BODY SIZE (NOM) (2)
TPS3123	SOT-23 (5)	2.90mm × 1.60mm

- (1) For all available packages, see the orderable addendum at the end of the data sheet.
- (2) The package size (length × width) is a nominal value and includes pins, where applicable.

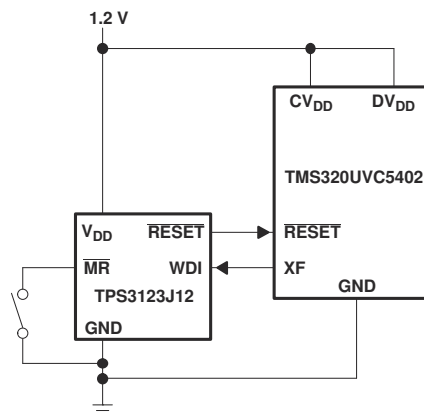

Typical Low-Voltage DSP Application



## Table of Contents

<b>1 Features</b> .....	1	<b>7 Detailed Description</b> .....	12
<b>2 Applications</b> .....	1	7.1 Overview.....	12
<b>3 Description</b> .....	1	7.2 Functional Block Diagram.....	12
<b>4 Device Comparison</b> .....	3	7.3 Feature Description.....	12
<b>5 Pin Configuration and Functions</b> .....	4	7.4 Device Functional Modes.....	13
<b>6 Specifications</b> .....	5	<b>8 Device and Documentation Support</b> .....	14
6.1 Absolute Maximum Ratings.....	5	8.1 Device and Documentation Support.....	14
6.2 ESD Ratings.....	5	8.2 Receiving Notification of Documentation Updates... 14	
6.3 Recommended Operating Conditions.....	5	8.3 Support Resources.....	14
6.4 Thermal Information.....	6	8.4 Trademarks.....	14
6.5 Electrical Characteristics.....	6	8.5 Electrostatic Discharge Caution.....	14
6.6 Timing Requirements.....	7	8.6 Glossary.....	14
6.7 Switching Characteristics.....	7	<b>9 Revision History</b> .....	15
6.8 Timing Diagrams .....	8	<b>10 Mechanical, Packaging, and Orderable Information</b> .....	15
6.9 Typical Characteristics.....	9		

## 4 Device Comparison

Figure 4-1 shows the device naming nomenclature to compare the different device variants. See Section 8.1 for ordering information on various variants of TPS3123/3124/3125/3126/ and TPS3128.

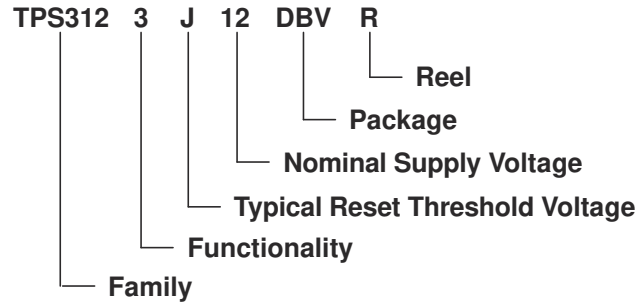
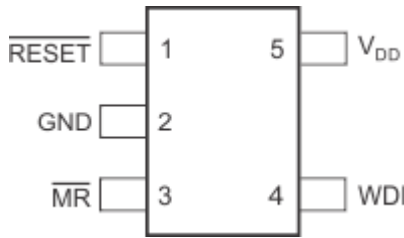

**Figure 4-1. Device Naming Nomenclature**

**Table 4-1. Reset Output Topologies**

DEVICES	OPEN DRAIN	PUSH-PULL
TPS3123		X
TPS3124		X
TPS3125		X
TPS3126	X	
TPS3128	X	

## 5 Pin Configuration and Functions



**Figure 5-1. TPS3123 / TPS3128: DBV PACKAGE  
5-Pin SOT-23  
Top View**

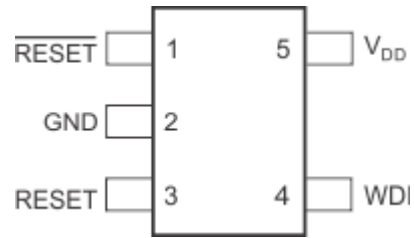

**Figure 5-2. TPS3124: DBV PACKAGE  
5-Pin SOT-23  
Top View**

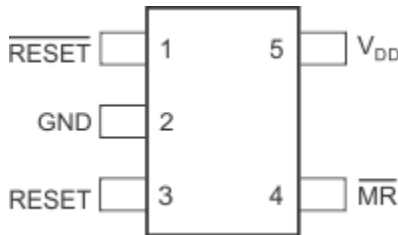

**Figure 5-3. TPS3125 / TPS3126: DBV PACKAGE  
5-Pin SOT-23  
Top View**

**Table 5-1. Pin Functions**

PIN NUMBER	PIN			I/O	DESCRIPTION
	TPS3123 TPS3128	TPS3124	TPS3125 TPS3126		
1	RESET	RESET	RESET	O	<b>Active-Low Output Reset Signal:</b> This pin is driven to a logic low when VDD voltage falls below the negative voltage threshold ( $V_{IT-}$ ). $\overline{\text{RESET}}$ remains low (asserted) for the delay time period ( $t_D$ ) after VDD voltage rises above $V_{IT+} = V_{IT-} + V_{HYS}$ .
2	GND	GND	GND	-	<b>GROUND</b>
3	$\overline{\text{MR}}$	-	-	I	<b>Manual Reset:</b> Pull this pin to a logic low to assert a reset signal in the $\overline{\text{RESET}}$ output pin. After $\overline{\text{MR}}$ pin is left floating or pulls to logic high, the $\overline{\text{RESET}}$ output deasserts to the nominal state after the reset delay time ( $t_D$ ) expires.
3	-	RESET	RESET	O	<b>Active-High Output Reset Signal:</b> This pin is driven to a logic high when VDD voltage falls below the negative voltage threshold ( $V_{IT-}$ ). RESET remains high (asserted) for the delay time period ( $t_D$ ) after VDD voltage rises above $V_{IT+} = V_{IT-} + V_{HYS}$ .
4	WDI	WDI	$\overline{\text{MR}}$	I	<b>Watchdog Timer Input:</b> If WDI remains high or low longer than the timeout period, then reset is triggered. The timer clears when reset is asserted or when WDI sees a rising edge or a falling edge.
5	VDD	VDD	VDD	I	<b>Input Supply Voltage:</b> Supply voltage pin. Good analog design practice is to place a 0.1 $\mu\text{F}$ ceramic capacitor close to this pin.

## 6 Specifications

### 6.1 Absolute Maximum Ratings

over operating free-air temperature range (unless otherwise noted)<sup>(1)</sup>

		MIN	MAX	UNIT
Voltage	Manual reset, $\overline{MR}$	-0.3	$V_{DD} + 0.6$	V
Voltage	RESET	-0.3	$V_{DD} + 0.6$	V
Voltage	Open drain RESET output	-0.3	$V_{DD} + 0.3$	V
Voltage	Supply voltage	-0.3	3.6	V
Voltage	Watchdog input, WDI	-0.3	$V_{DD} + 0.6$	V
Current	Maximum low output current, $I_{OL}$		5	mA
Current	Maximum high output current, $I_{OH}$		-5	mA
Current	Input clamp current ( $V_I < 0$ or $V_I > V_{DD}$ ), $I_{IK}$	-10	10	mA
Current	Output clamp current ( $V_O < 0$ or $V_O > V_{DD}$ ), $I_{OK}$	-10	10	mA
Temperature	Operating free-air temperature, $T_A$	-40	85	°C
Temperature	Storage temperature range, $T_{stg}$	-65	150	°C
Temperature	Soldering temperature		260	°C

- (1) Stresses beyond those listed under Absolute Maximum Ratings may cause permanent damage to the device. These are stress ratings only, and functional operation of the device at these or any other conditions beyond those indicated under Recommended Operating Conditions is not implied. Exposure to absolute-maximum-rated conditions for extended periods may affect device reliability.

### 6.2 ESD Ratings

		VALUE	UNIT
$V_{(ESD)}$	Electrostatic discharge	Human-body model (HBM), per ANSI/ESDA/JEDEC JS-001 <sup>(1)</sup>	±4000
		Charged-device model (CDM), per JEDEC specification JESD22-C101 <sup>(2)</sup>	±1000

- (1) JEDEC document JEP155 states that 500V HBM allows safe manufacturing with a standard ESD control process  
(2) JEDEC document JEP157 states that 250V CDM allows safe manufacturing with a standard ESD control process.

### 6.3 Recommended Operating Conditions

over operating free-air temperature range (unless otherwise noted)

		MIN	NOM	MAX	UNIT
$V_{DD}$	Supply voltage	$T_A = 0^\circ\text{C}$ to $85^\circ\text{C}$	0.9	3.3	V
		$T_A = -40^\circ\text{C}$ to $85^\circ\text{C}$	0.9	3.3	
	Manual reset voltage	0		$V_{DD} + 0.3$	V
$V_{WD1}$	Watchdog input voltage	0		$V_{DD} + 0.3$	V
$V_{IH}$	High level input voltage	$0.7 \times V_{DD}$			V
$V_{IL}$	Low level input voltage			$0.3 \times V_{DD}$	V
$\Delta t/\Delta V$	Input transition rise and fall rate at WDI			1	µs/V
$T_A$	Operating free-air temperature range	-40		85	°C

## 6.4 Thermal Information

THERMAL METRIC <sup>(1)</sup>		TPS312x
		DBV (SOT-23)
		5 PINS
R <sub>θJA</sub>	Junction-to-ambient thermal resistance	185
R <sub>θJC(top)</sub>	Junction-to-case (top) thermal resistance	83.3
R <sub>θJB</sub>	Junction-to-board thermal resistance	52.4
ψ <sub>JT</sub>	Junction-to-top characterization parameter	20.4
ψ <sub>JB</sub>	Junction-to-board characterization parameter	52.0
R <sub>θJC(bot)</sub>	Junction-to-case (bottom) thermal resistance	N/A

(1) For more information about traditional and new thermal metrics, see the [SPRA953](#) application report.

## 6.5 Electrical Characteristics

over recommended operating free-air temperature range (inless otherwise noted).

PARAMETER		TEST CONDITIONS		MIN	NOM	MAX	UNIT
R <sub>MR</sub>	MR pullup resistor (Internal)				90		kΩ
I <sub>IH</sub>	High-level input current	WDI	WDI = V <sub>DD</sub> = 3.3V	-1		1	μA
		MR	MR = 0.7 × V <sub>DD</sub> , V <sub>DD</sub> = 3.3V	7		19	μA
I <sub>IL</sub>	Low-level input current	WDI	WDI = 0V, V <sub>DD</sub> = 3.3V	-1		1	μA
		MR	MR = 0V, V <sub>DD</sub> = 3.3V	24		61	μA
I <sub>OH</sub>	High-level output current (leakage into RESET pin)	TPS3126-xx TPS3128-xx	V <sub>DD</sub> = V <sub>OH</sub> = 3.3V			200	nA
V <sub>OH</sub>	High-level output voltage (TPS3123/4/5 only)	RESET	V <sub>DD</sub> = 1.5V, I <sub>OH</sub> = -1mA	0.8 × V <sub>DD</sub>			V
			V <sub>DD</sub> = 3.3V, I <sub>OH</sub> = -4.5mA				
		RESET	V <sub>DD</sub> = 0.9V, I <sub>OH</sub> = -8μA				
			V <sub>DD</sub> = 1.5V, I <sub>OH</sub> = -1mA				
V <sub>OL</sub>	Low-level output voltage	RESET	V <sub>DD</sub> = 0.9V, I <sub>OL</sub> = 15μA	0.2 × V <sub>DD</sub>			V
			V <sub>DD</sub> = 1.5V, I <sub>OL</sub> = 1.4mA				
		RESET	V <sub>DD</sub> = 1.5V, I <sub>OL</sub> = 1.4mA				
			V <sub>DD</sub> = 3.3V, I <sub>OL</sub> = 3mA				
V <sub>IT-</sub>	Negative-going input threshold voltage <sup>(1)</sup>	TPS312xJ12	T <sub>A</sub> = -40°C to 85°C	1.04	1.08	1.12	V
		TPS312xG15		1.35	1.40	1.45	
		TPS312xJ18		1.56	1.62	1.68	
		TPS312xL30		2.57	2.64	2.71	
		TPS312xE12		1.10	1.14	1.18	
		TPS312xE15		1.38	1.43	1.48	
		TPS312xE18		1.65	1.71	1.77	
V <sub>HYS</sub>	Hysteresis at V <sub>DD</sub> input		1V < V <sub>IT-</sub> < 1.4V		15		mV
			1.4V < V <sub>IT-</sub> < 2V		20		
			2V < V <sub>IT-</sub> < 3V		30		
I <sub>DD</sub>	Supply current	TPS3123-xx TPS3124-xx TPS3128-xx	WDI = V <sub>DD</sub> , MR unconnected	V <sub>DD</sub> = 0.9V	14		μA
				V <sub>DD</sub> = 3.3V	22	30	
		TPS3125-xx TPS3126-xx <sup>(2)</sup>	MR unconnected	V <sub>DD</sub> = 0.9V	14		
				V <sub>DD</sub> = 3.3V	18	25	
C <sub>i</sub>	Input capacitance at MR, WDI		V <sub>I</sub> = 0V to 3.3V		5		pF

(1) To make sure best stability of the threshold voltage, place a bypass capacitor (ceramic, 0.1μF) near the supply terminal.

(2) The supply current during delay time t<sub>d</sub> is typical 5μA higher.

## 6.6 Timing Requirements

at  $R_L = 1\text{M}\Omega$ ,  $C_L = 50\text{pF}$ ,  $T_A = +25^\circ\text{C}$

		PARAMETER	TEST CONDITIONS	MIN	NOM	MAX	UNIT
$t_W$	Pulse width	At $V_{DD}$	$V_{IH} = V_{IT-} + 0.2\text{V}$ , $V_{IL} = V_{IT-} - 0.2\text{V}$	6			$\mu\text{s}$
		At $\overline{\text{MR}}$	$V_{DD} \geq V_{IT-} + 0.2\text{V}$ , $V_{IL} = 0.3 \times V_{DD}$ , $V_{IH} = 0.7 \times V_{DD}$	1			
		At WDI		0.1			

## 6.7 Switching Characteristics

at  $R_L = 1\text{M}\Omega$ ,  $C_L = 50\text{pF}$ ,  $T_A = +25^\circ\text{C}$

		PARAMETER	TEST CONDITIONS	MIN	NOM	MAX	UNIT
$t_{out}$	Watchdog time out		$V_{DD} \geq V_{IT-} + 0.2\text{V}$ , See timing diagram	0.8	1.4	2.1	s
$t_d$	Delay time		$V_{DD} \geq V_{IT-} + 0.2\text{V}$ , See timing diagram	100	180	260	ms
$t_{PHL}$	Propagation delay time, high-to-low output	$\overline{\text{MR}}$ to $\overline{\text{RESET}}$ delay (TPS3123/5/6/8)	$V_{DD} \geq V_{IT-} + 0.2\text{V}$ , $V_{IL} = V_{DD} \times 0.2$ , $V_{IH} = V_{DD} \times 0.8$	0.1			$\mu\text{s}$
$t_{PLH}$	Propagation delay time, low-to-high output	$\overline{\text{MR}}$ to $\overline{\text{RESET}}$ delay (TPS3125/6)		0.1			$\mu\text{s}$
$t_{PHL}$	Propagation delay time, high-to-low output	$V_{DD}$ to $\overline{\text{RESET}}$ delay	$V_{IL} = V_{IT-} - 0.2\text{V}$ , $V_{IH} = V_{IT-} + 0.2\text{V}$	17			$\mu\text{s}$
$t_{PLH}$	Propagation delay time, low-to-high output	$V_{DD}$ to $\overline{\text{RESET}}$ delay (TPS3124/5/6)		17			$\mu\text{s}$

## 6.8 Timing Diagrams

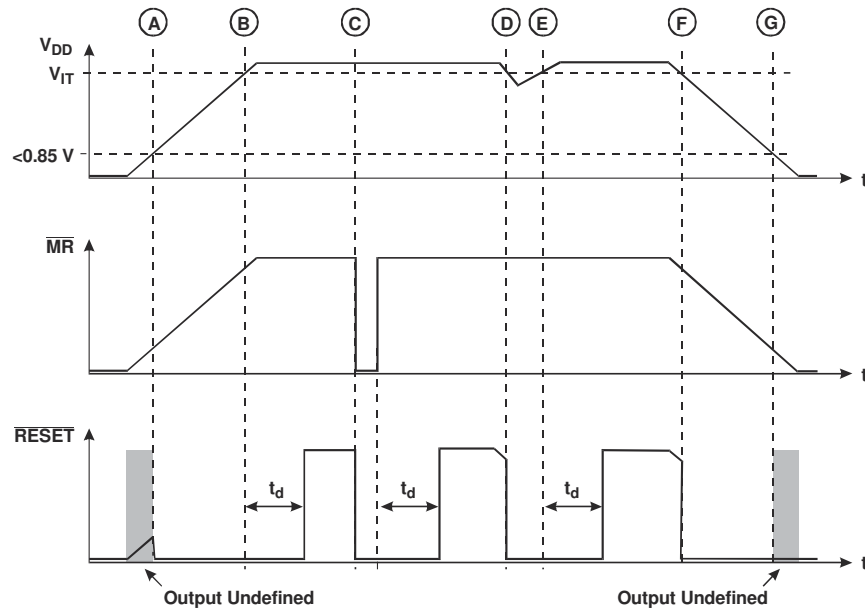

**Figure 6-1. Timing Diagram TPS3123/5/6/8**

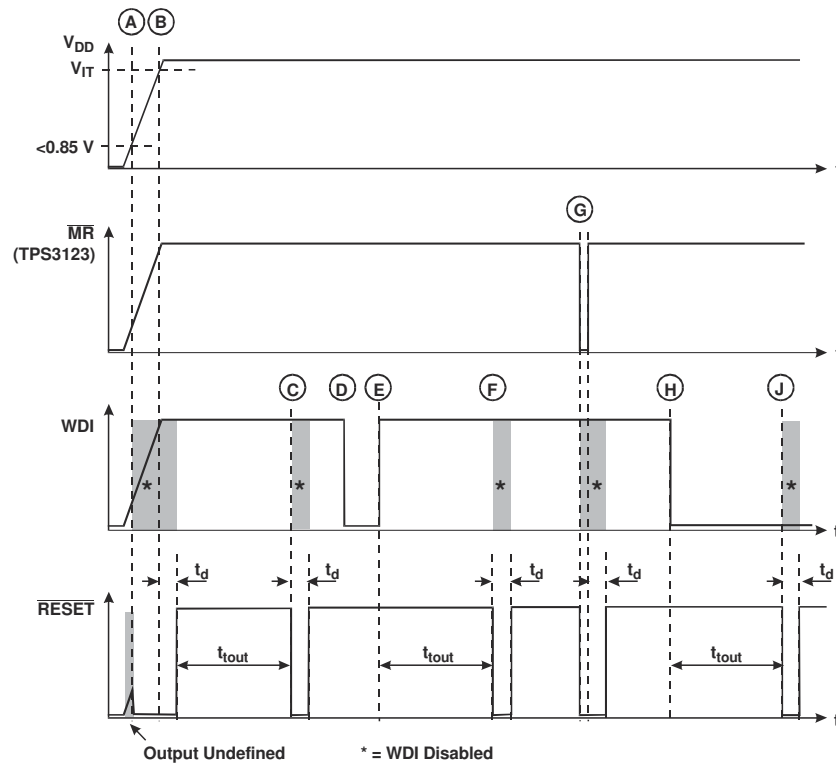

**Figure 6-2. Timing Diagram TPS3123/4/8**

### Note

A=Min VDD, B=VDD threshold, C,F,J=Watch Dog timeout, D,E,H=Watch Dog retriggered, G=Manual Reset



## 6.9 Typical Characteristics

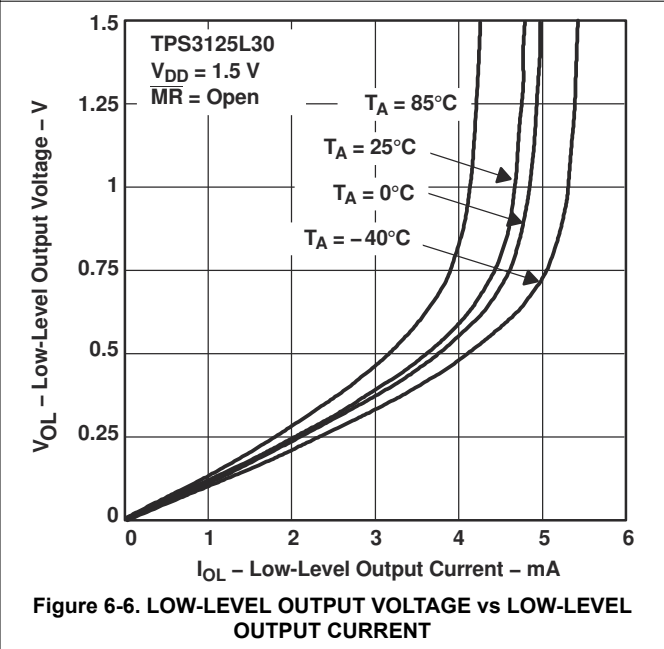
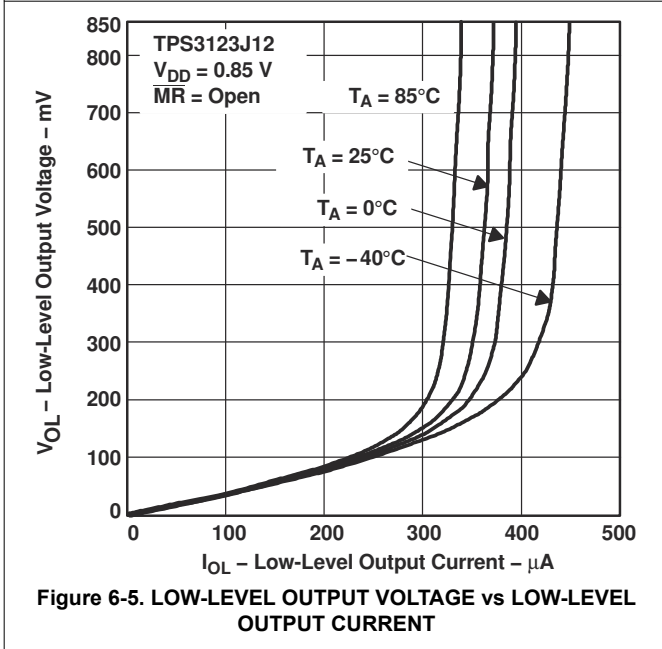
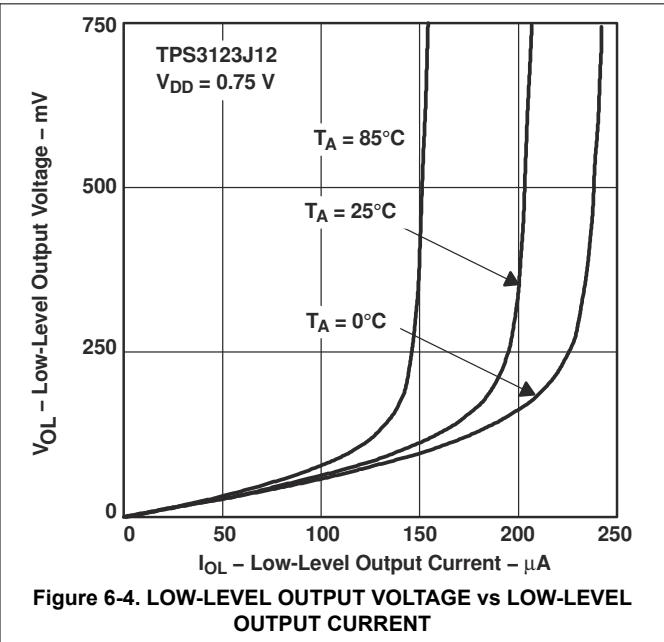
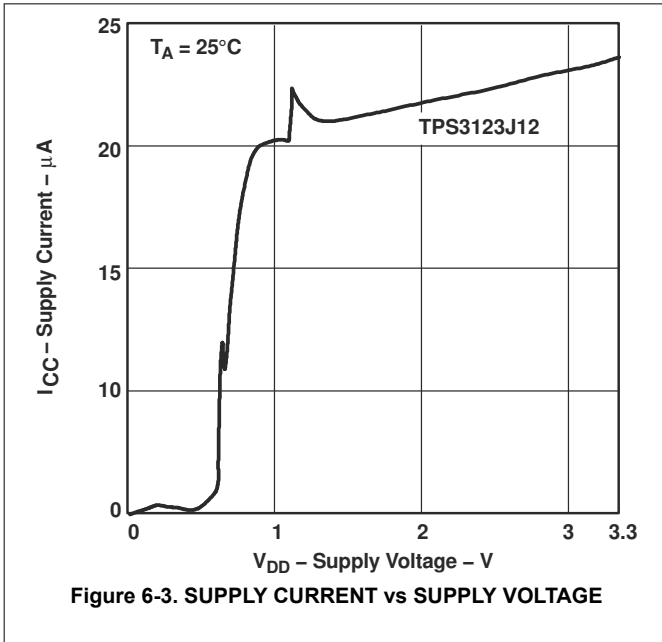

### 6.9 Typical Characteristics (continued)

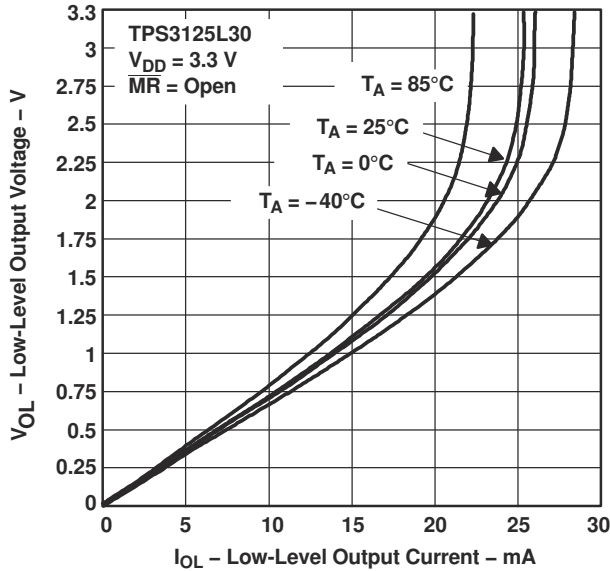

Figure 6-7. LOW-LEVEL OUTPUT VOLTAGE vs LOW-LEVEL OUTPUT CURRENT

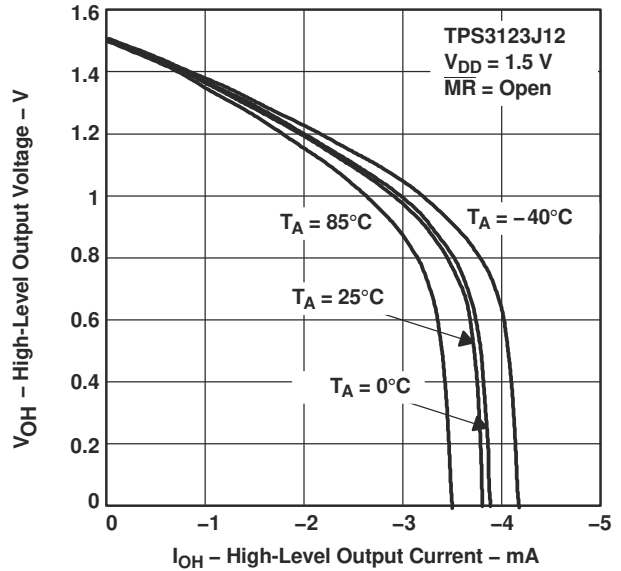

Figure 6-8. HIGH-LEVEL OUTPUT VOLTAGE vs HIGH-LEVEL OUTPUT CURRENT

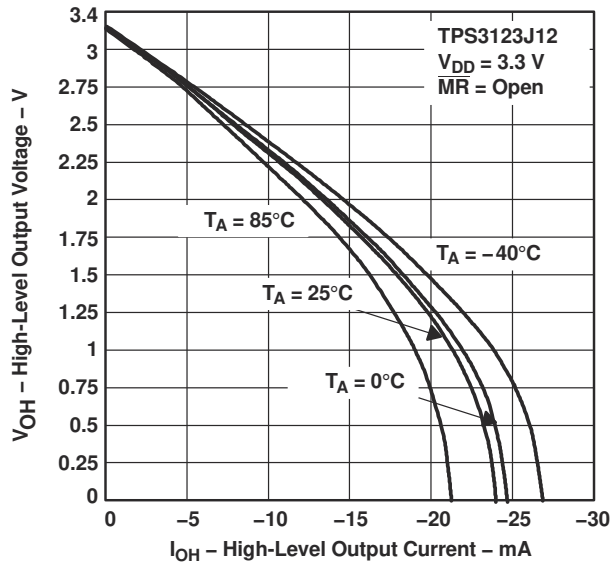

Figure 6-9. HIGH-LEVEL OUTPUT VOLTAGE vs HIGH-LEVEL OUTPUT CURRENT

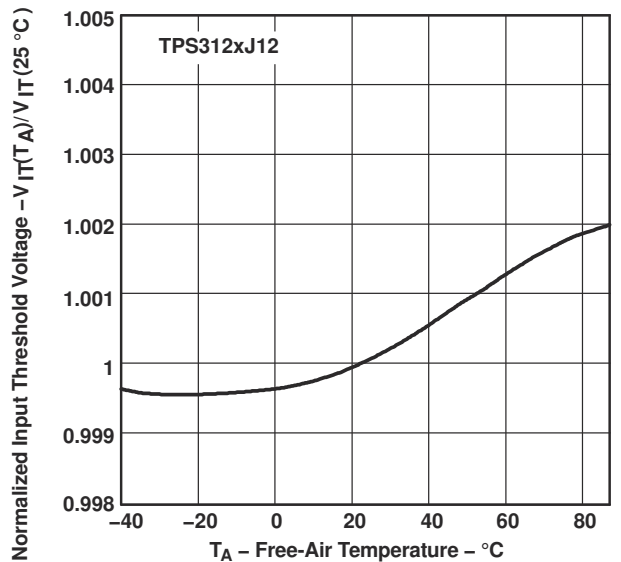

Figure 6-10. NORMALIZED INPUT THRESHOLD VOLTAGE vs FREE-AIR TEMPERATURE

### 6.9 Typical Characteristics (continued)

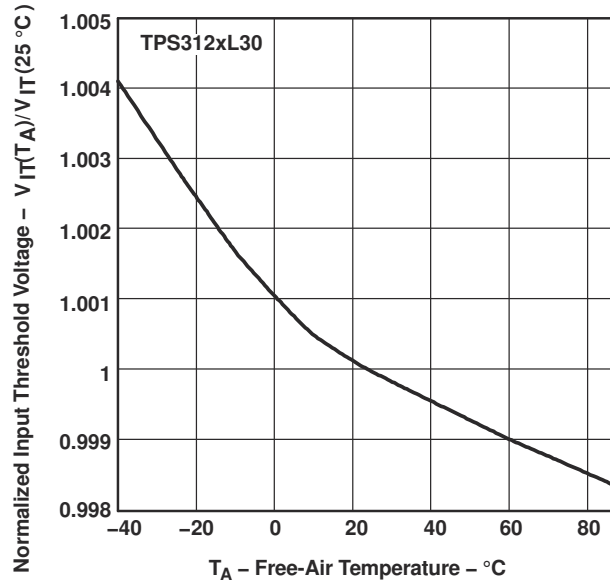

Figure 6-11. NORMALIZED INPUT THRESHOLD VOLTAGE vs FREE-AIR TEMPERATURE

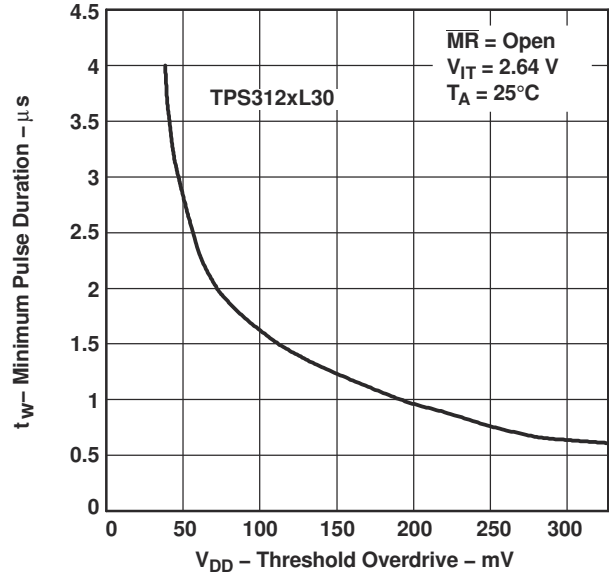

Figure 6-12. MINIMUM PULSE DURATION vs THRESHOLD OVERDRIVE

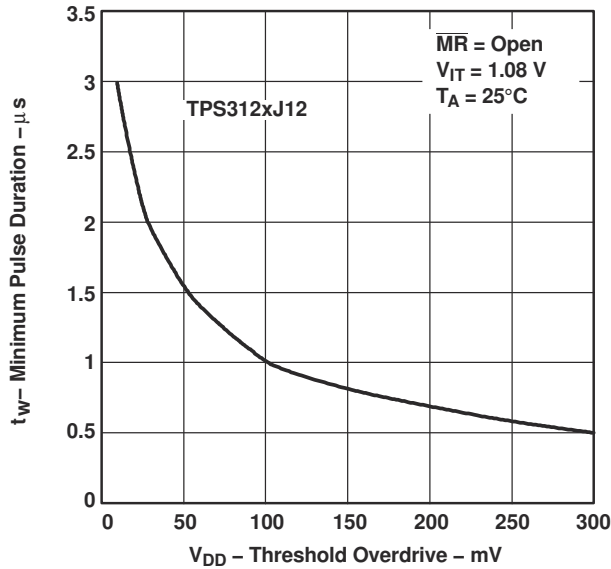

Figure 6-13. MINIMUM PULSE DURATION vs THRESHOLD OVERDRIVE

## 7 Detailed Description

### 7.1 Overview

The TPS312x family of supervisors provide circuit initialization and timing supervision. Optional configurations include devices with active-high and active-low output signals (TPS3124/3125/3126), devices with a watchdog timer (TPS3123/3124/3128), and devices with manual reset ( $\overline{MR}$ ) pins (TPS3123/3125/3126/3128).  $\overline{RESET}$  output is valid when the supply voltage,  $V_{DD}$ , is above 0.9V. For devices with active-low output logic, the device monitors  $V_{DD}$  and keeps  $\overline{RESET}$  low as long as  $V_{DD}$  remains below the negative threshold voltage,  $V_{IT-}$ . For devices with active-high output logic,  $RESET$  remains high as long as  $V_{DD}$  remains below  $V_{IT-}$ . An internal timer delays the return of the output to the inactive state (high) to make sure proper system reset. The delay time,  $t_d$ , starts after  $V_{DD}$  rises above the positive threshold voltage ( $V_{IT-} + V_{HYS}$ ). When the supply voltage drops below  $V_{IT-}$ , the output becomes active (low) again. All the devices of this family have a fixed-sense threshold voltage,  $V_{IT-}$ , set by an internal voltage divider, so no external components are required.

The TPS312x family is designed to monitor supply voltage. For devices with the manual reset functionality, a low level at  $\overline{MR}$  causes  $\overline{RESET}$  to become active. For devices with the watch dog timer functionality, when the supervising system fails to retrigger the watchdog circuit within the time-out interval  $t_{out} = 0.8s$ ,  $\overline{RESET}$  output becomes active for the time period ( $t_d$ ). This event also reinitializes the watchdog timer. The devices are available in a 5-pin SOT-23 package and are characterized for operation over a temperature range of  $-40^{\circ}C$  to  $85^{\circ}C$ .

### 7.2 Functional Block Diagram

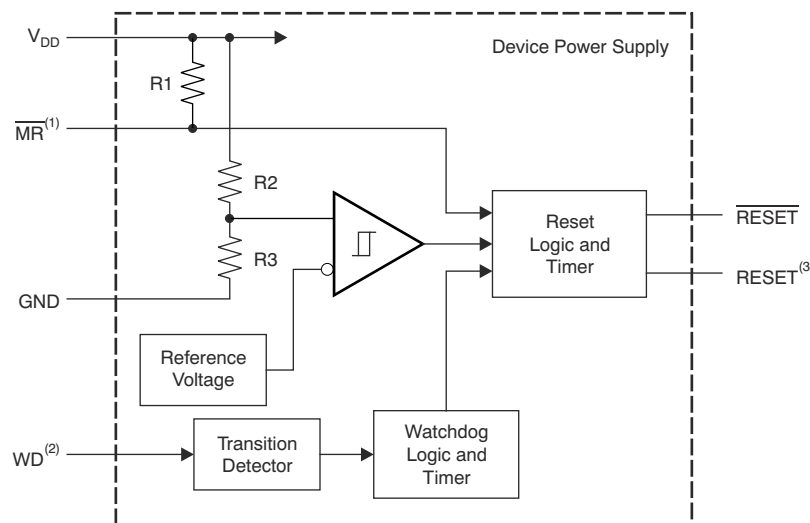

NOTES:  
 (1) TPS3123/5/6/8  
 (2) TPS3123/4/8  
 (3) TPS3124/5/6

Figure 7-1. FUNCTIONAL BLOCK DIAGRAM

### 7.3 Feature Description

#### 7.3.1 Manual Reset ( $\overline{MR}$ )

The  $\overline{MR}$  input allows an external logic signal from processors, logic circuits, and/or discrete sensors to force a reset signal regardless of  $V_{DD}$  with respect to  $V_{IT-}$  or the state of the watchdog timer. A low level at  $\overline{MR}$  causes the reset signals to become active.

### 7.3.2 Active-High or Active-Low Output

All TPS312x devices have an active-low logic output ( $\overline{\text{RESET}}$ ), while the TPS3124/3125/3126 devices also include an active-high logic output (RESET).

### 7.3.3 Push-Pull or Open-Drain Output

All TPS312x devices, except for TPS3126/3128, have push-pull outputs. TPS3126/3128 devices have an open-drain output.

### 7.3.4 Watchdog Timer (WDI)

The TPS3123, TPS3124, and TPS3128 devices have a watchdog timer that must be periodically triggered by either a positive or negative transition at WDI to avoid a reset signal being issued. When the supervising system fails to retrigger the watchdog circuit within the time-out interval,  $t_{\text{tout}}$ ,  $\overline{\text{RESET}}$  becomes active for the time period  $t_d$ . This event also reinitializes the watchdog timer.

## 7.4 Device Functional Modes

Table 7-1 lists the functional modes of the TPS312x devices.

**Table 7-1. Device Functional Modes Table**

TPS3123/8			TPS3124			TPS3125/6			
MR	VDD > V <sub>IT-</sub>	$\overline{\text{RESET}}$	VDD > V <sub>IT-</sub>	$\overline{\text{RESET}}$	RESET	MR	VDD > V <sub>IT-</sub>	$\overline{\text{RESET}}$	RESET
L	0	L	0	L	H	L	0	L	H
L	1	L	1	H	L	L	1	L	H
H	0	L				H	0	L	H
H	1	H				H	1	H	L

## 8 Device and Documentation Support

TI offers an extensive line of development tools. Tools and software to evaluate the performance of the device, generate code, and develop solutions are listed below.

### 8.1 Device and Documentation Support

**Table 8-1. Ordering Information Application Specific Versions <sup>(1)</sup>**

DEVICE NAME	NOMINAL SUPPLY VOLTAGE, $V_{NOM}$	DEVICE NAME	TYPICAL RESET THRESHOLD VOLTAGE- $V_{IT-}$
TPS312xx12DBV	1.2V	TPS312xAxxDBV	$V_{NOM} -1\%$
TPS312xx15DBV	1.5V	TPS312xBxxDBV	$V_{NOM} -2\%$
TPS312xx18DBV	1.8V	TPS312xCxxDBV	$V_{NOM} -3\%$
TPS312xx30DBV	3.0V	TPS312xDxxDBV	$V_{NOM} -4\%$
		TPS312xExxDBV	$V_{NOM} -5\%$
		TPS312xFxxDBV	$V_{NOM} -6\%$
		TPS312xGxxDBV	$V_{NOM} -7\%$
		TPS312xHxxDBV	$V_{NOM} -8\%$
		TPS312xIxxDBV	$V_{NOM} -9\%$
		TPS312xJxxDBV	$V_{NOM} -10\%$
		TPS312xKxxDBV	$V_{NOM} -11\%$
		TPS312xLxxDBV	$V_{NOM} -12\%$
		TPS312xMxxDBV	$V_{NOM} -13\%$
		TPS312xNxxDBV	$V_{NOM} -14\%$
		TPS312xOxxDBV	$V_{NOM} -15\%$

- For the application-specific versions contact Texas Instruments for availability, lead time, and minimum order quantities.

### 8.2 Receiving Notification of Documentation Updates

To receive notification of documentation updates, navigate to the device product folder on [ti.com](http://ti.com). Click on *Notifications* to register and receive a weekly digest of any product information that has changed. For change details, review the revision history included in any revised document.

### 8.3 Support Resources

[TI E2E™ support forums](#) are an engineer's go-to source for fast, verified answers and design help — straight from the experts. Search existing answers or ask your own question to get the quick design help you need.

Linked content is provided "AS IS" by the respective contributors. They do not constitute TI specifications and do not necessarily reflect TI's views; see TI's [Terms of Use](#).

### 8.4 Trademarks

TI E2E™ is a trademark of Texas Instruments.  
 All trademarks are the property of their respective owners.

### 8.5 Electrostatic Discharge Caution



This integrated circuit can be damaged by ESD. Texas Instruments recommends that all integrated circuits be handled with appropriate precautions. Failure to observe proper handling and installation procedures can cause damage.

ESD damage can range from subtle performance degradation to complete device failure. Precision integrated circuits may be more susceptible to damage because very small parametric changes could cause the device not to meet its published specifications.

### 8.6 Glossary

[TI Glossary](#) This glossary lists and explains terms, acronyms, and definitions.

## 9 Revision History

NOTE: Page numbers for previous revisions may differ from page numbers in the current version.

<b>Changes from Revision G (June 2024) to Revision H (March 2025)</b>	<b>Page</b>
• Rearrange table to meet latest data sheet guidelines.....	5
• Update VDD Min value to 0.9V.....	5
• Remove 'Dissipation Rating Table' and replace with 'Thermal Information'.....	6
• Remove Table 8-2. ....	14

---

<b>Changes from Revision F (December 2020) to Revision G (June 2024)</b>	<b>Page</b>
• Removed "If unused, the WDI connection must be high impedance to prevent device from causing a reset event." due to functionality not available.....	4
• Updated MR resistance typical value.....	6
• Updated tPHL and tPLH max specification.....	7

---

<b>Changes from Revision E (August 2011) to Revision F (December 2020)</b>	<b>Page</b>
• Updated the numbering format for tables, figures, and cross-references throughout the document.....	1
• Updated the description to highlight benefits of the key features.....	1
• Moved table of the details on package, threshold and top mark to the device and documentation support section in the back, leaving only the nomenclature and the topology summary here in this device comparison table section.....	3
• Moved pin out figures from first page to this new pin configuration section and added pin function table.....	4
• Moved Timing Diagrams to new section and added legend for the letters on the diagrams.....	8
• Moved and updated device overview, block diagram and function mode table to this newly created section and added subsections for detailed feature descriptions for MR, output topology (active high/low, push-pull/open-drain and watchdog timer).....	12

---

## 10 Mechanical, Packaging, and Orderable Information

The following pages include mechanical, packaging, and orderable information. This information is the most current data available for the designated devices. This data is subject to change without notice and revision of this document. For browser-based versions of this data sheet, refer to the left-hand navigation.

**PACKAGING INFORMATION**

Orderable part number	Status (1)	Material type (2)	Package   Pins	Package qty   Carrier	RoHS (3)	Lead finish/ Ball material (4)	MSL rating/ Peak reflow (5)	Op temp (°C)	Part marking (6)
<a href="#">TPS3123J12DBVR</a>	Active	Production	SOT-23 (DBV)   5	3000   LARGE T&R	Yes	NIPDAU	Level-1-260C-UNLIM	-40 to 85	PBNI
TPS3123J12DBVR.A	Active	Production	SOT-23 (DBV)   5	3000   LARGE T&R	Yes	NIPDAU	Level-1-260C-UNLIM	-40 to 85	PBNI
<a href="#">TPS3123J12DBVT</a>	Obsolete	Production	SOT-23 (DBV)   5	-	-	Call TI	Call TI	-40 to 85	PBNI
<a href="#">TPS3123J18DBVR</a>	Active	Production	SOT-23 (DBV)   5	3000   LARGE T&R	Yes	NIPDAU	Level-1-260C-UNLIM	-40 to 85	PBPI
TPS3123J18DBVR.A	Active	Production	SOT-23 (DBV)   5	3000   LARGE T&R	Yes	NIPDAU	Level-1-260C-UNLIM	-40 to 85	PBPI
<a href="#">TPS3123J18DBVT</a>	Obsolete	Production	SOT-23 (DBV)   5	-	-	Call TI	Call TI	-40 to 85	PBPI
<a href="#">TPS3124G15DBVR</a>	Active	Production	SOT-23 (DBV)   5	3000   LARGE T&R	Yes	NIPDAU	Level-1-260C-UNLIM	-40 to 85	PBRI
TPS3124G15DBVR.A	Active	Production	SOT-23 (DBV)   5	3000   LARGE T&R	Yes	NIPDAU	Level-1-260C-UNLIM	-40 to 85	PBRI
<a href="#">TPS3124J12DBVR</a>	Active	Production	SOT-23 (DBV)   5	3000   LARGE T&R	Yes	NIPDAU	Level-1-260C-UNLIM	-40 to 85	PBQI
TPS3124J12DBVR.A	Active	Production	SOT-23 (DBV)   5	3000   LARGE T&R	Yes	NIPDAU	Level-1-260C-UNLIM	-40 to 85	PBQI
<a href="#">TPS3124J12DBVT</a>	Obsolete	Production	SOT-23 (DBV)   5	-	-	Call TI	Call TI	-40 to 85	PBQI
<a href="#">TPS3124J18DBVR</a>	Active	Production	SOT-23 (DBV)   5	3000   LARGE T&R	Yes	NIPDAU	Level-1-260C-UNLIM	-40 to 85	PBSI
TPS3124J18DBVR.A	Active	Production	SOT-23 (DBV)   5	3000   LARGE T&R	Yes	NIPDAU	Level-1-260C-UNLIM	-40 to 85	PBSI
<a href="#">TPS3124J18DBVT</a>	Obsolete	Production	SOT-23 (DBV)   5	-	-	Call TI	Call TI	-40 to 85	PBSI
<a href="#">TPS3125G15DBVR</a>	Active	Production	SOT-23 (DBV)   5	3000   LARGE T&R	Yes	NIPDAU	Level-1-260C-UNLIM	-40 to 85	PBUI
TPS3125G15DBVR.A	Active	Production	SOT-23 (DBV)   5	3000   LARGE T&R	Yes	NIPDAU	Level-1-260C-UNLIM	-40 to 85	PBUI
<a href="#">TPS3125G15DBVT</a>	Obsolete	Production	SOT-23 (DBV)   5	-	-	Call TI	Call TI	-40 to 85	PBUI
<a href="#">TPS3125J12DBVR</a>	Active	Production	SOT-23 (DBV)   5	3000   LARGE T&R	Yes	NIPDAU	Level-1-260C-UNLIM	-40 to 85	PBTI
TPS3125J12DBVR.A	Active	Production	SOT-23 (DBV)   5	3000   LARGE T&R	Yes	NIPDAU	Level-1-260C-UNLIM	-40 to 85	PBTI
<a href="#">TPS3125J12DBVT</a>	Obsolete	Production	SOT-23 (DBV)   5	-	-	Call TI	Call TI	-40 to 85	PBTI
<a href="#">TPS3125J18DBVR</a>	Active	Production	SOT-23 (DBV)   5	3000   LARGE T&R	Yes	NIPDAU	Level-1-260C-UNLIM	-40 to 85	PBVI
TPS3125J18DBVR.A	Active	Production	SOT-23 (DBV)   5	3000   LARGE T&R	Yes	NIPDAU	Level-1-260C-UNLIM	-40 to 85	PBVI
<a href="#">TPS3125J18DBVT</a>	Obsolete	Production	SOT-23 (DBV)   5	-	-	Call TI	Call TI	-40 to 85	PBVI
<a href="#">TPS3125L30DBVR</a>	Active	Production	SOT-23 (DBV)   5	3000   LARGE T&R	Yes	NIPDAU	Level-1-260C-UNLIM	-40 to 85	PBXI
TPS3125L30DBVR.A	Active	Production	SOT-23 (DBV)   5	3000   LARGE T&R	Yes	NIPDAU	Level-1-260C-UNLIM	-40 to 85	PBXI
<a href="#">TPS3125L30DBVT</a>	Obsolete	Production	SOT-23 (DBV)   5	-	-	Call TI	Call TI	-40 to 85	PBXI
<a href="#">TPS3126E12DBVR</a>	Active	Production	SOT-23 (DBV)   5	3000   LARGE T&R	Yes	NIPDAU	Level-1-260C-UNLIM	-40 to 85	PFOI
TPS3126E12DBVR.A	Active	Production	SOT-23 (DBV)   5	3000   LARGE T&R	Yes	NIPDAU	Level-1-260C-UNLIM	-40 to 85	PFOI
<a href="#">TPS3126E12DBVT</a>	Obsolete	Production	SOT-23 (DBV)   5	-	-	Call TI	Call TI	-40 to 85	PFOI



Orderable part number	Status (1)	Material type (2)	Package   Pins	Package qty   Carrier	RoHS (3)	Lead finish/ Ball material (4)	MSL rating/ Peak reflow (5)	Op temp (°C)	Part marking (6)
<a href="#">TPS3126E15DBVR</a>	Active	Production	SOT-23 (DBV)   5	3000   LARGE T&R	Yes	NIPDAU	Level-1-260C-UNLIM	-40 to 85	PFPI
TPS3126E15DBVR.A	Active	Production	SOT-23 (DBV)   5	3000   LARGE T&R	Yes	NIPDAU	Level-1-260C-UNLIM	-40 to 85	PFPI
<a href="#">TPS3126E15DBVT</a>	Obsolete	Production	SOT-23 (DBV)   5	-	-	Call TI	Call TI	-40 to 85	PFPI
<a href="#">TPS3126E18DBVR</a>	Active	Production	SOT-23 (DBV)   5	3000   LARGE T&R	Yes	NIPDAU	Level-1-260C-UNLIM	-40 to 85	PFQI
TPS3126E18DBVR.A	Active	Production	SOT-23 (DBV)   5	3000   LARGE T&R	Yes	NIPDAU	Level-1-260C-UNLIM	-40 to 85	PFQI
<a href="#">TPS3126E18DBVT</a>	Obsolete	Production	SOT-23 (DBV)   5	-	-	Call TI	Call TI	-40 to 85	PFQI
<a href="#">TPS3128E12DBVT</a>	Active	Production	SOT-23 (DBV)   5	250   SMALL T&R	Yes	NIPDAU	Level-1-260C-UNLIM	-40 to 85	PFRI
TPS3128E12DBVT.A	Active	Production	SOT-23 (DBV)   5	250   SMALL T&R	Yes	NIPDAU	Level-1-260C-UNLIM	-40 to 85	PFRI
<a href="#">TPS3128E15DBVR</a>	Active	Production	SOT-23 (DBV)   5	3000   LARGE T&R	Yes	NIPDAU	Level-1-260C-UNLIM	-40 to 85	PFSI
TPS3128E15DBVR.A	Active	Production	SOT-23 (DBV)   5	3000   LARGE T&R	Yes	NIPDAU	Level-1-260C-UNLIM	-40 to 85	PFSI
<a href="#">TPS3128E15DBVT</a>	Obsolete	Production	SOT-23 (DBV)   5	-	-	Call TI	Call TI	-40 to 85	PFSI
<a href="#">TPS3128E18DBVR</a>	Active	Production	SOT-23 (DBV)   5	3000   LARGE T&R	Yes	NIPDAU	Level-1-260C-UNLIM	-40 to 85	PFTI
TPS3128E18DBVR.A	Active	Production	SOT-23 (DBV)   5	3000   LARGE T&R	Yes	NIPDAU	Level-1-260C-UNLIM	-40 to 85	PFTI
<a href="#">TPS3128E18DBVT</a>	Obsolete	Production	SOT-23 (DBV)   5	-	-	Call TI	Call TI	-40 to 85	PFTI

<sup>(1)</sup> **Status:** For more details on status, see our [product life cycle](#).

<sup>(2)</sup> **Material type:** When designated, preproduction parts are prototypes/experimental devices, and are not yet approved or released for full production. Testing and final process, including without limitation quality assurance, reliability performance testing, and/or process qualification, may not yet be complete, and this item is subject to further changes or possible discontinuation. If available for ordering, purchases will be subject to an additional waiver at checkout, and are intended for early internal evaluation purposes only. These items are sold without warranties of any kind.

<sup>(3)</sup> **RoHS values:** Yes, No, RoHS Exempt. See the [TI RoHS Statement](#) for additional information and value definition.

<sup>(4)</sup> **Lead finish/Ball material:** Parts may have multiple material finish options. Finish options are separated by a vertical ruled line. Lead finish/Ball material values may wrap to two lines if the finish value exceeds the maximum column width.

<sup>(5)</sup> **MSL rating/Peak reflow:** The moisture sensitivity level ratings and peak solder (reflow) temperatures. In the event that a part has multiple moisture sensitivity ratings, only the lowest level per JEDEC standards is shown. Refer to the shipping label for the actual reflow temperature that will be used to mount the part to the printed circuit board.

<sup>(6)</sup> **Part marking:** There may be an additional marking, which relates to the logo, the lot trace code information, or the environmental category of the part.

Multiple part markings will be inside parentheses. Only one part marking contained in parentheses and separated by a "-" will appear on a part. If a line is indented then it is a continuation of the previous line and the two combined represent the entire part marking for that device.

**Important Information and Disclaimer:** The information provided on this page represents TI's knowledge and belief as of the date that it is provided. TI bases its knowledge and belief on information provided by third parties, and makes no representation or warranty as to the accuracy of such information. Efforts are underway to better integrate information from third parties. TI has taken and continues to take reasonable steps to provide representative and accurate information but may not have conducted destructive testing or chemical analysis on incoming materials and chemicals. TI and TI suppliers consider certain information to be proprietary, and thus CAS numbers and other limited information may not be available for release.

In no event shall TI's liability arising out of such information exceed the total purchase price of the TI part(s) at issue in this document sold by TI to Customer on an annual basis.

**TAPE AND REEL INFORMATION**

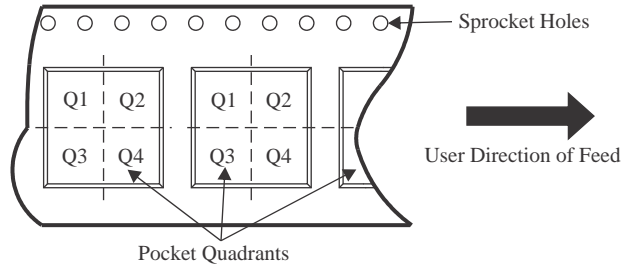
**QUADRANT ASSIGNMENTS FOR PIN 1 ORIENTATION IN TAPE**

\*All dimensions are nominal

Device	Package Type	Package Drawing	Pins	SPQ	Reel Diameter (mm)	Reel Width W1 (mm)	A0 (mm)	B0 (mm)	K0 (mm)	P1 (mm)	W (mm)	Pin1 Quadrant
TPS3123J12DBVR	SOT-23	DBV	5	3000	180.0	9.0	3.15	3.2	1.4	4.0	8.0	Q3
TPS3123J18DBVR	SOT-23	DBV	5	3000	180.0	9.0	3.15	3.2	1.4	4.0	8.0	Q3
TPS3124G15DBVR	SOT-23	DBV	5	3000	180.0	9.0	3.15	3.2	1.4	4.0	8.0	Q3
TPS3124J12DBVR	SOT-23	DBV	5	3000	180.0	9.0	3.15	3.2	1.4	4.0	8.0	Q3
TPS3124J18DBVR	SOT-23	DBV	5	3000	180.0	9.0	3.15	3.2	1.4	4.0	8.0	Q3
TPS3125G15DBVR	SOT-23	DBV	5	3000	180.0	9.0	3.15	3.2	1.4	4.0	8.0	Q3
TPS3125J12DBVR	SOT-23	DBV	5	3000	180.0	9.0	3.15	3.2	1.4	4.0	8.0	Q3
TPS3125J18DBVR	SOT-23	DBV	5	3000	180.0	9.0	3.15	3.2	1.4	4.0	8.0	Q3
TPS3125L30DBVR	SOT-23	DBV	5	3000	180.0	9.0	3.15	3.2	1.4	4.0	8.0	Q3
TPS3126E12DBVR	SOT-23	DBV	5	3000	180.0	9.0	3.15	3.2	1.4	4.0	8.0	Q3
TPS3126E15DBVR	SOT-23	DBV	5	3000	180.0	9.0	3.15	3.2	1.4	4.0	8.0	Q3
TPS3126E18DBVR	SOT-23	DBV	5	3000	180.0	9.0	3.15	3.2	1.4	4.0	8.0	Q3
TPS3128E12DBVT	SOT-23	DBV	5	250	180.0	9.0	3.15	3.2	1.4	4.0	8.0	Q3
TPS3128E15DBVR	SOT-23	DBV	5	3000	180.0	9.0	3.15	3.2	1.4	4.0	8.0	Q3
TPS3128E18DBVR	SOT-23	DBV	5	3000	180.0	9.0	3.15	3.2	1.4	4.0	8.0	Q3

**TAPE AND REEL BOX DIMENSIONS**

\*All dimensions are nominal

Device	Package Type	Package Drawing	Pins	SPQ	Length (mm)	Width (mm)	Height (mm)
TPS3123J12DBVR	SOT-23	DBV	5	3000	182.0	182.0	20.0
TPS3123J18DBVR	SOT-23	DBV	5	3000	182.0	182.0	20.0
TPS3124G15DBVR	SOT-23	DBV	5	3000	182.0	182.0	20.0
TPS3124J12DBVR	SOT-23	DBV	5	3000	182.0	182.0	20.0
TPS3124J18DBVR	SOT-23	DBV	5	3000	182.0	182.0	20.0
TPS3125G15DBVR	SOT-23	DBV	5	3000	182.0	182.0	20.0
TPS3125J12DBVR	SOT-23	DBV	5	3000	182.0	182.0	20.0
TPS3125J18DBVR	SOT-23	DBV	5	3000	182.0	182.0	20.0
TPS3125L30DBVR	SOT-23	DBV	5	3000	182.0	182.0	20.0
TPS3126E12DBVR	SOT-23	DBV	5	3000	182.0	182.0	20.0
TPS3126E15DBVR	SOT-23	DBV	5	3000	182.0	182.0	20.0
TPS3126E18DBVR	SOT-23	DBV	5	3000	182.0	182.0	20.0
TPS3128E12DBVT	SOT-23	DBV	5	250	182.0	182.0	20.0
TPS3128E15DBVR	SOT-23	DBV	5	3000	182.0	182.0	20.0
TPS3128E18DBVR	SOT-23	DBV	5	3000	182.0	182.0	20.0



# EXAMPLE BOARD LAYOUT

DBV0005A

SOT-23 - 1.45 mm max height

SMALL OUTLINE TRANSISTOR

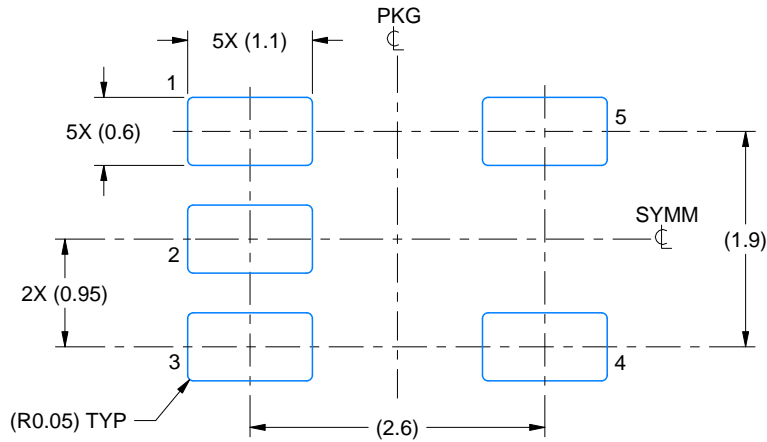

LAND PATTERN EXAMPLE  
EXPOSED METAL SHOWN  
SCALE:15X

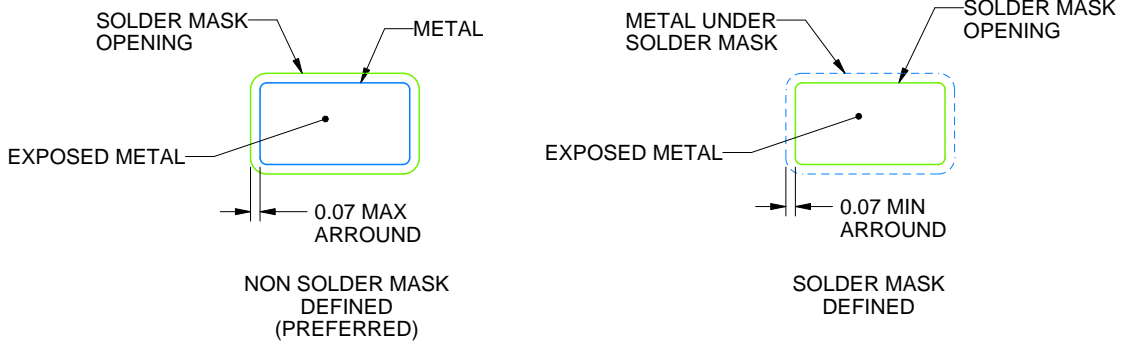

SOLDER MASK DETAILS

4214839/K 08/2024

NOTES: (continued)

- 6. Publication IPC-7351 may have alternate designs.
- 7. Solder mask tolerances between and around signal pads can vary based on board fabrication site.

# EXAMPLE STENCIL DESIGN

DBV0005A

SOT-23 - 1.45 mm max height

SMALL OUTLINE TRANSISTOR

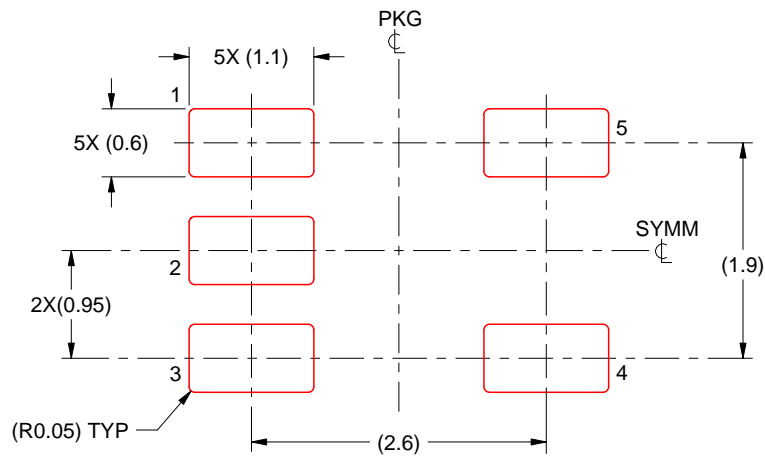

SOLDER PASTE EXAMPLE  
BASED ON 0.125 mm THICK STENCIL  
SCALE:15X

4214839/K 08/2024

NOTES: (continued)

8. Laser cutting apertures with trapezoidal walls and rounded corners may offer better paste release. IPC-7525 may have alternate design recommendations.
9. Board assembly site may have different recommendations for stencil design.

## IMPORTANT NOTICE AND DISCLAIMER

TI PROVIDES TECHNICAL AND RELIABILITY DATA (INCLUDING DATASHEETS), DESIGN RESOURCES (INCLUDING REFERENCE DESIGNS), APPLICATION OR OTHER DESIGN ADVICE, WEB TOOLS, SAFETY INFORMATION, AND OTHER RESOURCES "AS IS" AND WITH ALL FAULTS, AND DISCLAIMS ALL WARRANTIES, EXPRESS AND IMPLIED, INCLUDING WITHOUT LIMITATION ANY IMPLIED WARRANTIES OF MERCHANTABILITY, FITNESS FOR A PARTICULAR PURPOSE OR NON-INFRINGEMENT OF THIRD PARTY INTELLECTUAL PROPERTY RIGHTS.

These resources are intended for skilled developers designing with TI products. You are solely responsible for (1) selecting the appropriate TI products for your application, (2) designing, validating and testing your application, and (3) ensuring your application meets applicable standards, and any other safety, security, regulatory or other requirements.

These resources are subject to change without notice. TI grants you permission to use these resources only for development of an application that uses the TI products described in the resource. Other reproduction and display of these resources is prohibited. No license is granted to any other TI intellectual property right or to any third party intellectual property right. TI disclaims responsibility for, and you fully indemnify TI and its representatives against any claims, damages, costs, losses, and liabilities arising out of your use of these resources.

TI's products are provided subject to [TI's Terms of Sale](#), [TI's General Quality Guidelines](#), or other applicable terms available either on [ti.com](#) or provided in conjunction with such TI products. TI's provision of these resources does not expand or otherwise alter TI's applicable warranties or warranty disclaimers for TI products. Unless TI explicitly designates a product as custom or customer-specified, TI products are standard, catalog, general purpose devices.

TI objects to and rejects any additional or different terms you may propose.

Copyright © 2025, Texas Instruments Incorporated

Last updated 10/2025