

## BATTERY-BACKUP SUPERVISOR FOR RAM RETENTION

### FEATURES

- Supply Current of 40  $\mu$ A (Max)
- Battery Supply Current of 100 nA (Max)
- Precision 5-V Supply Voltage Monitor, Other Voltage Options on Request
- Backup-Battery Voltage Can Exceed  $V_{DD}$
- Watchdog Timer With 800-ms Time-Out
- Power-On Reset Generator With Fixed 100-ms Reset Delay Time
- Voltage Monitor for Power-Fail or Low-Battery Monitoring
- Battery Freshness Seal (TPS3617 Only)
- 8-Pin MSOP Package
- Temperature Range:  $-40^{\circ}$  to  $+85^{\circ}$ C

### APPLICATIONS

- Fax Machines
- Set-Top Boxes
- Advanced Voice Mail Systems
- Portable Battery Powered Equipment
- Computer Equipment
- Advanced Modems
- Automotive Systems
- Portable Long-Time Monitoring Equipment
- Point-of-Sale Equipment

### DESCRIPTION

The TPS3617 and TPS3618 are battery-backup supervisors that monitor 5 V supplies. They provide a battery-backup function ideal for applications that require data retention of CMOS RAM during fault conditions. When the voltage at  $V_{DD}$  drops below a preset threshold ( $V_{IT}$ ), the active low push-pull  $\overline{\text{RESET}}$  output asserts, and  $V_{OUT}$  switches from  $V_{DD}$  to  $V_{BAT}$ . When  $V_{DD}$  rises above the trip threshold,  $V_{OUT}$  switches immediately from  $V_{BAT}$  to  $V_{DD}$ . The  $\overline{\text{RESET}}$  output remains low until the delay time ( $t_d$ ) expires. During power on,  $\overline{\text{RESET}}$  is asserted when the supply voltage ( $V_{DD}$  or  $V_{BAT}$ ) goes higher than 1.1 V.

The PFI and  $\overline{\text{PFO}}$  pins are provided if additional voltage monitoring is needed. If the voltage at PFI is less than 1.15 V, the push-pull  $\overline{\text{PFO}}$  pin will assert low. When the voltage at PFI exceeds the threshold voltage,  $\overline{\text{PFO}}$  will go high.

These devices also feature a watchdog timer pin ( $\overline{\text{WDI}}$ ) that monitors processor activity and asserts  $\overline{\text{RESET}}$  if the the processor is inactive longer than the watchdog timeout period. If the watchdog timer is not used, the  $\overline{\text{WDI}}$  pin should be left floating.

The TPS3617 and TPS3618 are available in an 8-pin MSOP package and are characterized for operation over a temperature range of  $-40^{\circ}$ C to  $+85^{\circ}$ C.

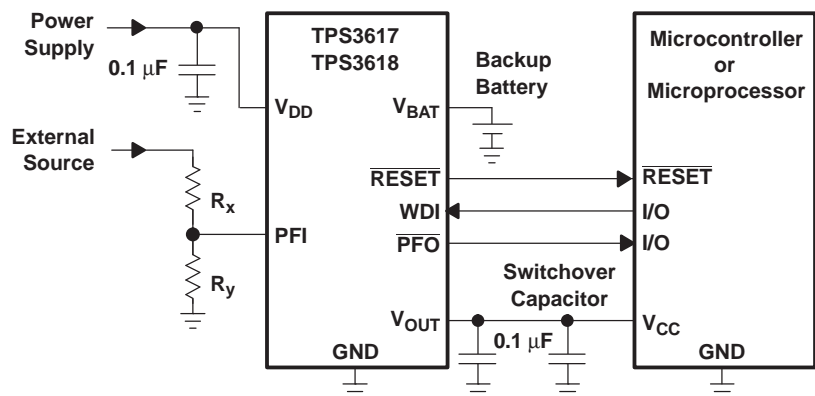
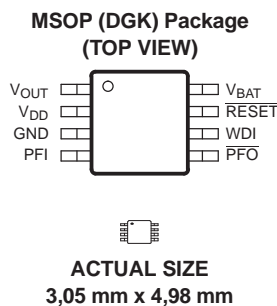

Please be aware that an important notice concerning availability, standard warranty, and use in critical applications of Texas Instruments semiconductor products and disclaimers thereto appears at the end of this data sheet.



This integrated circuit can be damaged by ESD. Texas Instruments recommends that all integrated circuits be handled with appropriate precautions. Failure to observe proper handling and installation procedures can cause damage.

ESD damage can range from subtle performance degradation to complete device failure. Precision integrated circuits may be more susceptible to damage because very small parametric changes could cause the device not to meet its published specifications.

### PACKAGE INFORMATION<sup>(1)</sup>

PRODUCT	NOMINAL SUPPLY VOLTAGE	THRESHOLD VOLTAGE (V <sub>IT</sub> ) <sup>(2)</sup>	SPECIFIED TEMPERATURE RANGE	PACKAGE MARKING	ORDERING NUMBER	TRANSPORT MEDIA, QUANTITY
TPS3617-50	5V	4.55V	–40°C to +125°C	ASD	TPS3617-50DGK	Tube, 80
					TPS3617-50DGKR	Tape and Reel, 2500
TPS3618-50				ANK	TPS3618-50DGKT	Tape and Reel, 250
					TPS3618-50DGKR	Tape and Reel, 2500

- (1) For the most current package and ordering information, see the Package Option Addendum at the end of this data sheet, or refer to our web site at [www.ti.com](http://www.ti.com).  
 (2) For other threshold voltages, contact the local TI sales office for availability and lead time.

### ABSOLUTE MAXIMUM RATINGS

over operating free-air temperature (unless otherwise noted)<sup>(1)</sup>

	TPS3617, TPS3618	UNIT
Input voltage range, V <sub>DD</sub>	–0.3 to 7	V
Input voltage range, PFI pin	–0.3 to (V <sub>DD</sub> + 0.3)	V
WDI pin	–0.3 to (V <sub>DD</sub> + 0.3)	V
Continuous output current at V <sub>OUT</sub> , I <sub>O</sub>	400	mA
All other pins, I <sub>O</sub>	±10	mA
Operating junction temperature range, T <sub>J</sub> <sup>(2)</sup>	–40 to +85	°C
Storage temperature range, T <sub>STG</sub>	–65 to +150	°C
Lead temperature soldering 1,6 mm (1/16 inch) from case for 10 seconds	+260	°C
Continuous total power dissipation	See <a href="#">Dissipation Rating Table</a>	

- (1) Stresses beyond those listed under *Absolute Maximum Ratings* may cause permanent damage to the device. These are stress ratings only, and functional operation of the device at these or any other conditions beyond those indicated under *Recommended Operating Conditions* is not implied. Exposure to absolute-maximum-rated conditions for extended periods may affect device reliability.  
 (2) Due to the low dissipated power in this device, it is assumed that T<sub>J</sub> = T<sub>A</sub>.

### DISSIPATION RATING TABLE

PACKAGE	T <sub>A</sub> ≤ +25°C POWER RATING	DERATING FACTOR ABOVE T <sub>A</sub> = +25°C	T <sub>A</sub> = +70°C POWER RATING	T <sub>A</sub> = +85°C POWER RATING
DGK	470 mW	3.76 mW/°C	301 mW	241 mW

## ELECTRICAL CHARACTERISTICS

1.65 V ≤ V<sub>DD</sub> ≤ 5.5 V, R<sub>LRESET</sub> = 1 MΩ, C<sub>LRESET</sub> = 50 pF, over operating temperature range (T<sub>J</sub> = –40°C to +85°C), unless otherwise noted. Typical values are at T<sub>J</sub> = +25°C.

PARAMETER		TEST CONDITIONS	MIN	TYP	MAX	UNIT		
V <sub>DD</sub>	Input supply range		1.65		5.5	V		
I <sub>DD</sub>	V <sub>DD</sub> supply current	V <sub>OUT</sub> = V <sub>DD</sub>			40	μA		
		V <sub>OUT</sub> = V <sub>BAT</sub>			40			
V <sub>BAT</sub>	Battery supply range		1.5		5.5	V		
I <sub>BAT</sub>	V <sub>BAT</sub> supply current	V <sub>OUT</sub> = V <sub>DD</sub>	–0.1		0.1	μA		
		V <sub>OUT</sub> = V <sub>BAT</sub>			0.5			
	Slew rate at V <sub>DD</sub> or V <sub>BAT</sub>				1	V/μs		
V <sub>I</sub>	Input voltage, any input		0		V <sub>DD</sub> + 0.3	V		
V <sub>OH</sub>	High-level output voltage	RESET	V <sub>DD</sub> = 1.8 V, I <sub>OH</sub> = –400 μA			V <sub>DD</sub> – 0.2	V	
			V <sub>DD</sub> = 3.3 V, I <sub>OH</sub> = –2 mA, V <sub>DD</sub> = 5 V, I <sub>OH</sub> = –3 mA			V <sub>DD</sub> – 0.4		
		PFO	V <sub>DD</sub> = 1.8 V, I <sub>OH</sub> = –20 μA			V <sub>DD</sub> – 0.3		
			V <sub>DD</sub> = 3.3 V, I <sub>OH</sub> = –80 μA, V <sub>DD</sub> = 5 V, I <sub>OH</sub> = –120 μA			V <sub>DD</sub> – 0.4		
V <sub>OL</sub>	Low-level output voltage	RESET PFO	V <sub>DD</sub> = 1.8 V, I <sub>OL</sub> = 400 μA			0.2	V	
			V <sub>DD</sub> = 3.3 V, I <sub>OL</sub> = 2 mA, V <sub>DD</sub> = 5 V, I <sub>OL</sub> = 3 mA			0.4		
			V <sub>BAT</sub> > 1.1 V, or V <sub>DD</sub> > 1.1 V, I <sub>OL</sub> = 20 μA			0.4		
V <sub>OUT</sub>	Normal mode	I <sub>O</sub> = 8.5 mA, V <sub>DD</sub> = 1.8 V, V <sub>BAT</sub> = 0 V				V <sub>DD</sub> – 0.050	V	
		I <sub>O</sub> = 125 mA, V <sub>DD</sub> = 3.3 V, V <sub>BAT</sub> = 0 V				V <sub>DD</sub> – 0.150		
		I <sub>O</sub> = 200 mA, V <sub>DD</sub> = 5 V, V <sub>BAT</sub> = 0 V				V <sub>DD</sub> – 0.200		
	Battery-backup mode	I <sub>O</sub> = 0.5 mA, V <sub>BAT</sub> = 1.5 V, V <sub>DD</sub> = 0 V				V <sub>BAT</sub> – 0.200		
		I <sub>O</sub> = 7.5 mA, V <sub>BAT</sub> = 3.3 V, V <sub>DD</sub> = 0 V				V <sub>BAT</sub> – 0.113		
R <sub>DS(on)</sub>	V <sub>DD</sub> to V <sub>OUT</sub> on-resistance	V <sub>DD</sub> = 5 V			0.6	1	Ω	
	V <sub>BAT</sub> to V <sub>OUT</sub> on-resistance	V <sub>BAT</sub> = 3.3 V			8	15		
I <sub>O</sub>	Continuous output current at V <sub>OUT</sub>					300	mA	
V <sub>IT</sub>	Negative-going input threshold voltage <sup>(2)</sup>	TPS3617-50	T <sub>A</sub> = –40°C to +85°C	4.46	4.55		V	
V <sub>PFI</sub>		PFI		1.13	1.15	1.17	V	
V <sub>HYS</sub>	V <sub>IT</sub> hysteresis	1.65 V < V <sub>IT</sub> < 2.5 V				20	mV	
		2.5 V < V <sub>IT</sub> < 3.5 V				40		
		3.5 V < V <sub>IT</sub> < 5.5 V				60		
	PFI hysteresis				12			
	V <sub>BSW</sub> hysteresis <sup>(3)</sup>	V <sub>DD</sub> = 1.8 V				55		
V <sub>IH</sub>	WDI high-level input voltage				0.7 x V <sub>DD</sub>			
V <sub>IL</sub>	WDI low-level input voltage				0.3 x V <sub>DD</sub>			
I <sub>IH</sub>	WDI high-level input current <sup>(4)</sup>	WDI = V <sub>DD</sub> = 5 V				150	μA	
I <sub>IL</sub>	WDI low-level input current <sup>(4)</sup>	WDI = 0 V, V <sub>DD</sub> = 5 V				–150	μA	
	WDI input transition rise and fall rate, Δt/ΔV					100	ns/V	
I <sub>I</sub>	PFI input current	PFI voltage < V <sub>DD</sub>				–25	25	nA
I <sub>OS</sub>	PFO short-circuit current	PFO = 0 V, V <sub>DD</sub> = 1.8 V				–0.3	mA	
		PFO = 0 V, V <sub>DD</sub> = 3.3 V				–1.1		
		PFO = 0 V, V <sub>DD</sub> = 5 V				–2.4		

(1) The lowest supply voltage at which RESET becomes active. t<sub>r</sub>, V<sub>DD</sub> ≥ 15 μs/V.

(2) To ensure the best stability of the threshold voltage, a bypass capacitor (ceramic, 0.1 μF) should be placed near the supply terminals.

(3) For V<sub>DD</sub> < 1.6 V, V<sub>OUT</sub> switches to V<sub>BAT</sub> regardless of V<sub>BAT</sub>.

(4) For details on how to optimize current consumption when using WDI, refer to the [Watchdog](#) section of this data sheet.

**ELECTRICAL CHARACTERISTICS (continued)**

1.65 V ≤ V<sub>DD</sub> ≤ 5.5 V, R<sub>LRESET</sub> = 1 MΩ, C<sub>LRESET</sub> = 50 pF, over operating temperature range (T<sub>J</sub> = –40°C to +85°C), unless otherwise noted. Typical values are at T<sub>J</sub> = +25°C.

PARAMETER		TEST CONDITIONS	MIN	TYP	MAX	UNIT
C <sub>i</sub>	Input capacitance, any input	V <sub>I</sub> = 0 V to 5 V		5		pF
t <sub>w</sub>	Pulse Width	V <sub>DD</sub>	V <sub>IH</sub> = V <sub>IT</sub> + 0.2 V, V <sub>IL</sub> = V <sub>IT</sub> – 0.2 V	6		μs
		WDI	V <sub>DD</sub> > V <sub>IT</sub> + 0.2 V, V <sub>IL</sub> = 0.3 × V <sub>DD</sub> , V <sub>IH</sub> = 0.7 × V <sub>DD</sub>	100		ns
t <sub>d</sub>	Delay time	V <sub>DD</sub> ≥ V <sub>IT</sub> + 0.2 V, See <a href="#">timing diagram</a>	60	100	140	ms
t <sub>(tout)</sub>	Watchdog time-out	V <sub>DD</sub> > V <sub>IT</sub> + 0.2 V, See <a href="#">timing diagram</a>	0.48	0.8	1.12	s
t <sub>PHL</sub>	Propagation (delay) time, high-to-low-level output	V <sub>DD</sub> to $\overline{\text{RESET}}$	V <sub>IL</sub> = V <sub>IT</sub> – 0.2 V, V <sub>IH</sub> = V <sub>IT</sub> + 0.2 V	2	5	μs
		PFI to $\overline{\text{PFO}}$	V <sub>IL</sub> = V <sub>PFI</sub> – 0.2 V, V <sub>IH</sub> = V <sub>PFI</sub> + 0.2 V	3	5	
Transition time		V <sub>DD</sub> to V <sub>BAT</sub>			3	μs

**TIMING DIAGRAM**

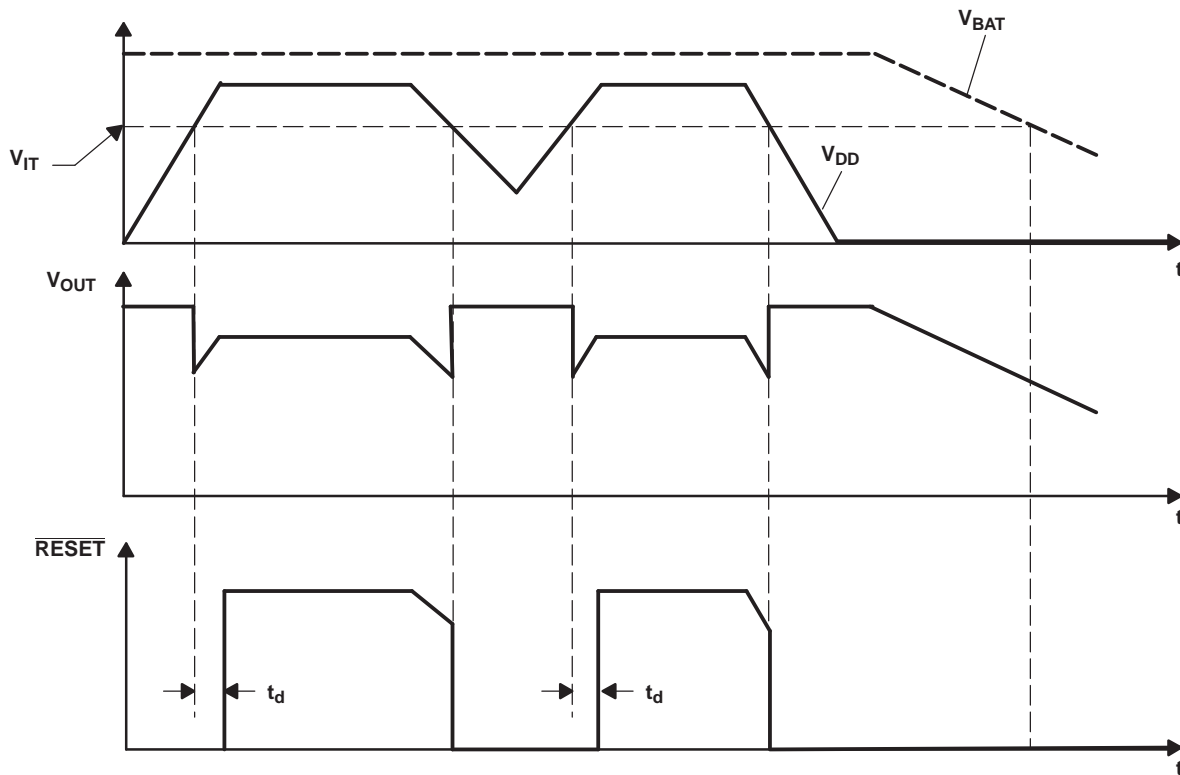

**Table 1. FUNCTION TABLE**

V <sub>DD</sub> > V <sub>IT</sub>	V <sub>DD</sub> > V <sub>BAT</sub>	V <sub>OUT</sub>	RESET
0	0	V <sub>BAT</sub>	0
0	1	V <sub>DD</sub>	0
1	0	V <sub>DD</sub>	1
1	1	V <sub>DD</sub>	1

**Table 2.  $\overline{\text{PFO}}$  FUNCTION TABLE**

$\text{PFI} > \text{V}_{\text{PFI}}$	$\overline{\text{PFO}}$
0	0
1	1

CONDITION:  $\text{V}_{\text{DD}} > \text{V}_{\text{DD(MIN)}}$

**Table 3. TERMINAL FUNCTIONS**

TERMINAL NAME	NO.	I/O	DESCRIPTION
GND	3	I	Ground
PFI	4	I	Power-fail comparator input
$\overline{\text{PFO}}$	5	O	Power-fail comparator output; asserts low when $\text{PFI} < 1.15 \text{ V}$
$\overline{\text{RESET}}$	7	O	Active-low push-pull reset output
$\text{V}_{\text{BAT}}$	8	I	Backup-battery input
$\text{V}_{\text{DD}}$	2	I	Input supply voltage
$\text{V}_{\text{OUT}}$	1	O	Supply output
WDI	6	I	Watchdog input. Should be left floating if not used.

**FUNCTIONAL BLOCK DIAGRAM**

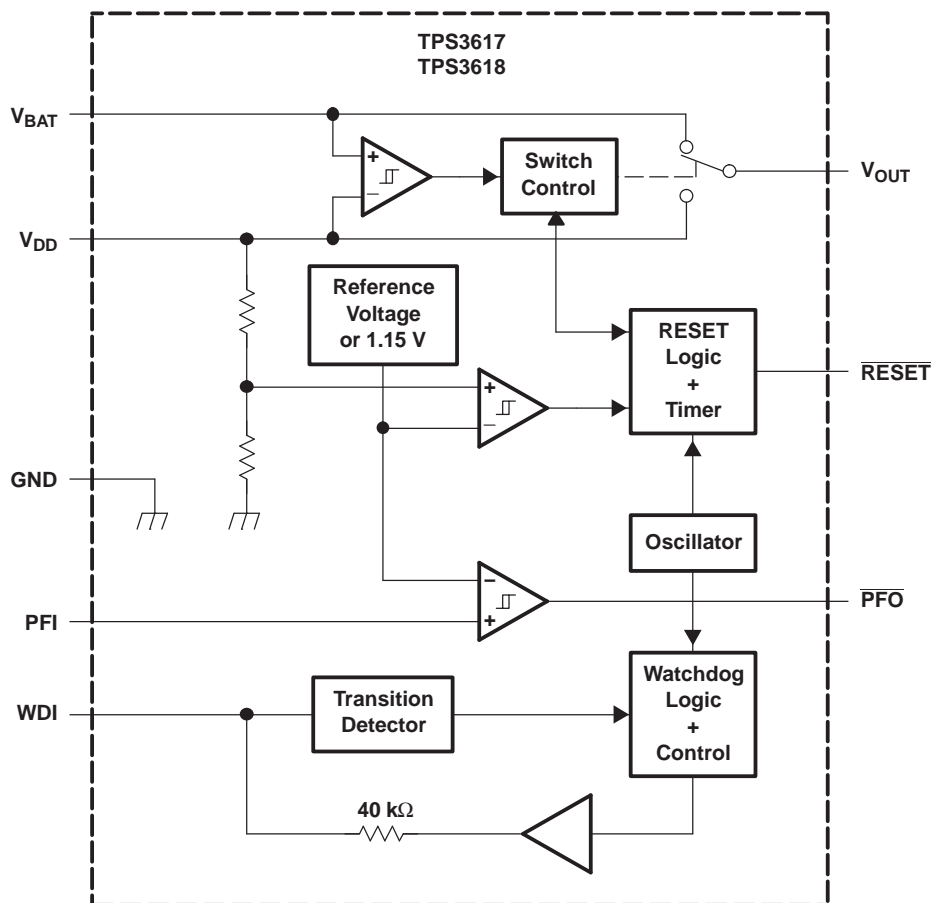

TYPICAL CHARACTERISTICS

TABLE OF GRAPHS

			FIGURE
$r_{DS(on)}$	Static drain-source on-state resistance ( $V_{DD}$ to $V_{OUT}$ )	vs Output current	3
	Static drain-source on-state resistance ( $V_{BAT}$ to $V_{OUT}$ )	vs Output current	4
$I_{DD}$	Supply current	vs Supply voltage	5
$V_{IT}$	Input threshold voltage at $\overline{RESET}$	vs Free-air temperature	6
$V_{OH}$	High-level output voltage at $\overline{RESET}$	vs High-level output current	7, 8
	High-level output voltage at $\overline{PFO}$		9, 10
$V_{OL}$	Low-level output voltage at $\overline{RESET}$	vs Low-level output current	11, 12
	Minimum pulse duration at $V_{DD}$	vs Threshold voltage overdrive at $V_{DD}$	13
	Minimum pulse duration at PFI	vs Threshold voltage overdrive at PFI	14

STATIC DRAIN-SOURCE ON-STATE RESISTANCE  
( $V_{DD}$  to  $V_{OUT}$ )  
vs  
OUTPUT CURRENT

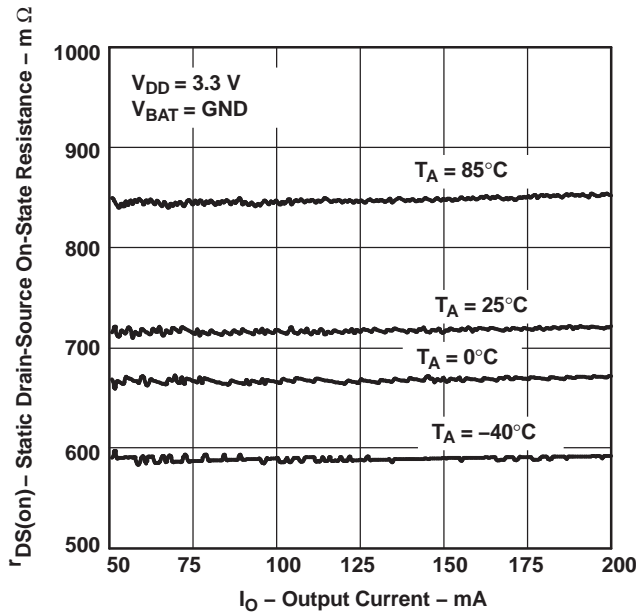

Figure 1.

STATIC DRAIN-SOURCE ON-STATE RESISTANCE  
( $V_{BAT}$  to  $V_{OUT}$ )  
vs  
OUTPUT CURRENT

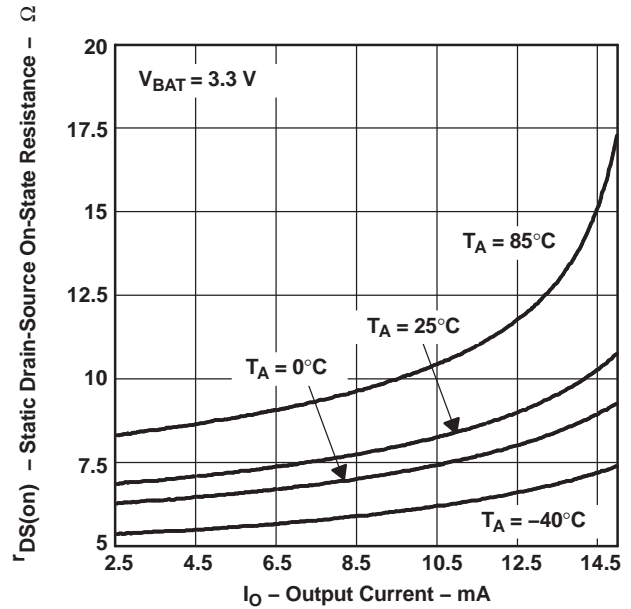

Figure 2.

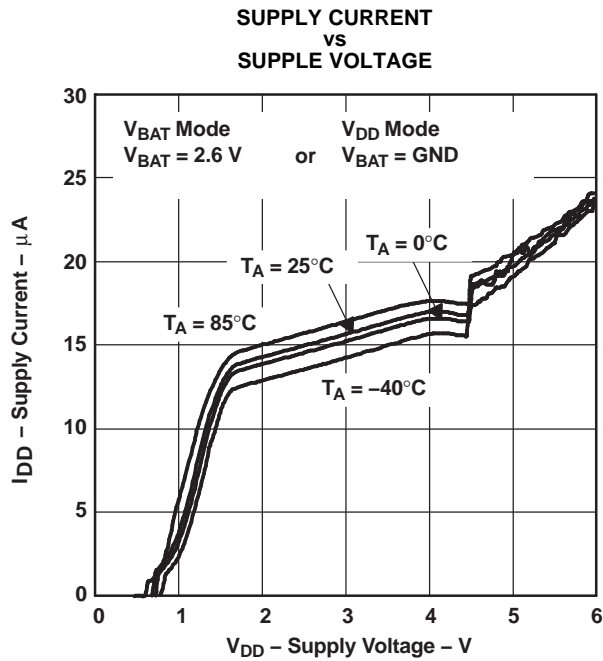

Figure 3.

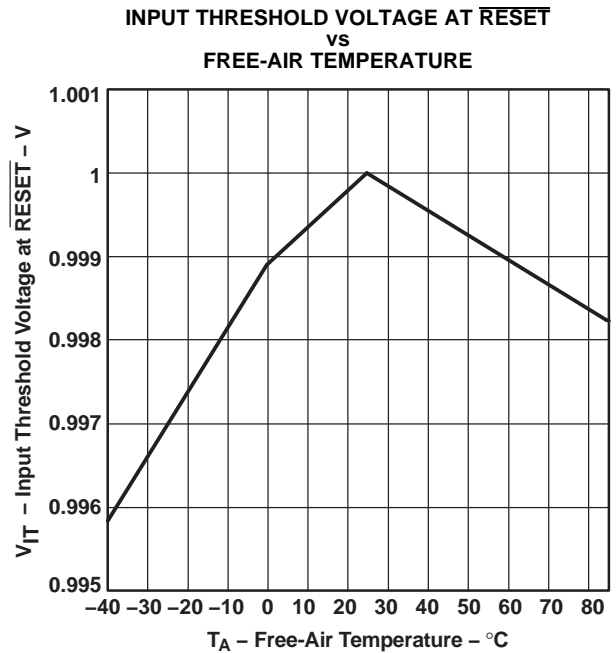

Figure 4.

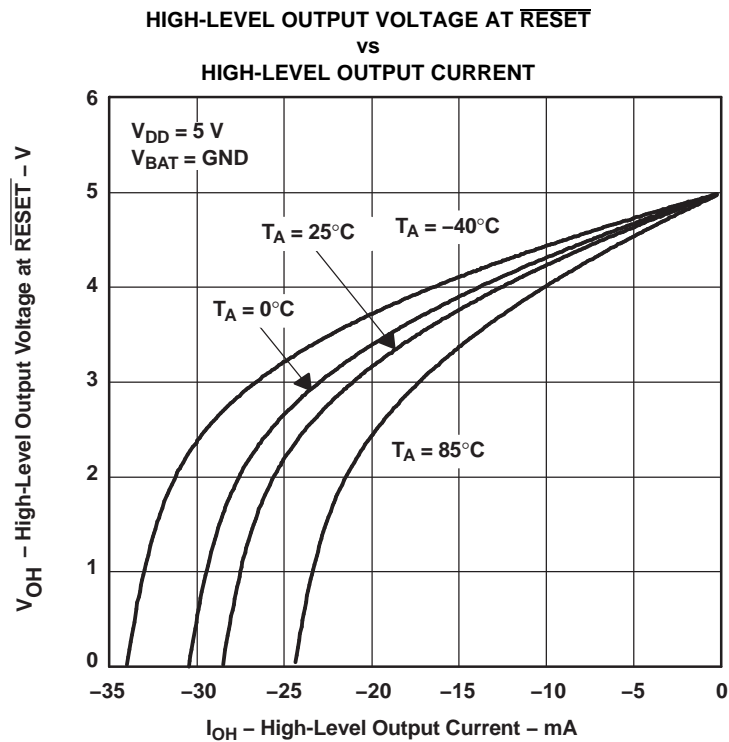

Figure 5.

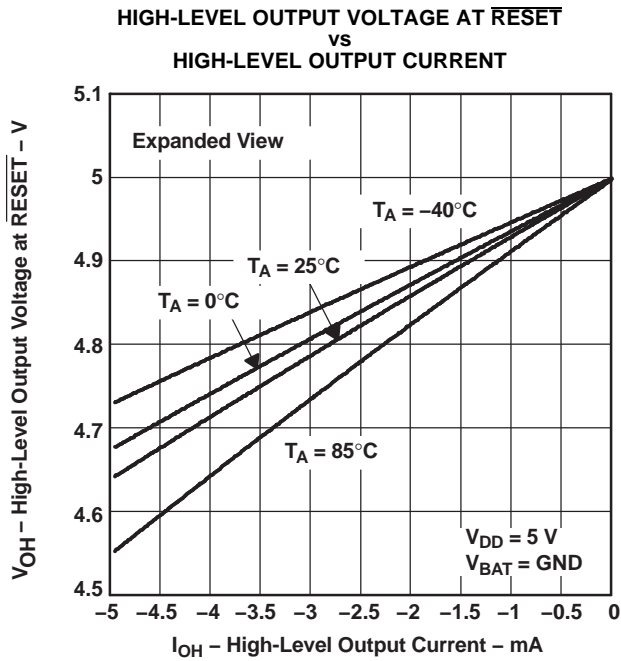

Figure 6.

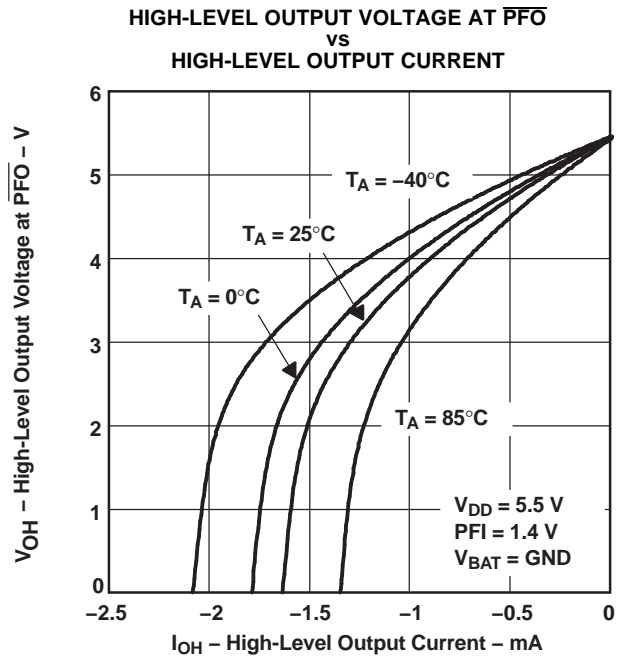

Figure 7.

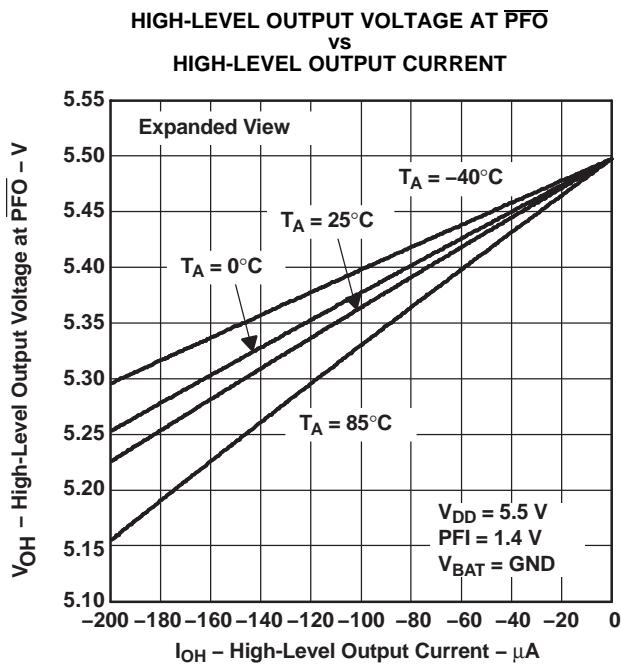

Figure 8.

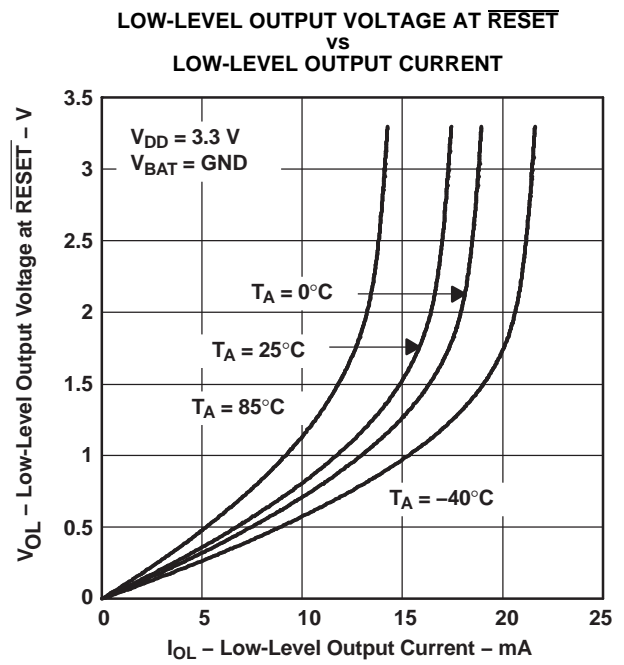

Figure 9.



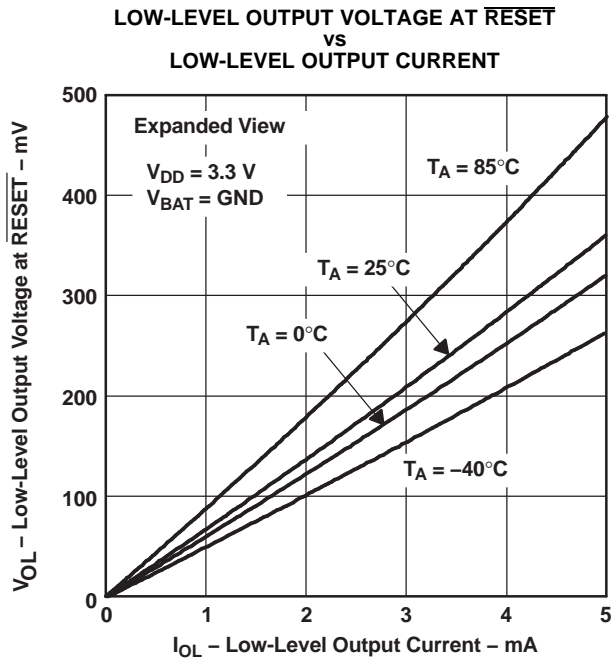

Figure 10.

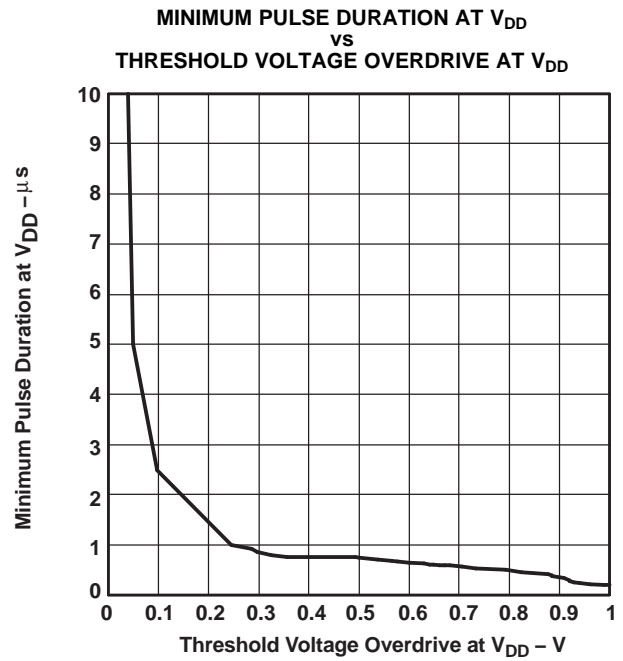

Figure 11.

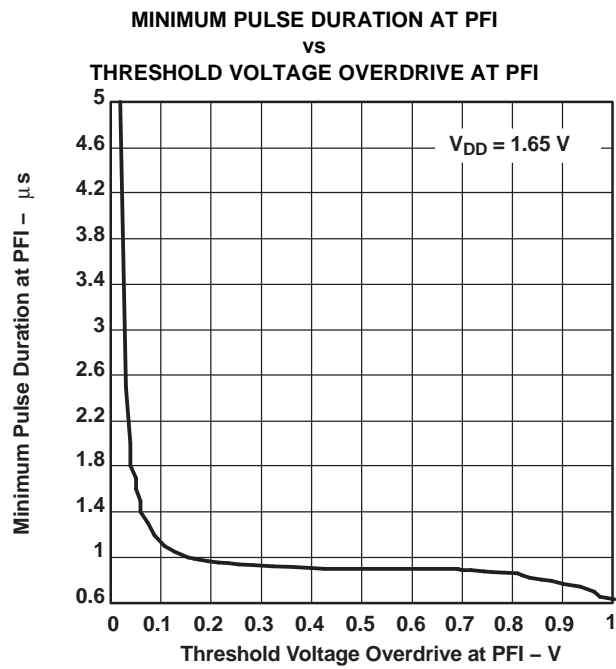

Figure 12.

## DETAILED DESCRIPTION

### BATTERY FRESHNESS SEAL (TPS3617 Only)

The battery freshness seal of the TPS3617 family disconnects the backup battery from the internal circuitry until it is needed. This ensures that the backup battery connected to  $V_{BAT}$  should be fresh when the final product is put to use. The following steps explain how to enable the freshness seal mode:

1. Connect  $V_{BAT}$  ( $V_{BAT} > V_{BAT(min)}$ ).
2. Ground  $\overline{PFO}$ .
3. Connect PFI to  $V_{DD}$  ( $PFI = V_{DD}$ ).
4. Connect  $V_{DD}$  to power supply ( $V_{DD} > V_{IT}$ ) and keep connected for  $5\text{ ms} < t < 35\text{ ms}$ .

The battery freshness seal mode is disabled by the positive-going edge of  $\overline{RESET}$  when  $V_{DD}$  is applied.

### POWER-FAIL COMPARATOR (PFI AND $\overline{PFO}$ )

An additional comparator monitors voltages other than the nominal supply voltage. The power-fail-input (PFI) can be compared with an internal voltage reference of 1.15 V. If the input voltage falls below the power-fail threshold ( $V_{(PFI)}$ ) of 1.15 V typical, the power-fail output ( $\overline{PFO}$ ) goes low. If it goes above  $V_{(PFI)}$  plus about 12-mV hysteresis, the output returns to high. By connecting two external resistors it is possible to supervise any voltages above  $V_{(PFI)}$ . The sum of both resistors should be about 1 M $\Omega$ , to minimize power consumption and also to ensure that the current in the PFI pin can be neglected compared with the current through the resistor network. The tolerance of the external resistors should be not more than 1% to ensure minimal variation of the sensed voltage. If the power-fail comparator is unused, connect PFI to ground and leave the  $\overline{PFO}$  unconnected.

### WATCHDOG

In a microprocessor- or DSP-based system, it is not only important to supervise the supply voltage, it is also important to ensure correct program execution. The task of a watchdog is to ensure that the program is not stalled in an indefinite loop. The microprocessor, microcontroller, or DSP has to toggle the watchdog input within 0.8 s typically, to avoid a timeout from occurring. Either a low-to-high or a high-to-low transition resets the internal watchdog timer. If the input is unconnected, the watchdog is disabled and should be retriggered internally. See Figure 13 for the watchdog timing diagram.

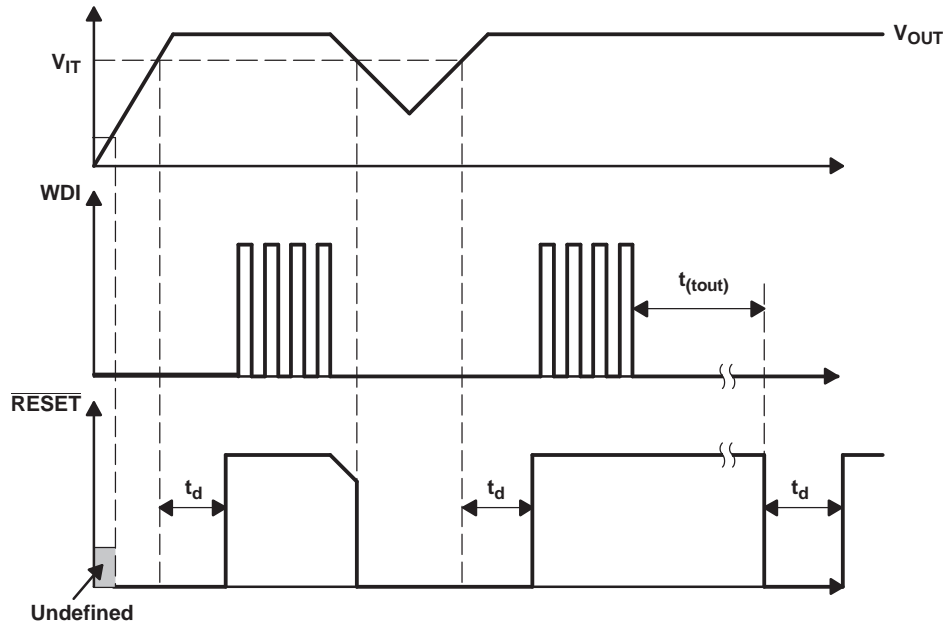

Figure 13. Watchdog Timing

## DETAILED DESCRIPTION (continued)

### SAVING CURRENT WHILE USING THE WATCHDOG

The watchdog input is internally driven low during the first 7/8 of the watchdog time-out period, then momentarily pulses high, resetting the watchdog counter. For minimum watchdog input current (minimum overall power consumption), leave WDI low for the majority of the watchdog time-out period, pulsing it low-high-low once within 7/8 of the watchdog time-out period to reset the watchdog timer. If instead, WDI is externally driven high for the majority of the time-out period, a current of e.g.  $5.0 \text{ V}/40 \text{ k}\Omega \approx 125 \mu\text{A}$  can flow into WDI.

### BACKUP-BATTERY SWITCHOVER

In case of a brownout or power failure, it may be necessary to preserve the contents of RAM. If a backup battery is installed at  $V_{\text{BAT}}$ , the device automatically switches the connected RAM to backup power when  $V_{\text{DD}}$  fails. In order to allow the backup battery (e.g., a 3.6-V lithium cell) to have a higher voltage than  $V_{\text{DD}}$ , these supervisors should not connect  $V_{\text{BAT}}$  to  $V_{\text{OUT}}$  when  $V_{\text{BAT}}$  is greater than  $V_{\text{DD}}$ .  $V_{\text{BAT}}$  only connects to  $V_{\text{OUT}}$  (through a 15- $\Omega$  switch) when  $V_{\text{DD}}$  falls below  $V_{\text{IT}}$  and  $V_{\text{BAT}}$  is greater than  $V_{\text{DD}}$ . When  $V_{\text{DD}}$  recovers, switchover is deferred either until  $V_{\text{DD}}$  crosses  $V_{\text{BAT}}$ , or until  $V_{\text{DD}}$  rises above the reset threshold  $V_{\text{IT}}$ .  $V_{\text{OUT}}$  connects to  $V_{\text{DD}}$  through a 1- $\Omega$  (max) PMOS switch when  $V_{\text{DD}}$  crosses the reset threshold.

FUNCTION TABLE		
$V_{\text{DD}} > V_{\text{BAT}}$	$V_{\text{DD}} > V_{\text{IT}}$	$V_{\text{OUT}}$
1	1	$V_{\text{DD}}$
1	0	$V_{\text{DD}}$
0	1	$V_{\text{DD}}$
0	0	$V_{\text{BAT}}$

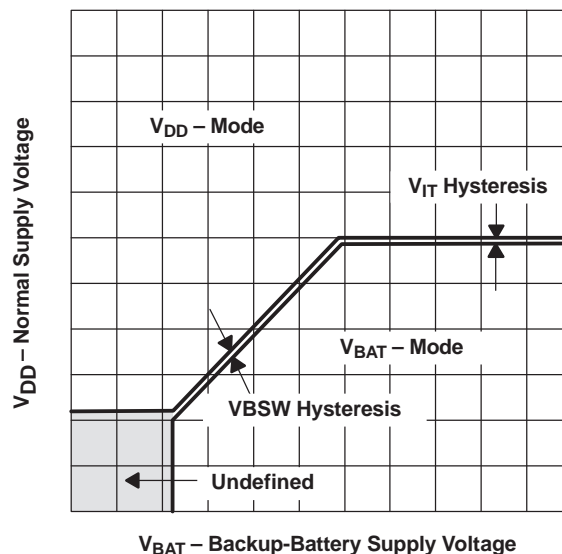

Figure 14.  $V_{\text{DD}} - V_{\text{BAT}}$  Switchover

**PACKAGING INFORMATION**

Orderable Device	Status (1)	Package Type	Package Drawing	Pins	Package Qty	Eco Plan (2)	Lead finish/ Ball material (6)	MSL Peak Temp (3)	Op Temp (°C)	Device Marking (4/5)	Samples
TPS3617-50DGKR	ACTIVE	VSSOP	DGK	8	2500	RoHS & Green	NIPDAU	Level-1-260C-UNLIM	-40 to 85	ASD	<a href="#">Samples</a>
TPS3618-50DGKT	ACTIVE	VSSOP	DGK	8	250	RoHS & Green	NIPDAU	Level-1-260C-UNLIM	-40 to 125	ANK	<a href="#">Samples</a>

(1) The marketing status values are defined as follows:

**ACTIVE:** Product device recommended for new designs.

**LIFEBUY:** TI has announced that the device will be discontinued, and a lifetime-buy period is in effect.

**NRND:** Not recommended for new designs. Device is in production to support existing customers, but TI does not recommend using this part in a new design.

**PREVIEW:** Device has been announced but is not in production. Samples may or may not be available.

**OBSOLETE:** TI has discontinued the production of the device.

(2) **RoHS:** TI defines "RoHS" to mean semiconductor products that are compliant with the current EU RoHS requirements for all 10 RoHS substances, including the requirement that RoHS substance do not exceed 0.1% by weight in homogeneous materials. Where designed to be soldered at high temperatures, "RoHS" products are suitable for use in specified lead-free processes. TI may reference these types of products as "Pb-Free".

**RoHS Exempt:** TI defines "RoHS Exempt" to mean products that contain lead but are compliant with EU RoHS pursuant to a specific EU RoHS exemption.

**Green:** TI defines "Green" to mean the content of Chlorine (Cl) and Bromine (Br) based flame retardants meet JS709B low halogen requirements of <=1000ppm threshold. Antimony trioxide based flame retardants must also meet the <=1000ppm threshold requirement.

(3) MSL, Peak Temp. - The Moisture Sensitivity Level rating according to the JEDEC industry standard classifications, and peak solder temperature.

(4) There may be additional marking, which relates to the logo, the lot trace code information, or the environmental category on the device.

(5) Multiple Device Markings will be inside parentheses. Only one Device Marking contained in parentheses and separated by a "~" will appear on a device. If a line is indented then it is a continuation of the previous line and the two combined represent the entire Device Marking for that device.

(6) Lead finish/Ball material - Orderable Devices may have multiple material finish options. Finish options are separated by a vertical ruled line. Lead finish/Ball material values may wrap to two lines if the finish value exceeds the maximum column width.

**Important Information and Disclaimer:**The information provided on this page represents TI's knowledge and belief as of the date that it is provided. TI bases its knowledge and belief on information provided by third parties, and makes no representation or warranty as to the accuracy of such information. Efforts are underway to better integrate information from third parties. TI has taken and continues to take reasonable steps to provide representative and accurate information but may not have conducted destructive testing or chemical analysis on incoming materials and chemicals. TI and TI suppliers consider certain information to be proprietary, and thus CAS numbers and other limited information may not be available for release.

In no event shall TI's liability arising out of such information exceed the total purchase price of the TI part(s) at issue in this document sold by TI to Customer on an annual basis.



## TAPE AND REEL INFORMATION



### QUADRANT ASSIGNMENTS FOR PIN 1 ORIENTATION IN TAPE



\*All dimensions are nominal

Device	Package Type	Package Drawing	Pins	SPQ	Reel Diameter (mm)	Reel Width W1 (mm)	A0 (mm)	B0 (mm)	K0 (mm)	P1 (mm)	W (mm)	Pin1 Quadrant
TPS3617-50DGKR	VSSOP	DGK	8	2500	330.0	12.4	5.3	3.4	1.4	8.0	12.0	Q1
TPS3618-50DGKT	VSSOP	DGK	8	250	177.8	12.4	5.3	3.4	1.4	8.0	12.0	Q1

**TAPE AND REEL BOX DIMENSIONS**

\*All dimensions are nominal

Device	Package Type	Package Drawing	Pins	SPQ	Length (mm)	Width (mm)	Height (mm)
TPS3617-50DGKR	VSSOP	DGK	8	2500	358.0	335.0	35.0
TPS3618-50DGKT	VSSOP	DGK	8	250	358.0	335.0	35.0

# DGK0008A



# PACKAGE OUTLINE

VSSOP - 1.1 mm max height

SMALL OUTLINE PACKAGE



**NOTES:**

PowerPAD is a trademark of Texas Instruments.

1. All linear dimensions are in millimeters. Any dimensions in parenthesis are for reference only. Dimensioning and tolerancing per ASME Y14.5M.
2. This drawing is subject to change without notice.
3. This dimension does not include mold flash, protrusions, or gate burrs. Mold flash, protrusions, or gate burrs shall not exceed 0.15 mm per side.
4. This dimension does not include interlead flash. Interlead flash shall not exceed 0.25 mm per side.
5. Reference JEDEC registration MO-187.



# EXAMPLE BOARD LAYOUT

DGK0008A

™ VSSOP - 1.1 mm max height

SMALL OUTLINE PACKAGE



LAND PATTERN EXAMPLE  
EXPOSED METAL SHOWN  
SCALE: 15X



SOLDER MASK DETAILS

4214862/A 04/2023

NOTES: (continued)

6. Publication IPC-7351 may have alternate designs.
7. Solder mask tolerances between and around signal pads can vary based on board fabrication site.
8. Vias are optional depending on application, refer to device data sheet. If any vias are implemented, refer to their locations shown on this view. It is recommended that vias under paste be filled, plugged or tented.
9. Size of metal pad may vary due to creepage requirement.

# EXAMPLE STENCIL DESIGN

DGK0008A

<sup>TM</sup> VSSOP - 1.1 mm max height

SMALL OUTLINE PACKAGE



SOLDER PASTE EXAMPLE  
SCALE: 15X

4214862/A 04/2023

NOTES: (continued)

11. Laser cutting apertures with trapezoidal walls and rounded corners may offer better paste release. IPC-7525 may have alternate design recommendations.
12. Board assembly site may have different recommendations for stencil design.

## IMPORTANT NOTICE AND DISCLAIMER

TI PROVIDES TECHNICAL AND RELIABILITY DATA (INCLUDING DATA SHEETS), DESIGN RESOURCES (INCLUDING REFERENCE DESIGNS), APPLICATION OR OTHER DESIGN ADVICE, WEB TOOLS, SAFETY INFORMATION, AND OTHER RESOURCES "AS IS" AND WITH ALL FAULTS, AND DISCLAIMS ALL WARRANTIES, EXPRESS AND IMPLIED, INCLUDING WITHOUT LIMITATION ANY IMPLIED WARRANTIES OF MERCHANTABILITY, FITNESS FOR A PARTICULAR PURPOSE OR NON-INFRINGEMENT OF THIRD PARTY INTELLECTUAL PROPERTY RIGHTS.

These resources are intended for skilled developers designing with TI products. You are solely responsible for (1) selecting the appropriate TI products for your application, (2) designing, validating and testing your application, and (3) ensuring your application meets applicable standards, and any other safety, security, regulatory or other requirements.

These resources are subject to change without notice. TI grants you permission to use these resources only for development of an application that uses the TI products described in the resource. Other reproduction and display of these resources is prohibited. No license is granted to any other TI intellectual property right or to any third party intellectual property right. TI disclaims responsibility for, and you will fully indemnify TI and its representatives against, any claims, damages, costs, losses, and liabilities arising out of your use of these resources.

TI's products are provided subject to [TI's Terms of Sale](#) or other applicable terms available either on [ti.com](https://www.ti.com) or provided in conjunction with such TI products. TI's provision of these resources does not expand or otherwise alter TI's applicable warranties or warranty disclaimers for TI products.

TI objects to and rejects any additional or different terms you may have proposed.

Mailing Address: Texas Instruments, Post Office Box 655303, Dallas, Texas 75265  
Copyright © 2024, Texas Instruments Incorporated