

TPS62850x 2.7V to 6V, 1A / 2A / 3A Step-Down Converter in SOT583 Package

1 Features

- **Functional Safety-Capable**
 - Documentation available to aid functional safety system design
- Input voltage range: 2.7V to 6V
- Output voltage from 0.6V to 5.5V
- 1% feedback voltage accuracy (full temperature range)
- $T_J = -40^{\circ}\text{C}$ to $+150^{\circ}\text{C}$
- Family of 1A, 2A (continuous), and 3A (peak) devices
- Adjustable switching frequency and sync of 1.8MHz to 4MHz
- Forced PWM or PWM and PFM operation
- Quiescent current $17\mu\text{A}$ (typical)
- Precise ENABLE input allows:
 - User-defined undervoltage lockout
 - Exact sequencing
- 100% duty cycle mode
- Active output discharge
- Power-good output with window comparator
- For device options with adjustable soft start, see the [TPS628511](#)

2 Applications

- Motor drives
- Factory automation and control
- Building automation
- Test and measurement
- General purpose POL

3 Description

The TPS62850x is a family of pin-to-pin 1A, 2A (continuous), and 3A (peak) high efficiency, easy-to-use synchronous step-down DC/DC converters. The devices are based on a peak current mode control topology. Low resistive switches allow up to 2A continuous output current and 3A peak current. The switching frequency is externally adjustable from 1.8MHz to 4MHz and can also be synchronized to an external clock in the same frequency range. In PWM and PFM mode, the TPS62850x automatically enters power save mode at light loads to maintain high efficiency across the whole load range. The TPS62850x provides a 1% output voltage accuracy in PWM mode, which helps design a power supply with high output voltage accuracy, fulfilling tight supply voltage requirements of digital processors and FPGA.

The TPS62850x is available in an 8-pin $1.60\text{mm} \times 2.10\text{mm}$ SOT583 package.

Package Information

PART NUMBER	PACKAGE ⁽¹⁾	PACKAGE SIZE ⁽²⁾
TPS62850x	DRL (SOT583, 8)	$1.60\text{mm} \times 2.10\text{mm}$

(1) For more information, see [Section 12](#).

(2) The package size (length \times width) is a nominal value and includes pins, where applicable.

Device Information

PART NUMBER ⁽¹⁾	OUTPUT CURRENT	OUTPUT VOLTAGE
TPS628501DRLR	1A	Adjustable
		Fixed 1.8V
TPS628502DRLR	2A	Adjustable
TPS628502ADRLR		Fixed 1.2V
TPS628502MDRLR		Fixed 1.8V
TPS628503DRLR	3A	Adjustable

(1) See the [Device Comparison Table](#).

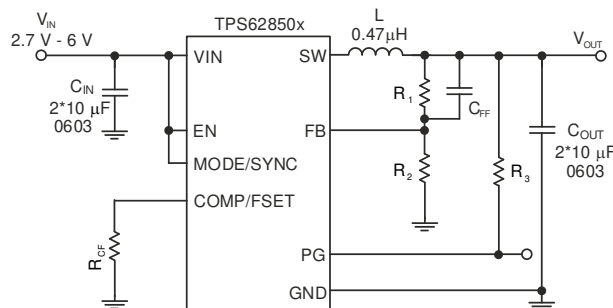

Simplified Schematic

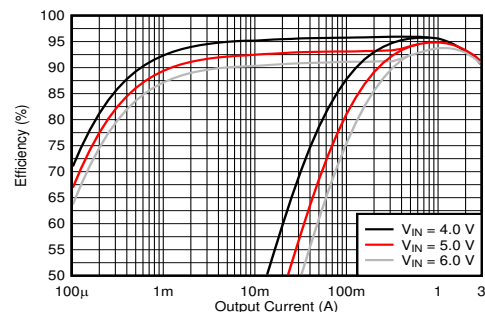

Efficiency versus I_{OUT} , $V_{OUT} = 3.3\text{V}$



Table of Contents

1 Features	1	8.4 Device Functional Modes.....	13
2 Applications	1	9 Application and Implementation	15
3 Description	1	9.1 Application Information.....	15
4 Device Comparison Table	3	9.2 Typical Application.....	17
5 Pin Configuration and Functions	3	9.3 System Examples.....	27
6 Specifications	4	9.4 Power Supply Recommendations.....	28
6.1 Absolute Maximum Ratings.....	4	9.5 Layout.....	28
6.2 ESD Ratings.....	4	10 Device and Documentation Support	30
6.3 Recommended Operating Conditions.....	4	10.1 Device Support.....	30
6.4 Thermal Information.....	4	10.2 Receiving Notification of Documentation Updates..	30
6.5 Electrical Characteristics.....	5	10.3 Support Resources.....	30
6.6 Typical Characteristics.....	8	10.4 Trademarks.....	30
7 Parameter Measurement Information	9	10.5 Electrostatic Discharge Caution.....	30
7.1 Schematic.....	9	10.6 Glossary.....	30
8 Detailed Description	10	11 Revision History	30
8.1 Overview.....	10	12 Mechanical, Packaging, and Orderable Information	31
8.2 Functional Block Diagram.....	10		
8.3 Feature Description.....	10		

4 Device Comparison Table

DEVICE NUMBER	OUTPUT CURRENT	V _{OUT} DISCHARGE	FOLDBACK CURRENT LIMIT	SPREAD SPECTRUM CLOCKING (SSC)	SOFT START	OUTPUT VOLTAGE
TPS628501DRLR	1A	ON	OFF	By COMP/FSET pin	Internal 1ms	Adjustable
TPS6285010MDRLR						Fixed 1.8V
TPS628502DRLR	2A					Adjustable
TPS6285020ADRLR						Fixed 1.2V
TPS6285020MDRLR						Fixed 1.8V
TPS628503DRLR	3A					Adjustable

5 Pin Configuration and Functions

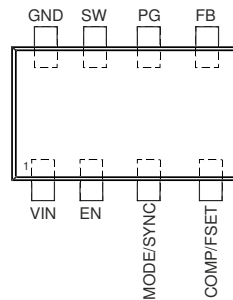

Figure 5-1. 8-Pin SOT583 DRL Package (Top View)

Table 5-1. Pin Functions

PIN		TYPE ⁽¹⁾	DESCRIPTION
NAME	NO.		
EN	2	I	This is the enable pin of the device. Connect to logic low to disable the device. Pull high to enable the device. Do not leave this pin unconnected.
FB	5	I	Voltage feedback input. Connect the resistive output voltage divider to this pin.
GND	8		Ground pin
MODE/SYNC	3	I	The device runs in PFM/PWM mode when this pin is pulled low. When the pin is pulled high, the device runs in forced PWM mode. Do not leave this pin unconnected. The mode pin can also be used to synchronize the device to an external frequency. See Section 6.5 for the detailed specification for the digital signal applied to this pin for external synchronization.
COMP/FSET	4	I	Device compensation and frequency set input. A resistor from this pin to GND defines the compensation of the control loop as well as the switching frequency if not externally synchronized.
PG	6	O	Open-drain power-good output
SW	7		This is the switch pin of the converter and is connected to the internal Power MOSFETs.
VIN	1		Power supply input. Make sure the input capacitor is connected as close as possible between pin VIN and GND.

(1) I = input, O = output

6 Specifications

6.1 Absolute Maximum Ratings

over operating temperature range (unless otherwise noted)⁽¹⁾

		MIN	MAX	UNIT
Pin voltage ⁽²⁾	VIN	-0.3	6.5	V
Pin voltage ⁽²⁾	SW (DC)	-0.3	V _{IN} + 0.3	V
Pin voltage ⁽²⁾	SW (AC, less than 10ns) ⁽³⁾	-3	10	V
Pin voltage ⁽²⁾	COMP/FSET, PG	-0.3	V _{IN} + 0.3	V
Pin voltage ⁽²⁾	EN, MODE/SYNC, FB	-0.3	6.5	V
T _{stg}	Storage temperature	-65	150	°C

- (1) Stresses beyond those listed under *Absolute Maximum Rating* may cause permanent damage to the device. These are stress ratings only, which do not imply functional operation of the device at these or any other conditions beyond those indicated under *Recommended Operating Condition*. Exposure to absolute-maximum-rated conditions for extended periods may affect device reliability.
- (2) All voltage values are with respect to the network ground terminal.
- (3) While switching.

6.2 ESD Ratings

			VALUE	UNIT
V _(ESD)	Electrostatic discharge	Human body model (HBM), per ANSI/ESDA/JEDEC JS-001, all pins ⁽¹⁾	±2000	V
		Charged device model (CDM), per JEDEC specification JS-002 ⁽²⁾	±750	

- (1) JEDEC document JEP155 states that 500-V HBM allows safe manufacturing with a standard ESD control process.
- (2) JEDEC document JEP157 states that 250-V CDM allows safe manufacturing with a standard ESD control process.

6.3 Recommended Operating Conditions

Over operating temperature range (unless otherwise noted)

		MIN	NOM	MAX	UNIT
V _{IN}	Input voltage range	2.7		6	V
V _{OUT}	Output voltage range	0.6		5.5	V
L	Effective inductance	0.32	0.47	1.2	μH
C _{OUT}	Effective output capacitance ⁽¹⁾	8	10	200	μF
C _{IN}	Effective input capacitance ⁽¹⁾	5	10		μF
R _{CF}		4.5		100	kΩ
I _{SINK_PG}	Sink current at PG pin	0		2	mA
I _{OUT}	Output current, TPS628503 ⁽²⁾	0		3	A
T _J	Junction temperature	-40		150	°C

- (1) The values given for all the capacitors in the table are effective capacitance, which includes the DC bias effect. Due to the DC bias effect of ceramic capacitors, the effective capacitance is lower than the nominal value when a voltage is applied. Please check the manufacturer's DC bias curves for the effective capacitance vs DC voltage applied. Further restrictions may apply. Please see the feature description for COMP/FSET about the output capacitance vs compensation setting and output voltage.
- (2) This part is designed for a 2A continuous output current at a junction temperature of 105°C or 3A at a junction temperature of 85°C; exceeding the output current or the junction temperature can significantly reduce lifetime.

6.4 Thermal Information

THERMAL METRIC ⁽¹⁾		TPS62850x	TPS62850x	UNIT
		DRL (JEDEC) ⁽²⁾	DRL (EVM)	
		8 PINS	8 PINS	
R _{θJA}	Junction-to-ambient thermal resistance	110	60	°C/W

THERMAL METRIC ⁽¹⁾		TPS62850x	TPS62850x	UNIT
		DRL (JEDEC) ⁽²⁾	DRL (EVM)	
		8 PINS	8 PINS	
R _{θJC(top)}	Junction-to-case (top) thermal resistance	41.3	n/a	°C/W
R _{θJB}	Junction-to-board thermal resistance	20	n/a	°C/W
Ψ _{JT}	Junction-to-top characterization parameter	0.8	n/a	°C/W
Y _{JB}	Junction-to-board characterization parameter	20	n/a	°C/W
R _{θJC(bot)}	Junction-to-case (bottom) thermal resistance	n/a	n/a	°C/W

(1) For more information about traditional and new thermal metrics, see the [Semiconductor and IC Package Thermal Metrics](#) application report.

(2) JEDEC standard PCB with 4 layers, no thermal vias.

6.5 Electrical Characteristics

Over operating junction temperature range ($T_J = -40^{\circ}\text{C}$ to $+150^{\circ}\text{C}$) and $V_{IN} = 2.7\text{ V}$ to 6 V . Typical values at $V_{IN} = 5\text{ V}$ and $T_J = 25^{\circ}\text{C}$. (unless otherwise noted)

PARAMETER		TEST CONDITIONS	MIN	TYP	MAX	UNIT
SUPPLY						
I _Q	Quiescent current	EN = V _{IN} , no load, device not switching, MODE = GND, V _{OUT} = 0.6V		17	36	μA
I _{SD}	Shutdown current	EN = GND, Nominal value at T _J = 25°C, Max value at T _J = 150°C		1.5	48	μA
I _{SD}	Shutdown current	EN = GND, T _J = -40°C to 85°C, including HSFET leakage			5.5	μA
V _{UVLO}	Undervoltage lock out threshold	V _{IN} rising	2.45	2.6	2.7	V
		V _{IN} falling	2.1	2.5	2.6	V
T _{JSD}	Thermal shutdown threshold	T _J rising		170		°C
	Thermal shutdown hysteresis	T _J falling		15		°C
CONTROL and INTERFACE						
V _{EN,IH}	Input threshold voltage at EN, rising edge		1.05	1.1	1.15	V
V _{EN,IL}	Input threshold voltage at EN, falling edge		0.96	1.0	1.05	V
V _{IH}	High-level input-threshold voltage at MODE/SYNC		1.1			V
I _{EN,LKG}	Input leakage current into EN	V _{IH} = V _{IN} or V _{IL} = GND			125	nA
V _{IL}	Low-level input-threshold voltage at MODE/SYNC				0.3	V
I _{LKG}	Input leakage current into MODE/SYNC				100	nA
t _{Delay}	Enable delay time	Time from EN high to device starts switching; V _{IN} applied already	135	200	520	μs
t _{Delay}	Enable delay time	Time from EN high to device starts switching; V _{IN} applied already, V _{IN} ≥ 3.3V			480	μs
t _{Ramp}	Output voltage ramp time	Time from device starts switching to power good; device not in current limit	0.8	1.3	1.8	ms
f _{SYNC}	Frequency range on MODE/SYNC pin for synchronization		1.8		4	MHz
	Duty cycle of synchronization signal at MODE/SYNC		20		80	%
	Time to lock to external frequency			50		μs
	resistance from COMP/FSET to GND for logic low	internal frequency setting with f = 2.25MHz	0		2.5	kΩ

6.5 Electrical Characteristics (continued)

Over operating junction temperature range ($T_J = -40^\circ\text{C}$ to $+150^\circ\text{C}$) and $V_{IN} = 2.7\text{ V}$ to 6 V . Typical values at $V_{IN} = 5\text{ V}$ and $T_J = 25^\circ\text{C}$. (unless otherwise noted)

PARAMETER		TEST CONDITIONS	MIN	TYP	MAX	UNIT
	Voltage on COMP/FSET for logic high	internal frequency setting with $f = 2.25\text{MHz}$		V_{IN}		V
V_{TH_PG}	UVP power-good threshold voltage; DC level	rising ($\%V_{FB}$)	92	95	98	%
V_{TH_PG}	UVP power-good threshold voltage; DC level	falling ($\%V_{FB}$)	87	90	93	%
V_{TH_PG}	OVP power-good threshold voltage; DC level	rising ($\%V_{FB}$)	107	110	113	%
	OVP power-good threshold voltage; DC level	falling ($\%V_{FB}$)	104	107	111	%
V_{PG_OL}	Low-level output voltage at PG	$I_{SINK_PG} = 2\text{mA}$		0.07	0.3	V
I_{PG_LKG}	Input leakage current into PG	$V_{PG} = 5\text{V}$			100	nA
t_{PG}	PG deglitch time	for a high level to low level transition on the power-good output		40		μs
OUTPUT						
V_{FB}	Feedback voltage, adjustable version			0.6		V
I_{FB_LKG}	Input leakage current into FB, adjustable version	$V_{FB} = 0.6\text{V}$		1	70	nA
V_{FB}	Feedback voltage accuracy	PWM, $V_{IN} \geq V_{OUT} + 1\text{V}$	-1		1	%
V_{FB}	Feedback voltage accuracy	PFM, $V_{IN} \geq V_{OUT} + 1\text{V}$, $V_{OUT} \geq 1.0\text{V}$, $C_{o,eff} \geq 10\mu\text{F}$, $L = 0.47\mu\text{H}$	-1		2	%
V_{FB}	Feedback voltage accuracy	PFM, $V_{IN} \geq V_{OUT} + 1\text{V}$, $V_{OUT} < 1.0\text{V}$, $C_{o,eff} \geq 15\mu\text{F}$, $L = 0.47\mu\text{H}$	-1		3	%
	Load regulation	PWM		0.05		%/A
	Line regulation	PWM, $I_{OUT} = 1\text{A}$, $V_{IN} \geq V_{OUT} + 1\text{V}$		0.02		%/V
R_{DIS}	Output discharge resistance				100	Ω
f_{SW}	PWM Switching frequency range	MODE = high, see the FSET pin functionality about setting the switching frequency	1.8	2.25	4	MHz
f_{SW}	PWM Switching frequency range	MODE = low, see the FSET pin functionality about setting the switching frequency	1.8		3.5	MHz
f_{SW}	PWM Switching frequency	with COMP/FSET tied to GND or V_{IN}	2.025	2.25	2.475	MHz
f_{SW}	PWM Switching frequency tolerance	using a resistor from COMP/FSET to GND	-12		12	%
$t_{on,min}$	Minimum on-time of high-side FET	$V_{IN} = 3.3\text{V}$, $T_J = -40^\circ\text{C}$ to 125°C		35	50	ns
$t_{on,min}$	Minimum on-time of low-side FET			10		ns
$R_{DS(ON)}$	High-side FET on-resistance	$V_{IN} \geq 5\text{V}$		65	120	m Ω
	Low-side FET on-resistance	$V_{IN} \geq 5\text{V}$		33	70	m Ω
	High-side MOSFET leakage current	$T_J = -40^\circ\text{C}$ to 85°C		0.01	44	μA
	High-side MOSFET leakage current			0.01	44	μA
	Low-side MOSFET leakage current	$T_J = -40^\circ\text{C}$ to 85°C		0.01	5	μA
	Low-side MOSFET leakage current			0.01	70	μA
	SW leakage	$V(SW) = 0.6\text{V}$, current into SW pin	-0.05		11	μA
I_{LIMH}	High-side FET switch current limit	DC value, for TPS628503; $V_{IN} = 3\text{V}$ to 6V	3.45	4.5	5.1	A

6.5 Electrical Characteristics (continued)

Over operating junction temperature range ($T_J = -40^{\circ}\text{C}$ to $+150^{\circ}\text{C}$) and $V_{IN} = 2.7\text{ V}$ to 6 V . Typical values at $V_{IN} = 5\text{ V}$ and $T_J = 25^{\circ}\text{C}$. (unless otherwise noted)

PARAMETER		TEST CONDITIONS	MIN	TYP	MAX	UNIT
I_{LIMH}	High-side FET switch current limit	DC value, for TPS628502; $V_{IN} = 3\text{V to }6\text{V}$	2.85	3.4	3.9	A
I_{LIMH}	High-side FET switch current limit	DC value, for TPS628501; $V_{IN} = 3\text{V to }6\text{V}$	2.1	2.6	3.0	A
I_{LIMNEG}	Low-side FET negative current limit	DC value		-1.8		A

6.6 Typical Characteristics

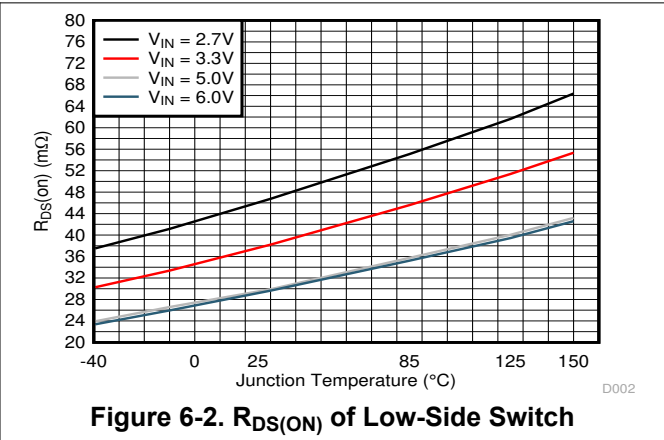
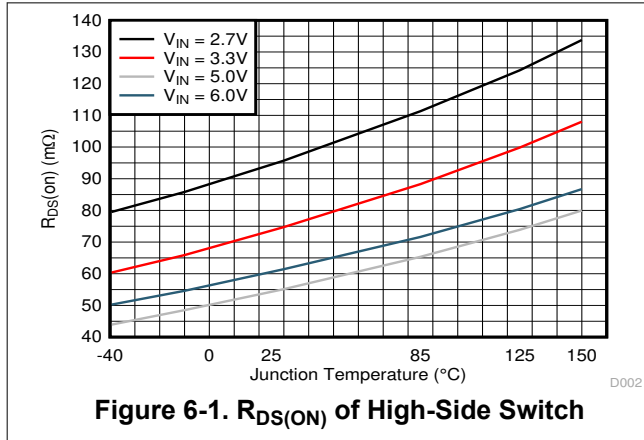

7 Parameter Measurement Information

7.1 Schematic

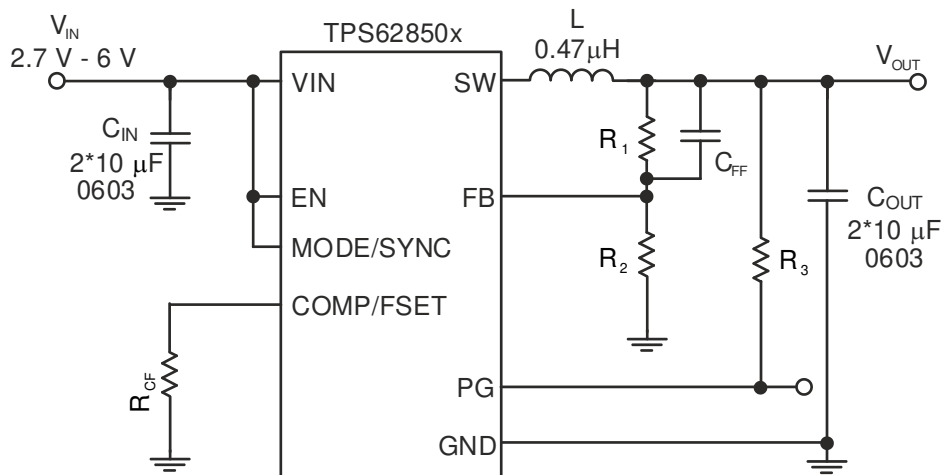

Figure 7-1. Measurement Setup

Table 7-1. List of Components

REFERENCE	DESCRIPTION	MANUFACTURER ⁽¹⁾
IC	TPS628502	Texas Instruments
L	0.47- μ H inductor DFE252012PD	Murata
C _{IN}	2 \times 10 μ F / 6.3 V GRM188D70J106MA73	Murata
C _{OUT}	2 \times 10 μ F / 6.3 V GRM188D70J106MA73 for V _{OUT} \geq 1 V	Murata
C _{OUT}	3 \times 10 μ F / 6.3 V GRM188D70J106MA73 for V _{OUT} < 1 V	Murata
R _{CF}	8.06 k Ω	Any
C _{FF}	10 pF	Any
R ₁	Depending on V _{OUT}	Any
R ₂	Depending on V _{OUT}	Any
R ₃	100 k Ω	Any

(1) See the [Third-party Products Disclaimer](#).

8 Detailed Description

8.1 Overview

The TPS62850x synchronous switch mode power converters are based on a peak current mode control topology. The control loop is internally compensated.

To optimize the bandwidth of the control loop to the wide range of output capacitance that can be used with TPS62850x, the internal compensation has two settings. See [Section 8.3.2](#). One out of the two compensation settings is chosen either by a resistor from COMP/FSET to GND, or by the logic state of this pin. The regulation network achieves fast and stable operation with small external components and low-ESR ceramic output capacitors. The devices can be operated without a feedforward capacitor on the output voltage divider, however, using a typically 10-pF feedforward capacitor improves transient response.

The devices support forced fixed frequency PWM operation with the MODE pin tied to a logic high level. The frequency is defined as either 2.25 MHz internally fixed when COMP/FSET is tied to GND or VIN, or in a range of 1.8 MHz to 4 MHz defined by a resistor from COMP/FSET to GND. Alternatively, the devices can be synchronized to an external clock signal in a range from 1.8 MHz to 4 MHz, applied to the MODE pin with no need for additional passive components. An internal PLL allows the internal clock to be changed to an external clock during operation. The synchronization to the external clock is done on a falling edge of the clock applied at MODE to the rising edge on the SW pin. This allows a roughly 180° phase shift when the SW pin is used to generate the synchronization signal for a second converter. When the MODE pin is set to a logic low level, the device operates in power save mode (PFM) at low output current and automatically transfers to fixed frequency PWM mode at higher output current. In PFM mode, the switching frequency decreases linearly based on the load to sustain high efficiency down to very low output current.

8.2 Functional Block Diagram

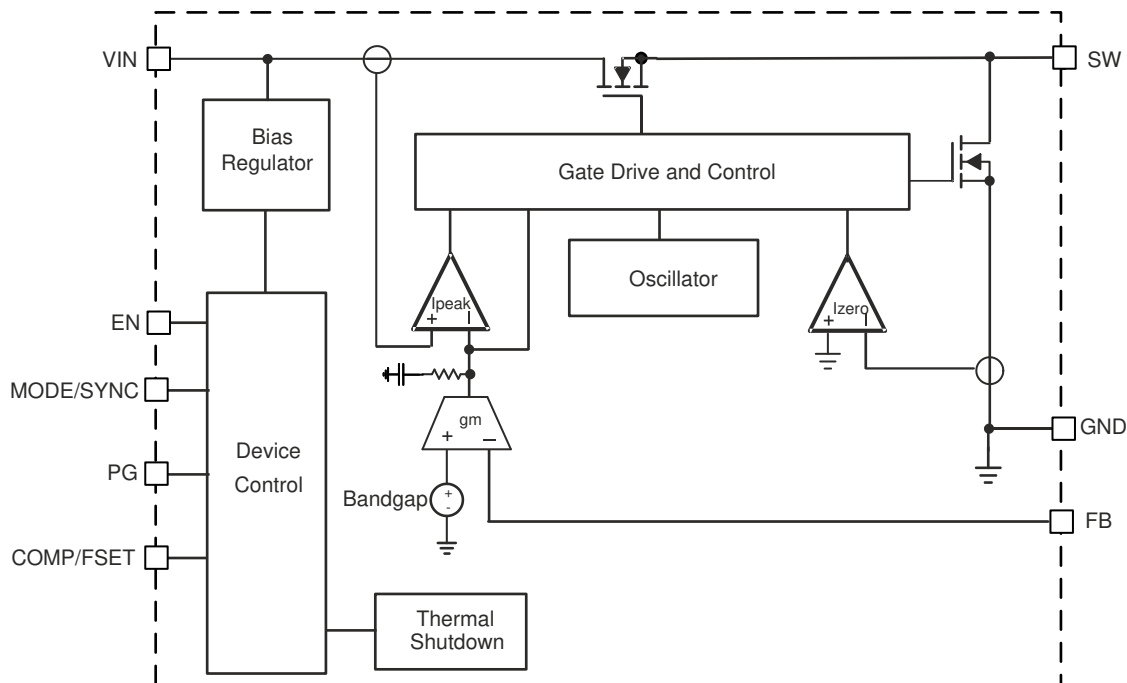

8.3 Feature Description

8.3.1 Precise Enable (EN)

The voltage applied at the enable pin of the TPS62850x is compared to a fixed threshold of 1.1 V for a rising voltage. This allows the user to drive the pin by a slowly changing voltage and enables the use of an external RC network to achieve a power-up delay.

The Precise Enable input provides a user-programmable undervoltage lockout by adding a resistor divider to the input of the Enable pin.

The enable input threshold for a falling edge is typically 100 mV lower than the rising edge threshold. The TPS62850x starts operation when the rising threshold is exceeded. For proper operation, the enable (EN) pin must be terminated and must not be left floating. Pulling the enable pin low forces the device into shutdown, with a shutdown current of typically 1 μ A. In this mode, the internal high-side and low-side MOSFETs are turned off and the entire internal control circuitry is switched off.

8.3.2 COMP/FSET

This pin allows to set three different parameters:

- Internal compensation settings for the control loop (two settings available)
- The switching frequency in PWM mode from 1.8 MHz to 4 MHz
- Enable/disable spread spectrum clocking (SSC)

A resistor from COMP/FSET to GND changes the compensation as well as the switching frequency. The change in compensation allows the user to adopt the device to different values of output capacitance. The resistor must be placed close to the pin to keep the parasitic capacitance on the pin to a minimum. The compensation setting is sampled at start-up of the converter, so a change in the resistor during operation only has an effect on the switching frequency but not on the compensation.

To save external components, the pin can also be directly tied to VIN or GND to set a pre-defined setting. Do not leave the pin floating.

The switching frequency has to be selected based on the input voltage and the output voltage to meet the specifications for the minimum on-time and minimum off-time.

Example: $V_{IN} = 5\text{ V}$, $V_{OUT} = 0.6\text{ V}$ --> duty cycle = $0.6\text{ V} / 5\text{ V} = 0.12$

- --> $t_{on,min} = 1 / f_s \times 0.12$
- --> $f_{sw,max} = 1 / t_{on,min} \times 0.12 = 1 / 0.05\ \mu\text{s} \times 0.12 = 2.4\text{ MHz}$

The compensation range has to be chosen based on the minimum capacitance used. The capacitance can be increased from the minimum value as given in [Table 8-1](#), up to the maximum of 200 μ F in both compensation ranges. If the capacitance of an output changes during operation, for example, when load switches are used to connect or disconnect parts of the circuitry, the compensation has to be chosen for the minimum capacitance on the output. With large output capacitance, the compensation must be done based on that large capacitance to get the best load transient response. Compensating for large output capacitance but placing less capacitance on the output can lead to instability.

The switching frequency for the different compensation setting is determined by the following equations.

For compensation (comp) setting 1 with spread spectrum clocking (SSC) disabled:

$$R_{CF}(k\Omega) = \frac{18\text{MHz} \cdot k\Omega}{f_s(\text{MHz})} \quad (1)$$

For compensation (comp) setting 1 with spread spectrum clocking (SSC) enabled:

$$R_{CF}(k\Omega) = \frac{60\text{MHz} \cdot k\Omega}{f_s(\text{MHz})} \quad (2)$$

For compensation (comp) setting 2 with spread spectrum clocking (SSC) disabled:

$$R_{CF}(k\Omega) = \frac{180\text{MHz} \cdot k\Omega}{f_s(\text{MHz})} \quad (3)$$

Table 8-1. Switching Frequency, Compensation and Spread Spectrum Clocking

R_{CF}	COMPENSATION	SWITCHING FREQUENCY	MINIMUM OUTPUT CAPACITANCE FOR $V_{OUT} < 1\text{ V}$	MINIMUM OUTPUT CAPACITANCE FOR $1\text{ V} \leq V_{OUT} < 3.3\text{ V}$	MINIMUM OUTPUT CAPACITANCE FOR $V_{OUT} \geq 3.3\text{ V}$
10 k Ω .. 4.5 k Ω	for smallest output capacitance (comp setting 1) SSC disabled	1.8 MHz (10 k Ω) .. 4 MHz (4.5 k Ω) according to Equation 1	15 μF	10 μF	8 μF
33 k Ω .. 15 k Ω	for smallest output capacitance (comp setting 1) SSC enabled	1.8 MHz (33 k Ω) .. 4 MHz (15 k Ω) according to Equation 2	15 μF	10 μF	8 μF
100 k Ω .. 45 k Ω	for best transient response (larger output capacitance) (comp setting 2) SSC disabled	1.8 MHz (100 k Ω) ..4 MHz (45 k Ω) according to Equation 3	30 μF	18 μF	15 μF
tied to GND	for smallest output capacitance (comp setting 1) SSC disabled	internally fixed 2.25 MHz	15 μF	10 μF	8 μF
tied to V_{IN}	for best transient response (larger output capacitance) (comp setting 2) SSC enabled	internally fixed 2.25 MHz	30 μF	18 μF	15 μF

Refer to [Section 9.1.3.2](#) for further details on the output capacitance required depending on the output voltage.

A resistor value that is too high for R_{CF} is decoded as "tied to V_{IN} ". A value below the lowest range is decoded as "tied to GND". The minimum output capacitance in [Table 8-1](#) is for capacitors close to the output of the device. If the capacitance is distributed, a lower compensation setting can be required.

8.3.3 MODE / SYNC

When MODE/SYNC is set low, the device operates in PWM or PFM mode, depending on the output current. The MODE/SYNC pin allows you to force PWM mode when set high. The pin also allows you to apply an external clock in a frequency range from 1.8 MHz to 4 MHz for external synchronization. The specifications for the minimum on-time and minimum off-time must be observed when setting the external frequency. For use with external synchronization on the MODE/SYNC pin, the internal switching frequency must be set by R_{CF} to a similar value to the externally applied clock. This ensures that if the external clock fails, the switching frequency stays in the same range and the compensation settings are still valid.

8.3.4 Spread Spectrum Clocking (SSC)

The device offers spread spectrum clocking as an option. When SSC is enabled, the switching frequency is randomly changed in PWM mode when the internal clock is used. The frequency variation is typically between the nominal switching frequency and up to 288 kHz above the nominal switching frequency. When the device is externally synchronized by applying a clock signal to the MODE/SYNC pin, the TPS62850x follows the external clock and the internal spread spectrum block is turned off. SSC is also disabled during soft start.

8.3.5 Undervoltage Lockout (UVLO)

If the input voltage drops, the undervoltage lockout prevents misoperation of the device by switching off both the power FETs. When enabled, the device is fully operational for input voltages above the rising UVLO threshold and turns off if the input voltage trips below the threshold for a falling supply voltage.

8.3.6 Power Good Output (PG)

Power good is an open-drain output that requires a pullup resistor to any voltage up to the recommended input voltage level. It is driven by a window comparator. PG is held low when the device is disabled, in undervoltage lockout in thermal shutdown, and not in soft start. When the output voltage is in regulation hence, within the window defined in the electrical characteristics, the output is high impedance.

V_{IN} must remain present for the PG pin to stay low. If the power good output is not used, TI recommends to tie it to GND or leave open. The PG indicator features a de-glitch, as specified in the electrical characteristics, for the transition from "high impedance" to "low" of the output.

Table 8-2. PG Status

EN	DEVICE STATUS	PG STATE
X	$V_{IN} < 2\text{ V}$	undefined
low	$V_{IN} \geq 2\text{ V}$	low
high	$2\text{ V} \leq V_{IN} \leq \text{UVLO}$ OR in thermal shutdown OR V_{OUT} not in regulation OR device in soft start	low
high	V_{OUT} in regulation	high impedance

8.3.7 Thermal Shutdown

The junction temperature (T_J) of the device is monitored by an internal temperature sensor. If T_J exceeds 170°C (typ), the device goes into thermal shutdown. Both the high-side and low-side power FETs are turned off and PG goes low. When T_J decreases below the hysteresis amount of typically 15°C , the converter resumes normal operation, beginning with soft start. During a PFM pause, the thermal shutdown is not active. After a PFM pause, the device needs up to $9\ \mu\text{s}$ to detect a junction temperature that is too high. If the PFM burst is shorter than this delay, the device does not detect a junction temperature that is too high.

8.4 Device Functional Modes

8.4.1 Pulse Width Modulation (PWM) Operation

The TPS62850x has two operating modes: forced PWM mode is discussed in this section and PWM/PFM as discussed in [Section 8.4.2](#).

With the MODE/SYNC pin set to high, the TPS62850x operates with pulse width modulation in continuous conduction mode (CCM). The switching frequency is either defined by a resistor from the COMP pin to GND or by an external clock signal applied to the MODE/SYNC pin. With an external clock applied to MODE/SYNC, the TPS62850x follows the frequency applied to the pin. In general, the frequency range in forced PWM mode is 1.8 MHz to 4 MHz. However, the frequency needs to be in a range the TPS62850x can operate at, taking the minimum on-time into account.

8.4.2 Power Save Mode Operation (PWM/PFM)

When the MODE/SYNC pin is low, power save mode is allowed. The device operates in PWM mode as long as the peak inductor current is above the PFM threshold of approximately 0.8 A. When the peak inductor current drops below the PFM threshold, the device starts to skip switching pulses. In power save mode, the switching frequency decreases with the load current maintaining high efficiency. In addition, the frequency set with the resistor on COMP/FSET must be in a range of 1.8 MHz to 3.5 MHz.

8.4.3 100% Duty-Cycle Operation

The duty cycle of a buck converter operated in PWM mode is given as $D = V_{OUT} / V_{IN}$. The duty cycle increases as the input voltage comes close to the output voltage and the off-time gets smaller. When the minimum off-time of typically 10 ns is reached, the TPS62850x skips switching cycles while it approaches 100% mode. In 100% mode, it keeps the high-side switch on continuously. The high-side switch stays turned on as long as the output voltage is below the target. In 100% mode, the low-side switch is turned off. The maximum dropout voltage in 100% mode is the product of the on-resistance of the high-side switch plus the series resistance of the inductor and the load current.

8.4.4 Current Limit and Short Circuit Protection

The TPS62850x is protected against overload and short circuit events. If the inductor current exceeds the current limit I_{LIMH} , the high-side switch is turned off and the low-side switch is turned on to ramp down the inductor current. The high-side switch turns on again only if the current in the low side-switch has decreased below the low side current limit. Due to internal propagation delay, the actual current can exceed the static current limit. The dynamic current limit is given as:

$$I_{peak(typ)} = I_{LIMH} + \frac{V_L}{L} \cdot t_{PD} \quad (4)$$

where

- I_{LIMH} is the static current limit as specified in the *Electrical Characteristics*
- L is the effective inductance at the peak current
- V_L is the voltage across the inductor ($V_{IN} - V_{OUT}$)
- t_{PD} is the internal propagation delay of typically 50 ns

The current limit can exceed static values, especially if the input voltage is high and very small inductances are used. The dynamic high-side switch peak current can be calculated as follows:

$$I_{peak(typ)} = I_{LIMH} + \frac{V_{IN} - V_{OUT}}{L} \cdot 50ns \quad (5)$$

8.4.5 Foldback Current Limit and Short Circuit Protection

This is valid for devices where foldback current limit is enabled. Contact Texas Instruments for more information on this option.

When the device detects current limit for more than 1024 subsequent switching cycles, it reduces the current limit from the nominal value to typically 1.3 A. Foldback current limit is left when the current limit indication goes away. If device operation continues in current limit, after 3072 switching cycles, it tries for full current limit for 1024 switching cycles.

8.4.6 Output Discharge

The purpose of the discharge function is to ensure a defined down-ramp of the output voltage when the device is being disabled and to keep the output voltage close to 0 V when the device is off. The output discharge feature is only active once the TPS62850x has been enabled at least once since the supply voltage was applied. The discharge function is enabled as soon as the device is disabled, in thermal shutdown, or in undervoltage lockout. The minimum supply voltage required for the discharge function to remain active is typically 2 V. Output discharge is not activated during a current limit or foldback current limit event.

8.4.7 Soft Start

The internal soft-start circuitry controls the output voltage slope during start-up. This avoids excessive inrush current and ensures a controlled output voltage rise time. It also prevents unwanted voltage drops from high impedance power sources or batteries. When EN is set high to start operation, the device starts switching after a delay of about 200 μ s then the internal reference and hence V_{OUT} rises with a slope defined by an internally defined slope of 150 μ s or 1 ms (OTP option).

8.4.8 Input Overvoltage Protection

When the input voltage exceeds the absolute maximum rating, the device is set to PFM mode so it cannot transfer energy from the output to the input.

9 Application and Implementation

Note

Information in the following applications sections is not part of the TI component specification, and TI does not warrant its accuracy or completeness. TI's customers are responsible for determining suitability of components for their purposes. Customers should validate and test their design implementation to confirm system functionality.

9.1 Application Information

9.1.1 Programming the Output Voltage

The output voltage of the TPS62850x is adjustable. It can be programmed for output voltages from 0.6 V to 5.5 V using a resistor divider from V_{OUT} to GND. The voltage at the FB pin is regulated to 600 mV. The value of the output voltage is set by the selection of the resistor divider from [Equation 6](#). TI recommends to choose resistor values that allow a current of at least 2 μ A, meaning the value of R_2 must not exceed 400 k Ω . Lower resistor values are recommended for highest accuracy and the most robust design.

$$R_1 = R_2 \cdot \left(\frac{V_{OUT}}{V_{FB}} - 1 \right) \quad (6)$$

9.1.2 Inductor Selection

The TPS62850x family is designed for a nominal 0.47- μ H inductor with a switching frequency of typically 2.25 MHz. Larger values can be used to achieve a lower inductor current ripple but they can have a negative impact on efficiency and transient response. Smaller values than 0.47 μ H cause a larger inductor current ripple, which causes larger negative inductor current in forced PWM mode at low or no output current. For a higher or lower nominal switching frequency, the inductance must be changed accordingly. See [Section 6.3](#) for details.

The inductor selection is affected by several effects like inductor ripple current, output ripple voltage, PWM-to-PFM transition point, and efficiency. In addition, the inductor selected has to be rated for appropriate saturation current and DC resistance (DCR). [Equation 7](#) calculates the maximum inductor current.

$$I_{L(max)} = I_{OUT(max)} + \frac{\Delta I_{L(max)}}{2} \quad (7)$$

$$\Delta I_{L(max)} = \frac{V_{OUT} \cdot \left(1 - \frac{V_{OUT}}{V_{IN}} \right)}{L \min} \cdot \frac{1}{f_{sw}} \quad (8)$$

where

- $I_{L(max)}$ is the maximum inductor current
- $\Delta I_{L(max)}$ is the peak-to-peak inductor ripple current
- $L \min$ is the minimum inductance at the operating point

Table 9-1. Typical Inductors

TYPE	INDUCTANCE [μ H]	CURRENT [A] (1)	FOR DEVICE	NOMINAL SWITCHING FREQUENCY	DIMENSIONS [LxBxH] mm	MANUFACTURER(2)
XFL4015-471ME	0.47 μ H, \pm 20%	3.5	TPS628501 / 502	2.25 MHz	4 × 4 × 1.6	Coilcraft
XFL4015-701ME	0.70 μ H, \pm 20%	3.3	TPS628501 / 502	2.25 MHz	4 × 4 × 1.6	Coilcraft
XEL3520-801ME	0.80 μ H, \pm 20%	2.0	TPS628501 / 502	2.25 MHz	3.5 × 3.2 × 2.0	Coilcraft
XEL3515-561ME	0.56 μ H, \pm 20%	4.5	TPS628501 / 502	2.25 MHz	3.5 × 3.2 × 1.5	Coilcraft
XFL3012-681ME	0.68 μ H, \pm 20%	2.1	TPS628501 / 502	2.25 MHz	3.0 × 3.0 × 1.2	Coilcraft
XPL2010-681ML	0.68 μ H, \pm 20%	1.5	TPS628501	2.25 MHz	2 × 1.9 × 1	Coilcraft
DFE252012PD-R68M	0.68 μ H, \pm 20%	see data sheet	TPS628501 / 502	2.25 MHz	2.5 × 2 × 1.2	Murata
DFE252012PD-R47M	0.47 μ H, \pm 20%	see data sheet	TPS628501 / 502	2.25 MHz	2.5 × 2 × 1.2	Murata
DFE201612PD-R68M	0.68 μ H, \pm 20%	see data sheet	TPS628501 / 502	2.25 MHz	2 × 1.6 × 1.2	Murata
DFE201612PD-R47M	0.47 μ H, \pm 20%	see data sheet	TPS628501 / 502	2.25 MHz	2 × 1.6 × 1.2	Murata

(1) Lower of I_{RMS} at 20°C rise or I_{SAT} at 20% drop.

(2) See the [Third-party Products Disclaimer](#).

Calculating the maximum inductor current using the actual operating conditions gives the minimum saturation current of the inductor needed. A margin of about 20% is recommended to add. A larger inductor value is also useful to get lower ripple current, but increases the transient response time and size as well.

9.1.3 Capacitor Selection

9.1.3.1 Input Capacitor

For most applications, 10- μ F nominal is sufficient and is recommended. The input capacitor buffers the input voltage for transient events and also decouples the converter from the supply. A low-ESR multilayer ceramic capacitor (MLCC) is recommended for the best filtering and must be placed between V_{IN} and GND as close as possible to those pins.

9.1.3.2 Output Capacitor

The architecture of the TPS62850x allows the use of tiny ceramic output capacitors with low equivalent series resistance (ESR). These capacitors provide low output voltage ripple and are recommended. To keep the low resistance up to high frequencies and to get narrow capacitance variation with temperature, TI recommends to use X7R or X5R dielectric. Using a higher value has advantages, like smaller voltage ripple and a tighter DC output accuracy in power save mode.

The COMP/FSET pin allows the user to select two different compensation settings based on the minimum capacitance used on the output. The maximum capacitance is 200 μ F in any of the compensation settings. The minimum capacitance required on the output depends on the compensation setting and output voltage.

For output voltages below 1 V, the minimum increases linearly from 10 μ F at 1 V to 15 μ F at 0.6 V with the compensation setting for smallest output capacitance. Other compensation ranges are equivalent. See [Table 8-1](#) for details.

9.2 Typical Application

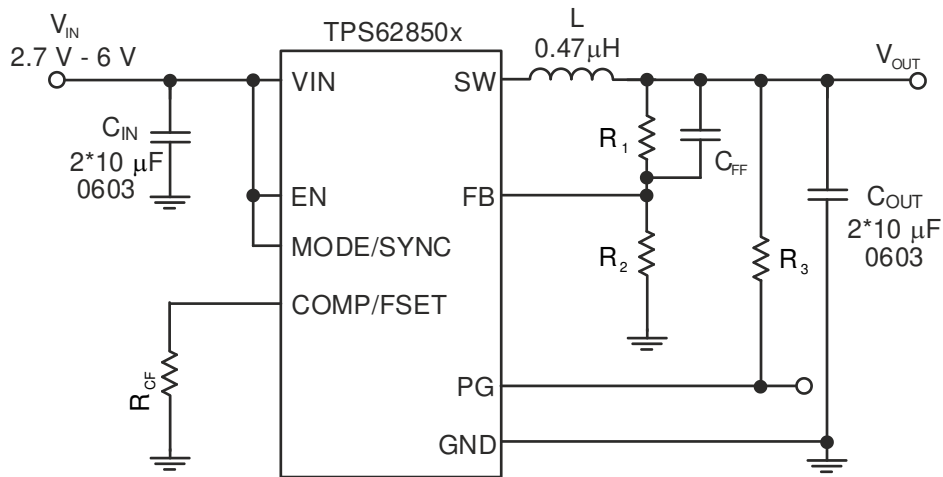

Figure 9-1. Typical Application

9.2.1 Design Requirements

The design guidelines provide a component selection to operate the device within the recommended operating conditions.

9.2.2 Detailed Design Procedure

$$R_1 = R_2 \cdot \left(\frac{V_{OUT}}{V_{FB}} - 1 \right) \quad (9)$$

With $V_{FB} = 0.6 \text{ V}$:

Table 9-2. Setting the Output Voltage

NOMINAL OUTPUT VOLTAGE V_{OUT}	R_1	R_2	C_{FF}	EXACT OUTPUT VOLTAGE
0.8 V	16.9 k Ω	51 k Ω	10 pF	0.7988 V
1.0 V	20 k Ω	30 k Ω	10 pF	1.0 V
1.1 V	39.2 k Ω	47 k Ω	10 pF	1.101 V
1.2 V	68 k Ω	68 k Ω	10 pF	1.2 V
1.5 V	76.8 k Ω	51 k Ω	10 pF	1.5 V
1.8 V	80.6 k Ω	40.2 k Ω	10 pF	1.803 V
2.5 V	47.5 k Ω	15 k Ω	10 pF	2.5 V
3.3 V	88.7 k Ω	19.6 k Ω	10 pF	3.315 V

9.2.3 Application Curves

All plots have been taken with a nominal switching frequency of 2.25 MHz when set to PWM mode, unless otherwise noted. The BOM is according to [Table 7-1](#).

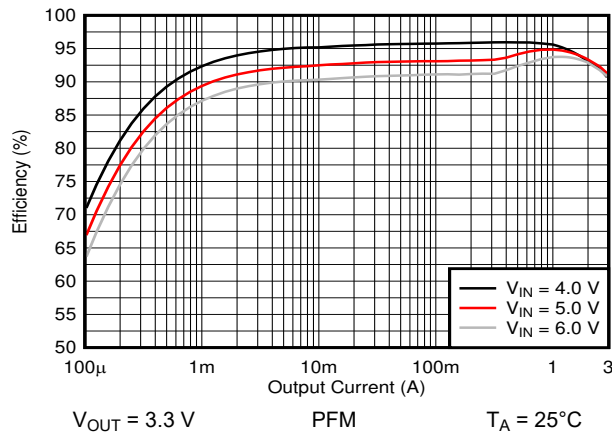

Figure 9-2. Efficiency Versus Output Current

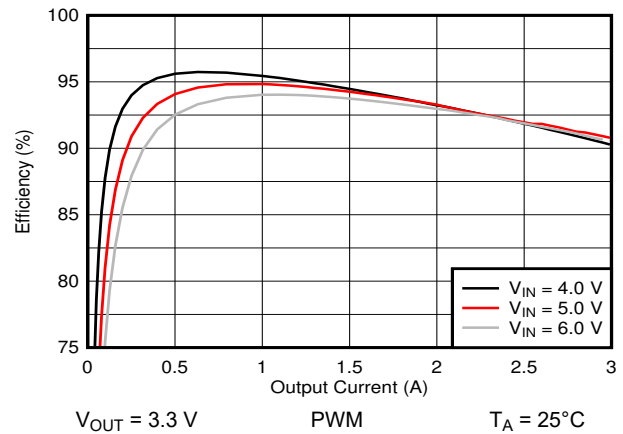

Figure 9-3. Efficiency Versus Output Current

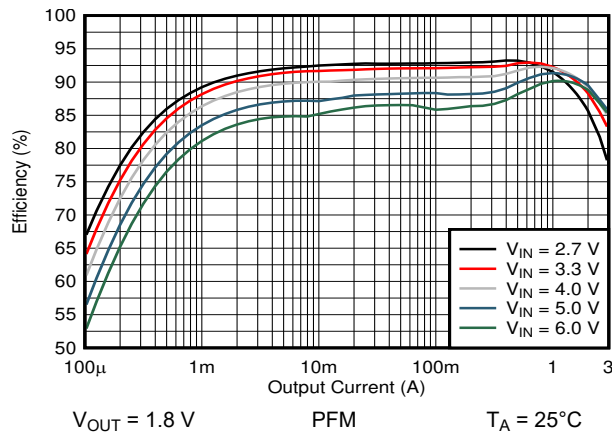

Figure 9-4. Efficiency Versus Output Current

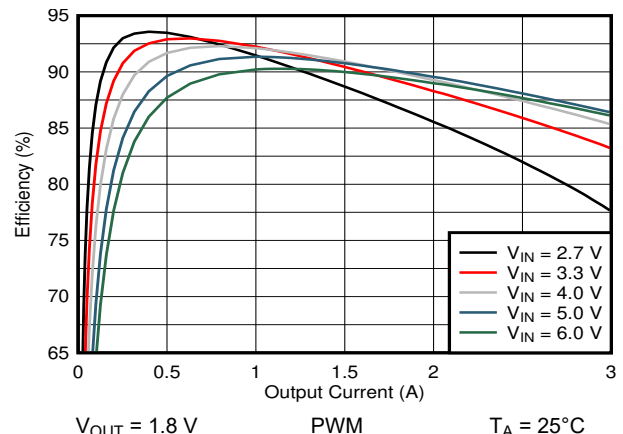

Figure 9-5. Efficiency Versus Output Current

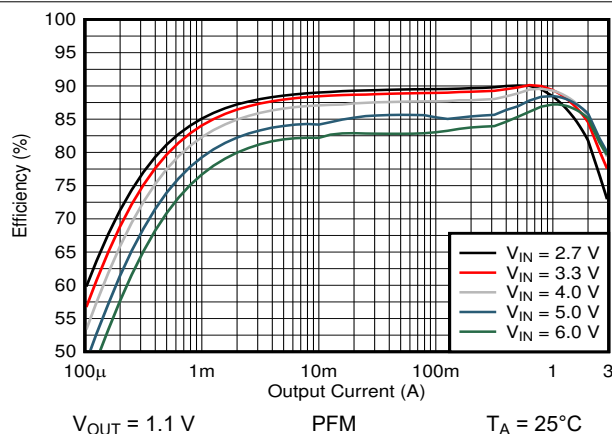

Figure 9-6. Efficiency Versus Output Current

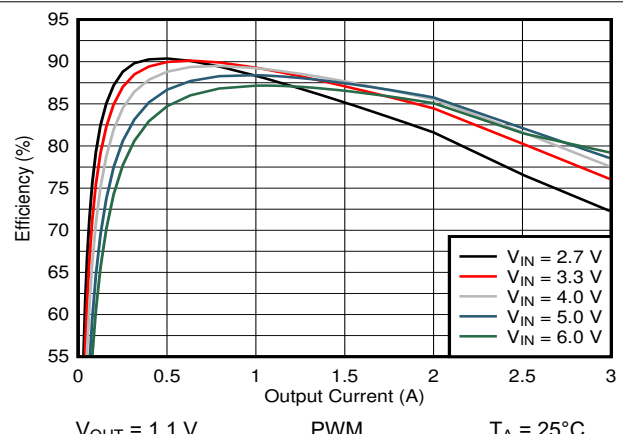

Figure 9-7. Efficiency Versus Output Current

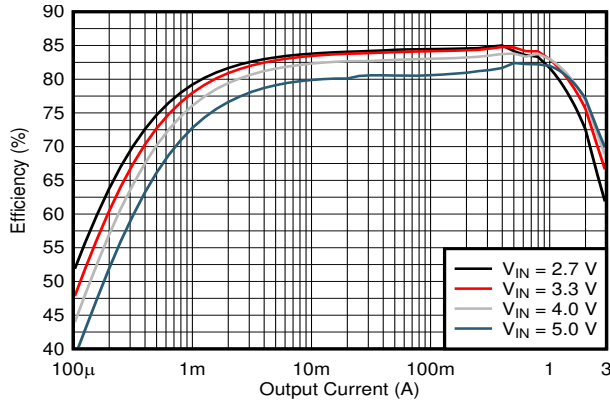

Figure 9-8. Efficiency Versus Output Current

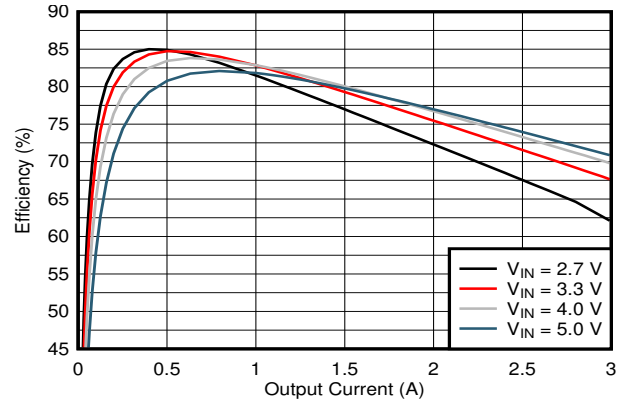

Figure 9-9. Efficiency Versus Output Current

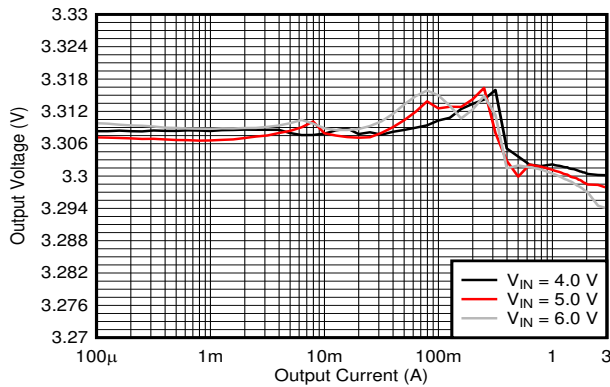

Figure 9-10. Output Voltage Versus Output Current

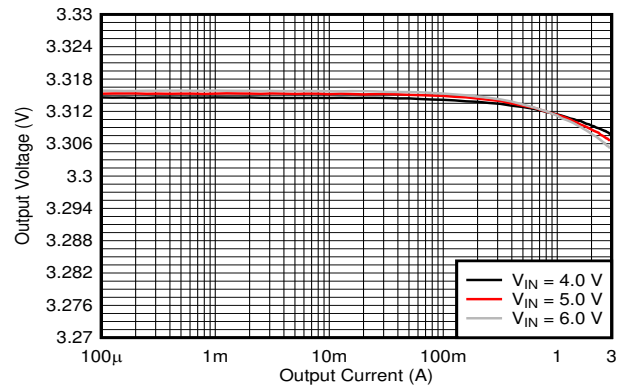

Figure 9-11. Output Voltage Versus Output Current

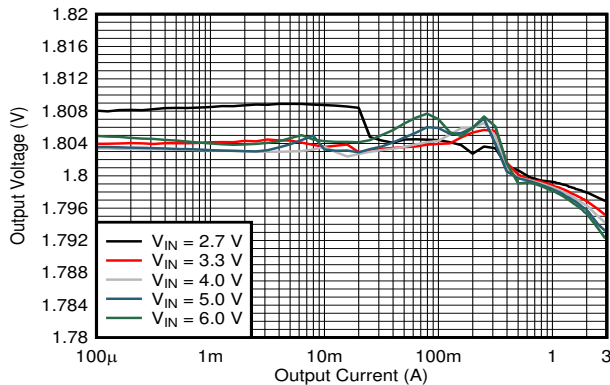

Figure 9-12. Output Voltage Versus Output Current

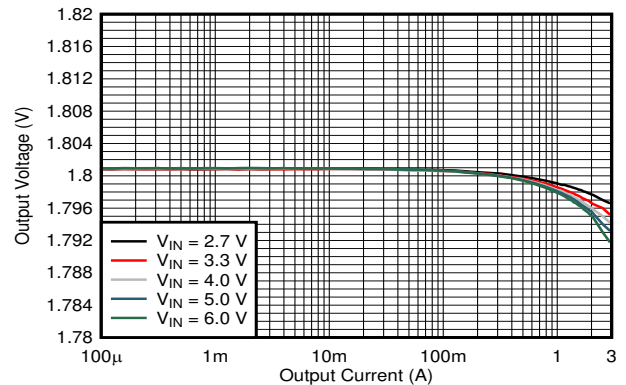

Figure 9-13. Output Voltage Versus Output Current

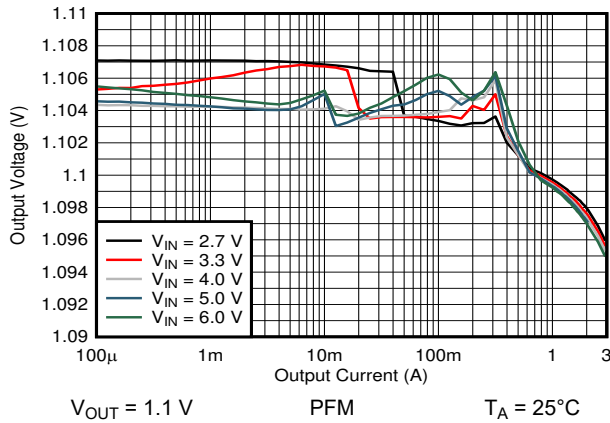

Figure 9-14. Output Voltage Versus Output Current

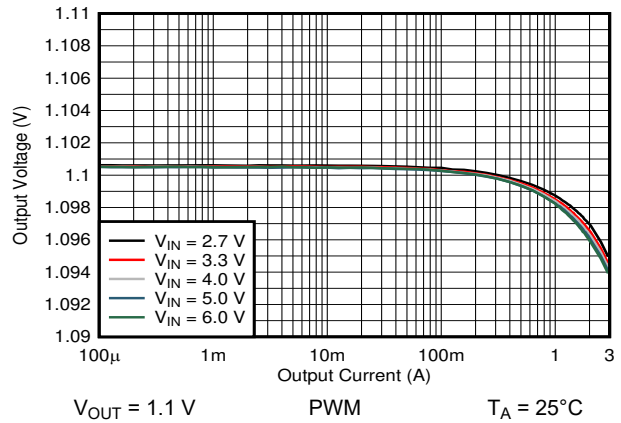

Figure 9-15. Output Voltage Versus Output Current

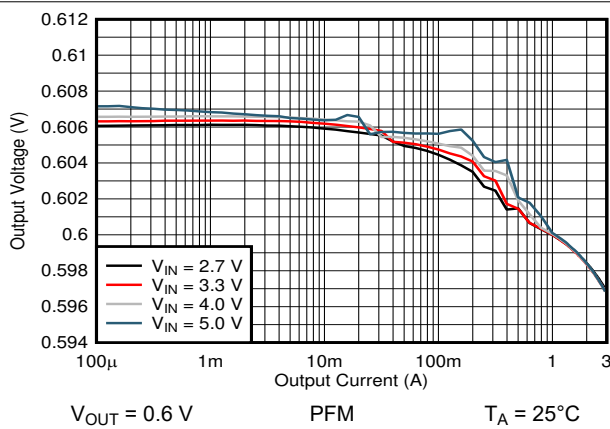

Figure 9-16. Output Voltage Versus Output Current

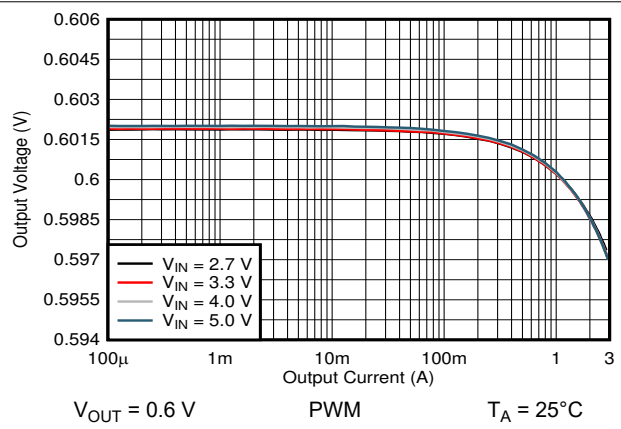

Figure 9-17. Output Voltage Versus Output Current

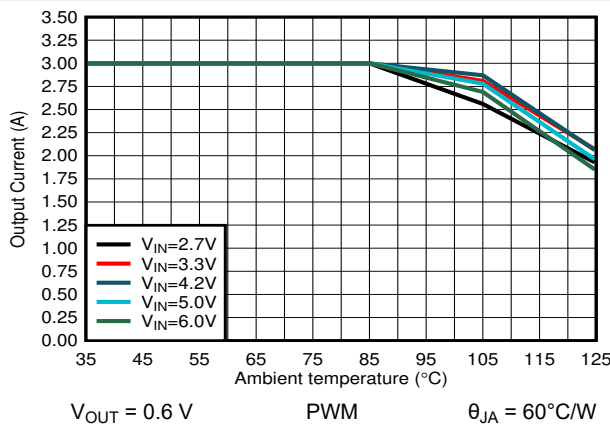

Figure 9-18. Output Current Versus Ambient Temperature

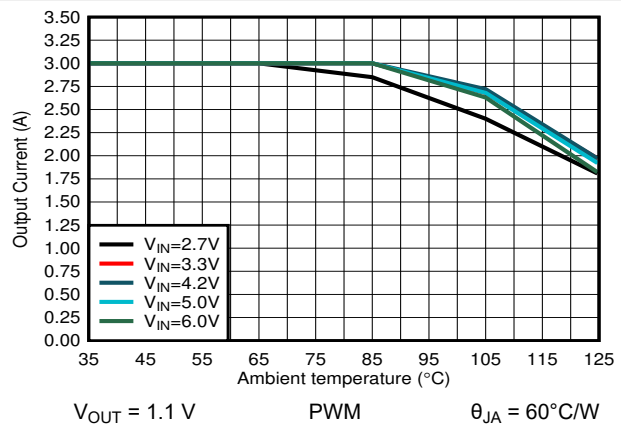

Figure 9-19. Output Current Versus Ambient Temperature

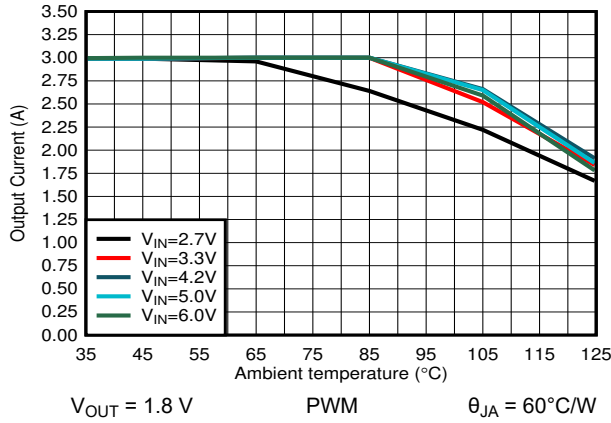

Figure 9-20. Output Current Versus Ambient Temperature

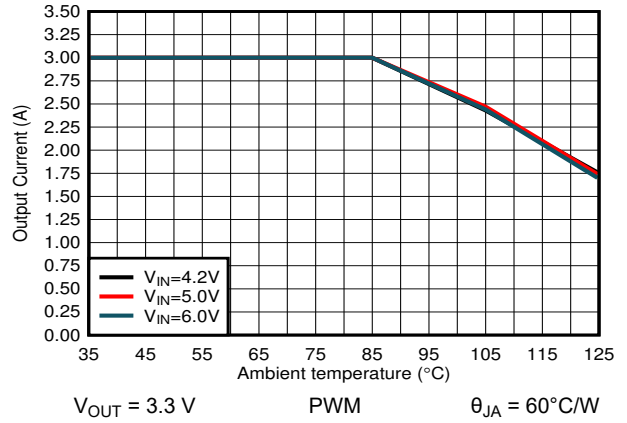

Figure 9-21. Output Current Versus Ambient Temperature

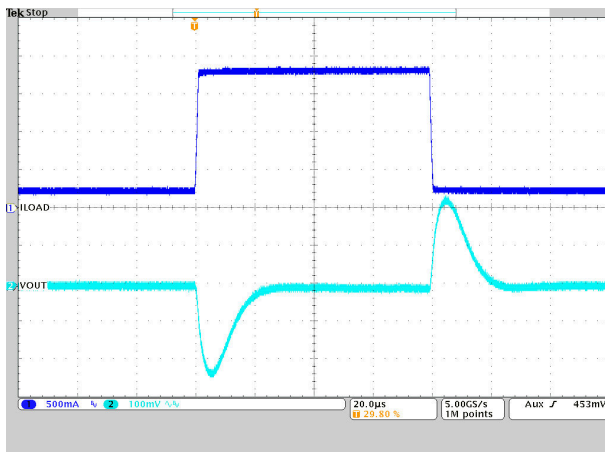

Figure 9-22. Load Transient Response

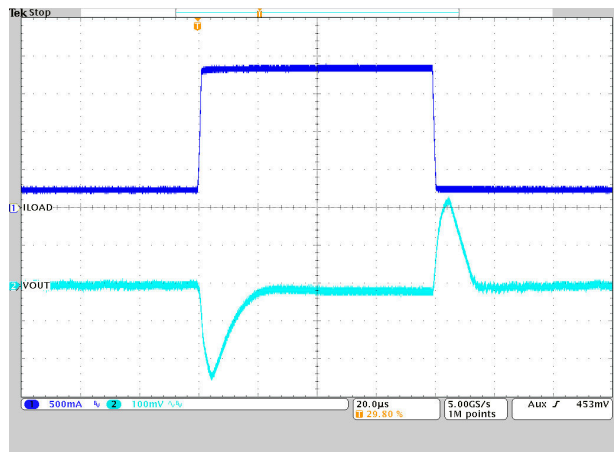

Figure 9-23. Load Transient Response

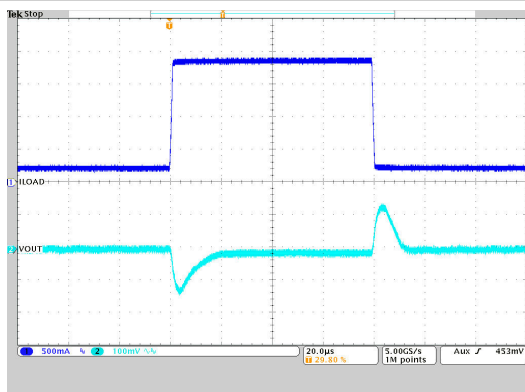

Figure 9-24. Load Transient Response

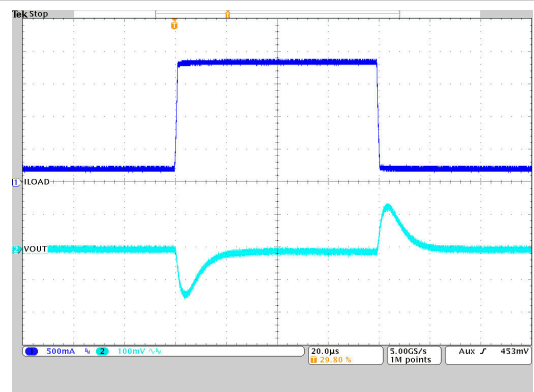
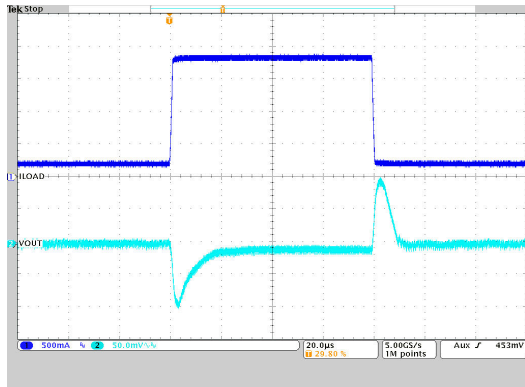
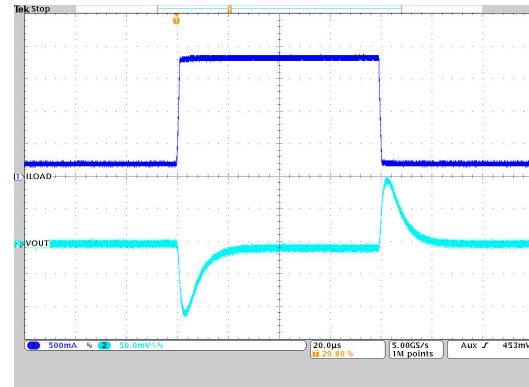

Figure 9-25. Load Transient Response



$V_{OUT} = 1.2\text{ V}$ PFM $T_A = 25^\circ\text{C}$
 $V_{IN} = 5.0\text{ V}$ $I_{OUT} = 0.2\text{ A to } 1.8\text{ A to } 0.2\text{ A}$

Figure 9-26. Load Transient Response



$V_{OUT} = 1.2\text{ V}$ PWM $T_A = 25^\circ\text{C}$
 $V_{IN} = 5.0\text{ V}$ $I_{OUT} = 0.2\text{ A to } 1.8\text{ A to } 0.2\text{ A}$

Figure 9-27. Load Transient Response

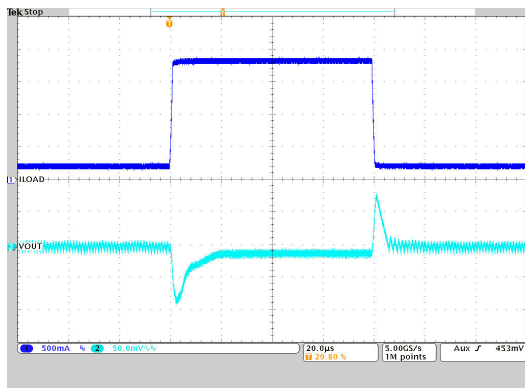

$V_{OUT} = 1.0\text{ V}$ PFM $T_A = 25^\circ\text{C}$
 $V_{IN} = 5.0\text{ V}$ $I_{OUT} = 0.2\text{ A to } 1.8\text{ A to } 0.2\text{ A}$

Figure 9-28. Load Transient Response

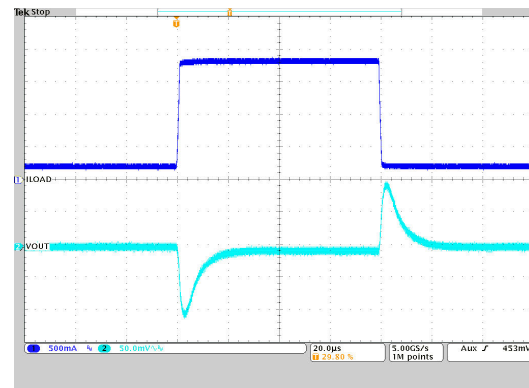

$V_{OUT} = 1.0\text{ V}$ PWM $T_A = 25^\circ\text{C}$
 $V_{IN} = 5.0\text{ V}$ $I_{OUT} = 0.2\text{ A to } 1.8\text{ A to } 0.2\text{ A}$

Figure 9-29. Load Transient Response

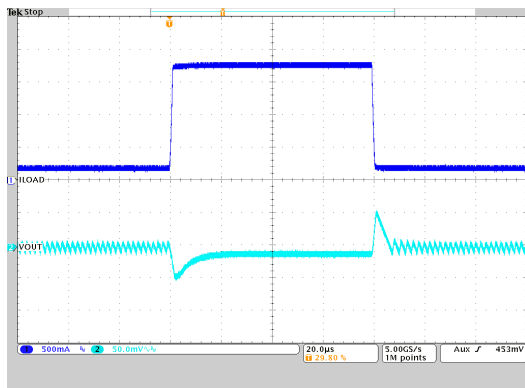

$V_{OUT} = 0.6\text{ V}$ PFM $T_A = 25^\circ\text{C}$
 $V_{IN} = 3.3\text{ V}$ $I_{OUT} = 0.2\text{ A to } 1.8\text{ A to } 0.2\text{ A}$

Figure 9-30. Load Transient Response

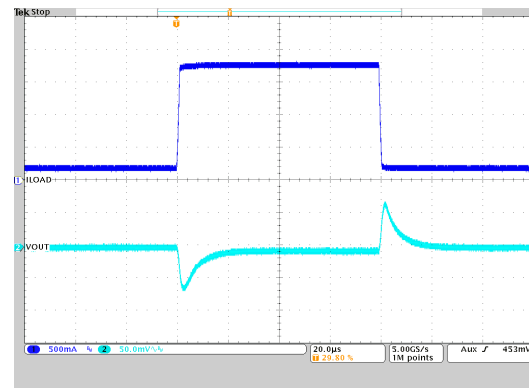

$V_{OUT} = 0.6\text{ V}$ PWM $T_A = 25^\circ\text{C}$
 $V_{IN} = 3.3\text{ V}$ $I_{OUT} = 0.2\text{ A to } 1.8\text{ A to } 0.2\text{ A}$

Figure 9-31. Load Transient Response

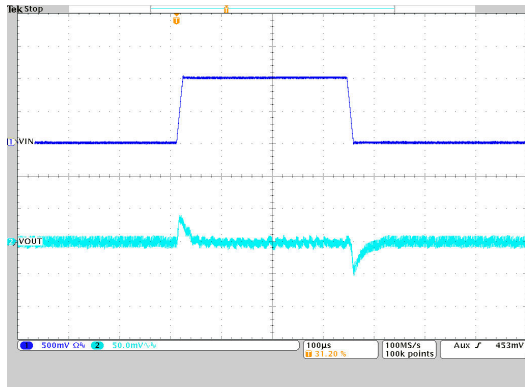

$V_{OUT} = 3.3\text{ V}$ PFM $T_A = 25^\circ\text{C}$
 $I_{OUT} = 0.2\text{ A}$ $V_{IN} = 4.5\text{ V to } 5.5\text{ V to } 4.5\text{ V}$

Figure 9-32. Line Transient Response

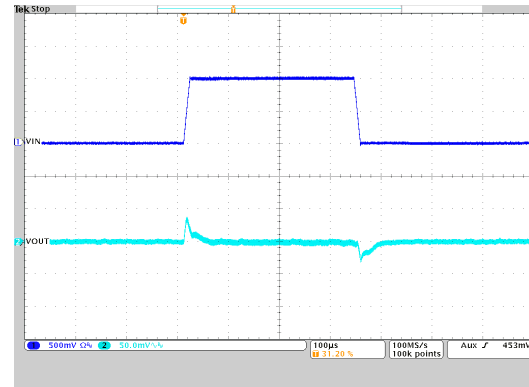

$V_{OUT} = 3.3\text{ V}$ PWM $T_A = 25^\circ\text{C}$
 $I_{OUT} = 2\text{ A}$ $V_{IN} = 4.5\text{ V to } 5.5\text{ V to } 4.5\text{ V}$

Figure 9-33. Line Transient Response

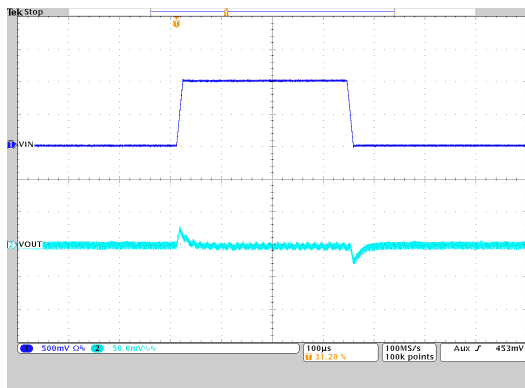

$V_{OUT} = 1.8\text{ V}$ PFM $T_A = 25^\circ\text{C}$
 $I_{OUT} = 0.2\text{ A}$ $V_{IN} = 4.5\text{ V to } 5.5\text{ V to } 4.5\text{ V}$

Figure 9-34. Line Transient Response

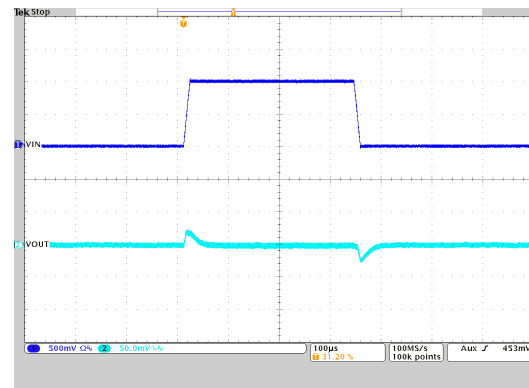

$V_{OUT} = 1.8\text{ V}$ PWM $T_A = 25^\circ\text{C}$
 $I_{OUT} = 2\text{ A}$ $V_{IN} = 4.5\text{ V to } 5.5\text{ V to } 4.5\text{ V}$

Figure 9-35. Line Transient Response

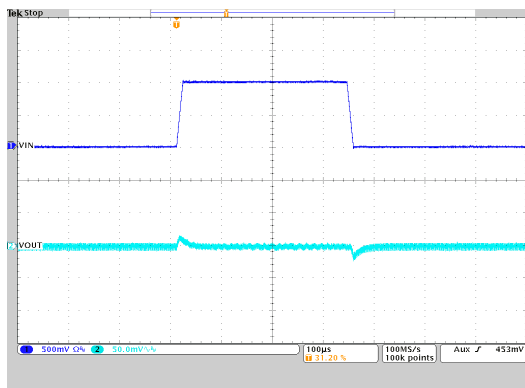

$V_{OUT} = 1.2\text{ V}$ PFM $T_A = 25^\circ\text{C}$
 $I_{OUT} = 0.2\text{ A}$ $V_{IN} = 4.5\text{ V to } 5.5\text{ V to } 4.5\text{ V}$

Figure 9-36. Line Transient Response

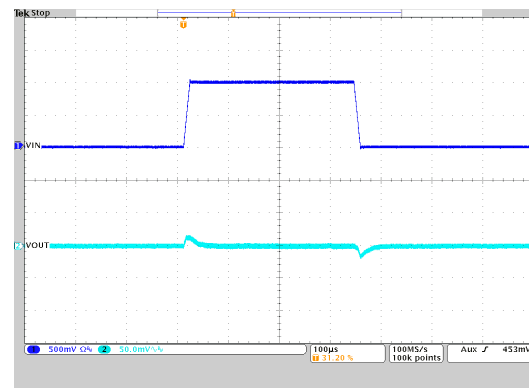

$V_{OUT} = 1.2\text{ V}$ PWM $T_A = 25^\circ\text{C}$
 $I_{OUT} = 2\text{ A}$ $V_{IN} = 4.5\text{ V to } 5.5\text{ V to } 4.5\text{ V}$

Figure 9-37. Line Transient Response

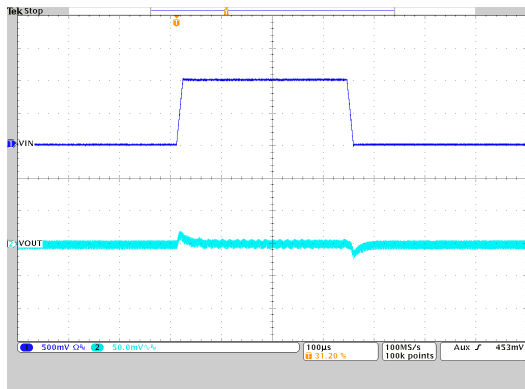

$V_{OUT} = 1.0\text{ V}$ PFM $T_A = 25^\circ\text{C}$
 $I_{OUT} = 0.2\text{ A}$ $V_{IN} = 4.5\text{ V to } 5.5\text{ V to } 4.5\text{ V}$

Figure 9-38. Line Transient Response

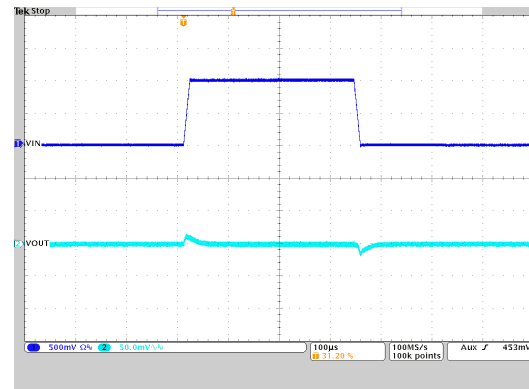

$V_{OUT} = 1.0\text{ V}$ PWM $T_A = 25^\circ\text{C}$
 $I_{OUT} = 2\text{ A}$ $V_{IN} = 4.5\text{ V to } 5.5\text{ V to } 4.5\text{ V}$

Figure 9-39. Line Transient Response

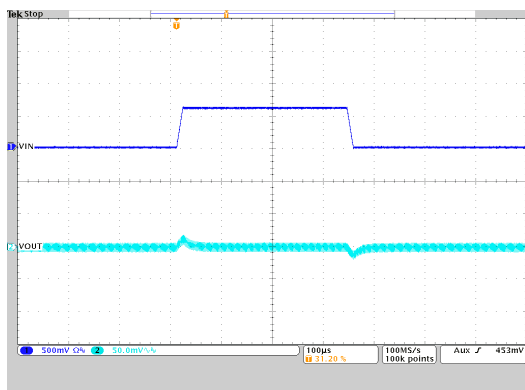

$V_{OUT} = 0.6\text{ V}$ PFM $T_A = 25^\circ\text{C}$
 $I_{OUT} = 0.2\text{ A}$ $V_{IN} = 3.0\text{ V to } 3.6\text{ V to } 3.0\text{ V}$

Figure 9-40. Line Transient Response

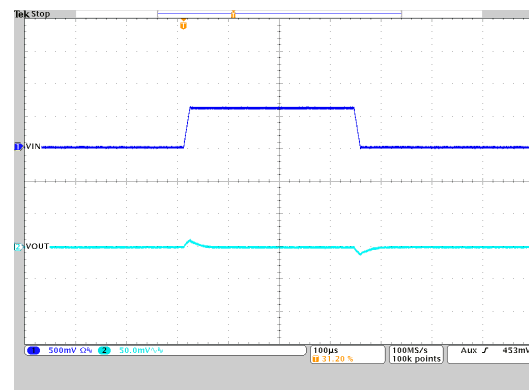

$V_{OUT} = 0.6\text{ V}$ PWM $T_A = 25^\circ\text{C}$
 $I_{OUT} = 2\text{ A}$ $V_{IN} = 3.0\text{ V to } 3.6\text{ V to } 3.0\text{ V}$

Figure 9-41. Line Transient Response

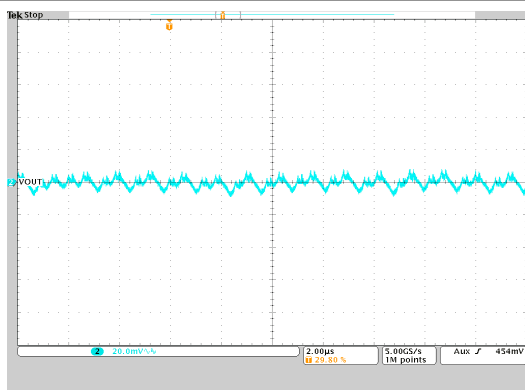

$V_{OUT} = 3.3\text{ V}$ PFM $T_A = 25^\circ\text{C}$
 $V_{IN} = 5\text{ V}$ $I_{OUT} = 0.2\text{ A}$

Figure 9-42. Output Voltage Ripple

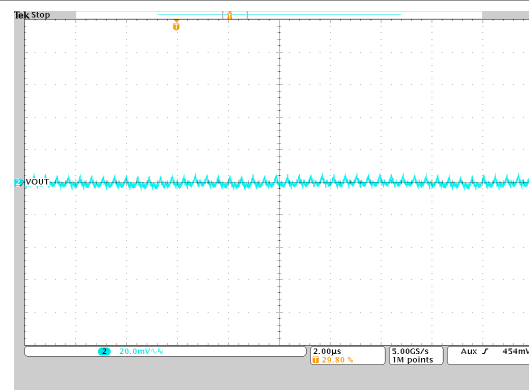

$V_{OUT} = 3.3\text{ V}$ PWM $T_A = 25^\circ\text{C}$
 $V_{IN} = 5\text{ V}$ $I_{OUT} = 2\text{ A}$

Figure 9-43. Output Voltage Ripple

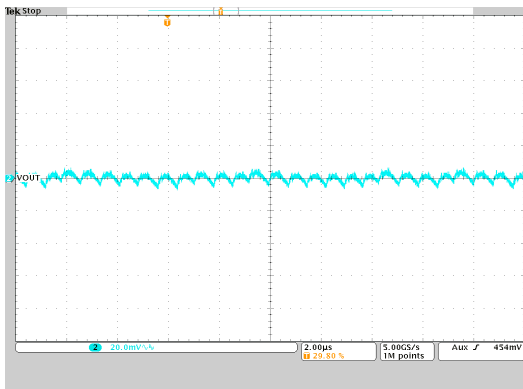

$V_{OUT} = 1.8\text{ V}$ PFM $T_A = 25^\circ\text{C}$
 $V_{IN} = 5\text{ V}$ $I_{OUT} = 0.2\text{ A}$

Figure 9-44. Output Voltage Ripple

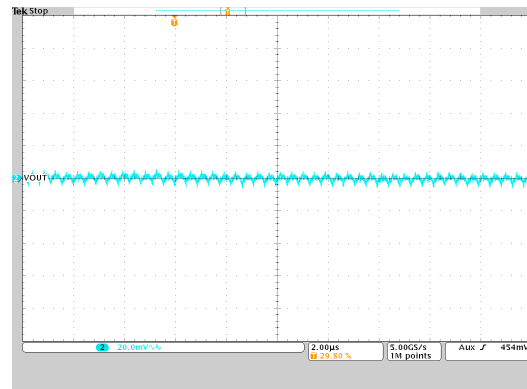

$V_{OUT} = 1.8\text{ V}$ PWM $T_A = 25^\circ\text{C}$
 $V_{IN} = 5\text{ V}$ $I_{OUT} = 2\text{ A}$

Figure 9-45. Output Voltage Ripple

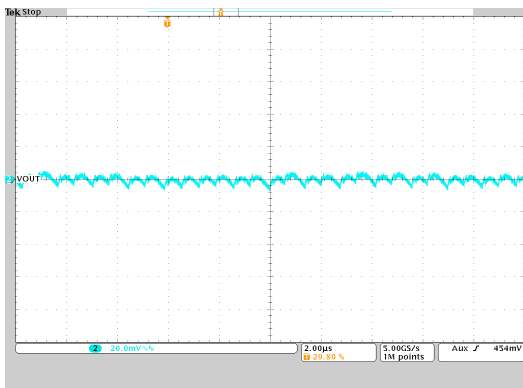

$V_{OUT} = 1.2\text{ V}$ PFM $T_A = 25^\circ\text{C}$
 $V_{IN} = 5\text{ V}$ $I_{OUT} = 0.2\text{ A}$

Figure 9-46. Output Voltage Ripple

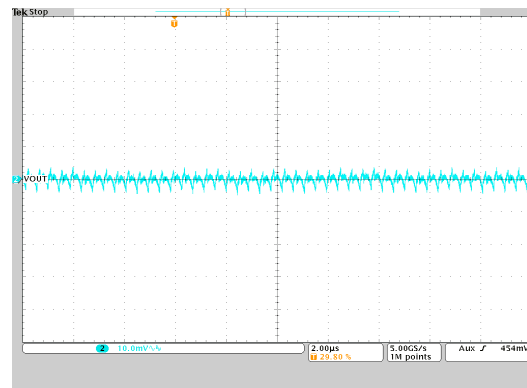

$V_{OUT} = 1.2\text{ V}$ PWM $T_A = 25^\circ\text{C}$
 $V_{IN} = 5\text{ V}$ $I_{OUT} = 2\text{ A}$

Figure 9-47. Output Voltage Ripple

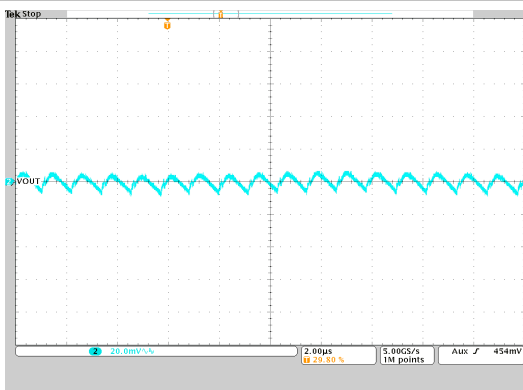

$V_{OUT} = 1.0\text{ V}$ PFM $T_A = 25^\circ\text{C}$
 $V_{IN} = 5\text{ V}$ $I_{OUT} = 0.2\text{ A}$

Figure 9-48. Output Voltage Ripple

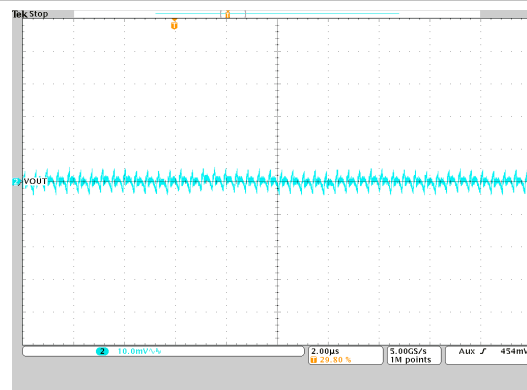

$V_{OUT} = 1.0\text{ V}$ PWM $T_A = 25^\circ\text{C}$
 $V_{IN} = 5\text{ V}$ $I_{OUT} = 2\text{ A}$

Figure 9-49. Output Voltage Ripple

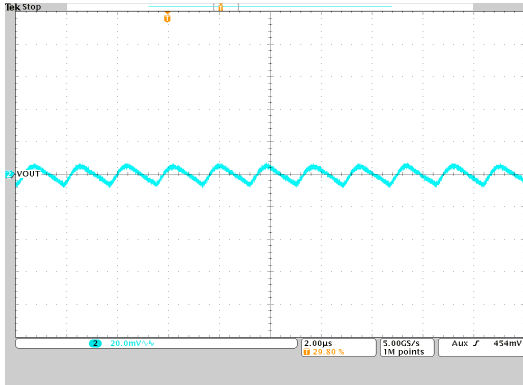

$V_{OUT} = 0.6\text{ V}$ PFM $T_A = 25^\circ\text{C}$
 $V_{IN} = 3.3\text{ V}$ $I_{OUT} = 0.2\text{ A}$

Figure 9-50. Output Voltage Ripple

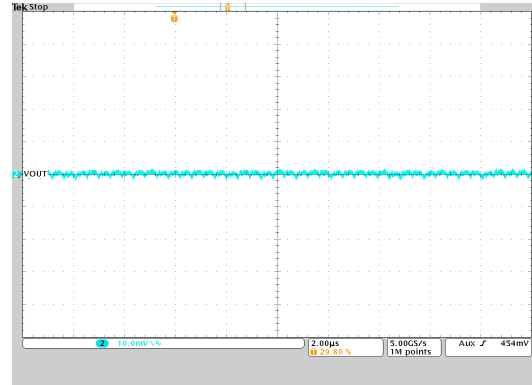

$V_{OUT} = 0.6\text{ V}$ PWM $T_A = 25^\circ\text{C}$
 $V_{IN} = 3.3\text{ V}$ $I_{OUT} = 2\text{ A}$

Figure 9-51. Output Voltage Ripple

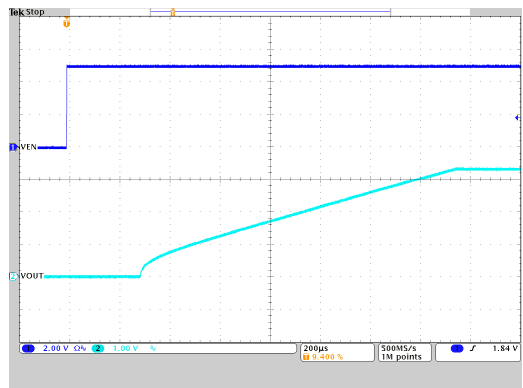

$V_{OUT} = 3.3\text{ V}$ PWM or PFM $T_A = 25^\circ\text{C}$
 $V_{IN} = 5\text{ V}$ $I_{OUT} = 2\text{ A}$

Figure 9-52. Start-Up Timing

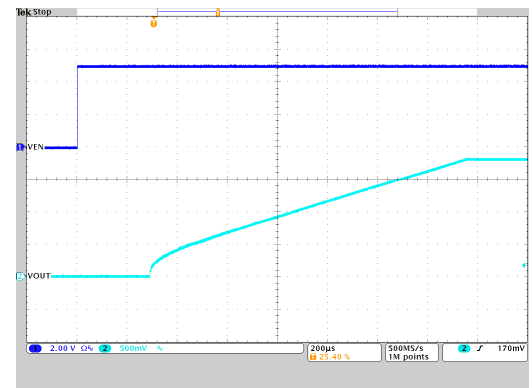

$V_{OUT} = 1.8\text{ V}$ PWM or PFM $T_A = 25^\circ\text{C}$
 $V_{IN} = 5\text{ V}$ $I_{OUT} = 2\text{ A}$

Figure 9-53. Start-Up Timing

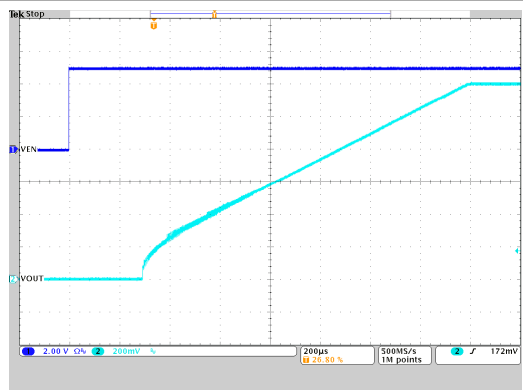

$V_{OUT} = 1.2\text{ V}$ PWM or PFM $T_A = 25^\circ\text{C}$
 $V_{IN} = 5\text{ V}$ $I_{OUT} = 2\text{ A}$

Figure 9-54. Start-Up Timing

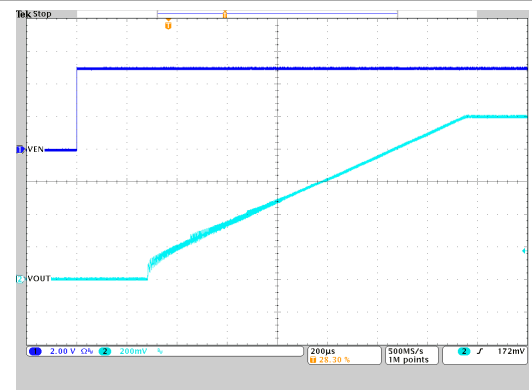

$V_{OUT} = 1.0\text{ V}$ PWM or PFM $T_A = 25^\circ\text{C}$
 $V_{IN} = 5\text{ V}$ $I_{OUT} = 2\text{ A}$

Figure 9-55. Start-Up Timing

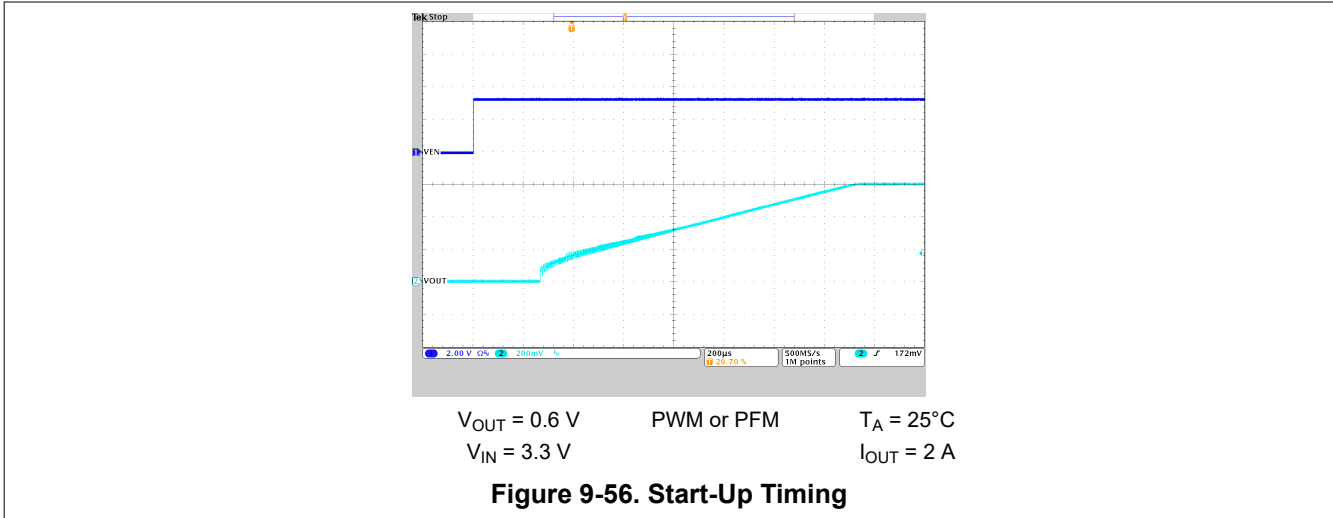

9.3 System Examples

9.3.1 Synchronizing to an External Clock

The TPS62850x can be externally synchronized by applying an external clock on the MODE/SYNC pin. There is no need for any additional circuitry as long as the input signal meets the requirements given in the electrical specifications. The clock can be applied / removed during operation, allowing an externally defined fixed frequency to be switched to a power-save mode or to internal fixed frequency operation.

The value of the R_{CF} resistor must be chosen such that the internally defined frequency and the externally applied frequency are close to each other. This ensures a smooth transition from internal to external frequency and vice versa.

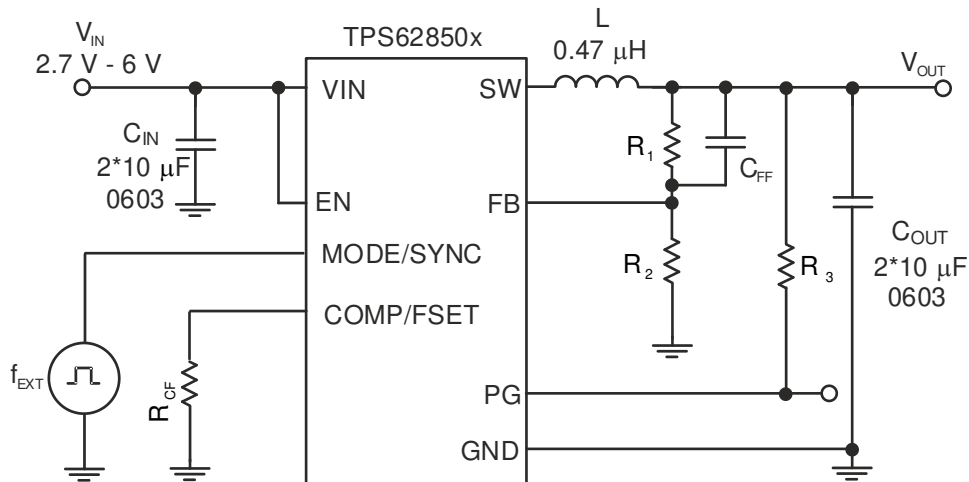
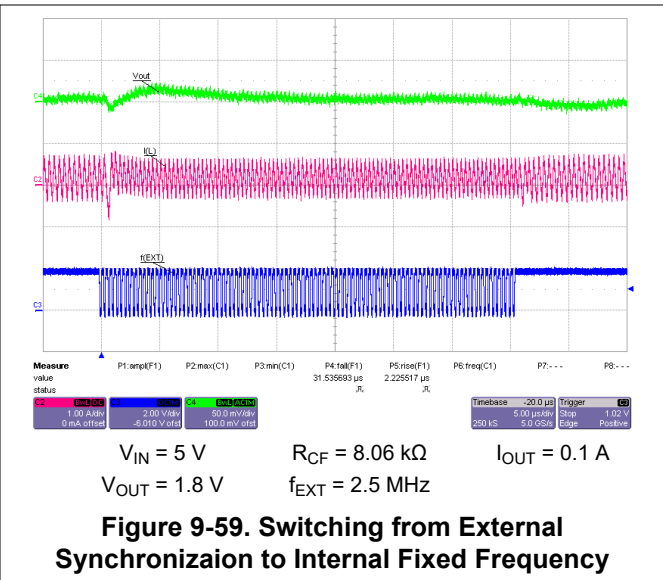
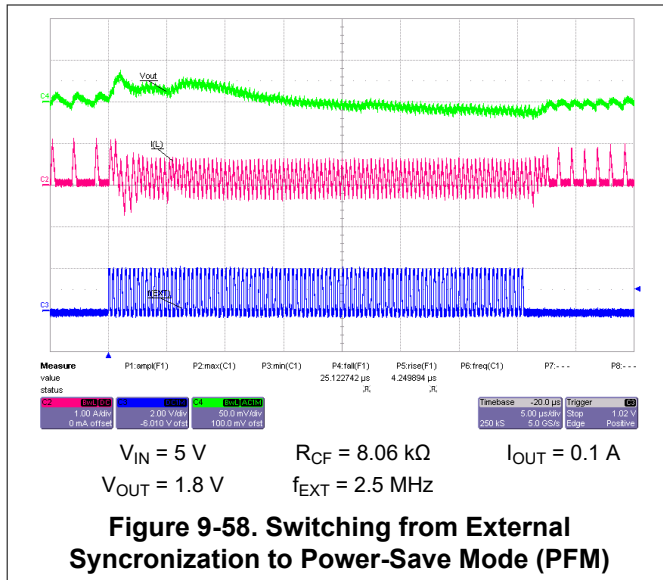

Figure 9-57. Schematic using External Synchronization



9.4 Power Supply Recommendations

The TPS62850x device family does not have special requirements for the input power supply. The output current of the input power supply needs to be rated according to the supply voltage, output voltage, and output current of the TPS62850x.

9.5 Layout

9.5.1 Layout Guidelines

A proper layout is critical for the operation of a switched mode power supply, even more at high switching frequencies. Therefore, the PCB layout of the TPS62850x demands careful attention to make sure operation and to get the performance specified. A poor layout can lead to issues like the following:

- Poor regulation (both in [Section 9.5.2](#) and load)
- Stability and accuracy weaknesses
- Increased EMI radiation
- Noise sensitivity

See [Figure 9-60](#) for the recommended layout of the TPS62850x, which is designed for common external ground connections. The input capacitor must be placed as close as possible between the VIN and GND pin.

Provide low inductive and resistive paths for loops with high di/dt. Therefore, paths conducting the switched load current must be as short and wide as possible. Provide low capacitive paths (with respect to all other nodes) for wires with high dv/dt. Therefore, the input and output capacitance must be placed as close as possible to the IC pins and parallel wiring over long distances and narrow traces must be avoided. Loops which conduct an alternating current must outline an area as small as possible because this area is proportional to the energy radiated.

Sensitive nodes like FB need to be connected with short wires and not nearby high dv/dt signals (for example, SW). Because FB carries information about the output voltage, FB must be connected as close as possible to the actual output voltage (at the output capacitor). The FB resistors, R_1 and R_2 , must be kept close to the IC and be connected directly to the pin and the system ground plane.

The package uses the pins for power dissipation. Thermal vias on the VIN and GND pins help to spread the heat into the PCB.

The recommended layout is implemented on the EVM and shown in the [TPS628502EVM-092 Evaluation Module User's Guide](#).

9.5.2 Layout Example

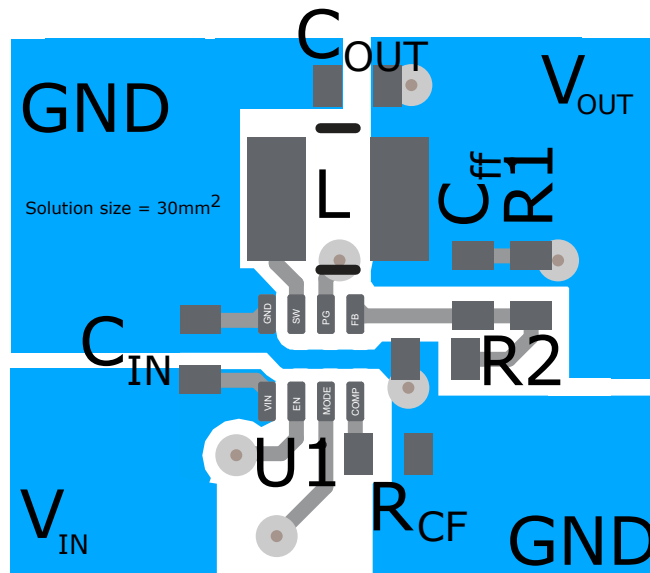

Figure 9-60. Example Layout

10 Device and Documentation Support

10.1 Device Support

10.1.1 Third-Party Products Disclaimer

TI'S PUBLICATION OF INFORMATION REGARDING THIRD-PARTY PRODUCTS OR SERVICES DOES NOT CONSTITUTE AN ENDORSEMENT REGARDING THE SUITABILITY OF SUCH PRODUCTS OR SERVICES OR A WARRANTY, REPRESENTATION OR ENDORSEMENT OF SUCH PRODUCTS OR SERVICES, EITHER ALONE OR IN COMBINATION WITH ANY TI PRODUCT OR SERVICE.

10.2 Receiving Notification of Documentation Updates

To receive notification of documentation updates, navigate to the device product folder on ti.com. Click on *Notifications* to register and receive a weekly digest of any product information that has changed. For change details, review the revision history included in any revised document.

10.3 Support Resources

[TI E2E™ support forums](#) are an engineer's go-to source for fast, verified answers and design help — straight from the experts. Search existing answers or ask your own question to get the quick design help you need.

Linked content is provided "AS IS" by the respective contributors. They do not constitute TI specifications and do not necessarily reflect TI's views; see TI's [Terms of Use](#).

10.4 Trademarks

TI E2E™ is a trademark of Texas Instruments.
All trademarks are the property of their respective owners.

10.5 Electrostatic Discharge Caution



This integrated circuit can be damaged by ESD. Texas Instruments recommends that all integrated circuits be handled with appropriate precautions. Failure to observe proper handling and installation procedures can cause damage.

ESD damage can range from subtle performance degradation to complete device failure. Precision integrated circuits may be more susceptible to damage because very small parametric changes could cause the device not to meet its published specifications.

10.6 Glossary

[TI Glossary](#) This glossary lists and explains terms, acronyms, and definitions.

11 Revision History

NOTE: Page numbers for previous revisions may differ from page numbers in the current version.

Changes from Revision A (June 2022) to Revision B (April 2024)	Page
• Added TPS628501MDRLR, TPS6285020ADRLR and TPS6285020MDRLR.....	3
<hr/>	
Changes from Revision * (March 2021) to Revision A (June 2022)	Page
• Added TPS628503.....	3

12 Mechanical, Packaging, and Orderable Information

The following pages include mechanical, packaging, and orderable information. This information is the most current data available for the designated devices. This data is subject to change without notice and revision of this document. For browser-based versions of this data sheet, refer to the left-hand navigation.

PACKAGING INFORMATION

Orderable Device	Status (1)	Package Type	Package Drawing	Pins	Package Qty	Eco Plan (2)	Lead finish/ Ball material (6)	MSL Peak Temp (3)	Op Temp (°C)	Device Marking (4/5)	Samples
TPS6285010MDRLR	ACTIVE	SOT-5X3	DRL	8	4000	RoHS & Green	Call TI SN	Level-1-260C-UNLIM	-40 to 150	10M	Samples
TPS628501DRLR	ACTIVE	SOT-5X3	DRL	8	4000	RoHS & Green	Call TI SN	Level-1-260C-UNLIM	-40 to 150	100	Samples
TPS6285020ADRLR	ACTIVE	SOT-5X3	DRL	8	4000	RoHS & Green	Call TI SN	Level-1-260C-UNLIM	-40 to 150	20A	Samples
TPS6285020MDRLR	ACTIVE	SOT-5X3	DRL	8	4000	RoHS & Green	SN	Level-1-260C-UNLIM	-40 to 150	20M	Samples
TPS628502DRLR	ACTIVE	SOT-5X3	DRL	8	4000	RoHS & Green	Call TI SN	Level-1-260C-UNLIM	-40 to 150	200	Samples
TPS628503DRLR	ACTIVE	SOT-5X3	DRL	8	4000	RoHS & Green	Call TI SN	Level-1-260C-UNLIM	-40 to 150	300	Samples

(1) The marketing status values are defined as follows:

ACTIVE: Product device recommended for new designs.

LIFEBUY: TI has announced that the device will be discontinued, and a lifetime-buy period is in effect.

NRND: Not recommended for new designs. Device is in production to support existing customers, but TI does not recommend using this part in a new design.

PREVIEW: Device has been announced but is not in production. Samples may or may not be available.

OBSELETE: TI has discontinued the production of the device.

(2) **RoHS:** TI defines "RoHS" to mean semiconductor products that are compliant with the current EU RoHS requirements for all 10 RoHS substances, including the requirement that RoHS substance do not exceed 0.1% by weight in homogeneous materials. Where designed to be soldered at high temperatures, "RoHS" products are suitable for use in specified lead-free processes. TI may reference these types of products as "Pb-Free".

RoHS Exempt: TI defines "RoHS Exempt" to mean products that contain lead but are compliant with EU RoHS pursuant to a specific EU RoHS exemption.

Green: TI defines "Green" to mean the content of Chlorine (Cl) and Bromine (Br) based flame retardants meet JS709B low halogen requirements of <=1000ppm threshold. Antimony trioxide based flame retardants must also meet the <=1000ppm threshold requirement.

(3) MSL, Peak Temp. - The Moisture Sensitivity Level rating according to the JEDEC industry standard classifications, and peak solder temperature.

(4) There may be additional marking, which relates to the logo, the lot trace code information, or the environmental category on the device.

(5) Multiple Device Markings will be inside parentheses. Only one Device Marking contained in parentheses and separated by a "~" will appear on a device. If a line is indented then it is a continuation of the previous line and the two combined represent the entire Device Marking for that device.

(6) Lead finish/Ball material - Orderable Devices may have multiple material finish options. Finish options are separated by a vertical ruled line. Lead finish/Ball material values may wrap to two lines if the finish value exceeds the maximum column width.

Important Information and Disclaimer: The information provided on this page represents TI's knowledge and belief as of the date that it is provided. TI bases its knowledge and belief on information provided by third parties, and makes no representation or warranty as to the accuracy of such information. Efforts are underway to better integrate information from third parties. TI has taken and continues to take reasonable steps to provide representative and accurate information but may not have conducted destructive testing or chemical analysis on incoming materials and chemicals. TI and TI suppliers consider certain information to be proprietary, and thus CAS numbers and other limited information may not be available for release.

In no event shall TI's liability arising out of such information exceed the total purchase price of the TI part(s) at issue in this document sold by TI to Customer on an annual basis.

OTHER QUALIFIED VERSIONS OF TPS628501, TPS628502, TPS628503 :

- Automotive : [TPS628501-Q1](#), [TPS628502-Q1](#), [TPS628503-Q1](#)

NOTE: Qualified Version Definitions:

- Automotive - Q100 devices qualified for high-reliability automotive applications targeting zero defects

TAPE AND REEL INFORMATION

QUADRANT ASSIGNMENTS FOR PIN 1 ORIENTATION IN TAPE

*All dimensions are nominal

Device	Package Type	Package Drawing	Pins	SPQ	Reel Diameter (mm)	Reel Width W1 (mm)	A0 (mm)	B0 (mm)	K0 (mm)	P1 (mm)	W (mm)	Pin1 Quadrant
TPS6285010MDRLR	SOT-5X3	DRL	8	4000	180.0	8.4	2.75	1.9	0.8	4.0	8.0	Q3
TPS628501DRLR	SOT-5X3	DRL	8	4000	180.0	8.4	2.75	1.9	0.8	4.0	8.0	Q3
TPS6285020ADRLR	SOT-5X3	DRL	8	4000	180.0	8.4	2.75	1.9	0.8	4.0	8.0	Q3
TPS6285020MDRLR	SOT-5X3	DRL	8	4000	180.0	8.4	2.75	1.9	0.8	4.0	8.0	Q3
TPS628502DRLR	SOT-5X3	DRL	8	4000	180.0	8.4	2.75	1.9	0.8	4.0	8.0	Q3
TPS628503DRLR	SOT-5X3	DRL	8	4000	180.0	8.4	2.75	1.9	0.8	4.0	8.0	Q3

TAPE AND REEL BOX DIMENSIONS

*All dimensions are nominal

Device	Package Type	Package Drawing	Pins	SPQ	Length (mm)	Width (mm)	Height (mm)
TPS6285010MDRLR	SOT-5X3	DRL	8	4000	210.0	185.0	35.0
TPS628501DRLR	SOT-5X3	DRL	8	4000	210.0	185.0	35.0
TPS6285020ADRLR	SOT-5X3	DRL	8	4000	210.0	185.0	35.0
TPS6285020MDRLR	SOT-5X3	DRL	8	4000	210.0	185.0	35.0
TPS628502DRLR	SOT-5X3	DRL	8	4000	210.0	185.0	35.0
TPS628503DRLR	SOT-5X3	DRL	8	4000	210.0	185.0	35.0

EXAMPLE BOARD LAYOUT

DRL0008A

SOT-5X3 - 0.6 mm max height

PLASTIC SMALL OUTLINE

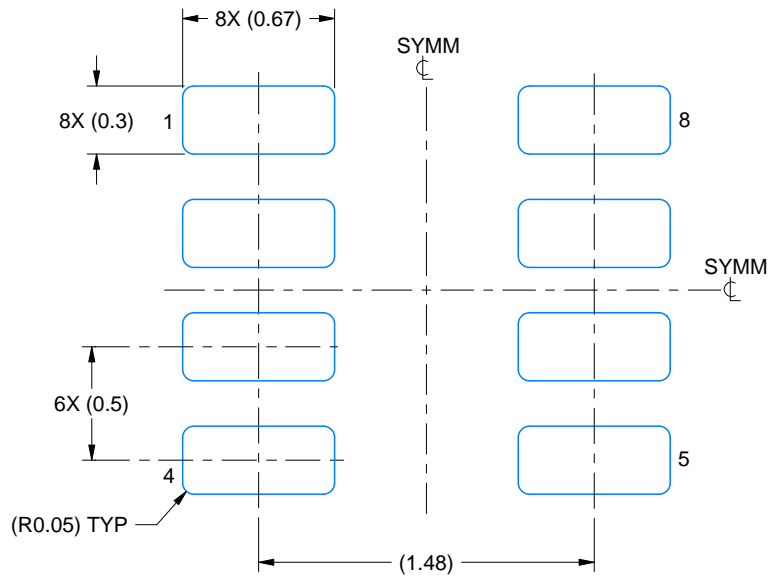

LAND PATTERN EXAMPLE
EXPOSED METAL SHOWN
SCALE:30X

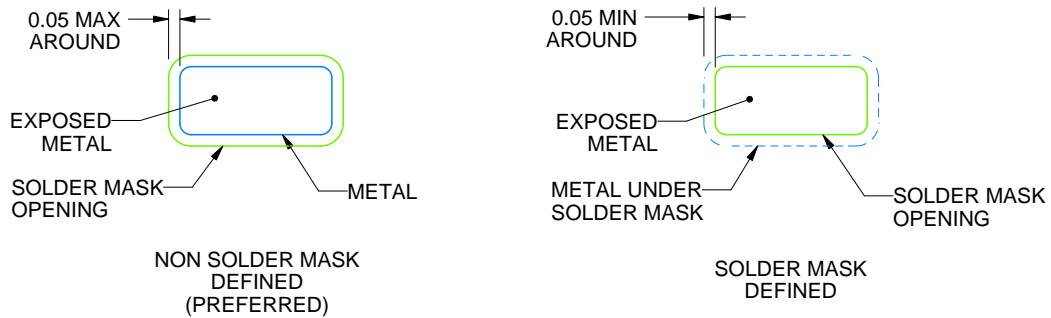

SOLDERMASK DETAILS

4224486/E 12/2021

NOTES: (continued)

5. Publication IPC-7351 may have alternate designs.
6. Solder mask tolerances between and around signal pads can vary based on board fabrication site.
7. Land pattern design aligns to IPC-610, Bottom Termination Component (BTC) solder joint inspection criteria.

EXAMPLE STENCIL DESIGN

DRL0008A

SOT-5X3 - 0.6 mm max height

PLASTIC SMALL OUTLINE

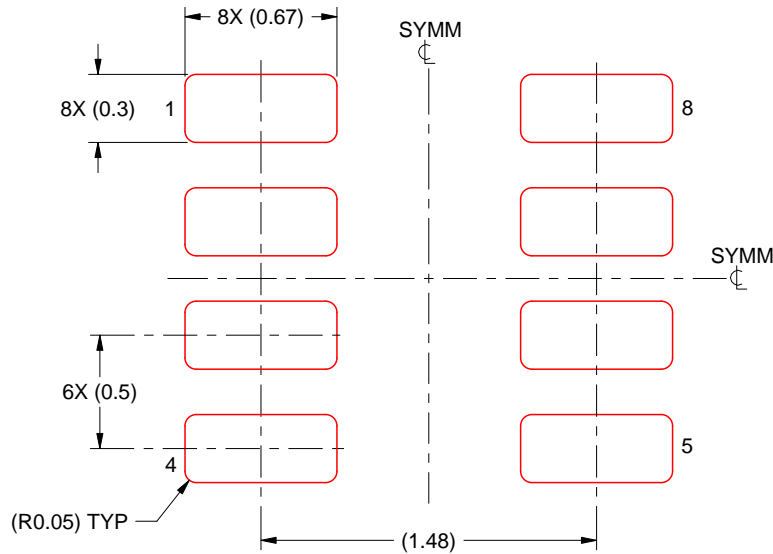

SOLDER PASTE EXAMPLE
BASED ON 0.1 mm THICK STENCIL
SCALE:30X

4224486/E 12/2021

NOTES: (continued)

8. Laser cutting apertures with trapezoidal walls and rounded corners may offer better paste release. IPC-7525 may have alternate design recommendations.
9. Board assembly site may have different recommendations for stencil design.

IMPORTANT NOTICE AND DISCLAIMER

TI PROVIDES TECHNICAL AND RELIABILITY DATA (INCLUDING DATA SHEETS), DESIGN RESOURCES (INCLUDING REFERENCE DESIGNS), APPLICATION OR OTHER DESIGN ADVICE, WEB TOOLS, SAFETY INFORMATION, AND OTHER RESOURCES "AS IS" AND WITH ALL FAULTS, AND DISCLAIMS ALL WARRANTIES, EXPRESS AND IMPLIED, INCLUDING WITHOUT LIMITATION ANY IMPLIED WARRANTIES OF MERCHANTABILITY, FITNESS FOR A PARTICULAR PURPOSE OR NON-INFRINGEMENT OF THIRD PARTY INTELLECTUAL PROPERTY RIGHTS.

These resources are intended for skilled developers designing with TI products. You are solely responsible for (1) selecting the appropriate TI products for your application, (2) designing, validating and testing your application, and (3) ensuring your application meets applicable standards, and any other safety, security, regulatory or other requirements.

These resources are subject to change without notice. TI grants you permission to use these resources only for development of an application that uses the TI products described in the resource. Other reproduction and display of these resources is prohibited. No license is granted to any other TI intellectual property right or to any third party intellectual property right. TI disclaims responsibility for, and you will fully indemnify TI and its representatives against, any claims, damages, costs, losses, and liabilities arising out of your use of these resources.

TI's products are provided subject to [TI's Terms of Sale](#) or other applicable terms available either on [ti.com](https://www.ti.com) or provided in conjunction with such TI products. TI's provision of these resources does not expand or otherwise alter TI's applicable warranties or warranty disclaimers for TI products.

TI objects to and rejects any additional or different terms you may have proposed.

Mailing Address: Texas Instruments, Post Office Box 655303, Dallas, Texas 75265
Copyright © 2024, Texas Instruments Incorporated