

ADC121S021 Single-Channel, 50- to 200-kpsps, 12-Bit A/D Converter

1 Features

- Specified Over a Range of Sample Rates
- Variable Power Management
- Single Power Supply With 2.7-V to 5.25-V Range
- Compatible With the SPI, QSPI, MICROWIRE, and DSP
- Key Specifications:
 - DNL: 0.45 and -0.25 LSB (Typical)
 - INL: 0.45 and -0.4 LSB (Typical)
 - SNR: 72.3 dB (Typical)
 - Power Consumption
 - 3.6-V Supply: 1.5 mW (Typical)
 - 5.25-V Supply: 7.9 mW (Typical)

2 Applications

- Portable Systems
- Remote Data Acquisition
- Instrumentation and Control Systems

3 Description

The ADC121S021 device is a low-power, single-channel CMOS 12-bit analog-to-digital converter with a high-speed serial interface. Unlike the conventional practice of specifying performance at a single sample rate only, the ADC121S021 is fully specified over a sample rate range of 50 kpsps to 200 kpsps. The converter is based upon a successive-approximation register architecture with an internal track-and-hold circuit.

The output serial data is straight binary, and is compatible with several standards, such as SPI™, QSPI™, MICROWIRE, and many common DSP serial interfaces.

The ADC121S021 operates with a single supply that can range from 2.7 V to 5.25 V. Normal power consumption using a 3.6-V or 5.25-V supply is 1.5 mW and 7.9 mW, respectively. The power-down feature reduces the power consumption to as low as 2.6 μ W using a 5.25-V supply.

The ADC121S021 is packaged in 6-pin WSON and SOT-23 packages. Operation over the industrial temperature range of -40°C to 85°C is ensured.

Device Information⁽¹⁾

PART NUMBER	PACKAGE	BODY SIZE (NOM)
ADC121S021	SOT-23 (6)	2.90 mm x 1.60 mm
	WSON (6)	2.50 mm x 2.20 mm

(1) For all available packages, see the orderable addendum at the end of the data sheet.

Key Graphic

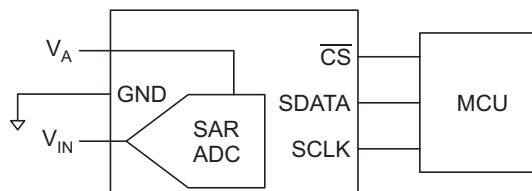

Table of Contents

1 Features	1	9.3 Feature Description	10
2 Applications	1	9.4 Device Functional Modes	10
3 Description	1	10 Applications Information	12
4 Revision History	2	10.1 Application Information	12
5 Device Comparison Table	3	10.2 Typical Application	15
6 Pin Configuration and Functions	3	11 Power Supply Recommendations	17
7 Specifications	4	11.1 Power Supply Noise Considerations	17
7.1 Absolute Maximum Ratings	4	12 Layout	17
7.2 ESD Ratings	4	12.1 Layout Guidelines	17
7.3 Recommended Operating Conditions	4	12.2 Layout Example	17
7.4 Thermal Information	5	13 Device and Documentation Support	18
7.5 Electrical Characteristics	5	13.1 Device Support	18
7.6 Timing Requirements	7	13.2 Community Resources	19
7.7 Typical Characteristics	8	13.3 Trademarks	19
8 Parameter Measurement Information	9	13.4 Electrostatic Discharge Caution	19
9 Detailed Description	10	13.5 Glossary	19
9.1 Overview	10	14 Mechanical, Packaging, and Orderable Information	19
9.2 Functional Block Diagram	10		

4 Revision History

NOTE: Page numbers for previous revisions may differ from page numbers in the current version.

Changes from Revision I (January 2014) to Revision J	Page
<ul style="list-style-type: none"> Added <i>ESD Ratings</i> table, <i>Feature Description</i> section, <i>Device Functional Modes, Application and Implementation</i> section, <i>Power Supply Recommendations</i> section, <i>Layout</i> section, <i>Device and Documentation Support</i> section, and <i>Mechanical, Packaging, and Orderable Information</i> section 	1
<hr/>	
Changes from Revision H (March 2013) to Revision I	Page
<ul style="list-style-type: none"> Changed sentence in the "Using the ADC121S021" section 	13
<hr/>	
Changes from Revision G (March 2013) to Revision H	Page
<ul style="list-style-type: none"> Changed layout of National Data Sheet to TI format 	17

5 Device Comparison Table⁽¹⁾

RESOLUTION	SPECIFIED FOR SAMPLE RATE RANGE OF:		
	50 to 200 ksps	200 to 500 ksps	500 ksps to 1 Msps
12-bit	ADC121S021	ADC121S051	ADC121S101
10-bit	ADC101S021	ADC101S051	ADC101S101
8-bit	ADC081S021	ADC081S051	ADC081S101

(1) All devices are fully pin and function compatible.

6 Pin Configuration and Functions

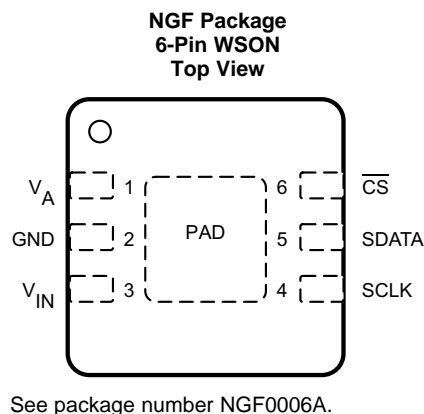
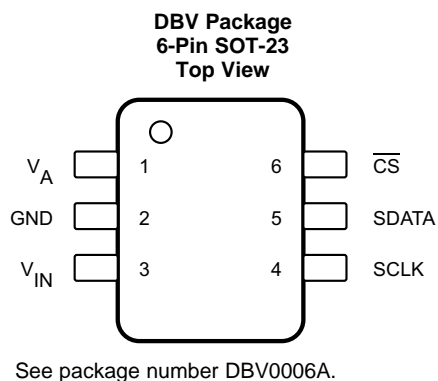

Pin Functions

PIN		TYPE	DESCRIPTION
NAME	NO.		
\overline{CS}	6	Digital I/O	Chip select. On the falling edge of \overline{CS} , a conversion process begins.
GND	2	PWR	The ground return for the supply and signals.
SCLK	4	Digital I/O	Digital clock input. This clock directly controls the conversion and readout processes.
SDATA	5	Digital I/O	Digital data output. The output samples are clocked out of this pin on falling edges of the SCLK pin.
V_A	1	PWR	Positive supply pin. This pin must be connected to a quiet 2.7-V to 5.25-V source and bypassed to GND with a 1- μ F capacitor and a 0.1- μ F monolithic capacitor located within 1 cm of the power pin.
V_{IN}	3	Analog I/O	Analog input. This signal can range from 0 V to V_A .
PAD	—	PWR	For package suffix CISD(X) only, TI recommends connecting the center pad to ground.

7 Specifications

7.1 Absolute Maximum Ratings

 over operating free-air temperature range (unless otherwise noted)⁽¹⁾⁽²⁾⁽³⁾

	MIN	MAX	UNIT
Analog supply voltage, V_A	-0.3	6.5	V
Voltage on any digital pin to GND	-0.3	6.5	V
Voltage on any analog pin to GND	-0.3	$V_A + 0.3$	V
Input current at any pin ⁽⁴⁾		± 10 mA	mA
Package input current ⁽⁴⁾		± 20 mA	mA
Power consumption at $T_A = 25^\circ\text{C}$		See ⁽⁵⁾	
Junction temperature, T_J		150	$^\circ\text{C}$
Storage temperature, T_{stg}	-65	150	$^\circ\text{C}$

- Stresses beyond those listed under *Absolute Maximum Ratings* may cause permanent damage to the device. These are stress ratings only, which do not imply functional operation of the device at these or any other conditions beyond those indicated under *Recommended Operating Conditions*. Exposure to absolute-maximum-rated conditions for extended periods may affect device reliability.
- If Military/Aerospace specified devices are required, please contact the TI Sales Office/ Distributors for availability and specifications.
- All voltages are measured with respect to GND = 0 V, unless otherwise specified.
- When the input voltage at any pin exceeds the power supply (that is, $V_{\text{IN}} < \text{GND}$ or $V_{\text{IN}} > V_A$), the current at that pin must be limited to 10 mA. The 20-mA maximum package input current rating limits the number of pins that can safely exceed the power supplies with an input current of 10 mA to two. The absolute maximum rating specification does not apply to the V_A pin. The current into the V_A pin is limited by the Analog Supply Voltage specification.
- The absolute maximum junction temperature (T_{Jmax}) for this device is 150°C . The maximum allowable power dissipation is dictated by T_{Jmax} , the junction-to-ambient thermal resistance ($R_{\theta\text{JA}}$), and the ambient temperature (T_A), and can be calculated using the formula $P_{\text{Dmax}} = (T_{\text{Jmax}} - T_A) / R_{\theta\text{JA}}$. The values for maximum power dissipation listed above is reached only when the device is operated in a severe fault condition (for example, when input or output pins are driven beyond the power supply voltages, or the power supply polarity is reversed). Obviously, such conditions must always be avoided.

7.2 ESD Ratings

		VALUE	UNIT
$V_{\text{(ESD)}}$	Electrostatic discharge	Human-body model (HBM), per ANSI/ESDA/JEDEC JS-001 ⁽¹⁾⁽²⁾	± 3500
		Charged-device model (CDM), per JEDEC specification JESD22-C101 ⁽³⁾	± 1250
		Machine mode (MM) ⁽⁴⁾	± 300

- JEDEC document JEP155 states that 500-V HBM allows safe manufacturing with a standard ESD control process.
- HBM is 100-pF capacitor discharged through a 1.5-k Ω resistor.
- JEDEC document JEP157 states that 250-V CDM allows safe manufacturing with a standard ESD control process.
- Machine model is 220-pF discharged through 0 Ω .

7.3 Recommended Operating Conditions

 over operating free-air temperature range (unless otherwise noted)⁽¹⁾

	MIN	MAX	UNIT
Operating temperature, T_A	-40	85	$^\circ\text{C}$
Supply voltage, V_A	2.7	5.25	V
Digital input pins voltage ⁽²⁾	-0.3	5.25	V
Analog input pins voltage	0	V_A	V
Clock frequency	0.025	20	MHz
Sample rate		1	Msps

- All voltages are measured with respect to GND = 0 V, unless otherwise specified.
- Regardless of supply voltage

7.4 Thermal Information

THERMAL METRIC ⁽¹⁾⁽²⁾		ADC121S021		UNIT
		DBV (SOT-23)	NGF (WSON)	
		6 PINS	6 PINS	
R _{θJA}	Junction-to-ambient thermal resistance	185	83.7	°C/W
R _{θJC(top)}	Junction-to-case (top) thermal resistance	156.5	72.1	°C/W
R _{θJB}	Junction-to-board thermal resistance	29.6	24.8	°C/W
ψ _{JT}	Junction-to-top characterization parameter	33.8	3.4	°C/W
ψ _{JB}	Junction-to-board characterization parameter	29.1	24.7	°C/W
R _{θJC(bot)}	Junction-to-case (bottom) thermal resistance	—	14.8	°C/W

- (1) For more information about traditional and new thermal metrics, see the *Semiconductor and IC Package Thermal Metrics* application report, [SPRA953](#).
- (2) Soldering process must comply with Reflow Temperature Profile specifications. See <http://www.ti.com/lit/SNOA549>. Reflow temperature profiles are different for lead-free and non-lead-free packages.

7.5 Electrical Characteristics

V_A = 2.7 V to 5.25 V, f_{SCLK} = 1 MHz to 4 MHz, f_{SAMPLE} = 50 ksp/s to 200 ksp/s, C_L = 15 pF, unless otherwise noted. Typical limits apply for T_A = 25°C; minimum and maximum limits apply for T_A = -40°C to 85°C, unless otherwise noted. All limits⁽¹⁾⁽²⁾

PARAMETER		TEST CONDITIONS		MIN	TYP	MAX	UNIT
STATIC CONVERTER CHARACTERISTICS							
Resolution with no missing codes		T _A = -40°C to 85°C		12			Bits
INL	Integral non-linearity	V _A = 2.7 V to 3.6 V	T _A = 25°C	-0.4		0.45	LSB
			T _A = -40°C to 85°C	-1		1	
		V _A = 4.75 V to 5.25 V	T _A = 25°C	-0.4		0.55	LSB
DNL	Differential non-linearity	V _A = 2.7 V to 3.6 V	T _A = 25°C	-0.25		0.45	LSB
			T _A = -40°C to 85°C	-0.8		1	
		V _A = 4.75 V to 5.25 V	T _A = 25°C	-0.3		0.6	LSB
V _{OFF}	Offset error	V _A = 2.7 V to 3.6 V			-0.18	±1.2	LSB
		V _A = 4.75 V to 5.25 V	T _A = 25°C			-0.26	
GE	Gain error	V _A = 2.7 V to 3.6 V			-0.75	±1.5	LSB
		V _A = 4.75 V to 5.25 V	T _A = 25°C			-1.6	
DYNAMIC CONVERTER CHARACTERISTICS							
SINAD	Signal-to-noise plus distortion ratio	V _A = 2.7 V to 5.25 V, f _{IN} = 100 kHz, -0.02 dBFS		70	72		dBFS
SNR	Signal-to-noise ratio	V _A = 2.7 V to 5.25 V, f _{IN} = 100 kHz, -0.02 dBFS		70.8	72.3		dBFS
THD	Total harmonic distortion	V _A = 2.7 V to 5.25 V, f _{IN} = 100 kHz, -0.02 dBFS			-83		dBFS
SFDR	Spurious-free dynamic range	V _A = 2.7 V to 5.25 V, f _{IN} = 100 kHz, -0.02 dBFS			85		dB
ENOB	Effective number of bits	V _A = 2.7 V to 5.25 V, f _{IN} = 100 kHz, -0.02 dBFS		11.3	11.7		Bits
IMD	Intermodulation distortion, second order terms	V _A = 5.25 V, f _a = 103.5 kHz, f _b = 113.5 kHz			-83		dBFS
	Intermodulation distortion, third order terms	V _A = 5.25 V, f _a = 103.5 kHz, f _b = 113.5 kHz			-82		dBFS
FPBW	-3-dB full power bandwidth	V _A = 5 V			11		MHz
		V _A = 3 V			8		
ANALOG INPUT CHARACTERISTICS							
V _{IN}	Input range	T _A = 25°C		0		V _A	V
I _{DCL}	DC leakage current			-1		1	μA
C _{INA}	Input capacitance	Track Mode			30		pF
		Hold Mode			4		

- (1) Tested limits are specified to TI's AOQL (Average Outgoing Quality Level).
- (2) Data sheet min/max specification limits are ensured by design, test, or statistical analysis.

Electrical Characteristics (continued)

$V_A = 2.7\text{ V to }5.25\text{ V}$, $f_{\text{SCLK}} = 1\text{ MHz to }4\text{ MHz}$, $f_{\text{SAMPLE}} = 50\text{ ksp/s to }200\text{ ksp/s}$, $C_L = 15\text{ pF}$, unless otherwise noted. Typical limits apply for $T_A = 25^\circ\text{C}$; minimum and maximum limits apply for $T_A = -40^\circ\text{C to }85^\circ\text{C}$, unless otherwise noted. All limits⁽¹⁾⁽²⁾⁽²⁾

PARAMETER		TEST CONDITIONS		MIN	TYP	MAX	UNIT
DIGITAL INPUT CHARACTERISTICS							
V_{IH}	Input high voltage	$V_A = 5.25\text{ V}$	$T_A = -40^\circ\text{C to }85^\circ\text{C}$	2.4			V
		$V_A = 3.6\text{ V}$	$T_A = -40^\circ\text{C to }85^\circ\text{C}$	2.1			
V_{IL}	Input low voltage	$V_A = 5\text{ V}$	$T_A = -40^\circ\text{C to }85^\circ\text{C}$			0.8	V
		$V_A = 3\text{ V}$	$T_A = -40^\circ\text{C to }85^\circ\text{C}$			0.4	
I_{IN}	Input current	$V_{\text{IN}} = 0\text{ V or }V_A$			± 0.1	± 1	μA
C_{IND}	Digital input capacitance				2	4	pF
DIGITAL OUTPUT CHARACTERISTICS							
V_{OH}	Output high voltage	$I_{\text{SOURCE}} = 200\text{ }\mu\text{A}$		$V_A - 0.2$	$V_A - 0.07$		V
		$I_{\text{SOURCE}} = 1\text{ mA}$		$V_A - 0.1$			
V_{OL}	Output low voltage	$I_{\text{SINK}} = 200\text{ }\mu\text{A}$			0.03	0.4	V
		$I_{\text{SINK}} = 1\text{ mA}$			0.1		
$I_{\text{OZH}}, I_{\text{OZL}}$	TRI-STATE [®] leakage current				± 0.1	± 10	μA
C_{OUT}	TRI-STATE output capacitance				2	4	pF
	Output coding			Straight (Natural) Binary			
POWER SUPPLY CHARACTERISTICS							
V_A	Supply voltage			2.7		5.25	V
I_A	Supply current, normal mode (operational, $\overline{\text{CS}}$ low)	$V_A = 5.25\text{ V}, f_{\text{SAMPLE}} = 200\text{ ksp/s}$			1.5	2.8	mA
		$V_A = 3.6\text{ V}, f_{\text{SAMPLE}} = 200\text{ ksp/s}$			0.4	1.2	
	Supply current, shutdown ($\overline{\text{CS}}$ high)	$f_{\text{SCLK}} = 0\text{ MHz}, V_A = 5.25\text{ V}, f_{\text{SAMPLE}} = 0\text{ ksp/s}$			500		nA
		$f_{\text{SCLK}} = 4\text{ MHz}, V_A = 5.25\text{ V}, f_{\text{SAMPLE}} = 0\text{ ksp/s}$			60		μA
P_D	Power consumption, normal mode (operational, $\overline{\text{CS}}$ low)	$V_A = 5.25\text{ V}$			7.9	14.7	mW
		$V_A = 3.6\text{ V}$			1.5	4.3	
	Power consumption, shutdown ($\overline{\text{CS}}$ high)	$f_{\text{SCLK}} = 0\text{ MHz}, V_A = 5.25\text{ V}, f_{\text{SAMPLE}} = 0\text{ ksp/s}$			2.6		μW
		$V_A = 5.25\text{ V}, f_{\text{SCLK}} = 4\text{ MHz}, f_{\text{SAMPLE}} = 0\text{ ksp/s}$			315		
AC ELECTRICAL CHARACTERISTICS							
f_{SCLK}	Clock frequency ⁽³⁾			1		4	MHz
f_S	Sample rate ⁽³⁾			50		200	ksp/s
DC	SCLK duty cycle	$f_{\text{SCLK}} = 4\text{ MHz}$		40%	50%	60%	
t_{ACQ}	Minimum acquisition time					350	ns
t_{QUIET}	Minimum quiet time ⁽⁴⁾			50			ns
t_{AD}	Aperture delay				3		ns
t_{AJ}	Aperture jitter				30		ps

(3) This is the frequency range over which the electrical performance is ensured. The device is functional over a wider range which is specified under Operating Ratings.

(4) Required by bus relinquish and the start of the next conversion.

7.6 Timing Requirements

The following specifications apply for $V_A = 2.7\text{ V}$ to 5.25 V , $GND = 0\text{ V}$, $f_{SCLK} = 1\text{ MHz}$ to 4 MHz , $C_L = 25\text{ pF}$, $f_{SAMPLE} = 50\text{ kpsps}$ to 200 kpsps , all limits $T_A = -40^\circ\text{C}$ to 85°C unless otherwise noted.

		MIN	TYP	MAX	UNIT
t_{CS}	Minimum \overline{CS} pulse width	10			ns
t_{SU}	\overline{CS} to SCLK setup time	10			ns
t_{EN}	Delay from \overline{CS} until SDATA TRI-STATE disabled ⁽¹⁾			20	ns
t_{ACC}	Data access time after SCLK falling edge ⁽²⁾	$V_A = 2.7\text{ V}$ to 3.6 V		40	ns
		$V_A = 4.75\text{ V}$ to 5.25 V		20	
t_{CL}	SCLK low pulse width	$0.4 \times t_{SCLK}$			ns
t_{CH}	SCLK high pulse width	$0.4 \times t_{SCLK}$			
t_H	SCLK to data valid hold time	$V_A = 2.7\text{ V}$ to 3.6 V	7		ns
		$V_A = 4.75\text{ V}$ to 5.25 V	5		
t_{DIS}	SCLK falling edge to SDATA high impedance ⁽³⁾	$V_A = 2.7\text{ V}$ to 3.6 V	6	25	ns
		$V_A = 4.75\text{ V}$ to 5.25 V	5	25	
$t_{POWER-UP}$	Power-up time from full power-down	$T_A = 25^\circ\text{C}$	1		μs

- (1) Measured with the timing test circuit shown in Figure 12 and defined as the time taken by the output signal to cross 1 V.
- (2) Measured with the timing test circuit shown in Figure 12 and defined as the time taken by the output signal to cross 1 V or 2 V.
- (3) t_{DIS} is derived from the time taken by the outputs to change by 0.5 V with the timing test circuit shown in Figure 12. The measured number is then adjusted to remove the effects of charging or discharging the output capacitance. This means that t_{DIS} is the true bus relinquish time, independent of the bus loading.

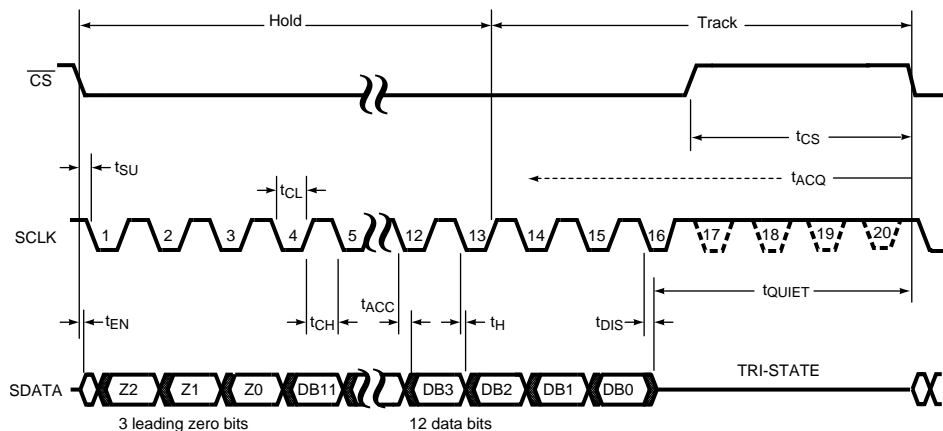

Figure 1. ADC121S021 Serial Timing Diagram

7.7 Typical Characteristics

$T_A = 25^\circ\text{C}$, $f_{\text{SAMPLE}} = 50 \text{ kpsps}$ to 200 kpsps , $f_{\text{SCLK}} = 1 \text{ MHz}$ to 4 MHz , $f_{\text{IN}} = 100 \text{ kHz}$ unless otherwise stated.

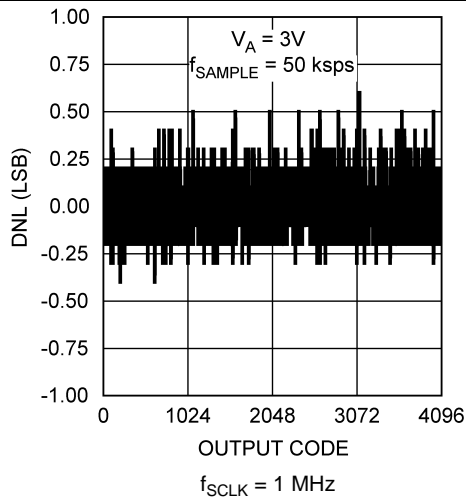

Figure 2. DNL

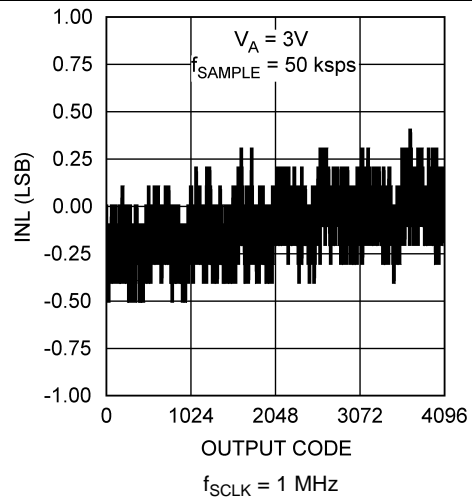

Figure 3. INL

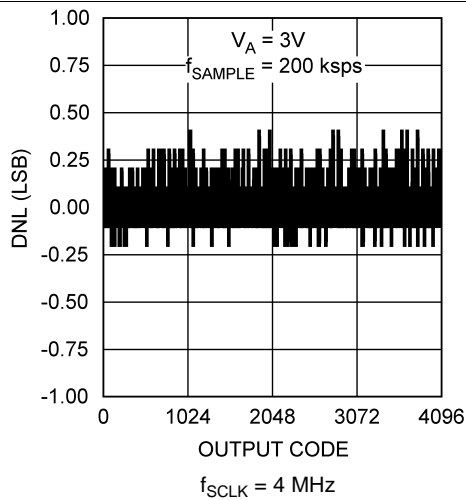

Figure 4. DNL

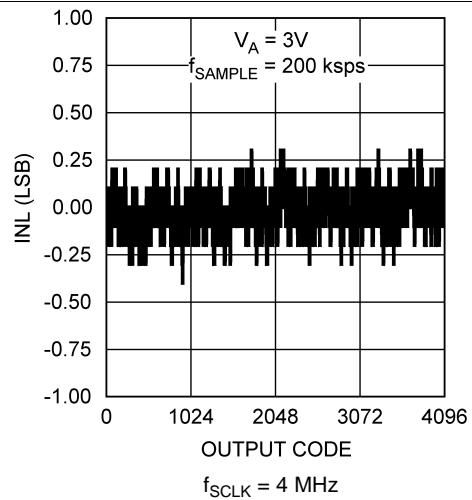

Figure 5. INL

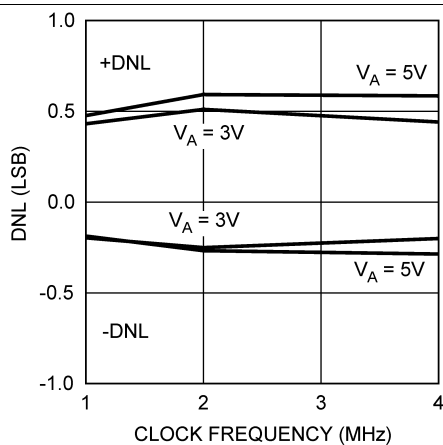

Figure 6. DNL vs Clock Frequency

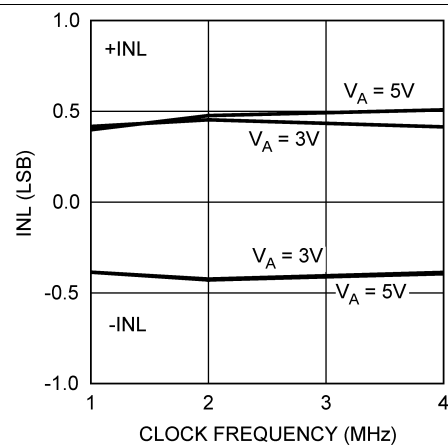

Figure 7. INL vs Clock Frequency

Typical Characteristics (continued)

$T_A = 25^\circ\text{C}$, $f_{\text{SAMPLE}} = 50 \text{ kpsps to } 200 \text{ kpsps}$, $f_{\text{SCLK}} = 1 \text{ MHz to } 4 \text{ MHz}$, $f_{\text{IN}} = 100 \text{ kHz}$ unless otherwise stated.

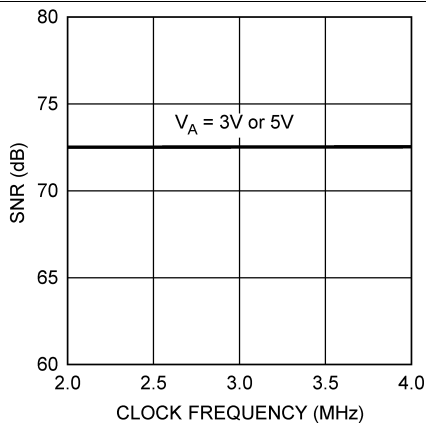

Figure 8. SNR vs Clock Frequency

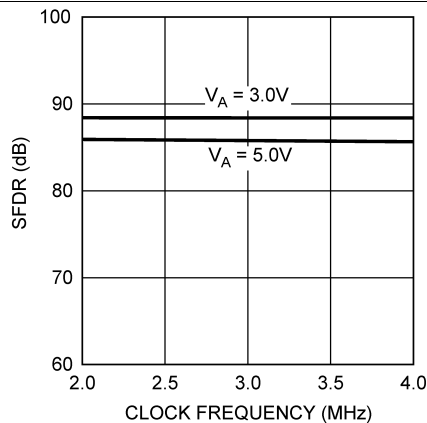

Figure 9. SFDR vs Clock Frequency

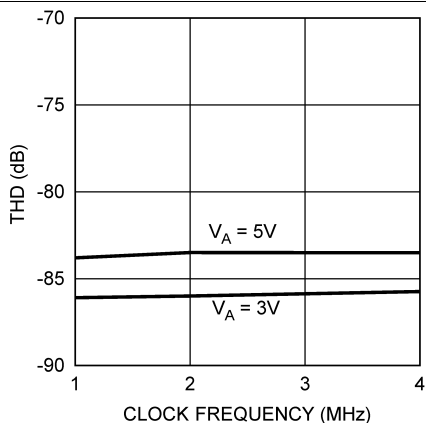

Figure 10. THD vs Clock Frequency

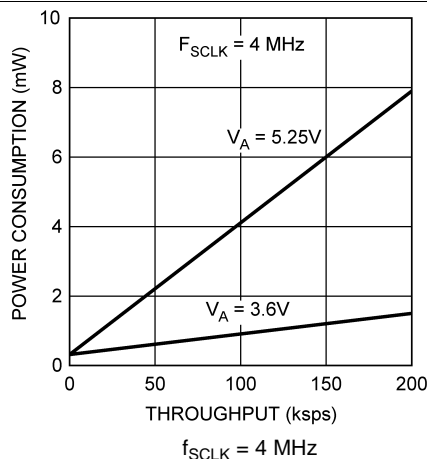

Figure 11. Power Consumption vs Throughput

8 Parameter Measurement Information

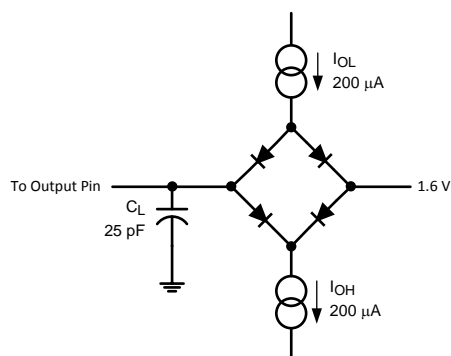

Figure 12. Timing Test Circuit

9 Detailed Description

9.1 Overview

The ADC121S021 is a low-power, single-channel, 12-bit analog-to-digital converter which is based upon a successive-approximation register architecture with an internal track-and-hold circuit. It operates with a single-supply voltage that can range from 2.7 V to 5.25 V. The ADC121S021 is packaged in 6-pin WSON and SOT-23 package. Operation over the industrial temperature range of -40°C to 85°C is ensured.

9.2 Functional Block Diagram

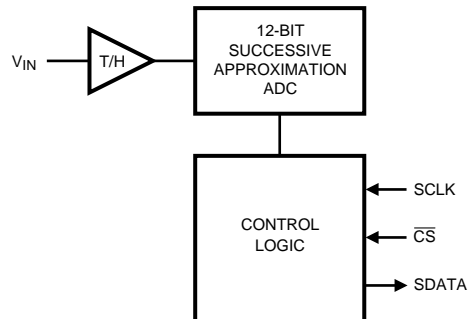

9.3 Feature Description

The ADC121S021 is fully specified over a sample rate range of 50 ksp/s to 200 ksp/s. Normal power consumption of the device using a 3.6-V or 5.25-V supply is 1.5 mW and 7.9 mW, respectively. The power-down feature helps reduce the power consumption to as low as 2.6 μW using a 5.25-V supply. The output serial data is straight binary, and is compatible with several standards such as SPI, QSPI, MICROWIRE, and many common DSP serial interfaces.

9.4 Device Functional Modes

The ADC has two possible modes of operation: normal mode, and shutdown mode. The ADC enters normal mode (and a conversion process is begun) when $\overline{\text{CS}}$ is pulled low. The device enters shutdown mode if $\overline{\text{CS}}$ is pulled high before the 10th falling edge of SCLK after $\overline{\text{CS}}$ is pulled low, or stays in normal mode if $\overline{\text{CS}}$ remains low. When in shutdown mode, the device stays there until $\overline{\text{CS}}$ is brought low again. By varying the ratio of time spent in the normal and shutdown modes, a system may trade off throughput for power consumption, with a sample rate as low as zero.

9.4.1 Normal Mode

The fastest possible throughput is obtained by leaving the ADC in normal mode at all times, so there are no power-up delays. To keep the device in normal mode continuously, $\overline{\text{CS}}$ must be kept low until after the 10th falling edge of SCLK after the start of a conversion (remember that a conversion is initiated by bringing $\overline{\text{CS}}$ low).

If $\overline{\text{CS}}$ is brought high after the 10th falling edge, but before the 16th falling edge, the device remains in normal mode, but the current conversion aborts, and SDATA returns to TRI-STATE (truncating the output word).

Sixteen SCLK cycles are required to read all of a conversion word from the device. After sixteen SCLK cycles have elapsed, $\overline{\text{CS}}$ may be idled either high or low until the next conversion. If $\overline{\text{CS}}$ is idled low, it must be brought high again before the start of the next conversion, which begins when $\overline{\text{CS}}$ is again brought low.

After sixteen SCLK cycles, SDATA returns to TRI-STATE. Another conversion may be started, after t_{QUIET} has elapsed, by bringing $\overline{\text{CS}}$ low again.

Device Functional Modes (continued)

9.4.2 Shutdown Mode

Shutdown mode is appropriate for applications that either do not sample continuously, or it is acceptable to trade throughput for power consumption. When the ADC is in shutdown mode, all of the analog circuitry is turned off.

To enter shutdown mode, a conversion must be interrupted by bringing \overline{CS} high anytime between the second and 10th falling edges of SCLK, as shown in Figure 13. Once \overline{CS} has been brought high in this manner, the device enters shutdown mode; the current conversion is aborted and SDATA enters TRI-STATE. If \overline{CS} is brought high before the second falling edge of SCLK, the device does not change mode; this is to avoid accidentally changing mode as a result of noise on the \overline{CS} line.

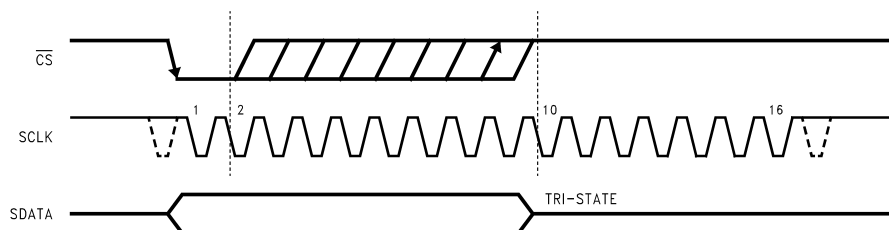

Figure 13. Entering Shutdown Mode

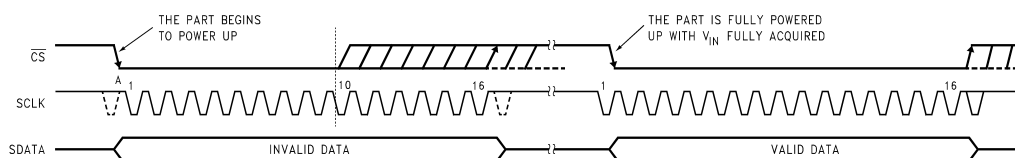

Figure 14. Entering Normal Mode

To exit shutdown mode, bring \overline{CS} back low. Upon bringing \overline{CS} low, the ADC begins powering up (power-up time is specified in [Timing Requirements](#)). This power-up delay results in the first conversion result being unusable. The second conversion performed after power-up, however, is valid, as shown in Figure 14.

If \overline{CS} is brought back high before the 10th falling edge of SCLK, the device returns to shutdown mode. This is done to avoid accidentally entering normal mode as a result of noise on the \overline{CS} line. To exit shutdown mode and remain in normal mode, \overline{CS} must be kept low until after the 10th falling edge of SCLK. The ADC is fully powered up after 16 SCLK cycles.

10 Applications Information

NOTE

Information in the following applications sections is not part of the TI component specification, and TI does not warrant its accuracy or completeness. TI's customers are responsible for determining suitability of components for their purposes. Customers should validate and test their design implementation to confirm system functionality.

10.1 Application Information

The ADC121S021 is a successive-approximation analog-to-digital converter designed around a charge-redistribution digital-to-analog converter core. Simplified schematics of the ADC121S021 in both track and hold modes are shown in Figure 15 and Figure 16, respectively. In Figure 15, the device is in track mode: switch SW1 connects the sampling capacitor to the input, and SW2 balances the comparator inputs. The device is in this state until \overline{CS} is brought low, at which point the device moves to the hold mode.

Figure 16 shows the device in hold mode: switch SW1 connects the sampling capacitor to ground, maintaining the sampled voltage, and switch SW2 unbalances the comparator. The control logic then instructs the charge-redistribution DAC to add or subtract fixed amounts of charge from the sampling capacitor until the comparator is balanced. When the comparator is balanced, the digital word supplied to the DAC is the digital representation of the analog input voltage. The device moves from hold mode to track mode on the 13th rising edge of SCLK.

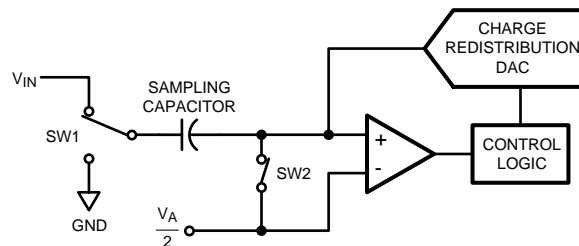

Figure 15. ADC121S021 in Track Mode

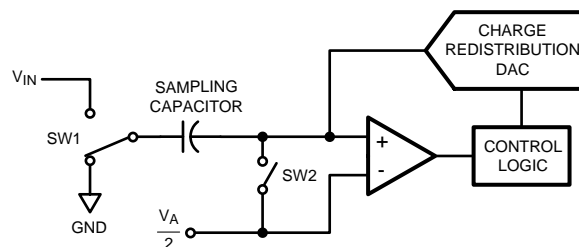

Figure 16. ADC121S021 in Hold Mode

10.1.1 Using the ADC121S021

The serial interface timing diagram for the ADC is shown in Figure 1. \overline{CS} is chip select, which initiates conversions on the ADC and frames the serial data transfers. SCLK (serial clock) controls both the conversion process and the timing of serial data. SDATA is the serial data out pin, where a conversion result is found as a serial data stream.

Basic operation of the ADC begins with \overline{CS} going low, which initiates a conversion process and data transfer. Subsequent rising and falling edges of SCLK is labeled with reference to the falling edge of \overline{CS} ; for example, *the third falling edge of SCLK* shall refer to the third falling edge of SCLK after \overline{CS} goes low.

Application Information (continued)

At the fall of \overline{CS} , the SDATA pin comes out of TRI-STATE, and the converter moves from track mode to hold mode. The input signal is sampled and held for conversion on the falling edge of \overline{CS} . The converter moves from hold mode to track mode on the 13th rising edge of SCLK (see [Figure 1](#)). It is at this point that the interval for the t_{ACQ} specification begins. At least 350 ns must pass between the 13th rising edge of SCLK and the next falling edge of \overline{CS} . The SDATA pin is placed back into TRI-STATE after the 16th falling edge of SCLK, or at the rising edge of \overline{CS} , whichever occurs first. After a conversion is completed, the quiet time (t_{QUIET}) must be satisfied before bringing \overline{CS} low again to begin another conversion.

Sixteen SCLK cycles are required to read a complete sample from the ADC. The sample bits (including leading zeroes) are clocked out on falling edges of SCLK, and are intended to be clocked in by a receiver on subsequent rising edges of SCLK. The ADC produces three leading zero bits on SDATA, followed by twelve data bits, most significant first.

If \overline{CS} goes low before the rising edge of SCLK, an additional (fourth) zero bit may be captured by the next falling edge of SCLK.

10.1.1.1 Determining Throughput

Throughput depends on the frequency of SCLK and how much time is allowed to elapse between the end of one conversion and the start of another. At the maximum specified SCLK frequency, the maximum ensured throughput is obtained by using a 20 SCLK frame. As shown in [Figure 1](#), the minimum allowed time between \overline{CS} falling edges is determined by 1) 12.5 SCLKs for Hold mode, 2) the larger of two quantities: either the minimum required time for Track mode (t_{ACQ}) or 2.5 SCLKs to finish reading the result and 3) 0, 1/2 or 1 SCLK padding to ensure an even number of SCLK cycles so there is a falling SCLK edge when \overline{CS} next falls. For example, at the fastest rate for this family of parts, SCLK is 20 MHz and 2.5 SCLKs are 125 ns, so the minimum time between \overline{CS} falling edges is calculated in [Equation 1](#):

$$12.5 \text{ SCLKs} + t_{ACQ} + 1/2 \text{ SCLK} = 12.5 \times 50 \text{ ns} + 350 \text{ ns} + 0.5 \times 50 \text{ ns} = 1000 \text{ ns} \quad (1)$$

Which corresponds to a maximum throughput of 1 MSPS. At the slowest rate for this family, SCLK is 1 MHz. Using a 20 cycle conversion frame as shown in [Figure 1](#) yields a 20 μ s time between \overline{CS} falling edges for a throughput of 50 KSPS.

It is possible, however, to use fewer than 20 clock cycles provided the timing parameters are met. With a 1-MHz SCLK, there are 2500 ns in 2.5 SCLK cycles, which is greater than t_{ACQ} . After the last data bit has come out, the clock needs one full cycle to return to a falling edge. Thus the total time between falling edges of \overline{CS} is $12.5 \times 1 \mu\text{s} + 2.5 \times 1 \mu\text{s} + 1 \times 1 \mu\text{s} = 16 \mu\text{s}$ which is a throughput of 62.5 ksp/s.

Application Information (continued)

10.1.2 ADC121S021 Transfer Function

The output format of the ADC is straight binary. Code transitions occur midway between successive integer LSB values. The LSB width for the ADC is $V_A / 4096$. The ideal transfer characteristic is shown in Figure 17. The transition from an output code of 0000 0000 0000 to a code of 0000 0000 0001 is at $1/2$ LSB, or a voltage of $V_A / 8192$. Other code transitions occur at steps of one LSB.

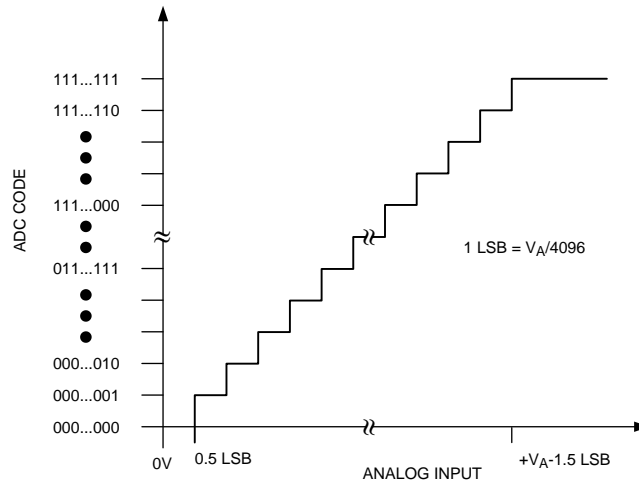

Figure 17. Ideal Transfer Characteristic

10.1.3 Analog Inputs

An equivalent circuit for the ADC's input is shown in Figure 18. Diodes D1 and D2 provide ESD protection for the analog inputs. The analog input must at no time go beyond $(V_A + 300 \text{ mV})$ or $(\text{GND} - 300 \text{ mV})$, as these ESD diodes begins to conduct, which could result in erratic operation. For this reason, the ESD diodes must not be used to clamp the input signal.

The capacitor C1 in Figure 18 has a typical value of 4 pF, and is mainly the package pin capacitance. Resistor R1 is the ON-resistance of the track / hold switch, and is typically 500 Ω . Capacitor C2 is the ADC sampling capacitor and is typically 26 pF. The ADC delivers best performance when driven by a low-impedance source to eliminate distortion caused by the charging of the sampling capacitance. This is especially important when using the ADC to sample AC signals. Also important when sampling dynamic signals is an anti-aliasing filter.

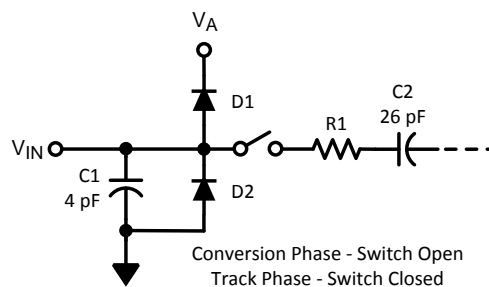

Figure 18. Equivalent Input Circuit

10.1.4 Digital Inputs And Outputs

The ADC digital inputs (SCLK and $\overline{\text{CS}}$) are not limited by the same maximum ratings as the analog inputs. The digital input pins are instead limited to 5.25 V with respect to GND, regardless of V_A , the supply voltage. This allows the ADC to be interfaced with a wide range of logic levels, independent of the supply voltage.

Application Information (continued)

10.1.5 Power Management

The ADC takes time to power-up, either after first applying V_A , or after returning to normal mode from shutdown mode. This corresponds to one dummy conversion for any SCLK frequency within the specifications in this document. After this first dummy conversion, the ADC performs conversions properly.

NOTE

The t_{QUIET} time must still be included between the first dummy conversion and the second valid conversion.

When the V_A supply is first applied, the ADC may power up in either of the two modes: normal or shutdown. As such, one dummy conversion must be performed after start-up, as described in the previous paragraph. The part may then be placed into either normal mode or the shutdown mode, as described in [Normal Mode](#) and [Shutdown Mode](#).

When the ADC is operated continuously in normal mode, the maximum ensured throughput is $f_{\text{SCLK}} / 20$ at the maximum specified f_{SCLK} . Throughput may be traded for power consumption by running f_{SCLK} at its maximum specified rate and performing fewer conversions per unit time, raising the ADC $\overline{\text{CS}}$ line after the 10th and before the 15th fall of SCLK of each conversion. A plot of typical power consumption versus throughput is shown in [Typical Characteristics](#). To calculate the power consumption for a given throughput, multiply the fraction of time spent in the normal mode by the normal mode power consumption and add the fraction of time spent in shutdown mode multiplied by the shutdown mode power consumption.

NOTE

The curve of power consumption vs throughput is essentially linear. This is because the power consumption in the shutdown mode is so small that it can be ignored for all practical purposes.

10.2 Typical Application

A typical application of the ADC is shown in [Figure 19](#). Power is provided in this example by the Texas Instruments LP2950 low-dropout voltage regulator, available in a variety of fixed and adjustable output voltages. The power supply pin is bypassed with a capacitor network located close to the ADC. Because the reference for the ADC is the supply voltage, any noise on the supply degrades the noise performance of the device. To keep noise off the supply, use a dedicated linear regulator for this device, or provide sufficient decoupling from other circuitry to keep noise off the ADC supply pin. Because of the ADC's low power requirements, it is also possible to use a precision reference as a power supply to maximize performance. The three-wire interface is shown connected to a microprocessor or DSP.

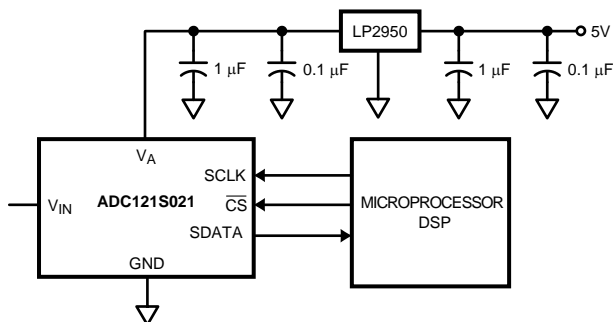

Figure 19. Typical Application Circuit

10.2.1 Design Requirements

A positive supply only data acquisition system capable of digitizing signals ranging from 0 V to 5 V and interfacing through SPI with an MCU whose supply is set at 3.3 V.

Typical Application (continued)

10.2.2 Detailed Design Procedure

The signal range requirement forces the design to use 5-V analog supply at V_A , analog supply. This follows from the fact that V_A is also a reference potential for the ADC.

Sampling is in fact a modulation process which may result in aliasing of the input signal if the input signal is not adequately band limited. The maximum sampling rate (f_S) of the ADC121S021 when it is enabled is:

$$f_S = f_{SCLK} / 16 \tag{2}$$

In order to avoid aliasing, the Nyquist criterion has to be met:

$$BW_{signal} < f_S / 2 \tag{3}$$

Therefore it is necessary to place an anti-aliasing filter at the input of the ADC. This filter may be a single-pole low-pass filter. The pole location need to satisfy Equation 4:

$$1 / (\pi \times R \times C) < f_{SCLK} / 16 \tag{4}$$

With $f_{SCLK} = 4$ MHz, a good choice for the single pole filter is:

- $R = 100 \Omega$
- $C = nF$

This reduces the input $BW_{signal} = 250$ kHz. The capacitor at the V_{IN} input of the device provides not only the filtering of the input signal, but it also absorbs the charge kick-back from the ADC. The kick-back is the result of the internal switches opening at the end of the acquisition period.

Take care when the signal source is capable of producing voltages beyond V_A . In such instances the internal ESD diodes may start conducting. The ESD diodes are not intended as input signal clamps. To provide the desired clamping action use Schottky diodes.

10.2.3 Application Curves

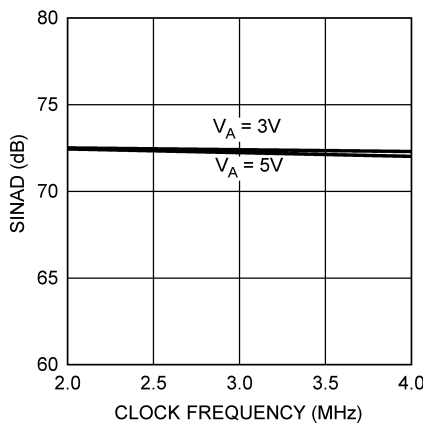

Figure 20. SINAD vs Clock Frequency

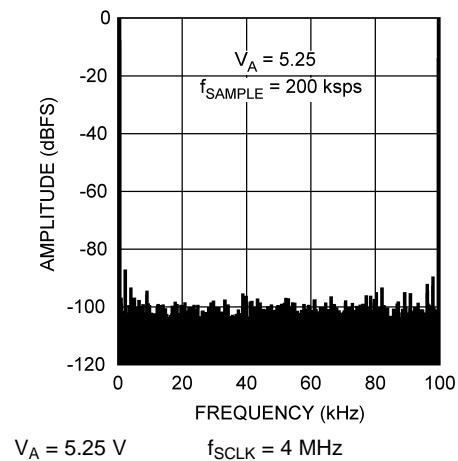

Figure 21. Spectral Response

11 Power Supply Recommendations

The ADC requires a single voltage supply within 2.7 V and 5.25 V.

11.1 Power Supply Noise Considerations

The charging of any output load capacitance requires current from the power supply, V_A . The current pulses required from the supply to charge the output capacitance causes voltage variations on the supply. If these variations are large enough, they could degrade SNR and SINAD performance of the ADC. Furthermore, discharging the output capacitance when the digital output goes from a logic high to a logic low dumps current into the die substrate, which is resistive. Load discharge currents causes *ground bounce* noise in the substrate that degrades noise performance if that current is large enough. The larger the output capacitance, the more current flows through the die substrate and the greater is the noise coupled into the analog channel, degrading noise performance.

To keep noise out of the power supply, keep the output load capacitance as small as practical. It is good practice to use a 100- Ω series resistor at the ADC output, located as close to the ADC output pin as practical. This limits the charge and discharge current of the output capacitance and improve noise performance.

12 Layout

12.1 Layout Guidelines

Ground must be a low impedance connection for return currents to flow undisturbed back to their respective sources. Keep connections to the ground plane as short and direct as possible. When using vias to connect to the ground layer, use multiple vias in parallel to reduce impedance to ground.

A mixed-signal layout sometimes incorporates separate analog and digital ground planes that are tied together at one location; however, separating the ground planes is not necessary when analog, digital, and power supply circuitry into different PCB regions to prevent digital return currents from coupling into sensitive analog circuitry.

For best performance, dedicate an entire PCB layer to a ground plane and do not route any other signal traces on this layer. If ground plane separation is necessary, then make the connection at the ADC. Do not connect individual ground planes at multiple locations because this configuration creates ground loops. A single plane for analog and digital ground avoids ground loops.

If isolation is required in the application, isolate the digital signals between the ADC and controller, or provide the isolation from the controller to the remaining system. If an external crystal is used to provide the ADC clock, place the crystal and load capacitors directly to the ADC pins using short direct traces.

Supply pins must be bypassed with a low-ESR ceramic capacitor. Place the bypass capacitors as close as possible to the supply pins using short, direct traces. For optimum performance, use low-impedance connections on the ground-side connections of the bypass capacitors. Flow the supply current through the bypass capacitor pin first and then to the supply pin to make the bypassing most effective (also known as a Kelvin connection). If multiple ADCs are on the same PCB, use wide power supply traces or dedicated power-supply planes to minimize the potential of crosstalk between ADCs.

It is important that the SCLK input of the serial interface is free from noise and glitches. Even with relatively slow SCLK frequencies, short digital-signal rise and fall times may cause excessive ringing and noise. For best performance, keep the digital signal traces short, use termination resistors as needed, and ensure all digital signals are routed directly above the ground plane with minimal use of vias.

12.2 Layout Example

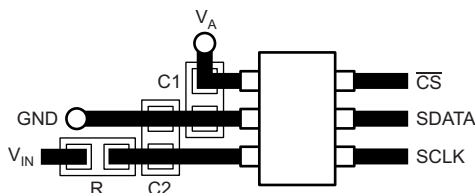

Figure 22. ADC121S021 Layout Example

13 Device and Documentation Support

13.1 Device Support

13.1.1 Device Nomenclature

ACQUISITION TIME The time required to acquire the input voltage. That is, it is time required for the hold capacitor to charge up to the input voltage. Acquisition time is measured backwards from the falling edge of \overline{CS} when the signal is sampled and the part moves from track to hold. The start of the time interval that contains t_{ACQ} is the 13th rising edge of SCLK of the previous conversion when the part moves from hold to track. The user must ensure that the time between the 13th rising edge of SCLK and the falling edge of the next \overline{CS} is not less than t_{ACQ} to meet performance specifications.

APERTURE DELAY The time after the falling edge of \overline{CS} to when the input signal is acquired or held for conversion.

APERTURE JITTER (APERTURE UNCERTAINTY) The variation in aperture delay from sample to sample. Aperture jitter manifests itself as noise in the output.

CONVERSION TIME The time required, after the input voltage is acquired, for the ADC to convert the input voltage to a digital word. This is from the falling edge of \overline{CS} when the input signal is sampled to the 16th falling edge of SCLK when the SDATA output goes into TRI-STATE.

DIFFERENTIAL NON-LINEARITY (DNL) The measure of the maximum deviation from the ideal step size of 1 LSB.

DUTY CYCLE The ratio of the time that a repetitive digital waveform is high to the total time of one period. The specification here refers to the SCLK.

EFFECTIVE NUMBER OF BITS (ENOB, or EFFECTIVE BITS) Another method of specifying Signal-to-Noise and Distortion or SINAD. ENOB is defined as $(SINAD - 1.76) / 6.02$ and says that the converter is equivalent to a perfect ADC of this (ENOB) number of bits.

FULL POWER BANDWIDTH A measure of the frequency at which the reconstructed output fundamental drops 3 dB below its low frequency value for a full scale input.

GAIN ERROR The deviation of the last code transition (111...110) to (111...111) from the ideal ($V_{REF} - 1.5$ LSB), after adjusting for offset error.

INTEGRAL NON-LINEARITY (INL) A measure of the deviation of each individual code from a line drawn from negative full scale ($\frac{1}{2}$ LSB below the first code transition) through positive full scale ($\frac{1}{2}$ LSB above the last code transition). The deviation of any given code from this straight line is measured from the center of that code value.

INTERMODULATION DISTORTION (IMD) The creation of additional spectral components as a result of two sinusoidal frequencies being applied to the ADC input at the same time. It is defined as the ratio of the power in the second and third order intermodulation products to the sum of the power in both of the original frequencies. IMD is usually expressed in dB.

MISSING CODES Output codes that never appears at the ADC outputs. The ADC121S021 is ensured not to have any missing codes.

OFFSET ERROR The deviation of the first code transition (000...000) to (000...001) from the ideal (i.e. GND + 0.5 LSB).

SIGNAL TO NOISE RATIO (SNR) The ratio, expressed in dB, of the rms value of the input signal to the rms value of the sum of all other spectral components below one-half the sampling frequency, not including harmonics or DC

SIGNAL TO NOISE PLUS DISTORTION (S/N+D or SINAD) The ratio, expressed in dB, of the rms value of the input signal to the rms value of all of the other spectral components below half the clock frequency, including harmonics but excluding DC

Device Support (continued)

SPURIOUS FREE DYNAMIC RANGE (SFDR) The difference, expressed in dB, between the desired signal amplitude to the amplitude of the peak spurious spectral component, where a spurious spectral component is any signal present in the output spectrum that is not present at the input and may or may not be a harmonic.

TOTAL HARMONIC DISTORTION (THD) The ratio, expressed in dB or dBc, of the rms total of the first five harmonic components at the output to the rms level of the input signal frequency as seen at the output. THD is calculated as:

$$\text{THD} = 20 \cdot \log_{10} \sqrt{\frac{A_{f_2}^2 + \dots + A_{f_6}^2}{A_{f_1}^2}}$$

where

- A_{f_1} is the RMS power of the input frequency at the output
 - A_{f_2} through A_{f_6} are the RMS power in the first 5 harmonic frequencies
- (5)

THROUGHPUT TIME The minimum time required between the start of two successive conversion. It is the acquisition time plus the conversion time.

13.2 Community Resources

The following links connect to TI community resources. Linked contents are provided "AS IS" by the respective contributors. They do not constitute TI specifications and do not necessarily reflect TI's views; see TI's [Terms of Use](#).

TI E2E™ Online Community *TI's Engineer-to-Engineer (E2E) Community*. Created to foster collaboration among engineers. At e2e.ti.com, you can ask questions, share knowledge, explore ideas and help solve problems with fellow engineers.

Design Support *TI's Design Support* Quickly find helpful E2E forums along with design support tools and contact information for technical support.

13.3 Trademarks

SPI, QSPI, E2E are trademarks of Texas Instruments.
 TRI-STATE is a registered trademark of Texas Instruments.
 All other trademarks are the property of their respective owners.

13.4 Electrostatic Discharge Caution



These devices have limited built-in ESD protection. The leads should be shorted together or the device placed in conductive foam during storage or handling to prevent electrostatic damage to the MOS gates.

13.5 Glossary

SLYZ022 — *TI Glossary*.

This glossary lists and explains terms, acronyms, and definitions.

14 Mechanical, Packaging, and Orderable Information

The following pages include mechanical, packaging, and orderable information. This information is the most current data available for the designated devices. This data is subject to change without notice and revision of this document. For browser-based versions of this data sheet, refer to the left-hand navigation.

PACKAGING INFORMATION

Orderable Device	Status (1)	Package Type	Package Drawing	Pins	Package Qty	Eco Plan (2)	Lead finish/ Ball material (6)	MSL Peak Temp (3)	Op Temp (°C)	Device Marking (4/5)	Samples
ADC121S021CIMF/NOPB	ACTIVE	SOT-23	DBV	6	1000	RoHS & Green	SN	Level-1-260C-UNLIM	-40 to 85	X07C	Samples
ADC121S021CIMFX/NOPB	ACTIVE	SOT-23	DBV	6	3000	RoHS & Green	SN	Level-1-260C-UNLIM	-40 to 85	X07C	Samples
ADC121S021CISD/NOPB	ACTIVE	WSON	NGF	6	1000	RoHS & Green	SN	Level-1-260C-UNLIM	-40 to 85	X7C	Samples
ADC121S021CISDX/NOPB	ACTIVE	WSON	NGF	6	4500	RoHS & Green	SN	Level-1-260C-UNLIM	-40 to 85	X7C	Samples

(1) The marketing status values are defined as follows:

ACTIVE: Product device recommended for new designs.

LIFEBUY: TI has announced that the device will be discontinued, and a lifetime-buy period is in effect.

NRND: Not recommended for new designs. Device is in production to support existing customers, but TI does not recommend using this part in a new design.

PREVIEW: Device has been announced but is not in production. Samples may or may not be available.

OBSELETE: TI has discontinued the production of the device.

(2) **RoHS:** TI defines "RoHS" to mean semiconductor products that are compliant with the current EU RoHS requirements for all 10 RoHS substances, including the requirement that RoHS substance do not exceed 0.1% by weight in homogeneous materials. Where designed to be soldered at high temperatures, "RoHS" products are suitable for use in specified lead-free processes. TI may reference these types of products as "Pb-Free".

RoHS Exempt: TI defines "RoHS Exempt" to mean products that contain lead but are compliant with EU RoHS pursuant to a specific EU RoHS exemption.

Green: TI defines "Green" to mean the content of Chlorine (Cl) and Bromine (Br) based flame retardants meet JS709B low halogen requirements of <=1000ppm threshold. Antimony trioxide based flame retardants must also meet the <=1000ppm threshold requirement.

(3) MSL, Peak Temp. - The Moisture Sensitivity Level rating according to the JEDEC industry standard classifications, and peak solder temperature.

(4) There may be additional marking, which relates to the logo, the lot trace code information, or the environmental category on the device.

(5) Multiple Device Markings will be inside parentheses. Only one Device Marking contained in parentheses and separated by a "-" will appear on a device. If a line is indented then it is a continuation of the previous line and the two combined represent the entire Device Marking for that device.

(6) Lead finish/Ball material - Orderable Devices may have multiple material finish options. Finish options are separated by a vertical ruled line. Lead finish/Ball material values may wrap to two lines if the finish value exceeds the maximum column width.

Important Information and Disclaimer:The information provided on this page represents TI's knowledge and belief as of the date that it is provided. TI bases its knowledge and belief on information provided by third parties, and makes no representation or warranty as to the accuracy of such information. Efforts are underway to better integrate information from third parties. TI has taken and

continues to take reasonable steps to provide representative and accurate information but may not have conducted destructive testing or chemical analysis on incoming materials and chemicals. TI and TI suppliers consider certain information to be proprietary, and thus CAS numbers and other limited information may not be available for release.

In no event shall TI's liability arising out of such information exceed the total purchase price of the TI part(s) at issue in this document sold by TI to Customer on an annual basis.

TAPE AND REEL INFORMATION

QUADRANT ASSIGNMENTS FOR PIN 1 ORIENTATION IN TAPE

*All dimensions are nominal

Device	Package Type	Package Drawing	Pins	SPQ	Reel Diameter (mm)	Reel Width W1 (mm)	A0 (mm)	B0 (mm)	K0 (mm)	P1 (mm)	W (mm)	Pin1 Quadrant
ADC121S021CIMF/NOPB	SOT-23	DBV	6	1000	178.0	8.4	3.2	3.2	1.4	4.0	8.0	Q3
ADC121S021CIMFX/NOPB	SOT-23	DBV	6	3000	178.0	8.4	3.2	3.2	1.4	4.0	8.0	Q3
ADC121S021CISD/NOPB	WSON	NGF	6	1000	178.0	12.4	2.8	2.5	1.0	8.0	12.0	Q1
ADC121S021CISDX/NOPB	WSON	NGF	6	4500	330.0	12.4	2.8	2.5	1.0	8.0	12.0	Q1

TAPE AND REEL BOX DIMENSIONS

*All dimensions are nominal

Device	Package Type	Package Drawing	Pins	SPQ	Length (mm)	Width (mm)	Height (mm)
ADC121S021CIMF/NOPB	SOT-23	DBV	6	1000	210.0	185.0	35.0
ADC121S021CIMFX/ NOPB	SOT-23	DBV	6	3000	210.0	185.0	35.0
ADC121S021CISD/NOPB	WSON	NGF	6	1000	210.0	185.0	35.0
ADC121S021CISDX/ NOPB	WSON	NGF	6	4500	367.0	367.0	35.0

DBV0006A



PACKAGE OUTLINE

SOT-23 - 1.45 mm max height

SMALL OUTLINE TRANSISTOR



NOTES:

1. All linear dimensions are in millimeters. Any dimensions in parenthesis are for reference only. Dimensioning and tolerancing per ASME Y14.5M.
2. This drawing is subject to change without notice.
3. Body dimensions do not include mold flash or protrusion. Mold flash and protrusion shall not exceed 0.25 per side.
4. Leads 1,2,3 may be wider than leads 4,5,6 for package orientation.
5. Reference JEDEC MO-178.

EXAMPLE BOARD LAYOUT

DBV0006A

SOT-23 - 1.45 mm max height

SMALL OUTLINE TRANSISTOR



LAND PATTERN EXAMPLE
EXPOSED METAL SHOWN
SCALE:15X

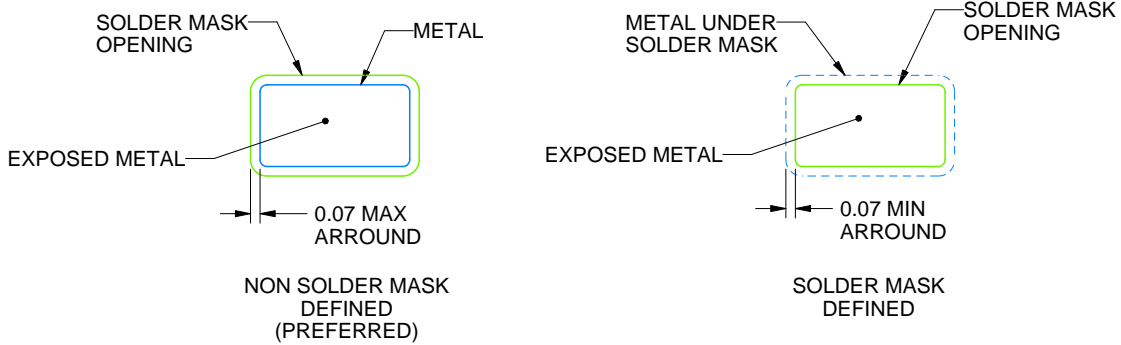

SOLDER MASK DETAILS

4214840/F 05/2024

NOTES: (continued)

- 6. Publication IPC-7351 may have alternate designs.
- 7. Solder mask tolerances between and around signal pads can vary based on board fabrication site.

EXAMPLE STENCIL DESIGN

DBV0006A

SOT-23 - 1.45 mm max height

SMALL OUTLINE TRANSISTOR



SOLDER PASTE EXAMPLE
BASED ON 0.125 mm THICK STENCIL
SCALE:15X

4214840/F 05/2024

NOTES: (continued)

8. Laser cutting apertures with trapezoidal walls and rounded corners may offer better paste release. IPC-7525 may have alternate design recommendations.
9. Board assembly site may have different recommendations for stencil design.

NGF0006A

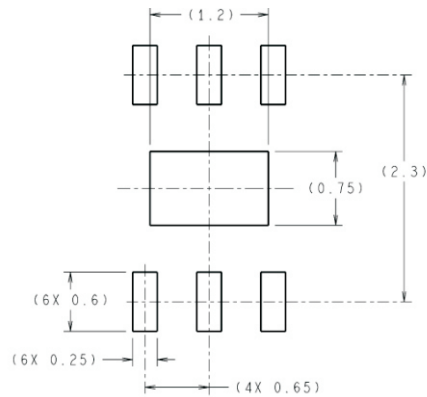

DIMENSIONS ARE IN MILLIMETERS
DIMENSIONS IN () FOR REFERENCE ONLY



RECOMMENDED LAND PATTERN

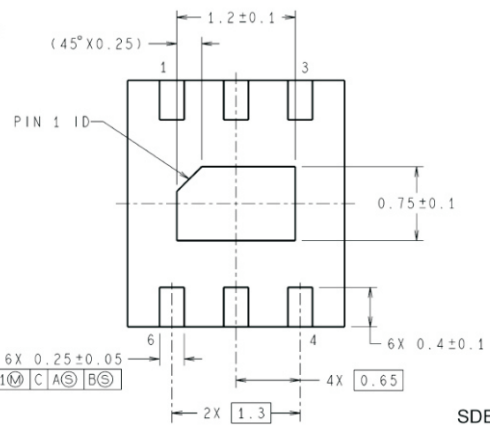
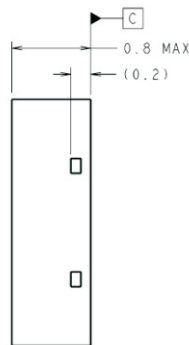
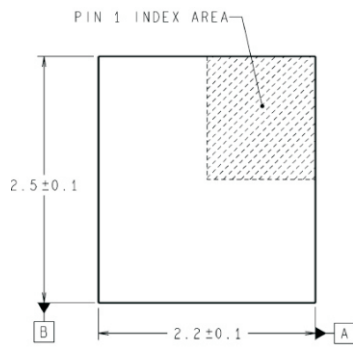

SDB06A (Rev A)

IMPORTANT NOTICE AND DISCLAIMER

TI PROVIDES TECHNICAL AND RELIABILITY DATA (INCLUDING DATA SHEETS), DESIGN RESOURCES (INCLUDING REFERENCE DESIGNS), APPLICATION OR OTHER DESIGN ADVICE, WEB TOOLS, SAFETY INFORMATION, AND OTHER RESOURCES "AS IS" AND WITH ALL FAULTS, AND DISCLAIMS ALL WARRANTIES, EXPRESS AND IMPLIED, INCLUDING WITHOUT LIMITATION ANY IMPLIED WARRANTIES OF MERCHANTABILITY, FITNESS FOR A PARTICULAR PURPOSE OR NON-INFRINGEMENT OF THIRD PARTY INTELLECTUAL PROPERTY RIGHTS.

These resources are intended for skilled developers designing with TI products. You are solely responsible for (1) selecting the appropriate TI products for your application, (2) designing, validating and testing your application, and (3) ensuring your application meets applicable standards, and any other safety, security, regulatory or other requirements.

These resources are subject to change without notice. TI grants you permission to use these resources only for development of an application that uses the TI products described in the resource. Other reproduction and display of these resources is prohibited. No license is granted to any other TI intellectual property right or to any third party intellectual property right. TI disclaims responsibility for, and you will fully indemnify TI and its representatives against, any claims, damages, costs, losses, and liabilities arising out of your use of these resources.

TI's products are provided subject to [TI's Terms of Sale](#) or other applicable terms available either on [ti.com](https://www.ti.com) or provided in conjunction with such TI products. TI's provision of these resources does not expand or otherwise alter TI's applicable warranties or warranty disclaimers for TI products.

TI objects to and rejects any additional or different terms you may have proposed.

Mailing Address: Texas Instruments, Post Office Box 655303, Dallas, Texas 75265
Copyright © 2024, Texas Instruments Incorporated