

# ADC12L066 12-Bit, 66 MSPS, 450 MHz Bandwidth A/D Converter with Internal Sample-and-Hold

Check for Samples: [ADC12L066](#)

## FEATURES

- Single Supply Operation
- Low Power Consumption
- Power Down Mode
- On-Chip Reference Buffer

## APPLICATIONS

- Ultrasound and Imaging
- Instrumentation
- Cellular Base Stations/Communications Receivers
- Sonar/Radar
- xDSL
- Wireless Local Loops
- Data Acquisition Systems
- DSP Front Ends

## KEY SPECIFICATIONS

- Resolution: 12 Bits
- Conversion Rate: 66 Msps
- Full Power Bandwidth: 450 MHz
- DNL:  $\pm 0.4$  LSB (typ)
- SNR ( $f_{IN} = 10$  MHz): 66 dB (typ)
- SFDR ( $f_{IN} = 10$  MHz): 80 dB (typ)
- Data Latency: 6 Clock Cycles
- Supply Voltage:  $+3.3V \pm 300$  mV
- Power Consumption, 66 MHz: 357 mW (typ)

## DESCRIPTION

The ADC12L066 is a monolithic CMOS analog-to-digital converter capable of converting analog input signals into 12-bit digital words at 66 Megasamples per second (Msps), minimum, with typical operation possible up to 80 Msps. This converter uses a differential, pipeline architecture with digital error correction and an on-chip sample-and-hold circuit to minimize die size and power consumption while providing excellent dynamic performance. A unique sample-and-hold stage yields a full-power bandwidth of 450 MHz. Operating on a single 3.3V power supply, this device consumes just 357 mW at 66 Msps, including the reference current. The Power Down feature reduces power consumption to just 50 mW.

The differential inputs provide a full scale input swing equal to  $\pm V_{REF}$  with the possibility of a single-ended input. Full use of the differential input is recommended for optimum performance. For ease of use, the buffered, high impedance, single-ended reference input is converted on-chip to a differential reference for use by the processing circuitry. Output data format is 12-bit offset binary.

This device is available in the 32-lead LQFP package and will operate over the industrial temperature range of  $-40^{\circ}\text{C}$  to  $+85^{\circ}\text{C}$ . An evaluation board is available to facilitate the evaluation process.



These devices have limited built-in ESD protection. The leads should be shorted together or the device placed in conductive foam during storage or handling to prevent electrostatic damage to the MOS gates.



Please be aware that an important notice concerning availability, standard warranty, and use in critical applications of Texas Instruments semiconductor products and disclaimers thereto appears at the end of this data sheet.

TRI-STATE is a registered trademark of National Semiconductor Corporation.  
All other trademarks are the property of their respective owners.

### Connection Diagram

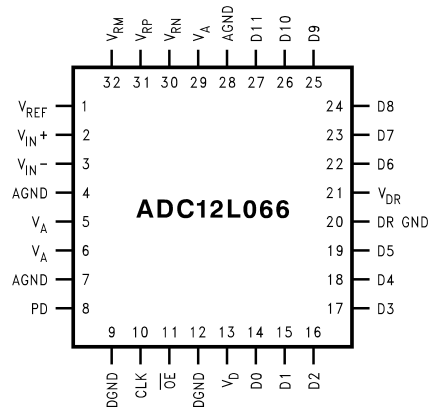

### Block Diagram

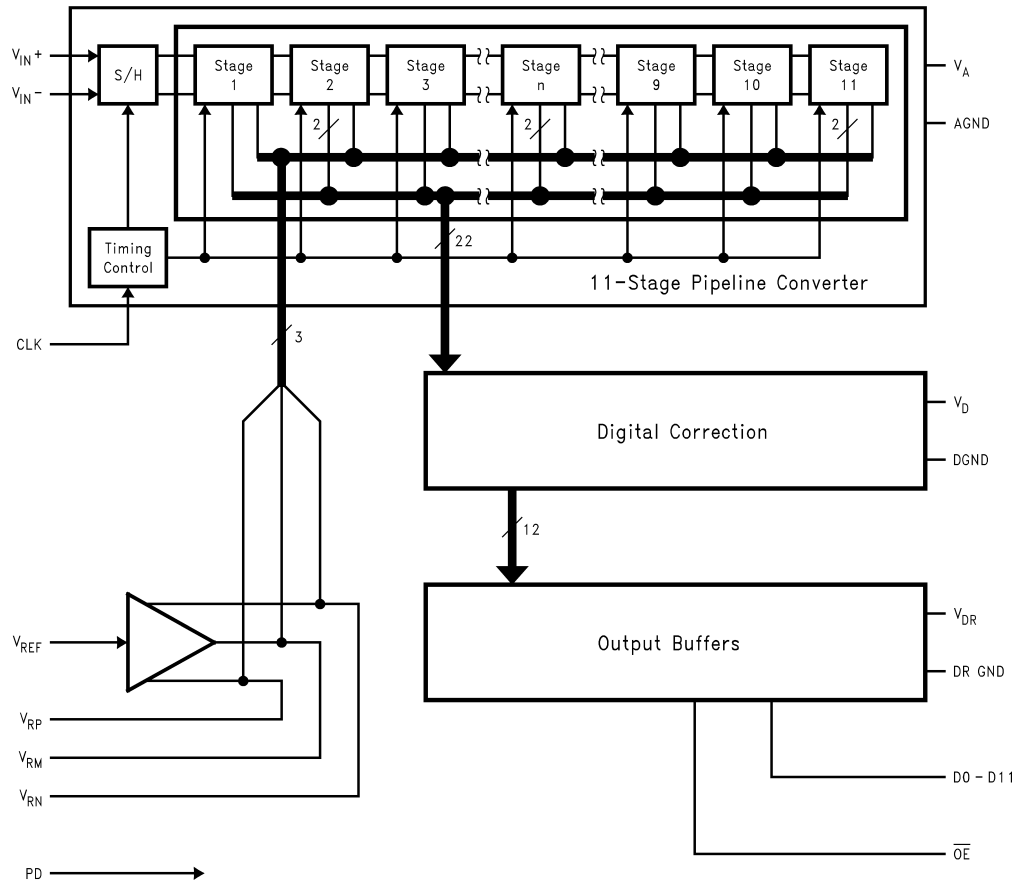

PIN DESCRIPTIONS and EQUIVALENT CIRCUITS

| Pin No.            | Symbol          | Equivalent Circuit | Description   |
|--------------------|-----------------|--------------------|---|
| <b>ANALOG I/O</b>  |                 |                    |   |
| 2                  | $V_{IN}^+$      |                    | Analog signal Input pins. With a 1.0V reference voltage the differential input signal level is 2.0 V <sub>P-P</sub> . The $V_{IN}^-$ pin may be connected to $V_{CM}$ for single-ended operation, but a differential input signal is required for best performance. |
| 3                  | $V_{IN}^-$      |                    |   |
| 1                  | $V_{REF}$       |                    | Reference input. This pin should be bypassed to AGND with a 0.1 $\mu$ F monolithic capacitor. $V_{REF}$ is 1.0V nominal and should be between 0.8V and 1.5V.  |
| 31                 | $V_{RP}$        |                    | These pins are high impedance reference bypass pins. Connect a 0.1 $\mu$ F capacitor from each of these pins to AGND. DO NOT LOAD these pins.   |
| 32                 | $V_{RM}$        |                    |   |
| 30                 | $V_{RN}$        |                    |   |
| <b>DIGITAL I/O</b> |                 |                    |   |
| 10                 | CLK             |                    | Digital clock input. The range of frequencies for this input is 1 MHz to 80 MHz (typical) with specified performance at 66 MHz. The input is sampled on the rising edge of this input.  |
| 11                 | $\overline{OE}$ |                    | $\overline{OE}$ is the output enable pin that, when low, enables the TRI-STATE <sup>®</sup> data output pins. When this pin is high, the outputs are in a high impedance state.   |
| 8                  | PD              |                    | PD is the Power Down input pin. When high, this input puts the converter into the power down mode. When this pin is low, the converter is in the active mode.   |

**PIN DESCRIPTIONS and EQUIVALENT CIRCUITS (continued)**

| Pin No.              | Symbol   | Equivalent Circuit | Description   |
|----------------------|----------|--------------------|---|
| 14–19,<br>22–27      | D0–D11   |                    | Digital data output pins that make up the 12-bit conversion results. D0 is the LSB, while D11 is the MSB of the offset binary output word.  |
| <b>ANALOG POWER</b>  |          |                    |   |
| 5, 6, 29             | $V_A$    |                    | Positive analog supply pins. These pins should be connected to a quiet +3.3V source and bypassed to AGND with 0.1 $\mu$ F monolithic capacitors located within 1 cm of these power pins, and with a 10 $\mu$ F capacitor.   |
| 4, 7, 28             | AGND     |                    | The ground return for the analog supply.  |
| <b>DIGITAL POWER</b> |          |                    |   |
| 13                   | $V_D$    |                    | Positive digital supply pin. This pin should be connected to the same quiet +3.3V source as is $V_A$ and bypassed to DGND with a 0.1 $\mu$ F monolithic capacitor in parallel with a 10 $\mu$ F capacitor, both located within 1 cm of the power pin.   |
| 9, 12                | DGND     |                    | The ground return for the digital supply.   |
| 21                   | $V_{DR}$ |                    | Positive digital supply pin for the ADC12L066's output drivers. This pin should be connected to a voltage source of +1.8V to $V_D$ and bypassed to DR GND with a 0.1 $\mu$ F monolithic capacitor. If the supply for this pin is different from the supply used for $V_A$ and $V_D$ , it should also be bypassed with a 10 $\mu$ F tantalum capacitor. The voltage at this pin should never exceed the voltage on $V_D$ by more than 300 mV. All bypass capacitors should be located within 1 cm of the supply pin. |
| 20                   | DR GND   |                    | The ground return for the digital supply for the ADC12L066's output drivers. This pin should be connected to the system digital ground, but not be connected in close proximity to the ADC12L066's DGND or AGND pins. See <a href="#">Layout and Grounding</a> for more details.  |

**Absolute Maximum Ratings<sup>(1)(2)(3)</sup>**

|   |                                 |                                  |
|---|---------------------------------|----------------------------------|
| $V_A, V_D, V_{DR}$                                      |                                 | 4.2V                             |
| $ V_A - V_D $   |                                 | $\leq 100$ mV                    |
| Voltage on Any Pin                                      |                                 | -0.3V to ( $V_A$ or $V_D$ +0.3V) |
| Input Current at Any Pin <sup>(4)</sup>                 |                                 | $\pm 25$ mA                      |
| Package Input Current <sup>(4)</sup>                    |                                 | $\pm 50$ mA                      |
| Package Dissipation at $T_A = 25^\circ\text{C}$         |                                 | See <sup>(5)</sup>               |
| ESD Susceptibility                                      | Human Body Model <sup>(6)</sup> | 2500V                            |
|   | Machine Model <sup>(6)</sup>    | 250V                             |
| Soldering Temperature, Infrared, 10 sec. <sup>(7)</sup> |                                 | 235°C                            |
| Storage Temperature                                     |                                 | -65°C to +150°C                  |

- (1) All voltages are measured with respect to GND = AGND = DGND = 0V, unless otherwise specified.
- (2) Absolute Maximum Ratings indicate limits beyond which damage to the device may occur. Operating Ratings indicate conditions for which the device is functional, but do not ensure specific performance limits. For ensured specifications and test conditions, see the Electrical Characteristics. The ensured specifications apply only for the test conditions listed. Some performance characteristics may degrade when the device is not operated under the listed test conditions.
- (3) If Military/Aerospace specified devices are required, please contact the Texas Instruments Sales Office/ Distributors for availability and specifications.
- (4) When the input voltage at any pin exceeds the power supplies (that is,  $V_{IN} < \text{AGND}$ , or  $V_{IN} > V_A, V_D$  or  $V_{DR}$ ), the current at that pin should be limited to 25 mA. The 50 mA maximum package input current rating limits the number of pins that can safely exceed the power supplies with an input current of 25 mA to two.
- (5) The absolute maximum junction temperature ( $T_{Jmax}$ ) for this device is 150°C. The maximum allowable power dissipation is dictated by  $T_{Jmax}$ , the junction-to-ambient thermal resistance ( $\theta_{JA}$ ), and the ambient temperature, ( $T_A$ ), and can be calculated using the formula  $P_{DMAX} = (T_{Jmax} - T_A) / \theta_{JA}$ . The values for maximum power dissipation will be reached only when the device is operated in a severe fault condition (e.g. when input or output pins are driven beyond the power supply voltages, or the power supply polarity is reversed). Obviously, such conditions should always be avoided.
- (6) Human body model is 100 pF capacitor discharged through a 1.5 k $\Omega$  resistor. Machine model is 220 pF discharged through 0 $\Omega$ .
- (7) The 235°C reflow temperature refers to infrared reflow. For Vapor Phase Reflow (VPR), the following Conditions apply: Maintain the temperature at the top of the package body above 183°C for a minimum 60 seconds. The temperature measured on the package body must not exceed 220°C. Only one excursion above 183°C is allowed per reflow cycle.

**Operating Ratings<sup>(1)(2)</sup>**

|                                   |  |   |
|-----------------------------------|--|---|
| Operating Temperature             |  | $-40^\circ\text{C} \leq T_A \leq +85^\circ\text{C}$ |
| Supply Voltage ( $V_A, V_D$ )     |  | +3.0V to +3.60V                                     |
| Output Driver Supply ( $V_{DR}$ ) |  | +1.8V to $V_D$                                      |
| $V_{REF}$ Input                   |  | 0.8V to 1.5V  |
| CLK, PD, $\overline{OE}$          |  | -0.05V to ( $V_D$ + 0.05V)                          |
| $V_{IN}$ Input                    |  | -0V to ( $V_A$ - 0.5V)                              |
| $V_{CM}$                          |  | 0.5V to ( $V_A$ - 1.5V)                             |
| $ AGND - DGND $                   |  | $\leq 100$ mV                                       |

- (1) Absolute Maximum Ratings indicate limits beyond which damage to the device may occur. Operating Ratings indicate conditions for which the device is functional, but do not ensure specific performance limits. For ensured specifications and test conditions, see the Electrical Characteristics. The ensured specifications apply only for the test conditions listed. Some performance characteristics may degrade when the device is not operated under the listed test conditions.
- (2) All voltages are measured with respect to GND = AGND = DGND = 0V, unless otherwise specified.

**Package Thermal Resistances**

| Package      | $\theta_{JA}$ |
|--------------|---------------|
| 32-Lead LQFP | 79°C / W      |

### Converter Electrical Characteristics

Unless otherwise specified, the following specifications apply for AGND = DGND = DR GND = 0V,  $V_A = V_D = +3.3V$ ,  $V_{DR} = +2.5V$ ,  $PD = 0V$ ,  $V_{REF} = +1.0V$ ,  $V_{CM} = 1.0V$ ,  $f_{CLK} = 66\text{ MHz}$ ,  $t_r = t_f = 2\text{ ns}$ ,  $C_L = 15\text{ pF/pin}$ . **Boldface limits apply for  $T_J = T_{MIN}$  to  $T_{MAX}$** : all other limits  $T_J = 25^\circ C$  <sup>(1)(2)(3)(4)</sup>

| Symbol  | Parameter                                    | Conditions                                   | Typical (4) | Limits (4)                  | Units (Limits)   |    |
|---|--|--|-------------|-----------------------------|------------------|----|
| <b>STATIC CONVERTER CHARACTERISTICS</b>           |  |  |             |                             |                  |    |
|   | Resolution with No Missing Codes             |  |             | <b>12</b>                   | Bits             |    |
| INL   | Integral Non Linearity <sup>(5)</sup>        |  | $\pm 1.2$   | <b>+2.7</b>                 | LSB (max)        |    |
|   |  |  |             | <b>-3</b>                   | LSB (min)        |    |
| DNL   | Differential Non Linearity                   |  | $\pm 0.4$   | <b>+1</b>                   | LSB (max)        |    |
|   |  |  |             | <b>-0.95</b>                | LSB (min)        |    |
| GE  | Gain Error                                   | Positive Error                               | -0.15       | <b><math>\pm 3</math></b>   | %FS (max)        |    |
|   |  | Negative Error                               | +0.4        | <b>+4</b>                   | %FS (max)        |    |
|   |  |  |             | <b>-5</b>                   | %FS (min)        |    |
|   | Offset Error ( $V_{IN+} = V_{IN-}$ )         |  | +0.2        | <b><math>\pm 1.3</math></b> | %FS (max)        |    |
|   | Under Range Output Code                      |  | 0           | <b>0</b>                    |                  |    |
|   | Over Range Output Code                       |  | 4095        | <b>4095</b>                 |                  |    |
| <b>REFERENCE AND ANALOG INPUT CHARACTERISTICS</b> |  |  |             |                             |                  |    |
| $V_{CM}$  | Common Mode Input Voltage                    |  | 1.0         | <b>0.5</b>                  | V (min)          |    |
|   |  |  |             | <b>1.5</b>                  | V (max)          |    |
| $C_{IN}$  | $V_{IN}$ Input Capacitance (each pin to GND) | $V_{IN} + 1.0\text{ Vdc} + 1\text{ V}_{P-P}$ |             | (CLK LOW)                   | 8                | pF |
|   |  |  |             | (CLK HIGH)                  | 7                | pF |
| $V_{REF}$   | Reference Voltage <sup>(6)</sup>             |  | 1.0         | <b>0.8</b>                  | V (min)          |    |
|   |  |  |             | <b>1.5</b>                  | V (max)          |    |
|   | Reference Input Resistance                   |  | 100         |                             | M $\Omega$ (min) |    |

(1) The inputs are protected as shown below. Input voltages above  $V_A$  or below GND will not damage this device, provided current is limited per [Note 4](#) under Absolute Maximum Ratings. However, errors in the A/D conversion can occur if the input goes above  $V_A$  or below GND by more than 100 mV. As an example, if  $V_A$  is 3.3V, the full-scale input voltage must be  $\leq 3.4V$  to ensure accurate conversions.

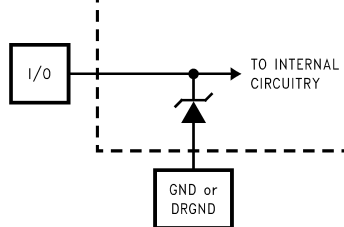

- (2) To ensure accuracy, it is required that  $|V_A - V_D| \leq 100\text{ mV}$  and separate bypass capacitors are used at each power supply pin.
- (3) With the test condition for  $V_{REF} = +1.0V$  (2  $V_{P-P}$  differential input), the 12-bit LSB is 488  $\mu V$ .
- (4) Typical figures are at  $T_A = T_J = 25^\circ C$ , and represent most likely parametric norms. Test limits are specified to TI's AOQL (Average Outgoing Quality Level).
- (5) Integral Non Linearity is defined as the deviation of the analog value, expressed in LSB, from the straight line that passes through positive and negative full-scale.
- (6) Optimum dynamic performance will be obtained by keeping the reference input in the 0.8V to 1.5V range. The LM4051CIM3-ADJ or the LM4051CIM3-1.2 bandgap voltage reference is recommended for this application.

### Converter Electrical Characteristics (continued)

Unless otherwise specified, the following specifications apply for AGND = DGND = DR GND = 0V,  $V_A = V_D = +3.3V$ ,  $V_{DR} = +2.5V$ , PD = 0V,  $V_{REF} = +1.0V$ ,  $V_{CM} = 1.0V$ ,  $f_{CLK} = 66\text{ MHz}$ ,  $t_r = t_f = 2\text{ ns}$ ,  $C_L = 15\text{ pF/pin}$ . **Boldface limits apply for  $T_J = T_{MIN}$  to  $T_{MAX}$** : all other limits  $T_J = 25^\circ\text{C}$  <sup>(1)(2)(3)(4)</sup>

| Symbol  | Parameter                    | Conditions   | Typical<br>(4) | Limits<br>(4) | Units<br>(Limits) |            |
|---|------------------------------|--|----------------|---------------|-------------------|------------|
| <b>DYNAMIC CONVERTER CHARACTERISTICS</b>              |                              |  |                |               |                   |            |
| BW  | Full Power Bandwidth         | 0 dBFS Input, Output at -3 dB                          | 450            |               | MHz               |            |
| SNR   | Signal-to-Noise Ratio        | $f_{IN} = 10\text{ MHz}$ , $V_{IN} = -0.5\text{ dBFS}$ | 85°C           | 66            | 64.6              | dB (min)   |
|   |                              |  | 25°C           |               | 65                | dB (min)   |
|   |                              |  | -40°C          |               | 64.6              | dB (min)   |
|   |                              | $f_{IN} = 25\text{ MHz}$ , $V_{IN} = -0.5\text{ dBFS}$ |                | 65            |                   | dB         |
|   |                              | $f_{IN} = 150\text{ MHz}$ , $V_{IN} = -6\text{ dBFS}$  | 85°C           | 55            | 52                | dB (min)   |
|   |                              |  | 25°C           |               | 54                | dB (min)   |
| -40°C   | 51                           |  | dB (min)       |               |                   |            |
| $f_{IN} = 240\text{ MHz}$ , $V_{IN} = -6\text{ dBFS}$ |                              | 52   |                | dB            |                   |            |
| SINAD   | Signal-to-Noise & Distortion | $f_{IN} = 10\text{ MHz}$ , $V_{IN} = -0.5\text{ dBFS}$ | 85°C           | 66            | 64.3              | dB (min)   |
|   |                              |  | 25°C           |               | 64.8              | dB (min)   |
|   |                              |  | -40°C          |               | 63                | dB (min)   |
|   |                              | $f_{IN} = 25\text{ MHz}$ , $V_{IN} = -0.5\text{ dBFS}$ |                | 64            |                   | dB         |
|   |                              | $f_{IN} = 150\text{ MHz}$ , $V_{IN} = -6\text{ dBFS}$  | 85°C           | 55            | 51.8              | dB (min)   |
|   |                              |  | 25°C           |               | 53.9              | dB (min)   |
| -40°C   | 50                           |  | dB (min)       |               |                   |            |
| $f_{IN} = 240\text{ MHz}$ , $V_{IN} = -6\text{ dBFS}$ |                              | 51   |                | dB            |                   |            |
| ENOB  | Effective Number of Bits     | $f_{IN} = 10\text{ MHz}$ , $V_{IN} = -0.5\text{ dBFS}$ | 85°C           | 10.7          | 10.3              |            |
|   |                              |  | 25°C           |               | 10.5              | Bits (min) |
|   |                              |  | -40°C          |               | 10.2              |            |
|   |                              | $f_{IN} = 25\text{ MHz}$ , $V_{IN} = -0.5\text{ dBFS}$ |                | 10.3          |                   | Bits       |
|   |                              | $f_{IN} = 150\text{ MHz}$ , $V_{IN} = -6\text{ dBFS}$  | 85°C           | 8.8           | 8.3               |            |
|   |                              |  | 25°C           |               | 8.6               | Bits (min) |
| -40°C   | 8.0                          |  |                |               |                   |            |
| $f_{IN} = 240\text{ MHz}$ , $V_{IN} = -6\text{ dBFS}$ |                              | 8.2  |                | Bits          |                   |            |
| 2nd Harm  | Second Harmonic Distortion   | $f_{IN} = 10\text{ MHz}$ , $V_{IN} = -0.5\text{ dBFS}$ | 85°C           | -80           | -73               | dB (max)   |
|   |                              |  | 25°C           |               | -73               | dB (max)   |
|   |                              |  | -40°C          |               | -68               | dB (max)   |
|   |                              | $f_{IN} = 25\text{ MHz}$ , $V_{IN} = -0.5\text{ dBFS}$ |                | -80           |                   | dB         |
|   |                              | $f_{IN} = 150\text{ MHz}$ , $V_{IN} = -6\text{ dBFS}$  | 85°C           | -81           | -66               | dB (max)   |
|   |                              |  | 25°C           |               | -66               | dB (max)   |
| -40°C   | -56                          |  | dB (max)       |               |                   |            |
| $f_{IN} = 240\text{ MHz}$ , $V_{IN} = -6\text{ dBFS}$ |                              | -61  |                | dB            |                   |            |

### Converter Electrical Characteristics (continued)

Unless otherwise specified, the following specifications apply for AGND = DGND = DR GND = 0V,  $V_A = V_D = +3.3V$ ,  $V_{DR} = +2.5V$ ,  $PD = 0V$ ,  $V_{REF} = +1.0V$ ,  $V_{CM} = 1.0V$ ,  $f_{CLK} = 66\text{ MHz}$ ,  $t_r = t_f = 2\text{ ns}$ ,  $C_L = 15\text{ pF/pin}$ . **Boldface limits apply for  $T_J = T_{MIN}$  to  $T_{MAX}$** : all other limits  $T_J = 25^\circ\text{C}$  <sup>(1)(2)(3)(4)</sup>

| Symbol   | Parameter                   | Conditions   |       | Typical<br>(4) | Limits<br>(4) | Units<br>(Limits) |
|----------|-----------------------------|--|-------|----------------|---------------|-------------------|
| 3rd Harm | Third Harmonic Distortion   | $f_{IN} = 10\text{ MHz}$ , $V_{IN} = -0.5\text{ dBFS}$ | 85°C  | -84            | -74           | dB (max)          |
|          |                             |  | 25°C  |                | -74           | dB (max)          |
|          |                             |  | -40°C |                | -71           | dB (max)          |
|          |                             | $f_{IN} = 25\text{ MHz}$ , $V_{IN} = -0.5\text{ dBFS}$ |       | -79            |               | dB                |
|          |                             | $f_{IN} = 150\text{ MHz}$ , $V_{IN} = -6\text{ dBFS}$  | 85°C  | -78            | -68           | dB (max)          |
|          |                             |  | 25°C  |                | -68           | dB (max)          |
|          |                             |  | -40°C |                | -64           | dB (max)          |
|          |                             | $f_{IN} = 240\text{ MHz}$ , $V_{IN} = -6\text{ dBFS}$  |       | -78            |               | dB                |
| THD      | Total Harmonic Distortion   | $f_{IN} = 10\text{ MHz}$ , $V_{IN} = -0.5\text{ dBFS}$ | 85°C  | -77            | -72           | dB (max)          |
|          |                             |  | 25°C  |                | -72           | dB (max)          |
|          |                             |  | -40°C |                | -66           | dB (max)          |
|          |                             | $f_{IN} = 25\text{ MHz}$ , $V_{IN} = -0.5\text{ dBFS}$ |       | -71            |               | dB                |
|          |                             | $f_{IN} = 150\text{ MHz}$ , $V_{IN} = -6\text{ dBFS}$  | 85°C  | -69            | -63           | dB (max)          |
|          |                             |  | 25°C  |                | -63           | dB (max)          |
|          |                             |  | -40°C |                | -53           | dB (max)          |
|          |                             | $f_{IN} = 240\text{ MHz}$ , $V_{IN} = -6\text{ dBFS}$  |       | -57            |               | dB                |
| SFDR     | Spurious Free Dynamic Range | $f_{IN} = 10\text{ MHz}$ , $V_{IN} = -0.5\text{ dBFS}$ | 85°C  | 80             | 73            |                   |
|          |                             |  | 25°C  |                | 73            | dB (min)          |
|          |                             |  | -40°C |                | 68            |                   |
|          |                             | $f_{IN} = 25\text{ MHz}$ , $V_{IN} = -0.5\text{ dBFS}$ |       | 73             |               | dB                |
|          |                             | $f_{IN} = 150\text{ MHz}$ , $V_{IN} = -6\text{ dBFS}$  | 85°C  | 74             | 66            |                   |
|          |                             |  | 25°C  |                | 66            | dB (min)          |
|          |                             |  | -40°C |                | 56            |                   |
|          |                             | $f_{IN} = 240\text{ MHz}$ , $V_{IN} = -6\text{ dBFS}$  |       | 61             |               | dB                |



## DC and Logic Electrical Characteristics

Unless otherwise specified, the following specifications apply for AGND = DGND = DR GND = 0V,  $V_A = V_D = +3.3V$ ,  $V_{DR} = +2.5V$ , PD = 0V,  $V_{REF} = +1.0V$ ,  $V_{CM} = 1.0V$ ,  $f_{CLK} = 66\text{ MHz}$ ,  $t_r = t_f = 2\text{ ns}$ ,  $C_L = 15\text{ pF/pin}$ . **Boldface limits apply for  $T_J = T_{MIN}$  to  $T_{MAX}$** : all other limits  $T_J = 25^\circ\text{C}^{(1)(2)(3)(4)}$

| Symbol   | Parameter                           | Conditions  | Typical<br>(4) | Limits<br>(4)             | Units<br>(Limits) |
|--|-------------------------------------|---|----------------|---------------------------|-------------------|
| <b>CLK, PD, <math>\overline{OE}</math> DIGITAL INPUT CHARACTERISTICS</b> |                                     |   |                |                           |                   |
| $V_{IN(1)}$  | Logical "1" Input Voltage           | $V_D = 3.3V$  |                | <b>2.0</b>                | V (min)           |
| $V_{IN(0)}$  | Logical "0" Input Voltage           | $V_D = 3.3V$  |                | <b>0.8</b>                | V (max)           |
| $I_{IN(1)}$  | Logical "1" Input Current           | $V_{IN^+}, V_{IN^-} = 3.3V$                                   | 10             |                           | $\mu\text{A}$     |
| $I_{IN(0)}$  | Logical "0" Input Current           | $V_{IN^+}, V_{IN^-} = 0V$                                     | -10            |                           | $\mu\text{A}$     |
| $C_{IN}$   | Digital Input Capacitance           |   | 5              |                           | pF                |
| <b>D0–D11 DIGITAL OUTPUT CHARACTERISTICS</b>                             |                                     |   |                |                           |                   |
| $V_{OUT(1)}$   | Logical "1" Output Voltage          | $I_{OUT} = -0.5\text{ mA}$                                    |                | $V_{DR} -$<br><b>0.18</b> | V (min)           |
| $V_{OUT(0)}$   | Logical "0" Output Voltage          | $I_{OUT} = 1.6\text{ mA}$                                     |                | <b>0.4</b>                | V (max)           |
| $I_{OZ}$   | TRI-STATE Output Current            | $V_{OUT} = 3.3V$  | 100            |                           | nA                |
|  |                                     | $V_{OUT} = 0V$  | -100           |                           | nA                |
| + $I_{SC}$   | Output Short Circuit Source Current | $V_{OUT} = 0V$  | -20            |                           | mA                |
| - $I_{SC}$   | Output Short Circuit Sink Current   | $V_{OUT} = 2.5V$  | 20             |                           | mA                |
| <b>POWER SUPPLY CHARACTERISTICS</b>                                      |                                     |   |                |                           |                   |
| $I_A$  | Analog Supply Current               | PD Pin = DGND, $V_{REF} = 1.0V$<br>PD Pin = $V_{DR}$          | 103<br>4       | <b>139</b>                | mA (max)<br>mA    |
| $I_D$  | Digital Supply Current              | PD Pin = DGND<br>PD Pin = $V_{DR}$                            | 5.3<br>2       | <b>6.2</b>                | mA (max)<br>mA    |
| $I_{DR}$   | Digital Output Supply Current       | PD Pin = DGND, <sup>(5)</sup>                                 | <1             |                           | mA                |
|  |                                     | PD Pin = $V_{DR}$   | 0              |                           | mA                |
|  | Total Power Consumption             | PD Pin = DGND, $C_L = 0\text{ pF}^{(6)}$<br>PD Pin = $V_{DR}$ | 357<br>50      | <b>479</b>                | mW (max)<br>mW    |
| PSRR1  | Power Supply Rejection              | Rejection of Full-Scale Error with<br>$V_A = 3.0V$ vs. $3.6V$ | 58             |                           | dB                |

- (1) The inputs are protected as shown below. Input voltages above  $V_A$  or below GND will not damage this device, provided current is limited per [Note 4](#) under Absolute Maximum Ratings. However, errors in the A/D conversion can occur if the input goes above  $V_A$  or below GND by more than 100 mV. As an example, if  $V_A$  is 3.3V, the full-scale input voltage must be  $\leq 3.4V$  to ensure accurate conversions.

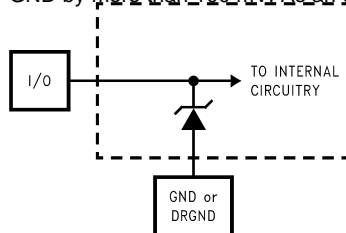

- (2) To ensure accuracy, it is required that  $|V_A - V_D| \leq 100\text{ mV}$  and separate bypass capacitors are used at each power supply pin.
- (3) With the test condition for  $V_{REF} = +1.0V$  (2  $V_{P-P}$  differential input), the 12-bit LSB is 488  $\mu\text{V}$ .
- (4) Typical figures are at  $T_A = T_J = 25^\circ\text{C}$ , and represent most likely parametric norms. Test limits are specified to TI's AOQL (Average Outgoing Quality Level).
- (5)  $I_{DR}$  is the current consumed by the switching of the output drivers and is primarily determined by load capacitance on the output pins, the supply voltage,  $V_{DR}$ , and the rate at which the outputs are switching (which is signal dependent).  $I_{DR} = V_{DR}(C_0 \times f_0 + C_1 \times f_1 + \dots + C_{11} \times f_{11})$  where  $V_{DR}$  is the output driver power supply voltage,  $C_n$  is total capacitance on the output pin, and  $f_n$  is the average frequency at which that pin is toggling.
- (6) Power consumption excludes output driver power. See [Note 5](#)

## AC Electrical Characteristics

Unless otherwise specified, the following specifications apply for AGND = DGND = DR GND = 0V,  $V_A = V_D = +3.3V$ ,  $V_{DR} = +2.5V$ , PD = 0V,  $V_{REF} = +1.0V$ ,  $V_{CM} = 1.0V$ ,  $f_{CLK} = 66$  MHz,  $t_r = t_f = 2$  ns,  $C_L = 15$  pF/pin. **Boldface limits apply for  $T_A = T_J = T_{MIN}$  to  $T_{MAX}$ : all other limits  $T_A = T_J = 25^\circ C$**  <sup>(1)(2)(3)(4)(5)</sup>

| Symbol     | Parameter                               | Conditions                     | Typical<br>(4) | Limits<br>(4) | Units<br>(Limits)  |
|------------|---|--------------------------------|----------------|---------------|--------------------|
| $f_{CLK1}$ | Maximum Clock Frequency                 |                                | 80             | <b>66</b>     | MHz (min)          |
| $f_{CLK2}$ | Minimum Clock Frequency                 |                                | 1              |               | MHz                |
| DC         | Clock Duty Cycle                        |                                | 40<br>60       |               | % (min)<br>% (max) |
| $t_{CH}$   | Clock High Time                         |                                | 6.5            |               | ns (min)           |
| $t_{CL}$   | Clock Low Time                          |                                | 6.5            |               | ns (min)           |
| $t_{CONV}$ | Conversion Latency                      |                                |                | <b>6</b>      | Clock Cycles       |
| $t_{OD}$   | Data Output Delay after Rising CLK Edge | $V_{DR} = 2.5V$                | 7.5            | <b>11</b>     | ns (max)           |
|            |   | $V_{DR} = 3.3V$                | 6.7            | <b>10.5</b>   | ns (max)           |
| $t_{AD}$   | Aperture Delay                          |                                | 2              |               | ns                 |
| $t_{AJ}$   | Aperture Jitter                         |                                | 1.2            |               | ps rms             |
| $t_{DIS}$  | Data outputs into TRI-STATE Mode        |                                | 10             |               | ns                 |
| $t_{EN}$   | Data Outputs Active after TRI-STATE     |                                | 10             |               | ns                 |
| $t_{PD}$   | Power Down Mode Exit Cycle              | 0.1 $\mu F$ on pins 30, 31, 32 | 300            |               | ns                 |

- (1) The inputs are protected as shown below. Input voltages above  $V_A$  or below GND will not damage this device, provided current is limited per [Note 4](#) under Absolute Maximum Ratings. However, errors in the A/D conversion can occur if the input goes above  $V_A$  or below GND by more than 100 mV. As an example, if  $V_A$  is 3.3V, the full-scale input voltage must be  $\leq 3.4V$  to ensure accurate conversions.

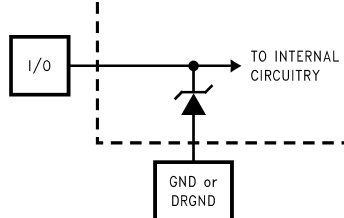

- (2) To ensure accuracy, it is required that  $|V_A - V_D| \leq 100$  mV and separate bypass capacitors are used at each power supply pin.
- (3) With the test condition for  $V_{REF} = +1.0V$  (2  $V_{P-P}$  differential input), the 12-bit LSB is 488  $\mu V$ .
- (4) Typical figures are at  $T_A = T_J = 25^\circ C$ , and represent most likely parametric norms. Test limits are specified to TI's AOQL (Average Outgoing Quality Level).
- (5) Timing specifications are tested at TTL logic levels,  $V_{IL} = 0.4V$  for a falling edge and  $V_{IH} = 2.4V$  for a rising edge.

## Specification Definitions

**APERTURE DELAY** is the time after the rising edge of the clock to when the input signal is acquired or held for conversion.

**APERTURE JITTER (APERTURE UNCERTAINTY)** is the variation in aperture delay from sample to sample. Aperture jitter manifests itself as noise in the output.

**CLOCK DUTY CYCLE** is the ratio of the time that a repetitive digital waveform is high to the total time of one period. The specification here refers to the ADC clock input signal.

**COMMON MODE VOLTAGE ( $V_{CM}$ )** is the d.c. potential present at both signal inputs to the ADC.

**CONVERSION LATENCY** is the number of clock cycles between initiation of conversion and when that data is presented to the output driver stage. Data for any given sample is available at the output pins the Pipeline Delay plus the Output Delay after the sample is taken. New data is available at every clock cycle, but the data lags the conversion by the pipeline delay.

**DIFFERENTIAL NON-LINEARITY (DNL)** is the measure of the maximum deviation from the ideal step size of 1 LSB.

**EFFECTIVE NUMBER OF BITS (ENOB, or EFFECTIVE BITS)** is another method of specifying Signal-to-Noise and Distortion or SINAD. ENOB is defined as  $(\text{SINAD} - 1.76) / 6.02$  and says that the converter is equivalent to a perfect ADC of this (ENOB) number of bits.

**FULL POWER BANDWIDTH** is a measure of the frequency at which the reconstructed output fundamental drops 3 dB below its low frequency value for a full scale input.

**GAIN ERROR** is the deviation from the ideal slope of the transfer function. It can be calculated as:

$$\text{Gain Error} = \text{Positive Full-Scale Error} - \text{Negative Full-Scale Error} \quad (1)$$

Gain Error can also be separated into Positive Gain Error and Negative Gain Error, which are

$$\text{Positive Gain Error} = \text{Positive Full-Scale Error} - \text{Offset Error} \quad (2)$$

$$\text{Negative Gain Error} = \text{Offset Error} - \text{Negative Full-Scale Error} \quad (3)$$

**LSB (LEAST SIGNIFICANT BIT)** is the bit that has the smallest value or weight of all bits. This value is  $V_{REF}/2^n$ , where “n” is the ADC resolution in bits, which is 12 in the case of the ADC12DL066.

**INTEGRAL NON LINEARITY (INL)** is a measure of the deviation of each individual code from a line drawn from negative full scale ( $\frac{1}{2}$  LSB below the first code transition) through positive full scale ( $\frac{1}{2}$  LSB above the last code transition). The deviation of any given code from this straight line is measured from the center of that code value.

**INTERMODULATION DISTORTION (IMD)** is the creation of additional spectral components as a result of two sinusoidal frequencies being applied to the ADC input at the same time. It is defined as the ratio of the power in the second and third order intermodulation products to the power in one of the original frequencies. IMD is usually expressed in dBFS.

**MISSING CODES** are those output codes that will never appear at the ADC outputs. The ADC12L066 is ensured not to have any missing codes.

**MSB (MOST SIGNIFICANT BIT)** is the bit that has the largest value or weight. Its value is one half of full scale.

**NEGATIVE FULL SCALE ERROR** is the difference between the input voltage ( $V_{IN+} - V_{IN-}$ ) just causing a transition from negative full scale to the first code and its ideal value of 0.5 LSB. Negative Full-Scale Error can be calculated as:

**OFFSET ERROR** is the input voltage that will cause a transition from a code of 01 1111 1111 to a code of 10 0000 0000.

**OUTPUT DELAY** is the time delay after the rising edge of the clock before the data update is presented at the output pins.

**PIPELINE DELAY (LATENCY)** See Conversion Latency

**POSITIVE FULL SCALE ERROR** is the difference between the actual last code transition and its ideal value of  $\frac{1}{2}$  LSB below positive full scale.

**POWER SUPPLY REJECTION RATIO (PSRR)** is a measure of how well the ADC rejects a change in the power supply voltage. For the ADC12L066, PSRR1 is the ratio of the change in Full-Scale Error that results from a change in the d.c. power supply voltage, expressed in dB. PSRR2 is a measure of how well an a.c. signal riding upon the power supply is rejected at the output.

**SIGNAL TO NOISE RATIO (SNR)** is the ratio, expressed in dB, of the rms value of the input signal to the rms value of the sum of all other spectral components below one-half the sampling frequency, not including harmonics or d.c.

**SIGNAL TO NOISE PLUS DISTORTION (S/N+D or SINAD)** Is the ratio, expressed in dB, of the rms value of the input signal to the rms value of all of the other spectral components below half the clock frequency, including harmonics but excluding d.c.

**SPURIOUS FREE DYNAMIC RANGE (SFDR)** is the difference, expressed in dB, between the desired signal amplitude to the amplitude of the peak spurious spectral component, where a spurious spectral component is any signal present in the output spectrum that is not present at the input and may or may not be a harmonic.

**TOTAL HARMONIC DISTORTION (THD)** is the ratio, expressed in dBc, of the rms total of the first nine harmonic levels at the output to the level of the fundamental at the output. THD is calculated as

$$\text{THD} = 20 \times \log \sqrt{\frac{f_2^2 + \dots + f_{10}^2}{f_1^2}} \quad (4)$$

where  $f_1$  is the RMS power of the fundamental (output) frequency and  $f_2$  through  $f_{10}$  are the RMS power in the first 9 harmonic frequencies.

**SECOND HARMONIC DISTORTION (2ND HARM)** is the difference expressed in dB, between the RMS power in the input frequency at the output and the power in its 2nd harmonic level at the output.

**THIRD HARMONIC DISTORTION (3RD HARM)** is the difference, expressed in dB, between the RMS power in the input frequency at the output and the power in its 3rd harmonic level at the output.

### Timing Diagram

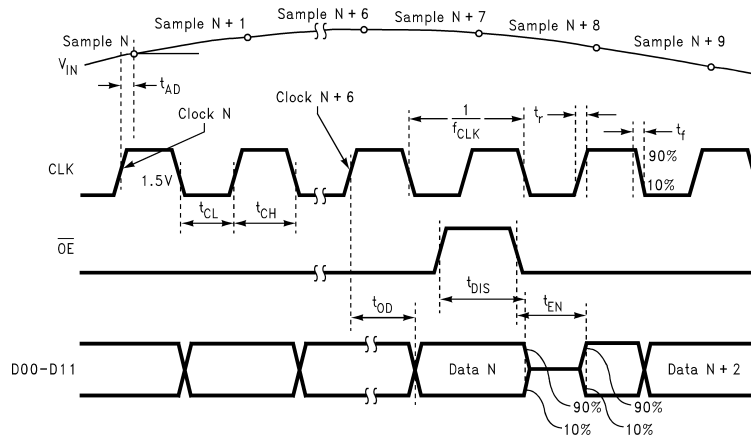

Figure 1. Output Timing

### Transfer Characteristic

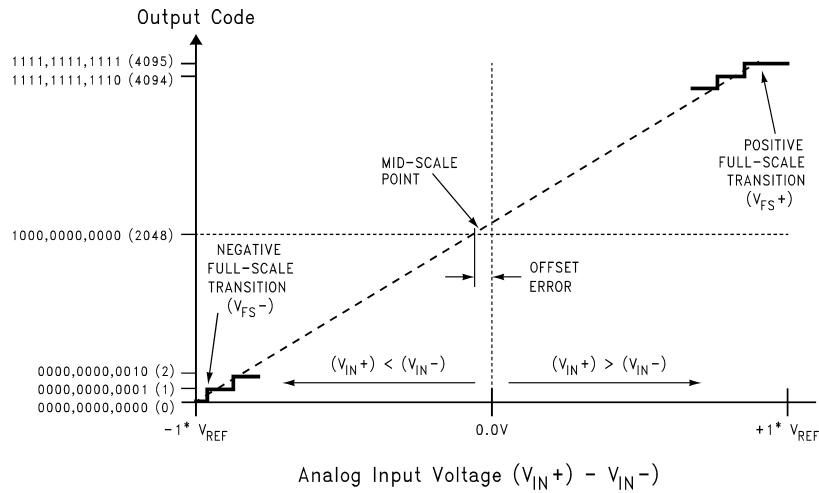

Figure 2. Transfer Characteristic

### Typical Performance Characteristics

$V_A = V_D = 3.3V$ ,  $V_{DR} = 2.5V$ ,  $f_{CLK} = 66\text{ MHz}$ ,  $f_{IN} = 25\text{ MHz}$ ,  $V_{REF} = 1.0V$ , unless otherwise stated.

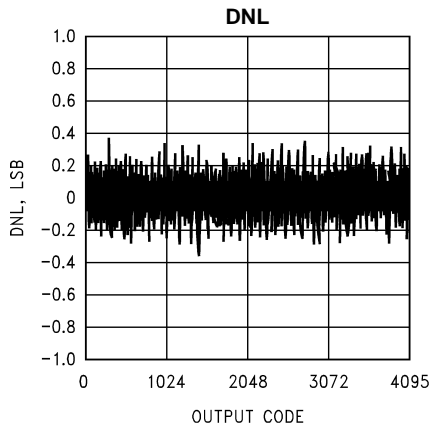

Figure 3.

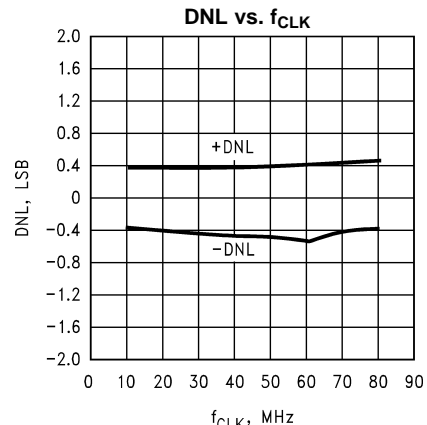

Figure 4.

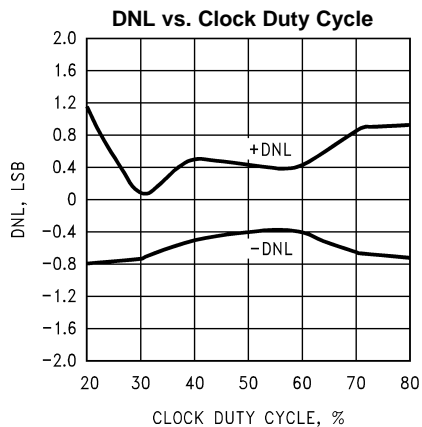

Figure 5.

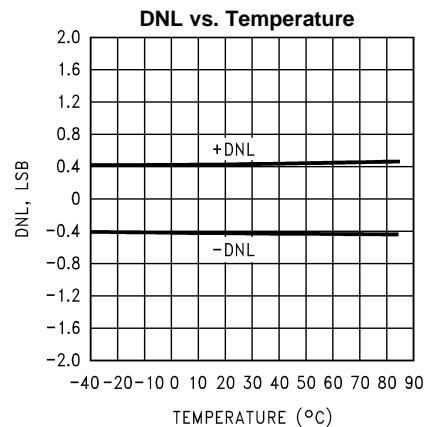

Figure 6.

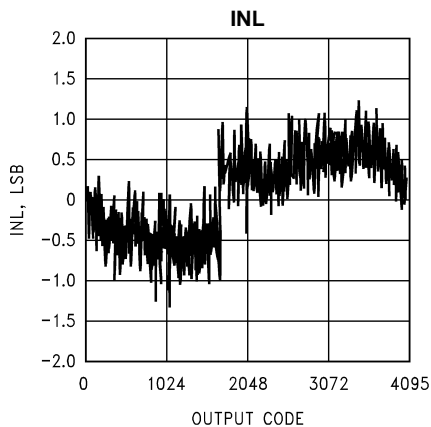

Figure 7.

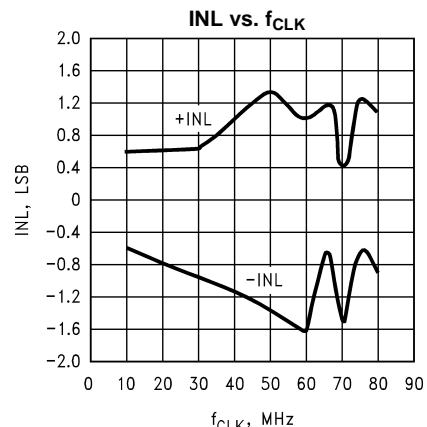

Figure 8.

**Typical Performance Characteristics (continued)**

$V_A = V_D = 3.3V$ ,  $V_{DR} = 2.5V$ ,  $f_{CLK} = 66\text{ MHz}$ ,  $f_{IN} = 25\text{ MHz}$ ,  $V_{REF} = 1.0V$ , unless otherwise stated.

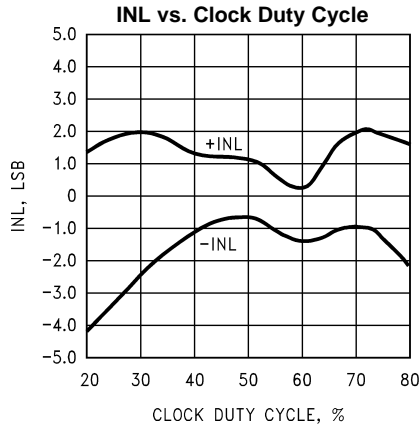

Figure 9.

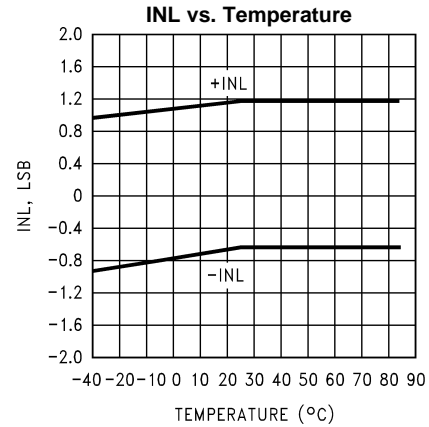

Figure 10.

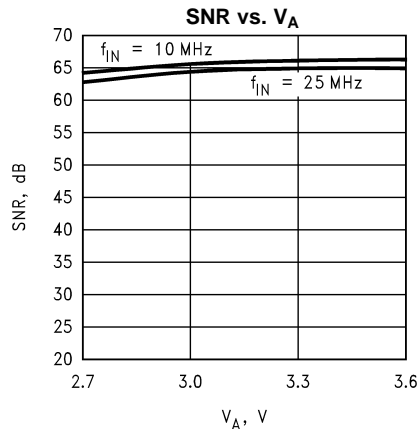

Figure 11.

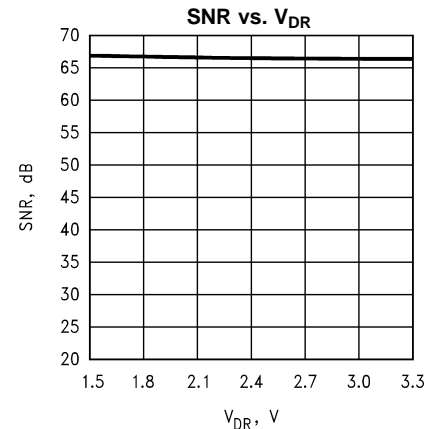

Figure 12.

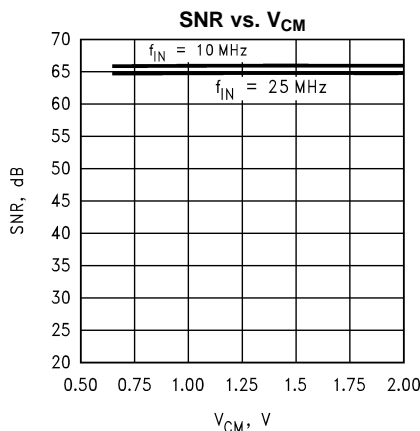

Figure 13.

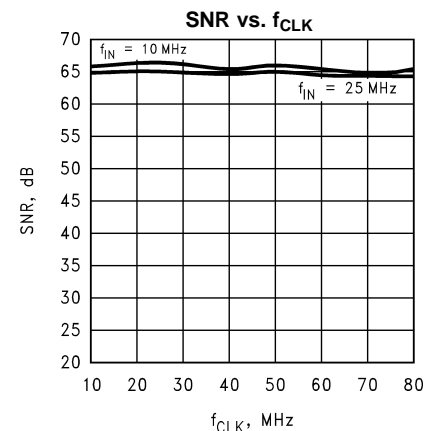

Figure 14.

**Typical Performance Characteristics (continued)**

$V_A = V_D = 3.3V$ ,  $V_{DR} = 2.5V$ ,  $f_{CLK} = 66\text{ MHz}$ ,  $f_{IN} = 25\text{ MHz}$ ,  $V_{REF} = 1.0V$ , unless otherwise stated.

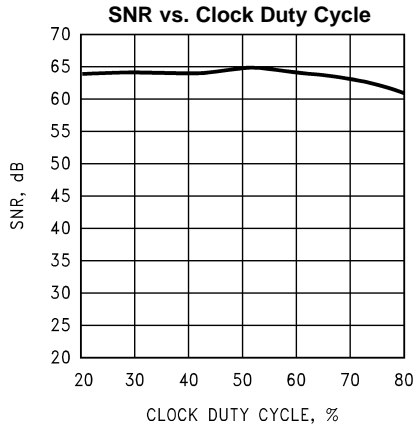

Figure 15.

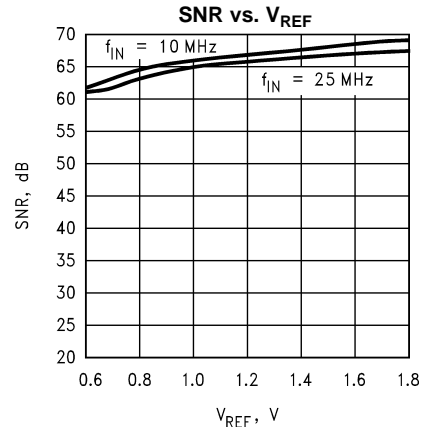

Figure 16.

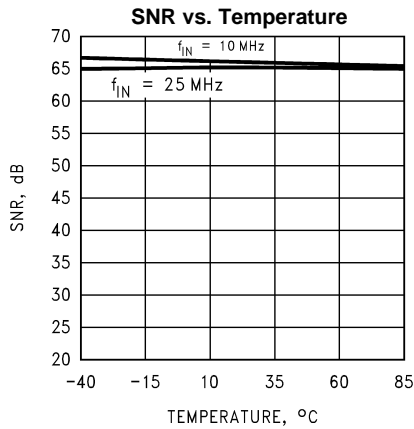

Figure 17.

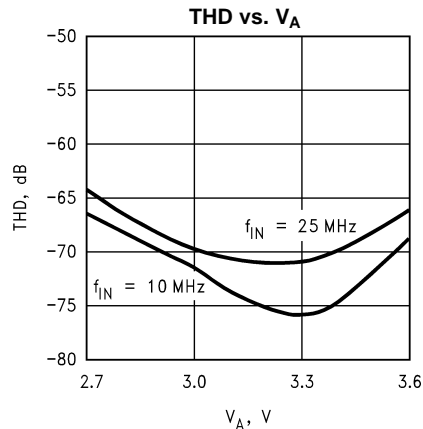

Figure 18.

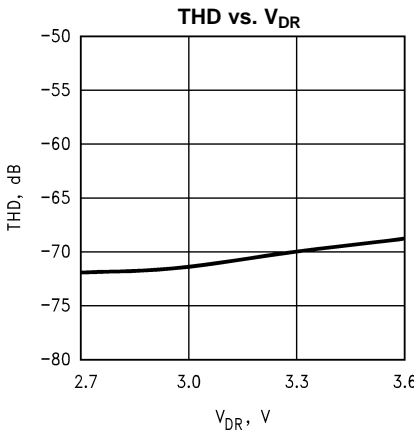

Figure 19.

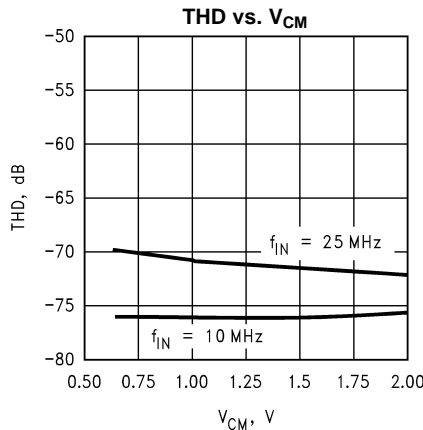
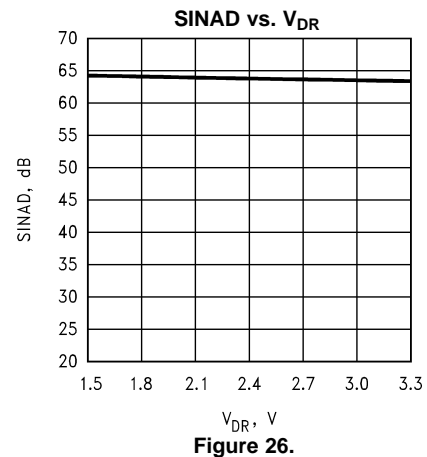
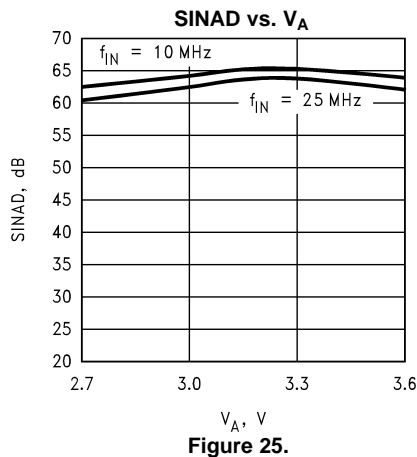
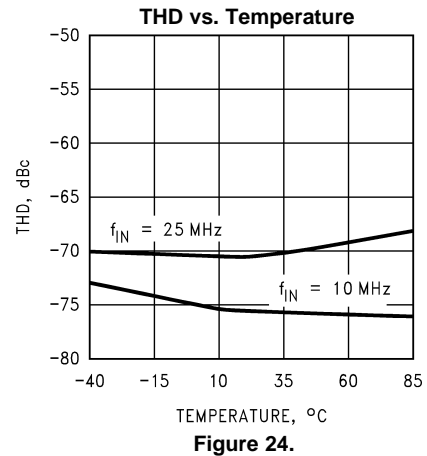
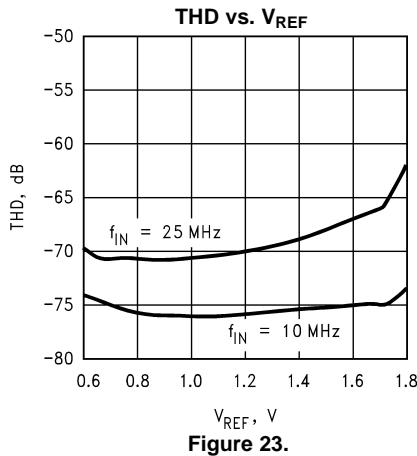
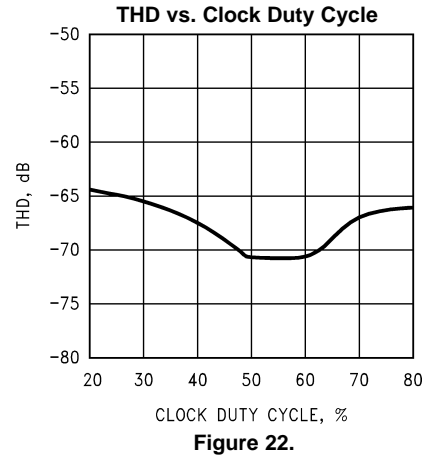
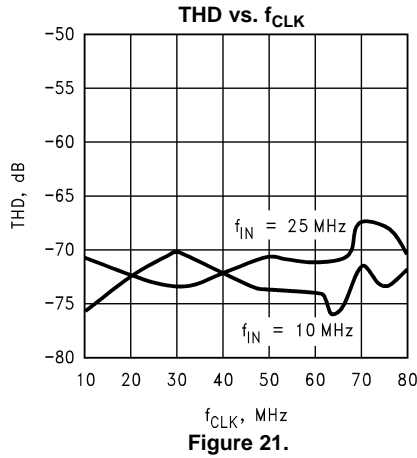

Figure 20.



**Typical Performance Characteristics (continued)**

$V_A = V_D = 3.3V$ ,  $V_{DR} = 2.5V$ ,  $f_{CLK} = 66\text{ MHz}$ ,  $f_{IN} = 25\text{ MHz}$ ,  $V_{REF} = 1.0V$ , unless otherwise stated.



**Typical Performance Characteristics (continued)**

$V_A = V_D = 3.3V$ ,  $V_{DR} = 2.5V$ ,  $f_{CLK} = 66\text{ MHz}$ ,  $f_{IN} = 25\text{ MHz}$ ,  $V_{REF} = 1.0V$ , unless otherwise stated.

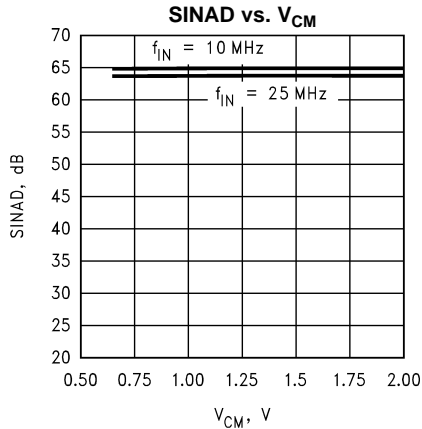

Figure 27.

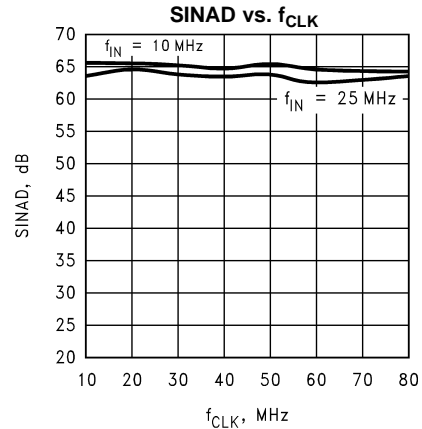

Figure 28.

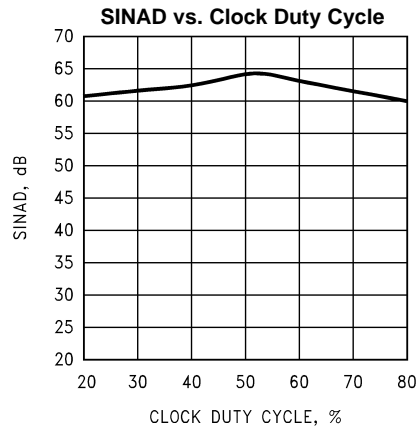

Figure 29.

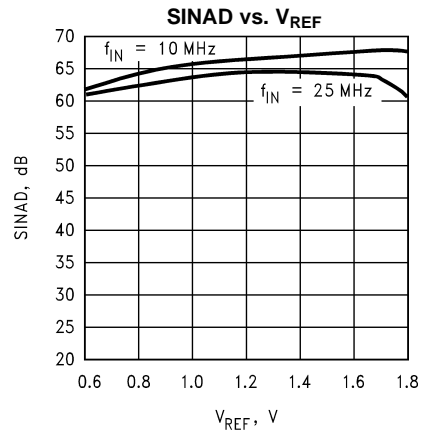

Figure 30.

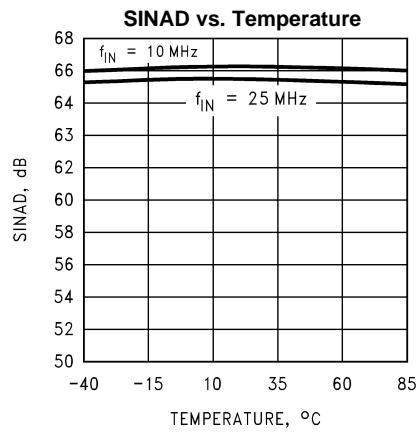

Figure 31.

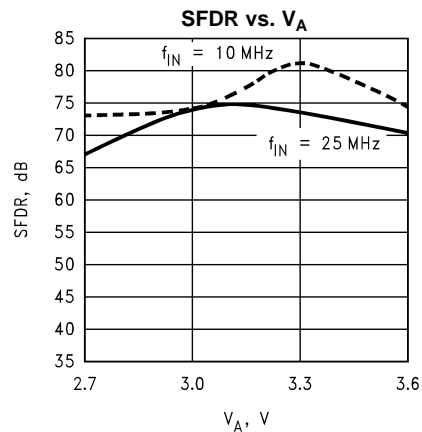

Figure 32.

**Typical Performance Characteristics (continued)**

$V_A = V_D = 3.3V$ ,  $V_{DR} = 2.5V$ ,  $f_{CLK} = 66\text{ MHz}$ ,  $f_{IN} = 25\text{ MHz}$ ,  $V_{REF} = 1.0V$ , unless otherwise stated.

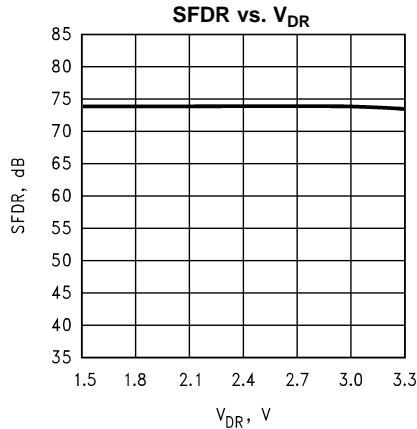

Figure 33.

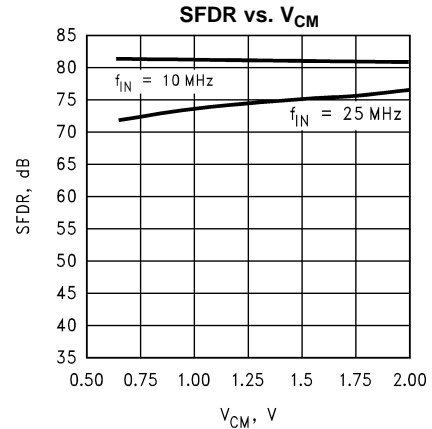

Figure 34.

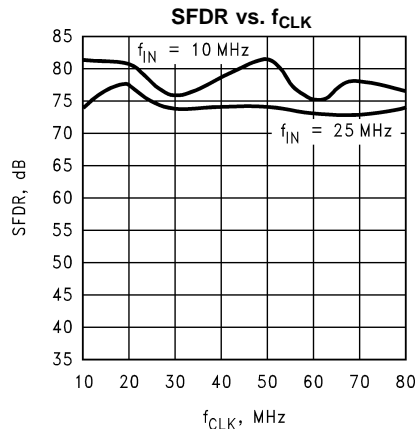

Figure 35.

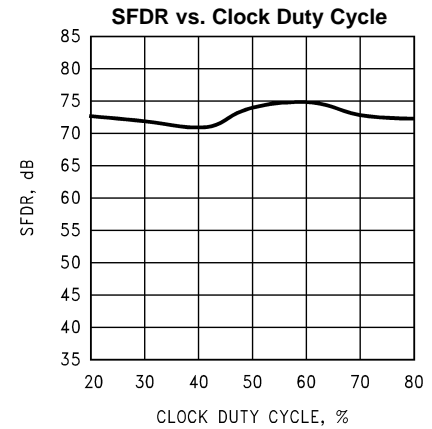

Figure 36.

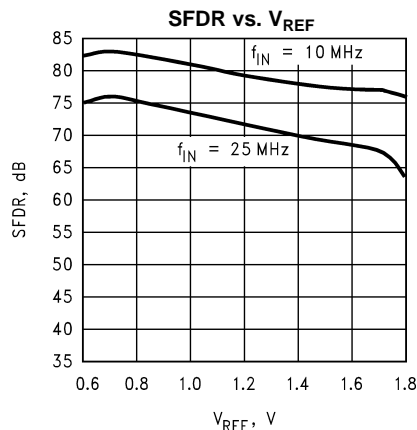

Figure 37.

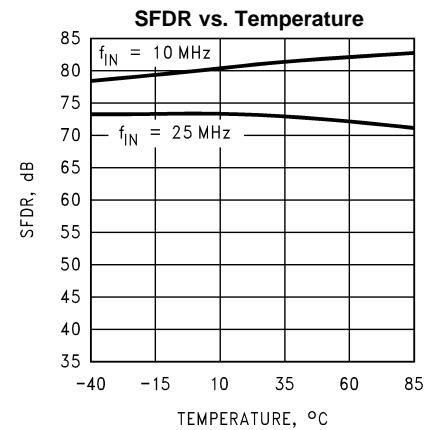

Figure 38.

**Typical Performance Characteristics (continued)**

$V_A = V_D = 3.3V$ ,  $V_{DR} = 2.5V$ ,  $f_{CLK} = 66\text{ MHz}$ ,  $f_{IN} = 25\text{ MHz}$ ,  $V_{REF} = 1.0V$ , unless otherwise stated.

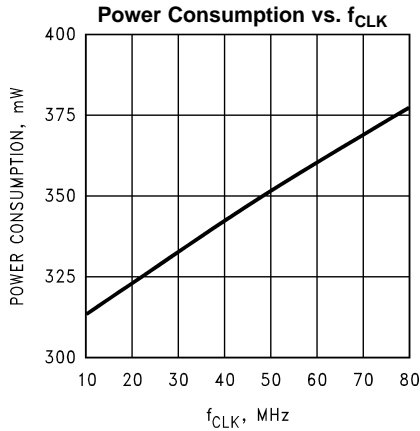

Figure 39.

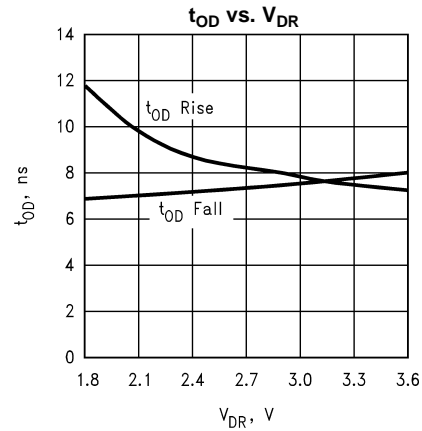

Figure 40.

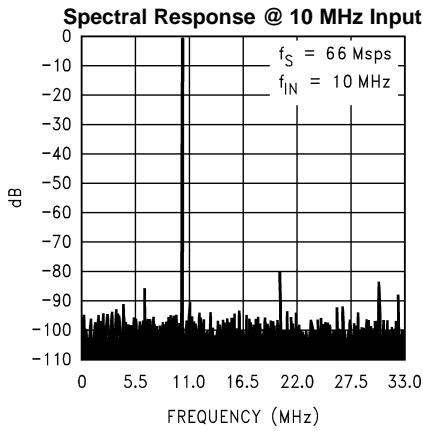

Figure 41.

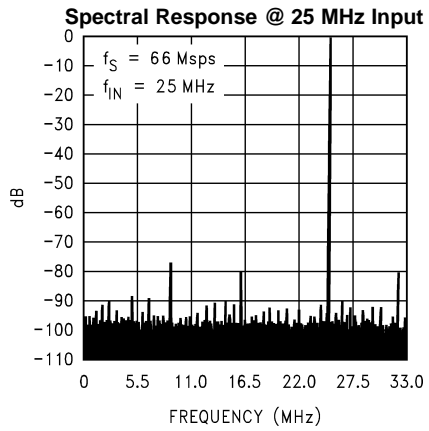

Figure 42.

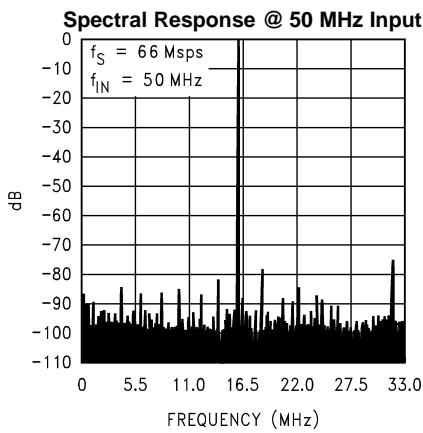

Figure 43.

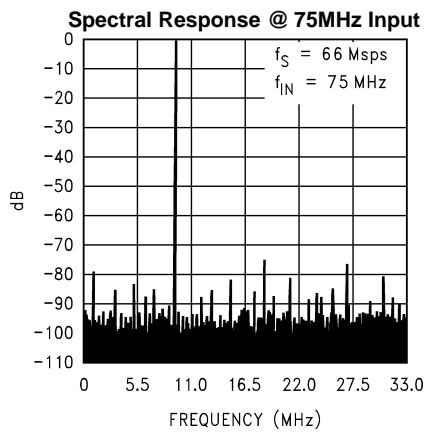
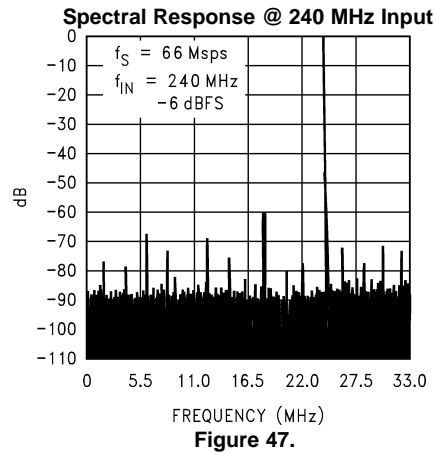
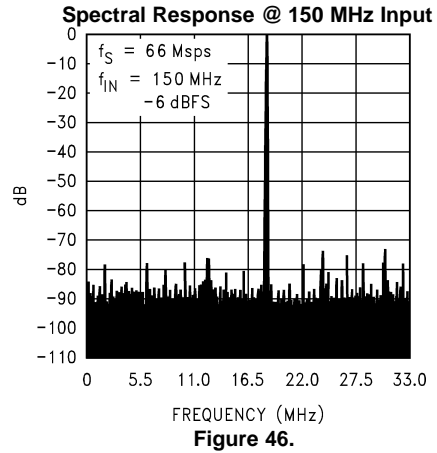
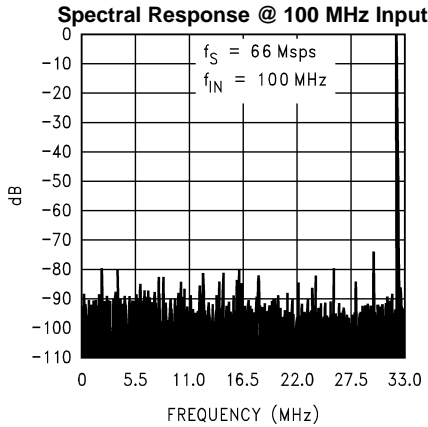

Figure 44.

**Typical Performance Characteristics (continued)**

$V_A = V_D = 3.3V$ ,  $V_{DR} = 2.5V$ ,  $f_{CLK} = 66\text{ MHz}$ ,  $f_{IN} = 25\text{ MHz}$ ,  $V_{REF} = 1.0V$ , unless otherwise stated.



## FUNCTIONAL DESCRIPTION

Operating on a single +3.3V supply, the ADC12L066 uses a pipeline architecture and has error correction circuitry to help ensure maximum performance.

Differential analog input signals are digitized to 12 bits. Each analog input signal should have a peak-to-peak voltage equal to the input reference voltage,  $V_{REF}$ , be centered around a common mode voltage,  $V_{CM}$ , and be 180° out of phase with each other. [Table 1](#) and [Table 2](#) indicate the input to output relationship of the ADC12L066. Biasing one input to  $V_{CM}$  and driving the other input with its full range signal results in a 6 dB reduction of the output range, limiting it to the range of  $\frac{1}{4}$  to  $\frac{3}{4}$  of the minimum output range obtainable if both inputs were driven with complimentary signals. [Signal Inputs](#) explains how to avoid this signal reduction.

**Table 1. Input to Output Relationship–Differential Input**

| $V_{IN+}$            | $V_{IN-}$            | Output         |
|----------------------|----------------------|----------------|
| $V_{CM} - V_{REF}/2$ | $V_{CM} + V_{REF}/2$ | 0000 0000 0000 |
| $V_{CM} - V_{REF}/4$ | $V_{CM} + V_{REF}/4$ | 0100 0000 0000 |
| $V_{CM}$             | $V_{CM}$             | 1000 0000 0000 |
| $V_{CM} + V_{REF}/4$ | $V_{CM} - V_{REF}/4$ | 1100 0000 0000 |
| $V_{CM} + V_{REF}/2$ | $V_{CM} - V_{REF}/2$ | 1111 1111 1111 |

**Table 2. Input to Output Relationship–Single-Ended Input**

| $V_{IN+}$            | $V_{IN-}$ | Output         |
|----------------------|-----------|----------------|
| $V_{CM} - V_{REF}$   | $V_{CM}$  | 0000 0000 0000 |
| $V_{CM} - V_{REF}/2$ | $V_{CM}$  | 0100 0000 0000 |
| $V_{CM}$             | $V_{CM}$  | 1000 0000 0000 |
| $V_{CM} + V_{REF}/2$ | $V_{CM}$  | 1100 0000 0000 |
| $V_{CM} + V_{REF}$   | $V_{CM}$  | 1111 1111 1111 |

The output word rate is the same as the clock frequency, which can be between 1 Msps and 80 Msps (typical). The analog input voltage is acquired at the rising edge of the clock and the digital data for that sample is delayed by the pipeline for 6 clock cycles.

A logic high on the power down (PD) pin reduces the converter power consumption to 50 mW.

## Applications Information

### OPERATING CONDITIONS

We recommend that the following conditions be observed for operation of the ADC12L066:

- $3.0\text{ V} \leq V_A \leq 3.6\text{ V}$
- $V_D = V_A$
- $1.8\text{ V} \leq V_{DR} \leq V_D$
- $1\text{ MHz} \leq f_{CLK} \leq 80\text{ MHz}$
- $0.8\text{ V} \leq V_{REF} \leq 1.5\text{ V}$
- $0.5\text{ V} \leq V_{CM} \leq 1.5\text{ V}$

### Analog Inputs

The ADC12L066 has two analog signal inputs,  $V_{IN+}$  and  $V_{IN-}$ . These two pins form a differential input pair. There is one reference input pin,  $V_{REF}$ .

### Reference Pins

The ADC12L066 is designed to operate with a 1.0V reference, but performs well with reference voltages in the range of 0.8V to 1.5V. Lower reference voltages will decrease the signal-to-noise ratio (SNR) of the ADC12L066. Increasing the reference voltage (and the input signal swing) beyond 1.5V may degrade THD for a full-scale input, especially at higher input frequencies. It is important that all grounds associated with the reference voltage and the input signal make connection to the analog ground plane at a single, quiet point in that plane to minimize the effects of noise currents in the ground path.

The ADC12L066 will perform well with reference voltages up to 1.5V for full-scale input frequencies up to 10 MHz. However, more headroom is needed as the input frequency increases, so the maximum reference voltage (and input swing) will decrease for higher full-scale input frequencies.

The three Reference Bypass Pins ( $V_{RP}$ ,  $V_{RM}$  and  $V_{RN}$ ) are made available for bypass purposes only. These pins should each be bypassed to ground with a 0.1  $\mu\text{F}$  capacitor. Smaller capacitor values will allow faster recovery from the power down mode, but may result in degraded noise performance. DO NOT LOAD these pins. Loading any of these pins may result in performance degradation.

The nominal voltages for the reference bypass pins are as follows:

$$\begin{aligned} V_{RM} &= V_A / 2 \\ V_{RP} &= V_{RM} + V_{REF} / 2 \\ V_{RN} &= V_{RM} - V_{REF} / 2 \end{aligned}$$

The  $V_{RM}$  pin may be used as a common mode voltage source ( $V_{CM}$ ) for the analog input pins as long as no d.c. current is drawn from it. However, because the voltage at this pin is half that of the  $V_A$  supply pin, using these pins for a common mode source will result in reduced input headroom (the difference between the  $V_A$  supply voltage and the peak signal voltage at either analog input) and the possibility of reduced THD and SFDR performance. For this reason, it is recommended that  $V_A$  always exceed  $V_{REF}$  by at least 2 Volts. For high input frequencies it may be necessary to increase this headroom to maintain THD and SFDR performance. Alternatively, use  $V_{RN}$  for a  $V_{CM}$  source.

### Signal Inputs

The signal inputs are  $V_{IN+}$  and  $V_{IN-}$ . The input signal,  $V_{IN}$ , is defined as

$$V_{IN} = (V_{IN+}) - (V_{IN-}) \tag{5}$$

Figure 48 shows the expected input signal range.

Note that the nominal input common mode voltage is  $V_{REF}$  and the nominal input signals each run between the limits of  $V_{REF}/2$  and  $3V_{REF}/2$ . The Peaks of the input signals should never exceed the voltage described as

$$\text{Peak Input Voltage} = V_A - 0.8 \tag{6}$$

to maintain dynamic performance.

The ADC12L066 performs best with a differential input with each input centered around a common mode voltage,  $V_{CM}$  (minimum of 0.5V). The peak-to-peak voltage swing at both  $V_{IN+}$  and  $V_{IN-}$  should each not exceed the value of the reference voltage or the output data will be clipped.

The two input signals should be exactly 180° out of phase from each other and of the same amplitude. For single frequency (sine wave) inputs, angular errors result in a reduction of the effective full scale input. For a complex waveform, however, angular errors will result in distortion.

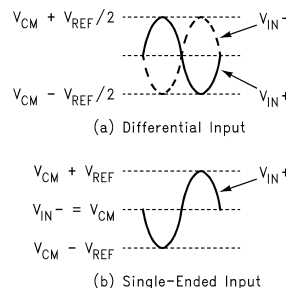
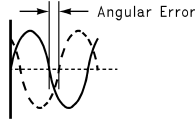

Figure 48. Expected Input Signal Range

For angular deviations of up to 10 degrees from these two signals being 180 out of phase with each other, the full scale error in LSB can be described as approximately

$$E_{FS} = \text{dev}^{1.79} \quad (7)$$

Where dev is the angular difference between the two signals having a 180° relative phase relationship to each other (see [Figure 49](#)). Drive the analog inputs with a source impedance less than 100Ω.



**Figure 49. Angular Errors Between Two Input Signals Will Reduce the Output Level or Cause Distortion**

For differential operation, each analog input pin of the differential pair should have a peak-to-peak voltage equal to the input reference voltage,  $V_{REF}$ , and be centered around  $V_{CM}$ .

#### SINGLE-ENDED INPUT OPERATION

Single-ended performance is inferior to that with differential input signals, so single-ended operation is not recommended. However, if single-ended operation is required and the resulting performance degradation is acceptable, one of the analog inputs should be connected to the d.c. mid point voltage of the driven input. The peak-to-peak differential input signal should be twice the reference voltage to maximize SNR and SINAD performance ([Figure 48b](#)).

For example, set  $V_{REF}$  to 0.5V, bias  $V_{IN-}$  to 1.0V and drive  $V_{IN+}$  with a signal range of 0.5V to 1.5V.

Because very large input signal swings can degrade distortion performance, better performance with a single-ended input can be obtained by reducing the reference voltage while maintaining a full-range output. [Table 1](#) and [Table 2](#) indicate the input to output relationship of the ADC12L066.

#### DRIVING THE ANALOG INPUTS

The  $V_{IN+}$  and the  $V_{IN-}$  inputs of the ADC12L066 consist of an analog switch followed by a switched-capacitor amplifier. The capacitance seen at the analog input pins changes with the clock level, appearing as 8 pF when the clock is low, and 7 pF when the clock is high.

As the internal sampling switch opens and closes, current pulses occur at the analog input pins, resulting in voltage spikes at the signal input pins. As a driving amplifier attempts to counteract these voltage spikes, a damped oscillation may appear at the ADC analog input. The best amplifiers for driving the ADC12L066 input pins must be able to react to these spikes and settle before the switch opens and another sample is taken. The LMH6702, LMH6628, LMH6622 and the LMH6655 are good amplifiers for driving the ADC12L066.

To help isolate the pulses at the ADC input from the amplifier output, use RCs at the inputs, as can be seen in [Figure 51](#) and [Figure 52](#). These components should be placed close to the ADC inputs because the input pins of the ADC is the most sensitive part of the system and this is the last opportunity to filter that input.

For Nyquist applications the RC pole should be at the ADC sample rate. The ADC input capacitance in the sample mode should be considered with setting the RC pole. Setting the pole in this manner will provide best SINAD performance.

To obtain best SNR performance, leave the RC values as calculated. To obtain best SINAD and ENOB performance, reduce the RC time constant until SNR and THD are numerically equal to each other. To obtain best distortion and SFDR performance, eliminate the RC altogether.

For undersampling applications, the RC pole should be set at about 1.5 to 2 times the maximum input frequency for narrow band applications. For wide band applications, the RC pole should be set at about 1.5 times the maximum input frequency to maintain a linear delay response.

A single-ended to differential conversion circuit is shown in [Figure 51](#).



## INPUT COMMON MODE VOLTAGE

The input common mode voltage,  $V_{CM}$ , should be in the range of 0.5V to 1.5V and be of a value such that the peak excursions of the analog signal does not go more negative than ground or more positive than 0.8 Volts below the  $V_A$  supply voltage. The nominal  $V_{CM}$  should generally be about 1.0V, but  $V_{RM}$  or  $V_{RN}$  can be used as a  $V_{CM}$  source as long as no d.c. current is drawn from either of these pins.

## DIGITAL INPUTS

Digital inputs are TTL/CMOS compatible and consist of CLK,  $\overline{OE}$  and PD.

### CLK

The **CLK** signal controls the timing of the sampling process. Drive the clock input with a stable, low jitter clock signal in the range of 1 MHz to 80 MHz with rise and fall times of less than 2 ns. The trace carrying the clock signal should be as short as possible and should not cross any other signal line, analog or digital, not even at 90°.

The **CLK** signal also drives an internal state machine. If the **CLK** is interrupted, or its frequency is too low, the charge on internal capacitors can dissipate to the point where the accuracy of the output data will degrade. This is what limits the lowest sample rate to 1 Msps.

The duty cycle of the clock signal can affect the performance of any A/D Converter. Because achieving a precise duty cycle is difficult, the ADC12L066 is designed to maintain performance over a range of duty cycles. While it is specified and performance is specified with a 50% clock duty cycle, performance is typically maintained over a clock duty cycle range of 40% to 60%.

The clock line should be series terminated at the clock source in the characteristic impedance of that line if the clock line is longer than

$$\frac{t_r}{6 \times t_{prop}} \quad (8)$$

where  $t_r$  is the clock rise time and  $t_{prop}$  is the propagation rate of the signal along the trace. For a typical board of FR-4 material,  $t_{PROP}$  is about 150 ps/in, or 60 ps/cm. The **CLOCK** pin may need to be a.c. terminated with a series RC such that the resistor value is equal to the characteristic impedance of the clock line and the capacitor value is

$$C \geq \frac{1.2 \times 10^{-9} \times l}{Z_0} \quad (9)$$

where "l" is the line length in inches and  $Z_0$  is the characteristic impedance of the clock line. This termination should be located as close as possible to, but within one centimeter of, the ADC12L066 clock pin as shown in [Figure 52](#). It should also be located beyond the ADC clock pin as seen from the clock source.

Take care to maintain a constant clock line impedance throughout the length of the line and to properly terminate the source end of the line with its characteristic impedance. Refer to Application Notes AN-905 ([SNLA035](#)) and AN-1113 ([SNLA011](#)) for information on setting characteristic impedance.

### $\overline{OE}$

The  $\overline{OE}$  pin, when high, puts the output pins into a high impedance state. When this pin is low the outputs are in the active state. The ADC12L066 will continue to convert whether this pin is high or low, but the output can not be read while the  $\overline{OE}$  pin is high.

Since ADC noise increases with increased output capacitance at the digital output pins, do use the TRI-STATE outputs of the ADC12L066 to drive a bus. Rather, each output pin should be located close to and drive a single digital input pin. To further reduce ADC noise, a 100  $\Omega$  resistor in series with each ADC digital output pin, located close to their respective pins, should be added to the circuit. See [Data Outputs](#)

### PD

The PD pin, when high, holds the ADC12L066 in a power-down mode to conserve power when the converter is not being used. The power consumption in this state is 50 mW with a 66 MHz clock and 30 mW if the clock is stopped. The output data pins are undefined in this mode. The data in the pipeline is corrupted while in the power down mode.

The Power Down Mode Exit Cycle time is determined by the value of the capacitors on pins 30, 31 and 32 and is about 300 ns with the recommended 0.1  $\mu$ F on these pins. These capacitors lose their charge in the Power Down mode and must be recharged by on-chip circuitry before conversions can be accurate. Smaller capacitor values allow faster recovery from the power down mode, but can result in a reduction in SNR, SINAD and ENOB performance.

## DATA OUTPUTS

The ADC12L066 has 12 TTL/CMOS compatible Data Output pins and the output format is offset binary. Valid offset binary data is present at these outputs while the  $\overline{OE}$  and PD pins are low. While the  $t_{OD}$  time provides information about output timing, a simple way to capture a valid output is to latch the data on the edge of the conversion clock (pin 10). Which edge to use will depend upon the clock frequency and duty cycle as well as the set-up and hold times of the receiving device or circuit. If the rising edge is used, the  $t_{OD}$  time can be used to determine maximum hold time acceptable of the driven device data inputs. If the falling edge of the clock is used, care must be taken to be sure that adequate setup and hold times are allowed for capturing the ADC output data.

Be very careful when driving a high capacitance bus. The more capacitance the output drivers must charge for each conversion, the more instantaneous digital current flows through  $V_{DR}$  and DR GND. These large charging current spikes can cause on-chip noise that can couple into the analog circuitry, degrading dynamic performance. Adequate power supply bypassing and careful attention to the ground plane will reduce this problem. Additionally, bus capacitance beyond the specified 15 pF/pin will cause  $t_{OD}$  to increase, making it difficult to properly latch the ADC output data. The result could be an apparent reduction in dynamic performance.

To minimize noise due to output switching, minimize the load currents at the digital outputs. This can be done by connecting buffers (74AC541, for example) between the ADC outputs and any other circuitry. Only one driven input should be connected to each output pin. Additionally, inserting series 100 $\Omega$  resistors at the digital outputs, close to the ADC pins, will isolate the outputs from trace and other circuit capacitances and limit the output currents, which could otherwise result in performance degradation. See [Figure 50](#).

While the ADC12L066 will operate with  $V_{DR}$  voltages down to 1.8V,  $t_{OD}$  increases with reduced  $V_{DR}$ . Be careful of external timing when using reduced  $V_{DR}$ .

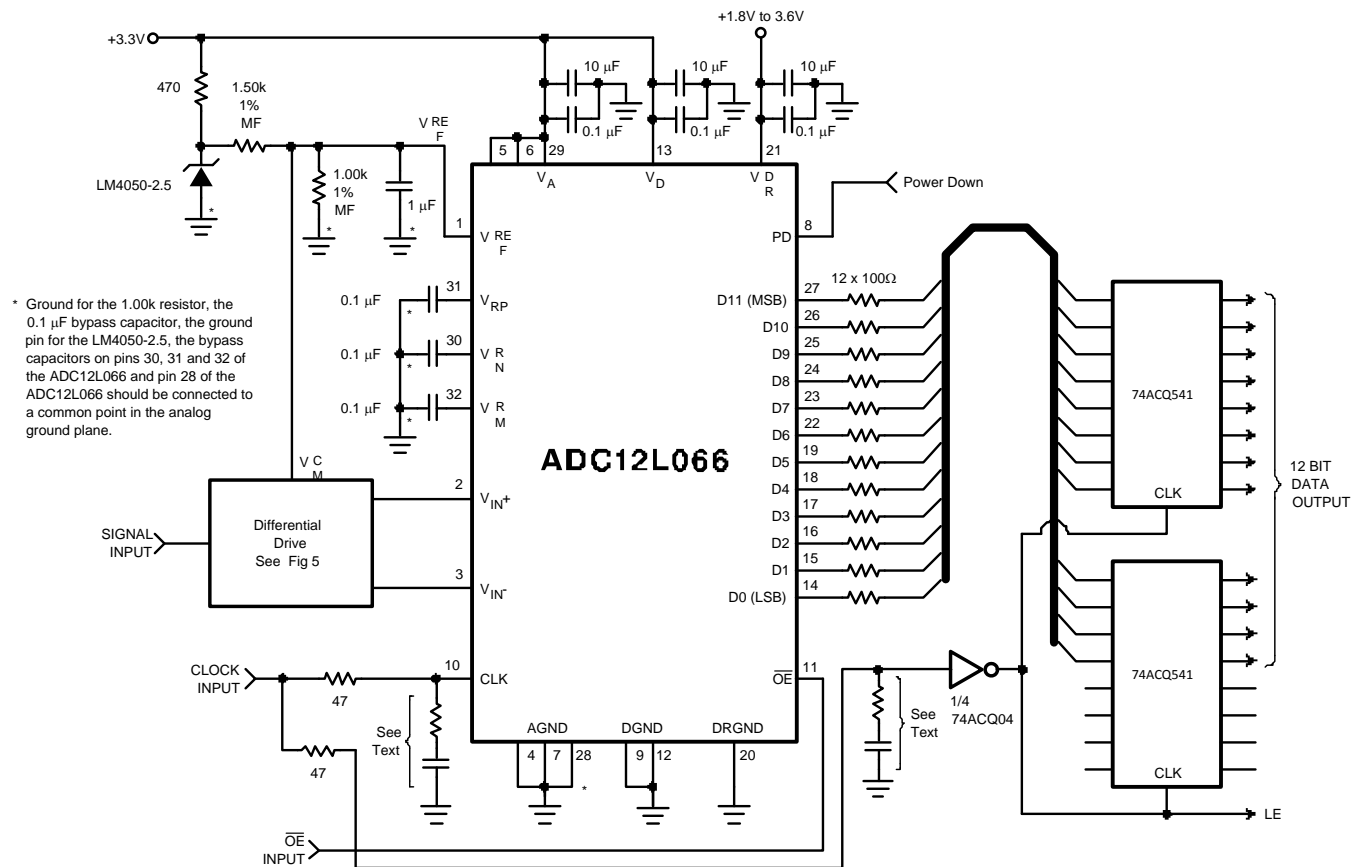

Figure 50. Simple Application Circuit with Single-Ended to Differential Buffer

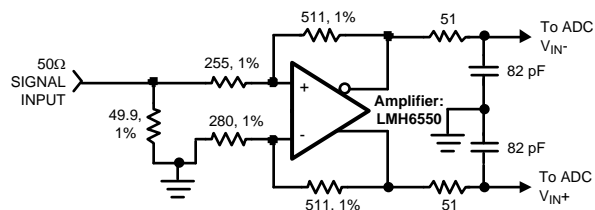
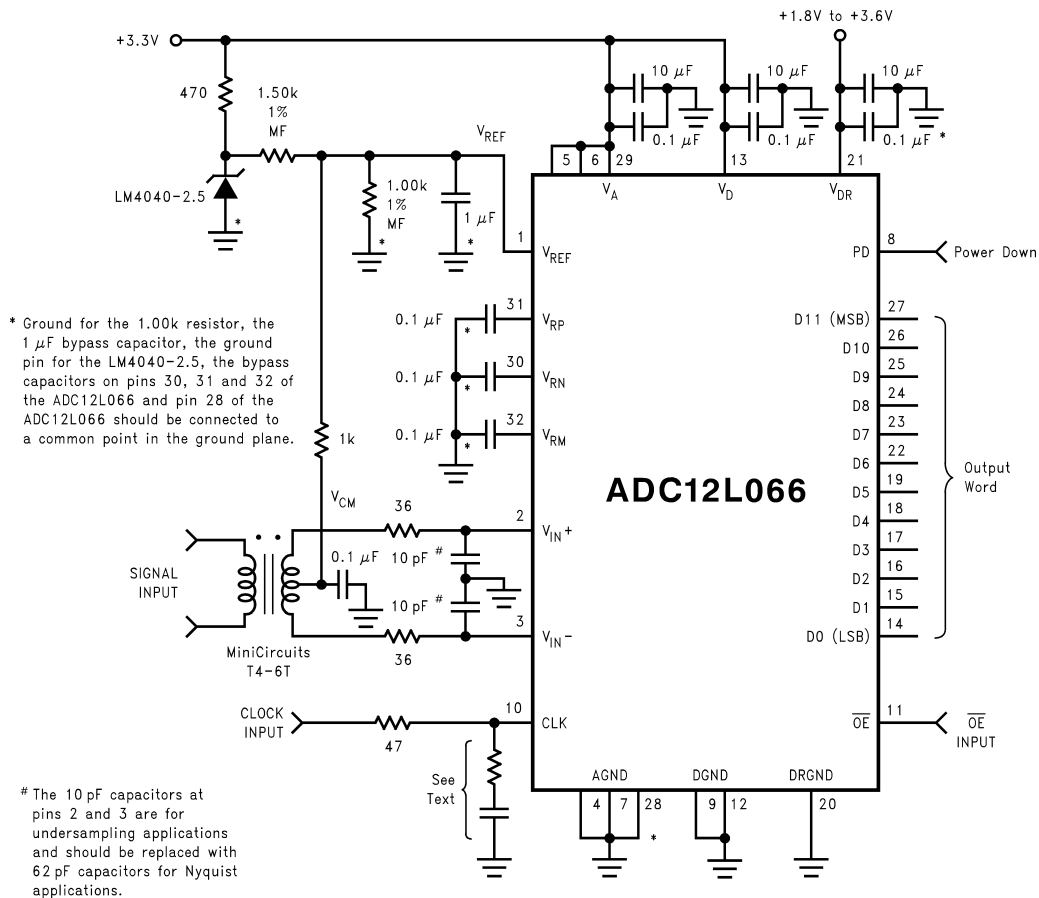

Figure 51. Differential Drive Circuit of Figure 50



**Figure 52. Driving the Signal Inputs with a Transformer**

## POWER SUPPLY CONSIDERATIONS

The power supply pins should be bypassed with a 10  $\mu$ F capacitor and with a 0.1  $\mu$ F ceramic chip capacitor within a centimeter of each power pin. Leadless chip capacitors are preferred because they have low series inductance.

As is the case with all high-speed converters, the ADC12L066 is sensitive to power supply noise. Accordingly, the noise on the analog supply pin should be kept below 100 mV<sub>P-P</sub>.

No pin should ever have a voltage on it that is in excess of the supply voltages, not even on a transient basis. Be especially careful of this during turn on and turn off of power.

The V<sub>DR</sub> pin provides power for the output drivers and may be operated from a supply in the range of 1.8V to V<sub>D</sub>. This can simplify interfacing to devices and systems operating with supplies less than V<sub>D</sub>. Note, however, that t<sub>OD</sub> increases with reduced V<sub>DR</sub>. **DO NOT operate the V<sub>DR</sub> pin at a voltage higher than V<sub>D</sub>.**

## LAYOUT AND GROUNDING

Proper grounding and proper routing of all signals are essential to ensure accurate conversion. Maintaining separate analog and digital areas of the board, with the ADC12L066 between these areas, is required to achieve specified performance.

The ground return for the data outputs (DR GND) carries the ground current for the output drivers. The output current can exhibit high transients that could add noise to the conversion process. To prevent this from happening, the DR GND pins should NOT be connected to system ground in close proximity to any of the ADC12L066's other ground pins.

Capacitive coupling between the typically noisy digital circuitry and the sensitive analog circuitry can lead to poor performance. The solution is to keep the analog circuitry separated from the digital circuitry, and to keep the clock line as short as possible.

Digital circuits create substantial supply and ground current transients. The logic noise thus generated could have significant impact upon system noise performance. The best logic family to use in systems with A/D converters is one which employs non-saturating transistor designs, or has low noise characteristics, such as the 74LS, 74HC(T) and 74AC(T) families. The worst noise generators are logic families that draw the largest supply current transients during clock or signal edges, like the 74F and the 74AC(T) families.

The effects of the noise generated from the ADC output switching can be minimized through the use of 100Ω resistors in series with each data output line. Locate these resistors as close to the ADC output pins as possible.

Since digital switching transients are composed largely of high frequency components, total ground plane copper weight will have little effect upon the logic-generated noise. This is because of the skin effect. Total surface area is more important than is total ground plane volume.

Generally, analog and digital lines should cross each other at 90° to avoid crosstalk. To maximize accuracy in high speed, high resolution systems, however, avoid crossing analog and digital lines altogether. It is important to keep clock lines as short as possible and isolated from ALL other lines, including other digital lines. Even the generally accepted 90° crossing should be avoided with the clock line as even a little coupling can cause problems at high frequencies. This is because other lines can introduce jitter into the clock line, which can lead to degradation of SNR. Also, the high speed clock can introduce noise into the analog chain.

Best performance at high frequencies and at high resolution is obtained with a straight signal path. That is, the signal path through all components should form a straight line wherever possible.

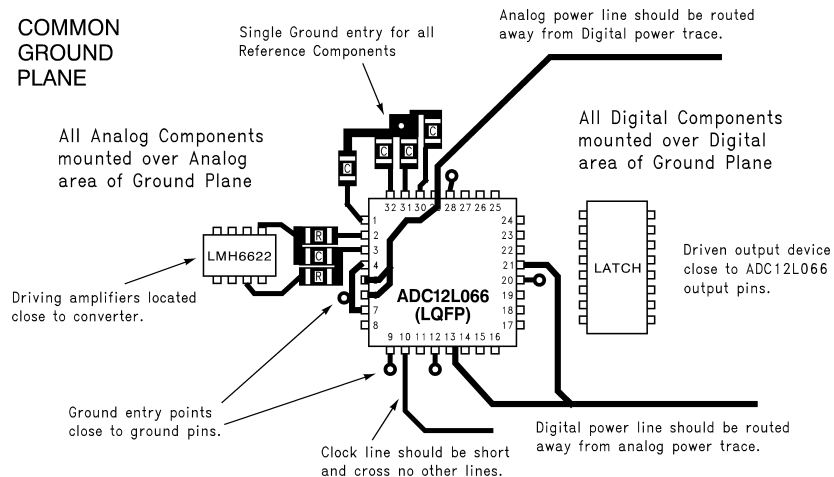

Figure 53. Example of a Suitable Layout

Be especially careful with the layout of inductors. Mutual inductance can change the characteristics of the circuit in which they are used. Inductors should *not* be placed side by side, even with just a small part of their bodies beside each other.

The analog input should be isolated from noisy signal traces to avoid coupling of spurious signals into the input. Any external component (e.g., a filter capacitor) connected between the converter's input pins and ground or to the reference input pin and ground should be connected to a very clean point in the ground plane.

Figure 53 gives an example of a suitable layout. All analog circuitry (input amplifiers, filters, reference components, etc.) should be placed in the analog area of the board. All digital circuitry and I/O lines should be placed in the digital area of the board. The ADC12L066 should be between these two areas. Furthermore, all components in the reference circuitry and the input signal chain that are connected to ground should be connected together with short traces and enter the ground plane at a single, quiet point. All ground connections should have a low inductance path to ground.

## DYNAMIC PERFORMANCE

To achieve the best dynamic performance, the clock source driving the CLK input must be free of jitter. Isolate the ADC clock from any digital circuitry with buffers, as with the clock tree shown in [Figure 54](#).

As mentioned in [Layout and Grounding](#), it is good practice to keep the ADC clock line as short as possible and to keep it well away from any other signals. Other signals can introduce jitter into the clock signal, which can lead to reduced SNR performance, and the clock can introduce noise into other lines. Even lines with 90° crossings have capacitive coupling, so try to avoid even these 90° crossings of the clock line.

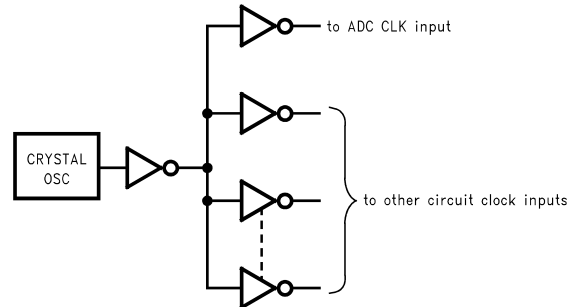

**Figure 54. Isolating the ADC Clock from other Circuitry with a Clock Tree**

## COMMON APPLICATION PITFALLS

**Driving the inputs (analog or digital) beyond the power supply rails.** For proper operation, all inputs should not go more than 100 mV beyond the supply rails (more than 100 mV below the ground pins or 100 mV above the supply pins). Exceeding these limits on even a transient basis may cause faulty or erratic operation. It is not uncommon for high speed digital components (e.g., 74F and 74AC devices) to exhibit overshoot or undershoot that goes above the power supply or below ground. A resistor of about 50Ω to 100Ω in series with any offending digital input, close to the signal source, will eliminate the problem.

Do not allow input voltages to exceed the supply voltage, even on a transient basis. Not even during power up or power down.

Be careful not to overdrive the inputs of the ADC12L066 with a device that is powered from supplies outside the range of the ADC12L066 supply. Such practice may lead to conversion inaccuracies and even to device damage.

**Attempting to drive a high capacitance digital data bus.** The more capacitance the output drivers must charge for each conversion, the more instantaneous digital current flows through  $V_{DR}$  and DR GND. These large charging current spikes can couple into the analog circuitry, degrading dynamic performance. Adequate bypassing and maintaining separate analog and digital areas on the pc board will reduce this problem.

Additionally, bus capacitance beyond the specified 15 pF/pin will cause  $t_{OD}$  to increase, making it difficult to properly latch the ADC output data. The result could, again, be a reduction in dynamic performance.

The digital data outputs should be buffered (with 74AC541, for example). Dynamic performance can also be improved by adding series resistors at each digital output, close to the ADC12L066, which reduces the energy coupled back into the converter output pins by limiting the output current. A reasonable value for these resistors is 100Ω.

**Using an inadequate amplifier to drive the analog input.** As explained in [Signal Inputs](#), the capacitance seen at the input alternates between 8 pF and 7 pF, depending upon the phase of the clock. This dynamic load is more difficult to drive than is a fixed capacitance.

If the amplifier exhibits overshoot, ringing, or any evidence of instability, even at a very low level, it will degrade performance. A small series resistor at each amplifier output and a capacitor across the analog inputs (as shown in [Figure 51](#) [Figure 52](#)) will improve performance. The LMH6702, LMH6628, LMH6622 and LMH6655 have been successfully used to drive the analog inputs of the ADC12L066.

Also, it is important that the signals at the two inputs have exactly the same amplitude and be exactly 180° out of phase with each other. Board layout, especially equality of the length of the two traces to the input pins, will affect the effective phase between these two signals. Remember that an operational amplifier operated in the non-inverting configuration will exhibit more time delay than will the same device operating in the inverting configuration.

**Operating with the reference pins outside of the specified range.** As mentioned in [Reference Pins](#),  $V_{REF}$  should be in the range of

$$0.8V \leq V_{REF} \leq 1.5V \quad (10)$$

Operating outside of these limits could lead to performance degradation.

**Using a clock source with excessive jitter, using excessively long clock signal trace, or having other signals coupled to the clock signal trace.** This will cause the sampling interval to vary, causing excessive output noise and a reduction in SNR and SINAD performance.

## REVISION HISTORY

| Changes from Revision H (March 2013) to Revision I         | Page               |
|--|--------------------|
| • Changed layout of National Data Sheet to TI format ..... | <a href="#">31</a> |



**PACKAGING INFORMATION**

| Orderable Device   | Status<br>(1) | Package Type | Package Drawing | Pins | Package Qty | Eco Plan<br>(2) | Lead finish/<br>Ball material<br>(6) | MSL Peak Temp<br>(3) | Op Temp (°C) | Device Marking<br>(4/5) | Samples   |
|--------------------|---------------|--------------|-----------------|------|-------------|-----------------|--------------------------------------|----------------------|--------------|-------------------------|---|
| ADC12L066CIVY/NOPB | ACTIVE        | LQFP         | NEY             | 32   | 250         | RoHS & Green    | SN                                   | Level-3-260C-168 HR  | -40 to 85    | ADC12L0<br>66CIVY       |  |

(1) The marketing status values are defined as follows:

**ACTIVE:** Product device recommended for new designs.

**LIFEBUY:** TI has announced that the device will be discontinued, and a lifetime-buy period is in effect.

**NRND:** Not recommended for new designs. Device is in production to support existing customers, but TI does not recommend using this part in a new design.

**PREVIEW:** Device has been announced but is not in production. Samples may or may not be available.

**OBsolete:** TI has discontinued the production of the device.

(2) **RoHS:** TI defines "RoHS" to mean semiconductor products that are compliant with the current EU RoHS requirements for all 10 RoHS substances, including the requirement that RoHS substance do not exceed 0.1% by weight in homogeneous materials. Where designed to be soldered at high temperatures, "RoHS" products are suitable for use in specified lead-free processes. TI may reference these types of products as "Pb-Free".

**RoHS Exempt:** TI defines "RoHS Exempt" to mean products that contain lead but are compliant with EU RoHS pursuant to a specific EU RoHS exemption.

**Green:** TI defines "Green" to mean the content of Chlorine (Cl) and Bromine (Br) based flame retardants meet JS709B low halogen requirements of <=1000ppm threshold. Antimony trioxide based flame retardants must also meet the <=1000ppm threshold requirement.

(3) MSL, Peak Temp. - The Moisture Sensitivity Level rating according to the JEDEC industry standard classifications, and peak solder temperature.

(4) There may be additional marking, which relates to the logo, the lot trace code information, or the environmental category on the device.

(5) Multiple Device Markings will be inside parentheses. Only one Device Marking contained in parentheses and separated by a "~" will appear on a device. If a line is indented then it is a continuation of the previous line and the two combined represent the entire Device Marking for that device.

(6) Lead finish/Ball material - Orderable Devices may have multiple material finish options. Finish options are separated by a vertical ruled line. Lead finish/Ball material values may wrap to two lines if the finish value exceeds the maximum column width.

**Important Information and Disclaimer:**The information provided on this page represents TI's knowledge and belief as of the date that it is provided. TI bases its knowledge and belief on information provided by third parties, and makes no representation or warranty as to the accuracy of such information. Efforts are underway to better integrate information from third parties. TI has taken and continues to take reasonable steps to provide representative and accurate information but may not have conducted destructive testing or chemical analysis on incoming materials and chemicals. TI and TI suppliers consider certain information to be proprietary, and thus CAS numbers and other limited information may not be available for release.

In no event shall TI's liability arising out of such information exceed the total purchase price of the TI part(s) at issue in this document sold by TI to Customer on an annual basis.

**TRAY**

Chamfer on Tray corner indicates Pin 1 orientation of packed units.

\*All dimensions are nominal

| Device             | Package Name | Package Type | Pins | SPQ | Unit array matrix | Max temperature (°C) | L (mm) | W (mm) | K0 (µm) | P1 (mm) | CL (mm) | CW (mm) |
|--------------------|--------------|--------------|------|-----|-------------------|----------------------|--------|--------|---------|---------|---------|---------|
| ADC12L066CIVY/NOPB | NEY          | LQFP         | 32   | 250 | 9 X 24            | 150                  | 322.6  | 135.9  | 7620    | 12.2    | 11.1    | 11.25   |

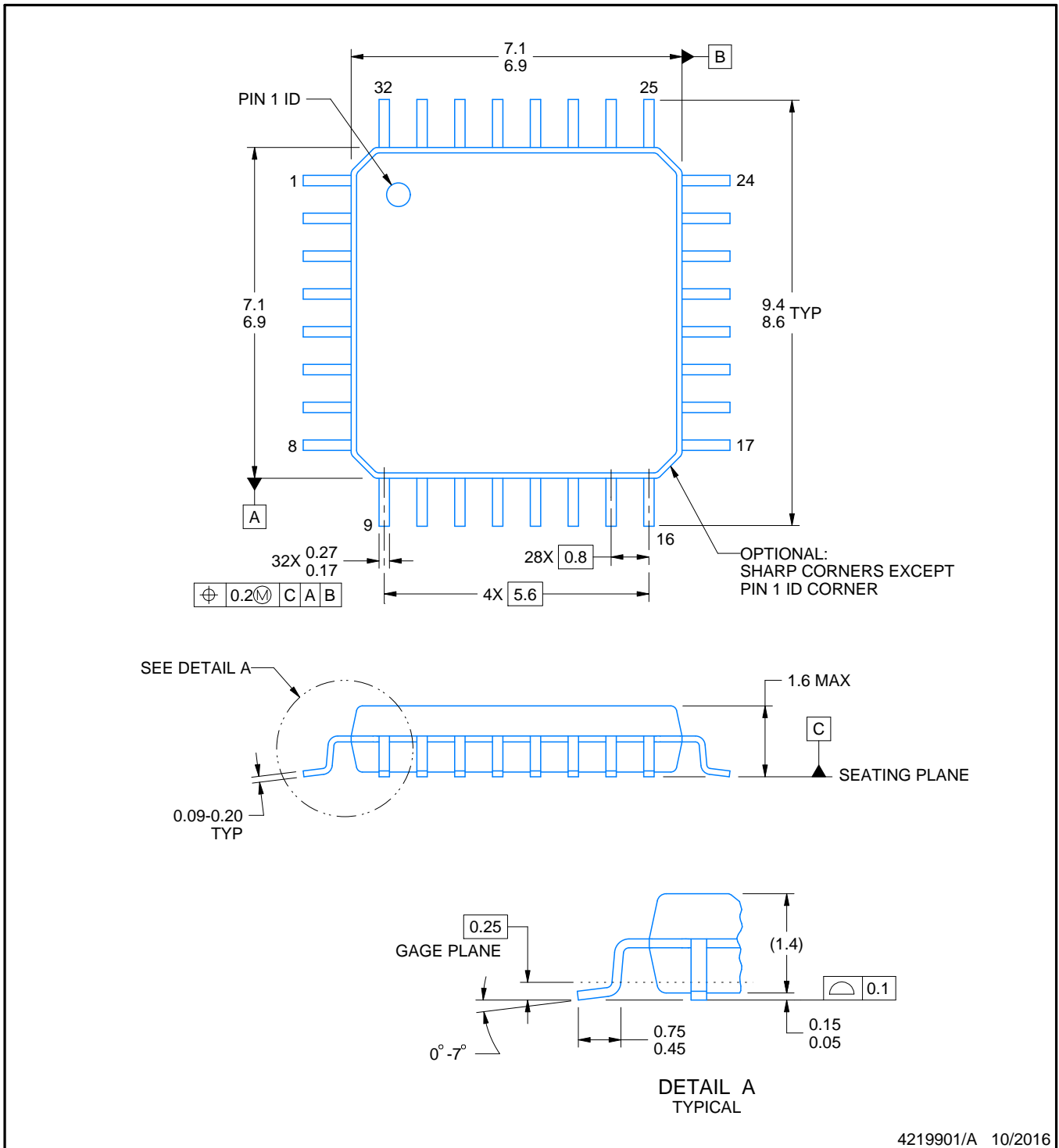
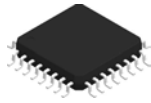

4219901/A 10/2016

NOTES:

1. All linear dimensions are in millimeters. Any dimensions in parenthesis are for reference only. Dimensioning and tolerancing per ASME Y14.5M.
2. This drawing is subject to change without notice.
3. Reference JEDEC registration MS-026.

# EXAMPLE BOARD LAYOUT

NEY0032A

LQFP - 1.6 mm max height

PLASTIC QUAD FLATPACK

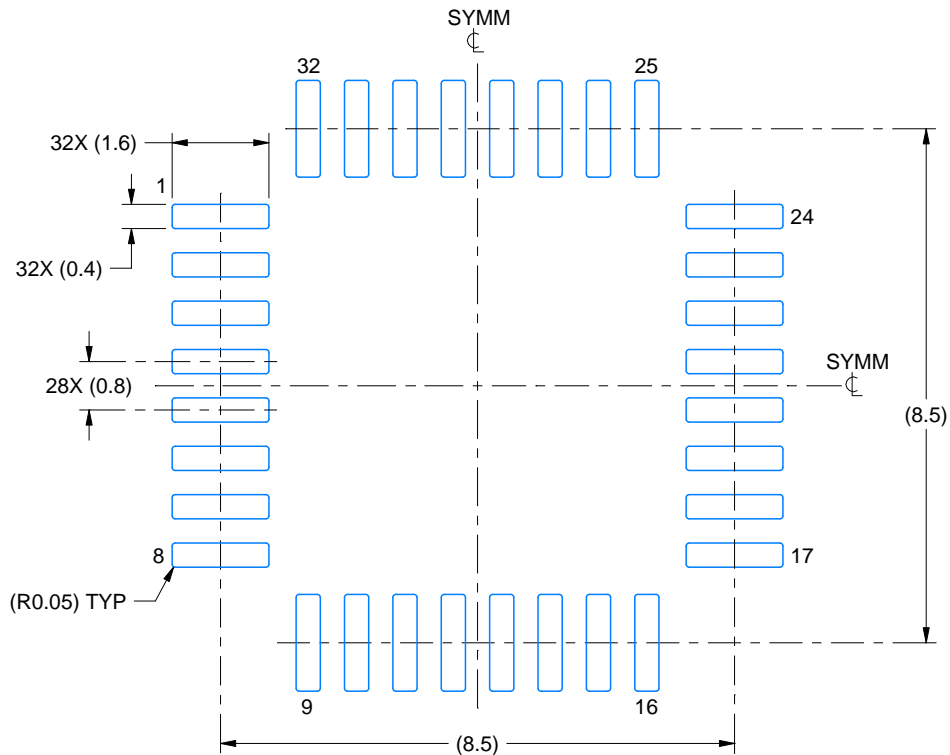

LAND PATTERN EXAMPLE  
SCALE:8X

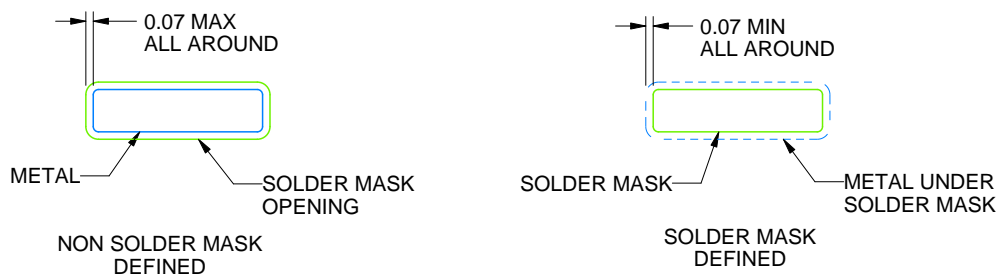

SOLDER MASK DETAILS

4219901/A 10/2016

NOTES: (continued)

4. Publication IPC-7351 may have alternate designs.
5. Solder mask tolerances between and around signal pads can vary based on board fabrication site.

# EXAMPLE STENCIL DESIGN

NEY0032A

LQFP - 1.6 mm max height

PLASTIC QUAD FLATPACK

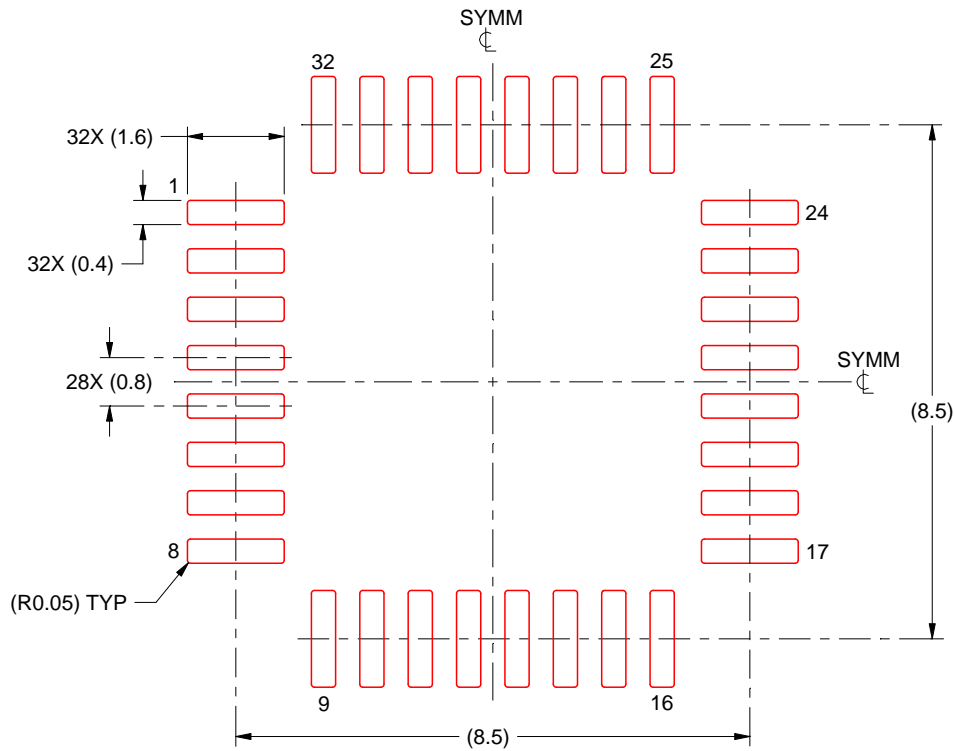

SOLDER PASTE EXAMPLE  
SCALE 8X

4219901/A 10/2016

NOTES: (continued)

6. Laser cutting apertures with trapezoidal walls and rounded corners may offer better paste release. IPC-7525 may have alternate design recommendations.
7. Board assembly site may have different recommendations for stencil design.

## IMPORTANT NOTICE AND DISCLAIMER

TI PROVIDES TECHNICAL AND RELIABILITY DATA (INCLUDING DATA SHEETS), DESIGN RESOURCES (INCLUDING REFERENCE DESIGNS), APPLICATION OR OTHER DESIGN ADVICE, WEB TOOLS, SAFETY INFORMATION, AND OTHER RESOURCES "AS IS" AND WITH ALL FAULTS, AND DISCLAIMS ALL WARRANTIES, EXPRESS AND IMPLIED, INCLUDING WITHOUT LIMITATION ANY IMPLIED WARRANTIES OF MERCHANTABILITY, FITNESS FOR A PARTICULAR PURPOSE OR NON-INFRINGEMENT OF THIRD PARTY INTELLECTUAL PROPERTY RIGHTS.

These resources are intended for skilled developers designing with TI products. You are solely responsible for (1) selecting the appropriate TI products for your application, (2) designing, validating and testing your application, and (3) ensuring your application meets applicable standards, and any other safety, security, regulatory or other requirements.

These resources are subject to change without notice. TI grants you permission to use these resources only for development of an application that uses the TI products described in the resource. Other reproduction and display of these resources is prohibited. No license is granted to any other TI intellectual property right or to any third party intellectual property right. TI disclaims responsibility for, and you will fully indemnify TI and its representatives against, any claims, damages, costs, losses, and liabilities arising out of your use of these resources.

TI's products are provided subject to [TI's Terms of Sale](#) or other applicable terms available either on [ti.com](https://www.ti.com) or provided in conjunction with such TI products. TI's provision of these resources does not expand or otherwise alter TI's applicable warranties or warranty disclaimers for TI products.

TI objects to and rejects any additional or different terms you may have proposed.

Mailing Address: Texas Instruments, Post Office Box 655303, Dallas, Texas 75265  
Copyright © 2023, Texas Instruments Incorporated