

# CC1354P10 SimpleLink™ High-Performance Multi-band Wireless MCU With Integrated Power Amplifier

## 1 Features

### Wireless microcontroller

- Powerful 48 MHz Arm® Cortex®-M33 processor with TrustZone®
- FPU and DSP extension
- 1024 kB flash program memory
- 8 kB of cache SRAM
- 256 kB of ultra-low leakage SRAM with parity for high-reliability operation
  - 32 kB of additional SRAM is available if parity is disabled
- Dual-band Sub-1 GHz and 2.4 GHz operation
- Dynamic multiprotocol manager (DMM) driver
- Programmable radio includes support for 2-(G)FSK, 4-(G)FSK, MSK, OOK, IEEE 802.15.4 PHY and MAC
- Supports over-the-air upgrade (OTA)

### Ultra-low power sensor controller

- Autonomous MCU with 4 kB of SRAM
- Sample, store, and process sensor data
- Fast wake-up for low-power operation
- Software defined peripherals; capacitive touch, flow meter, LCD

### Low power consumption

- MCU consumption:
  - 3.4 mA active mode, CoreMark®
  - 71 µA/MHz running CoreMark®
  - 0.98 µA standby mode, RTC, 256 kB RAM
  - 0.17 µA shutdown mode, wake-up on pin
- Ultra low-power sensor controller consumption
  - 32 µA in 2 MHz mode
  - 849 µA in 24 MHz mode
- Radio consumption:
  - 5.8 mA RX at 868 MHz
  - 6.9 mA RX at 2.4 GHz
  - 22 mA TX at +10 dBm at 2.4 GHz
  - 25.8 mA TX at +14 dBm at 868 MHz
  - 69 mA TX at +20 dBm at 915 MHz
  - 101 mA TX at +20 dBm at 2.4 GHz

### Wireless protocol support

- [Thread](#), [Zigbee®](#), [Matter](#)
- [Bluetooth® 5.3 Low Energy](#)
- [Wi-SUN®](#)
- [mioty®](#)
- [Amazon Sidewalk](#)
- [Wireless M-Bus](#)

- [SimpleLink™ TI 15.4-Stack \(Sub-1 GHz\)](#)
- [6LoWPAN](#)
- [Proprietary Systems](#)

### High performance radio

- Up to 130 dB link budget at 50 kbps, 868 MHz
- Up to 141 dB link budget at 2.5 kbps, 868 MHz
- –121 dBm for 2.5 kbps long-range mode
- –110 dBm at 50 kbps, 802.15.4, 868 MHz
- –104 dBm for Bluetooth® Low Energy 125 kbps
- –105 dBm for IEEE 802.15.4-2006 2.4 GHz OQPSK (coherent modem)
- Output power up to +20 dBm with temperature compensation

### Regulatory compliance

- Designed for systems targeting compliance with these standards:
  - ETSI EN 300 220 Receiver Cat. 1.5 and 2, EN 300 328, EN 303 131, EN 303 204, EN 300 440 Cat. 2 and 3
  - FCC CFR47 Part 15
  - ARIB STD-T66, STD-T67 and STD-T108

### MCU peripherals

- Most digital peripherals can be routed to any GPIO
- Four 32-bit or eight 16-bit general-purpose timers
- 12-bit SAR ADC, 200 ksps, 8 channels
- 8-bit DAC
- Two comparators
- Programmable current source
- Four UART, four SPI, two I<sup>2</sup>C, one I<sup>2</sup>S
- Real-time clock (RTC)
- Integrated temperature and battery monitor

### Security enablers

- Supports secure boot
- Supports secure key storage and device ID
- Arm® TrustZone® for trusted execution environment
- AES 128- and 256-bit cryptographic accelerator
- Public key accelerator
- SHA2 accelerator (full suite up to SHA-512)
- True random number generator (TRNG)
- Secure debug lock
- Software anti-rollback protection

### Development tools and software

- [LP-EM-CC1354P10-1](#) for dual-band and +20 dBm output power on 868/915 MHz



**CC1354P10**

SWRS267B – DECEMBER 2022 – REVISED DECEMBER 2023

- [LP-EM-CC1354P10-6](#) for dual-band and +10 dBm output power on 2.4 GHz
- [LP-XDS110](#), [LP-XDS110ET](#) or [TMDSEMU110-U](#) (with [TMDSEMU110-ETH](#) add-on) Debug Probe
- [SimpleLink™ LOWPOWER F2 Software Development Kit \(SDK\)](#)
- [SmartRF™ Studio](#) for simple radio configuration
- [Sensor Controller Studio](#) for building low-power sensing applications
- [SysConfig](#) system configuration tool
- HVAC – [thermostat](#), [wireless environmental sensor](#), [HVAC system controller](#), [gateway](#)
- Fire safety system – [smoke and heat detector](#), [fire alarm control panel \(FACP\)](#)
- Video surveillance – [IP network camera](#)
- Elevators and escalators – [elevator main control panel for elevators and escalators](#)
- [Grid infrastructure](#)
  - Smart meters – [water meter](#), [gas meter](#), [electricity meter](#), and [heat cost allocators](#)
  - Grid communications – [wireless communications](#) – Long-range sensor applications
  - Other alternative energy – [energy harvesting](#)
- [Industrial transport](#) – [asset tracking](#)
- [Factory automation and control](#)
- [Medical](#)
- [Communication equipment](#)
  - [Wired networking](#) – [wireless LAN or Wi-Fi access points](#), [edge router](#)
- [Personal electronics](#)
  - [Home theater & entertainment](#) – [smart speakers](#), [smart display](#), [set-top box](#)
  - [Wearables \(non-medical\)](#) – [smart trackers](#), [smart clothing](#)

### Operating range

- On-chip buck DC/DC converter
- 1.8 V to 3.8 V single supply voltage
- –40°C to +105°C

### Package

- 7 mm × 7 mm RGZ VQFN48 (26 GPIOs)
- 8 mm × 8 mm RSK VQFN64 (42 GPIOs)
- RoHS-compliant package

## 2 Applications

- 315, 433, 470 to 510, 868, 902 to 928, and 2400 to 2480 MHz ISM and SRD systems<sup>1</sup> with down to 4 kHz of receive bandwidth
- [Building automation](#)
  - Building security systems – [motion detector](#), [electronic smart lock](#), [door and window sensor](#), [garage door system](#), [gateway](#)

## 3 Description

The SimpleLink™ CC1354P10 device is a multiprotocol and multi-band Sub-1 GHz and 2.4 GHz wireless microcontroller (MCU) supporting [Thread](#), [Zigbee®](#), [Bluetooth 5.3 Low Energy](#), IEEE 802.15.4g, IPv6-enabled smart objects (6LoWPAN), [mioty](#), [Wi-SUN](#), [Amazon Sidewalk](#), [proprietary systems](#), including the TI 15.4-Stack (Sub-1 GHz and 2.4 GHz), and [concurrent multiprotocol](#) through a [Dynamic Multiprotocol Manager \(DMM\)](#) driver. The device is optimized for low-power wireless communications, with advanced security features and on-chip over-the-air (OAD) update capability. It enables long range and reliable communication in [building security systems](#), [HVAC](#), [smart meters](#), [medical](#), [wired networking](#), [portable electronics](#), [home theater & entertainment](#), and [connected peripherals](#) markets. The highlighted features of this device include:

- Arm® TrustZone® based secure key storage, device ID and trusted functions support.
- Multi-band device supporting concurrent multiprotocol for both Sub-1 GHz and 2.4 GHz through a DMM driver.
- Wide flexibility of protocol stack support in the [SimpleLink LOWPOWER F2 Software Development Kit \(SDK\)](#).
- Enablement of long-range and low-power applications using the integrated +20 dBm high-power amplifier with best-in-class transmit current consumption at 64 mA for Sub-1 GHz and 101 mA for 2.4 GHz operation.
- Maximum transmit power of +14 dBm at Sub-1 GHz with 24.9 mA and +5 dBm at 2.4 GHz with 9.6 mA current consumption.
- Optimized for coin-cell operation at +10 dBm at 2.4 GHz with 22 mA current consumption.
- Longer battery life wireless applications with low standby current of 0.98 µA and full RAM retention.
- Industrial temperature ready with lowest standby current of 5 µA at 85 °C.

<sup>1</sup> See [RF Core](#) for additional details on supported protocol standards, modulation formats, and data rates.

- Advanced sensing with a programmable, autonomous ultra-low power [Sensor Controller CPU](#) with fast wake-up capability. As an example, the sensor controller is capable of 1 Hz ADC sampling at 1  $\mu$ A system current.
- Low [Soft Error Rate \(SER\)](#) Failure-in-Time (FIT) for long operation lifetime with no disruption for industrial markets with always-on SRAM parity against corruption due to potential radiation events.
- Dedicated software controlled radio controller (Arm<sup>®</sup> Cortex<sup>®</sup>-M0) providing flexible low-power RF transceiver capability to support multiple physical layers and RF standards.
- Excellent radio sensitivity (-121 dBm) and robustness (selectivity and blocking) performance for SimpleLink<sup>™</sup> long-range mode.

The CC1354P10 device is part of the SimpleLink<sup>™</sup> MCU platform, which consists of Wi-Fi<sup>®</sup>, *Bluetooth* Low Energy, Thread, Zigbee, Sub-1 GHz MCUs, and host MCUs that all share a common, easy-to-use development environment with a single core software development kit (SDK) and rich tool set. A one-time integration of the SimpleLink<sup>™</sup> platform enables you to add any combination of the portfolio's devices into your design, allowing 100 percent code reuse when your design requirements change. For more information, visit [SimpleLink MCU platform](#).

In addition to the software compatibility, within the multi-band wireless MCUs, there is pin-to-pin compatibility from 352 kB of flash up to 1 MB of flash in the 7 × 7 mm QFN package for maximum design scalability. For more information on TIs Sub-1 GHz solutions, visit [www.ti.com/sub1ghz](http://www.ti.com/sub1ghz)

#### Device Information

PART NUMBER <sup>(1)</sup>	PACKAGE	BODY SIZE (NOM)
CC1354P106T0RGZ	VQFN (48)	7.00 mm × 7.00 mm
CC1354P106T0RSK	VQFN (64)	8.00 mm × 8.00 mm

- (1) For the most current part, package, and ordering information for all available devices, see the Package Option Addendum in [Section 12](#), or see the [TI website](#).

## 4 Functional Block Diagram

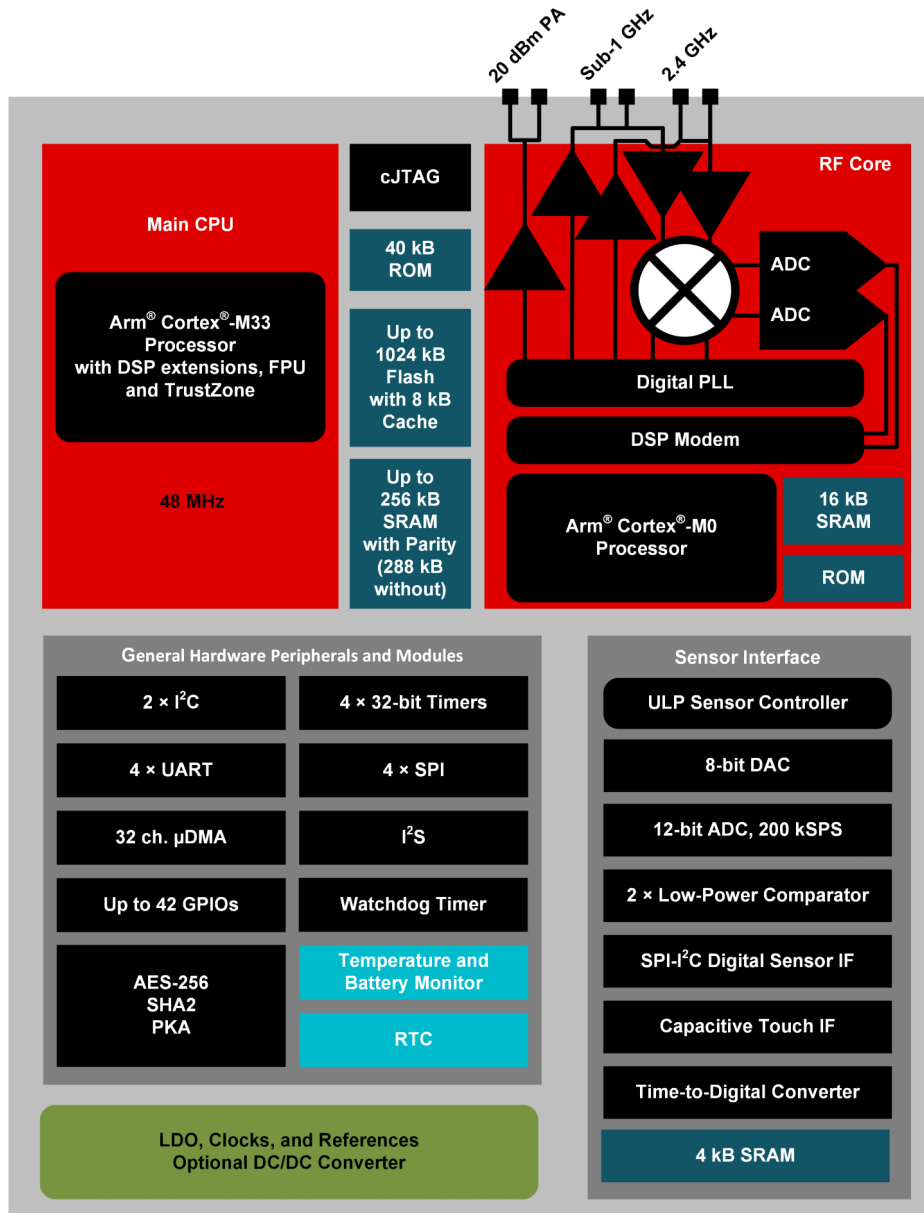


Figure 4-1. CC1354P10 Block Diagram

## Table of Contents

<b>1 Features</b> .....	1
<b>2 Applications</b> .....	2
<b>3 Description</b> .....	2
<b>4 Functional Block Diagram</b> .....	4
<b>5 Revision History</b> .....	5
<b>6 Device Comparison</b> .....	6
<b>7 Terminal Configuration and Functions</b> .....	7
7.1 Pin Diagram – RGZ Package (Top View).....	7
7.2 Signal Descriptions – RGZ Package.....	8
7.3 Connections for Unused Pins and Modules – RGZ Package.....	9
7.4 Pin Diagram – RSK Package (Top View).....	10
7.5 Signal Descriptions – RSK Package.....	11
7.6 Connection of Unused Pins and Module – RSK Package.....	13
<b>8 Specifications</b> .....	14
8.1 Absolute Maximum Ratings.....	14
8.2 ESD Ratings.....	14
8.3 Recommended Operating Conditions.....	14
8.4 Power Supply and Modules.....	14
8.5 Power Consumption - Power Modes.....	16
8.6 Power Consumption - Radio Modes.....	17
8.7 Nonvolatile (Flash) Memory Characteristics.....	17
8.8 Thermal Resistance Characteristics.....	17
8.9 RF Frequency Bands.....	18
8.10 861 MHz to 1054 MHz - Receive (RX).....	19
8.11 861 MHz to 1054 MHz - Transmit (TX).....	27
8.12 861 MHz to 1054 MHz - PLL Phase Noise Wideband Mode.....	28
8.13 861 MHz to 1054 MHz - PLL Phase Noise Narrowband Mode.....	29
8.14 Bluetooth Low Energy - Receive (RX).....	30
8.15 Bluetooth Low Energy - Transmit (TX).....	33
8.16 Zigbee and Thread - IEEE 802.15.4-2006 2.4 GHz (OQPSK DSSS1:8, 250 kbps) - RX.....	34
8.17 Zigbee and Thread - IEEE 802.15.4-2006 2.4 GHz (OQPSK DSSS1:8, 250 kbps) - TX.....	35
8.18 Timing and Switching Characteristics.....	35
8.19 Peripheral Characteristics.....	41
8.20 Typical Characteristics.....	49
<b>9 Detailed Description</b> .....	61
9.1 Overview.....	61
9.2 System CPU.....	61
9.3 Radio (RF Core).....	62
9.4 Memory.....	65
9.5 Sensor Controller.....	66
9.6 Cryptography.....	67
9.7 Timers.....	68
9.8 Serial Peripherals and I/O.....	69
9.9 Battery and Temperature Monitor.....	69
9.10 $\mu$ DMA.....	69
9.11 Debug.....	69
9.12 Power Management.....	71
9.13 Clock Systems.....	72
9.14 Network Processor.....	72
<b>10 Application, Implementation, and Layout</b> .....	73
10.1 Reference Designs.....	73
<b>11 Device and Documentation Support</b> .....	75
11.1 Tools and Software.....	75
11.2 Documentation Support.....	78
11.3 Support Resources.....	79
11.4 Trademarks.....	79
11.5 Electrostatic Discharge Caution.....	79
11.6 Glossary.....	79
<b>12 Mechanical, Packaging, and Orderable Information</b> .....	80
12.1 Packaging Information.....	80

## 5 Revision History

NOTE: Page numbers for previous revisions may differ from page numbers in the current version.

### Changes from June 20, 2023 to December 14, 2023 (from Revision A (June 2023) to Revision B (December 2023))

	Page
• Removed preliminary information footnote for RSK package.....	1
• Updated <a href="#">Device Comparison</a> table.....	6
• Updated graphs and tables on <a href="#">Typical characteristics</a> .....	49
• Added EnergyTrace information to <a href="#">Section 9.11, Debug</a> .....	69

## 6 Device Comparison

Device	RADIO SUPPORT											FLASH (kB)	RAM + Cache (kB)	GPIO	PACKAGE SIZE					
	Sub-1 GHz Prop.	2.4GHz Prop.	Wireless M-Bus	mioty	Wi-SUN®	Sidewalk	Bluetooth® LE	ZigBee	Thread	Multiprotocol	+20 dBm PA				4 x 4 mm VQFN (24)	4 x 4 mm VQFN (32)	5 x 5 mm VQFN (32)	5 x 5 mm VQFN (40)	7 x 7 mm VQFN (48)	8 x 8 mm VQFN (64)
CC1310	√		√	√								32-128	16-20 + 8	10-30		√	√		√	
CC1311R3	√		√	√								352	32 + 8	22-30				√	√	
CC1311P3	√		√	√							√	352	32 + 8	26					√	
CC1312R	√		√	√	√							352	80 + 8	30					√	
CC1312R7	√		√	√	√	√			√			704	144 + 8	30					√	
CC1314R10	√		√	√	√	√			√			1024	256 + 8	30-46					√	√
CC1352R	√	√	√	√	√		√	√	√	√		352	80 + 8	28					√	
CC1354R10	√	√	√	√	√		√	√	√	√		1024	256 + 8	28-42					√	√
CC1352P	√	√	√	√	√		√	√	√	√	√	352	80 + 8	26					√	
CC1352P7	√	√	√	√	√	√	√	√	√	√	√	704	144 + 8	26					√	
CC1354P10	√	√	√	√	√	√	√	√	√	√	√	1024	256 + 8	26-42					√	√
CC2340R5 <sup>(1)</sup>		√					√	√	√			512	36	12-26	√			√		
CC2640R2F							√					128	20 + 8	10-31		√	√		√	
CC2642R							√					352	80 + 8	31					√	
CC2642R-Q1							√					352	80 + 8	31					√	
CC2651R3		√					√	√				352	32 + 8	23-31				√	√	
CC2651P3		√					√	√		√		352	32 + 8	22-26				√	√	
CC2652R		√					√	√	√	√		352	80 + 8	31					√	
CC2652RB		√					√	√	√	√		352	80 + 8	31					√	
CC2652R7		√					√	√	√	√		704	144 + 8	31					√	
CC2652P		√					√	√	√	√	√	352	80 + 8	26					√	
CC2652P7		√					√	√	√	√	√	704	144 + 8	26					√	
CC2674R10		√					√	√	√	√		1024	256 + 8	31-45					√	√
CC2674P10		√					√	√	√	√	√	1024	256 + 8	26-45					√	√

(1) ZigBee and Thread support enabled by future software update

## 7 Terminal Configuration and Functions

### 7.1 Pin Diagram – RGZ Package (Top View)

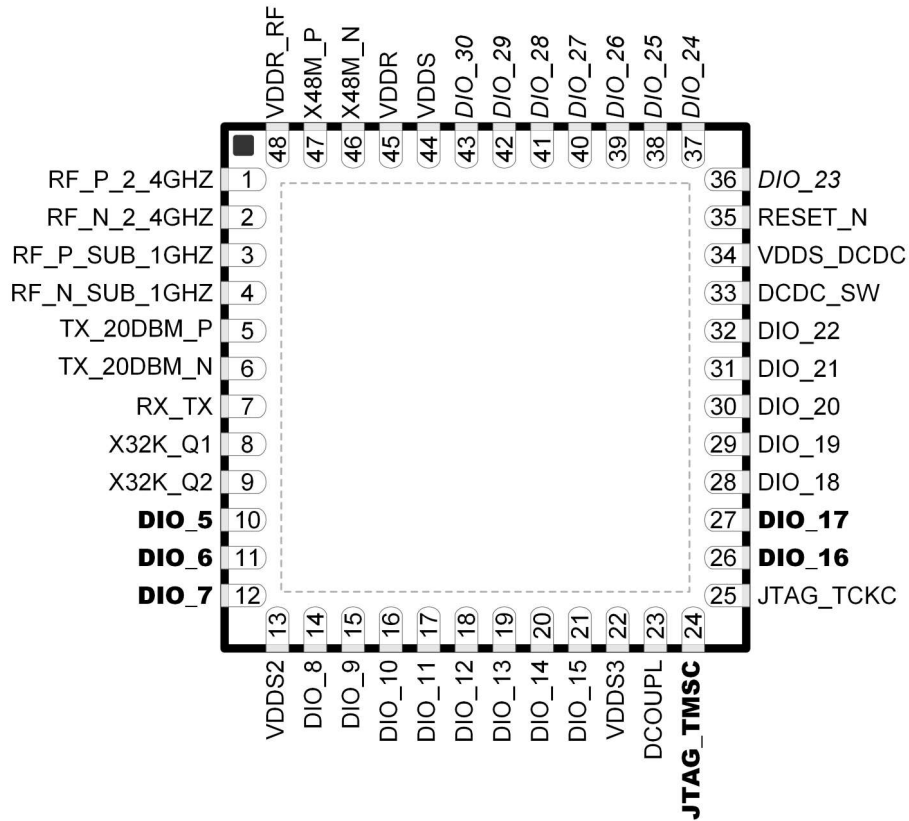


Figure 7-1. RGZ (7 mm × 7 mm) Pinout, 0.5 mm Pitch (Top View)

The following I/O pins marked in [Figure 7-1](#) in **bold** have high-drive capabilities:

- Pin 10, **DIO\_5**
- Pin 11, **DIO\_6**
- Pin 12, **DIO\_7**
- Pin 24, **JTAG\_TMISC**
- Pin 26, **DIO\_16**
- Pin 27, **DIO\_17**

The following I/O pins marked in [Figure 7-1](#) in *italics* have analog capabilities:

- Pin 36, *DIO\_23*
- Pin 37, *DIO\_24*
- Pin 38, *DIO\_25*
- Pin 39, *DIO\_26*
- Pin 40, *DIO\_27*
- Pin 41, *DIO\_28*
- Pin 42, *DIO\_29*
- Pin 43, *DIO\_30*

## 7.2 Signal Descriptions – RGZ Package

**Table 7-1. Signal Descriptions – RGZ Package**

PIN		I/O	TYPE	DESCRIPTION
NAME	NO.			
DCDC_SW	33	—	Power	Output from internal DC/DC converter <sup>(1)</sup>
DCOUPPL	23	—	Power	For decoupling of internal 1.27 V regulated digital-supply <sup>(2)</sup>
DIO_5	10	I/O	Digital	GPIO, high-drive capability
DIO_6	11	I/O	Digital	GPIO, high-drive capability
DIO_7	12	I/O	Digital	GPIO, high-drive capability
DIO_8	14	I/O	Digital	GPIO
DIO_9	15	I/O	Digital	GPIO
DIO_10	16	I/O	Digital	GPIO
DIO_11	17	I/O	Digital	GPIO
DIO_12	18	I/O	Digital	GPIO
DIO_13	19	I/O	Digital	GPIO
DIO_14	20	I/O	Digital	GPIO
DIO_15	21	I/O	Digital	GPIO
DIO_16	26	I/O	Digital	GPIO, JTAG_TDO, high-drive capability
DIO_17	27	I/O	Digital	GPIO, JTAG_TDI, high-drive capability
DIO_18	28	I/O	Digital	GPIO
DIO_19	29	I/O	Digital	GPIO
DIO_20	30	I/O	Digital	GPIO
DIO_21	31	I/O	Digital	GPIO
DIO_22	32	I/O	Digital	GPIO
DIO_23	36	I/O	Digital or Analog	GPIO, analog capability
DIO_24	37	I/O	Digital or Analog	GPIO, analog capability
DIO_25	38	I/O	Digital or Analog	GPIO, analog capability
DIO_26	39	I/O	Digital or Analog	GPIO, analog capability
DIO_27	40	I/O	Digital or Analog	GPIO, analog capability
DIO_28	41	I/O	Digital or Analog	GPIO, analog capability
DIO_29	42	I/O	Digital or Analog	GPIO, analog capability
DIO_30	43	I/O	Digital or Analog	GPIO, analog capability
EGP	—	—	GND	Ground – exposed ground pad <sup>(3)</sup>
JTAG_TMSC	24	I/O	Digital	JTAG TMSC, high-drive capability
JTAG_TCKC	25	I	Digital	JTAG TCKC
RESET_N	35	I	Digital	Reset, active low. No internal pullup resistor
RF_P_2_4GHZ	1	—	RF	Positive 2.4 GHz RF input signal to LNA during RX Positive 2.4 GHz RF output signal from PA during TX
RF_N_2_4GHZ	2	—	RF	Negative 2.4 GHz RF input signal to LNA during RX Negative 2.4 GHz RF output signal from PA during TX
RF_P_SUB_1GHZ	3	—	RF	Positive Sub-1 GHz RF input signal to LNA during RX Positive Sub-1 GHz RF output signal from PA during TX
RF_N_SUB_1GHZ	4	—	RF	Negative Sub-1 GHz RF input signal to LNA during RX Negative Sub-1 GHz RF output signal from PA during TX
RX_TX	7	—	RF	Optional bias pin for the RF LNA
TX_20DBM_P	5	—	RF	Positive Sub-1 GHz or 2.4 GHz high-power TX signal
TX_20DBM_N	6	—	RF	Negative Sub-1 GHz or 2.4 GHz high-power TX signal



**Table 7-1. Signal Descriptions – RGZ Package (continued)**

PIN		I/O	TYPE	DESCRIPTION
NAME	NO.			
VDDR	45	—	Power	Internal supply, must be powered from the internal DC/DC converter or the internal LDO <sup>(2)</sup> <sup>(4)</sup> <sup>(6)</sup>
VDDR_RF	48	—	Power	Internal supply, must be powered from the internal DC/DC converter or the internal LDO <sup>(2)</sup> <sup>(5)</sup> <sup>(6)</sup>
VDDS	44	—	Power	1.8 V to 3.8 V main chip supply <sup>(1)</sup>
VDDS2	13	—	Power	1.8 V to 3.8 V DIO supply <sup>(1)</sup>
VDDS3	22	—	Power	1.8 V to 3.8 V DIO supply <sup>(1)</sup>
VDDS_DCDC	34	—	Power	1.8 V to 3.8 V DC/DC converter supply
X48M_N	46	—	Analog	48 MHz crystal oscillator pin N
X48M_P	47	—	Analog	48 MHz crystal oscillator pin P
X32K_Q1	8	—	Analog	32 kHz crystal oscillator pin 1
X32K_Q2	9	—	Analog	32 kHz crystal oscillator pin 2

- (1) For more details, see technical reference manual listed in [Section 11.2](#).
- (2) Do not supply external circuitry from this pin.
- (3) EGP is the only ground connection for the device. Good electrical connection to device ground on printed circuit board (PCB) is imperative for proper device operation.
- (4) If internal DC/DC converter is not used, this pin is supplied internally from the main LDO.
- (5) If internal DC/DC converter is not used, this pin must be connected to VDDR for supply from the main LDO.
- (6) Output from internal DC/DC and LDO is trimmed to 1.68 V.

### 7.3 Connections for Unused Pins and Modules – RGZ Package

**Table 7-2. Connections for Unused Pins – RGZ Package**

FUNCTION	SIGNAL NAME	PIN NUMBER	ACCEPTABLE PRACTICE <sup>(1)</sup>	PREFERRED PRACTICE <sup>(1)</sup>
GPIO	DIO_n	10–12	NC or GND	NC
		14–21		
		26–32		
		36–43		
32.768 kHz crystal	X32K_Q1		NC or GND	NC
	X32K_Q2	9		
DC/DC converter <sup>(2)</sup>	DCDC_SW	33	NC	NC
	VDDS_DCDC	34	VDDS	VDDS

- (1) NC = No connect
- (2) When the DC/DC converter is not used, the inductor between DCDC\_SW and VDDR can be removed. VDDR and VDDR\_RF must still be connected and the 22  $\mu$ F DCDC capacitor must be kept on the VDDR net.

## 7.4 Pin Diagram – RSK Package (Top View)

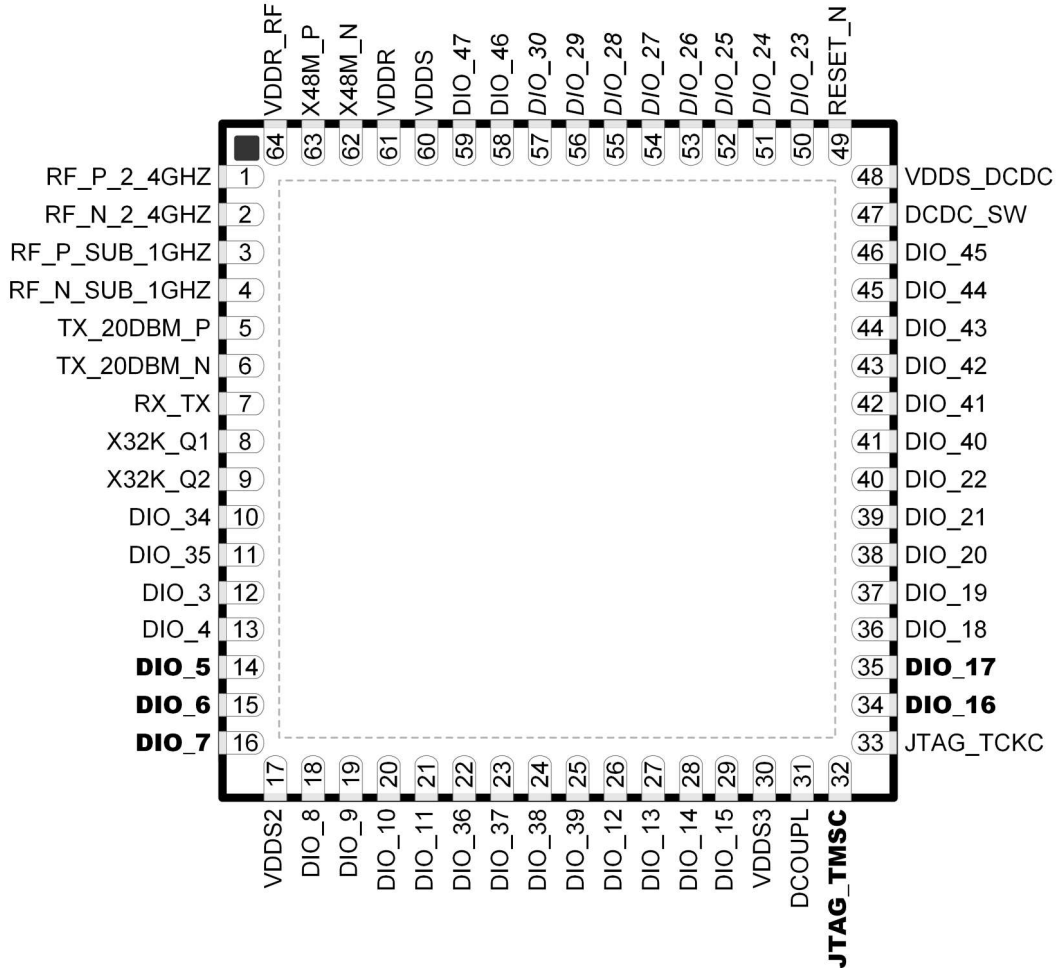


Figure 7-2. RSK (8 mm × 8 mm) Pinout, 0.4 mm Pitch (Top View)

The following I/O pins marked in [Figure 7-2](#) in **bold** have high-drive capabilities:

- Pin 14, DIO\_5
- Pin 15, DIO\_6
- Pin 16, DIO\_7
- Pin 32, JTAG\_TMESC
- Pin 34, DIO\_16
- Pin 35, DIO\_17

The following I/O pins marked in [Figure 7-2](#) in *italics* have analog capabilities:

- Pin 50, DIO\_23
- Pin 51, DIO\_24
- Pin 52, DIO\_25
- Pin 53, DIO\_26
- Pin 54, DIO\_27
- Pin 55, DIO\_28
- Pin 56, DIO\_29
- Pin 57, DIO\_30

## 7.5 Signal Descriptions – RSK Package

**Table 7-3. Signal Descriptions – RSK Package**

PIN		I/O	TYPE	DESCRIPTION
NAME	NO.			
DCDC_SW	47	—	Power	Output from internal DC/DC converter <sup>(1)</sup>
DCOUPPL	31	—	Power	For decoupling of internal 1.27 V regulated digital-supply <sup>(2)</sup>
DIO_3	12	I/O	Digital	GPIO
DIO_4	13	I/O	Digital	GPIO
DIO_5	14	I/O	Digital	GPIO, high-drive capability
DIO_6	15	I/O	Digital	GPIO, high-drive capability
DIO_7	16	I/O	Digital	GPIO, high-drive capability
DIO_8	18	I/O	Digital	GPIO
DIO_9	19	I/O	Digital	GPIO
DIO_10	20	I/O	Digital	GPIO
DIO_11	21	I/O	Digital	GPIO
DIO_12	26	I/O	Digital	GPIO
DIO_13	27	I/O	Digital	GPIO
DIO_14	28	I/O	Digital	GPIO
DIO_15	29	I/O	Digital	GPIO
DIO_16	34	I/O	Digital	GPIO, JTAG_TDO, high-drive capability
DIO_17	35	I/O	Digital	GPIO, JTAG_TDI, high-drive capability
DIO_18	36	I/O	Digital	GPIO
DIO_19	37	I/O	Digital	GPIO
DIO_20	38	I/O	Digital	GPIO
DIO_21	39	I/O	Digital	GPIO
DIO_22	40	I/O	Digital	GPIO
DIO_23	50	I/O	Digital or Analog	GPIO, analog capability
DIO_24	51	I/O	Digital or Analog	GPIO, analog capability
DIO_25	52	I/O	Digital or Analog	GPIO, analog capability
DIO_26	53	I/O	Digital or Analog	GPIO, analog capability
DIO_27	54	I/O	Digital or Analog	GPIO, analog capability
DIO_28	55	I/O	Digital or Analog	GPIO, analog capability
DIO_29	56	I/O	Digital or Analog	GPIO, analog capability
DIO_30	57	I/O	Digital	GPIO, analog capability
DIO_34	10	I/O	Digital	GPIO
DIO_35	11	I/O	Digital	GPIO
DIO_36	22	I/O	Digital	GPIO
DIO_37	23	I/O	Digital	GPIO
DIO_38	24	I/O	Digital	GPIO
DIO_39	25	I/O	Digital	GPIO
DIO_40	41	I/O	Digital	GPIO
DIO_41	42	I/O	Digital	GPIO
DIO_42	43	I/O	Digital	GPIO
DIO_43	44	I/O	Digital	GPIO
DIO_44	45	I/O	Digital	GPIO
DIO_45	46	I/O	Digital	GPIO
DIO_46	58	I/O	Digital	GPIO

**Table 7-3. Signal Descriptions – RSK Package (continued)**

PIN		I/O	TYPE	DESCRIPTION
NAME	NO.			
DIO_47	59	I/O	Digital	GPIO
EGP	—	—	GND	Ground – exposed ground pad <sup>(3)</sup>
JTAG_TMSC	32	I/O	Digital	JTAG TMSC, high-drive capability
JTAG_TCKC	33	I	Digital	JTAG TCKC
RESET_N	49	I	Digital	Reset, active low. No internal pullup resistor
RF_P_2_4GHZ	1	—	RF	Positive 2.4 GHz RF input signal to LNA during RX Positive 2.4 GHz RF output signal from PA during TX
RF_N_2_4GHZ	2	—	RF	Negative 2.4 GHz RF input signal to LNA during RX Negative 2.4 GHz RF output signal from PA during TX
RF_P_SUB_1GHZ	3	—	RF	Positive Sub-1 GHz RF input signal to LNA during RX Positive Sub-1 GHz RF output signal from PA during TX
RF_N_SUB_1GHZ	4	—	RF	Negative Sub-1 GHz RF input signal to LNA during RX Negative Sub-1 GHz RF output signal from PA during TX
RX_TX	7	—	RF	Optional bias pin for the RF LNA
TX_20DBM_P	5	—	RF	Positive Sub-1 GHz or 2.4 GHz high-power TX signal
TX_20DBM_N	6	—	RF	Negative Sub-1 GHz or 2.4 GHz high-power TX signal
VDDR	61	—	Power	Internal supply, must be powered from the internal DC/DC converter or the internal LDO <sup>(2) (4) (6)</sup>
VDDR_RF	64	—	Power	Internal supply, must be powered from the internal DC/DC converter or the internal LDO <sup>(2) (5) (6)</sup>
VDDS	60	—	Power	1.8 V to 3.8 V main chip supply <sup>(1)</sup>
VDDS2	17	—	Power	1.8 V to 3.8 V DIO supply <sup>(1)</sup>
VDDS3	30	—	Power	1.8 V to 3.8 V DIO supply <sup>(1)</sup>
VDDS_DCDC	48	—	Power	1.8 V to 3.8 V DC/DC converter supply
X48M_N	62	—	Analog	48 MHz crystal oscillator pin N
X48M_P	63	—	Analog	48 MHz crystal oscillator pin P
X32K_Q1	8	—	Analog	32 kHz crystal oscillator pin 1
X32K_Q2	9	—	Analog	32 kHz crystal oscillator pin 2

- (1) For more details, see technical reference manual listed in [Section 11.2](#).
- (2) Do not supply external circuitry from this pin.
- (3) EGP is the only ground connection for the device. Good electrical connection to device ground on printed circuit board (PCB) is imperative for proper device operation.
- (4) If internal DC/DC converter is not used, this pin is supplied internally from the main LDO.
- (5) If internal DC/DC converter is not used, this pin must be connected to VDDR for supply from the main LDO.
- (6) Output from internal DC/DC and LDO is trimmed to 1.68 V.

## 7.6 Connection of Unused Pins and Module – RSK Package

**Table 7-4. Connections for Unused Pins – RSK Package**

FUNCTION	SIGNAL NAME	PIN NUMBER	ACCEPTABLE PRACTICE <sup>(1)</sup>	PREFERRED PRACTICE <sup>(1)</sup>
GPIO	DIO_n	10–12	NC or GND	NC
		14–21		
		26–32		
		36–43		
32.768 kHz crystal	X32K_Q1	8	NC or GND	NC
	X32K_Q2	9		
DC/DC converter <sup>(2)</sup>	DCDC_SW	47	NC	NC
	VDDS_DCDC	48	VDDS	VDDS

(1) NC = No connect

(2) When the DC/DC converter is not used, the inductor between DCDC\_SW and VDDR can be removed. VDDR and VDDR\_RF must still be connected and the 22 µF DCDC capacitor must be kept on the VDDR net.

## 8 Specifications

### 8.1 Absolute Maximum Ratings

Over operating free-air temperature range (unless otherwise noted)<sup>(1) (2)</sup>

		MIN	MAX	UNIT
V <sub>DD3</sub> <sup>(3)</sup>	Supply voltage	-0.3	4.1	V
	Voltage on any digital pin <sup>(4) (5)</sup>	-0.3	V <sub>DD3</sub> + 0.3, max 4.1	V
	Voltage on crystal oscillator pins, X32K_Q1, X32K_Q2, X48M_N and X48M_P	-0.3	V <sub>DD3</sub> + 0.3, max 2.25	V
V <sub>in</sub>	Voltage on ADC input	Voltage scaling enabled	V <sub>DD3</sub>	V
		Voltage scaling disabled, internal reference	1.49	
		Voltage scaling disabled, V <sub>DD3</sub> as reference	V <sub>DD3</sub> / 2.9	
	Input level, Sub-1 GHz RF pins		10	dBm
	Input level, 2.4 GHz RF pins		5	dBm
T <sub>stg</sub>	Storage temperature	-40	150	°C

- (1) Stresses beyond those listed under *Absolute Maximum Ratings* may cause permanent damage to the device. These are stress ratings only, and functional operation of the device at these or any other conditions beyond those indicated under *Recommended Operating Conditions* is not implied. Exposure to absolute-maximum-rated conditions for extended periods may affect device reliability.
- (2) All voltage values are with respect to ground, unless otherwise noted.
- (3) V<sub>DD3\_DCDC</sub>, V<sub>DD3\_2</sub> and V<sub>DD3\_3</sub> must be at the same potential as V<sub>DD3</sub>.
- (4) Including analog capable DIOs.
- (5) Injection current is not supported on any GPIO pin.

### 8.2 ESD Ratings

			VALUE	UNIT	
V <sub>ESD</sub>	Electrostatic discharge	Human body model (HBM), per ANSI/ESDA/JEDEC JS001 <sup>(1)</sup>	All pins	±2000	V
		Charged device model (CDM), per JESD22-C101 <sup>(2)</sup>	All pins	±500	V

- (1) JEDEC document JEP155 states that 500 V HBM allows safe manufacturing with a standard ESD control process.
- (2) JEDEC document JEP157 states that 250 V CDM allows safe manufacturing with a standard ESD control process.

### 8.3 Recommended Operating Conditions

Over operating free-air temperature range (unless otherwise noted)

		MIN	MAX	UNIT
Operating ambient temperature <sup>(1)</sup>		-40	105	°C
Operating supply voltage (V <sub>DD3</sub> )		1.8	3.8	V
Operating supply voltage (V <sub>DD3</sub> ), boost mode	V <sub>DD3</sub> = 1.95 V +14 dBm RF output sub-1 GHz power amplifier	2.1	3.8	V
Rising supply voltage slew rate		0	100	mV/μs
Falling supply voltage slew rate <sup>(2)</sup>		0	20	mV/μs

- (1) Operation at or near maximum operating temperature for extended durations will result in lifetime reduction.
- (2) For small coin-cell batteries, with high worst-case end-of-life equivalent source resistance, a 22 μF V<sub>DD3</sub> input capacitor must be used to ensure compliance with this slew rate.

### 8.4 Power Supply and Modules

Over operating free-air temperature range (unless otherwise noted).

PARAMETER		MIN	TYP	MAX	UNIT
V <sub>DD3</sub> Power-on-Reset (POR) threshold		1.1 - 1.55			V
V <sub>DD3</sub> Brown-out Detector (BOD) <sup>(1)</sup>	Rising threshold	1.77			V
V <sub>DD3</sub> Brown-out Detector (BOD), before initial boot <sup>(2)</sup>	Rising threshold	1.70			V
V <sub>DD3</sub> Brown-out Detector (BOD) <sup>(1)</sup>	Falling threshold	1.75			V

- (1) For boost mode (V<sub>DD3</sub> = 1.95 V), TI drivers software initialization will trim V<sub>DD3</sub> BOD limits to maximum (approximately 2.0 V).

- (2) Brown-out Detector is trimmed at initial boot, value is kept until device is reset by a POR reset or the RESET\_N pin.

## 8.5 Power Consumption - Power Modes

When measured on the LP-EM-CC1354P10-1 reference design with  $T_c = 25\text{ }^\circ\text{C}$ ,  $V_{DD5} = 3.6\text{ V}$  with DC/DC enabled unless otherwise noted.

PARAMETER		TEST CONDITIONS	TYP	UNIT
<b>Core Current Consumption</b>				
$I_{\text{core}}$	Reset and Shutdown	Reset. RESET_N pin asserted or VDD5 below power-on-reset threshold	150	nA
		Shutdown. No clocks running, no retention	171	
	Standby without cache retention	RTC running, CPU, 256 kB RAM and (partial) register retention. RCOSC_LF	0.98	$\mu\text{A}$
		RTC running, CPU, 128 kB RAM and (partial) register retention. RCOSC_LF	0.88	$\mu\text{A}$
		RTC running, CPU, 256 kB RAM and (partial) register retention XOSC_LF	1.08	$\mu\text{A}$
		RTC running, CPU, 128 kB RAM and (partial) register retention XOSC_LF	0.99	$\mu\text{A}$
	Standby with cache retention	RTC running, CPU, 256 kB RAM and (partial) register retention. RCOSC_LF	2.24	$\mu\text{A}$
		RTC running, CPU, 128 kB RAM and (partial) register retention. RCOSC_LF	2.16	$\mu\text{A}$
		RTC running, CPU, 256 kB RAM and (partial) register retention. XOSC_LF	2.34	$\mu\text{A}$
		RTC running, CPU, 128 kB RAM and (partial) register retention. XOSC_LF	2.25	$\mu\text{A}$
	Idle	Supply Systems and RAM powered RCOSC_HF	635	$\mu\text{A}$
	Active	MCU running CoreMark at 48 MHz with parity enabled RCOSC_HF	3.5	mA
		MCU running CoreMark at 48 MHz with parity disabled RCOSC_HF	3.4	mA
	<b>Peripheral Current Consumption</b>			
$I_{\text{peri}}$	Peripheral power domain	Delta current with domain enabled	62.4	$\mu\text{A}$
	Serial power domain	Delta current with domain enabled	5.83	
	RF Core	Delta current with power domain enabled, clock enabled, RF core idle	102.0	
	$\mu\text{DMA}$	Delta current with clock enabled, module is idle	58.0	
	Timers	Delta current with clock enabled, module is idle <sup>(3)</sup>	97.2	
	I2C	Delta current with clock enabled, module is idle	9.8	
	I2S	Delta current with clock enabled, module is idle	22.2	
	SPI	Delta current with clock enabled, module is idle <sup>(2)</sup>	55.8	
	UART	Delta current with clock enabled, module is idle <sup>(1)</sup>	114.2	
	CRYPTO (AES)	Delta current with clock enabled, module is idle	15.5	
	PKA	Delta current with clock enabled, module is idle	66.6	
	TRNG	Delta current with clock enabled, module is idle	21.0	
<b>Sensor Controller Engine Consumption</b>				
$I_{\text{SCE}}$	Active mode	24 MHz, infinite loop, $V_{DD5} = 3.0\text{ V}$	849	$\mu\text{A}$
	Low-power mode	2 MHz, infinite loop, $V_{DD5} = 3.0\text{ V}$	32	

- (1) Only one UART running
- (2) Only one SPI running
- (3) Only one GPTimer running



## 8.6 Power Consumption - Radio Modes

When measured on the LP-EM-CC1354P10-1 reference design with  $T_c = 25\text{ }^\circ\text{C}$ ,  $V_{DD5} = 3.6\text{ V}$  with DC/DC enabled unless otherwise noted.

High power PA connected to  $V_{DD5}$  unless otherwise noted.

Using boost mode (increasing VDDR up to 1.95 V), will increase system current by 15% (does not apply to TX +14 dBm setting where this current is already included).

Relevant  $I_{core}$  and  $I_{peri}$  currents are included in below numbers.

PARAMETER		TEST CONDITIONS	TYP	UNIT
$I_{radio}$	Radio receive current, 868 MHz		5.8	mA
$I_{radio}$	Radio receive current, 2.44 GHz (BLE)	$V_{DD5} = 3.0\text{ V}$	6.9	mA
$I_{radio}$	Radio transmit current Sub-1 GHz PA	0 dBm output power setting 868 MHz	9.5	mA
	Radio transmit current Sub-1 GHz PA	+10 dBm output power setting 868 MHz	14.1	mA
	Radio transmit current Sub-1 GHz PA	+14 dBm output power setting 868 MHz	25.8	mA
$I_{radio}$	Radio transmit current 2.4 GHz PA (BLE)	0 dBm output power setting, $V_{DD5} = 3.0\text{ V}$	7.1	mA
	Radio transmit current 2.4 GHz PA (BLE)	+5 dBm output power setting 2440 MHz, $V_{DD5} = 3.0\text{ V}$	9.6	mA
$I_{radio}$	Radio transmit current High-power PA	Transmit (TX), +20 dBm output power setting 915 MHz, $V_{DD5} = 3.3\text{ V}$	69	mA

## 8.7 Nonvolatile (Flash) Memory Characteristics

Over operating free-air temperature range and  $V_{DD5} = 3.0\text{ V}$  (unless otherwise noted)

PARAMETER	TEST CONDITIONS	MIN	TYP	MAX	UNIT
Flash sector size			2		kB
Supported flash erase cycles before failure, full bank <sup>(1) (5)</sup>		30			k Cycles
Supported flash erase cycles before failure, single sector <sup>(2)</sup>		60			k Cycles
Maximum number of write operations per row before sector erase <sup>(3)</sup>				83	Write Operations
Flash retention	105 °C	11.4			Years
Flash sector erase current	Average delta current		0.3		mA
Flash sector erase time <sup>(4)</sup>	Zero cycles		2.1		ms
	30k cycles			4000	ms
Flash write current	Average delta current, 16 bytes at a time		3.0		mA
Flash write time <sup>(4)</sup>	16 bytes at a time		21.4		µs

- (1) A full bank erase is counted as a single erase cycle on each sector.
- (2) Up to 4 customer-designated sectors can be individually erased an additional 30k times beyond the baseline bank limitation of 30k cycles.
- (3) Each wordline is 2048 bits (or 256 bytes) wide. This limitation corresponds to sequential memory writes of 4 (3.1) bytes minimum per write over a whole wordline. If additional writes to the same wordline are required, a sector erase is required once the maximum number of write operations per row is reached.
- (4) This number is dependent on Flash aging and increases over time and erase cycles.
- (5) Aborting flash during erase or program modes is not a safe operation.

## 8.8 Thermal Resistance Characteristics

THERMAL METRIC <sup>(1) (3)</sup>		PACKAGE		UNIT
		RGZ (VQFN)		
		48 PINS		
$R_{\theta JA}$	Junction-to-ambient thermal resistance	23.4		°C/W <sup>(2)</sup>
$R_{\theta JC(top)}$	Junction-to-case (top) thermal resistance	13.3		°C/W <sup>(2)</sup>
$R_{\theta JB}$	Junction-to-board thermal resistance	8.0		°C/W <sup>(2)</sup>

THERMAL METRIC <sup>(1)</sup> <sup>(3)</sup>		PACKAGE	UNIT
		RGZ (VQFN)	
		48 PINS	
$\Psi_{JT}$	Junction-to-top characterization parameter	0.1	$^{\circ}\text{C}/\text{W}^{(2)}$
$\Psi_{JB}$	Junction-to-board characterization parameter	7.9	$^{\circ}\text{C}/\text{W}^{(2)}$
$R_{\theta JC(\text{bot})}$	Junction-to-case (bottom) thermal resistance	1.7	$^{\circ}\text{C}/\text{W}^{(2)}$

(1) For more information about traditional and new thermal metrics, see [Semiconductor and IC Package Thermal Metrics](#).

(2)  $^{\circ}\text{C}/\text{W}$  = degrees Celsius per watt.

(3) RSK data is pending

## 8.9 RF Frequency Bands

Over operating free-air temperature range (unless otherwise noted).

PARAMETER	MIN	TYP	MAX	UNIT
Frequency bands	2360		2500	MHz
	1076		1315	
	861		1054	
	431		527	
	359		439	
	287		351	

## 8.10 861 MHz to 1054 MHz - Receive (RX)

Measured on the LP-EM-CC1354P10-1 reference design with  $T_c = 25\text{ }^\circ\text{C}$ ,  $V_{DD5} = 3.0\text{ V}$  with DC/DC enabled and high power PA connected to  $V_{DD5}$  unless otherwise noted. All measurements are performed at the antenna input with a combined RX and TX path and through an RF switch as part of the reference design. All measurements are performed conducted.

PARAMETER	TEST CONDITIONS	MIN	TYP	MAX	UNIT
<b>General Parameters</b>					
Digital channel filter programmable receive bandwidth		4		4000	kHz
Data rate step size			1.5		bps
Spurious emissions 25 MHz to 1 GHz	868 MHz		< -57		dBm
Spurious emissions 1 GHz to 13 GHz	Conducted emissions measured according to ETSI EN 300 220		< -47		dBm
<b>Wi-SUN, 50 kbps, <math>\pm 12.5</math> kHz deviation, 2-GFSK, 78 kHz RX BW, #1a</b>					
Sensitivity	MRFSK, 866.6 MHz, 10% PER, 250 byte payload		-106		dBm
Saturation limit	10% PER, 250 byte payload, 866.6 MHz		10		dBm
Selectivity, +100 kHz	10% PER, 250 byte payload, 866.6 MHz. Wanted signal 3 dB above sensitivity level.		33		dB
Selectivity, -100 kHz			31		dB
Selectivity, +200 kHz			38		dB
Selectivity, -200 kHz			37		dB
RSSI dynamic range	Starting from the sensitivity limit		93		dB
RSSI accuracy	Starting from the sensitivity limit across the given dynamic range		$\pm 3$		dB
<b>Wi-SUN, 50 kbps, <math>\pm 25</math> kHz deviation, 2-GFSK, 100 kHz RX BW, #1b</b>					
Sensitivity	MRFSK, 918.2 MHz, 10% PER, 250 byte payload		-106		dBm
Saturation limit	10% PER, 250 byte payload, 918.2 MHz		10		dBm
Selectivity, +200 kHz	10% PER, 250 byte payload, 918.2 MHz. Wanted signal 3 dB above sensitivity level.		37		dB
Selectivity, -200 kHz			35		dB
Selectivity, +400 kHz			42		dB
Selectivity, -400 kHz			41		dB
RSSI dynamic range	Starting from the sensitivity limit		95		dB
RSSI accuracy	Starting from the sensitivity limit across the given dynamic range		$\pm 3$		dB
<b>Wi-SUN, 100 kbps, <math>\pm 25</math> kHz deviation, 2-GFSK, 135 kHz RX BW, #2a</b>					
Sensitivity	MRFSK, 866.6 MHz, 10% PER, 250 byte payload		-103		dBm
Saturation limit	10% PER, 250 byte payload, 866.6 MHz		10		dBm
Selectivity, +200 kHz	10% PER, 250 byte payload, 866.6 MHz. Wanted signal 3 dB above sensitivity level.		40		dB
Selectivity, -200 kHz			38		dB
Selectivity, +400 kHz			46		dB
Selectivity, -400 kHz			44		dB
RSSI dynamic range	Starting from the sensitivity limit		95		dB
RSSI accuracy	Starting from the sensitivity limit across the given dynamic range		$\pm 3$		dB
<b>Wi-SUN, 100 kbps, <math>\pm 50</math> kHz deviation, 2-GFSK, 208 kHz RX BW, #2b</b>					
Sensitivity	MRFSK, 920.9 MHz, 10% PER, 250 byte payload		-102		dBm
Saturation limit	10% PER, 250 byte payload, 920.9 MHz		10		dBm
Selectivity, +400 kHz	10% PER, 250 byte payload, 920.9 MHz. Wanted signal 3 dB above sensitivity level, modulated blocker.		42		dB
Selectivity, -400 kHz			39		dB
Selectivity, +800 kHz			52		dB
Selectivity, -800 kHz			46		dB
RSSI dynamic range	Starting from the sensitivity limit		91		dB
RSSI accuracy	Starting from the sensitivity limit across the given dynamic range		$\pm 3$		dB
<b>Wi-SUN, 150 kbps, <math>\pm 37.5</math> kHz deviation, 2-GFSK, 273 kHz RX BW, #3</b>					
Sensitivity	MRFSK, 918.4 MHz, 10% PER, 250 byte payload		-99		dBm
Saturation limit	10% PER, 250 byte payload, 918.4 MHz		10		dBm

## 8.10 861 MHz to 1054 MHz - Receive (RX) (continued)

Measured on the LP-EM-CC1354P10-1 reference design with  $T_c = 25\text{ }^\circ\text{C}$ ,  $V_{DD5} = 3.0\text{ V}$  with DC/DC enabled and high power PA connected to  $V_{DD5}$  unless otherwise noted. All measurements are performed at the antenna input with a combined RX and TX path and through an RF switch as part of the reference design. All measurements are performed conducted.

PARAMETER	TEST CONDITIONS	MIN	TYP	MAX	UNIT
Selectivity, +400 kHz	10% PER, 250 byte payload, 918.4 MHz. Wanted signal 3 dB above sensitivity level.		41		dB
Selectivity, -400 kHz			39		dB
Selectivity, +800 kHz			50		dB
Selectivity, -800 kHz			46		dB
RSSI dynamic range	Starting from the sensitivity limit		86		dB
RSSI accuracy	Starting from the sensitivity limit across the given dynamic range		±3		dB
<b>Wi-SUN, 200 kbps, ±50 kHz deviation, 2-GFSK, 335 kHz RX BW, #4a</b>					
Sensitivity	MRFSK, 918.4 MHz, 10% PER, 250 byte payload		-99		dBm
Saturation limit	10% PER, 250 byte payload, 918.4 MHz		10		dBm
Selectivity, +400 kHz	10% PER, 250 byte payload, 918.4 MHz. Wanted signal 3 dB above sensitivity level.		42		dB
Selectivity, -400 kHz			40		dB
Selectivity, +800 kHz			51		dB
Selectivity, -800 kHz			47		dB
RSSI dynamic range	Starting from the sensitivity limit		91		dB
RSSI accuracy	Starting from the sensitivity limit across the given dynamic range		±3		dB
<b>Wi-SUN, 200 kbps, ±100 kHz deviation, 2-GFSK, 416 kHz RX BW, #4b</b>					
Sensitivity	MRFSK, 920.8 MHz, 10% PER, 250 byte payload		-98		dBm
Saturation limit	10% PER, 250 byte payload, 920.8 MHz		10		dBm
Selectivity, +600 kHz	10% PER, 250 byte payload, 920.8 MHz. Wanted signal 3 dB above sensitivity level, modulated blocker.		46		dB
Selectivity, -600 kHz			43		dB
Selectivity, +1200 kHz			54		dB
Selectivity, -1200 kHz			51		dB
RSSI dynamic range	Starting from the sensitivity limit		86		dB
RSSI accuracy	Starting from the sensitivity limit across the given dynamic range		±3		dB
<b>Wi-SUN, 300 kbps, ±75 kHz deviation, 2-GFSK, 496 kHz RX BW, #5</b>					
Sensitivity	MRFSK, 917.6 MHz, 10% PER, 250 byte payload		-97		dBm
Saturation limit	10% PER, 250 byte payload, 917.6 MHz		10		dBm
Selectivity, +600 kHz	10% PER, 250 byte payload, 917.6 MHz. Wanted signal 3 dB above sensitivity level.		42		dB
Selectivity, -600 kHz			37		dB
Selectivity, +1200 kHz			51		dB
Selectivity, -1200 kHz			40		dB
RSSI dynamic range	Starting from the sensitivity limit		86		dB
RSSI accuracy	Starting from the sensitivity limit across the given dynamic range		±3		dB
<b>802.15.4-2020, 10 kbps, 2-FSK, 26 kHz RX BW, Mode #1a</b>					
Sensitivity	FSK, 915.0 MHz, 20 byte PSDU < 10% PER		-113		dBm
Sensitivity	FSK, 868.3 MHz, 20 byte PSDU < 10% PER		-113		dBm
Saturation limit	PSDU length 20 octets; PER < 10%, 868.3 MHz		10		dBm

## 8.10 861 MHz to 1054 MHz - Receive (RX) (continued)

Measured on the LP-EM-CC1354P10-1 reference design with  $T_c = 25\text{ }^\circ\text{C}$ ,  $V_{DD5} = 3.0\text{ V}$  with DC/DC enabled and high power PA connected to  $V_{DD5}$  unless otherwise noted. All measurements are performed at the antenna input with a combined RX and TX path and through an RF switch as part of the reference design. All measurements are performed conducted.

PARAMETER	TEST CONDITIONS	MIN	TYP	MAX	UNIT
Selectivity, +50 kHz	PSDU length 20 octets; PER < 10%, 868.3 MHz		36		dB
Selectivity, -50 kHz			36		dB
Selectivity, +100 kHz			40		dB
Selectivity, -100 kHz			39		dB
Selectivity, +200 kHz			44		dB
Selectivity, -200 kHz			37		dB
Blocking, +1 MHz			60		dB
Blocking, -1 MHz			59		dB
Blocking, +2 MHz			64		dB
Blocking, -2 MHz			64		dB
Blocking, +5 MHz			75		dB
Blocking, -5 MHz			74		dB
Blocking, +10 MHz			79		dB
Blocking, -10 MHz			79		dB
Selectivity, +50 kHz	PSDU length 20 octets; PER < 10%, 868.3 MHz. Wanted signal 3 dB above sensitivity level.		35		dB
Selectivity, -50 kHz			35		dB
Selectivity, +100 kHz			39		dB
Selectivity, -100 kHz			38		dB
Selectivity, +200 kHz			44		dB
Selectivity, -200 kHz			44		dB
Blocking, +1 MHz			58		dB
Blocking, -1 MHz			58		dB
Blocking, +2 MHz			62		dB
Blocking, -2 MHz			63		dB
Blocking, +5 MHz			74		dB
Blocking, -5 MHz			74		dB
Blocking, +10 MHz			73		dB
Blocking, -10 MHz			78		dB
Blocking + 5% Fc. (45.75 MHz)	10% PER, 20 byte payload, 866.6 MHz 802.15.4g mandatory mode, wanted signal -94 dBm. 3 dB above usable sensitivity limit according to ETSI EN 300 220 V3.1.1 (usable sensitivity -97 dBm). Limit is Cat 1.5 requirement.		-15		dBm
Blocking - 5% Fc. (-45.75 MHz)			-15		dBm
Image rejection (image compensation enabled)			39		dB
Image rejection (image compensation enabled)	PSDU length 20 octets; PER < 10%, 868.3 MHz		39		dB
RSSI dynamic range	Starting from the sensitivity limit		100		dB
RSSI accuracy	Starting from the sensitivity limit across the given dynamic range		±3		dB
Frequency error tolerance (ppm)	10% PER, 20 byte payload, measured at 10 dB above sensitivity level. Negative offset		-12		ppm
Frequency error tolerance (ppm)	10% PER, 20 byte payload, measured at 10 dB above sensitivity level. Positive offset		12		ppm
Symbol rate error tolerance (ppm)	10% PER, 20 byte payload, measured at 10 dB above sensitivity level. Negative offset		-1000		ppm
Symbol rate error tolerance (ppm)	1% BER, measured at 10 dB above sensitivity level. Positive offset		1000		ppm
<b>802.15.4-2020, 20 kbps, 2-FSK, 52 kHz RX BW, Mode #1b</b>					
Sensitivity	FSK, 20 kbps, ±10 kHz deviation, 2-GFSK, 915.0 MHz, 52 kHz RX BW, 20 byte PSDU < 10% PER		-110		dBm

## 8.10 861 MHz to 1054 MHz - Receive (RX) (continued)

Measured on the LP-EM-CC1354P10-1 reference design with  $T_c = 25\text{ }^\circ\text{C}$ ,  $V_{DD5} = 3.0\text{ V}$  with DC/DC enabled and high power PA connected to  $V_{DD5}$  unless otherwise noted. All measurements are performed at the antenna input with a combined RX and TX path and through an RF switch as part of the reference design. All measurements are performed conducted.

PARAMETER	TEST CONDITIONS	MIN	TYP	MAX	UNIT	
Sensitivity	FSK, 20 kbps, $\pm 10\text{ kHz}$ deviation, 2-GFSK, 868.3 MHz, 52 kHz RX BW, 20 byte PSDU < 10% PER		-110		dBm	
Saturation limit	20 byte PSDU < 10% PER, 868.3 MHz		10		dBm	
Selectivity, +100 kHz	20 byte PSDU < 10% PER, 868.3 MHz		38		dB	
Selectivity, -100 kHz			36		dB	
Selectivity, +200 kHz			44		dB	
Selectivity, -200 kHz			42		dB	
Selectivity, +400 kHz			49		dB	
Selectivity, -400 kHz			44		dB	
Blocking, +1 MHz			58		dB	
Blocking, -1 MHz			54		dB	
Blocking, -2 MHz			61		dB	
Blocking, +2 MHz			61		dB	
Blocking, -5 MHz			70		dB	
Blocking, +5 MHz			70		dB	
Blocking, -10 MHz			75		dB	
Blocking, +10 MHz			76		dB	
Selectivity, +100 kHz		20 byte PSDU < 10% PER, 868.3 MHz. Wanted signal 3 dB above sensitivity level.		36		dB
Selectivity, -100 kHz				34		dB
Selectivity, +200 kHz				42		dB
Selectivity, -200 kHz				41		dB
Selectivity, +400 kHz				47		dB
Selectivity, -400 kHz				46		dB
Blocking, +1 MHz			56		dB	
Blocking, -1 MHz			55		dB	
Blocking, +2 MHz			61		dB	
Blocking, -2 MHz			61		dB	
Blocking, +5 MHz			71		dB	
Blocking, -5 MHz			70		dB	
Blocking, +10 MHz			75		dB	
Blocking, -10 MHz			75		dB	
Blocking + 5% Fc. (45.75 MHz)	20 byte PSDU < 10% PER, 866.6 MHz, wanted signal -94 dBm. 3 dB above usable sensitivity limit according to ETSI EN 300 220 V3.1.1 (usable sensitivity -97 dBm). Limit is Cat 1.5 requirement.			-13		dBm
Blocking - 5% Fc. (-45.75 MHz)				-13		dBm
Image rejection (image compensation enabled)	20 byte PSDU < 10% PER, 866.6 MHz. Wanted signal 3 dB above sensitivity limit.			39		dB
Image rejection (image compensation enabled)	20 byte PSDU < 10% PER, 866.6 MHz <sup>(1)</sup>			39		dB
RSSI dynamic range	Starting from the sensitivity limit			100		dB
RSSI accuracy	Starting from the sensitivity limit across the given dynamic range			$\pm 3$		dB
Frequency error tolerance (ppm)	20 byte PSDU < 10% PER, measured at 10 dB above sensitivity level. Negative offset		-24		ppm	
Frequency error tolerance (ppm)	20 byte PSDU < 10% PER, measured at 10 dB above sensitivity level. Positive offset		24		ppm	
Symbol rate error tolerance (ppm)	20 byte PSDU < 10% PER, measured at 10 dB above sensitivity level. Negative offset		-1000		ppm	
Symbol rate error tolerance (ppm)	20 byte PSDU < 10% PER, measured at 10 dB above sensitivity level. Negative offset		1000		ppm	

## 8.10 861 MHz to 1054 MHz - Receive (RX) (continued)

Measured on the LP-EM-CC1354P10-1 reference design with  $T_c = 25\text{ }^\circ\text{C}$ ,  $V_{DD5} = 3.0\text{ V}$  with DC/DC enabled and high power PA connected to  $V_{DD5}$  unless otherwise noted. All measurements are performed at the antenna input with a combined RX and TX path and through an RF switch as part of the reference design. All measurements are performed conducted.

PARAMETER	TEST CONDITIONS	MIN	TYP	MAX	UNIT
<b>802.15.4, 200 kbps, <math>\pm 50</math> kHz deviation, 2-GFSK, 311 kHz RX BW</b>					
Sensitivity	BER = $10^{-2}$ , 868 MHz		-103		dBm
Sensitivity	BER = $10^{-2}$ , 915 MHz		-103		dBm
Selectivity, +400 kHz	BER = $10^{-2}$ , 915 MHz. Wanted signal 3 dB above sensitivity limit.		45		dB
Selectivity, -400 kHz	BER = $10^{-2}$ , 915 MHz. Wanted signal 3 dB above sensitivity limit.		45		dB
Selectivity, +800 kHz	BER = $10^{-2}$ , 915 MHz. Wanted signal 3 dB above sensitivity limit.		52		dB
Selectivity, -800 kHz	BER = $10^{-2}$ , 915 MHz. Wanted signal 3 dB above sensitivity limit.		47		dB
Blocking, +2 MHz	BER = $10^{-2}$ , 915 MHz. Wanted signal 3 dB above sensitivity limit.		59		dB
Blocking, -2 MHz	BER = $10^{-2}$ , 915 MHz. Wanted signal 3 dB above sensitivity limit.		56		dB
Blocking, +10 MHz	BER = $10^{-2}$ , 915 MHz. Wanted signal 3 dB above sensitivity limit.		71		dB
Blocking, -10 MHz	BER = $10^{-2}$ , 915 MHz. Wanted signal 3 dB above sensitivity limit.		70		dB
<b>802.15.4, 500 kbps, <math>\pm 190</math> kHz deviation, 2-GFSK, 622 kHz RX BW</b>					
Sensitivity 500 kbps	915 MHz, 1% PER, 127 byte payload		-95		dBm
Selectivity, $\pm 1$ MHz	915 MHz, 1% PER, 127 byte payload. Wanted signal at -88 dBm		34		dB
Selectivity, $\pm 2$ MHz	915 MHz, 1% PER, 127 byte payload. Wanted signal at -88 dBm		46		dB
Co-channel rejection	915 MHz, 1% PER, 127 byte payload. Wanted signal at -71 dBm		-8		dB
<b>SimpleLink™ Long Range 2.5/5 kbps (20 ksps), <math>\pm 5</math> kHz Deviation, 2-GFSK, 34 kHz RX Bandwidth, FEC = 1:2, DSSS = 1:4/1:2</b>					
Sensitivity	2.5 kbps, BER = $10^{-2}$ , 868 MHz		-121		dBm
Sensitivity	2.5 kbps, BER = $10^{-2}$ , 915 MHz		-121		dBm
Sensitivity	5 kbps, BER = $10^{-2}$ , 868 MHz		-119		dBm
Sensitivity	5 kbps, BER = $10^{-2}$ , 915 MHz		-119		dBm
Saturation limit	2.5 kbps, BER = $10^{-2}$ , 868 MHz		10		dBm
Selectivity, +100 kHz	2.5 kbps, BER = $10^{-2}$ , 868 MHz <sup>(1)</sup>		49		dB
Selectivity, -100 kHz	2.5 kbps, BER = $10^{-2}$ , 868 MHz <sup>(1)</sup>		49		dB
Selectivity, +200 kHz	2.5 kbps, BER = $10^{-2}$ , 868 MHz <sup>(1)</sup>		52		dB
Selectivity, -200 kHz	2.5 kbps, BER = $10^{-2}$ , 868 MHz <sup>(1)</sup>		48		dB
Selectivity, +300 kHz	2.5 kbps, BER = $10^{-2}$ , 868 MHz <sup>(1)</sup>		54		dB
Selectivity, -300 kHz	2.5 kbps, BER = $10^{-2}$ , 868 MHz <sup>(1)</sup>		48		dB
Blocking, +1 MHz	2.5 kbps, BER = $10^{-2}$ , 868 MHz <sup>(1)</sup>		65		dB
Blocking, -1 MHz	2.5 kbps, BER = $10^{-2}$ , 868 MHz <sup>(1)</sup>		60		dB
Blocking, +2 MHz	2.5 kbps, BER = $10^{-2}$ , 868 MHz <sup>(1)</sup>		70		dB
Blocking, -2 MHz	2.5 kbps, BER = $10^{-2}$ , 868 MHz <sup>(1)</sup>		68		dB
Blocking, +5 MHz	2.5 kbps, BER = $10^{-2}$ , 868 MHz <sup>(1)</sup>		78		dB
Blocking, -5 MHz	2.5 kbps, BER = $10^{-2}$ , 868 MHz <sup>(1)</sup>		77		dB
Blocking, +10 MHz	2.5 kbps, BER = $10^{-2}$ , 868 MHz <sup>(1)</sup>		87		dB
Blocking, -10 MHz	2.5 kbps, BER = $10^{-2}$ , 868 MHz <sup>(1)</sup>		92		dB
Image rejection (image compensation enabled)	2.5 kbps, BER = $10^{-2}$ , 868 MHz <sup>(1)</sup>		47		dB
RSSI accuracy	Starting from the sensitivity limit across the given dynamic range		$\pm 3$		dB
Frequency error tolerance (ppm)	2.5 kbps, 20 kbaud, DSSS=4, $\frac{1}{2}$ K=7 FEC. measured at -110 dBm.		-24/26		ppm
Symbolrate error tolerance (ppm)	2.5 kbps, 20 kbaud, DSSS=4, $\frac{1}{2}$ K=7 FEC. measured at -110 dBm. Referred to 20 kbaud chip rate.		-90/70		ppm
<b>Narrowband, 9.6 kbps <math>\pm 2.4</math> kHz deviation, 2-GFSK, 868 MHz, 17.1 kHz RX BW</b>					
Sensitivity	1% BER		-117		dBm
Adjacent Channel Rejection	1% BER. Wanted signal 3 dB above usable sensitivity limit (usable sensitivity -104.6 dBm). Interferer $\pm 20$ kHz		42		dB

## 8.10 861 MHz to 1054 MHz - Receive (RX) (continued)

Measured on the LP-EM-CC1354P10-1 reference design with  $T_c = 25\text{ }^\circ\text{C}$ ,  $V_{DD5} = 3.0\text{ V}$  with DC/DC enabled and high power PA connected to  $V_{DD5}$  unless otherwise noted. All measurements are performed at the antenna input with a combined RX and TX path and through an RF switch as part of the reference design. All measurements are performed conducted.

PARAMETER	TEST CONDITIONS	MIN	TYP	MAX	UNIT	
Alternate Channel Rejection	1% BER. Wanted signal 3 dB above usable sensitivity limit (usable sensitivity -104.6 dBm). Interferer $\pm 40\text{ kHz}$		42		dB	
Blocking, $\pm 1\text{ MHz}$	1% BER. Wanted signal 3 dB above usable sensitivity limit (usable sensitivity -104.6 dBm).		66		dB	
Blocking, $\pm 2\text{ MHz}$	1% BER. Wanted signal 3 dB above usable sensitivity limit (usable sensitivity -104.6 dBm).		71		dB	
Blocking, $\pm 10\text{ MHz}$	1% BER. Wanted signal 3 dB above usable sensitivity limit (usable sensitivity -104.6 dBm).		85		dB	
<b>802.15.4, 50 kbps, <math>\pm 25\text{ kHz}</math> Deviation, 2-GFSK, 100 kHz RX BW (Legacy)</b>						
Sensitivity	BER = $10^{-2}$ , 868 MHz		-110		dBm	
Sensitivity	BER = $10^{-2}$ , 915 MHz		-110		dBm	
Saturation limit	BER = $10^{-2}$ , 868 MHz		10		dBm	
Selectivity, +200 kHz	BER = $10^{-2}$ , 868 MHz <sup>(1)</sup>		44		dB	
Selectivity, -200 kHz			44		dB	
Selectivity, +400 kHz			54		dB	
Selectivity, -400 kHz			44		dB	
Blocking, +1 MHz			57		dB	
Blocking, -1 MHz			57		dB	
Blocking, +2 MHz			61		dB	
Blocking, -2 MHz			61		dB	
Blocking, +5 MHz			67		dB	
Blocking, -5 MHz			67		dB	
Blocking, +10 MHz			76		dB	
Blocking, -10 MHz			76		dB	
Selectivity, +200 kHz		BER = $10^{-2}$ , 868 MHz. Wanted signal 3 dB above sensitivity limit.		45		dB
Selectivity, -200 kHz				45		dB
Selectivity, +400 kHz			51		dB	
Selectivity, -400 kHz			45		dB	
Blocking, +1 MHz			61		dB	
Blocking, -1 MHz			61		dB	
Blocking, +2 MHz			63		dB	
Blocking, -2 MHz			63		dB	
Blocking, +5 MHz			67		dB	
Blocking, -5 MHz			67		dB	
Blocking, +10 MHz			73		dB	
Blocking, -10 MHz			73		dB	
Blocking + 5% Fc. (43.42 MHz)	BER = $10^{-2}$ , 868 MHz			-15		dBm
Blocking - 5% Fc. (-43.42 MHz)	802.15.4g mandatory mode, wanted signal -94 dBm. 3 dB above usable sensitivity limit according to ETSI EN 300 220 V3.1.1 (usable sensitivity -97 dBm). Limit is Cat 1.5 requirement.			-15		dBm
Image rejection (image compensation enabled)	BER = $10^{-2}$ , 868 MHz. Wanted signal 3 dB above sensitivity limit.		39		dB	
Image rejection (image compensation enabled)	BER = $10^{-2}$ , 868 MHz <sup>(1)</sup>		39		dB	
RSSI dynamic range	Starting from the sensitivity limit		95		dB	
RSSI accuracy	Starting from the sensitivity limit across the given dynamic range		$\pm 3$		dB	
Frequency error tolerance (ppm)	1% BER, measured at -100 dBm (10 dB above sensitivity level). Negative offset		-30		ppm	
Frequency error tolerance (ppm)	1% BER, measured at -100 dBm (10 dB above sensitivity level). Positive offset		25		ppm	



## 8.10 861 MHz to 1054 MHz - Receive (RX) (continued)

Measured on the LP-EM-CC1354P10-1 reference design with  $T_c = 25\text{ }^\circ\text{C}$ ,  $V_{DD5} = 3.0\text{ V}$  with DC/DC enabled and high power PA connected to  $V_{DD5}$  unless otherwise noted. All measurements are performed at the antenna input with a combined RX and TX path and through an RF switch as part of the reference design. All measurements are performed conducted.

PARAMETER	TEST CONDITIONS	MIN	TYP	MAX	UNIT	
Symbol rate error tolerance (ppm)	1% BER, measured at-100 dBm (10 dB above sensitivity level). Negative offset		-2000		ppm	
Symbol rate error tolerance (ppm)	1% BER, measured at-100 dBm (10 dB above sensitivity level) Positive offset		2000		ppm	
<b>802.15.4, 100 kbps, <math>\pm 25</math> kHz deviation, 2-GFSK, 137 kHz RX BW</b>						
Sensitivity 100 kbps	868 MHz, 1% PER, 127 byte payload		-103		dBm	
Selectivity, $\pm 200$ kHz	868 MHz, 1% PER, 127 byte payload. Wanted signal at -96 dBm		38		dB	
Selectivity, $\pm 400$ kHz			44		dB	
Co-channel rejection			-9		dB	
<b>Generic OOK (16.384 kbps, OOK w / Manchester encoding, 100 kHz RX BW)</b>						
Sensitivity	OOK, 915.0 MHz, 1% BER		-114		dBm	
Sensitivity	OOK, 868.8 MHz, 1% BER		-113		dBm	
Saturation limit	868.3 MHz		0		dBm	
Selectivity, +200 kHz	868.3 MHz <sup>(1)</sup>		52		dB	
Selectivity, -200 kHz			48		dB	
Selectivity, +400 kHz			68		dB	
Selectivity, -400 kHz			64		dB	
Blocking, +1 MHz			64		dB	
Blocking, -1 MHz			59		dB	
Blocking, +2 MHz			64		dB	
Blocking, -2 MHz			59		dB	
Blocking, +5 MHz			72		dB	
Blocking, -5 MHz			73		dB	
Blocking, +10 MHz			64		dB	
Blocking, -10 MHz			58		dB	
Selectivity, +200 kHz		868.3 MHz. Wanted signal 3 dB above sensitivity level.		52		dB
Selectivity, -200 kHz				47		dB
Selectivity, +400 kHz				42		dB
Selectivity, -400 kHz				42		dB
Blocking, +1 MHz			68		dB	
Blocking, -1 MHz			64		dB	
Blocking, +2 MHz			68		dB	
Blocking, -2 MHz			64		dB	
Blocking, +5 MHz			74		dB	
Blocking, -5 MHz			73		dB	
Blocking, +10 MHz			68		dB	
Blocking, -10 MHz			64		dB	
RSSI dynamic range	Starting from the sensitivity limit			95		dB
RSSI accuracy	Starting from the sensitivity limit across the given dynamic range			$\pm 3$		dB
Frequency error tolerance (ppm)	Measured at 10 dB above sensitivity level. Negative offset			-40		ppm
Frequency error tolerance (ppm)	Measured at 10 dB above sensitivity level. Positive offset			40		ppm
Symbol rate error tolerance (ppm)	Measured at 10 dB above sensitivity level. Negative offset		-2000		ppm	
Symbol rate error tolerance (ppm)	Measured at 10 dB above sensitivity level Positive offset		2000		ppm	
<b>WB-DSSS, 240/120/60/30 kbps (480 ksym/s, 2-GFSK, <math>\pm 195</math> kHz Deviation, FEC (Half Rate), DSSS = 1/2/4/8, 622 kHz RX BW)</b>						
Sensitivity	240 kbps, DSSS = 1, BER = $10^{-2}$ , 915.0 MHz		-105		dBm	

## 8.10 861 MHz to 1054 MHz - Receive (RX) (continued)

Measured on the LP-EM-CC1354P10-1 reference design with  $T_c = 25\text{ }^\circ\text{C}$ ,  $V_{DD5} = 3.0\text{ V}$  with DC/DC enabled and high power PA connected to  $V_{DD5}$  unless otherwise noted. All measurements are performed at the antenna input with a combined RX and TX path and through an RF switch as part of the reference design. All measurements are performed conducted.

PARAMETER	TEST CONDITIONS	MIN	TYP	MAX	UNIT
Sensitivity	120 kbps, DSSS = 2, BER = $10^{-2}$ , 915.0 MHz		-106		dBm
Sensitivity	60 kbps, DSSS = 4, BER = $10^{-2}$ , 915.0 MHz		-108		dBm
Sensitivity	30 kbps, DSSS = 8, BER = $10^{-2}$ , 915.0 MHz		-109		dBm
Saturation limit	915.0 MHz		0		dBm
Blocking +1 MHz	240 kbps, DSSS = 1		54		dB
	120 kbps, DSSS = 2		57		dB
	60 kbps, DSSS = 4		57		dB
	30 kbps, DSSS = 8		57		dB
Blocking -1 MHz	240 kbps, DSSS = 1		49		dB
	120 kbps, DSSS = 2		50		dB
	60 kbps, DSSS = 4		52		dB
	30 kbps, DSSS = 8		53		dB
Blocking +2 MHz	240 kbps, DSSS = 1		54		dB
	120 kbps, DSSS = 2		55		dB
	60 kbps, DSSS = 4		57		dB
	30 kbps, DSSS = 8		58		dB
Blocking -2 MHz	240 kbps, DSSS = 1		53		dB
	120 kbps, DSSS = 2		54		dB
	60 kbps, DSSS = 4		56		dB
	30 kbps, DSSS = 8		56		dB
Blocking +5 MHz	240 kbps, DSSS = 1		55		dB
	120 kbps, DSSS = 2		56		dB
	60 kbps, DSSS = 4		58		dB
	30 kbps, DSSS = 8		59		dB
Blocking -5 MHz	240 kbps, DSSS = 1		54		dB
	120 kbps, DSSS = 2		55		dB
	60 kbps, DSSS = 4		57		dB
	30 kbps, DSSS = 8		58		dB
Blocking +10 MHz	240 kbps, DSSS = 1		69		dB
	120 kbps, DSSS = 2		70		dB
	60 kbps, DSSS = 4		72		dB
	30 kbps, DSSS = 8		73		dB
Blocking -10 MHz	240 kbps, DSSS = 1		65		dB
Blocking -10 MHz	120 kbps, DSSS = 2		67		dB
Blocking -10 MHz	60 kbps, DSSS = 4		69		dB
Blocking -10 MHz	30 kbps, DSSS = 8		70		dB
RSSI dynamic range	Starting from the sensitivity limit		85		dB
RSSI accuracy	Starting from the sensitivity limit across the given dynamic range		±3		dB

(1) Wanted signal 3 dB above usable sensitivity limit according to ETSI EN 300 220 v. 3.1.1.

## 8.11 861 MHz to 1054 MHz - Transmit (TX)

Measured on the LP-EM-CC1354P10-1 reference design with  $T_c = 25^\circ\text{C}$ ,  $V_{\text{DD5}} = 3.0\text{ V}$  with DC/DC enabled and high power PA connected to  $V_{\text{DD5}}$  unless otherwise noted. All measurements are performed at the antenna input with a combined RX and TX path and through an RF switch as part of the reference design. All measurements are performed conducted. <sup>(1)</sup>

PARAMETER		TEST CONDITIONS	MIN	TYP	MAX	UNIT
<b>General parameters</b>						
Max output power, boost mode Sub-1 GHz PA <sup>(2)</sup>		VDDR = 1.95 V Minimum supply voltage (VDD5) for boost mode is 2.1 V 868 MHz and 915 MHz		14		dBm
Max output power, Sub-1 GHz PA <sup>(2)</sup>		868 MHz and 915 MHz		12		dBm
Max output power, High power PA		915 MHz VDD5 = 3.3V		20		dBm
Output power programmable range Sub-1 GHz PA		868 MHz and 915 MHz, 1dB step size.		34		dB
Output power programmable range High power PA		868 MHz and 915 MHz VDD5 = 3.3V		6		dB
Output power variation over temperature Sub-1 GHz PA		+10 dBm setting Over recommended temperature operating range		±2		dB
Output power variation over temperature Boost mode, Sub-1 GHz PA		+14 dBm setting Over recommended temperature operating range		±1.5		dB
<b>Spurious emissions and harmonics</b>						
Spurious emissions (excluding harmonics) Sub-1 GHz PA, 868 MHz <sup>(3)</sup>	30 MHz to 1 GHz	+14 dBm setting ETSI restricted bands		< -54		dBm
		+14 dBm setting ETSI outside restricted bands		< -36		dBm
	1 GHz to 12.75 GHz (outside ETSI restricted bands)	+14 dBm setting measured in 1 MHz bandwidth (ETSI)		< -30		dBm
Spurious emissions out-of-band Sub-1 GHz PA, 915 MHz <sup>(3)</sup>	30 MHz to 88 MHz (within FCC restricted bands)	+14 dBm setting		< -56		dBm
	88 MHz to 216 MHz (within FCC restricted bands)	+14 dBm setting		< -52		dBm
	216 MHz to 960 MHz (within FCC restricted bands)	+14 dBm setting		< -50		dBm
	960 MHz to 2390 MHz and above 2483.5 MHz (within FCC restricted band)	+14 dBm setting		< -42		dBm
	1 GHz to 12.75 GHz (outside FCC restricted bands)	+14 dBm setting		< -40		dBm
Spurious emissions out-of-band High power PA, 915 MHz <sup>(3) (4)</sup>	30 MHz to 88 MHz (within FCC restricted bands)	+20 dBm setting, VDD5 = 3.3 V		< -55		dBm
	88 MHz to 216 MHz (within FCC restricted bands)	+20 dBm setting, VDD5 = 3.3 V		< -52		dBm
	216 MHz to 960 MHz (within FCC restricted bands)	+20 dBm setting, VDD5 = 3.3 V		< -49		dBm
	960 MHz to 2390 MHz and above 2483.5 MHz (within FCC restricted band)	+20 dBm setting, VDD5 = 3.3 V		< -41		dBm
	1 GHz to 12.75 GHz (outside FCC restricted bands)	+20 dBm setting, VDD5 = 3.3 V		< -20		dBm

## 8.11 861 MHz to 1054 MHz - Transmit (TX) (continued)

Measured on the LP-EM-CC1354P10-1 reference design with  $T_c = 25^\circ\text{C}$ ,  $V_{\text{DD5}} = 3.0\text{ V}$  with DC/DC enabled and high power PA connected to  $V_{\text{DD5}}$  unless otherwise noted. All measurements are performed at the antenna input with a combined RX and TX path and through an RF switch as part of the reference design. All measurements are performed conducted. <sup>(1)</sup>

PARAMETER		TEST CONDITIONS	MIN	TYP	MAX	UNIT	
Spurious emissions out-of-band Sub-1 GHz PA, 920.6/928 MHz <sup>(3)</sup>	Below 710 MHz (ARIB T-108)	+14 dBm setting		< -36		dBm	
	710 MHz to 900 MHz (ARIB T-108)	+14 dBm setting		< -55		dBm	
	900 MHz to 915 MHz (ARIB T-108)	+14 dBm setting		< -55		dBm	
	930 MHz to 1000 MHz (ARIB T-108)	+14 dBm setting		< -55		dBm	
	1000 MHz to 1215 MHz (ARIB T-108)	+14 dBm setting		< -45		dBm	
	Above 1215 MHz (ARIB T-108)	+14 dBm setting		< -30		dBm	
Harmonics Sub-1 GHz PA	Second harmonic	+14 dBm setting, 868 MHz		< -30		dBm	
		+14 dBm setting, 915 MHz		< -30		dBm	
	Third harmonic	+14 dBm setting, 868 MHz		< -30		dBm	
		+14 dBm setting, 915 MHz		< -42		dBm	
	Fourth harmonic	+14 dBm setting, 868 MHz		< -30		dBm	
		+14 dBm setting, 915 MHz		< -42		dBm	
	Fifth harmonic	+14 dBm setting, 868 MHz		< -30		dBm	
		+14 dBm setting, 915 MHz		< -42		dBm	
	Harmonics High power PA	Second harmonic	+20 dBm setting, $V_{\text{DD5}} = 3.3\text{ V}$ , 915 MHz		< -30		dBm
		Third harmonic	+20 dBm setting, $V_{\text{DD5}} = 3.3\text{ V}$ , 915 MHz		< -42		dBm
Fourth harmonic		+20 dBm setting, $V_{\text{DD5}} = 3.3\text{ V}$ , 915 MHz		< -42		dBm	
Fifth harmonic		+20 dBm setting, $V_{\text{DD5}} = 3.3\text{ V}$ , 915 MHz		< -42		dBm	

- (1) Some combinations of frequency, data rate and modulation format requires use of external crystal load capacitors for regulatory compliance. More details can be found in the device errata.
- (2) Output power is dependent on RF match. For dual-band devices in the CC13X4 platform, output power might be slightly reduced depending on RF layout trade-offs.
- (3) Suitable for systems targeting compliance with EN 300 220, EN 303 131, EN 303 204, FCC CFR47 Part 15, ARIB STD-T108.
- (4) Spurious emissions increase for supply voltages below 2.2 V. As such, care must be taken to ensure regulatory requirements are met when operating at low supply voltage levels. An alternative is to use the Sub-1 GHz PA below 2.2 V.

## 8.12 861 MHz to 1054 MHz - PLL Phase Noise Wideband Mode

When measured on the LP-EM-CC1354P10-1 reference design with  $T_c = 25^\circ\text{C}$ ,  $V_{\text{DD5}} = 3.0\text{ V}$ .

PARAMETER	TEST CONDITIONS	MIN	TYP	MAX	UNIT
Phase noise in the 868- and 915-MHz bands 20 kHz PLL loop bandwidth	±10 kHz offset		-74		dBc/Hz
	±100 kHz offset		-97		dBc/Hz
	±200 kHz offset		-107		dBc/Hz
	±400 kHz offset		-113		dBc/Hz
	±1000 kHz offset		-120		dBc/Hz
	±2000 kHz offset		-127		dBc/Hz
	±10000 kHz offset		-141		dBc/Hz

### 8.13 861 MHz to 1054 MHz - PLL Phase Noise Narrowband Mode

When measured on the LP-EM-CC1354P10-1 reference design with  $T_c = 25\text{ }^\circ\text{C}$ ,  $V_{\text{DDS}} = 3.0\text{ V}$ .

PARAMETER	TEST CONDITIONS	MIN	TYP	MAX	UNIT
Phase noise in the 868- and 915-MHz bands 150 kHz PLL loop bandwidth	±10 kHz offset		-96		dBc/Hz
	±100 kHz offset		-95		dBc/Hz
	±200 kHz offset		-94		dBc/Hz
	±400 kHz offset		-104		dBc/Hz
	±1000 kHz offset		-121		dBc/Hz
	±2000 kHz offset		-130		dBc/Hz
	±10000 kHz offset		-140		dBc/Hz

## 8.14 Bluetooth Low Energy - Receive (RX)

Measured on the LP-EM-CC1354P10-1 reference design with  $T_c = 25\text{ }^\circ\text{C}$ ,  $V_{DD5} = 3.0\text{ V}$ ,  $f_{RF} = 2440\text{ MHz}$  with DC/DC enabled and high power PA connected to  $V_{DD5}$  unless otherwise noted.

All measurements are performed at the antenna input with a combined RX and TX path and through an RF switch as part of the reference design. All measurements are performed conducted.

PARAMETER	TEST CONDITIONS	MIN	TYP	MAX	UNIT
<b>125 kbps (LE Coded)</b>					
Receiver sensitivity	Differential mode. BER = $10^{-3}$		-104		dBm
Receiver saturation	Differential mode. BER = $10^{-3}$		>5		dBm
Frequency error tolerance	Difference between the incoming carrier frequency and the internally generated carrier frequency		> (-300 / 300)		kHz
Data rate error tolerance	Difference between incoming data rate and the internally generated data rate (37-byte packets)		> (-320 / 240)		ppm
Data rate error tolerance	Difference between incoming data rate and the internally generated data rate (255-byte packets)		> (-100 / 125)		ppm
Co-channel rejection <sup>(1)</sup>	Wanted signal at -79 dBm, modulated interferer in channel, BER = $10^{-3}$		-1.5		dB
Selectivity, $\pm 1\text{ MHz}$ <sup>(1)</sup>	Wanted signal at -79 dBm, modulated interferer at $\pm 1\text{ MHz}$ , BER = $10^{-3}$		8 / 4.5 <sup>(2)</sup>		dB
Selectivity, $\pm 2\text{ MHz}$ <sup>(1)</sup>	Wanted signal at -79 dBm, modulated interferer at $\pm 2\text{ MHz}$ , BER = $10^{-3}$		44 / 39 <sup>(2)</sup>		dB
Selectivity, $\pm 3\text{ MHz}$ <sup>(1)</sup>	Wanted signal at -79 dBm, modulated interferer at $\pm 3\text{ MHz}$ , BER = $10^{-3}$		43 / 43 <sup>(2)</sup>		dB
Selectivity, $\pm 4\text{ MHz}$ <sup>(1)</sup>	Wanted signal at -79 dBm, modulated interferer at $\pm 4\text{ MHz}$ , BER = $10^{-3}$		44 / 43 <sup>(2)</sup>		dB
Selectivity, $\pm 6\text{ MHz}$ <sup>(1)</sup>	Wanted signal at -79 dBm, modulated interferer at $\geq \pm 6\text{ MHz}$ , BER = $10^{-3}$		48 / 43 <sup>(2)</sup>		dB
Selectivity, $\pm 7\text{ MHz}$	Wanted signal at -79 dBm, modulated interferer at $\geq \pm 7\text{ MHz}$ , BER = $10^{-3}$		51 / 45 <sup>(2)</sup>		dB
Selectivity, Image frequency <sup>(1)</sup>	Wanted signal at -79 dBm, modulated interferer at image frequency, BER = $10^{-3}$		39		dB
Selectivity, Image frequency $\pm 1\text{ MHz}$ <sup>(1)</sup>	Note that Image frequency + 1 MHz is the Co-channel -1 MHz. Wanted signal at -79 dBm, modulated interferer at $\pm 1\text{ MHz}$ from image frequency, BER = $10^{-3}$		4.5 / 44 <sup>(2)</sup>		dB
RSSI Range			89		dB
RSSI Accuracy (+/-)			$\pm 4$		dB
<b>500 kbps (LE Coded)</b>					
Receiver sensitivity	Differential mode. BER = $10^{-3}$		-100		dBm
Receiver saturation	Differential mode. BER = $10^{-3}$		> 5		dBm
Frequency error tolerance	Difference between the incoming carrier frequency and the internally generated carrier frequency		> (-300 / 300)		kHz
Data rate error tolerance	Difference between incoming data rate and the internally generated data rate (37-byte packets)		> (-450 / 450)		ppm
Data rate error tolerance	Difference between incoming data rate and the internally generated data rate (255-byte packets)		> (-175 / 175)		ppm
Co-channel rejection <sup>(1)</sup>	Wanted signal at -72 dBm, modulated interferer in channel, BER = $10^{-3}$		-3.5		dB
Selectivity, $\pm 1\text{ MHz}$ <sup>(1)</sup>	Wanted signal at -72 dBm, modulated interferer at $\pm 1\text{ MHz}$ , BER = $10^{-3}$		8 / 4 <sup>(2)</sup>		dB
Selectivity, $\pm 2\text{ MHz}$ <sup>(1)</sup>	Wanted signal at -72 dBm, modulated interferer at $\pm 2\text{ MHz}$ , BER = $10^{-3}$		41 / 37 <sup>(2)</sup>		dB
Selectivity, $\pm 3\text{ MHz}$ <sup>(1)</sup>	Wanted signal at -72 dBm, modulated interferer at $\pm 3\text{ MHz}$ , BER = $10^{-3}$		44 / 41 <sup>(2)</sup>		dB
Selectivity, $\pm 4\text{ MHz}$ <sup>(1)</sup>	Wanted signal at -72 dBm, modulated interferer at $\pm 4\text{ MHz}$ , BER = $10^{-3}$		44 / 43 <sup>(2)</sup>		dB
Selectivity, $\pm 6\text{ MHz}$ <sup>(1)</sup>	Wanted signal at -72 dBm, modulated interferer at $\geq \pm 6\text{ MHz}$ , BER = $10^{-3}$		46 / 43 <sup>(2)</sup>		dB

## 8.14 Bluetooth Low Energy - Receive (RX) (continued)

Measured on the LP-EM-CC1354P10-1 reference design with  $T_c = 25\text{ }^\circ\text{C}$ ,  $V_{DD5} = 3.0\text{ V}$ ,  $f_{RF} = 2440\text{ MHz}$  with DC/DC enabled and high power PA connected to  $V_{DD5}$  unless otherwise noted.

All measurements are performed at the antenna input with a combined RX and TX path and through an RF switch as part of the reference design. All measurements are performed conducted.

PARAMETER	TEST CONDITIONS	MIN	TYP	MAX	UNIT
Selectivity, $\pm 7\text{ MHz}$	Wanted signal at $-72\text{ dBm}$ , modulated interferer at $\geq \pm 7\text{ MHz}$ , BER = $10^{-3}$		49 / 45 <sup>(2)</sup>		dB
Selectivity, Image frequency <sup>(1)</sup>	Wanted signal at $-72\text{ dBm}$ , modulated interferer at image frequency, BER = $10^{-3}$		37		dB
Selectivity, Image frequency $\pm 1\text{ MHz}$ <sup>(1)</sup>	Note that Image frequency + 1 MHz is the Co- channel $-1\text{ MHz}$ . Wanted signal at $-72\text{ dBm}$ , modulated interferer at $\pm 1\text{ MHz}$ from image frequency, BER = $10^{-3}$		4 / 46 <sup>(2)</sup>		dB
RSSI Range			85		dB
RSSI Accuracy (+/-)			$\pm 4$		dB
<b>1 Mbps (LE 1M)</b>					
Receiver sensitivity	Differential mode. BER = $10^{-3}$		$-97$		dBm
Receiver saturation	Differential mode. BER = $10^{-3}$		$> 5$		dBm
Frequency error tolerance	Difference between the incoming carrier frequency and the internally generated carrier frequency		$> (-350 / 350)$		kHz
Data rate error tolerance	Difference between incoming data rate and the internally generated data rate (37-byte packets)		$> (-750 / 750)$		ppm
Co-channel rejection <sup>(1)</sup>	Wanted signal at $-67\text{ dBm}$ , modulated interferer in channel, BER = $10^{-3}$		$-6$		dB
Selectivity, $\pm 1\text{ MHz}$ <sup>(1)</sup>	Wanted signal at $-67\text{ dBm}$ , modulated interferer at $\pm 1\text{ MHz}$ , BER = $10^{-3}$		7 / 4 <sup>(2)</sup>		dB
Selectivity, $\pm 2\text{ MHz}$ <sup>(1)</sup>	Wanted signal at $-67\text{ dBm}$ , modulated interferer at $\pm 2\text{ MHz}$ , BER = $10^{-3}$		40 / 33 <sup>(2)</sup>		dB
Selectivity, $\pm 3\text{ MHz}$ <sup>(1)</sup>	Wanted signal at $-67\text{ dBm}$ , modulated interferer at $\pm 3\text{ MHz}$ , BER = $10^{-3}$		36 / 41 <sup>(2)</sup>		dB
Selectivity, $\pm 4\text{ MHz}$ <sup>(1)</sup>	Wanted signal at $-67\text{ dBm}$ , modulated interferer at $\pm 4\text{ MHz}$ , BER = $10^{-3}$		36 / 45 <sup>(2)</sup>		dB
Selectivity, $\pm 5\text{ MHz}$ or more <sup>(1)</sup>	Wanted signal at $-67\text{ dBm}$ , modulated interferer at $\geq \pm 5\text{ MHz}$ , BER = $10^{-3}$		40		dB
Selectivity, image frequency <sup>(1)</sup>	Wanted signal at $-67\text{ dBm}$ , modulated interferer at image frequency, BER = $10^{-3}$		33		dB
Selectivity, image frequency $\pm 1\text{ MHz}$ <sup>(1)</sup>	Note that Image frequency + 1 MHz is the Co- channel $-1\text{ MHz}$ . Wanted signal at $-67\text{ dBm}$ , modulated interferer at $\pm 1\text{ MHz}$ from image frequency, BER = $10^{-3}$		4 / 41 <sup>(2)</sup>		dB
Out-of-band blocking <sup>(3)</sup>	30 MHz to 2000 MHz		$-10$		dBm
Out-of-band blocking	2003 MHz to 2399 MHz		$-18$		dBm
Out-of-band blocking	2484 MHz to 2997 MHz		$-12$		dBm
Out-of-band blocking	3000 MHz to 12.75 GHz		$-2$		dBm
Intermodulation	Wanted signal at 2402 MHz, $-64\text{ dBm}$ . Two interferers at 2405 and 2408 MHz respectively, at the given power level		$-42$		dBm
Spurious emissions, 30 to 1000 MHz <sup>(4)</sup>	Measurement in a 50 $\Omega$ single-ended load.		$< -59$		dBm
Spurious emissions, 1 to 12.75 GHz <sup>(4)</sup>	Measurement in a 50 $\Omega$ single-ended load.		$< -47$		dBm
RSSI dynamic range			70		dB
RSSI accuracy			$\pm 4$		dB
<b>2 Mbps (LE 2M)</b>					
Receiver sensitivity	Differential mode. Measured at SMA connector, BER = $10^{-3}$		$-92$		dBm
Receiver saturation	Differential mode. Measured at SMA connector, BER = $10^{-3}$		$> 5$		dBm

## 8.14 Bluetooth Low Energy - Receive (RX) (continued)

Measured on the LP-EM-CC1354P10-1 reference design with  $T_c = 25\text{ }^\circ\text{C}$ ,  $V_{DD5} = 3.0\text{ V}$ ,  $f_{RF} = 2440\text{ MHz}$  with DC/DC enabled and high power PA connected to  $V_{DD5}$  unless otherwise noted.

All measurements are performed at the antenna input with a combined RX and TX path and through an RF switch as part of the reference design. All measurements are performed conducted.

PARAMETER	TEST CONDITIONS	MIN	TYP	MAX	UNIT
Frequency error tolerance	Difference between the incoming carrier frequency and the internally generated carrier frequency		> (-500 / 500)		kHz
Data rate error tolerance	Difference between incoming data rate and the internally generated data rate (37-byte packets)		> (-700 / 750)		ppm
Co-channel rejection <sup>(1)</sup>	Wanted signal at -67 dBm, modulated interferer in channel, BER = $10^{-3}$		-7		dB
Selectivity, $\pm 2\text{ MHz}$ <sup>(1)</sup>	Wanted signal at -67 dBm, modulated interferer at $\pm 2\text{ MHz}$ , Image frequency is at -2 MHz, BER = $10^{-3}$		8 / 4 <sup>(2)</sup>		dB
Selectivity, $\pm 4\text{ MHz}$ <sup>(1)</sup>	Wanted signal at -67 dBm, modulated interferer at $\pm 4\text{ MHz}$ , BER = $10^{-3}$		35 / 32 <sup>(2)</sup>		dB
Selectivity, $\pm 6\text{ MHz}$ <sup>(1)</sup>	Wanted signal at -67 dBm, modulated interferer at $\pm 6\text{ MHz}$ , BER = $10^{-3}$		37 / 34 <sup>(2)</sup>		dB
Selectivity, image frequency <sup>(1)</sup>	Wanted signal at -67 dBm, modulated interferer at image frequency, BER = $10^{-3}$		4		dB
Selectivity, image frequency $\pm 2\text{ MHz}$ <sup>(1)</sup>	Note that Image frequency + 2 MHz is the Co-channel. Wanted signal at -67 dBm, modulated interferer at $\pm 2\text{ MHz}$ from image frequency, BER = $10^{-3}$		-7 / 36 <sup>(2)</sup>		dB
Out-of-band blocking <sup>(3)</sup>	30 MHz to 2000 MHz		-16		dBm
Out-of-band blocking	2003 MHz to 2399 MHz		-21		dBm
Out-of-band blocking	2484 MHz to 2997 MHz		-15		dBm
Out-of-band blocking	3000 MHz to 12.75 GHz		-20		dBm
Intermodulation	Wanted signal at 2402 MHz, -64 dBm. Two interferers at 2408 and 2414 MHz respectively, at the given power level		-37		dBm
RSSI Range			64		dB
RSSI Accuracy (+/-)			$\pm 4$		dB

(1) Numbers given as I/C dB.

(2) X / Y, where X is +N MHz and Y is -N MHz.

(3) Excluding one exception at  $F_{\text{wanted}} / 2$ , per Bluetooth Specification.

(4) Suitable for systems targeting compliance with worldwide radio-frequency regulations ETSI EN 300 328 and EN 300 440 Class 2 (Europe), FCC CFR47 Part 15 (US), and ARIB STD-T66 (Japan).



## 8.15 Bluetooth Low Energy - Transmit (TX)

Measured on the LP-EM-CC1354P10-1 reference design with  $T_c = 25\text{ }^\circ\text{C}$ ,  $V_{DD5} = 3.0\text{ V}$ ,  $f_{RF} = 2440\text{ MHz}$  with DC/DC enabled and high power PA connected to  $V_{DD5}$  unless otherwise noted.

All measurements are performed at the antenna input with a combined RX and TX path and through an RF switch as part of the reference design. All measurements are performed conducted.

PARAMETER	TEST CONDITIONS	MIN	TYP	MAX	UNIT
<b>General Parameters</b>					
Max output power, 2.4 GHz PA	Differential mode, delivered to a single-ended 50 $\Omega$ load through a balun		5		dBm
Output power programmable range, 2.4 GHz PA	Differential mode, delivered to a single-ended 50 $\Omega$ load through a balun		26		dB
<b>Spurious emissions and harmonics</b>					
Spurious emissions, 2.4 GHz PA	f < 1 GHz, outside restricted bands	+5 dBm setting	< -36		dBm
	f < 1 GHz, restricted bands ETSI		< -54		dBm
	f < 1 GHz, restricted bands FCC		< -55		dBm
	f > 1 GHz, including harmonics		< -42		dBm
Harmonics, 2.4 GHz PA	Second harmonic		< -42		dBm
	Third harmonic	< -42		dBm	

## 8.16 Zigbee and Thread - IEEE 802.15.4-2006 2.4 GHz (OQPSK DSSS1:8, 250 kbps) - RX

Measured on the LP-EM-CC1354P10-1 reference design with  $T_c = 25\text{ }^\circ\text{C}$ ,  $V_{DD5} = 3.0\text{ V}$ ,  $f_{RF} = 2440\text{ MHz}$  with DC/DC enabled and high power PA connected to  $V_{DD5}$  unless otherwise noted.

All measurements are performed at the antenna input with a combined RX and TX path and through an RF switch as part of the reference design. All measurements are performed conducted.

PARAMETER	TEST CONDITIONS	MIN	TYP	MAX	UNIT
<b>General Parameters</b>					
Receiver sensitivity	Coherent mode PER = 1%		-105		dBm
Receiver saturation	PER = 1%		> -10		dBm
Adjacent channel rejection	Wanted signal at -82 dBm, modulated interferer at $\pm 5\text{ MHz}$ , PER = 1%		36		dB
Alternate channel rejection	Wanted signal at -82 dBm, modulated interferer at $\pm 10\text{ MHz}$ , PER = 1%		55		dB
Channel rejection, $\pm 15\text{ MHz}$ or more	Wanted signal at -82 dBm, undesired signal is IEEE 802.15.4 modulated channel, stepped through all channels 2405 to 2480 MHz, PER = 1%		59		dB
Blocking and desensitization, 5 MHz from upper band edge	Wanted signal at -97 dBm (3 dB above the sensitivity level), CW jammer, PER = 1%		57		dB
Blocking and desensitization, 10 MHz from upper band edge	Wanted signal at -97 dBm (3 dB above the sensitivity level), CW jammer, PER = 1%		62		dB
Blocking and desensitization, 20 MHz from upper band edge	Wanted signal at -97 dBm (3 dB above the sensitivity level), CW jammer, PER = 1%		62		dB
Blocking and desensitization, 50 MHz from upper band edge	Wanted signal at -97 dBm (3 dB above the sensitivity level), CW jammer, PER = 1%		65		dB
Blocking and desensitization, -5 MHz from lower band edge	Wanted signal at -97 dBm (3 dB above the sensitivity level), CW jammer, PER = 1%		60		dB
Blocking and desensitization, -10 MHz from lower band edge	Wanted signal at -97 dBm (3 dB above the sensitivity level), CW jammer, PER = 1%		60		dB
Blocking and desensitization, -20 MHz from lower band edge	Wanted signal at -97 dBm (3 dB above the sensitivity level), CW jammer, PER = 1%		60		dB
Blocking and desensitization, -50 MHz from lower band edge	Wanted signal at -97 dBm (3 dB above the sensitivity level), CW jammer, PER = 1%		62		dB
Spurious emissions, 30 MHz to 1000 MHz	Measurement in a 50 $\Omega$ single-ended load		-66		dBm
Spurious emissions, 1 GHz to 12.75 GHz	Measurement in a 50 $\Omega$ single-ended load		-53		dBm
Frequency error tolerance	Difference between the incoming carrier frequency and the internally generated carrier frequency		> 100		ppm
Symbol rate error tolerance	Difference between incoming symbol rate and the internally generated symbol rate		> 800		ppm
RSSI dynamic range			95		dB
RSSI accuracy			$\pm 4$		dB

## 8.17 Zigbee and Thread - IEEE 802.15.4-2006 2.4 GHz (OQPSK DSSS1:8, 250 kbps) - TX

Measured on the LP-EM-CC1354P10-1 reference design with  $T_c = 25\text{ }^\circ\text{C}$ ,  $V_{\text{DDS}} = 3.0\text{ V}$ ,  $f_{\text{RF}} = 2440\text{ MHz}$  with DC/DC enabled and high power PA connected to  $V_{\text{DDS}}$  unless otherwise noted. All measurements are performed at the antenna input with a combined RX and TX path and through an RF switch as part of the reference design. All measurements are performed conducted.

PARAMETER	TEST CONDITIONS	MIN	TYP	MAX	UNIT
<b>General Parameters</b>					
Max output power, 2.4 GHz PA	Differential mode, delivered to a single-ended 50 $\Omega$ load through a balun		5		dBm
Output power programmable range, 2.4 GHz PA	Differential mode, delivered to a single-ended 50 $\Omega$ load through a balun		26		dB
<b>Spurious emissions and harmonics</b>					
Spurious emissions, 2.4 GHz PA <sup>(1)</sup>	f < 1 GHz, outside restricted bands	+5 dBm setting	< -36		dBm
	f < 1 GHz, restricted bands ETSI		< -47		dBm
	f < 1 GHz, restricted bands FCC		< -55		dBm
	f > 1 GHz, including harmonics		< -42		dBm
Harmonics, 2.4 GHz PA	Second harmonic		< -42		dBm
	Third harmonic		< -42		dBm
<b>IEEE 802.15.4-2006 2.4 GHz (OQPSK DSSS1:8, 250 kbps)</b>					
Error vector magnitude, 2.4-GHz PA	+5 dBm setting		2		%

(1) To ensure margins for passing FCC requirements for harmonic emission, duty cycling may be required.

## 8.18 Timing and Switching Characteristics

### 8.18.1 Reset Timing

PARAMETER	MIN	TYP	MAX	UNIT
RESET_N low duration	1			$\mu\text{s}$

### 8.18.2 Wakeup Timing

Measured over operating free-air temperature with  $V_{\text{DDS}} = 3.0\text{ V}$  (unless otherwise noted). The times listed here do not include software overhead.

PARAMETER	TEST CONDITIONS	MIN	TYP	MAX	UNIT
MCU, Reset to Active <sup>(1)</sup>		850	4000		$\mu\text{s}$
MCU, Shutdown to Active <sup>(1)</sup>		850	4000		$\mu\text{s}$
MCU, Standby to Active			160		$\mu\text{s}$
MCU, Active to Standby			39		$\mu\text{s}$
MCU, Idle to Active			15		$\mu\text{s}$

(1) The wakeup time is dependent on remaining charge on VDDR capacitor when starting the device, and thus how long the device has been in Reset or Shutdown before starting up again. The wake up time increases with a higher capacitor value.

### 8.18.3 Clock Specifications

#### 8.18.3.1 48 MHz Clock Input (TCXO)

Measured on a Texas Instruments reference design with  $T_c = 25\text{ }^\circ\text{C}$ ,  $V_{DD5} = 3.0\text{ V}$ , unless otherwise noted.<sup>(1)</sup>

PARAMETER	TEST CONDITIONS	MIN	TYP	MAX	UNIT
Clock frequency			48		MHz
TCXO clipped sine output, peak-to-peak	TCXO clipped sine output connected to pin X48M_P through series capacitor	0.8		1.7	V
TCXO with CMOS output, High input voltage	TCXO with CMOS output directly coupled to pin X48M_P	1.3		VDDR	V
TCXO with CMOS output, Low input voltage		0		0.3	V

(1) Probing or otherwise stopping the TCXO while the DC/DC converter is enabled may cause permanent damage to the device.

#### 8.18.3.2 48 MHz Crystal Oscillator (XOSC\_HF)

Measured on a Texas Instruments reference design with  $T_c = 25\text{ }^\circ\text{C}$ ,  $V_{DD5} = 3.0\text{ V}$ , unless otherwise noted.<sup>(1)</sup>

	PARAMETER	MIN	TYP	MAX	UNIT
F	Crystal frequency		48		MHz
ESR	Equivalent series resistance $6\text{ pF} < C_L \leq 9\text{ pF}$		20	60	$\Omega$
ESR	Equivalent series resistance $5\text{ pF} < C_L \leq 6\text{ pF}$			80	$\Omega$
$L_M$	Motional inductance, relates to the load capacitance that is used for the crystal ( $C_L$ in Farads) <sup>(5)</sup>		$< 3 \times 10^{-25} / C_L^2$		H
$C_L$	Crystal load capacitance <sup>(4)</sup>	5	7 <sup>(3)</sup>	9	pF
t	Start-up time <sup>(2)</sup>		200		$\mu\text{s}$

(1) Probing or otherwise stopping the crystal while the DC/DC converter is enabled may cause permanent damage to the device.

(2) Start-up time using the TI-provided power driver. Start-up time may increase if driver is not used.

(3) On-chip default connected capacitance including reference design parasitic capacitance. Connected internal capacitance is changed through software in the Customer Configuration section (CCFG).

(4) Adjustable load capacitance is integrated into the device. External load capacitors are required for systems targeting compliance with certain regulations. See the device errata for further details.

(5) The crystal manufacturer's specification must satisfy this requirement for proper operation.

#### 8.18.3.3 48 MHz RC Oscillator (RCOSC\_HF)

Measured on a Texas Instruments reference design with  $T_c = 25\text{ }^\circ\text{C}$ ,  $V_{DD5} = 3.0\text{ V}$ , unless otherwise noted.

	MIN	TYP	MAX	UNIT
Frequency		48		MHz
Uncalibrated frequency accuracy		$\pm 1$		%
Calibrated frequency accuracy <sup>(1)</sup>		$\pm 0.25$		%
Start-up time		5		$\mu\text{s}$

(1) Accuracy relative to the calibration source (XOSC\_HF).

#### 8.18.3.4 2 MHz RC Oscillator (RCOSC\_MF)

Measured on a Texas Instruments reference design with  $T_c = 25\text{ }^\circ\text{C}$ ,  $V_{DD5} = 3.0\text{ V}$ , unless otherwise noted.

	MIN	TYP	MAX	UNIT
Calibrated frequency		2		MHz
Start-up time		5		$\mu\text{s}$

#### 8.18.3.5 32.768 kHz Crystal Oscillator (XOSC\_LF)

Measured on a Texas Instruments reference design with  $T_c = 25\text{ }^\circ\text{C}$ ,  $V_{DD5} = 3.0\text{ V}$ , unless otherwise noted.

	MIN	TYP	MAX	UNIT
Crystal frequency		32.768		kHz

### 8.18.3.5 32.768 kHz Crystal Oscillator (XOSC\_LF) (continued)

Measured on a Texas Instruments reference design with  $T_c = 25\text{ }^\circ\text{C}$ ,  $V_{DD5} = 3.0\text{ V}$ , unless otherwise noted.

		MIN	TYP	MAX	UNIT
ESR	Equivalent series resistance		30	100	k $\Omega$
$C_L$	Crystal load capacitance	6	7 <sup>(1)</sup>	12	pF

- (1) Default load capacitance using TI reference designs including parasitic capacitance. Crystals with different load capacitance may be used.

### 8.18.3.6 32 kHz RC Oscillator (RCOSC\_LF)

Measured on a Texas Instruments reference design with  $T_c = 25\text{ }^\circ\text{C}$ ,  $V_{DD5} = 3.0\text{ V}$ , unless otherwise noted.

		MIN	TYP	MAX	UNIT
	Calibrated frequency		32.8 <sup>(1)</sup>		kHz
	Temperature coefficient		50		ppm/ $^\circ\text{C}$

- (1) When using RCOSC\_LF as source for the low frequency system clock (SCLK\_LF), the accuracy of the SCLK\_LF-derived Real Time Clock (RTC) can be improved by measuring RCOSC\_LF relative to XOSC\_HF and compensating for the RTC tick speed. This functionality is available through the TI-provided Power driver.

## 8.18.4 Serial Peripheral Interface (SPI) Characteristics

### 8.18.4.1 SPI Characteristics

over operating free-air temperature range (unless otherwise noted).

PARAMETERS		TEST CONDITIONS	MIN	TYP	MAX	UNIT
$f_{SCLK}$ $1/t_{sclk}$	SPI clock frequency	Master Mode $1.8 < V_{DD5} < 3.8$			12	MHz
		Slave Mode $2.7 < V_{DD5} < 3.8$			8	
		Slave Mode $V_{DD5} < 2.7$			7	
$DC_{SCK}$	SCK Duty Cycle		45	50	55	%

### 8.18.4.2 SPI Master Mode

over operating free-air temperature range (unless otherwise noted).

PARAMETERS		TEST CONDITIONS	MIN	TYP	MAX	UNIT
$t_{SCLK\_H/L}$	SCLK High or Low time		$(t_{SPI}/2) - 1$	$t_{SPI} / 2$	$(t_{SPI}/2) + 1$	ns
$t_{CS\_LEAD}$	CS lead-time, CS active to clock		1			SCLK
$t_{CS\_LAG}$	CS lag time, Last clock to CS inactive		1			SCLK
$t_{CS\_ACC}$	CS access time, CS active to MOSI data out				1	SCLK
$t_{CS\_DIS}$	CS disable time, CS inactive to MOSI high impedance				1	SCLK
$t_{SU\_MI}$	MISO input data setup time <sup>(1)</sup>	$V_{DD5} = 3.3\text{ V}$	12.5			ns
$t_{SU\_MI}$	MISO input data setup time	$V_{DD5} = 1.8\text{ V}$	23.5			ns
$t_{HD\_MI}$	MISO input data hold time		0			ns
$t_{VALID\_MO}$	MOSI output data valid time <sup>(2)</sup>	SCLK edge to MOSI valid, $CL = 20\text{ pF}$ (4)			13	ns
$t_{HD\_MO}$	MOSI output data hold time <sup>(3)</sup>	$CL = 20\text{ pF}$	0			ns

- (1) The MISO input data setup time can be fully compensated when delayed sampling feature is enabled.  
(2) Specifies the time to drive the next valid data to the output after the output changing SCLK clock edge.

(3) Specifies how long data on the output is valid after the output changing SCLK clock edge.

### 8.18.4.3 SPI Master Mode Timing Diagrams

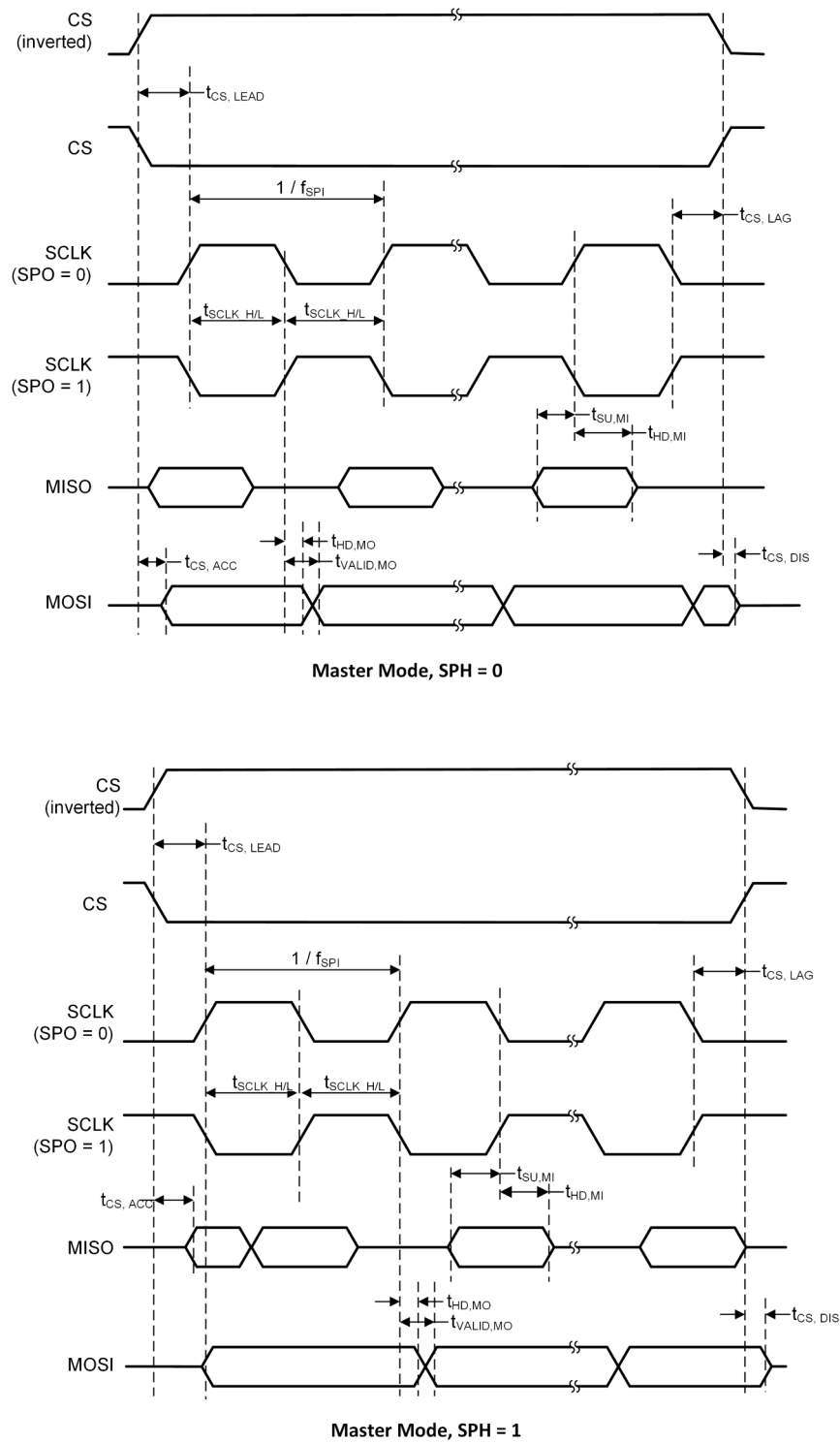


Figure 8-1. SPI Master Mode Timing

#### 8.18.4.4 SPI Slave Mode

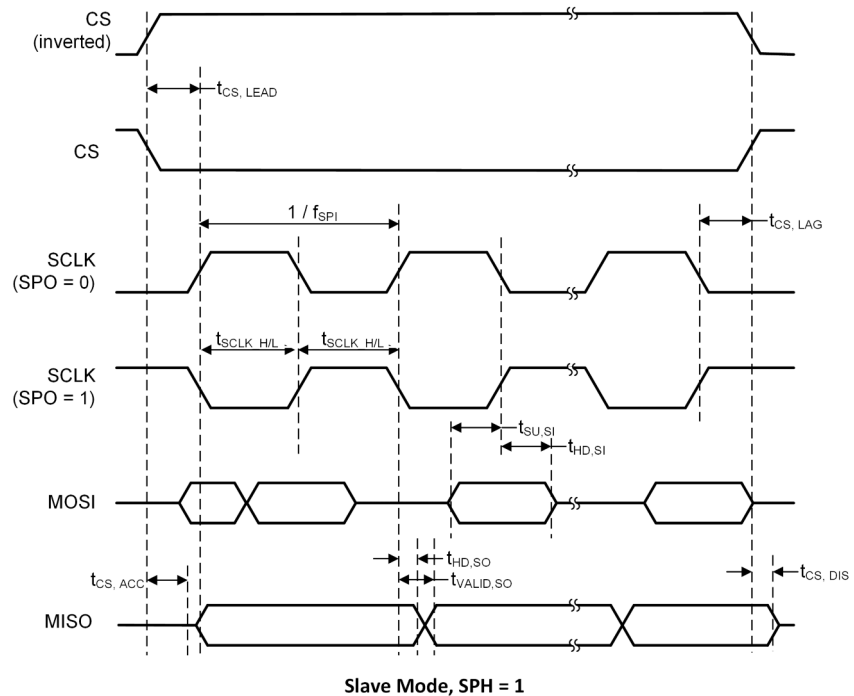
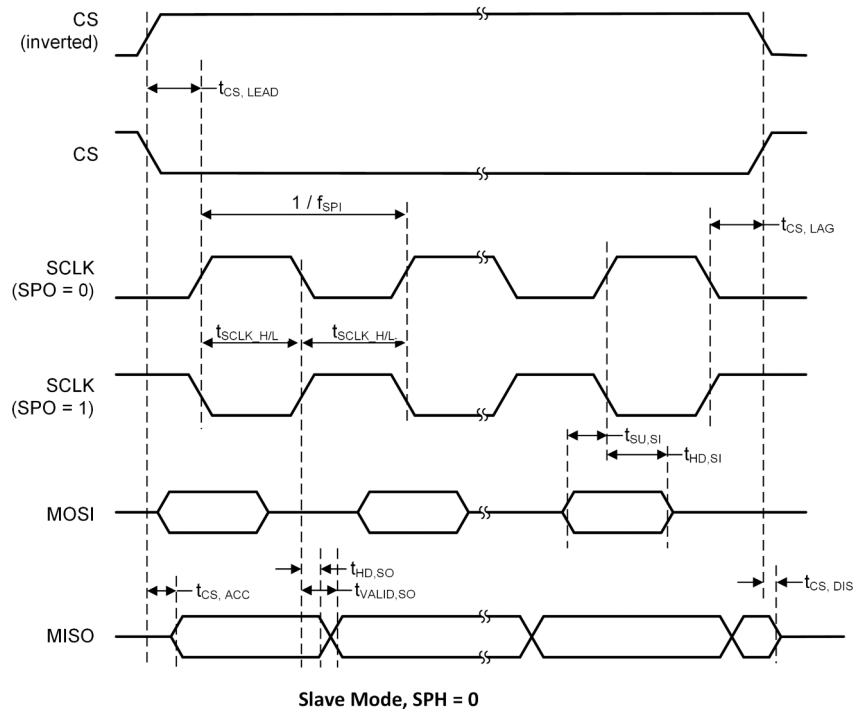
over operating free-air temperature range (unless otherwise noted).

PARAMETERS		TEST CONDITIONS	MIN	TYP	MAX	UNIT
$t_{CS.LEAD}$	CS lead-time, CS active to clock		1			SCLK
$t_{CS.LAG}$	CS lag time, Last clock to CS inactive		1			SCLK
$t_{CS.ACC}$	CS access time, CS active to MISO data out	VDDS = 3.3V			56	ns
$t_{CS.ACC}$	CS access time, CS active to MISO data out	VDDS = 1.8V			70	ns
$t_{CS.DIS}$	CS disable time, CS inactive to MISO high impedance	VDDS = 3.3V			56	ns
$t_{CS.DIS}$	CS disable time, CS inactive to MISO high impedance	VDDS = 1.8V			70	ns
$t_{SU.SI}$	MOSI input data setup time		30			ns
$t_{HD.SI}$	MOSI input data hold time		0			ns
$t_{VALID.SO}$	MISO output data valid time <sup>(1)</sup>	SCLK edge to MISO valid, $C_L = 20$ pF, 3.3V (4)			50	ns
$t_{VALID.SO}$	MISO output data valid time <sup>(1)</sup>	SCLK edge to MISO valid, $C_L = 20$ pF, 1.8V (4)			65	ns
$t_{HD.SO}$	MISO output data hold time <sup>(2)</sup>	$C_L = 20$ pF	0			ns

(1) Specifies the time to drive the next valid data to the output after the output changing SCLK clock edge.

(2) Specifies how long data on the output is valid after the output changing SCLK clock edge.

### 8.18.4.5 SPI Slave Mode Timing Diagrams



**Figure 8-2. SPI Slave Mode Timing**



## 8.18.5 UART

### 8.18.5.1 UART Characteristics

over operating free-air temperature range (unless otherwise noted).

PARAMETER	MIN	TYP	MAX	UNIT
UART rate			3	MBaud

## 8.19 Peripheral Characteristics

### 8.19.1 ADC

#### 8.19.1.1 Analog-to-Digital Converter (ADC) Characteristics

$T_c = 25\text{ }^\circ\text{C}$ ,  $V_{DD5} = 3.0\text{ V}$  and voltage scaling enabled, unless otherwise noted.<sup>(1)</sup>

Performance numbers require use of offset and gain adjustments in software by TI-provided ADC drivers.

PARAMETER		TEST CONDITIONS	MIN	TYP	MAX	UNIT
	Input voltage range		0		VDDS	V
	Resolution			12		Bits
	Sample Rate				200	ksps
	Offset	Internal 4.3 V equivalent reference <sup>(2)</sup>		-0.24		LSB
	Gain error	Internal 4.3 V equivalent reference <sup>(2)</sup>		7.14		LSB
DNL <sup>(4)</sup>	Differential nonlinearity			>-1		LSB
INL	Integral nonlinearity			±4		LSB
ENOB	Effective number of bits	Internal 4.3 V equivalent reference <sup>(2)</sup> , 200 kSamples/s, 9.6 kHz input tone		9.8		Bits
		Internal 4.3 V equivalent reference <sup>(2)</sup> , 200 kSamples/s, 9.6 kHz input tone, DC/DC enabled		9.8		
		VDDS as reference, 200 kSamples/s, 9.6 kHz input tone		10.1		
		Internal reference, voltage scaling disabled, 32 samples average, 200 kSamples/s, 300 Hz input tone		11.1		
		Internal reference, voltage scaling disabled, 14-bit mode, 200 kSamples/s, 300 Hz input tone <sup>(5)</sup>		11.3		
		Internal reference, voltage scaling disabled, 15-bit mode, 200 kSamples/s, 300 Hz input tone <sup>(5)</sup>		11.6		
THD	Total harmonic distortion	Internal 4.3 V equivalent reference <sup>(2)</sup> , 200 kSamples/s, 9.6 kHz input tone		-65		dB
		VDDS as reference, 200 kSamples/s, 9.6 kHz input tone		-70		
		Internal reference, voltage scaling disabled, 32 samples average, 200 kSamples/s, 300 Hz input tone		-72		
SINAD, SNDR	Signal-to-noise and distortion ratio	Internal 4.3 V equivalent reference <sup>(2)</sup> , 200 kSamples/s, 9.6 kHz input tone		60		dB
		VDDS as reference, 200 kSamples/s, 9.6 kHz input tone		63		
		Internal reference, voltage scaling disabled, 32 samples average, 200 kSamples/s, 300 Hz input tone		68		
SFDR	Spurious-free dynamic range	Internal 4.3 V equivalent reference <sup>(2)</sup> , 200 kSamples/s, 9.6 kHz input tone		70		dB
		VDDS as reference, 200 kSamples/s, 9.6 kHz input tone		73		
		Internal reference, voltage scaling disabled, 32 samples average, 200 kSamples/s, 300 Hz input tone		75		
	Conversion time	Serial conversion, time-to-output, 24 MHz clock		50		Clock Cycles
	Current consumption	Internal 4.3 V equivalent reference <sup>(2)</sup>		0.42		mA
	Current consumption	VDDS as reference		0.6		mA
	Reference voltage	Equivalent fixed internal reference (input voltage scaling enabled). For best accuracy, the ADC conversion should be initiated through the TI-RTOS API in order to include the gain/offset compensation factors stored in FCFG1		4.3 <sup>(2)</sup> <sup>(3)</sup>		V

### 8.19.1.1 Analog-to-Digital Converter (ADC) Characteristics (continued)

$T_c = 25\text{ }^\circ\text{C}$ ,  $V_{DD5} = 3.0\text{ V}$  and voltage scaling enabled, unless otherwise noted.<sup>(1)</sup>

Performance numbers require use of offset and gain adjustments in software by TI-provided ADC drivers.

PARAMETER		TEST CONDITIONS	MIN	TYP	MAX	UNIT
	Reference voltage	Fixed internal reference (input voltage scaling disabled). For best accuracy, the ADC conversion should be initiated through the TI-RTOS API in order to include the gain/offset compensation factors stored in FCFG1. This value is derived from the scaled value (4.3 V) as follows: $V_{ref} = 4.3\text{ V} \times 1408 / 4095$		1.48		V
	Reference voltage	VDDS as reference, input voltage scaling enabled		VDDS		V
	Reference voltage	VDDS as reference, input voltage scaling disabled		VDDS / 2.82 <sup>(3)</sup>		V
	Input impedance	200 kSamples/s, voltage scaling enabled. Capacitive input, Input impedance depends on sampling frequency and sampling time		>1		MΩ

- (1) Using IEEE Std 1241-2010 for terminology and test methods.
- (2) Input signal scaled down internally before conversion, as if voltage range was 0 to 4.3 V.
- (3) Applied voltage must be within [Absolute Maximum Ratings](#) at all times.
- (4) No missing codes.
- (5)  $\text{ADC\_output} = \Sigma(4^n \text{ samples}) \gg n$ ,  $n$  = desired extra bits.

## 8.19.2 DAC

### 8.19.2.1 Digital-to-Analog Converter (DAC) Characteristics

$T_c = 25\text{ }^\circ\text{C}$ ,  $V_{DD5} = 3.0\text{ V}$ , unless otherwise noted.

PARAMETER		TEST CONDITIONS	MIN	TYP	MAX	UNIT
<b>General Parameters</b>						
	Resolution			8		Bits
$V_{DD5}$	Supply voltage	Any load, any $V_{REF}$ , pre-charge OFF, DAC charge-pump ON	1.8		3.8	V
		External Load <sup>(4)</sup> , any $V_{REF}$ , pre-charge OFF, DAC charge-pump OFF	2.0		3.8	
		Any load, $V_{REF} = \text{DCOUP}$ , pre-charge ON	2.6		3.8	
$F_{DAC}$	Clock frequency	Buffer ON (recommended for external load)	16		250	kHz
		Buffer OFF (internal load)	16		1000	
	Voltage output settling time	$V_{REF} = V_{DD5}$ , buffer OFF, internal load		13		1 / $F_{DAC}$
		$V_{REF} = V_{DD5}$ , buffer ON, external capacitive load = 20 pF <sup>(3)</sup>		13.8		
	External capacitive load			20	200	pF
	External resistive load		10			MΩ
	Short circuit current				400	μA
$Z_{MAX}$	Max output impedance $V_{ref} = V_{DD5}$ , buffer ON, CLK 250 kHz	$V_{DD5} = 3.8\text{ V}$ , DAC charge-pump OFF		50.8		kΩ
		$V_{DD5} = 3.0\text{ V}$ , DAC charge-pump ON		51.7		
		$V_{DD5} = 3.0\text{ V}$ , DAC charge-pump OFF		53.2		
		$V_{DD5} = 2.0\text{ V}$ , DAC charge-pump ON		48.7		
		$V_{DD5} = 2.0\text{ V}$ , DAC charge-pump OFF		70.2		
		$V_{DD5} = 1.8\text{ V}$ , DAC charge-pump ON		46.3		
		$V_{DD5} = 1.8\text{ V}$ , DAC charge-pump OFF		88.9		
<b>Internal Load - Continuous Time Comparator / Low Power Clocked Comparator</b>						
DNL	Differential nonlinearity	$V_{REF} = V_{DD5}$ , load = Continuous Time Comparator or Low Power Clocked Comparator $F_{DAC} = 250\text{ kHz}$		±1		LSB <sup>(1)</sup>
	Differential nonlinearity	$V_{REF} = V_{DD5}$ , load = Continuous Time Comparator or Low Power Clocked Comparator $F_{DAC} = 16\text{ kHz}$		±1.2		
	Offset error <sup>(2)</sup> Load = Continuous Time Comparator	$V_{REF} = V_{DD5} = 3.8\text{ V}$		±0.64		LSB <sup>(1)</sup>
		$V_{REF} = V_{DD5} = 3.0\text{ V}$		±0.81		
		$V_{REF} = V_{DD5} = 1.8\text{ V}$		±1.27		
		$V_{REF} = \text{DCOUP}$ , pre-charge ON		±3.43		
		$V_{REF} = \text{DCOUP}$ , pre-charge OFF		±2.88		
		$V_{REF} = \text{ADCRE}$		±2.37		
	Offset error <sup>(2)</sup> Load = Low Power Clocked Comparator	$V_{REF} = V_{DD5} = 3.8\text{ V}$		±0.78		LSB <sup>(1)</sup>
		$V_{REF} = V_{DD5} = 3.0\text{ V}$		±0.77		
		$V_{REF} = V_{DD5} = 1.8\text{ V}$		±3.46		
		$V_{REF} = \text{DCOUP}$ , pre-charge ON		±3.44		
		$V_{REF} = \text{DCOUP}$ , pre-charge OFF		±4.70		
		$V_{REF} = \text{ADCRE}$		±4.11		
	Max code output voltage variation <sup>(2)</sup> Load = Continuous Time Comparator	$V_{REF} = V_{DD5} = 3.8\text{ V}$		±1.53		LSB <sup>(1)</sup>
		$V_{REF} = V_{DD5} = 3.0\text{ V}$		±1.71		
		$V_{REF} = V_{DD5} = 1.8\text{ V}$		±2.10		
		$V_{REF} = \text{DCOUP}$ , pre-charge ON		±6.00		
		$V_{REF} = \text{DCOUP}$ , pre-charge OFF		±3.85		
		$V_{REF} = \text{ADCRE}$		±5.84		

### 8.19.2.1 Digital-to-Analog Converter (DAC) Characteristics (continued)

$T_c = 25\text{ }^\circ\text{C}$ ,  $V_{DD5} = 3.0\text{ V}$ , unless otherwise noted.

PARAMETER	TEST CONDITIONS	MIN	TYP	MAX	UNIT
Max code output voltage variation <sup>(2)</sup> Load = Low Power Clocked Comparator	$V_{REF} = V_{DD5} = 3.8\text{ V}$		±2.92		LSB <sup>(1)</sup>
	$V_{REF} = V_{DD5} = 3.0\text{ V}$		±3.06		
	$V_{REF} = V_{DD5} = 1.8\text{ V}$		±3.91		
	$V_{REF} = \text{DCOUP}, \text{pre-charge ON}$		±7.84		
	$V_{REF} = \text{DCOUP}, \text{pre-charge OFF}$		±4.06		
	$V_{REF} = \text{ADCREf}$		±6.94		
Output voltage range <sup>(2)</sup> Load = Continuous Time Comparator	$V_{REF} = V_{DD5} = 3.8\text{ V}$ , code 1		0.03		V
	$V_{REF} = V_{DD5} = 3.8\text{ V}$ , code 255		3.62		
	$V_{REF} = V_{DD5} = 3.0\text{ V}$ , code 1		0.02		
	$V_{REF} = V_{DD5} = 3.0\text{ V}$ , code 255		2.86		
	$V_{REF} = V_{DD5} = 1.8\text{ V}$ , code 1		0.01		
	$V_{REF} = V_{DD5} = 1.8\text{ V}$ , code 255		1.71		
	$V_{REF} = \text{DCOUP}, \text{pre-charge OFF}$ , code 1		0.01		
	$V_{REF} = \text{DCOUP}, \text{pre-charge OFF}$ , code 255		1.21		
	$V_{REF} = \text{DCOUP}, \text{pre-charge ON}$ , code 1		1.27		
	$V_{REF} = \text{DCOUP}, \text{pre-charge ON}$ , code 255		2.46		
	$V_{REF} = \text{ADCREf}$ , code 1		0.01		
	$V_{REF} = \text{ADCREf}$ , code 255		1.41		
Output voltage range <sup>(2)</sup> Load = Low Power Clocked Comparator	$V_{REF} = V_{DD5} = 3.8\text{ V}$ , code 1		0.03		V
	$V_{REF} = V_{DD5} = 3.8\text{ V}$ , code 255		3.61		
	$V_{REF} = V_{DD5} = 3.0\text{ V}$ , code 1		0.02		
	$V_{REF} = V_{DD5} = 3.0\text{ V}$ , code 255		2.85		
	$V_{REF} = V_{DD5} = 1.8\text{ V}$ , code 1		0.01		
	$V_{REF} = V_{DD5} = 1.8\text{ V}$ , code 255		1.71		
	$V_{REF} = \text{DCOUP}, \text{pre-charge OFF}$ , code 1		0.01		
	$V_{REF} = \text{DCOUP}, \text{pre-charge OFF}$ , code 255		1.21		
	$V_{REF} = \text{DCOUP}, \text{pre-charge ON}$ , code 1		1.27		
	$V_{REF} = \text{DCOUP}, \text{pre-charge ON}$ , code 255		2.46		
	$V_{REF} = \text{ADCREf}$ , code 1		0.01		
	$V_{REF} = \text{ADCREf}$ , code 255		1.41		
<b>External Load (Keysight 34401A Multimeter)</b>					
INL	Integral nonlinearity	$V_{REF} = V_{DD5}$ , $F_{DAC} = 250\text{ kHz}$		±1	LSB <sup>(1)</sup>
		$V_{REF} = \text{DCOUP}$ , $F_{DAC} = 250\text{ kHz}$		±1	
		$V_{REF} = \text{ADCREf}$ , $F_{DAC} = 250\text{ kHz}$		±1	
DNL	Differential nonlinearity	$V_{REF} = V_{DD5}$ , $F_{DAC} = 250\text{ kHz}$		±1	LSB <sup>(1)</sup>
Offset error		$V_{REF} = V_{DD5} = 3.8\text{ V}$		±0.20	LSB <sup>(1)</sup>
		$V_{REF} = V_{DD5} = 3.0\text{ V}$		±0.25	
		$V_{REF} = V_{DD5} = 1.8\text{ V}$		±0.45	
		$V_{REF} = \text{DCOUP}, \text{pre-charge ON}$		±1.55	
		$V_{REF} = \text{DCOUP}, \text{pre-charge OFF}$		±1.30	
		$V_{REF} = \text{ADCREf}$		±1.10	
Max code output voltage variation		$V_{REF} = V_{DD5} = 3.8\text{ V}$		±0.60	LSB <sup>(1)</sup>
		$V_{REF} = V_{DD5} = 3.0\text{ V}$		±0.55	
		$V_{REF} = V_{DD5} = 1.8\text{ V}$		±0.60	
		$V_{REF} = \text{DCOUP}, \text{pre-charge ON}$		±3.45	
		$V_{REF} = \text{DCOUP}, \text{pre-charge OFF}$		±2.10	
		$V_{REF} = \text{ADCREf}$		±1.90	

### 8.19.2.1 Digital-to-Analog Converter (DAC) Characteristics (continued)

$T_c = 25\text{ }^\circ\text{C}$ ,  $V_{DD5} = 3.0\text{ V}$ , unless otherwise noted.

PARAMETER	TEST CONDITIONS	MIN	TYP	MAX	UNIT
Output voltage range Load = Low Power Clocked Comparator	$V_{REF} = V_{DD5} = 3.8\text{ V}$ , code 1		0.03		V
	$V_{REF} = V_{DD5} = 3.8\text{ V}$ , code 255		3.61		
	$V_{REF} = V_{DD5} = 3.0\text{ V}$ , code 1		0.02		
	$V_{REF} = V_{DD5} = 3.0\text{ V}$ , code 255		2.85		
	$V_{REF} = V_{DD5} = 1.8\text{ V}$ , code 1		0.02		
	$V_{REF} = V_{DD5} = 1.8\text{ V}$ , code 255		1.71		
	$V_{REF} = \text{DCOUPPL}$ , pre-charge OFF, code 1		0.02		
	$V_{REF} = \text{DCOUPPL}$ , pre-charge OFF, code 255		1.20		
	$V_{REF} = \text{DCOUPPL}$ , pre-charge ON, code 1		1.27		
	$V_{REF} = \text{DCOUPPL}$ , pre-charge ON, code 255		2.46		
	$V_{REF} = \text{ADCREFL}$ , code 1		0.02		
	$V_{REF} = \text{ADCREFL}$ , code 255		1.42		

- (1) 1 LSB ( $V_{REF} 3.8\text{ V}/3.0\text{ V}/1.8\text{ V}/\text{DCOUPPL}/\text{ADCREFL}$ ) = 14.10 mV/11.13 mV/6.68 mV/4.67 mV/5.48 mV.
- (2) Includes comparator offset.
- (3) A load > 20 pF will increase the settling time.
- (4) Keysight 34401A Multimeter.

### 8.19.3 Temperature and Battery Monitor

#### 8.19.3.1 Temperature Sensor

Measured on a Texas Instruments reference design with  $T_c = 25\text{ }^\circ\text{C}$ ,  $V_{DD5} = 3.0\text{ V}$ , unless otherwise noted.

PARAMETER	TEST CONDITIONS	MIN	TYP	MAX	UNIT
Resolution			2		$^\circ\text{C}$
Accuracy	$-40\text{ }^\circ\text{C}$ to $0\text{ }^\circ\text{C}$		$\pm 5.0$		$^\circ\text{C}$
Accuracy	$0\text{ }^\circ\text{C}$ to $105\text{ }^\circ\text{C}$		$\pm 3.5$		$^\circ\text{C}$
Supply voltage coefficient <sup>(1)</sup>			3.6		$^\circ\text{C/V}$

(1) The temperature sensor is automatically compensated for  $V_{DD5}$  variation when using the TI-provided driver.

#### 8.19.3.2 Battery Monitor

Measured on a Texas Instruments reference design with  $T_c = 25\text{ }^\circ\text{C}$ , unless otherwise noted.

PARAMETER	TEST CONDITIONS	MIN	TYP	MAX	UNIT
Resolution			25		mV
Range		1.8		3.8	V
Integral nonlinearity (max)			23		mV
Accuracy	$V_{DD5} = 3.0\text{ V}$		22.5		mV
Offset error			-32		mV
Gain error			-1		%

## 8.19.4 Comparators

### 8.19.4.1 Low-Power Clocked Comparator

$T_c = 25\text{ }^\circ\text{C}$ ,  $V_{DD5} = 3.0\text{ V}$ , unless otherwise noted.

PARAMETER	TEST CONDITIONS	MIN	TYP	MAX	UNIT
Input voltage range		0		$V_{DD5}$	V
Clock frequency			SCLK_LF		
Internal reference voltage <sup>(1)</sup>	Using internal DAC with $V_{DD5}$ as reference voltage, DAC code = 0 - 255		0.024 - 2.865		V
Offset	Measured at $V_{DD5} / 2$ , includes error from internal DAC		$\pm 5$		mV
Decision time	Step from $-50\text{ mV}$ to $50\text{ mV}$		1		Clock Cycle

- (1) The comparator can use an internal 8 bits DAC as its reference. The DAC output voltage range depends on the reference voltage selected. See [DAC Characteristics](#).

### 8.19.4.2 Continuous Time Comparator

$T_c = 25\text{ }^\circ\text{C}$ ,  $V_{DD5} = 3.0\text{ V}$ , unless otherwise noted.

PARAMETER	TEST CONDITIONS	MIN	TYP	MAX	UNIT
Input voltage range <sup>(1)</sup>		0		$V_{DD5}$	V
Offset	Measured at $V_{DD5} / 2$		$\pm 5$		mV
Decision time	Step from $-10\text{ mV}$ to $10\text{ mV}$		0.78		$\mu\text{s}$
Current consumption	Internal reference		8.6		$\mu\text{A}$

- (1) The input voltages can be generated externally and connected throughout I/Os or an internal reference voltage can be generated using the DAC.

## 8.19.5 Current Source

### 8.19.5.1 Programmable Current Source

$T_c = 25\text{ }^\circ\text{C}$ ,  $V_{DD5} = 3.0\text{ V}$ , unless otherwise noted.

PARAMETER	TEST CONDITIONS	MIN	TYP	MAX	UNIT
Current source programmable output range (logarithmic range)			0.25 - 20		$\mu\text{A}$
Resolution			0.25		$\mu\text{A}$

## 8.19.6 GPIO

### 8.19.6.1 GPIO DC Characteristics

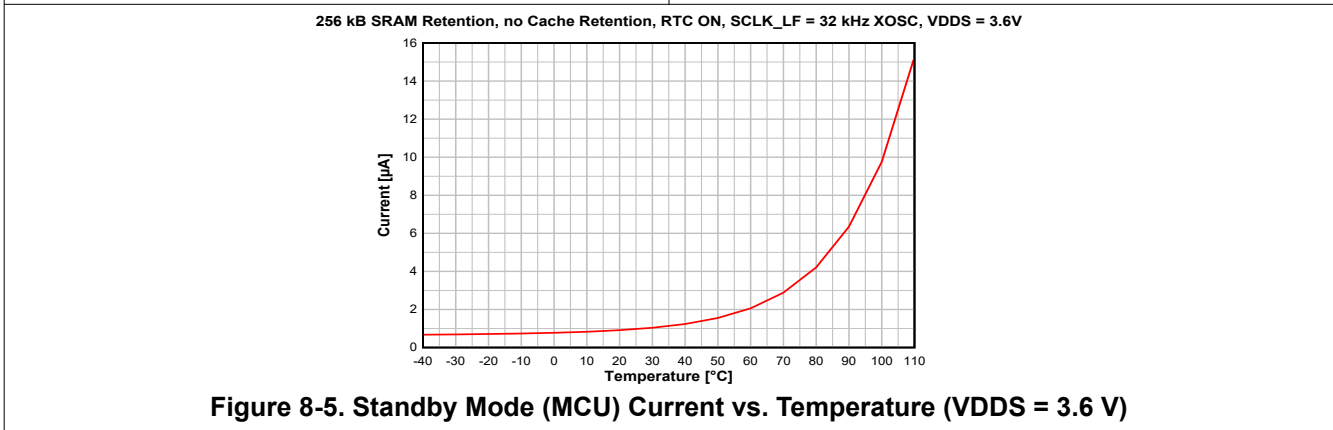
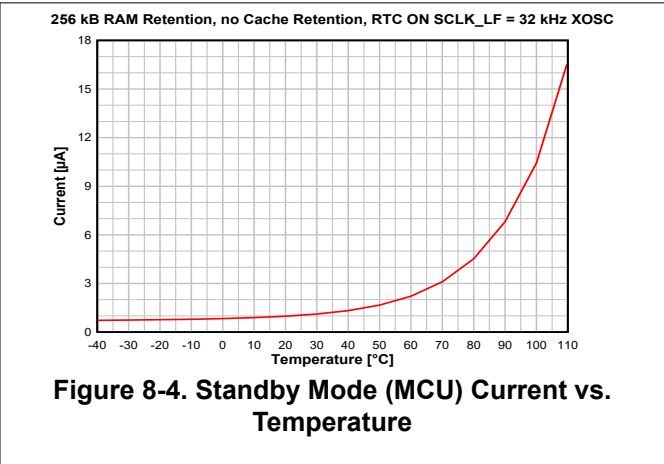
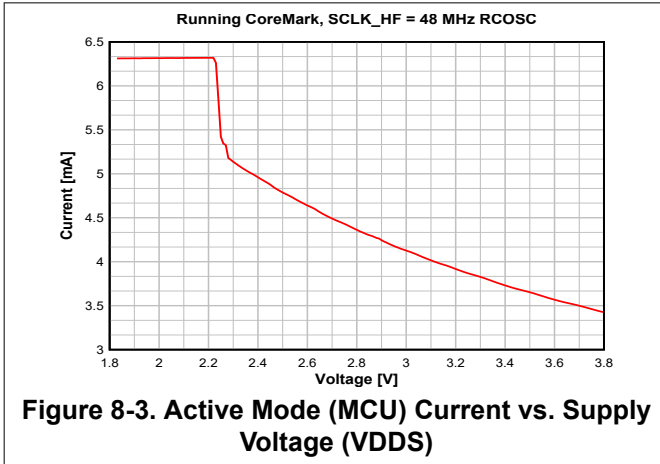
PARAMETER	TEST CONDITIONS	MIN	TYP	MAX	UNIT
<b>T<sub>A</sub> = 25 °C, V<sub>DDs</sub> = 1.8 V</b>					
GPIO VOH at 8 mA load	IOCURR = 2, high-drive GPIOs only		1.56		V
GPIO VOL at 8 mA load	IOCURR = 2, high-drive GPIOs only		0.24		V
GPIO VOH at 4 mA load	IOCURR = 1		1.59		V
GPIO VOL at 4 mA load	IOCURR = 1		0.21		V
GPIO pullup current	Input mode, pullup enabled, Vpad = 0 V		73		μA
GPIO pulldown current	Input mode, pulldown enabled, Vpad = VDDs		19		μA
GPIO low-to-high input transition, with hysteresis	IH = 1, transition voltage for input read as 0 → 1		1.08		V
GPIO high-to-low input transition, with hysteresis	IH = 1, transition voltage for input read as 1 → 0		0.73		V
GPIO input hysteresis	IH = 1, difference between 0 → 1 and 1 → 0 points		0.35		V
<b>T<sub>A</sub> = 25 °C, V<sub>DDs</sub> = 3.0 V</b>					
GPIO VOH at 8 mA load	IOCURR = 2, high-drive GPIOs only		2.59		V
GPIO VOL at 8 mA load	IOCURR = 2, high-drive GPIOs only		0.42		V
GPIO VOH at 4 mA load	IOCURR = 1		2.63		V
GPIO VOL at 4 mA load	IOCURR = 1		0.40		V
<b>T<sub>A</sub> = 25 °C, V<sub>DDs</sub> = 3.8 V</b>					
GPIO pullup current	Input mode, pullup enabled, Vpad = 0 V		282		μA
GPIO pulldown current	Input mode, pulldown enabled, Vpad = VDDs		110		μA
GPIO low-to-high input transition, with hysteresis	IH = 1, transition voltage for input read as 0 → 1		1.97		V
GPIO high-to-low input transition, with hysteresis	IH = 1, transition voltage for input read as 1 → 0		1.55		V
GPIO input hysteresis	IH = 1, difference between 0 → 1 and 1 → 0 points		0.42		V
<b>T<sub>A</sub> = 25 °C</b>					
VIH	Lowest GPIO input voltage reliably interpreted as a <i>High</i>	0.8*V <sub>DDs</sub>			V
VIL	Highest GPIO input voltage reliably interpreted as a <i>Low</i>		0.2*V <sub>DDs</sub>		V



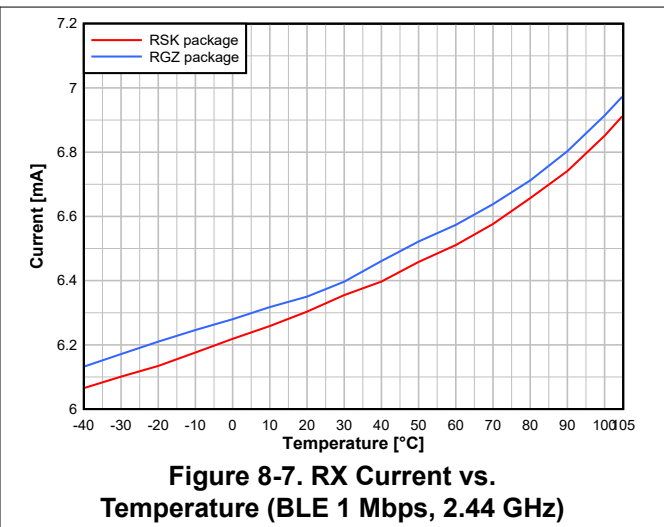
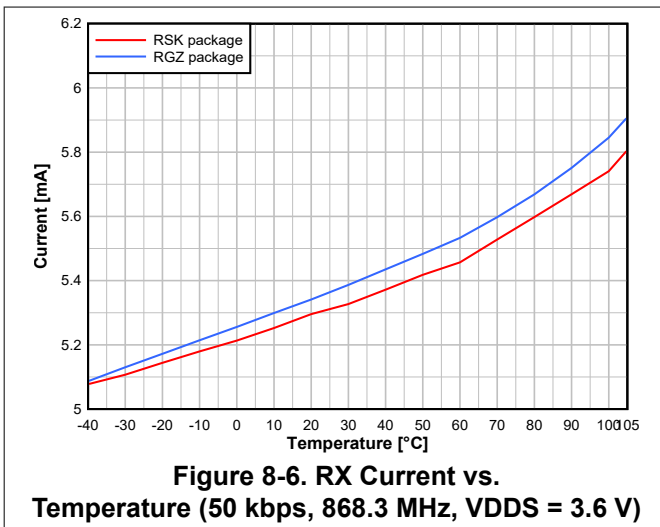
## 8.20 Typical Characteristics

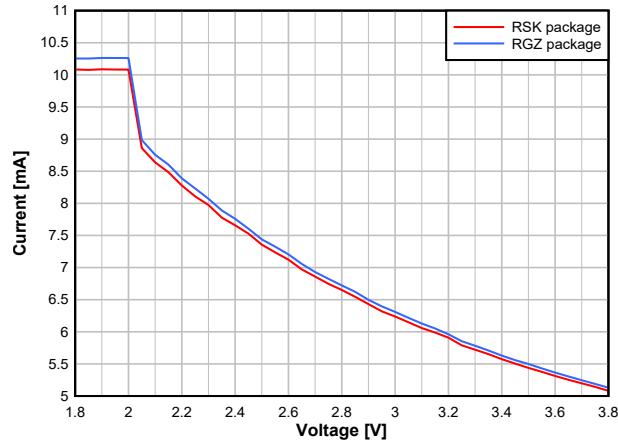
All measurements in this section are done with  $T_c = 25\text{ }^\circ\text{C}$  and  $V_{DD5} = 3.0\text{ V}$ , unless otherwise noted. See *Recommended Operating Conditions*, [Section 8.3](#), for device limits. Values exceeding these limits are for reference only.

### 8.20.1 MCU Current

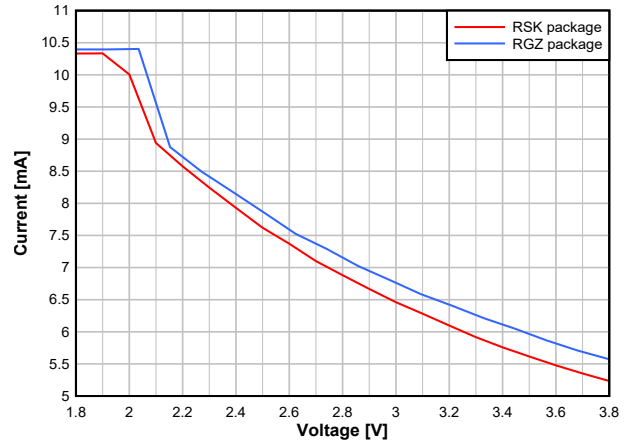


### 8.20.2 RX Current



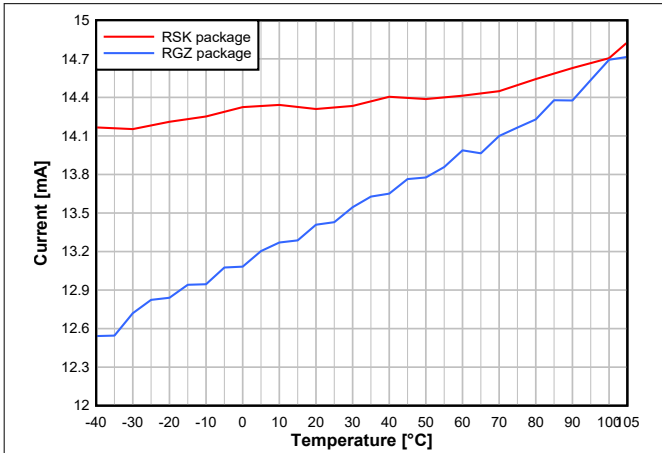


**Figure 8-8. RX Current vs. Supply Voltage (VDDS) (50 kbps, 868.3 MHz)**

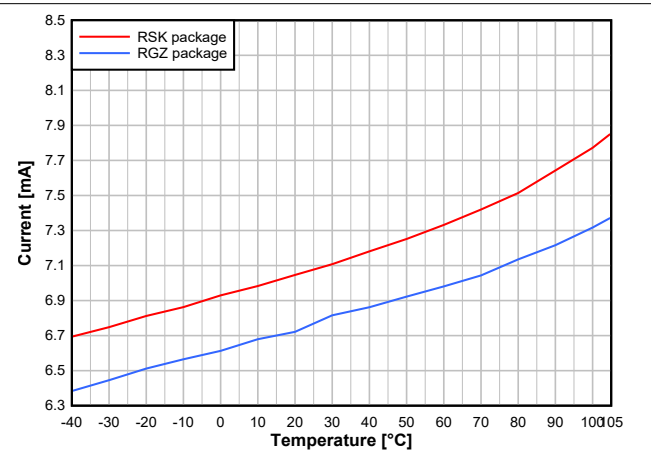


**Figure 8-9. RX Current vs. Supply Voltage (VDDS) (BLE 1 Mbps, 2.44 GHz)**

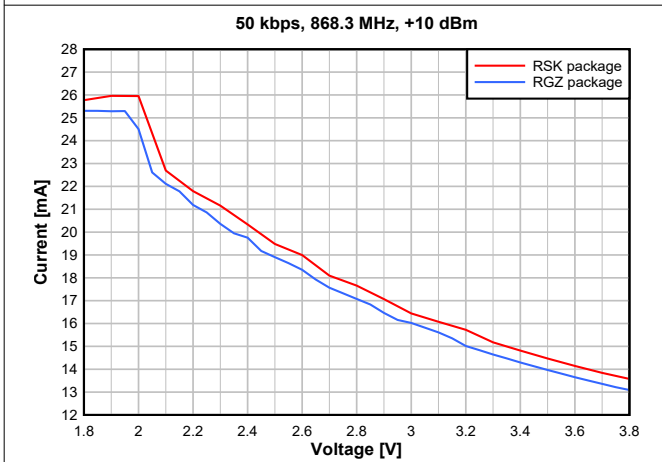
### 8.20.3 TX Current



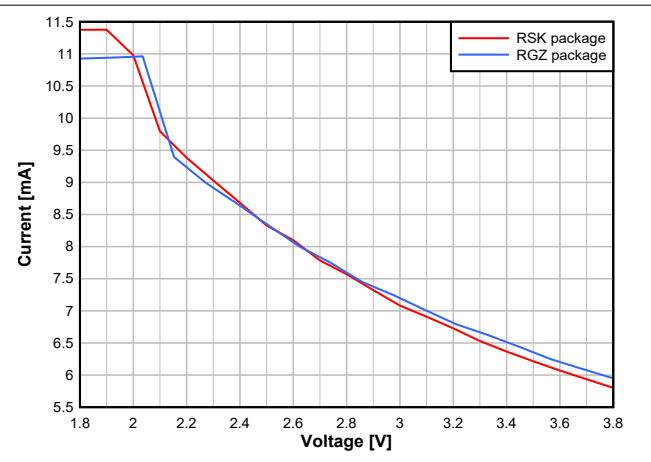
**Figure 8-10. TX Current vs. Temperature (50 kbps, 868.3 MHz, +10 dBm, VDD = 3.6 V)**



**Figure 8-11. TX Current vs. Temperature (BLE 1 Mbps, 2.44 GHz, 0 dBm)**



**Figure 8-12. TX Current vs. Supply Voltage (VDD) (50 kbps, 868.3 MHz)**



**Figure 8-13. TX Current vs. Supply Voltage (VDD) (BLE 1 Mbps, 2.44 GHz, 0 dBm)**

Table 8-1, Table 8-2 and Table 8-3 for RGZ (7 × 7) package and Table 8-4, Table 8-5 and Table 8-6 for RSK (8 × 8) package show typical TX current and output power for different output power settings.

**Table 8-1. Typical TX Current and Output Power (868 MHz, VDD5 = 3.6 V, RGZ package)**

CC1354P10 RGZ at 868 MHz, VDD5 = 3.6 V (Measured on CC1354P10EM-XD7793-XD24-PA9093)			
txPower	TX Power Setting (SmartRF Studio)	Typical Output Power [dBm]	Typical Current Consumption [mA]
0x013F	14	14.0	25.7
0xAE3F	12	12.0	22.0
0xB066	11	11.0	18.8
0x5452	10	10.0	16.7
0x8EA8	9	9.0	15.6
0x629C	8	7.9	14.0
0x15C5F	7	6.9	13.6
0x14E59	6	6.0	12.7
0x6AE8	5	5.0	11.9
0x152B7	4	3.9	12.2
0x15CAC	3	2.9	11.1
0x2466A	2	2.0	11.0
0x1389E	1	0.9	9.6
0x1329A	0	0.0	9.1
0x12A96	-1	-1.0	8.6
0x12493	-2	-2.0	8.2
0x132E7	-3	-3.0	8.6
0x12AE1	-4	-4.0	8.1
0x21CA5	-5	-5.1	8.3
0x216A0	-6	-6.0	7.8
0x2169C	-7	-7.0	7.5
0x20EF3	-8	-8.1	8.5
0x308B6	-9	-9.0	8.8
0x308AE	-10	-10.1	8.2
0x208E0	-11	-11.2	7.1
0x208DC	-12	-12.1	6.8
0x208D9	-13	-13.0	6.5
0x300F4	-14	-14.1	8.3
0x300ED	-15	-15.0	7.8
0x300E7	-16	-16.1	7.4
0x300E2	-17	-17.2	7.0
0x300DE	-18	-18.2	6.7
0x300DB	-19	-19.1	6.5
0x300D8	-20	-20.0	6.2

**Table 8-2. Typical TX Current and Output Power (915 MHz, VDD5 = 3.3 V, RGZ package)**

CC1354P10 RGZ at 915 MHz, VDD5 = 3.3 V (Measured on CC1354P10EM-XD7793-XD24-PA9093)			
txPower	TX Power Setting (SmartRF Studio)	Typical Output Power [dBm]	Typical Current Consumption [mA]
0x1B83D2	20	19.3	58.8
0x448CF	19	18.4	50.6
0x48022	18	17.3	43.0
0x2661C	17	16.5	39.4

**Table 8-2. Typical TX Current and Output Power (915 MHz, VDD5 = 3.3 V, RGZ package) (continued)**

CC1354P10 RGZ at 915 MHz, VDD5 = 3.3 V (Measured on CC1354P10EM-XD7793-XD24-PA9093)			
txPower	TX Power Setting (SmartRF Studio)	Typical Output Power [dBm]	Typical Current Consumption [mA]
0x5618	16	15.7	35.9
0x4812	15	14.8	32.8
0x380D	14	13.7	29.2

**Table 8-3. Typical TX Current and Output Power (2.4 GHz, VDD5 = 3.0 V, RGZ package)**

CC1354P10 RGZ at 2.4 GHz, VDD5 = 3.0 V (Measured on CC1354P10EM-XD7793-XD24-PA9093)			
txPower	TX Power Setting (SmartRF Studio)	Typical Output Power [dBm]	Typical Current Consumption [mA]
0x003F	5	4.8	10.3
0x8A2C	4	4.3	9.7
0x7420	3	3.6	9.1
0x6018	2	2.8	8.6
0x4665	1	2.3	8.3
0x385F	0	1.5	7.9
0x2E55	-3	-0.9	6.9
0x2095	-5	-2.5	6.4
0x2093	-6	-3.4	6.2
0x188E	-9	-6.2	5.6
0x0ED3	-10	-6.6	5.5
0x0ED0	-12	-8.4	5.3
0x08CC	-15	-11.5	4.9
0x08C9	-18	-14.6	4.6
0x08C8	-20	-15.8	4.5

**Table 8-4. Typical TX Current and Output Power (868 MHz, VDD5 = 3.6 V, RSK package)**

CC1354P10 RSK at 868 MHz, VDD5 = 3.6 V (Measured on LP-EM-CC1354P10-1)			
txPower	TX Power Setting (SmartRF Studio)	Typical Output Power [dBm]	Typical Current Consumption [mA]
0x013F	14	13.5	25.2
0xBE33	12	12.2	18.5
0x945F	11	11.2	16.2
0x404E	10	10.1	14.5
0x78A3	9	9.2	13.6
0x17065	8	8.1	13.0
0x1545C	7	7.1	11.9
0x14656	6	6.1	11.0
0x13851	5	4.9	10.2
0x166B1	4	3.9	10.5
0x24E6D	3	2.9	10.2
0x24665	2	1.9	9.4
0x1389B	1	1.0	8.3
0x13297	0	0.1	7.9
0x146F2	-1	-1.1	8.6
0x22AB6	-2	-2.2	8.7
0x132E3	-3	-3.0	7.4
0x12ADD	-4	-4.1	6.9
0x21CA1	-5	-5.1	7.1

**Table 8-4. Typical TX Current and Output Power (868 MHz, VDD5 = 3.6 V, RSK package) (continued)**

CC1354P10 RSK at 868 MHz, VDD5 = 3.6 V (Measured on LP-EM-CC1354P10-1)			
txPower	TX Power Setting (SmartRF Studio)	Typical Output Power [dBm]	Typical Current Consumption [mA]
0x21C9C	-6	-6.1	6.7
0x11CD3	-7	-6.9	6.0
0x30EB8	-8	-8.1	8.1
0x216E7	-9	-9.1	6.9
0x216E1	-10	-10.2	6.4
0x20EDD	-11	-11.1	6.1
0x20ED9	-12	-12.1	5.8
0x20ED6	-13	-13.1	5.6
0x308EF	-14	-14.1	7.1
0x208D1	-15	-15.2	5.2
0x208CF	-16	-16.2	5.1
0x308DF	-17	-17.0	6.0
0x308DB	-18	-18.2	5.8
0x300D8	-19	-18.8	5.6
0x300D5	-20	-19.9	5.4

**Table 8-5. Typical TX Current and Output Power (915 MHz, VDD5 = 3.3 V, RSK package)**

CC1354P10 RSK at 915 MHz, VDD5 = 3.3 V (Measured on LP-EM-CC1354P10-1)			
txPower	TX Power Setting (SmartRF Studio)	Typical Output Power [dBm]	Typical Current Consumption [mA]
0x1B83D2	20	19.6	69.6
0x448CF	19	17.6	55.2
0x48022	18	16.6	46.8
0x2661C	17	16.0	43.1
0x5618	16	15.3	39.7
0x5619	15	14.5	36.3
0x380D	14	13.4	32.5

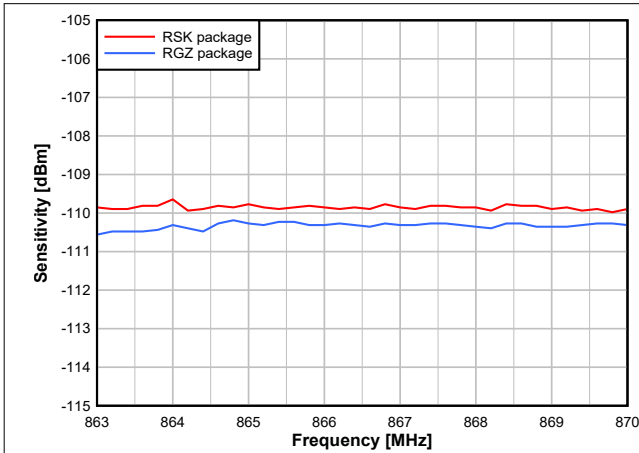
**Table 8-6. Typical TX Current and Output Power (2.4 GHz, VDD5 = 3.0 V, RSK package)**

CC1354P10 RSK at 2.4 GHz, VDD5 = 3.0 V (Measured on LP-EM-CC1354P10-1)			
txPower	TX Power Setting (SmartRF Studio)	Typical Output Power [dBm]	Typical Current Consumption [mA]
0x003F	5	4.7	9.4
0x8029	4	3.9	8.7
0x5C1D	3	3.0	8.1
0x4616	2	2.1	7.6
0x3263	1	1.1	7.2
0x2A5E	0	0.2	6.9
0x1CE6	-3	-2.8	6.1
0x1695	-5	-4.6	5.6
0x1693	-6	-5.6	5.4
0x0E8E	-9	-8.6	5.0
0x00D2	-10	-9.9	4.9
0x088A	-12	-12.0	4.6
0x08CC	-15	-14.6	4.4
0x00C9	-18	-17.6	4.3

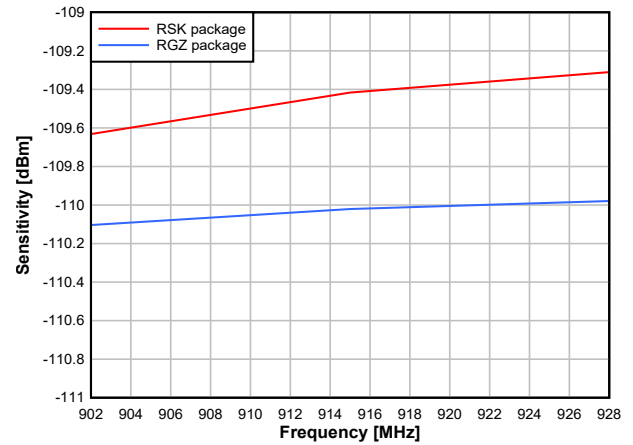
**Table 8-6. Typical TX Current and Output Power (2.4 GHz, VDD5 = 3.0 V, RSK package) (continued)**

CC1354P10 RSK at 2.4 GHz, VDD5 = 3.0 V (Measured on LP-EM-CC1354P10-1)			
txPower	TX Power Setting (SmartRF Studio)	Typical Output Power [dBm]	Typical Current Consumption [mA]
0x00C7	-20	-20.2	4.1

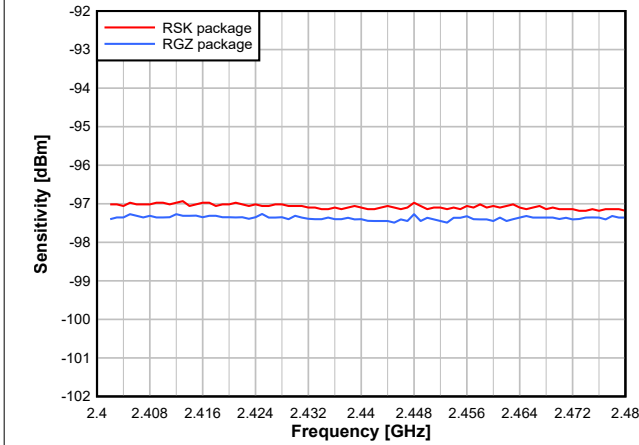
### 8.20.4 RX Performance



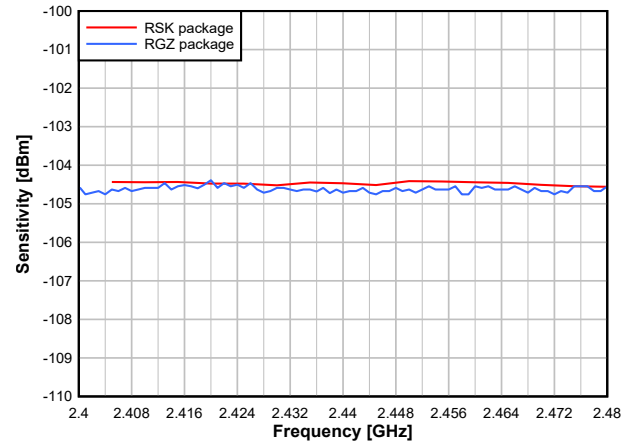
**Figure 8-14. Sensitivity vs. Frequency (50 kbps, 868 MHz)**



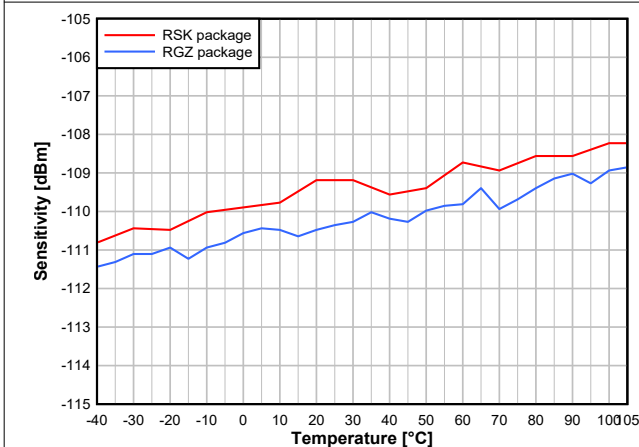
**Figure 8-15. Sensitivity vs. Frequency (50 kbps, 915 MHz)**



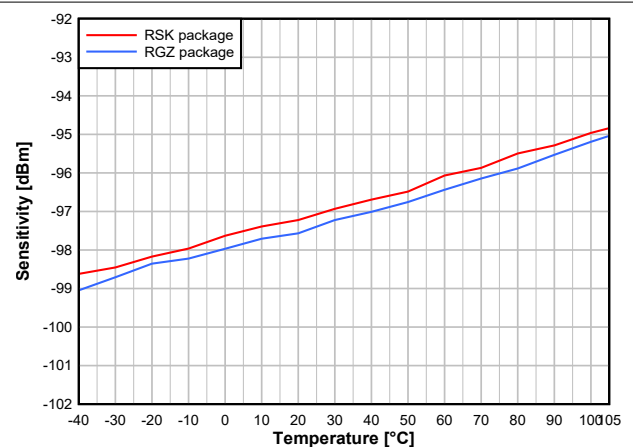
**Figure 8-16. Sensitivity vs. Frequency (BLE 1 Mbps, 2.44 GHz)**



**Figure 8-17. Sensitivity vs. Frequency (IEEE 802.15.4 OQPSK DSSS1:8, 250 kbps, 2.44 GHz)**

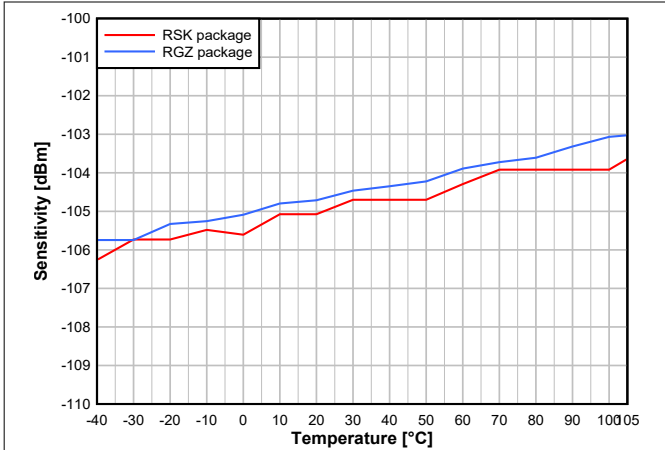


**Figure 8-18. Sensitivity vs. Temperature (50 kbps, 868.3 MHz)**

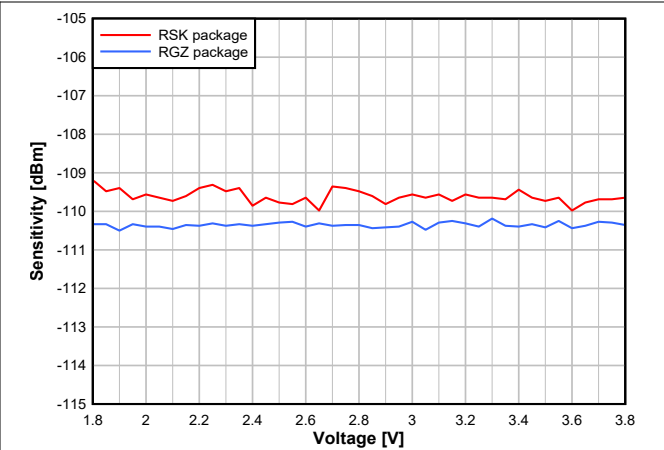


**Figure 8-19. Sensitivity vs. Temperature (BLE 1 Mbps, 2.44 GHz)**

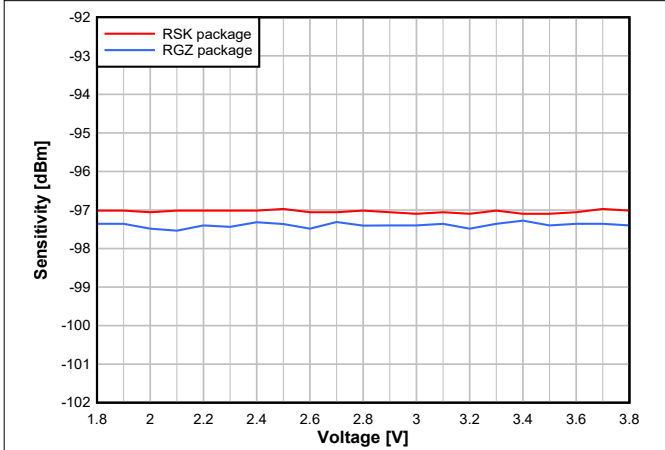




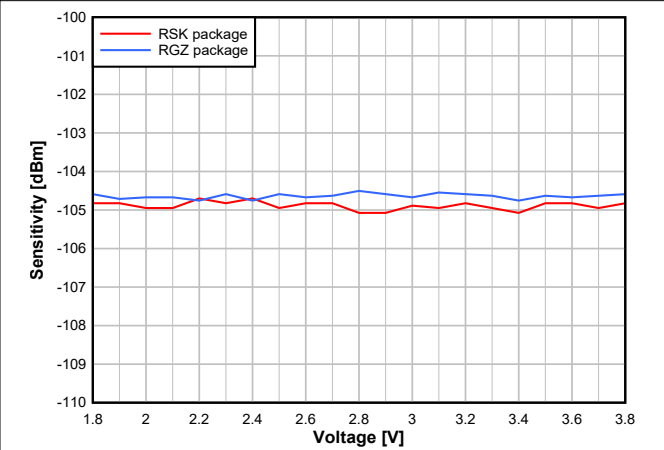
**Figure 8-20. Sensitivity vs. Temperature (250 kbps, 2.44 GHz)**



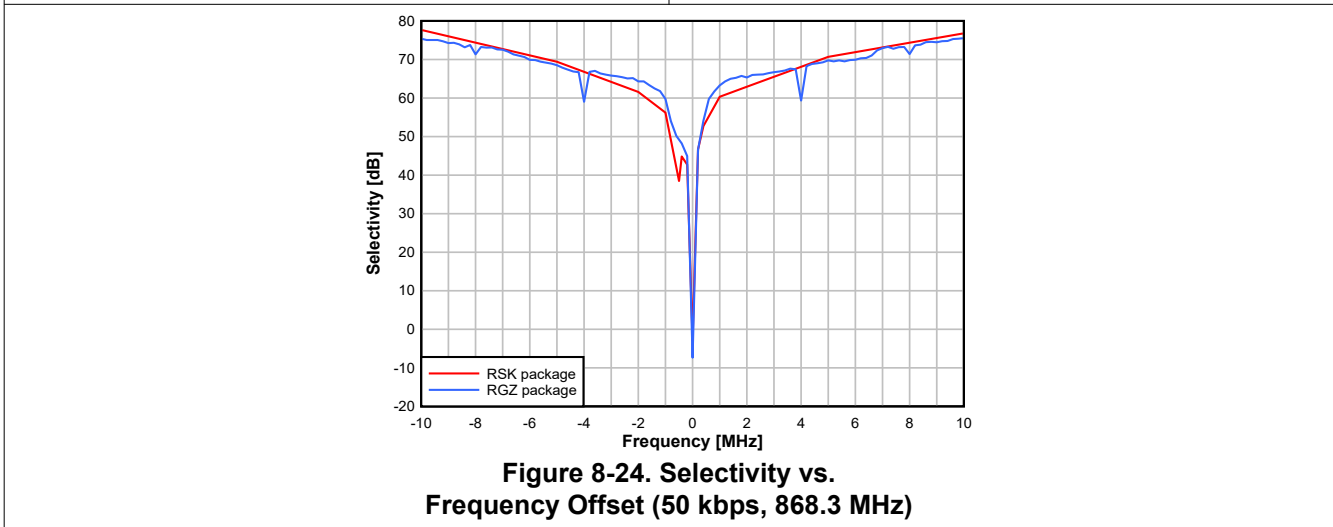
**Figure 8-21. Sensitivity vs. Supply Voltage (VDD5) (50 kbps, 868.3 MHz)**



**Figure 8-22. Sensitivity vs. Supply Voltage (VDD5) (BLE 1 Mbps, 2.44 GHz)**

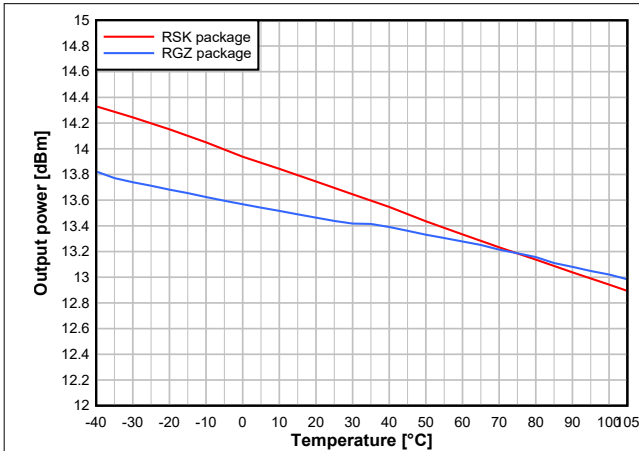


**Figure 8-23. Sensitivity vs. Supply Voltage (VDD5) (250 kbps, 2.44 GHz)**

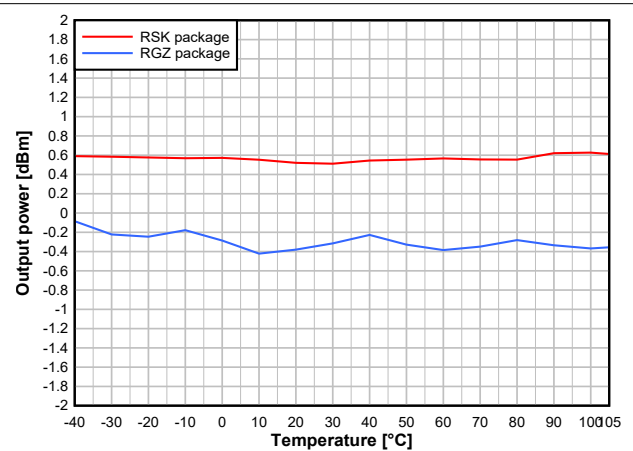


**Figure 8-24. Selectivity vs. Frequency Offset (50 kbps, 868.3 MHz)**

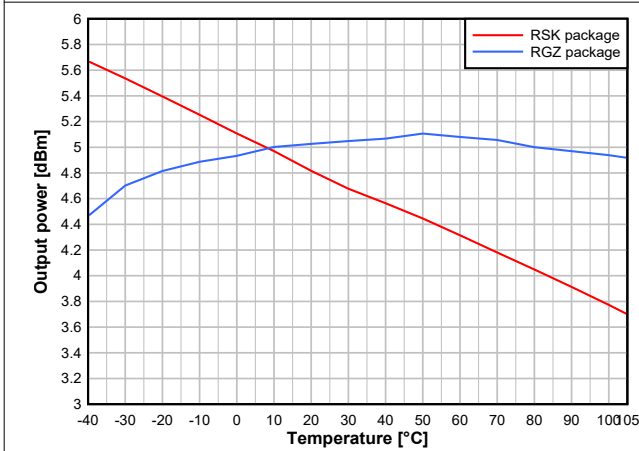
8.20.5 TX Performance



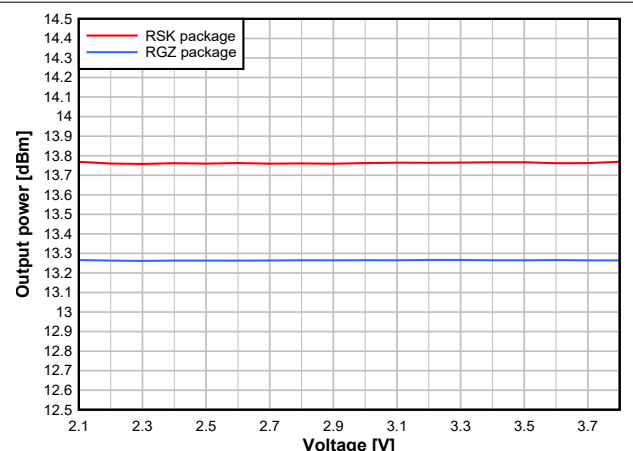
**Figure 8-25. Output Power vs. Temperature (50 kbps, 868.3 MHz, +14 dBm)**



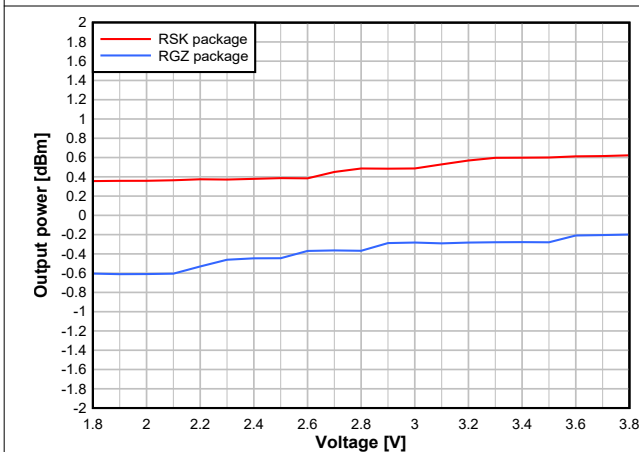
**Figure 8-26. Output Power vs. Temperature (BLE 1 Mbps, 2.44 GHz, 0 dBm)**



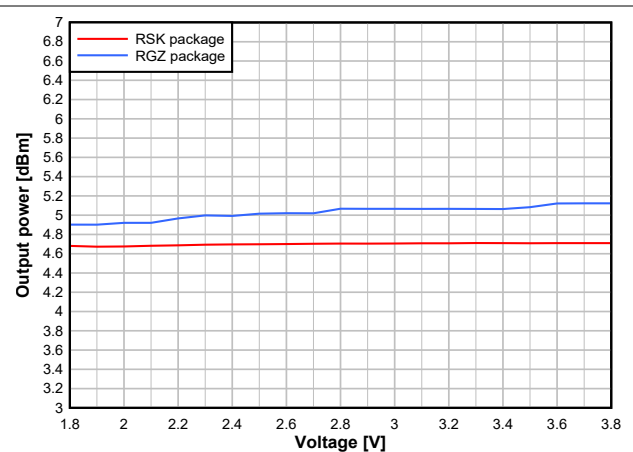
**Figure 8-27. Output Power vs. Temperature (BLE 1 Mbps, 2.44 GHz, +5 dBm)**



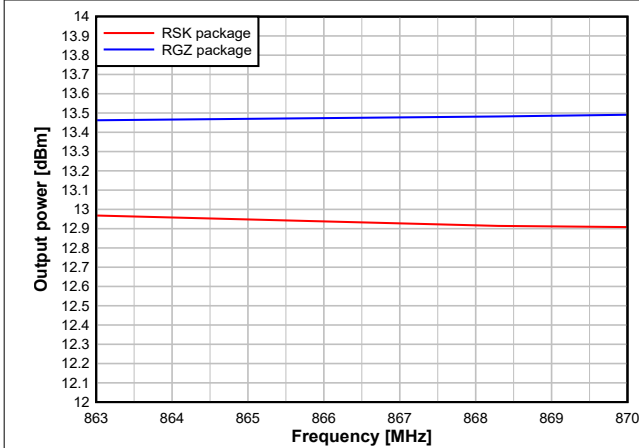
**Figure 8-28. Output Power vs. Supply Voltage (VDD5) (50 kbps, 868.3 MHz, +14 dBm)**



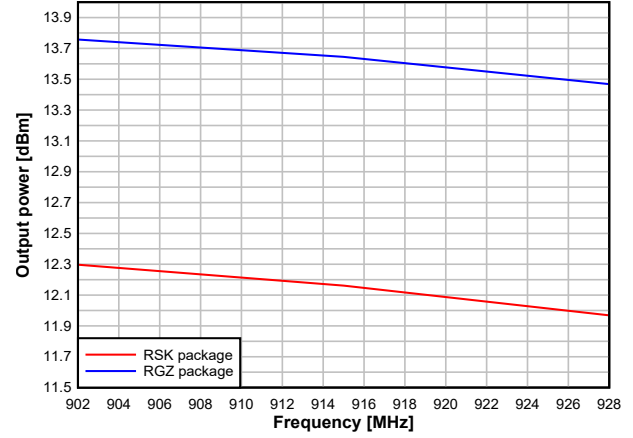
**Figure 8-29. Output Power vs. Supply Voltage (VDD5) (BLE 1 Mbps, 2.44 GHz, 0 dBm)**



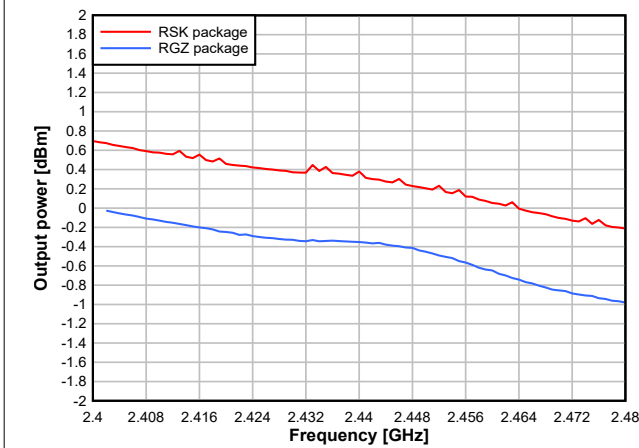
**Figure 8-30. Output Power vs. Supply Voltage (VDD5) (BLE 1 Mbps, 2.44 GHz, +5 dBm)**



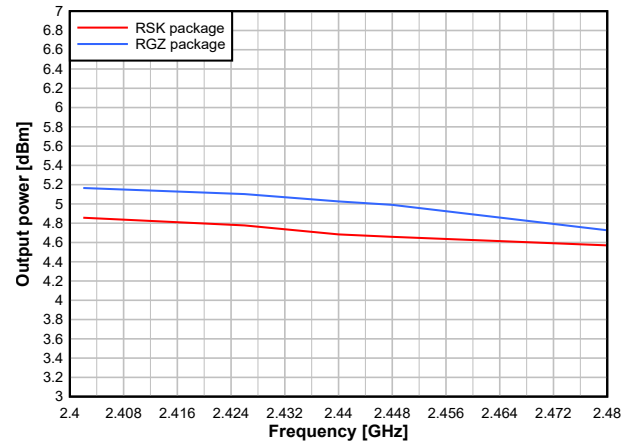
**Figure 8-31. Output Power vs. Frequency (50 kbps, 868 MHz, +14 dBm)**



**Figure 8-32. Output Power vs. Frequency (50 kbps, 915 MHz, +14 dBm)**



**Figure 8-33. Output Power vs. Frequency (BLE 1 Mbps, 2.44 GHz, 0 dBm)**



**Figure 8-34. Output Power vs. Frequency (BLE 1 Mbps, 2.44 GHz, +5 dBm)**

### 8.20.6 ADC Performance

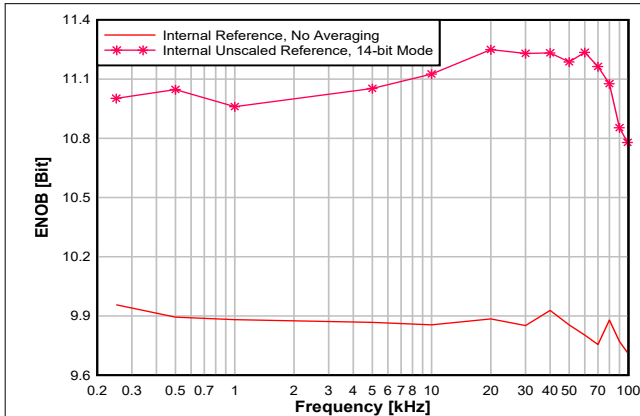


Figure 8-35. ENOB vs. Input Frequency

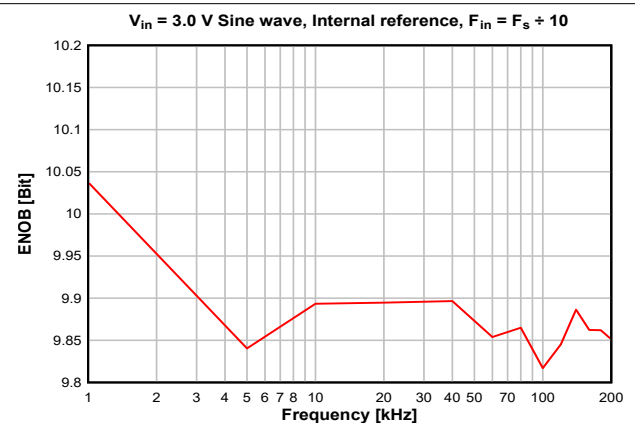


Figure 8-36. ENOB vs. Sampling Frequency

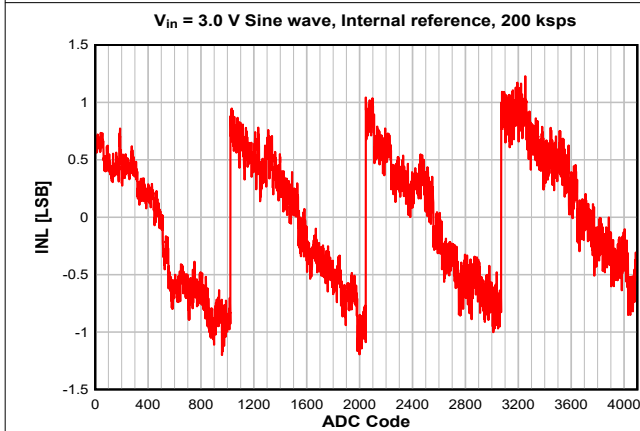


Figure 8-37. INL vs. ADC Code

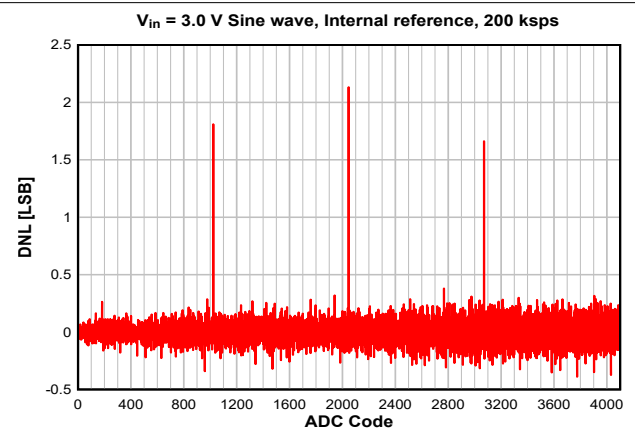


Figure 8-38. DNL vs. ADC Code

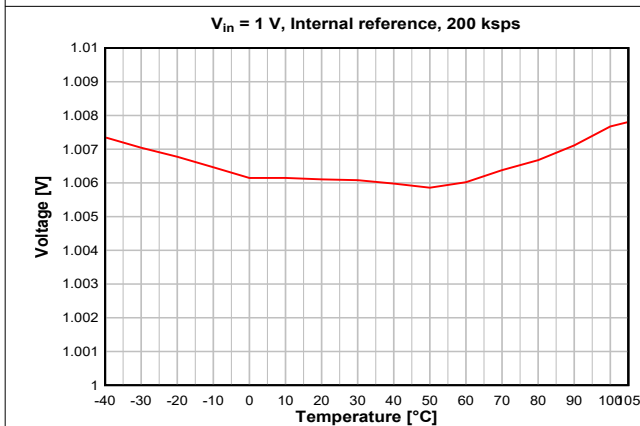


Figure 8-39. ADC Accuracy vs. Temperature

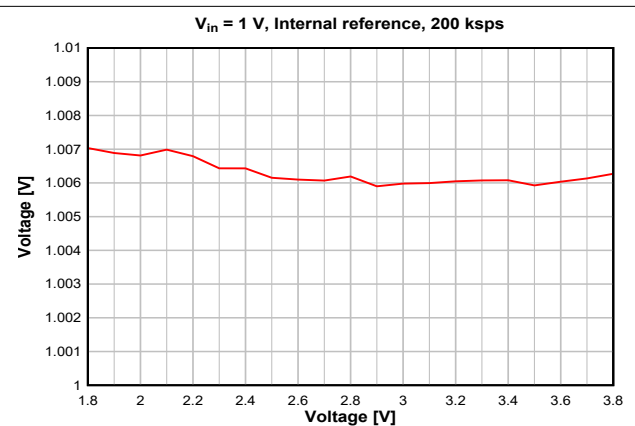


Figure 8-40. ADC Accuracy vs. Supply Voltage (VDD5)

## 9 Detailed Description

### 9.1 Overview

Figure 4-1 shows the core modules of the CC1354P10 device.

Throughout this section, see the Technical Reference Manual listed in [Section 11.2](#) for more details.

### 9.2 System CPU

The CC1354P10 SimpleLink™ Wireless MCU contains an Arm® Cortex®-M33 system CPU with TrustZone®, which runs the application and the higher layers of radio protocol stacks.

The system CPU is the foundation of a high-performance, low-cost platform that meets the system requirements of minimal memory implementation, and low-power consumption, while delivering outstanding computational performance and exceptional system response to interrupts.

Its features include the following:

- ARMv8-M architecture with TrustZone® security extension optimized for small-footprint embedded applications
- Arm Thumb®-2 mixed 16- and 32-bit instruction set delivers the high performance expected of a 32-bit Arm core in a compact memory size
- 8 regions of non-secure memory protected regions
- 8 regions of secure memory protected regions
- 4 regions of Security Attribute Unit (SAU)
- Single-cycle multiply instruction and hardware divide
- Digital signal processing (DSP) extension
- IEEE 754-compliant single-precision Floating Point Unit (FPU)
- Fast code execution permits increased sleep mode time
- Deterministic, high-performance interrupt handling for time-critical applications
- Full debug with data matching for watchpoint generation
  - Data Watchpoint and Trace Unit (DWT)
  - JTAG Debug Access Port (DAP)
  - Flash Patch and Breakpoint Unit (FPB)
- Trace support reduces the number of pins required for debugging and tracing
  - Instrumentation Trace Macrocell Unit (ITM)
  - Trace Port Interface Unit (TPIU) with asynchronous serial wire output (SWO)
- Optimized for single-cycle flash memory access
- Tightly connected to 8 kB 4-way random replacement cache for minimal active power consumption and wait states
- Ultra-low-power consumption with integrated sleep modes
- 48 MHz operation

### 9.3 Radio (RF Core)

The RF Core is a highly flexible and future proof radio module which contains an Arm Cortex-M0 processor that interfaces the analog RF and base-band circuitry, handles data to and from the system CPU side, and assembles the information bits in a given packet structure. The RF core offers a high level, command-based API to the main CPU that configurations and data are passed through. The Arm Cortex-M0 processor is not programmable by customers and is interfaced through the TI-provided RF driver that is included with the SimpleLink Software Development Kit (SDK).

The RF core can autonomously handle the time-critical aspects of the radio protocols, thus offloading the main CPU, which reduces power and leaves more resources for the user application. Several signals are also available to control external circuitry such as RF switches or range extenders autonomously.

Dual-band and multiprotocol solutions are enabled through time-sliced access of the radio, handled transparently for the application through the TI-provided RF driver and dual-mode manager.

The various physical layer radio formats are partly built as a software defined radio where the radio behavior is either defined by radio ROM contents or by non-ROM radio formats delivered in form of firmware patches with the SimpleLink SDKs. This allows the radio platform to be updated for support of future versions of standards even with over-the-air (OTA) updates while still using the same silicon.

---

#### Note

Not all combinations of features, frequencies, data rates, and modulation formats described in this chapter are supported. Over time, TI can enable new physical radio formats (PHYs) for the device and provides performance numbers for selected PHYs in the data sheet. Supported radio formats for a specific device, including optimized settings to use with the TI RF driver, are included in the [SmartRF Studio](#) tool with performance numbers of selected formats found in [Section 8](#).

---

### 9.3.1 Proprietary Radio Formats

The CC1354P10 radio can support a wide range of physical radio formats through a set of hardware peripherals combined with firmware available in the device ROM, covering various customer needs for optimizing towards parameters such as speed or sensitivity. This allows great flexibility in tuning the radio both to work with legacy protocols as well as customizing the behavior for specific application needs.

[Table 9-1](#) gives a simplified overview of features of the various radio formats available in ROM. Other radio formats may be available in the form of radio firmware patches or programs through the Software Development Kit (SDK) and may combine features in a different manner, as well as add other features.

**Table 9-1. Feature Support**

Feature	Main 2-(G)FSK Mode	High Data Rates	Low Data Rates	SimpleLink™ Long Range
Programmable preamble, sync word and CRC	Yes	Yes	Yes	No
Programmable receive bandwidth	Yes	Yes	Yes (down to 4 kHz)	Yes
Data / Symbol rate <sup>(3)</sup>	20 to 1000 kbps	≤ 2 Msps	≤ 100 ksps	≤ 20 ksps
Modulation format	2-(G)FSK	2-(G)FSK 4-(G)FSK	2-(G)FSK 4-(G)FSK	2-(G)FSK
Dual Sync Word	Yes	Yes	No	No
Carrier Sense <sup>(1)</sup> <sup>(2)</sup>	Yes	No	No	No
Preamble Detection <sup>(2)</sup>	Yes	Yes	Yes	No
Data Whitening	Yes	Yes	Yes	Yes
Digital RSSI	Yes	Yes	Yes	Yes
CRC filtering	Yes	Yes	Yes	Yes
Direct-sequence spread spectrum (DSSS)	No	No	No	1:2 1:4 1:8
Forward error correction (FEC)	No	No	No	Yes
Link Quality Indicator (LQI)	Yes	Yes	Yes	Yes

- (1) Carrier Sense can be used to implement HW-controlled listen-before-talk (LBT) and Clear Channel Assessment (CCA) for compliance with such requirements in regulatory standards. This is available through the CMD\_PROP\_CS radio API.
- (2) Carrier Sense and Preamble Detection can be used to implement sniff modes where the radio is duty cycled to save power.
- (3) Data rates are only indicative. Data rates outside this range may also be supported. For some specific combinations of settings, a smaller range might be supported.

### 9.3.2 Bluetooth 5.3 Low Energy

The RF Core offers full support for Bluetooth 5.3 Low Energy, including the high speed 2 Mbps physical layer and the 500 kbps and 125 kbps long range PHYs (Coded PHY) through the TI provided Bluetooth 5.3 stack or through a high-level Bluetooth API. The Bluetooth 5.3 PHY and part of the controller are in radio and system ROM, providing significant savings in memory usage and more space available for applications.

The new high-speed mode allows data transfers up to 2 Mbps, twice the speed of Bluetooth 4.2 and five times the speed of Bluetooth 4.0, without increasing power consumption. In addition to faster speeds, this mode offers significant improvements for energy efficiency and wireless coexistence with reduced radio communication time.

Bluetooth 5.3 also enables unparalleled flexibility for adjustment of speed and range based on application needs, which capitalizes on the high-speed or long-range modes respectively. Data transfers are now possible at 2 Mbps, enabling development of applications using voice, audio, imaging, and data logging that were not previously an option using Bluetooth low energy. With high-speed mode, existing applications deliver faster responses, richer engagement, and longer battery life. Bluetooth 5.3 enables fast, reliable firmware updates.

### **9.3.3 802.15.4 Thread, Zigbee, and 6LoWPAN**

Through a dedicated IEEE radio API, the RF Core supports the 2.4 GHz IEEE 802.15.4-2011 physical layer (2 Mcps per second Offset-QPSK with DSSS 1:8), used in Thread, Zigbee, and 6LoWPAN protocols. The 802.15.4 PHY and MAC are in radio and system ROM. TI also provides royalty-free protocol stacks for Thread and Zigbee as part of the SimpleLink SDK, enabling a robust end-to-end solution.



## 9.4 Memory

The up to 1024 kB nonvolatile (Flash) memory provides storage for code and data. The flash memory is in-system programmable and erasable. The last flash memory sector must contain a Customer Configuration section (CCFG) that is used by boot ROM and TI provided drivers to configure the device. This configuration is done through the `ccfg.c` source file that is included in all TI provided examples.

The ultra-low leakage system static RAM (SRAM) is split into up to eight 32 kB blocks and can be used for both storage of data and execution of code. Retention of SRAM contents in Standby power mode is enabled by default and included in Standby mode power consumption numbers. Parity checking for detection of bit errors in memory is built-in, which reduces chip-level soft errors and thereby increases reliability. Parity can be disabled for an additional 32 kB which can be allocated for general purpose SRAM. System SRAM is always initialized to zeroes upon code execution from boot.

To improve code execution speed and lower power when executing code from nonvolatile memory, a 4-way nonassociative 8 kB cache is enabled by default to cache and prefetch instructions read by the system CPU. The cache can be used as a general-purpose RAM by enabling this feature in the Customer Configuration Area (CCFG).

There is a 4 kB ultra-low leakage SRAM available for use with the Sensor Controller Engine which is typically used for storing Sensor Controller programs, data and configuration parameters. This RAM is also accessible by the system CPU. The Sensor Controller RAM is not cleared to zeroes between system resets.

The ROM includes a TI-RTOS kernel and low-level drivers, as well as significant parts of selected radio stacks, which frees up flash memory for the application. The ROM also contains a serial (SPI and UART) bootloader that can be used for initial programming of the device.

## 9.5 Sensor Controller

The Sensor Controller contains circuitry that can be selectively enabled in both Standby and Active power modes. The peripherals in this domain can be controlled by the Sensor Controller Engine, which is a proprietary power-optimized CPU. This CPU can read and monitor sensors or perform other tasks autonomously; thereby significantly reducing power consumption and offloading the system CPU.

The Sensor Controller Engine is user programmable with a simple programming language that has syntax similar to C. This programmability allows for sensor polling and other tasks to be specified as sequential algorithms rather than static configuration of complex peripheral modules, timers, DMA, register programmable state machines, or event routing.

The main advantages are:

- Flexibility - data can be read and processed in unlimited manners while still ensuring ultra-low power
- 2 MHz low-power mode enables lowest possible handling of digital sensors
- Dynamic reuse of hardware resources
- 40-bit accumulator supporting multiplication, addition and shift
- Observability and debugging options

[Sensor Controller Studio](#) is used to write, test, and debug code for the Sensor Controller. The tool produces C driver source code, which the System CPU application uses to control and exchange data with the Sensor Controller. Typical use cases may be (but are not limited to) the following:

- Read analog sensors using integrated ADC or comparators
- Interface digital sensors using GPIOs, SPI, UART, or I<sup>2</sup>C (UART and I<sup>2</sup>C are bit-banged)
- Capacitive sensing
- Waveform generation
- Very low-power pulse counting (flow metering)
- Key scan

The peripherals in the Sensor Controller include the following:

- The low-power clocked comparator can be used to wake the system CPU from any state in which the comparator is active. A configurable internal reference DAC can be used in conjunction with the comparator. The output of the comparator can also be used to trigger an interrupt or the ADC.
- Capacitive sensing functionality is implemented through the use of a constant current source, a time-to-digital converter, and a comparator. The continuous time comparator in this block can also be used as a higher-accuracy alternative to the low-power clocked comparator. The Sensor Controller takes care of baseline tracking, hysteresis, filtering, and other related functions when these modules are used for capacitive sensing.
- The ADC is a 12-bit 200 ksps ADC with eight inputs and a built-in voltage reference. The ADC can be triggered by many different sources including timers, I/O pins, software, and comparators.
- The analog modules can connect to up to eight different GPIOs.
- Dedicated SPI master with up to 6 MHz clock speed.

The peripherals in the Sensor Controller can also be controlled from the main application processor.

## 9.6 Cryptography

The CC1354P10 device comes with a wide set of modern cryptography-related hardware accelerators, drastically reducing code footprint and execution time for cryptographic operations. It also has the benefit of being lower power and improves availability and responsiveness of the system because the cryptography operations runs in a background hardware thread.

Together with a large selection of open-source cryptography libraries provided with the Software Development Kit (SDK), this allows for secure and future proof IoT applications to be easily built on top of the platform. The hardware accelerator modules are:

- **True Random Number Generator (TRNG)** module provides a true, nondeterministic noise source for the purpose of generating keys, initialization vectors (IVs), and other random number requirements. The TRNG is built on 24 ring oscillators that create unpredictable output to feed a complex nonlinear-combinatorial circuit.
- **Secure Hash Algorithm 2 (SHA-2)** with support for SHA224, SHA256, SHA384, and SHA512.
- **Advanced Encryption Standard (AES)** with 128, 192 and 256 bit key lengths.
- **Public Key Accelerator** - Hardware accelerator supporting mathematical operations needed for elliptic curves up to 512 bits.

Through use of these modules and the TI provided cryptography drivers, the following capabilities are available for an application or stack:

- **Key Agreement Schemes**
  - Elliptic Curve Diffie–Hellman with static or ephemeral keys (ECDH and ECDHE)
  - Elliptic curve Password Authenticated Key Exchange by Juggling (ECJ-PAKE)
- **Signature Processing**
  - Elliptic curve Diffie–Hellman Digital Signature Algorithm (ECDSA)
  - Edwards-curve Digital Signature Algorithm (EdDSA)
- **Curve Support**
  - Short Weierstrass form, such as:
    - NIST-P224 (secp224r1), NIST-P256 (secp256r1), NIST-P384 (secp384r1), NIST-P521 (secp521r1)
    - Brainpool-256R1, Brainpool-384R1, Brainpool-512R1
  - Montgomery form, such as:
    - Curve25519
  - Twisted Edwards form, such as:
    - Ed25519
- **Message Authentication Codes**
  - AEC CBC-MAC
  - AES CMAC
  - HMAC with SHA224, SHA256, SHA384 and SHA512
- **Block cipher mode of operation**
  - AES CCM and AES CCM-Star
  - AES GCM
  - AES ECB
  - AES CBC
  - AES CTR
- **Hash Algorithm**
  - SHA224
  - SHA256
  - SHA384
  - SHA512
- **True random number generation**

Other capabilities, such as RSA encryption and signatures (using keys as large as 2048 bits) as well as other ECC curves such as Curve1174, can be implemented using the provided public key accelerator but are not part of the TI SimpleLink SDK for the CC1354P10 device.

## 9.7 Timers

A large selection of timers are available as part of the CC1354P10 device. These timers are:

- **Real-Time Clock (RTC)**

A 70-bit 3-channel timer running on the 32 kHz low frequency system clock (SCLK\_LF). This timer is available in all power modes except Shutdown. The timer can be calibrated to compensate for frequency drift when using the LF RCOSC as the low frequency system clock. If an external LF clock with frequency different from 32.768 kHz is used, the RTC tick speed can be adjusted to compensate for this. When using TI-RTOS, the RTC is used as the base timer in the operating system and should thus only be accessed through the kernel APIs such as the Clock module. The real time clock can also be read by the Sensor Controller Engine to timestamp sensor data and also has dedicated capture channels. By default, the RTC halts when a debugger halts the device.

- **General Purpose Timers (GPTIMER)**

The four flexible GPTIMERS can be used as either 4 × 32 bit timers or 8 × 16 bit timers, all running on up to 48 MHz. Each of the 16- or 32-bit timers support a wide range of features such as one-shot or periodic counting, pulse width modulation (PWM), time counting between edges and edge counting. The inputs and outputs of the timer are connected to the device event fabric, which allows the timers to interact with signals such as GPIO inputs, other timers, DMA and ADC. The GPTIMERS are available in Active and Idle power modes.

- **Sensor Controller Timers**

The Sensor Controller contains 3 timers:

The Sensor Controller contains 3 timers: AUX Timer 0 and 1 are 16-bit timers with a  $2^N$  prescaler. Timers can either increment on a clock or on each edge of a selected tick source. Both one-shot and periodical timer modes are available.

AUX Timer 2 is a 16-bit timer that can operate at 24 MHz, 2 MHz or 32 kHz independent of the Sensor Controller functionality. There are 4 capture or compare channels, which can be operated in one-shot or periodical modes. The timer can be used to generate events for the Sensor Controller Engine or the ADC, as well as for PWM output or waveform generation.

- **Radio Timer**

A multichannel 32-bit timer running at 4 MHz is available as part of the device radio. The radio timer is typically used as the timing base in wireless network communication using the 32-bit timing word as the network time. The radio timer is synchronized with the RTC by using a dedicated radio API when the device radio is turned on or off. This ensures that for a network stack, the radio timer seems to always be running when the radio is enabled. The radio timer is in most cases used indirectly through the trigger time fields in the radio APIs and should only be used when running the accurate 48 MHz high frequency crystal is the source of SCLK\_HF.

- **Watchdog Timer**

The watchdog timer is used to regain control if the system operates incorrectly due to software errors. It is typically used to generate an interrupt and reset the device for the case where periodic monitoring of the system components and tasks fails to verify proper functionality. The watchdog timer runs on a 1.5 MHz clock rate and cannot be stopped once enabled. The watchdog timer continues to run in Standby power mode but pauses when a debugger halts the device.

- **Always On Watchdog Timer (AON\_WDT)**

The Always On Watchdog Timer is used during standby to regain control when the system has failed due to a software error or failure of an external device to respond in the expected way. It generates a reset when its configured time-out counter reaches zero and cannot be stopped once started, unless by asserting a device reset. The Always-on watchdog timer runs in Standby power mode and may pause when a debugger halts the device.

## 9.8 Serial Peripherals and I/O

The SPI interface provides a standardized synchronous serial interface to communicate with devices compatible with SPI (3 and 4 wire), MICROWIRE and TI Synchronous Serial Format. The SPIs support master/slave operation up to 12 MHz, programmable clock bit rate with prescaler, as well as configurable phase and polarity.

The UART interface implements universal asynchronous receiver and transmitter functions. The UART supports flexible baud-rate generation up to a maximum of 3 Mbps with FIFO, multiple data sizes, stop and parity bits as well as hardware handshake.

The I<sup>2</sup>S interface provides a standardized interface to exchange digital audio with devices compatible with this standard, including ADCs, DACs and CODECs. The I<sup>2</sup>S can also receive pulse-density modulation (PDM) data from devices such as digital microphones and perform conversion to PCM data.

The I<sup>2</sup>C interface enables low speed serial communications with devices compatible with the I<sup>2</sup>C standard. The I<sup>2</sup>C interface can handle both standard (100 kHz) and fast (400 kHz) speeds, as well as four modes of operation: master transmit/receive and slave transmit/receive.

The I/O controller (IOC) controls the digital I/O pins and contains multiplexer circuitry to allow a set of peripherals to be assigned to I/O pins in a flexible manner. All digital I/Os are interrupt and wake-up capable, have a programmable pullup and pulldown function, and can generate an interrupt on a negative or positive edge (configurable). When configured as an output, pins can function as either push-pull or open-drain. Five GPIOs have high-drive capabilities, which are marked in **bold** in [Section 7](#). All digital peripherals can be connected to any digital pin on the device.

## 9.9 Battery and Temperature Monitor

A combined temperature and battery voltage monitor is available in the CC1354P10 device. The battery and temperature monitor allows an application to continuously monitor on-chip temperature and supply voltage and respond to changes in environmental conditions as needed. The module contains window comparators to interrupt the system CPU when temperature or supply voltage go outside defined windows. These events can also be used to wake up the device from Standby mode through the Always-On (AON) event fabric.

## 9.10 $\mu$ DMA

The device includes a direct memory access ( $\mu$ DMA) controller. The  $\mu$ DMA controller provides a way to offload data-transfer tasks from the system CPU, thus allowing for more efficient use of the processor and the available bus bandwidth. The  $\mu$ DMA controller can perform a transfer between memory and peripherals. The  $\mu$ DMA controller has dedicated channels for each supported on-chip module and can be programmed to automatically perform transfers between peripherals and memory when the peripheral is ready to transfer more data.

Some features of the  $\mu$ DMA controller include the following (this is not an exhaustive list):

- Highly flexible and configurable channel operation of up to 32 channels
- Transfer modes: memory-to-memory, memory-to-peripheral, peripheral-to-memory, and peripheral-to-peripheral
- Data sizes of 8, 16, and 32 bits
- Ping-pong mode for continuous streaming of data

## 9.11 Debug

The debug subsystem implements two IEEE standards for debug and test purposes:

IEEE 1149.7 Class 4: Reduced-pin and Enhanced-functionality Test Access Port and Boundary-scan Architecture. This is known by the acronym cJTAG (compact JTAG) and this device uses only two pins to communicate to the target: TMS (JTAG\_TMSC) and TCK (JTAG\_TCKC). This is the default mode of operation.

IEEE standard 1149.1: Test Access Port and Boundary Scan Architecture Test Access Port (TAP). This standard is known by the acronym JTAG and this device uses four pins to communicate to the target: TMS (JTAG\_TMSC), TCK (JTAG\_TCKC), TDI (JTAG\_TDI) and TDO (JTAG\_TDO).

The debug subsystem also implements a user-configurable firewall to control unauthorized access to debug/test ports.

Also featured is **EnergyTrace/EnergyTrace++**. This technology implements an improved method for measuring MCU current consumption, which features a very high dynamic range (from sub- $\mu$ A to hundreds of mA), high sample rate (up to 256 kSamples/s) and the ability to track the CPU and peripheral power states.

Two modes of operation can be configured. **EnergyTrace** measures the overall MCU current consumption and allows maximum accuracy and speed to track ultra low-power states as well as the fast power transitions during radio transmission and reception. **EnergyTrace++** tracks the various power states of both the CPU and its Peripherals as well as the system clocks, allowing a close monitoring of the overall device activity.

## 9.12 Power Management

To minimize power consumption, the CC1354P10 supports a number of power modes and power management features (see [Table 9-2](#)).

**Table 9-2. Power Modes**

MODE	SOFTWARE CONFIGURABLE POWER MODES				RESET PIN HELD
	ACTIVE	IDLE	STANDBY	SHUTDOWN	
CPU	Active	Off	Off	Off	Off
Flash	On	Available	Off	Off	Off
SRAM	On	On	Retention	Off	Off
Supply System	On	On	Duty Cycled	Off	Off
Register and CPU retention	Full	Full	Partial	No	No
SRAM retention	Full	Full	Full	No	No
48 MHz high-speed clock (SCLK_HF)	XOSC_HF or RCOSC_HF	XOSC_HF or RCOSC_HF	Off	Off	Off
2 MHz medium-speed clock (SCLK_MF)	RCOSC_MF	RCOSC_MF	Available	Off	Off
32 kHz low-speed clock (SCLK_LF)	XOSC_LF or RCOSC_LF	XOSC_LF or RCOSC_LF	XOSC_LF or RCOSC_LF	Off	Off
Peripherals	Available	Available	Off	Off	Off
Sensor Controller	Available	Available	Available	Off	Off
Wake-up on RTC	Available	Available	Available	Off	Off
Wake-up on pin edge	Available	Available	Available	Available	Off
Wake-up on reset pin	On	On	On	On	On
Brownout detector (BOD)	On	On	Duty Cycled	Off	Off
Power-on reset (POR)	On	On	On	Off	Off
Watchdog timer (WDT)	Available	Available	Paused	Off	Off
Always-on Watchdog timer (AON_WDT)	Available	Available	Available	Off	Off

In **Active** mode, the application system CPU is actively executing code. Active mode provides normal operation of the processor and all of the peripherals that are currently enabled. The system clock can be any available clock source (see [Table 9-2](#)).

In **Idle** mode, all active peripherals can be clocked, but the Application CPU core and memory are not clocked and no code is executed. Any interrupt event brings the processor back into active mode.

In **Standby** mode, only the always-on (AON) domain is active. An external wake-up event, RTC event, or Sensor Controller event is required to bring the device back to active mode. MCU peripherals with retention do not need to be reconfigured when waking up again, and the CPU continues execution from where it went into standby mode. All GPIOs are latched in standby mode.

In **Shutdown** mode, the device is entirely turned off (including the AON domain and Sensor Controller), and the I/Os are latched with the value they had before entering shutdown mode. A change of state on any I/O pin defined as a *wake from shutdown pin* wakes up the device and functions as a reset trigger. The CPU can differentiate between reset in this way and reset-by-reset pin or power-on reset by reading the reset status register. The only state retained in this mode is the latched I/O state and the flash memory contents.

The Sensor Controller is an autonomous processor that can control the peripherals in the Sensor Controller independently of the system CPU. This means that the system CPU does not have to wake up, for example to perform an ADC sampling or poll a digital sensor over SPI, thus saving both current and wake-up time that would otherwise be wasted. The [Sensor Controller Studio](#) tool enables the user to program the Sensor Controller, control its peripherals, and wake up the system CPU as needed. All Sensor Controller peripherals can also be controlled by the system CPU.

---

#### Note

The power, RF and clock management for the CC1354P10 device require specific configuration and handling by software for optimized performance. This configuration and handling is implemented in the TI-provided drivers that are part of the CC1354P10 software development kit (SDK). Therefore, TI highly recommends using this software framework for all application development on the device. The complete SDK with TI-RTOS (optional), device drivers, and examples is offered free of charge in source code.

---

### 9.13 Clock Systems

The CC1354P10 device has several internal system clocks.

The 48 MHz SCLK\_HF is used as the main system (MCU and peripherals) clock. This can be driven by the internal 48 MHz RC Oscillator (RCOSC\_HF) or an external 48 MHz crystal (XOSC\_HF). Radio operation requires an external 48 MHz crystal.

SCLK\_MF is an internal 2 MHz clock that is used by the Sensor Controller in low-power mode and also for internal power management circuitry. The SCLK\_MF clock is always driven by the internal 2 MHz RC Oscillator (RCOSC\_MF).

SCLK\_LF is the 32.768 kHz internal low-frequency system clock. It can be used by the Sensor Controller for ultra-low-power operation and is also used for the RTC and to synchronize the radio timer before or after Standby power mode. SCLK\_LF can be driven by the internal 32.8 kHz RC Oscillator (RCOSC\_LF), a 32.768 kHz watch-type crystal, or a clock input on any digital IO.

When using a crystal or the internal RC oscillator, the device can output the 32 kHz SCLK\_LF signal to other devices, thereby reducing the overall system cost.

### 9.14 Network Processor

Depending on the product configuration, the CC1354P10 device can function as a wireless network processor (WNP - a device running the wireless protocol stack with the application running on a separate host MCU), or as a system-on-chip (SoC) with the application and protocol stack running on the system CPU inside the device.

In the first case, the external host MCU communicates with the device using SPI or UART. In the second case, the application must be written according to the application framework supplied with the wireless protocol stack.



## 10 Application, Implementation, and Layout

### Note

Information in the following Applications section is not part of the TI component specification, and TI does not warrant its accuracy or completeness. TI's customers are responsible for determining suitability of components for their purposes. Customers should validate and test their design implementation to confirm system functionality.

For general design guidelines and hardware configuration guidelines, refer to [CC13xx/CC26xx Hardware Configuration and PCB Design Considerations Application Report](#).

For optimum RF performance, especially when using the high-power PA, it is important to accurately follow the reference design with respect to component values and layout. Failure to do so may lead to reduced RF performance due to balun mismatch. The amplitude and phase balance through the balun must be <1 dB and <6 degrees, respectively.

PCB stack-up is also critical for proper operation. The CC1354P10 EVMs and characterization boards are using a finished thickness between the top layer (RF signals) and layer 2 (ground plane) of 175  $\mu\text{m}$ . It is very important to use the same substrate thickness, or slightly thicker, in an end product implementing the CC1354P10 device.

Integrated balun devices can be used both at sub-1 GHz frequencies and at 2.4 GHz. The following baluns are recommended for CC1354P10 high-power PA output:

- Johanson Technology 1720BL15B0200E
- Anaren BD0826J50200AH

### 10.1 Reference Designs

The following reference designs should be followed closely when implementing designs using the CC1354P10 device.

Special attention must be paid to RF component placement, decoupling capacitors and DC/DC regulator components, as well as ground connections for all of these.

[CC1352PEM-XD7793-XD24-PA9093 Design Files](#) The CC1352PEM-XD7793-XD24-PA9093 reference design provides schematic, layout and production files for the characterization board used for deriving the performance number found in this document. This board includes tuning for 915 MHz on the high-power PA output.

[CC1352PEM-XD7793-XD24-PA24 Design Files](#) The CC1352PEM-XD7793-XD24-PA24 reference design provides schematic, layout and production files for the characterization board used for deriving the performance number found in this document. This board includes tuning for 2.4 GHz on the high-power PA output.

[LP-EM-CC1354P10-1 Design Files](#) Detailed schematics and layouts for the multi-band CC1354P10 LaunchPad evaluation board featuring 868/915 MHz RF matching on the 20 dBm PA output and up to 5 dBm TX power at 2.4 GHz.

[LP-EM-CC1354P10-6 Design Files](#) Detailed schematics and layouts for the multi-band CC1354P10 LaunchPad evaluation board featuring 2.4 GHz RF matching optimized for 10 dBm operation on the 20 dBm PA output and up to 13 dBm TX power at 433 MHz.

[Sub-1 GHz and 2.4 GHz Antenna Kit for LaunchPad™ Development Kit and SensorTag](#) The antenna kit allows real-life testing to identify the optimal antenna for your application. The antenna kit includes 16 antennas for frequencies from 169 MHz to 2.4 GHz, including:

- PCB antennas

- Helical antennas
- Chip antennas
- Dual-band antennas for 868 MHz and 915 MHz combined with 2.4 GHz

The antenna kit includes a JSC cable to connect to the Wireless MCU LaunchPad Development Kits and SensorTags.

## 11 Device and Documentation Support

TI offers an extensive line of development tools. Tools and software to evaluate the performance of the device, generate code, and develop solutions are listed as follows.

### 11.1 Tools and Software

The CC1354P10 device is supported by a variety of software and hardware development tools.

#### Development Kit

##### [CC1354P10-1 LaunchPad™ Development Kit](#)

The CC1354P10-1 LaunchPad™ Development Kit enables development of high-performance wireless applications in the 863 - 930 MHz and 2.4 GHz frequency bands that benefit from low-power operation. The kit features the CC1354P10 multi-band and multiprotocol SimpleLink™ Wireless MCU with an integrated High-Power Amplifier. The kit works with the LaunchPad ecosystem, easily enabling additional functionality like sensors, display, and more.

The RF configuration of the LaunchPad enables up to +20 dBm output power for 863 to 930 MHz and +5 dBm output power for 2.4 GHz.

##### [CC1354P10-6 LaunchPad™ Development Kit](#)

The CC1354P10-6 LaunchPad™ Development Kit enables development of high-performance wireless applications in the 863 - 930 MHz and 2.4 GHz frequency bands that benefit from low-power operation. The kit features the CC1354P10 multi-band and multiprotocol SimpleLink™ Wireless MCU with an integrated High-Power Amplifier. The kit works with the LaunchPad ecosystem, easily enabling additional functionality like sensors, display, and more. The built-in EnergyTrace™ software is an energy-based code analysis tool that measures and displays the application's energy profile and helps to optimize it for ultra-low power consumption.

The RF configuration of the LaunchPad enables up to +14 dBm output power for 863 to 930 MHz and +20 dBm output power for 2.4 GHz.

##### [LP-XDS110 LaunchPad™ Debug Probe](#)

The LP-XDS110 LaunchPad™ Debug Probe enables development of high-performance wireless applications in the entire family of LP-EM LaunchPad™ development boards. Featuring a seamless connection with the new 20-pin LP-EM Debug connector, it supports not only multiple standards such as JTAG/cJTAG/SWD but also a UART backchannel for maximum debugging flexibility. It also features an Arm® 10-pin Debug connector to perform debugging in any custom board.

##### [LP-XDS110ET LaunchPad™ Debug Probe](#)

The LP-XDS110ET LaunchPad™ Debug Probe enables development of high-performance wireless applications in the entire family of LP-EM LaunchPad™ development boards. Featuring a seamless connection with the new 20-pin LP-EM Debug connector, it supports not only multiple standards such as JTAG/cJTAG/SWD but also a UART backchannel for maximum debugging flexibility. In addition, it also features an Arm® 10-pin Debug connector to perform debugging in any custom board. This Debug Probe also features the XDS110 EnergyTrace™ technology, which is a new method for measuring the current consumption that captures the complete operational profile of the wireless MCU.

##### [TMDSEMU110-U Debug Probe](#)

The TMDSEMU110-U Debug Probe enables development of high-performance wireless applications in the entire family of SimpleLink™ LaunchPad™ development boards. Featuring a convenient enclosure, which grants the proper mechanical robustness for field and production environments, it supports not only multiple standards such as JTAG/cJTAG/SWD but also a UART backchannel and four GPIOs for maximum debugging flexibility. In addition, the expansion connector allows using the [TMDSEMU110-ETH](#) add-on (sold separately), which adds the full featured XDS110 EnergyTrace™ technology with

variable supply voltage from 1.8V to 3.6V and up to 800 mA of supply current. The XDS110 EnergyTrace™ technology is a new method for measuring the current consumption that captures the complete operational profile of the wireless MCU.

## Software

### SimpleLink™ LOWPOWER F2 SDK

The SimpleLink™ LOWPOWER F2 Software Development Kit (SDK) provides a complete package for the development of wireless applications on the CC13XX / CC26XX family of devices. The SDK includes a comprehensive software package for the CC1354P10 device, including the following protocol stacks:

- Bluetooth Low Energy 4 and 5.3
- Thread (based on OpenThread)
- TI Z-Stack (Zigbee 3.0)
- TI 15.4-Stack - an IEEE 802.15.4-based star networking solution for Sub-1 GHz and 2.4 GHz
- EasyLink - a large set of building blocks for building proprietary RF software stacks
- Multiprotocol support - concurrent operation between stacks using the Dynamic Multiprotocol Manager (DMM)
- TI Wi-SUN FAN Stack
- Matter

The SimpleLink™ LOWPOWER F2 SDK is part of TI's SimpleLink™ MCU platform, offering a single development environment that delivers flexible hardware, software and tool options for customers developing wired and wireless applications. For more information about the SimpleLink™ MCU Platform, visit [ti.com/simplelink](http://ti.com/simplelink).

## Development Tools

### Code Composer Studio™ Integrated Development Environment (IDE)

Code Composer Studio is an integrated development environment (IDE) that supports TI's Microcontroller and Embedded Processors portfolio. Code Composer Studio comprises a suite of tools used to develop and debug embedded applications. It includes an optimizing C/C++ compiler, source code editor, project build environment, debugger, profiler, and many other features. The intuitive IDE provides a single user interface taking you through each step of the application development flow. Familiar tools and interfaces allow users to get started faster than ever before. Code Composer Studio combines the advantages of the Eclipse® software framework with advanced embedded debug capabilities from TI resulting in a compelling feature-rich development environment for embedded developers.

CCS has support for all SimpleLink™ Wireless MCUs and includes support for EnergyTrace™ software (application energy usage profiling). A real-time object viewer plugin is available for TI-RTOS, part of the SimpleLink™ SDK.

Code Composer Studio is provided free of charge when used in conjunction with the XDS debuggers included on a LaunchPad Development Kit.

### Code Composer Studio™ Cloud IDE

Code Composer Studio (CCS) Cloud is a web-based IDE that allows you to create, edit and build CCS and Energia™ projects. After you have successfully built your project, you can download and run on your connected LaunchPad. Basic debugging, including features like setting breakpoints and viewing variable values is now supported with CCS Cloud.

### IAR Embedded Workbench® for Arm®

IAR Embedded Workbench® is a set of development tools for building and debugging embedded system applications using assembler, C and C++. It provides a completely integrated development environment that includes a project manager, editor, and build tools. IAR has support for all SimpleLink™ Wireless MCUs. It offers broad debugger support, including XDS110, IAR I-jet™ and Segger J-Link™. A real-time object viewer plugin is available for TI-RTOS, part of the SimpleLink™ SDK. IAR is also supported out-of-the-box on most software examples provided as part of the SimpleLink™ SDK.

A 30-day evaluation or a 32 kB size-limited version is available through [iar.com](http://iar.com).

### SmartRF™ Studio

SmartRF™ Studio is a Windows® application that can be used to evaluate and configure SimpleLink™ Wireless MCUs from Texas Instruments. The application will help designers of RF systems to easily evaluate the radio at an early stage in the design process. It is especially useful for generation of configuration register values and for practical testing and debugging of the RF system. SmartRF Studio can be used either as a standalone application or together with applicable evaluation boards or debug probes for the RF device. Features of the SmartRF Studio include:

- Link tests - send and receive packets between nodes
- Antenna and radiation tests - set the radio in continuous wave TX and RX states
- Export radio configuration code for use with the TI SimpleLink™ SDK RF driver
- Custom GPIO configuration for signaling and control of external switches

### Sensor Controller Studio

Sensor Controller Studio is used to write, test and debug code for the Sensor Controller peripheral. The tool generates a Sensor Controller Interface driver, which is a set of C source files that are compiled into the System CPU application. These source files also contain the Sensor Controller binary image and allow the System CPU application to control and exchange data with the Sensor Controller. Features of the Sensor Controller Studio include:

- Ready-to-use examples for several common use cases
- Full toolchain with built-in compiler and assembler for programming in a C-like programming language
- Provides rapid development by using the integrated sensor controller task testing and debugging functionality, including visualization of sensor data and verification of algorithms

### UniFlash

UniFlash is a standalone tool used to program on-chip flash memory on TI MCUs. UniFlash has a GUI, command line, and scripting interface. UniFlash is available free of charge.

## 11.1.1 SimpleLink™ Microcontroller Platform

The SimpleLink™ microcontroller platform sets a new standard for developers with the broadest portfolio of wired and wireless Arm® MCUs (System-on-Chip) in a single software development environment. Delivering flexible hardware, software and tool options for your IoT applications. Invest once in the SimpleLink™ software development kit and use throughout your entire portfolio. Learn more on [ti.com/simplelink](https://ti.com/simplelink).

## 11.2 Documentation Support

To receive notification of documentation updates on data sheets, errata, application notes and similar, navigate to the device product folder on [ti.com/product/CC1354P10](https://ti.com/product/CC1354P10). In the upper right corner, click on *Alert me* to register and receive a weekly digest of any product information that has changed. For change details, review the revision history included in any revised document.

The current documentation that describes the MCU, related peripherals, and other technical collateral is listed as follows.

### TI Resource Explorer

[TI Resource Explorer](#) Software examples, libraries, executables, and documentation are available for your device and development board.

### Errata

#### [CC1354P10 Silicon Errata](#)

The silicon errata describes the known exceptions to the functional specifications for each silicon revision of the device and description on how to recognize a device revision.

## Application Reports

All application reports for the CC1354P10 device are found on the device product folder at: [ti.com/product/CC1354P10/technicaldocuments](https://ti.com/product/CC1354P10/technicaldocuments).

## Technical Reference Manual (TRM)

[CC13x4, CC26x4 SimpleLink™ Wireless MCU Technical Reference Manual](#)

The TRM provides a detailed description of all modules and peripherals available in the device family.

## 11.3 Support Resources

[TI E2E™ support forums](#) are an engineer's go-to source for fast, verified answers and design help — straight from the experts. Search existing answers or ask your own question to get the quick design help you need.

Linked content is provided "AS IS" by the respective contributors. They do not constitute TI specifications and do not necessarily reflect TI's views; see TI's [Terms of Use](#).

## 11.4 Trademarks

SimpleLink™, LaunchPad™, EnergyTrace™, Code Composer Studio™, and TI E2E™ are trademarks of Texas Instruments.

I-jet™ is a trademark of IAR Systems AB.

J-Link™ is a trademark of SEGGER Microcontroller Systeme GmbH.

Arm®, Cortex®, and TrustZone® are registered trademarks of Arm Limited (or its subsidiaries) in the US and/or elsewhere.

CoreMark® is a registered trademark of Embedded Microprocessor Benchmark Consortium Corporation.

Wi-SUN® is a registered trademark of Wi-SUN Alliance.

mioty® is a registered trademark of Fraunhofer-Gesellschaft.

Zigbee® is a registered trademark of Zigbee Alliance Inc.

Arm Thumb® are registered trademarks of Arm Limited (or its subsidiaries).

Wi-Fi® is a registered trademark of Wi-Fi Alliance.

is a registered trademark of Arm Limited.

Eclipse® is a registered trademark of Eclipse Foundation.

IAR Embedded Workbench® is a registered trademark of IAR Systems AB.

Windows® is a registered trademark of Microsoft Corporation.

All trademarks are the property of their respective owners.

## 11.5 Electrostatic Discharge Caution



This integrated circuit can be damaged by ESD. Texas Instruments recommends that all integrated circuits be handled with appropriate precautions. Failure to observe proper handling and installation procedures can cause damage.

ESD damage can range from subtle performance degradation to complete device failure. Precision integrated circuits may be more susceptible to damage because very small parametric changes could cause the device not to meet its published specifications.

## 11.6 Glossary

[TI Glossary](#) This glossary lists and explains terms, acronyms, and definitions.

## 12 Mechanical, Packaging, and Orderable Information

### 12.1 Packaging Information

The following pages include mechanical packaging and orderable information. This information is the most current data available for the designated devices. This data is subject to change without notice and revision of this document. For browser-based versions of this data sheet, refer to the left-hand navigation.



**PACKAGING INFORMATION**

Orderable Device	Status (1)	Package Type	Package Drawing	Pins	Package Qty	Eco Plan (2)	Lead finish/ Ball material (6)	MSL Peak Temp (3)	Op Temp (°C)	Device Marking (4/5)	Samples
CC1354P106T0RGZR	ACTIVE	VQFN	RGZ	48	2500	RoHS & Green	NIPDAU	Level-3-260C-168 HR	-40 to 105	CC1354 P106	<a href="#">Samples</a>
CC1354P106T0RSKR	ACTIVE	VQFN	RSK	64	2000	RoHS & Green	NIPDAU	Level-3-260C-168 HR	-40 to 105	CC1354 P106	<a href="#">Samples</a>
XCC1354P106T0RGZ	ACTIVE	VQFN	RGZ	48	260	TBD	Call TI	Call TI	-40 to 105		<a href="#">Samples</a>
XCC1354P106T0RSK	ACTIVE	VQFN	RSK	64	4000	TBD	Call TI	Call TI	-40 to 105		<a href="#">Samples</a>

(1) The marketing status values are defined as follows:

**ACTIVE:** Product device recommended for new designs.

**LIFEBUY:** TI has announced that the device will be discontinued, and a lifetime-buy period is in effect.

**NRND:** Not recommended for new designs. Device is in production to support existing customers, but TI does not recommend using this part in a new design.

**PREVIEW:** Device has been announced but is not in production. Samples may or may not be available.

**OBSOLETE:** TI has discontinued the production of the device.

(2) **RoHS:** TI defines "RoHS" to mean semiconductor products that are compliant with the current EU RoHS requirements for all 10 RoHS substances, including the requirement that RoHS substance do not exceed 0.1% by weight in homogeneous materials. Where designed to be soldered at high temperatures, "RoHS" products are suitable for use in specified lead-free processes. TI may reference these types of products as "Pb-Free".

**RoHS Exempt:** TI defines "RoHS Exempt" to mean products that contain lead but are compliant with EU RoHS pursuant to a specific EU RoHS exemption.

**Green:** TI defines "Green" to mean the content of Chlorine (Cl) and Bromine (Br) based flame retardants meet JS709B low halogen requirements of <=1000ppm threshold. Antimony trioxide based flame retardants must also meet the <=1000ppm threshold requirement.

(3) MSL, Peak Temp. - The Moisture Sensitivity Level rating according to the JEDEC industry standard classifications, and peak solder temperature.

(4) There may be additional marking, which relates to the logo, the lot trace code information, or the environmental category on the device.

(5) Multiple Device Markings will be inside parentheses. Only one Device Marking contained in parentheses and separated by a "~" will appear on a device. If a line is indented then it is a continuation of the previous line and the two combined represent the entire Device Marking for that device.

(6) Lead finish/Ball material - Orderable Devices may have multiple material finish options. Finish options are separated by a vertical ruled line. Lead finish/Ball material values may wrap to two lines if the finish value exceeds the maximum column width.

**Important Information and Disclaimer:**The information provided on this page represents TI's knowledge and belief as of the date that it is provided. TI bases its knowledge and belief on information provided by third parties, and makes no representation or warranty as to the accuracy of such information. Efforts are underway to better integrate information from third parties. TI has taken and

continues to take reasonable steps to provide representative and accurate information but may not have conducted destructive testing or chemical analysis on incoming materials and chemicals. TI and TI suppliers consider certain information to be proprietary, and thus CAS numbers and other limited information may not be available for release.

In no event shall TI's liability arising out of such information exceed the total purchase price of the TI part(s) at issue in this document sold by TI to Customer on an annual basis.

## GENERIC PACKAGE VIEW

**RGZ 48**

**VQFN - 1 mm max height**

7 x 7, 0.5 mm pitch

PLASTIC QUADFLAT PACK- NO LEAD



Images above are just a representation of the package family, actual package may vary.  
Refer to the product data sheet for package details.

4224671/A



NOTES:

1. All linear dimensions are in millimeters. Any dimensions in parenthesis are for reference only. Dimensioning and tolerancing per ASME Y14.5M.
2. This drawing is subject to change without notice.
3. The package thermal pad must be soldered to the printed circuit board for optimal thermal and mechanical performance.



NOTES: (continued)

4. This package is designed to be soldered to a thermal pad on the board. For more information, see Texas Instruments literature number SLUA271 ([www.ti.com/lit/slua271](http://www.ti.com/lit/slua271)).
5. Vias are optional depending on application, refer to device data sheet. If any vias are implemented, refer to their locations shown on this view. It is recommended that vias under paste be filled, plugged or tented.

# EXAMPLE STENCIL DESIGN

RGZ0048A

VQFN - 1 mm max height

PLASTIC QUADFLAT PACK- NO LEAD



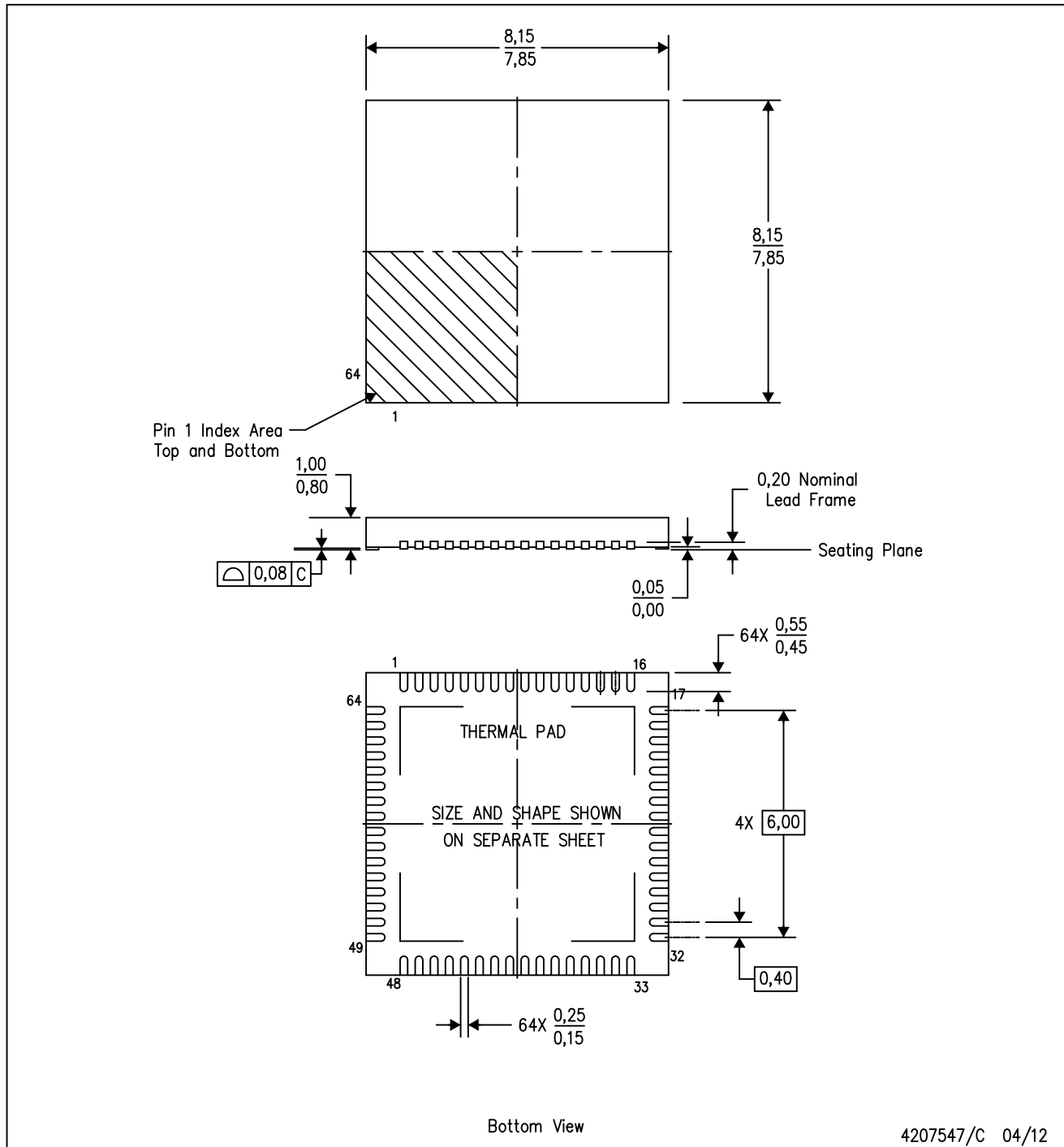
NOTES: (continued)

6. Laser cutting apertures with trapezoidal walls and rounded corners may offer better paste release. IPC-7525 may have alternate design recommendations.

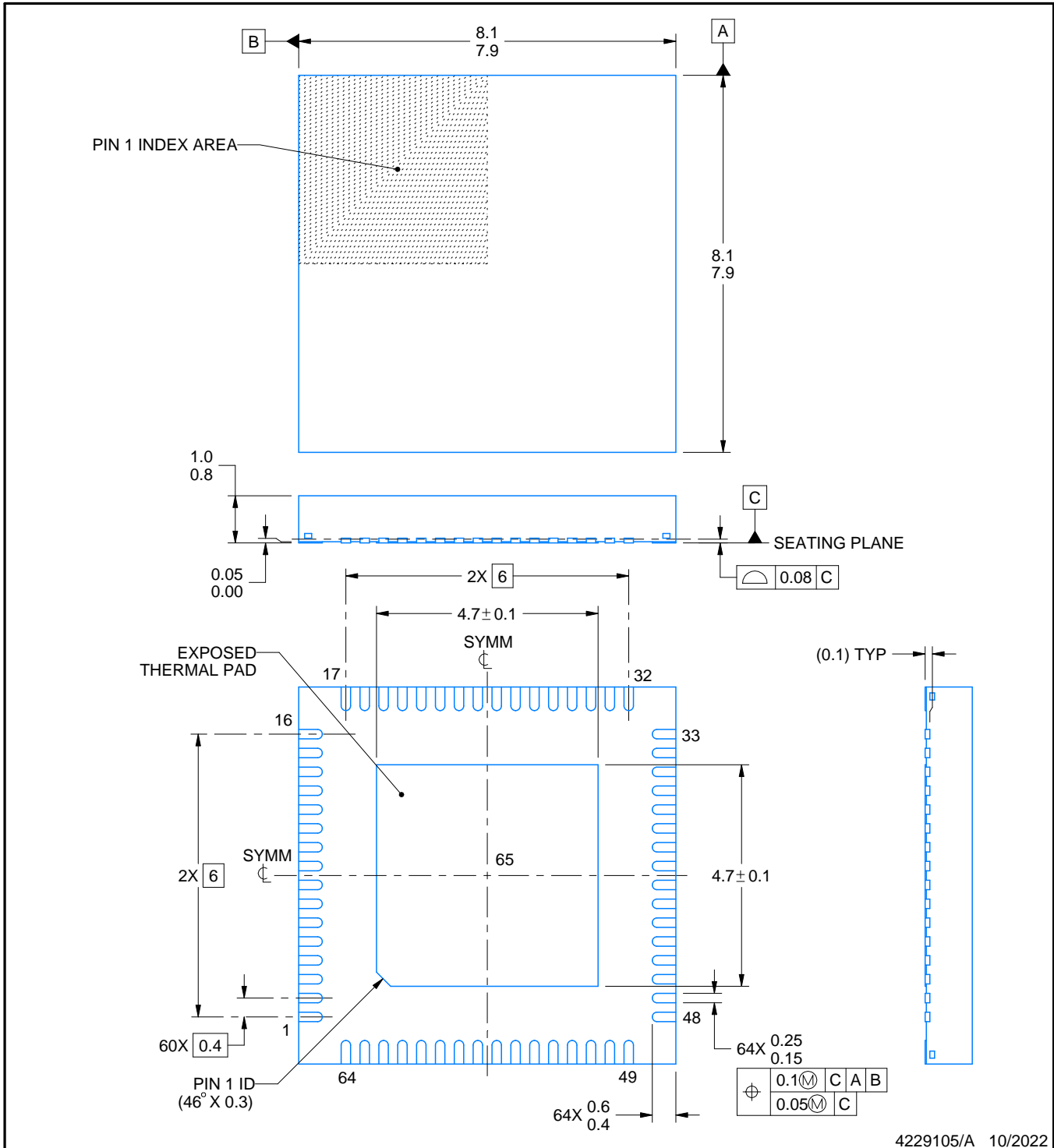
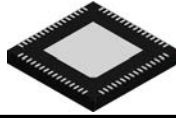
# MECHANICAL DATA

RSK (S-PVQFN-N64)

PLASTIC QUAD FLATPACK NO-LEAD



- NOTES:
- A. All linear dimensions are in millimeters. Dimensioning and tolerancing per ASME Y14.5-1994.
  - B. This drawing is subject to change without notice.
  - C. QFN (Quad Flatpack No-Lead) Package configuration.
  - D. The package thermal pad must be soldered to the board for thermal and mechanical performance.
  - E. See the additional figure in the Product Data Sheet for details regarding the exposed thermal pad features and dimensions.



4229105/A 10/2022

NOTES:

1. All linear dimensions are in millimeters. Any dimensions in parenthesis are for reference only. Dimensioning and tolerancing per ASME Y14.5M.
2. This drawing is subject to change without notice.
3. The package thermal pad must be soldered to the printed circuit board for thermal and mechanical performance.

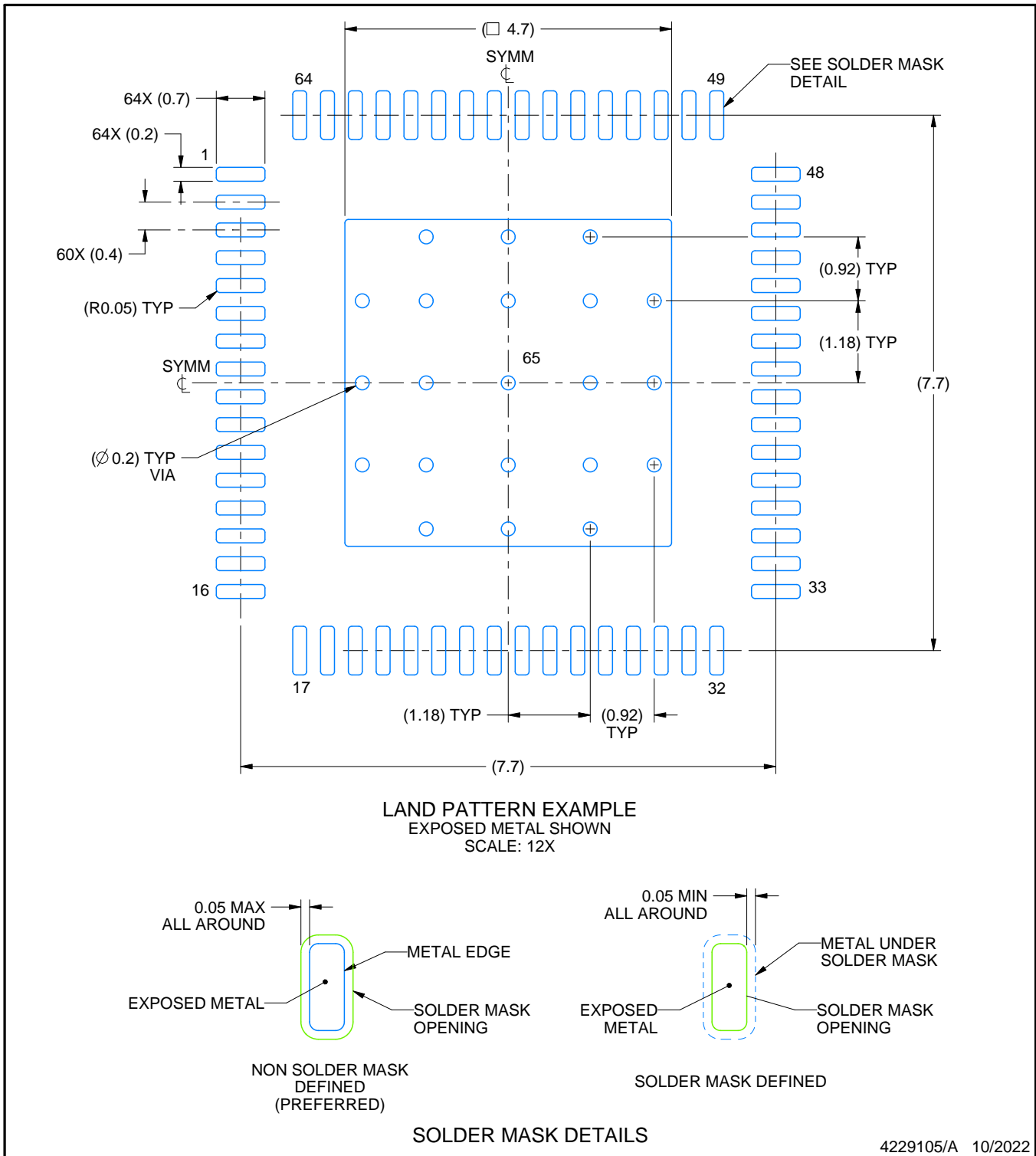


# EXAMPLE BOARD LAYOUT

RSK0064D

VQFN - 1 mm max height

PLASTIC QUAD FLATPACK - NO LEAD



NOTES: (continued)

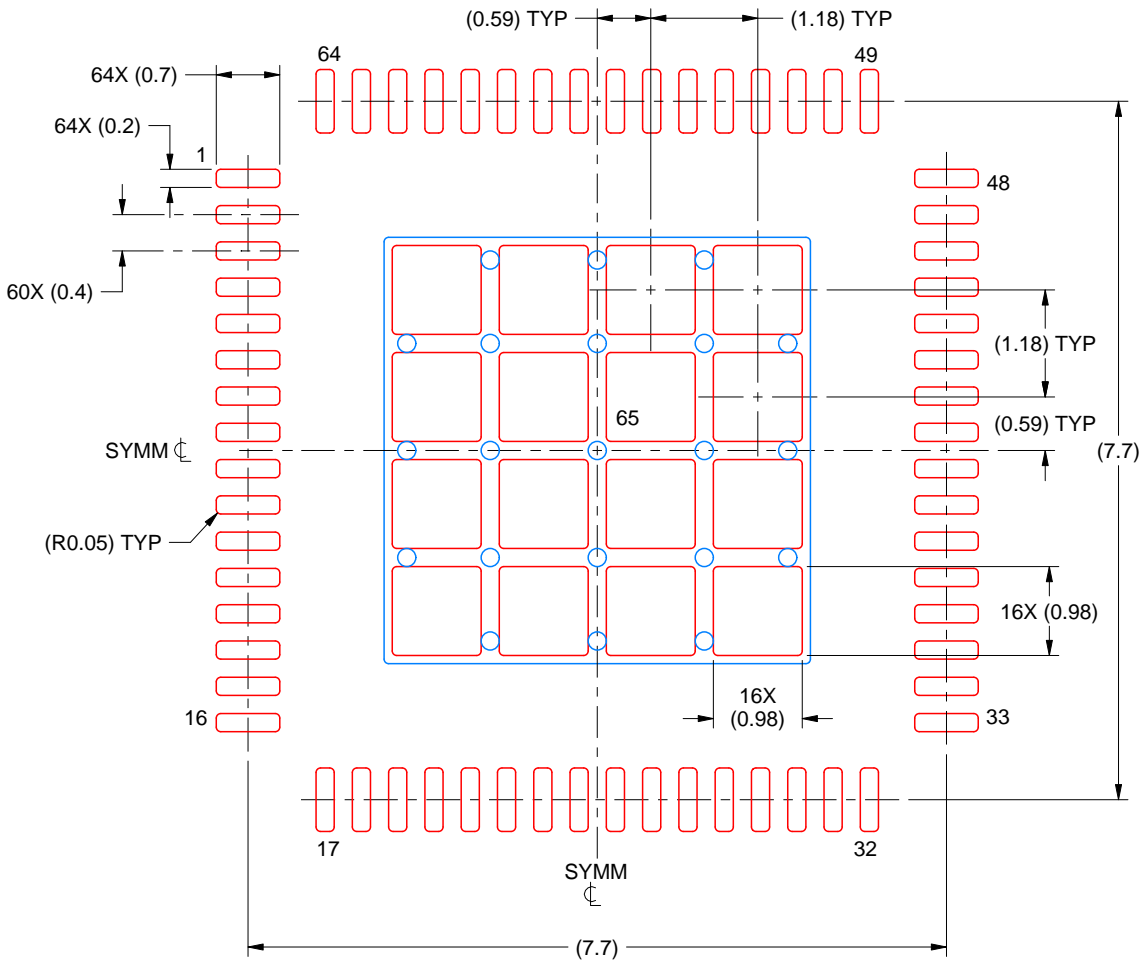
4. This package is designed to be soldered to a thermal pad on the board. For more information, see Texas Instruments literature number SLUA271 ([www.ti.com/lit/sluea271](http://www.ti.com/lit/sluea271)).
5. Vias are optional depending on application, refer to device data sheet. If any vias are implemented, refer to their locations shown on this view. It is recommended that vias under paste be filled, plugged or tented.

# EXAMPLE STENCIL DESIGN

RSK0064D

VQFN - 1 mm max height

PLASTIC QUAD FLATPACK - NO LEAD



SOLDER PASTE EXAMPLE  
 BASED ON 0.100 MM THICK STENCIL  
 SCALE: 12X

EXPOSED PAD 65  
 70% PRINTED SOLDER COVERAGE BY AREA UNDER PACKAGE

4229105/A 10/2022

NOTES: (continued)

6. Laser cutting apertures with trapezoidal walls and rounded corners may offer better paste release. IPC-7525 may have alternate design recommendations.

## IMPORTANT NOTICE AND DISCLAIMER

TI PROVIDES TECHNICAL AND RELIABILITY DATA (INCLUDING DATA SHEETS), DESIGN RESOURCES (INCLUDING REFERENCE DESIGNS), APPLICATION OR OTHER DESIGN ADVICE, WEB TOOLS, SAFETY INFORMATION, AND OTHER RESOURCES "AS IS" AND WITH ALL FAULTS, AND DISCLAIMS ALL WARRANTIES, EXPRESS AND IMPLIED, INCLUDING WITHOUT LIMITATION ANY IMPLIED WARRANTIES OF MERCHANTABILITY, FITNESS FOR A PARTICULAR PURPOSE OR NON-INFRINGEMENT OF THIRD PARTY INTELLECTUAL PROPERTY RIGHTS.

These resources are intended for skilled developers designing with TI products. You are solely responsible for (1) selecting the appropriate TI products for your application, (2) designing, validating and testing your application, and (3) ensuring your application meets applicable standards, and any other safety, security, regulatory or other requirements.

These resources are subject to change without notice. TI grants you permission to use these resources only for development of an application that uses the TI products described in the resource. Other reproduction and display of these resources is prohibited. No license is granted to any other TI intellectual property right or to any third party intellectual property right. TI disclaims responsibility for, and you will fully indemnify TI and its representatives against, any claims, damages, costs, losses, and liabilities arising out of your use of these resources.

TI's products are provided subject to [TI's Terms of Sale](#) or other applicable terms available either on [ti.com](https://www.ti.com) or provided in conjunction with such TI products. TI's provision of these resources does not expand or otherwise alter TI's applicable warranties or warranty disclaimers for TI products.

TI objects to and rejects any additional or different terms you may have proposed.

Mailing Address: Texas Instruments, Post Office Box 655303, Dallas, Texas 75265  
Copyright © 2023, Texas Instruments Incorporated