

CD4016B Types CMOS Quad Bilateral Switch

1 Features

- 20V digital or $\pm 10V$ peak-to-peak switching
- 280 Ω typical on-state resistance for 15V operation
- Switch on-state resistance matched to within 10 Ω typ over 15V signal-input range
- High on/off output-voltage ratio: 65dB typ at $f_{is} = 10\text{kHz}$, $R_L = 10\text{k}\Omega$
- High degree of linearity: <0.5% distortion typ at $f_{is} = 1\text{kHz}$, $V_{is} = 5V_{p-p}$, $V_{DD} - V_{SS} \square 10V$, $R_L = 10\text{k}\Omega$
- Extremely low off-state switch leakage resulting in very low offset current and high effective off-state resistance: 100pA typ. at $V_{DD} - V_{SS} = 18V$, $T_A = 25^\circ\text{C}$
- Extremely high control input impedance (control circuit isolated from signal circuit): $10^{12}\Omega$ typ.
- Low crosstalk between switches: -50dB typ at $f_{is} = 0.9\text{MHz}$, $R_L = 1\text{k}\Omega$
- Matched control-input to signal-output capacitance: Reduces output signal transients
- Frequency response, switch on = 40MHz (typical)
- 100% tested for quiescent current at 20V
- Maximum control input current of 1 μA at 18V over full package temperature range; 100nA at 18V at 25 $^\circ\text{C}$
- 5V, 10V, and 15V parametric ratings

2 Applications

- Analog signal switching/multiplexing signal gating
- Modulator squelch control
- Demodulator chopper
- Commutating switch
- Digital signal switching/multiplexing
- CMOS logic implementation
- Analog-to-digital and digital-to-analog conversion
- Digital control of frequency, impedance, phase, and analog-signal gain

3 Description

For transmission or multiplexing of analog or digital signals high-voltage types (20V rating).

CD4016B *B* Series types are quad bilateral switches intended for the transmission or multiplexing of analog or digital signals. Each of the four independent bilateral switches has a single control signal input which simultaneously biases both the p and n device in a given switch on or off.

The CD4016B *B* Series types are supplied in 14-lead hermetic dual-in-line ceramic packages (F3A suffix), 14-lead dual-in-line plastic packages (E suffix), 14-lead small-outline packages (M, MT, M96, and NSR suffixes), and 14-lead thin shrink small-outline packages (PW and PWR suffixes).

Package Information

PART NUMBER	PACKAGE ⁽¹⁾	PACKAGE SIZE ⁽²⁾
CD4016B	N (PDIP, 14)	19.3mm \times 9.4mm
	D (SOIC, 14)	8.65mm \times 6mm

(1) For more information, see [Section 8](#).

(2) The package size (length \times width) is a nominal value and includes pins, where applicable.



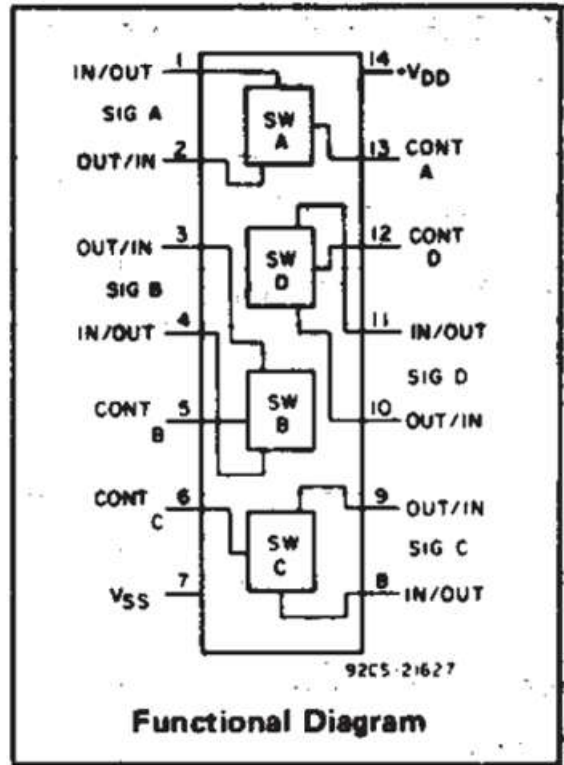
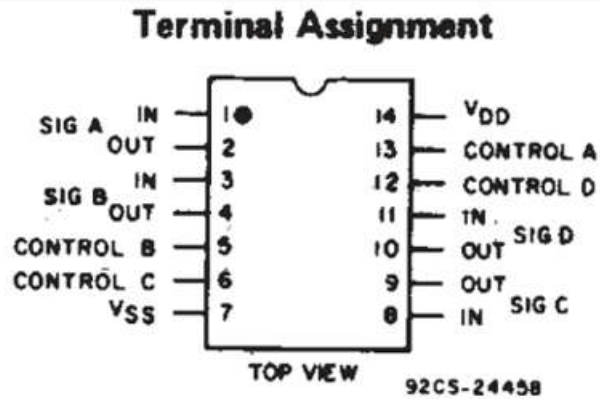

Schematic Diagram - 1 of 4 Identical Sections

Table of Contents

1 Features	1	4.5 Electrical Characteristics.....	5
2 Applications	1	4.6 Electrical Characteristics.....	9
3 Description	1	4.7 Typical Characteristics.....	10
4 Specifications	4	5 Parameter Measurement Information	11
4.1 Absolute Maximum Ratings.....	4	6 Device and Documentation Support	13
4.2 ESD Ratings.....	4	6.1 Documentation Support.....	13
4.3 Recommended Operating Conditions.....	4	7 Revision History	13
4.4 Thermal Information.....	5	8 Mechanical, Packaging, and Orderable Information ..	13

4 Specifications

4.1 Absolute Maximum Ratings

over operating free-air temperature range (unless otherwise noted)⁽¹⁾ ⁽²⁾

		MIN	MAX	UNIT
$V_{DD} - V_{SS}$	Supply voltage		20	V
V_{DD}		-0.5	20	V
V_{SS}		-20	0.5	V
I_{SEL} or I_{EN}	Logic control input pin current (\overline{EN} , Ax, SELx)	-30	30	mA
V_S or V_D	Source or drain voltage (Sx, D)	$V_{SS}-0.5$	$V_{DD}+0.5$	V
I_S or I_D (CONT)	Source or drain continuous current (Sx, D)	-20	20	mA
T_J	Junction temperature		150	°C
T_{stg}	Storage temperature	-65	150	°C

- (1) Stresses beyond those listed under *Absolute Maximum Rating* may cause permanent damage to the device. These are stress ratings only, which do not imply functional operation of the device at these or any other conditions beyond those indicated under *Recommended Operating Condition*. Exposure to absolute-maximum-rated conditions for extended periods may affect device reliability.
- (2) All voltages are with respect to ground, unless otherwise specified.

4.2 ESD Ratings

			VALUE	UNIT
$V_{(ESD)}$	Electrostatic discharge	Human body model (HBM), per ANSI/ESDA/ JEDEC JS-001, all pins ⁽¹⁾	±500	V
		Charged device model (CDM), per JEDEC specification JESD22-C101, all pins ⁽²⁾	±1500	

- (1) JEDEC document JEP155 states that 500-V HBM allows safe manufacturing with a standard ESD control process.
- (2) JEDEC document JEP157 states that 250-V CDM allows safe manufacturing with a standard ESD control process.

4.3 Recommended Operating Conditions

over operating free-air temperature range (unless otherwise noted)

		MIN	NOM	MAX	UNIT
$V_{DD} - V_{SS}$ ⁽¹⁾	Power supply voltage differential	3		18	V
V_{DD}	Positive power supply voltage	3		18	V
V_S or V_D	Signal path input/output voltage (source or drain pin) (Sx, D)	V_{SS}		V_{DD}	V
V_{SEL} or V_{EN}	Address or enable pin voltage	0		V_{DD}	V
I_S or I_D (CONT)	Source or drain continuous current (Sx, D)	-10		10	mA
T_A	Ambient temperature	-55		125	°C

- (1) V_{DD} and V_{SS} can be any value as long as $3V \leq (V_{DD} - V_{SS}) \leq 24V$, and the minimum V_{DD} is met.

4.4 Thermal Information

THERMAL METRIC ⁽¹⁾		CD4016		UNIT
		N (PDIP)	D (SOIC)	
		14 PINS	14 PINS	
$R_{\theta JA}$	Junction-to-ambient thermal resistance	93.7	109.7	°C/W
$R_{\theta JC(top)}$	Junction-to-case (top) thermal resistance	72.5	69.4	°C/W
$R_{\theta JB}$	Junction-to-board thermal resistance	68.0	67.9	°C/W
Ψ_{JT}	Junction-to-top characterization parameter	50.3	25.8	°C/W
Ψ_{JB}	Junction-to-board characterization parameter	67.3	67.1	°C/W

(1) For more information about traditional and new thermal metrics, see the [Semiconductor and IC Package Thermal Metrics](#) application report.

4.5 Electrical Characteristics

Over operating free-air temperature range, $V_{SUPPLY} = \pm 5V$, and $R_L = 100\Omega$, (unless otherwise noted)⁽¹⁾

PARAMETER		TEST CONDITIONS			MIN	TYP	MAX	UNIT	
SIGNAL INPUTS (V_{IS}) AND OUTPUTS (V_{OS})									
I_{DD}	Quiescent Device Current	$V_{IS} = 0$ to 5V $V_{DD} = 5V$	$T_A = -55^\circ C$					5	μA
			$T_A = -40^\circ C$					5	
			$T_A = 25^\circ C$			4.5		6	
			$T_A = 85^\circ C$					7.5	
			$T_A = 125^\circ C$					7.5	
		$V_{IS} = 0$ to 10V $V_{DD} = 10V$	$T_A = -55^\circ C$					6	
			$T_A = -40^\circ C$					6	
			$T_A = 25^\circ C$			5		7	
			$T_A = 85^\circ C$					15	
			$T_A = 125^\circ C$					15	
		$V_{IS} = 0$ to 15V $V_{DD} = 15V$	$T_A = -55^\circ C$					7	
			$T_A = -40^\circ C$					7.2	
			$T_A = 25^\circ C$			6		8	
			$T_A = 85^\circ C$					30	
			$T_A = 125^\circ C$					30	
		$V_{IS} = 0$ to 20V $V_{DD} = 20V$	$T_A = -55^\circ C$					8.5	
			$T_A = -40^\circ C$					8.5	
			$T_A = 25^\circ C$			6.5		9	
			$T_A = 85^\circ C$					150	
			$T_A = 125^\circ C$					150	

4.5 Electrical Characteristics (continued)

Over operating free-air temperature range, $V_{\text{SUPPLY}} = \pm 5\text{V}$, and $R_L = 100\Omega$, (unless otherwise noted)⁽¹⁾

PARAMETER		TEST CONDITIONS			MIN	TYP	MAX	UNIT
r_{ON}	ON Resistance r_{ON} Max	to ($V_{\text{DD}}+V_{\text{SS}}$)/2, $V_C = V_{\text{DD}}$, $R_L = 10\text{k}\Omega$	$V_{\text{DD}} = 10\text{V}$ $V_{\text{is}} = V_{\text{SS}}$ or V_{DD}	$T_A = -55^\circ\text{C}$			600	Ω
				$T_A = -40^\circ\text{C}$			610	
				$T_A = 25^\circ\text{C}$		250	660	
				$T_A = 85^\circ\text{C}$			840	
				$T_A = 125^\circ\text{C}$			960	
			$V_{\text{DD}} = 10\text{V}$ $V_{\text{is}} = 4.75$ to 5.75V	$T_A = -55^\circ\text{C}$			1870	
				$T_A = -40^\circ\text{C}$			1900	
				$T_A = 25^\circ\text{C}$			2000	
				$T_A = 85^\circ\text{C}$			2380	
				$T_A = 125^\circ\text{C}$			2600	
			$V_{\text{DD}} = 15\text{V}$ $V_{\text{is}} = V_{\text{SS}}$ or V_{DD}	$T_A = -55^\circ\text{C}$			360	
				$T_A = -40^\circ\text{C}$			370	
				$T_A = 25^\circ\text{C}$		200	400	
				$T_A = 85^\circ\text{C}$			520	
				$T_A = 125^\circ\text{C}$			600	
			$V_{\text{DD}} = 15\text{V}$ $V_{\text{is}} = 7.25$ to 7.75V	$T_A = -55^\circ\text{C}$			775	
$T_A = -40^\circ\text{C}$				790				
$T_A = 25^\circ\text{C}$				850				
$T_A = 85^\circ\text{C}$				1080				
$T_A = 125^\circ\text{C}$				1230				
r_{ON}	ON Resistance r_{ON} Max	to ($V_{\text{DD}}+V_{\text{SS}}$)/2, $V_C = V_{\text{DD}}$, $R_L = 10\text{k}\Omega$	$V_{\text{DD}} = 5\text{V}$ $V_{\text{SS}} = 0\text{V}$	$T_A = 25^\circ\text{C}$		580	7000	Ω
			$V_{\text{DD}} = 7.5\text{V}$ $V_{\text{SS}} = -7.5\text{V}$	$T_A = 25^\circ\text{C}$		200	280	
			$V_{\text{DD}} = 5\text{V}$ $V_{\text{SS}} = -5\text{V}$	$T_A = 25^\circ\text{C}$		250	580	
			$V_{\text{DD}} = 2.5\text{V}$ $V_{\text{SS}} = -2.5\text{V}$	$T_A = 25^\circ\text{C}$		520	30000	
ΔR_{ON}	On-state resistance difference between any two switches	$R_L = 10\text{k}\Omega$, $V_C = V_{\text{DD}}$	$V_{\text{DD}} = 5\text{V}$			15	Ω	
			$V_{\text{DD}} = 10\text{V}$			10		
			$V_{\text{DD}} = 15\text{V}$			5		
THD	Total Harmonic Distortion	$V_C = V_{\text{DD}} = 5\text{V}$, $V_{\text{SS}} = -5\text{V}$, $V_{\text{is(p-p)}} = 5\text{V}$ (sine wave centered on 0V), $R_L = 10\text{k}\Omega$, $f_{\text{is}} = 1\text{kHz}$ sine wave				0.4	%	
BW	-3-dB cutoff frequency (switch on)	$V_C = V_{\text{DD}} = 5\text{V}$, $V_{\text{SS}} = -5\text{V}$, $V_{\text{is(p-p)}} = 5\text{V}$ (sine wave centered on 0V), $R_L = 1\text{k}\Omega$				40	MHz	
OISO	-50-dB feedthrough frequency (switch off)	$V_C = V_{\text{DD}} = 5\text{V}$, $V_{\text{SS}} = -5\text{V}$, $V_{\text{is(p-p)}} = 5\text{V}$ (sine wave centered on 0V), $R_L = 1\text{k}\Omega$				1.25	MHz	
I_{is}	Input/Output Leakage Current (switch off)	$V_{\text{DD}} = 18\text{V}$ $V_C = 0\text{V}$ $V_{\text{is}} = 18\text{V}$, $V_{\text{os}} = 0\text{V}$ $V_{\text{is}} = 0\text{V}$, $V_{\text{os}} = 18\text{V}$	$T_A = -55^\circ\text{C}$		-0.1	0.1	μA	
			$T_A = -40^\circ\text{C}$		-0.1	0.1		
			$T_A = 25^\circ\text{C}$		0.000 1	0.1		
			$T_A = 85^\circ\text{C}$		-1	1		
			$T_A = 125^\circ\text{C}$		-1	1		
XTALK	-50-dB crosstalk frequency	$V_C = V_{\text{DD}} = 5\text{V}$, $V_{\text{SS}} = -5\text{V}$, $V_{\text{is(p-p)}} = 5\text{V}$ (sine wave centered on 0V), $R_L = 1\text{k}\Omega$				0.9	MHz	

4.5 Electrical Characteristics (continued)

Over operating free-air temperature range, $V_{SUPPLY} = \pm 5V$, and $R_L = 100\Omega$, (unless otherwise noted)⁽¹⁾

PARAMETER		TEST CONDITIONS			MIN	TYP	MAX	UNIT
t_{pd}	Propagation delay	$V_C = V_{DD}, V_{SS} = GND$ $V_{IS} = \text{Square Wave 0 to } V_{DD}, C_L = 50pF, R_L = 200k\Omega$	$V_{DD} = 5V$		40	100	ns	
			$V_{DD} = 10V$		20	40		
			$V_{DD} = 15V$		15	30		
C_{IS}	Input capacitance	$V_{DD} = 5V, V_C = V_{SS} = -5V$				4		pF
C_{OS}	Output capacitance	$V_{DD} = 5V, V_C = V_{SS} = -5V$				4		pF
C_{IOS}	Feed through	$V_{DD} = 5V, V_C = V_{SS} = -5V$				0.2		pF
V_{ILC}	Control input, low voltage (max)	$ I_{is} < 10\mu A,$ $V_{is} = V_{SS}, V_{OS} = V_{DD},$ and $V_{is} = V_{DD}, V_{OS} = V_{SS}$	$V_{DD} = 5V$ $V_{DD} = 10V$ $V_{DD} = 15V$	$T_A = -55^\circ C$		0.9	V	
				$T_A = -40^\circ C$		0.9		
				$T_A = 25^\circ C$		0.7		
				$T_A = 85^\circ C$		0.4		
				$T_A = 125^\circ C$		0.4		
V_{IHC}	Control input, high voltage	See Figure 10	$V_{DD} = 5V$		3.5		V	
			$V_{DD} = 10V$		7		V	
			$V_{DD} = 15V$		11		V	
I_{IH}	Input High Leakage		$V_{DD} = 18V$		0.5	1	μA	
I_{IL}	Input Low Leakage		$V_{DD} = 18V$		-1	-0.1	μA	
	Crosstalk (control input to signal output)	$V_C = 10V$ (square wave), $t_r, t_f = 20ns, R_L = 10k\Omega, V_{DD} = 10V$	$V_{DD} = 10V$			50		mV
	Turn-on propagation delay	$t_r, t_f = 20ns$ $C_L = 50pF,$ $R_L = 1k\Omega$	$V_{DD} = 5V$		35	70	ns	
$V_{DD} = 10V$				20	40	ns		
$V_{DD} = 15V$				15	30	ns		
	Maximum control input repetition rate	$V_{IN} = V_{DD}, C_L = 50pF, R_L = 1k\Omega$ $V_C = 10V$ (square wave centered on 5V), $t_r, t_f = 20ns, V_{OS} = 1/2V_{OS}$ at 1kHz	$V_{DD} = 10V$		10		MHz	
C_{IN}	Input Capacitance				5	7.5	pF	

4.5 Electrical Characteristics (continued)

Over operating free-air temperature range, $V_{\text{SUPPLY}} = \pm 5\text{V}$, and $R_L = 100\Omega$, (unless otherwise noted)⁽¹⁾

PARAMETER		TEST CONDITIONS			MIN	TYP	MAX	UNIT	
I_{IS}	Switch input current	$V_{\text{DD}} = 5\text{V}$ $V_{\text{IS}} = 0\text{V}$	$T_A = -55^\circ\text{C}$				0.25	mA	
			$T_A = -40^\circ\text{C}$				0.2		
			$T_A = 25^\circ\text{C}$				0.2		
			$T_A = 85^\circ\text{C}$				0.12		
			$T_A = 125^\circ\text{C}$				0.14		
		$V_{\text{DD}} = 5\text{V}$ $V_{\text{IS}} = 5\text{V}$	$T_A = -55^\circ\text{C}$					-0.25	mA
			$T_A = -40^\circ\text{C}$					-0.2	
			$T_A = 25^\circ\text{C}$					-0.2	
			$T_A = 85^\circ\text{C}$					-0.12	
			$T_A = 125^\circ\text{C}$					-0.14	
		$V_{\text{DD}} = 10\text{V}$ $V_{\text{IS}} = 0\text{V}$	$T_A = -55^\circ\text{C}$					0.62	mA
			$T_A = -40^\circ\text{C}$					0.5	
			$T_A = 25^\circ\text{C}$					0.5	
			$T_A = 85^\circ\text{C}$					0.3	
			$T_A = 125^\circ\text{C}$					0.35	
		$V_{\text{DD}} = 10\text{V}$ $V_{\text{IS}} = 10\text{V}$	$T_A = -55^\circ\text{C}$					-0.62	mA
			$T_A = -40^\circ\text{C}$					-0.5	
			$T_A = 25^\circ\text{C}$					-0.5	
			$T_A = 85^\circ\text{C}$					-0.3	
			$T_A = 125^\circ\text{C}$					-0.35	
$V_{\text{DD}} = 15\text{V}$ $V_{\text{IS}} = 0\text{V}$	$T_A = -55^\circ\text{C}$					1.8	mA		
	$T_A = -40^\circ\text{C}$					1.4			
	$T_A = 25^\circ\text{C}$					1.5			
	$T_A = 85^\circ\text{C}$					1			
	$T_A = 125^\circ\text{C}$					1.1			
$V_{\text{DD}} = 15\text{V}$ $V_{\text{IS}} = 15\text{V}$	$T_A = -55^\circ\text{C}$					-1.8	mA		
	$T_A = -40^\circ\text{C}$					-1.4			
	$T_A = 25^\circ\text{C}$					-1.5			
	$T_A = 85^\circ\text{C}$					-1			
	$T_A = 125^\circ\text{C}$					-1.1			
V_{OS}	Switch output voltage	$V_{\text{DD}} = 5\text{V}$ $V_{\text{IS}} = 0\text{V}$					0.4	V	
		$V_{\text{DD}} = 5\text{V}$ $V_{\text{IS}} = 5\text{V}$				4.6		V	
		$V_{\text{DD}} = 10\text{V}$ $V_{\text{IS}} = 0\text{V}$					0.5	V	
		$V_{\text{DD}} = 10\text{V}$ $V_{\text{IS}} = 10\text{V}$				9.5		V	
		$V_{\text{DD}} = 15\text{V}$ $V_{\text{IS}} = 0\text{V}$					1.5	V	
		$V_{\text{DD}} = 15\text{V}$ $V_{\text{IS}} = 15\text{V}$				13.5		V	

(1) Peak-to-Peak voltage symmetrical about $(V_{\text{DD}} - V_{\text{EE}}) / 2$.

4.6 Electrical Characteristics

CHARACTERISTIC	TEST CONDITIONS			LIMITS AT INDICATED TEMPERATURES (°C)						UNITS	
		V_{IN} (V)	V_{DD} (V)					+25			
				-55	-40	+85	+125	TYP	MAX		
Quiescent Device Current, I_{DD}		0,5	5	025	0,25	7,5	7,5	0,01	0,25	μA	
		0,10	10	0,5	0,5	15	15	0,01	0,5		
		0,15	15	1	1	30	30	0,01	1		
		0,20	20	5	5	150	150	0,02	5		
Signal Inputs (V_{is}) and Output (V_{os})											
On-State Resistance, r_{on} MAX	$V_C = V_{DD}$ $R_L = 10k\Omega$ Returned to $\frac{V_{DD} - V_{SS}}{2}$	$V_{is} = V_{DD}$ or V_{SS}		10	600	610	840	960	-	660	Ω
		$V_{is} = 4.75$ to $5.75V$		10	1870	1900	2380	2600	-	2000	
		$V_{is} = V_{DD}$ or V_{SS}		15	360	370	520	600	-	400	
		$V_{is} = 7.25$ to $7.75V$		15	775	790	1080	1230	-	850	
Δ On-State Resistance Between Any 2 Switches, Δr_{on}	$R_L = 10k\Omega$, $V_C = V_{DD}$			5	-	-	-	-	15	-	Ω
				10	-	-	-	-	10	-	
				15	-	-	-	-	5	-	
Total Harmonic Distortion, THD	$V_C = V_{DD} = 5V$, $V_{SS} = -5V$, $V_{is(p-p)} = 5V$ (Sine wave centered on 0V) $R_L = 10k\Omega$, $f_{is} = 1kHz$ sine wave			-	-	-	-	-	0.4	-	%
-3dB Cutoff Frequency (Switch on)	$V_C = V_{DD} = 5V$, $V_{SS} = -5V$, $V_{is(p-p)}$ (Sine wave centered on 0V) $R_L = 1k\Omega$,			-	-	-	-	-	40	-	MHz
-50dB Feed-through Frequency (Switch off)	$V_C = V_{SS} = -5V$, $V_{is(p-p)} = 5V$ (Sine wave centered on 0V) $R_L = 1k\Omega$			-	-	-	-	-	1.25	-	MHz
Input/Output Leakage Current (Switch off) I_{is} MAX	$V_C = 0V$ $V_{is} = 18V$, $V_{os} = 0V$; $V_{is} = 0V$, $V_{os} = 18V$	18		± 0.1	± 0.1	± 1	± 1	10^{-4}	± 0.1	μA	
-50dB Crosstalk Frequency	$V_C(A) = V_{DD} = +5V$, $V_C(B) = V_{SS} = -5V$, $V_{is(A)} = 5V_{p-p}$, 50 Ω source $R_L = 1k\Omega$			-	-	-	-	-	0.9	-	MHz
Propagation Delay (Signal Input to Signal Output) t_{pd}	$R_L = 200k\Omega$ $V_C = V_{DD}$, $V_{SS} = GND$, $C_L = 50pF$ $V_{is} =$ Square Wave 0 to V_{DD} $t_r, t_f = 20ns$	5		-	-	-	-	-	40	100	ns
		10		-	-	-	-	-	20	40	
		15		-	-	-	-	-	15	30	
Capacitance: Input, C_{is} Output, C_{os} Feed-through, C_{ios}	$V_{DD} = +5V$ $V_C = V_{SS} = -5V$			-	-	-	-	-	4	-	pF
				-	-	-	-	-	4	-	
				-	-	-	-	-	0.2	-	
Control (V_C)											
Control Input Low Voltage, $V_{ILC}(MAX)$	$ I_{is} < 10 \mu A$ $V_{is} = V_{SS}$, $V_{os} = V_{DD}$ and $V_{is} = V_{DD}$, $V_{os} = V_{SS}$	5, 10, 15		0.9	0.9	0.4	0.4	-	0.7	V	
Control Input High Voltage, V_{IHC}	See Figure 4-8	5		3.5 (Min.)						V	
		10		7 (Min.)							
		15		11 (Min.)							
Input Current, I_{IN} (MAX)	Input Current, I_{IN} (MAX) $V_{is} \square V_{DD}$			-	-	-	-	-	-	-	μA
	$V_{DD} - V_{SS} = 18V$	18		± 0.1	± 0.1	± 1	± 1	$\pm 10^{-5}$	± 0.1		
	$V_{CC} \square V_{DD} - V_{SS}$			-	-	-	-	-	-	-	
Crosstalk (Control Input to Signal Output)	$V_C = 10V$ (Sq. Wave)			-	-	-	-	-	50	-	mV
	$t_r, t_f = 20ns$	10		-	-	-	-	-	-	-	
	$R_L = 10k\Omega$			-	-	-	-	-	-	-	
Turn-On Propagation Delay	Turn-On Propagation Delay $t_r, t_f = 20ns$	5		-	-	-	-	-	35	70	ns
	$C_L = 50pF$	10		-	-	-	-	-	20	40	
	$R_L = 1k\Omega$	15		-	-	-	-	-	15	30	

4.6 Electrical Characteristics (continued)

CHARACTERISTIC	TEST CONDITIONS			LIMITS AT INDICATED TEMPERATURES (°C)						UNITS
		V_{IN} (V)	V_{DD} (V)					+25		
				-55	-40	+85	+125	TYP	MAX	
Maximum Control Input Repetition Rate	Maximum Control Input Repetition Rate $V_{is} = V_{DD} < V_{SS} = GND$, $R_L = 1k\Omega$ to GND, $C_L = 50pF$, $V_C = 10V$ (Square wave centered on 5V) $t_r, t_f = 20ns$, $V_{OS} = \frac{1}{2} V_{OS}$ at 1kHz		10	-	-	-	-	10	-	MHz
Input Capacitance, C_{IN}				-	-	-	-	5	7.5	μF

4.7 Typical Characteristics

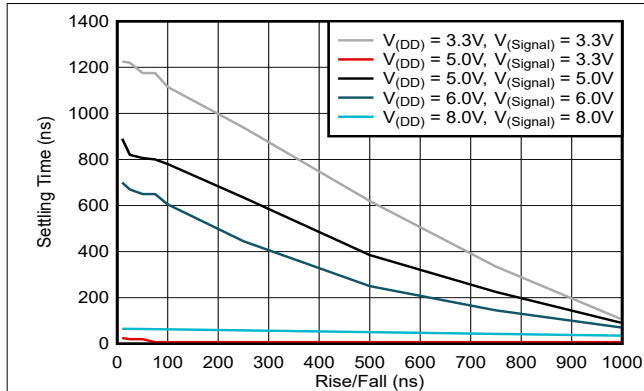

Figure 4-1. System Settling Time vs Signal Rise/Fall Time

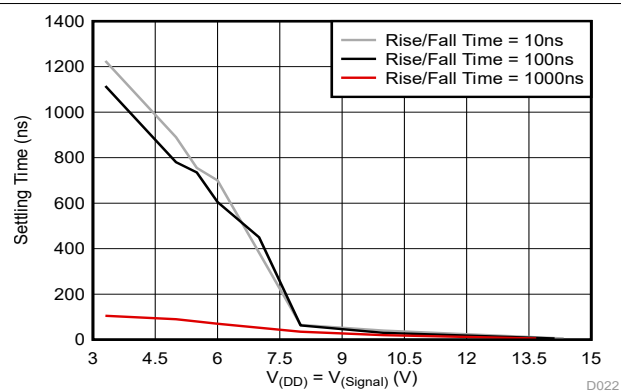

Figure 4-2. System Settling Time vs Signal Voltage

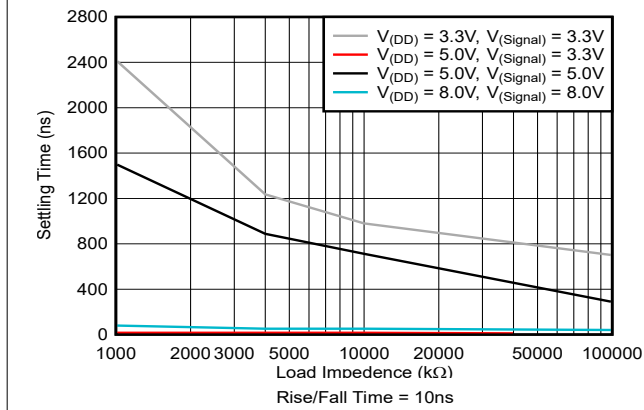

Figure 4-3. System Settling Time vs Signal Voltage

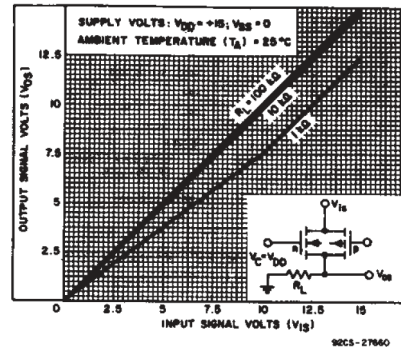

Figure 4-4. On-state Characteristics for 1 of 4 Switches with $V_{DD} = +15V$, $V_{SS} = 0V$.

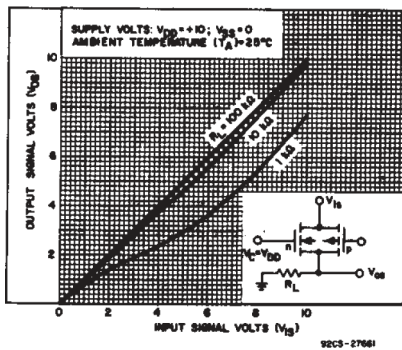

Figure 4-5. On-state Characteristics for 1 of 4 Switches with $V_{DD} = +10V$, $V_{SS} = 0V$.

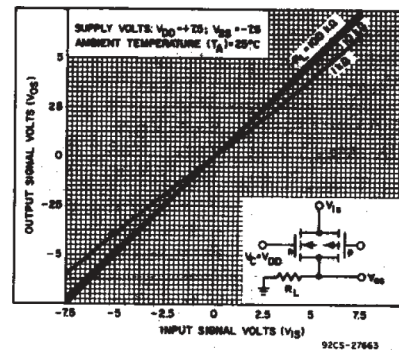

Figure 4-6. On-state Characteristics for 1 of 4 Switches with $V_{DD} = +7.5V$, $V_{SS} = -7.5V$.

4.7 Typical Characteristics (continued)

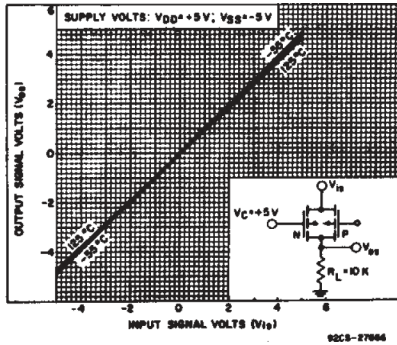

Figure 4-7. On-state Characteristics as a Function of Temp. for 1 of 4 Switches with $V_{DD} = +5V$, $V_{SS} = -5V$.

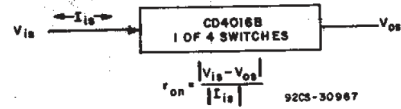

Figure 4-8. Determination of R_{on} As a Test Condition for Control Input High Voltage Specification.

5 Parameter Measurement Information

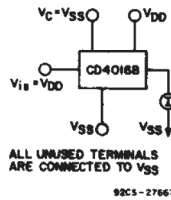

Figure 5-1. Off-state Switch Input or Output Leakage Current Test Circuit.

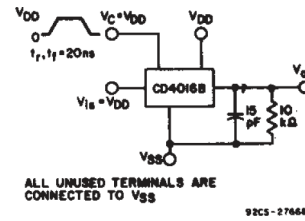

Figure 5-2. Test Circuit for Square-wave Response.

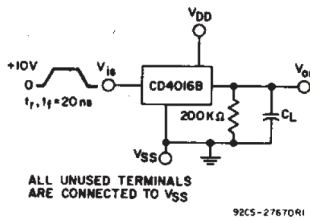

Figure 5-3. Propagation Delay Time Signal Input (v_{is}) To Signal Output (v_{os})

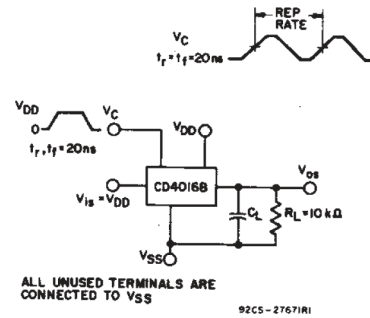
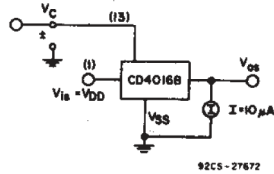
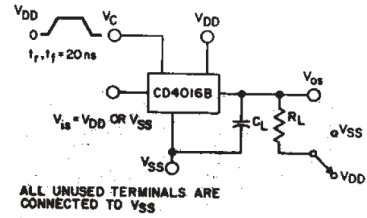

Figure 5-4. MAX Control-input Repetition Rate.



92CS-27672
SWITCH THRESHOLD VOLTAGE IS DEFINED AS THE VOLTAGE APPLIED TO A TRANSMISSION GATE CONTROL WHICH CAUSES 10 μA OF TRANSMISSION GATE CURRENT.

Figure 5-5. Switch Threshold Voltage.



ALL UNUSED TERMINALS ARE CONNECTED TO VSS

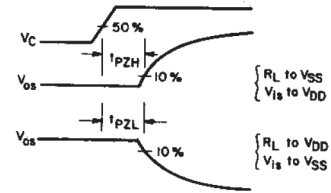

92CM-28308

Figure 5-6. Turn-On Propagation Delay-control Input.

6 Device and Documentation Support

TI offers an extensive line of development tools. Tools and software to evaluate the performance of the device, generate code, and develop solutions are listed below.

6.1 Documentation Support

6.1.1 Receiving Notification of Documentation Updates

To receive notification of documentation updates, navigate to the device product folder on ti.com. Click on *Notifications* to register and receive a weekly digest of any product information that has changed. For change details, review the revision history included in any revised document.

6.1.2 Support Resources

[TI E2E™ support forums](#) are an engineer's go-to source for fast, verified answers and design help — straight from the experts. Search existing answers or ask your own question to get the quick design help you need.

Linked content is provided "AS IS" by the respective contributors. They do not constitute TI specifications and do not necessarily reflect TI's views; see TI's [Terms of Use](#).

6.1.3 Trademarks

TI E2E™ is a trademark of Texas Instruments.
All trademarks are the property of their respective owners.

6.1.4 Electrostatic Discharge Caution



This integrated circuit can be damaged by ESD. Texas Instruments recommends that all integrated circuits be handled with appropriate precautions. Failure to observe proper handling and installation procedures can cause damage.

ESD damage can range from subtle performance degradation to complete device failure. Precision integrated circuits may be more susceptible to damage because very small parametric changes could cause the device not to meet its published specifications.

6.1.5 Glossary

[TI Glossary](#) This glossary lists and explains terms, acronyms, and definitions.

7 Revision History

NOTE: Page numbers for previous revisions may differ from page numbers in the current version.

Changes from Revision D (May 2024) to Revision E (August 2024)	Page
• Added Settling Time plots.....	10

Changes from Revision C (September 2003) to Revision D (May 2024)	Page
• Increased IDD max/typ for the lower Temperature cases.....	5
• Changed typical I _{IH} to 0.5μA.....	5
• Changed typical I _{IL} to -0.1μA.....	5

8 Mechanical, Packaging, and Orderable Information

The following pages include mechanical, packaging, and orderable information. This information is the most current data available for the designated devices. This data is subject to change without notice and revision of this document. For browser-based versions of this data sheet, refer to the left-hand navigation.

PACKAGING INFORMATION

Orderable Device	Status (1)	Package Type	Package Drawing	Pins	Package Qty	Eco Plan (2)	Lead finish/ Ball material (6)	MSL Peak Temp (3)	Op Temp (°C)	Device Marking (4/5)	Samples
5962-9064001CA	ACTIVE	CDIP	J	14	25	Non-RoHS & Green	SNPB	N / A for Pkg Type	-55 to 125	5962-9064001CA CD4016BF3A	Samples
CD4016BE	ACTIVE	PDIP	N	14	25	RoHS & Green	NIPDAU	N / A for Pkg Type	-55 to 125	CD4016BE	Samples
CD4016BEE4	ACTIVE	PDIP	N	14	25	RoHS & Green	NIPDAU	N / A for Pkg Type	-55 to 125	CD4016BE	Samples
CD4016BF	ACTIVE	CDIP	J	14	25	Non-RoHS & Green	SNPB	N / A for Pkg Type	-55 to 125	CD4016BF	Samples
CD4016BF3A	ACTIVE	CDIP	J	14	25	Non-RoHS & Green	SNPB	N / A for Pkg Type	-55 to 125	5962-9064001CA CD4016BF3A	Samples
CD4016BM	OBSOLETE	SOIC	D	14		TBD	Call TI	Call TI	-55 to 125	CD4016BM	
CD4016BM96	ACTIVE	SOIC	D	14	2500	RoHS & Green	NIPDAU	Level-1-260C-UNLIM	-55 to 125	CD4016BM	Samples
CD4016BMT	OBSOLETE	SOIC	D	14		TBD	Call TI	Call TI	-55 to 125	CD4016BM	
CD4016BNSR	NRND	SO	NS	14	2000	RoHS & Green	NIPDAU	Level-1-260C-UNLIM	-55 to 125	CD4016B	
CD4016BPW	NRND	TSSOP	PW	14	90	RoHS & Green	NIPDAU	Level-1-260C-UNLIM	-55 to 125	CM016B	
CD4016BPWR	NRND	TSSOP	PW	14	2000	RoHS & Green	NIPDAU	Level-1-260C-UNLIM	-55 to 125	CM016B	

(1) The marketing status values are defined as follows:

ACTIVE: Product device recommended for new designs.

LIFEBUY: TI has announced that the device will be discontinued, and a lifetime-buy period is in effect.

NRND: Not recommended for new designs. Device is in production to support existing customers, but TI does not recommend using this part in a new design.

PREVIEW: Device has been announced but is not in production. Samples may or may not be available.

OBSOLETE: TI has discontinued the production of the device.

(2) **RoHS:** TI defines "RoHS" to mean semiconductor products that are compliant with the current EU RoHS requirements for all 10 RoHS substances, including the requirement that RoHS substance do not exceed 0.1% by weight in homogeneous materials. Where designed to be soldered at high temperatures, "RoHS" products are suitable for use in specified lead-free processes. TI may reference these types of products as "Pb-Free".

RoHS Exempt: TI defines "RoHS Exempt" to mean products that contain lead but are compliant with EU RoHS pursuant to a specific EU RoHS exemption.

Green: TI defines "Green" to mean the content of Chlorine (Cl) and Bromine (Br) based flame retardants meet JS709B low halogen requirements of <=1000ppm threshold. Antimony trioxide based flame retardants must also meet the <=1000ppm threshold requirement.

(3) MSL, Peak Temp. - The Moisture Sensitivity Level rating according to the JEDEC industry standard classifications, and peak solder temperature.

(4) There may be additional marking, which relates to the logo, the lot trace code information, or the environmental category on the device.

⁽⁵⁾ Multiple Device Markings will be inside parentheses. Only one Device Marking contained in parentheses and separated by a "~" will appear on a device. If a line is indented then it is a continuation of the previous line and the two combined represent the entire Device Marking for that device.

⁽⁶⁾ Lead finish/Ball material - Orderable Devices may have multiple material finish options. Finish options are separated by a vertical ruled line. Lead finish/Ball material values may wrap to two lines if the finish value exceeds the maximum column width.

Important Information and Disclaimer:The information provided on this page represents TI's knowledge and belief as of the date that it is provided. TI bases its knowledge and belief on information provided by third parties, and makes no representation or warranty as to the accuracy of such information. Efforts are underway to better integrate information from third parties. TI has taken and continues to take reasonable steps to provide representative and accurate information but may not have conducted destructive testing or chemical analysis on incoming materials and chemicals. TI and TI suppliers consider certain information to be proprietary, and thus CAS numbers and other limited information may not be available for release.

In no event shall TI's liability arising out of such information exceed the total purchase price of the TI part(s) at issue in this document sold by TI to Customer on an annual basis.

OTHER QUALIFIED VERSIONS OF CD4016B, CD4016B-MIL :

- Catalog : [CD4016B](#)
- Military : [CD4016B-MIL](#)

NOTE: Qualified Version Definitions:

- Catalog - TI's standard catalog product
- Military - QML certified for Military and Defense Applications

TAPE AND REEL INFORMATION

QUADRANT ASSIGNMENTS FOR PIN 1 ORIENTATION IN TAPE

*All dimensions are nominal

Device	Package Type	Package Drawing	Pins	SPQ	Reel Diameter (mm)	Reel Width W1 (mm)	A0 (mm)	B0 (mm)	K0 (mm)	P1 (mm)	W (mm)	Pin1 Quadrant
CD4016BM96	SOIC	D	14	2500	330.0	16.4	6.5	9.0	2.1	8.0	16.0	Q1
CD4016BM96	SOIC	D	14	2500	330.0	16.4	6.5	9.0	2.1	8.0	16.0	Q1
CD4016BNSR	SO	NS	14	2000	330.0	16.4	8.2	10.5	2.5	12.0	16.0	Q1
CD4016BPWR	TSSOP	PW	14	2000	330.0	12.4	6.9	5.6	1.6	8.0	12.0	Q1

TAPE AND REEL BOX DIMENSIONS



*All dimensions are nominal

Device	Package Type	Package Drawing	Pins	SPQ	Length (mm)	Width (mm)	Height (mm)
CD4016BM96	SOIC	D	14	2500	353.0	353.0	32.0
CD4016BM96	SOIC	D	14	2500	356.0	356.0	35.0
CD4016BNSR	SO	NS	14	2000	356.0	356.0	35.0
CD4016BPWR	TSSOP	PW	14	2000	367.0	367.0	35.0

TUBE

*All dimensions are nominal

Device	Package Name	Package Type	Pins	SPQ	L (mm)	W (mm)	T (μm)	B (mm)
CD4016BE	N	PDIP	14	25	506	13.97	11230	4.32
CD4016BEE4	N	PDIP	14	25	506	13.97	11230	4.32
CD4016BPW	PW	TSSOP	14	90	530	10.2	3600	3.5

MECHANICAL DATA

NS (R-PDSO-G**)

PLASTIC SMALL-OUTLINE PACKAGE

14-PINS SHOWN



- NOTES:
- A. All linear dimensions are in millimeters.
 - B. This drawing is subject to change without notice.
 - C. Body dimensions do not include mold flash or protrusion, not to exceed 0,15.

J 14

GENERIC PACKAGE VIEW
CDIP - 5.08 mm max height
CERAMIC DUAL IN LINE PACKAGE



Images above are just a representation of the package family, actual package may vary.
Refer to the product data sheet for package details.

4040083-5/G

J0014A



PACKAGE OUTLINE

CDIP - 5.08 mm max height

CERAMIC DUAL IN LINE PACKAGE



4214771/A 05/2017

NOTES:

1. All controlling linear dimensions are in inches. Dimensions in brackets are in millimeters. Any dimension in brackets or parenthesis are for reference only. Dimensioning and tolerancing per ASME Y14.5M.
2. This drawing is subject to change without notice.
3. This package is hermetically sealed with a ceramic lid using glass frit.
4. Index point is provided on cap for terminal identification only and on press ceramic glass frit seal only.
5. Falls within MIL-STD-1835 and GDIP1-T14.

EXAMPLE BOARD LAYOUT

J0014A

CDIP - 5.08 mm max height

CERAMIC DUAL IN LINE PACKAGE



LAND PATTERN EXAMPLE
NON-SOLDER MASK DEFINED
SCALE: 5X



4214771/A 05/2017

D (R-PDSO-G14)

PLASTIC SMALL OUTLINE



- NOTES:
- A. All linear dimensions are in inches (millimeters).
 - B. This drawing is subject to change without notice.
 -  Body length does not include mold flash, protrusions, or gate burrs. Mold flash, protrusions, or gate burrs shall not exceed 0.006 (0,15) each side.
 -  Body width does not include interlead flash. Interlead flash shall not exceed 0.017 (0,43) each side.
 - E. Reference JEDEC MS-012 variation AB.

D (R-PDSO-G14)

PLASTIC SMALL OUTLINE



4211283-3/E 08/12

- NOTES:
- A. All linear dimensions are in millimeters.
 - B. This drawing is subject to change without notice.
 - C. Publication IPC-7351 is recommended for alternate designs.
 - D. Laser cutting apertures with trapezoidal walls and also rounding corners will offer better paste release. Customers should contact their board assembly site for stencil design recommendations. Refer to IPC-7525 for other stencil recommendations.
 - E. Customers should contact their board fabrication site for solder mask tolerances between and around signal pads.

PW (R-PDSO-G14)

PLASTIC SMALL OUTLINE



- NOTES:
- A. All linear dimensions are in millimeters. Dimensioning and tolerancing per ASME Y14.5M-1994.
 - B. This drawing is subject to change without notice.
 - C. Body length does not include mold flash, protrusions, or gate burrs. Mold flash, protrusions, or gate burrs shall not exceed 0,15 each side.
 - D. Body width does not include interlead flash. Interlead flash shall not exceed 0,25 each side.
 - E. Falls within JEDEC MO-153

N (R-PDIP-T**)

PLASTIC DUAL-IN-LINE PACKAGE

16 PINS SHOWN



4040049/E 12/2002

- NOTES:
- A. All linear dimensions are in inches (millimeters).
 - B. This drawing is subject to change without notice.
 - (C) Falls within JEDEC MS-001, except 18 and 20 pin minimum body length (Dim A).
 - (D) The 20 pin end lead shoulder width is a vendor option, either half or full width.

IMPORTANT NOTICE AND DISCLAIMER

TI PROVIDES TECHNICAL AND RELIABILITY DATA (INCLUDING DATA SHEETS), DESIGN RESOURCES (INCLUDING REFERENCE DESIGNS), APPLICATION OR OTHER DESIGN ADVICE, WEB TOOLS, SAFETY INFORMATION, AND OTHER RESOURCES "AS IS" AND WITH ALL FAULTS, AND DISCLAIMS ALL WARRANTIES, EXPRESS AND IMPLIED, INCLUDING WITHOUT LIMITATION ANY IMPLIED WARRANTIES OF MERCHANTABILITY, FITNESS FOR A PARTICULAR PURPOSE OR NON-INFRINGEMENT OF THIRD PARTY INTELLECTUAL PROPERTY RIGHTS.

These resources are intended for skilled developers designing with TI products. You are solely responsible for (1) selecting the appropriate TI products for your application, (2) designing, validating and testing your application, and (3) ensuring your application meets applicable standards, and any other safety, security, regulatory or other requirements.

These resources are subject to change without notice. TI grants you permission to use these resources only for development of an application that uses the TI products described in the resource. Other reproduction and display of these resources is prohibited. No license is granted to any other TI intellectual property right or to any third party intellectual property right. TI disclaims responsibility for, and you will fully indemnify TI and its representatives against, any claims, damages, costs, losses, and liabilities arising out of your use of these resources.

TI's products are provided subject to [TI's Terms of Sale](#) or other applicable terms available either on [ti.com](https://www.ti.com) or provided in conjunction with such TI products. TI's provision of these resources does not expand or otherwise alter TI's applicable warranties or warranty disclaimers for TI products.

TI objects to and rejects any additional or different terms you may have proposed.

Mailing Address: Texas Instruments, Post Office Box 655303, Dallas, Texas 75265
Copyright © 2024, Texas Instruments Incorporated