

CD4049UB and CD4050B CMOS Hex Inverting Buffer and Converter

1 Features

- CD4049UB Inverting
- CD4050B Noninverting
- High Sink Current for Driving 2 TTL Loads
- High-to-Low Level Logic Conversion
- 100% Tested for Quiescent Current at 20 V
- Maximum Input Current of 1 μA at 18 V Over Full Package Temperature Range; 100 nA at 18 V and 25°C
- 5-V, 10-V, and 15-V Parametric Ratings

2 Applications

- CMOS to DTL or TTL Hex Converters
- CMOS Current *Sink* or *Source* Drivers
- CMOS High-to-Low Logic Level Converters

3 Description

The CD4049UB and CD4050B devices are inverting and noninverting hex buffers, and feature logic-level conversion using only one supply voltage (V_{CC}). The input-signal high level (V_{IH}) can exceed the V_{CC} supply voltage when these devices are used for logic-level conversions. These devices are intended for use as CMOS to DTL or TTL converters and can drive directly two DTL or TTL loads. ($V_{CC} = 5\text{ V}$, $V_{OL} \leq 0.4\text{ V}$, and $I_{OL} \geq 3.3\text{ mA}$.)

Device Information

| PART NUMBER ⁽¹⁾ | PACKAGE | BODY SIZE (NOM) |
|----------------------------|------------|--------------------|
| CD4049UBE, CD4050BE | PDIP (16) | 6.35 mm × 19.30 mm |
| CD4049UBD, CD4050BD | SOIC (16) | 9.90 mm × 3.91 mm |
| CD4049UBDW, CD4050BDW | SOIC (16) | 10.30 mm × 7.50 mm |
| CD4049UBNS, CD4050BNS | SO (16) | 10.30 mm × 5.30 mm |
| CD4049UBPW, CD4050BPW | TSSOP (16) | 5.00 mm × 4.40 mm |

(1) For all available packages, see the orderable addendum at the end of the data sheet.

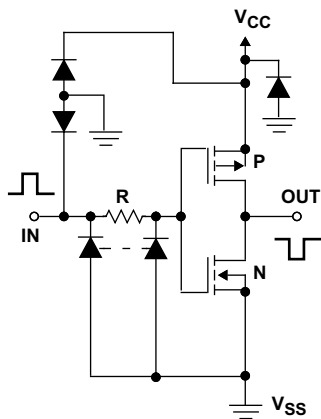

Copyright © 2016,
Texas Instruments Incorporated

1 of 6 Identical Units

Schematic Diagram of CD4049UB

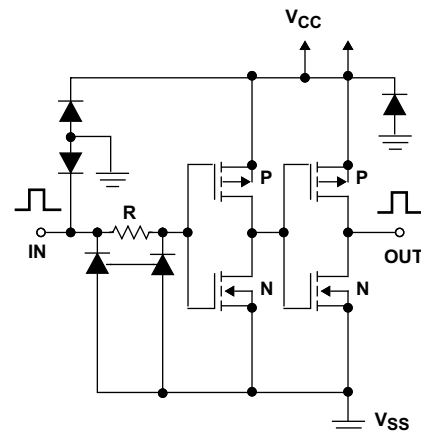

Copyright © 2016, Texas Instruments Incorporated

1 of 6 Identical Units

Schematic Diagram of CD4050B



Table of Contents

| | | | |
|--|----|--|----|
| 1 Features | 1 | 8.4 Device Functional Modes..... | 14 |
| 2 Applications | 1 | 9 Application and Implementation | 15 |
| 3 Description | 1 | 9.1 Application Information..... | 15 |
| 4 Revision History | 2 | 9.2 Typical Application..... | 15 |
| 5 Pin Configuration and Functions | 3 | 10 Power Supply Recommendations | 16 |
| 6 Specifications | 4 | 11 Layout | 16 |
| 6.1 Absolute Maximum Ratings..... | 4 | 11.1 Layout Guidelines..... | 16 |
| 6.2 ESD Ratings..... | 4 | 11.2 Layout Example..... | 16 |
| 6.3 Recommended Operating Conditions..... | 4 | 12 Device and Documentation Support | 17 |
| 6.4 Thermal Information..... | 5 | 12.1 Documentation Support..... | 17 |
| 6.5 Electrical Characteristics: DC..... | 5 | 12.2 Related Links..... | 17 |
| 6.6 Electrical Characteristics: AC..... | 9 | 12.3 Receiving Notification of Documentation Updates.. | 17 |
| 6.7 Typical Characteristics..... | 10 | 12.4 Support Resources..... | 17 |
| 7 Parameter Measurement Information | 11 | 12.5 Trademarks..... | 17 |
| 7.1 Test Circuits..... | 11 | 12.6 Electrostatic Discharge Caution..... | 17 |
| 8 Detailed Description | 13 | 12.7 Glossary..... | 17 |
| 8.1 Overview..... | 13 | 13 Mechanical, Packaging, and Orderable Information | 17 |
| 8.2 Functional Block Diagram..... | 13 | | |
| 8.3 Feature Description..... | 13 | | |

4 Revision History

NOTE: Page numbers for previous revisions may differ from page numbers in the current version.

| Changes from Revision J (September 2016) to Revision K (June 2020) | Page |
|---|-------------|
| • Updated the numbering format for tables, figures, and cross-references throughout the document..... | 1 |
| • Updated <i>Device Information Table</i> with correct package dimensions..... | 1 |
| Changes from Revision I (May 2004) to Revision J (September 2016) | Page |
| • Added <i>ESD Ratings</i> table, <i>Feature Description</i> section, <i>Device Functional Modes</i> , <i>Application and Implementation</i> section, <i>Power Supply Recommendations</i> section, <i>Layout</i> section, <i>Device and Documentation Support</i> section, and <i>Mechanical, Packaging, and Orderable Information</i> section..... | 1 |
| • Deleted <i>Ordering Information</i> table; see POA at the end of the data sheet..... | 1 |
| • Changed Storage temperature minimum value from 65 to –65..... | 4 |
| • Changed $R_{\theta JA}$ values for the CD4049UB device: D (SOIC) from 73 to 81.6, DW (SOIC) from 57 to 81.6, E (PDIP) from 67 to 49.5, NS (SO) from 64 to 84.3, and PW (TSSOP) from 108 to 108.9..... | 5 |
| • Changed $R_{\theta JA}$ values for the CD4050B device: D (SOIC) from 73 to 81.6, DW (SOIC) from 57 to 81.2, E (PDIP) from 67 to 49.7, NS (SO) from 64 to 83.8, and PW (TSSOP) from 108 to 108.4..... | 5 |

5 Pin Configuration and Functions

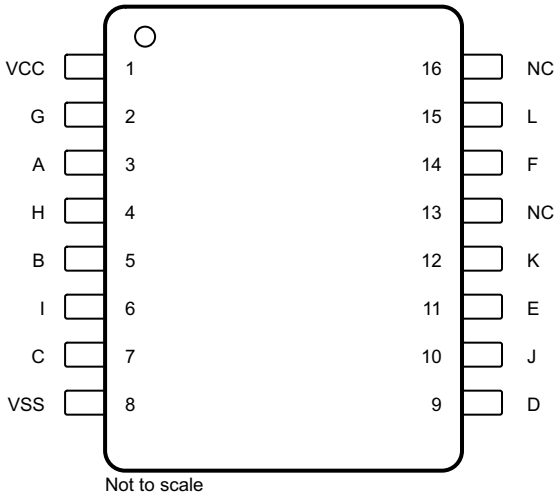

Figure 5-1. CD4049UB D, DW, N, NS, and PW Packages 16-Pin SOIC, PDIP, SO, and TSSOP Top View

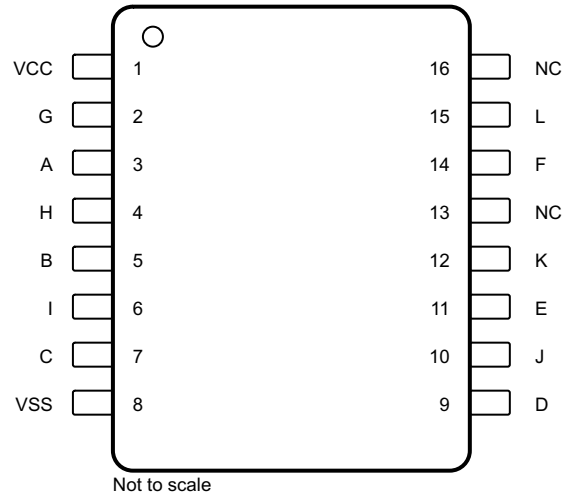

Figure 5-2. CD4050B D, DW, N, NS, and PW Packages 16-Pin SOIC, PDIP, SO, and TSSOP Top View

Pin Functions: CD4049UB

| PIN | | I/O | DESCRIPTION |
|------|--------|-----|-----------------------------------|
| NAME | NO. | | |
| A | 3 | I | Input 1 |
| B | 5 | I | Input 2 |
| C | 7 | I | Input 3 |
| D | 9 | I | Input 4 |
| E | 11 | I | Input 5 |
| F | 14 | I | Input 6 |
| G | 2 | O | Inverting output 1. $G = \bar{A}$ |
| H | 4 | O | Inverting output 2. $H = \bar{B}$ |
| I | 6 | O | Inverting output 3. $I = \bar{C}$ |
| J | 10 | O | Inverting output 4. $J = \bar{D}$ |
| K | 12 | O | Inverting output 5. $K = \bar{E}$ |
| L | 15 | O | Inverting output 6. $L = \bar{F}$ |
| NC | 13, 16 | — | No connection |
| VCC | 1 | — | Power pin |
| VSS | 8 | — | Negative supply |

Pin Functions: CD4050B

| PIN | | I/O | DESCRIPTION |
|------|--------|-----|---------------------------|
| NAME | NO. | | |
| A | 3 | I | Input 1 |
| B | 5 | I | Input 2 |
| C | 7 | I | Input 3 |
| D | 9 | I | Input 4 |
| E | 11 | I | Input 5 |
| F | 14 | I | Input 6 |
| G | 2 | O | Inverting output 1. G = A |
| H | 4 | O | Inverting output 2. H = B |
| I | 6 | O | Inverting output 3. I = C |
| J | 10 | O | Inverting output 4. J = D |
| K | 12 | O | Inverting output 5. K = E |
| L | 15 | O | Inverting output 6. L = F |
| NC | 13, 16 | — | No connection |
| VCC | 1 | — | Power pin |
| VSS | 8 | — | Negative supply |

6 Specifications

6.1 Absolute Maximum Ratings

over operating free-air temperature range (unless otherwise noted) ⁽¹⁾

| | | MIN | MAX | UNIT |
|------------------------------------|----------------------|------|-----|------|
| Supply voltage | VCC to VSS | -0.5 | 20 | V |
| DC input current, I_{IK} | Any one input | | ±10 | mA |
| Lead temperature (soldering, 10 s) | SOIC, lead tips only | | 265 | °C |
| Junction temperature, T_J | | | 150 | °C |
| Storage temperature, T_{stg} | | -65 | 150 | °C |

- (1) Stresses beyond those listed under *Absolute Maximum Ratings* may cause permanent damage to the device. These are stress ratings only, which do not imply functional operation of the device at these or any other conditions beyond those indicated under [Section 6.3](#). Exposure to absolute-maximum-rated conditions for extended periods may affect device reliability.

6.2 ESD Ratings

| | | VALUE | UNIT |
|-------------|-------------------------|--|-------|
| $V_{(ESD)}$ | Electrostatic discharge | Human-body model (HBM), per ANSI/ESDA/JEDEC JS-001 ⁽¹⁾ | ±1500 |
| | | Charged-device model (CDM), per JEDEC specification JESD22-C101 ⁽²⁾ | ±1000 |

- (1) JEDEC document JEP155 states that 500-V HBM allows safe manufacturing with a standard ESD control process.
 (2) JEDEC document JEP157 states that 250-V CDM allows safe manufacturing with a standard ESD control process.

6.3 Recommended Operating Conditions

over operating free-air temperature range (unless otherwise noted)

| | | MIN | MAX | UNIT |
|----------|-----------------------|-----|-----|------|
| V_{CC} | Supply voltage | 3 | 18 | V |
| T_A | Operating temperature | -55 | 125 | °C |

6.4 Thermal Information

| THERMAL METRIC ⁽¹⁾ | CD4049UB | | | | | CD4050B | | | | | UNIT | |
|-------------------------------|---|-----------|----------|---------|------------|----------|-----------|----------|---------|------------|-------|------|
| | D (SOIC) | DW (SOIC) | E (PDIP) | NS (SO) | PW (TSSOP) | D (SOIC) | DW (SOIC) | E (PDIP) | NS (SO) | PW (TSSOP) | | |
| | 16 PINS | 16 PINS | 16 PINS | 16 PINS | 16 PINS | 16 PINS | 16 PINS | 16 PINS | 16 PINS | 16 PINS | | |
| R _{θJA} | Junction-to-ambient thermal resistance ⁽²⁾ | 81.6 | 81.6 | 49.5 | 84.3 | 108.9 | 81.6 | 81.2 | 49.7 | 83.8 | 108.4 | °C/W |
| R _{θJC(top)} | Junction-to-case (top) thermal resistance | 41.5 | 44.5 | 36.8 | 43 | 43.7 | 41.5 | 44.1 | 37 | 42.5 | 43.2 | °C/W |
| R _{θJB} | Junction-to-board thermal resistance | 39 | 46.3 | 29.4 | 44.6 | 54 | 39 | 45.9 | 29.6 | 44.1 | 53.5 | °C/W |
| ψ _{JT} | Junction-to-top characterization parameter | 10.7 | 16.5 | 21.7 | 12.8 | 4.6 | 10.7 | 16.1 | 21.9 | 12.5 | 4.5 | °C/W |
| ψ _{JB} | Junction-to-board characterization parameter | 38.7 | 45.8 | 29.3 | 44.3 | 53.4 | 38.7 | 45.4 | 29.5 | 43.8 | 52.9 | °C/W |

- (1) For more information about traditional and new thermal metrics, see the [Semiconductor and IC Package Thermal Metrics](#) application report.
- (2) The package thermal impedance is calculated in accordance with JESD 51-7.

6.5 Electrical Characteristics: DC

| PARAMETER | TEST CONDITIONS | MIN | TYP | MAX | UNIT |
|---|---|-------------------------|------|-----|------|
| I _{DD(Max)} Quiescent device current | V _{IN} = 0 or 5 V, V _{CC} = 5 V | T _A = -55 °C | | 1 | μA |
| | | T _A = -40 °C | | 1 | |
| | | T _A = 25 °C | 0.02 | 1 | |
| | | T _A = 85 °C | | 30 | |
| | | T _A = 125 °C | | 30 | |
| | V _{IN} = 0 or 10 V, V _{CC} = 10 V | T _A = -55 °C | | 2 | |
| | | T _A = -40 °C | | 2 | |
| | | T _A = 25 °C | 0.02 | 2 | |
| | | T _A = 85 °C | | 60 | |
| | | T _A = 125 °C | | 60 | |
| | V _{IN} = 0 or 15 V, V _{CC} = 4 V | T _A = -55 °C | | 4 | |
| | | T _A = -40 °C | | 4 | |
| | | T _A = 25 °C | 0.02 | 4 | |
| | | T _A = 85 °C | | 120 | |
| | | T _A = 125 °C | | 120 | |
| | V _{IN} = 0 or 20 V, V _{CC} = 20 V | T _A = -55 °C | | 20 | |
| | | T _A = -40 °C | | 20 | |
| | | T _A = 25 °C | 0.04 | 20 | |
| | | T _A = 85 °C | | 600 | |
| | | T _A = 125 °C | | 600 | |

| PARAMETER | | TEST CONDITIONS | MIN | TYP | MAX | UNIT | | |
|-------------------------|------------------------------|---|-------------------------|-------|------|-------|----|------|
| I _{OL} (Min) | Output low (sink) current | V _{OUT} = 0.4 V, V _{IN} = 0 or 5 V, V _{CC} = 4.5 V | T _A = -55 °C | | | 3.3 | mA | |
| | | | T _A = -40 °C | | | 3.1 | | |
| | | | T _A = 25 °C | 2.6 | 5.2 | | | |
| | | | T _A = 85 °C | | | 2.1 | | |
| | | | T _A = 125 °C | | | 1.8 | | |
| | | V _{OUT} = 0.4 V, V _{IN} = 0 or 5 V, V _{CC} = 5 V | T _A = -55 °C | | | | | 4 |
| | | | T _A = -40 °C | | | | | 3.8 |
| | | | T _A = 25 °C | 3.2 | 6.4 | | | |
| | | | T _A = 85 °C | | | 2.9 | | |
| | | | T _A = 125 °C | | | 2.4 | | |
| | | V _{OUT} = 0.5 V, V _{IN} = 0 or 10 V, V _{CC} = 10 V | T _A = -55 °C | | | | | 10 |
| | | | T _A = -40 °C | | | | | 9.6 |
| | | | T _A = 25 °C | 8 | 16 | | | |
| | | | T _A = 85 °C | | | 6.6 | | |
| | | | T _A = 125 °C | | | 5.6 | | |
| | | V _{OUT} = 1.5 V, V _{IN} = 0 or 15 V, V _{CC} = 15 V | T _A = -55 °C | | | | | 26 |
| T _A = -40 °C | | | | | 25 | | | |
| T _A = 25 °C | 24 | | 48 | | | | | |
| T _A = 85 °C | | | | 20 | | | | |
| T _A = 125 °C | | | | 18 | | | | |
| I _{OH} (Min) | Output high (source) current | V _{OUT} = 4.6 V, V _{IN} = 0 or 5 V, V _{CC} = 5 V | T _A = -55 °C | | | -0.81 | mA | |
| | | | T _A = -40 °C | | | -0.73 | | |
| | | | T _A = 25 °C | -0.65 | -1.2 | | | |
| | | | T _A = 85 °C | | | -0.58 | | |
| | | | T _A = 125 °C | | | -0.48 | | |
| | | V _{OUT} = 2.5 V, V _{IN} = 0 or 5 V, V _{CC} = 5 V | T _A = -55 °C | | | | | -2.6 |
| | | | T _A = -40 °C | | | | | -2.4 |
| | | | T _A = 25 °C | -2.1 | -3.9 | | | |
| | | | T _A = 85 °C | | | -1.9 | | |
| | | | T _A = 125 °C | | | -1.55 | | |
| | | V _{OUT} = 9.5 V, V _{IN} = 0 or 10 V, V _{CC} = 10 V | T _A = -55 °C | | | | | -2 |
| | | | T _A = -40 °C | | | | | -1.8 |
| | | | T _A = 25 °C | -1.65 | -3 | | | |
| | | | T _A = 85 °C | | | -1.35 | | |
| | | | T _A = 125 °C | | | -1.18 | | |
| | | V _{OUT} = 1.3 V, V _{IN} = 0 or 15 V, V _{CC} = 15 V | T _A = -55 °C | | | | | -5.2 |
| T _A = -40 °C | | | | | -4.8 | | | |
| T _A = 25 °C | -4.3 | | -8 | | | | | |
| T _A = 85 °C | | | | -3.5 | | | | |
| T _A = 125 °C | | | | -3.1 | | | | |

| PARAMETER | | TEST CONDITIONS | MIN | TYP | MAX | UNIT | |
|--|--|---|-------|-----|-------|------|-------|
| $V_{OL}(\text{Max})$ Out voltage low level | $V_{IN} = 0$ or 5 V , $V_{CC} = 5\text{ V}$ | $T_A = -55\text{ }^\circ\text{C}$ | | | 0.05 | V | |
| | | $T_A = -40\text{ }^\circ\text{C}$ | | | 0.05 | | |
| | | $T_A = 25\text{ }^\circ\text{C}$ | | 0 | 0.05 | | |
| | | $T_A = 85\text{ }^\circ\text{C}$ | | | 0.05 | | |
| | | $T_A = 125\text{ }^\circ\text{C}$ | | | 0.05 | | |
| | $V_{IN} = 0$ or 10 V , $V_{CC} = 10\text{ V}$ | $T_A = -55\text{ }^\circ\text{C}$ | | | | | 0.05 |
| | | $T_A = -40\text{ }^\circ\text{C}$ | | | | | 0.05 |
| | | $T_A = 25\text{ }^\circ\text{C}$ | | 0 | 0.05 | | |
| | | $T_A = 85\text{ }^\circ\text{C}$ | | | 0.05 | | |
| | | $T_A = 125\text{ }^\circ\text{C}$ | | | 0.05 | | |
| | $V_{IN} = 0$ or 15 V , $V_{CC} = 15\text{ V}$ | $T_A = -55\text{ }^\circ\text{C}$ | | | | | 0.05 |
| | | $T_A = -40\text{ }^\circ\text{C}$ | | | | | 0.05 |
| | | $T_A = 25\text{ }^\circ\text{C}$ | | 0 | 0.05 | | |
| | | $T_A = 85\text{ }^\circ\text{C}$ | | | 0.05 | | |
| | | $T_A = 125\text{ }^\circ\text{C}$ | | | 0.05 | | |
| $V_{OH}(\text{Min})$ Output voltage high level | $V_{IN} = 0$ or 5 V , $V_{CC} = 5\text{ V}$ | $T_A = -55\text{ }^\circ\text{C}$ | | | 4.95 | V | |
| | | $T_A = -40\text{ }^\circ\text{C}$ | | | 4.95 | | |
| | | $T_A = 25\text{ }^\circ\text{C}$ | 4.95 | 5 | | | |
| | | $T_A = 85\text{ }^\circ\text{C}$ | | | 4.95 | | |
| | | $T_A = 125\text{ }^\circ\text{C}$ | | | 4.95 | | |
| | $V_{IN} = 0$ or 10 V , $V_{CC} = 10\text{ V}$ | $T_A = -55\text{ }^\circ\text{C}$ | | | | | 9.95 |
| | | $T_A = -40\text{ }^\circ\text{C}$ | | | | | 9.95 |
| | | $T_A = 25\text{ }^\circ\text{C}$ | 9.95 | 10 | | | |
| | | $T_A = 85\text{ }^\circ\text{C}$ | | | 9.95 | | |
| | | $T_A = 125\text{ }^\circ\text{C}$ | | | 9.95 | | |
| | $V_{IN} = 0$ or 15 V , $V_{CC} = 15\text{ V}$ | $T_A = -55\text{ }^\circ\text{C}$ | | | | | 14.95 |
| | | $T_A = -40\text{ }^\circ\text{C}$ | | | | | 14.95 |
| | | $T_A = 25\text{ }^\circ\text{C}$ | 14.95 | 15 | | | |
| | | $T_A = 85\text{ }^\circ\text{C}$ | | | 14.95 | | |
| | | $T_A = 125\text{ }^\circ\text{C}$ | | | 14.95 | | |
| $V_{IL}(\text{Max})$ | Input low voltage (CD4049UB) | $V_{OUT} = 4.5\text{ V}$, $V_{CC} = 5\text{ V}$, Full temperature range | | | 1 | V | |
| | | $V_{OUT} = 9\text{ V}$, $V_{CC} = 10\text{ V}$, Full temperature range | | | 2 | | |
| | | $V_{OUT} = 13.5\text{ V}$, $V_{CC} = 15\text{ V}$, Full temperature range | | | 2.5 | | |
| | Input low voltage (CD4050B) | $V_{OUT} = 0.5\text{ V}$, $V_{CC} = 5\text{ V}$, Full temperature range | | | 1.5 | | |
| | | $V_{OUT} = 1\text{ V}$, $V_{CC} = 10\text{ V}$, Full temperature range | | | 3 | | |
| | | $V_{OUT} = 1.5\text{ V}$, $V_{CC} = 15\text{ V}$, Full temperature range | | | 4 | | |

| PARAMETER | | TEST CONDITIONS | MIN | TYP | MAX | UNIT | | |
|----------------------|-------------------------------|---|-------------------------|-------------------|-----|------|----|------|
| V _{IH(Min)} | Input high voltage (CD4049UB) | V _{OUT} = 0.5 V, V _{CC} = 5 V | T _A = -55 °C | | | 4 | V | |
| | | | T _A = -40 °C | | | 4 | | |
| | | | T _A = 25 °C | 4 | | | | |
| | | | T _A = 85 °C | | | 4 | | |
| | | | T _A = 125 °C | | | 4 | | |
| | | V _{OUT} = 1 V, V _{CC} = 10 V | T _A = -55 °C | | | | | 8 |
| | | | T _A = -40 °C | | | | | 8 |
| | | | T _A = 25 °C | 8 | | | | |
| | | | T _A = 85 °C | | | | | 8 |
| | | | T _A = 125 °C | | | | | 8 |
| | | V _{OUT} = 1.5 V, V _{CC} = 15 V | T _A = -55 °C | | | | | 12.5 |
| | | | T _A = -40 °C | | | | | 12.5 |
| | | | T _A = 25 °C | 12.5 | | | | |
| | | | T _A = 85 °C | | | | | 12.5 |
| | | | T _A = 125 °C | | | | | 12.5 |
| V _{IH} | Input high voltage (CD4050B) | V _{OUT} = 4.5 V, V _{CC} = 5 V | T _A = -55 °C | | | 3.5 | V | |
| | | | T _A = -40 °C | | | 3.5 | | |
| | | | T _A = 25 °C | 3.5 | | | | |
| | | | T _A = 85 °C | | | 3.5 | | |
| | | | T _A = 125 °C | | | 3.5 | | |
| | | V _{OUT} = 9 V, V _{CC} = 10 V | T _A = -55 °C | | | | | 7 |
| | | | T _A = -40 °C | | | | | 7 |
| | | | T _A = 25 °C | 7 | | | | |
| | | | T _A = 85 °C | | | | | 7 |
| | | | T _A = 125 °C | | | | | 7 |
| | | V _{OUT} = 13.5 V, V _{CC} = 15 V | T _A = -55 °C | | | | | 11 |
| | | | T _A = -40 °C | | | | | 11 |
| | | | T _A = 25 °C | 11 | | | | |
| | | | T _A = 85 °C | | | | | 11 |
| | | | T _A = 125 °C | | | | | 11 |
| I _{IN(Max)} | Input current | V _{IN} = 0 or 18 V, V _{CC} = 18 V | T _A = -55 °C | | | ±0.1 | µA | |
| | | | T _A = -40 °C | | | ±0.1 | | |
| | | | T _A = 25 °C | ±10 ⁻⁵ | | ±0.1 | | |
| | | | T _A = 85 °C | | | ±1 | | |
| | | | T _A = 125 °C | | | ±1 | | |

6.6 Electrical Characteristics: AC

$T_A = 25^\circ\text{C}$, Input t_r and $t_f = 20\text{ ns}$, $C_L = 50\text{ pF}$, $R_L = 200\text{ k}\Omega$ (unless otherwise noted)

| PARAMETER | | TEST CONDITIONS | MIN | TYP | MAX | UNIT |
|-----------|--|--|-----|-----|------|------|
| t_{PLH} | Propagation delay time Low to high (CD4049UB) | $V_{IN} = 5\text{ V}, V_{CC} = 5\text{ V}$ | | 60 | 120 | ns |
| | | $V_{IN} = 10\text{ V}, V_{CC} = 10\text{ V}$ | | 32 | 65 | |
| | | $V_{IN} = 10\text{ V}, V_{CC} = 5\text{ V}$ | | 45 | 90 | |
| | | $V_{IN} = 15\text{ V}, V_{CC} = 15\text{ V}$ | | 25 | 50 | |
| | | $V_{IN} = 15\text{ V}, V_{CC} = 5\text{ V}$ | | 45 | 90 | |
| | Propagation delay time Low to high (CD4050B) | $V_{IN} = 5\text{ V}, V_{CC} = 5\text{ V}$ | | 70 | 140 | ns |
| | | $V_{IN} = 10\text{ V}, V_{CC} = 10\text{ V}$ | | 40 | 80 | |
| | | $V_{IN} = 10\text{ V}, V_{CC} = 5\text{ V}$ | | 45 | 90 | |
| | | $V_{IN} = 15\text{ V}, V_{CC} = 15\text{ V}$ | | 30 | 60 | |
| | | $V_{IN} = 15\text{ V}, V_{CC} = 5\text{ V}$ | | 40 | 80 | |
| t_{PHL} | Propagation delay time High to low (CD4049UB) | $V_{IN} = 5\text{ V}, V_{CC} = 5\text{ V}$ | | 32 | 65 | ns |
| | | $V_{IN} = 10\text{ V}, V_{CC} = 10\text{ V}$ | | 20 | 40 | |
| | | $V_{IN} = 10\text{ V}, V_{CC} = 5\text{ V}$ | | 15 | 30 | |
| | | $V_{IN} = 15\text{ V}, V_{CC} = 15\text{ V}$ | | 15 | 30 | |
| | | $V_{IN} = 15\text{ V}, V_{CC} = 5\text{ V}$ | | 10 | 20 | |
| | Propagation delay time High to low (CD4050B) | $V_{IN} = 5\text{ V}, V_{CC} = 5\text{ V}$ | | 55 | 110 | ns |
| | | $V_{IN} = 10\text{ V}, V_{CC} = 10\text{ V}$ | | 22 | 55 | |
| | | $V_{IN} = 10\text{ V}, V_{CC} = 5\text{ V}$ | | 50 | 100 | |
| | | $V_{IN} = 15\text{ V}, V_{CC} = 15\text{ V}$ | | 15 | 30 | |
| | | $V_{IN} = 15\text{ V}, V_{CC} = 5\text{ V}$ | | 50 | 100 | |
| t_{TLH} | Transition time Low to high | $V_{IN} = 5\text{ V}, V_{CC} = 5\text{ V}$ | | 80 | 160 | ns |
| | | $V_{IN} = 10\text{ V}, V_{CC} = 10\text{ V}$ | | 40 | 80 | |
| | | $V_{IN} = 15\text{ V}, V_{CC} = 15\text{ V}$ | | 30 | 60 | |
| t_{THL} | Transition time High to low | $V_{IN} = 5\text{ V}, V_{CC} = 5\text{ V}$ | | 30 | 60 | ns |
| | | $V_{IN} = 10\text{ V}, V_{CC} = 10\text{ V}$ | | 20 | 40 | |
| | | $V_{IN} = 15\text{ V}, V_{CC} = 15\text{ V}$ | | 15 | 30 | |
| C_{IN} | Input capacitance (CD4049UB) | | | 15 | 22.5 | pF |
| | Input capacitance (CD4050B) | | | 5 | 7.5 | pF |

6.7 Typical Characteristics

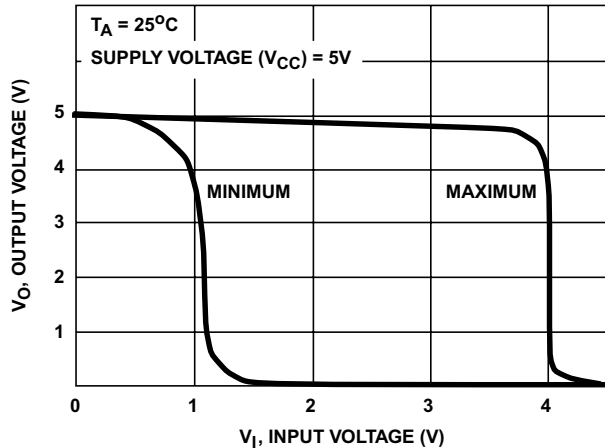

Figure 6-1. Minimum and Maximum Voltage Transfer Characteristics for CD4049UB

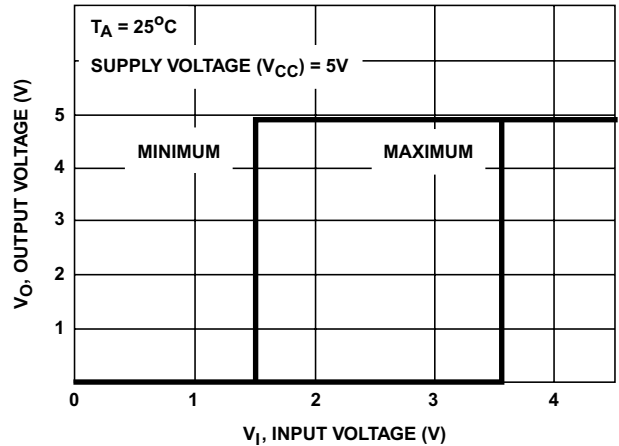

Figure 6-2. Minimum and Maximum Voltage Transfer Characteristics for CD4050B

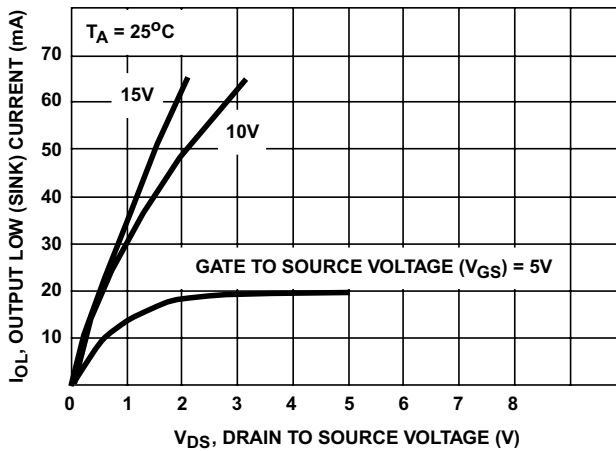

Figure 6-3. Typical Output Low (Sink) Current Characteristics

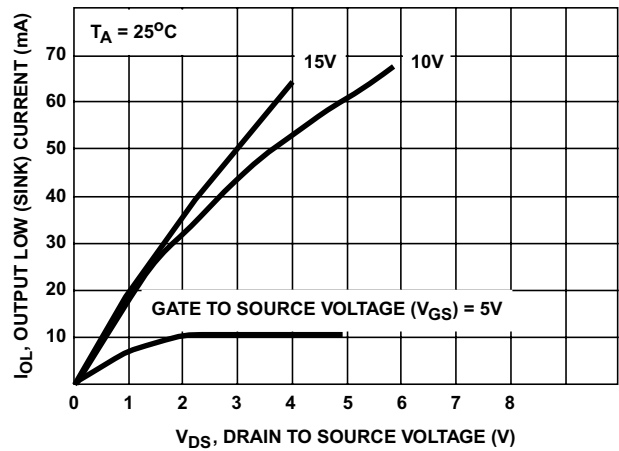

Figure 6-4. Minimum Output Low (Sink) Current Drain Characteristics

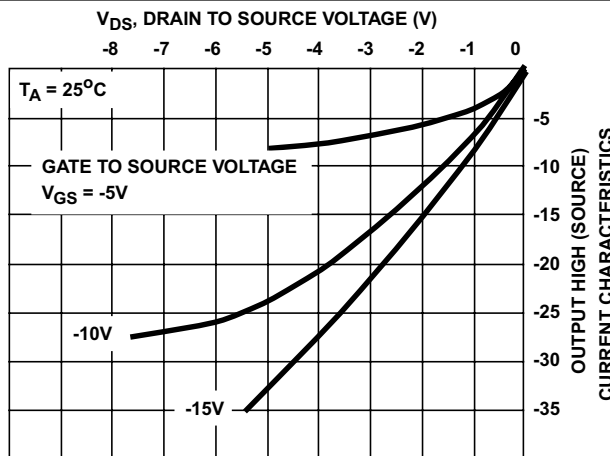

Figure 6-5. Typical Output High (Source) Current Characteristics

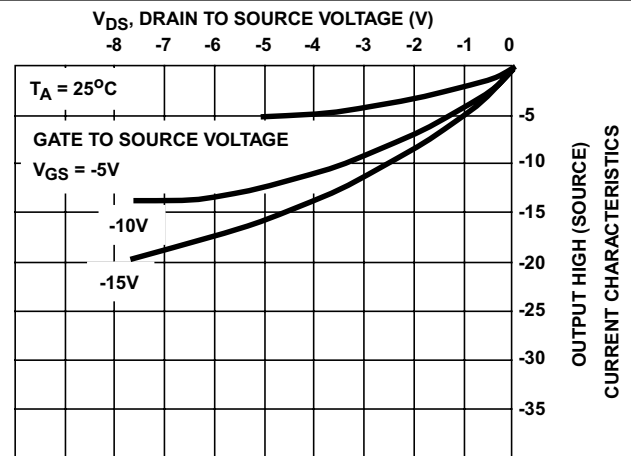

Figure 6-6. Minimum Output High (Source) Current Characteristics

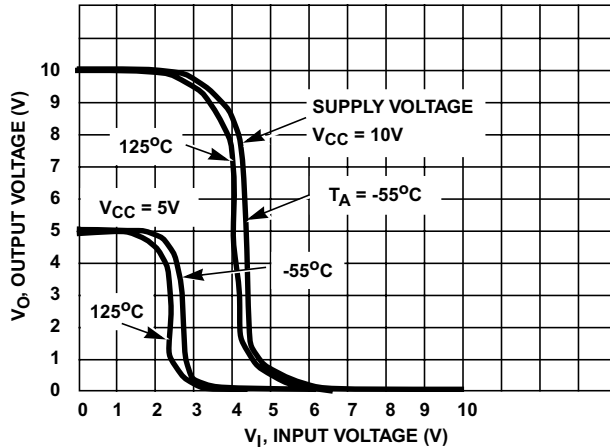

Figure 6-7. Typical Voltage Transfer Characteristics as a Function of Temperature for CD4049UB

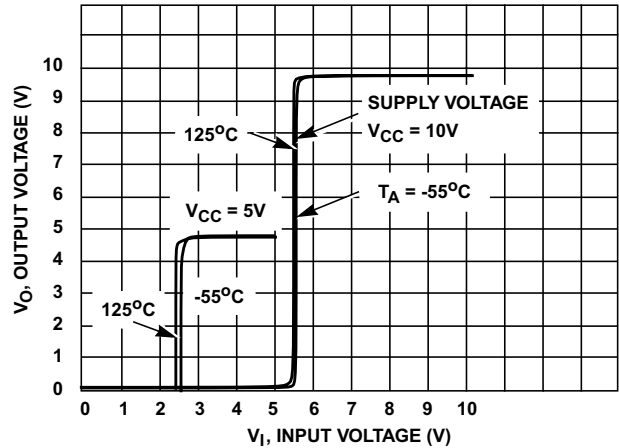

Figure 6-8. Typical Voltage Transfer Characteristics as a Function of Temperature for CD4050B

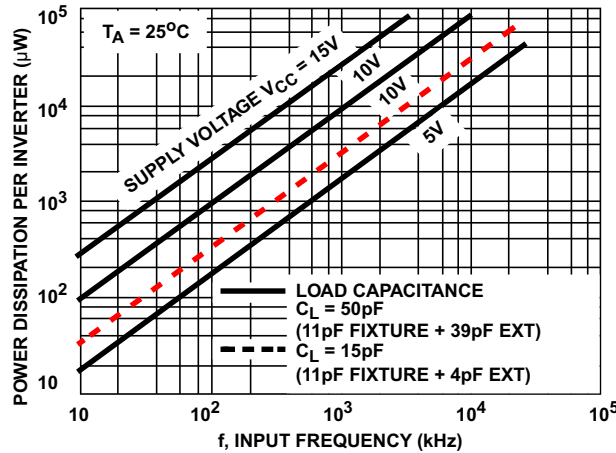

Figure 6-9. Typical Power Dissipation versus Frequency Characteristics

7 Parameter Measurement Information

7.1 Test Circuits

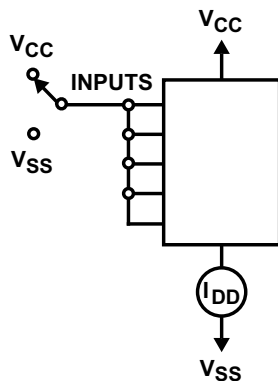
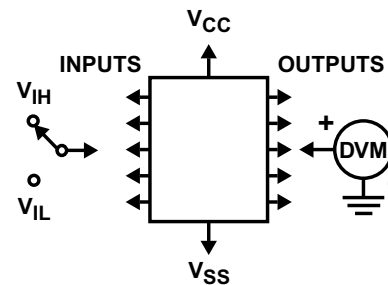

Figure 7-1. Quiescent Device Current Test Circuit



Test any one input with other inputs at V_{CC} or V_{SS}.

Figure 7-2. Input Voltage Test Circuit

CD4049UB, CD4050B

SCHS046K – AUGUST 1998 – REVISED JUNE 2020

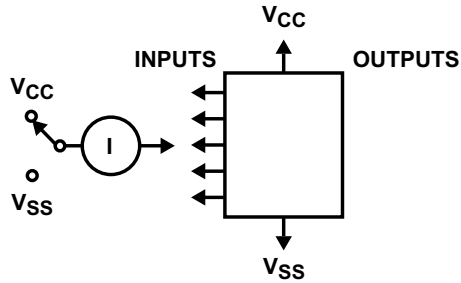

Measure inputs sequentially, to both VCC and VSS connect all unused inputs to either VCC or VSS.

Figure 7-3. Input Current Test Circuit

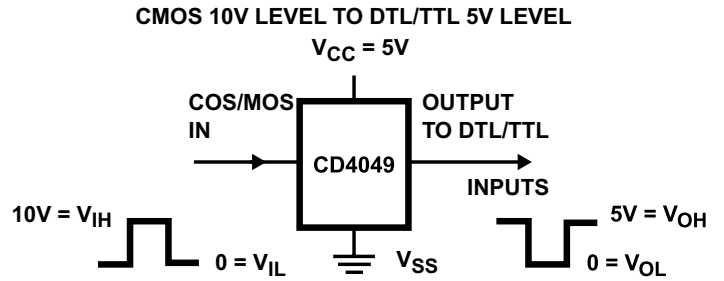

- IN Pin: A, B, C, D, E, or F
- OUT Pin: G, H, I, J, K, or L
- C. VCC Pin
- D. VSS Pin

Figure 7-4. Logic Level Conversion Application

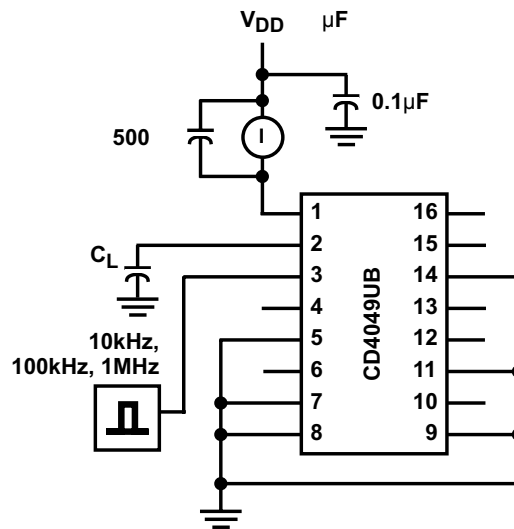

C_L includes fixture capacitance.

Figure 7-5. Dynamic Power Dissipation Test Circuits

8 Detailed Description

8.1 Overview

The CD4049UB device is an inverting hex buffer; the CD4050B device is a noninverting hex buffer. These devices do logic-level conversions and have a high sink current that can drive two TTL loads. These devices also have low input current of 1 μA across the full temperature range at 18 V.

The CD4049UB and CD4050B devices are designated as replacements for CD4009UB and CD4010B devices, respectively. Because the CD4049UB and CD4050B require only one power supply, they are preferred over the CD4009UB and CD4010B and should be used in place of the CD4009UB and CD4010B in all inverter, current driver, or logic-level conversion applications. In these applications the CD4049UB and CD4050B are pin compatible with the CD4009UB and CD4010B respectively, and can be substituted for these devices in existing as well as in new designs. Pin 16 (NC) is not connected internally on the CD4049UB or CD4050B, therefore, connection to this terminal is of no consequence to circuit operation. TI recommends the CD4069UB hex inverter is recommended for applications not requiring high sink-current or voltage conversion.

8.2 Functional Block Diagram

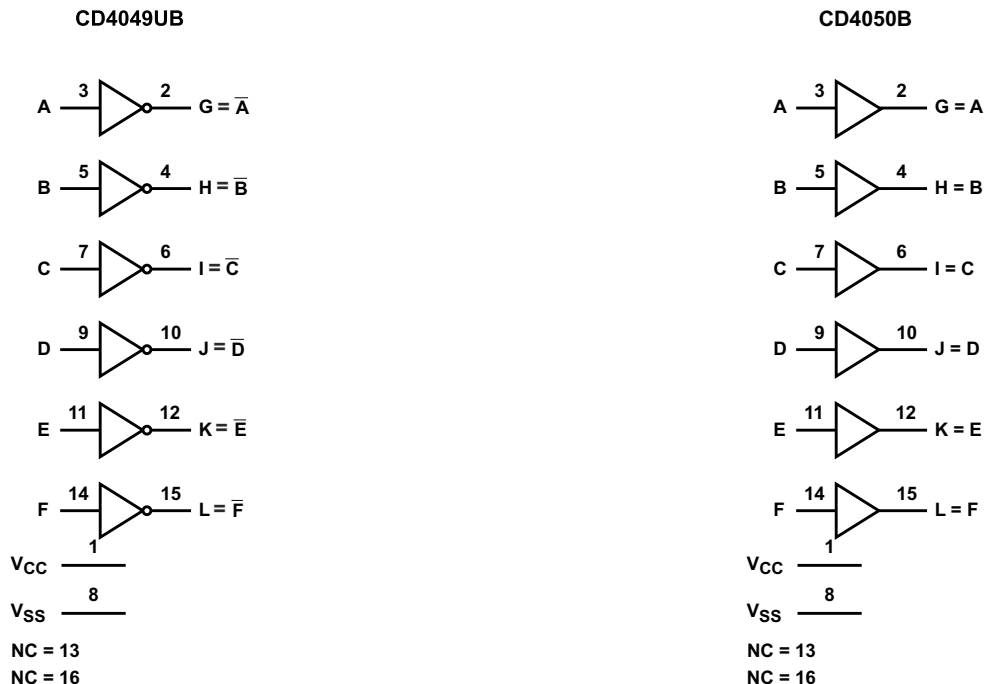

Copyright © 2016, Texas Instruments Incorporated

8.3 Feature Description

CD4049UB and CD4050B have standardized symmetrical output characteristics and a wide operating voltage from 3 V to 18 V with quiescent current tested at 20 V. These devices have transition times of $t_{TLH} = 40$ ns and $t_{THL} = 20$ ns (typical) at 10 V. The operating temperature is from -55°C to 125°C .

8.4 Device Functional Modes

[Table 8-1](#) shows the functional modes for CD4049UB. [Table 8-2](#) shows the functional modes for CD4050B.

**Table 8-1. Function Table for
CD4049UB**

| INPUT A, B, C, D, E, F | OUTPUT G, H, I, J, K, L |
|---------------------------|----------------------------|
| H | L |
| L | H |

**Table 8-2. Function Table for
CD4050B**

| INPUT A, B, C, D, E, F | OUTPUT G, H, I, J, K, L |
|---------------------------|----------------------------|
| H | H |
| L | L |

9 Application and Implementation

Note

Information in the following applications sections is not part of the TI component specification, and TI does not warrant its accuracy or completeness. TI's customers are responsible for determining suitability of components for their purposes. Customers should validate and test their design implementation to confirm system functionality.

9.1 Application Information

The CD4049UB and CD4050B devices have low input currents of 1 μA at 18 V over full package-temperature range and 100 nA at 18 V, 25°C. These devices have a wide operating voltage from 3 V to 18 V and used in high-voltage applications.

9.2 Typical Application

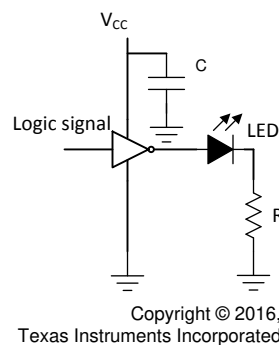

Figure 9-1. CD4049UB Application

9.2.1 Design Requirements

The CD4049UB device is the industry's highest logic inverter operating at 18 V under recommended conditions. These devices have high sink current capabilities.

9.2.2 Detailed Design Procedure

The recommended input conditions for [Figure 9-1](#) includes rise time and fall time specifications (see $\Delta t/\Delta V$ in [Recommended Operating Conditions](#)) and specified high and low levels (see V_{IH} and V_{IL} in [Recommended Operating Conditions](#)). Inputs are not overvoltage tolerant and must be below V_{CC} level because of the presence of input clamp diodes to V_{CC} .

The recommended output condition for the CD4049UB application includes specific load currents. Load currents must be limited so as to not exceed the total power (continuous current through V_{CC} or GND) for the device. These limits are in the [Absolute Maximum Ratings](#). Outputs must not be pulled above V_{CC} .

9.2.3 Application Curves

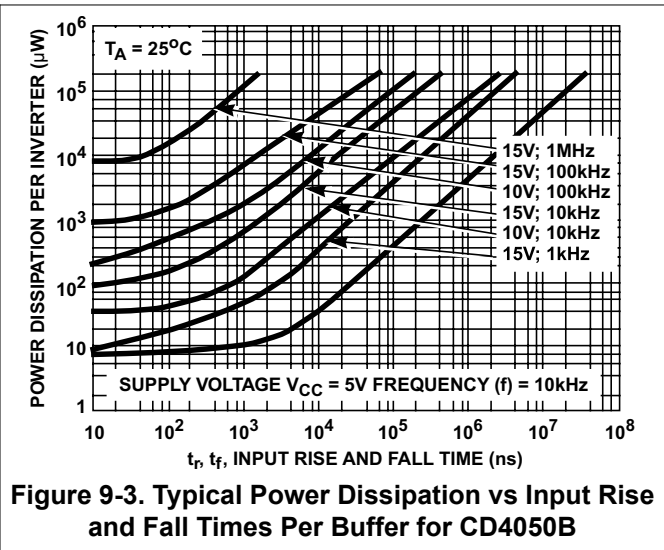
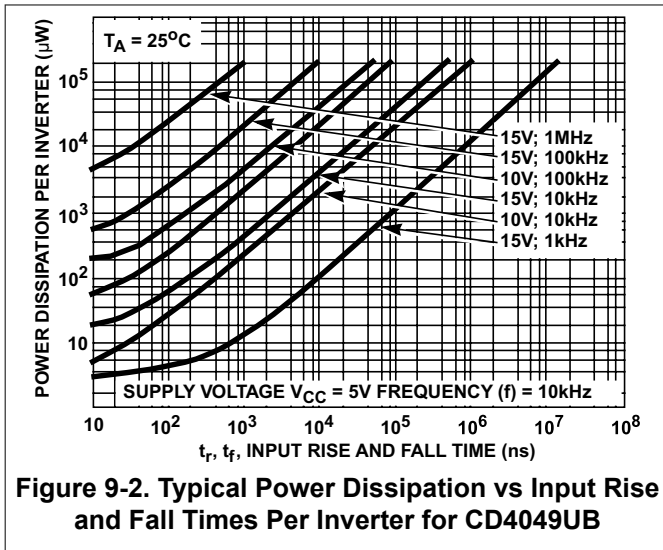

10 Power Supply Recommendations

The power supply can be any voltage between the minimum and maximum supply voltage rating in [Recommended Operating Conditions](#).

Each VCC pin must have a good bypass capacitor to prevent power disturbance. For devices with a single supply, TI recommends a 0.1-µF capacitor. If there are multiple VCC pins, then TI recommends a 0.01-µF or 0.022-µF capacitor for each power pin. It is acceptable to parallel multiple bypass capacitors to reject different frequencies of noise. 0.1-µF and 1-µF capacitors are commonly used in parallel. The bypass capacitor must be installed as close to the power pin as possible for best results.

11 Layout

11.1 Layout Guidelines

When using multiple bit logic devices, inputs must never float.

In many cases, digital logic device functions or parts of these functions are unused (for example, when only two inputs of a triple-input and gate are used, or only 3 of the 4 buffer gates are used). Such input pins must not be left unconnected because the undefined voltages at the outside connections result in undefined operational states. This rule must be observed under all circumstances specified in the next paragraph.

All unused inputs of digital logic devices must be connected to a high or low bias to prevent them from floating. See [Implications of Slow or Floating CMOS Inputs](#) for more information on the effects of floating inputs. The logic level must apply to any particular unused input depending on the function of the device. Generally, they are tied to GND or VCC (whichever is convenient).

11.2 Layout Example

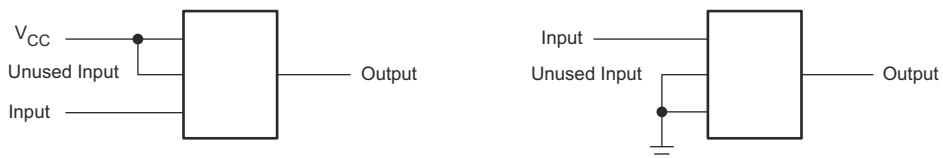

Figure 11-1. Layout Diagram

12 Device and Documentation Support

12.1 Documentation Support

12.1.1 Related Documentation

For related documentation see the following:

[Implications of Slow or Floating CMOS Inputs](#) (SCBA004)

12.2 Related Links

The table below lists quick access links. Categories include technical documents, support and community resources, tools and software, and quick access to sample or buy.

Table 12-1. Related Links

| PARTS | PRODUCT FOLDER | SAMPLE & BUY | TECHNICAL DOCUMENTS | TOOLS & SOFTWARE | SUPPORT & COMMUNITY |
|----------|----------------------------|----------------------------|----------------------------|----------------------------|----------------------------|
| CD4049UB | Click here | Click here | Click here | Click here | Click here |
| CD4050B | Click here | Click here | Click here | Click here | Click here |

12.3 Receiving Notification of Documentation Updates

To receive notification of documentation updates, navigate to the device product folder on ti.com. In the upper right corner, click on *Alert me* to register and receive a weekly digest of any product information that has changed. For change details, review the revision history included in any revised document.

12.4 Support Resources

[TI E2E™ support forums](#) are an engineer's go-to source for fast, verified answers and design help — straight from the experts. Search existing answers or ask your own question to get the quick design help you need.

Linked content is provided "AS IS" by the respective contributors. They do not constitute TI specifications and do not necessarily reflect TI's views; see TI's [Terms of Use](#).

12.5 Trademarks

TI E2E™ is a trademark of Texas Instruments Incorporated.
All other trademarks are the property of their respective owners.

12.6 Electrostatic Discharge Caution



This integrated circuit can be damaged by ESD. Texas Instruments recommends that all integrated circuits be handled with appropriate precautions. Failure to observe proper handling and installation procedures can cause damage.

ESD damage can range from subtle performance degradation to complete device failure. Precision integrated circuits may be more susceptible to damage because very small parametric changes could cause the device not to meet its published specifications.

12.7 Glossary

[TI Glossary](#) This glossary lists and explains terms, acronyms, and definitions.

13 Mechanical, Packaging, and Orderable Information

The following pages include mechanical, packaging, and orderable information. This information is the most current data available for the designated devices. This data is subject to change without notice and revision of this document. For browser-based versions of this data sheet, refer to the left-hand navigation.

PACKAGING INFORMATION

| Orderable Device | Status (1) | Package Type | Package Drawing | Pins | Package Qty | Eco Plan (2) | Lead finish/ Ball material (6) | MSL Peak Temp (3) | Op Temp (°C) | Device Marking (4/5) | Samples |
|------------------|---------------|--------------|-----------------|------|-------------|------------------|--------------------------------------|----------------------|--------------|-------------------------|---------|
| CD4049UBD | OBSOLETE | SOIC | D | 16 | | TBD | Call TI | Call TI | -55 to 125 | CD4049UBM | |
| CD4049UBDR | ACTIVE | SOIC | D | 16 | 2500 | RoHS & Green | NIPDAU | Level-1-260C-UNLIM | -55 to 125 | CD4049UBM | Samples |
| CD4049UBDRE4 | ACTIVE | SOIC | D | 16 | 2500 | RoHS & Green | NIPDAU | Level-1-260C-UNLIM | -55 to 125 | CD4049UBM | Samples |
| CD4049UBDRG4 | ACTIVE | SOIC | D | 16 | 2500 | RoHS & Green | NIPDAU | Level-1-260C-UNLIM | -55 to 125 | CD4049UBM | Samples |
| CD4049UBDT | OBSOLETE | SOIC | D | 16 | | TBD | Call TI | Call TI | -55 to 125 | CD4049UBM | |
| CD4049UBDW | ACTIVE | SOIC | DW | 16 | 40 | RoHS & Green | NIPDAU | Level-1-260C-UNLIM | -55 to 125 | CD4049UBM | Samples |
| CD4049UBDWG4 | ACTIVE | SOIC | DW | 16 | 40 | RoHS & Green | NIPDAU | Level-1-260C-UNLIM | -55 to 125 | CD4049UBM | Samples |
| CD4049UBE | ACTIVE | PDIP | N | 16 | 25 | RoHS & Green | NIPDAU | N / A for Pkg Type | -55 to 125 | CD4049UBE | Samples |
| CD4049UBEE4 | ACTIVE | PDIP | N | 16 | 25 | RoHS & Green | NIPDAU | N / A for Pkg Type | -55 to 125 | CD4049UBE | Samples |
| CD4049UBF | ACTIVE | CDIP | J | 16 | 25 | Non-RoHS & Green | SNPB | N / A for Pkg Type | -55 to 125 | CD4049UBF | Samples |
| CD4049UBF3A | ACTIVE | CDIP | J | 16 | 25 | Non-RoHS & Green | SNPB | N / A for Pkg Type | -55 to 125 | CD4049UBF3A | Samples |
| CD4049UBNSR | ACTIVE | SOP | NS | 16 | 2000 | RoHS & Green | NIPDAU | Level-1-260C-UNLIM | -55 to 125 | CD4049UB | Samples |
| CD4049UBPW | OBSOLETE | TSSOP | PW | 16 | | TBD | Call TI | Call TI | -55 to 125 | CM049UB | |
| CD4049UBPWR | ACTIVE | TSSOP | PW | 16 | 2000 | RoHS & Green | NIPDAU | Level-1-260C-UNLIM | -55 to 125 | CM049UB | Samples |
| CD4050BD | OBSOLETE | SOIC | D | 16 | | TBD | Call TI | Call TI | -55 to 125 | CD4050BM | |
| CD4050BDR | ACTIVE | SOIC | D | 16 | 2500 | RoHS & Green | NIPDAU | Level-1-260C-UNLIM | -55 to 125 | CD4050BM | Samples |
| CD4050BDT | OBSOLETE | SOIC | D | 16 | | TBD | Call TI | Call TI | -55 to 125 | CD4050BM | |
| CD4050BDW | OBSOLETE | SOIC | DW | 16 | | TBD | Call TI | Call TI | -55 to 125 | CD4050BM | |
| CD4050BDWR | ACTIVE | SOIC | DW | 16 | 2000 | RoHS & Green | NIPDAU | Level-1-260C-UNLIM | -55 to 125 | CD4050BM | Samples |
| CD4050BE | ACTIVE | PDIP | N | 16 | 25 | RoHS & Green | NIPDAU | N / A for Pkg Type | -55 to 125 | CD4050BE | Samples |
| CD4050BEE4 | ACTIVE | PDIP | N | 16 | 25 | RoHS & Green | NIPDAU | N / A for Pkg Type | -55 to 125 | CD4050BE | Samples |

| Orderable Device | Status (1) | Package Type | Package Drawing | Pins | Package Qty | Eco Plan (2) | Lead finish/ Ball material (6) | MSL Peak Temp (3) | Op Temp (°C) | Device Marking (4/5) | Samples |
|------------------|---------------|--------------|-----------------|------|-------------|------------------|--------------------------------------|----------------------|--------------|-------------------------|-------------------------|
| CD4050BF | ACTIVE | CDIP | J | 16 | 25 | Non-RoHS & Green | SNPB | N / A for Pkg Type | -55 to 125 | CD4050BF | Samples |
| CD4050BF3A | ACTIVE | CDIP | J | 16 | 25 | Non-RoHS & Green | SNPB | N / A for Pkg Type | -55 to 125 | CD4050BF3A | Samples |
| CD4050BNSR | ACTIVE | SOP | NS | 16 | 2000 | RoHS & Green | NIPDAU | Level-1-260C-UNLIM | -55 to 125 | CD4050B | Samples |
| CD4050BPW | OBSOLETE | TSSOP | PW | 16 | | TBD | Call TI | Call TI | -55 to 125 | CM050B | |
| CD4050BPWR | ACTIVE | TSSOP | PW | 16 | 2000 | RoHS & Green | NIPDAU | Level-1-260C-UNLIM | -55 to 125 | CM050B | Samples |
| JM38510/05553BEA | ACTIVE | CDIP | J | 16 | 25 | Non-RoHS & Green | SNPB | N / A for Pkg Type | -55 to 125 | JM38510/ 05553BEA | Samples |
| JM38510/05554BEA | ACTIVE | CDIP | J | 16 | 25 | Non-RoHS & Green | SNPB | N / A for Pkg Type | -55 to 125 | JM38510/ 05554BEA | Samples |
| M38510/05553BEA | ACTIVE | CDIP | J | 16 | 25 | Non-RoHS & Green | SNPB | N / A for Pkg Type | -55 to 125 | JM38510/ 05553BEA | Samples |
| M38510/05554BEA | ACTIVE | CDIP | J | 16 | 25 | Non-RoHS & Green | SNPB | N / A for Pkg Type | -55 to 125 | JM38510/ 05554BEA | Samples |

(1) The marketing status values are defined as follows:

ACTIVE: Product device recommended for new designs.

LIFEBUY: TI has announced that the device will be discontinued, and a lifetime-buy period is in effect.

NRND: Not recommended for new designs. Device is in production to support existing customers, but TI does not recommend using this part in a new design.

PREVIEW: Device has been announced but is not in production. Samples may or may not be available.

OBSOLETE: TI has discontinued the production of the device.

(2) **RoHS:** TI defines "RoHS" to mean semiconductor products that are compliant with the current EU RoHS requirements for all 10 RoHS substances, including the requirement that RoHS substance do not exceed 0.1% by weight in homogeneous materials. Where designed to be soldered at high temperatures, "RoHS" products are suitable for use in specified lead-free processes. TI may reference these types of products as "Pb-Free".

RoHS Exempt: TI defines "RoHS Exempt" to mean products that contain lead but are compliant with EU RoHS pursuant to a specific EU RoHS exemption.

Green: TI defines "Green" to mean the content of Chlorine (Cl) and Bromine (Br) based flame retardants meet JS709B low halogen requirements of <=1000ppm threshold. Antimony trioxide based flame retardants must also meet the <=1000ppm threshold requirement.

(3) MSL, Peak Temp. - The Moisture Sensitivity Level rating according to the JEDEC industry standard classifications, and peak solder temperature.

(4) There may be additional marking, which relates to the logo, the lot trace code information, or the environmental category on the device.

(5) Multiple Device Markings will be inside parentheses. Only one Device Marking contained in parentheses and separated by a "~" will appear on a device. If a line is indented then it is a continuation of the previous line and the two combined represent the entire Device Marking for that device.

(6) Lead finish/Ball material - Orderable Devices may have multiple material finish options. Finish options are separated by a vertical ruled line. Lead finish/Ball material values may wrap to two lines if the finish value exceeds the maximum column width.

Important Information and Disclaimer:The information provided on this page represents TI's knowledge and belief as of the date that it is provided. TI bases its knowledge and belief on information provided by third parties, and makes no representation or warranty as to the accuracy of such information. Efforts are underway to better integrate information from third parties. TI has taken and continues to take reasonable steps to provide representative and accurate information but may not have conducted destructive testing or chemical analysis on incoming materials and chemicals. TI and TI suppliers consider certain information to be proprietary, and thus CAS numbers and other limited information may not be available for release.

In no event shall TI's liability arising out of such information exceed the total purchase price of the TI part(s) at issue in this document sold by TI to Customer on an annual basis.

OTHER QUALIFIED VERSIONS OF CD4049UB, CD4049UB-MIL, CD4050B, CD4050B-MIL :

- Catalog : [CD4049UB](#), [CD4050B](#)
- Military : [CD4049UB-MIL](#), [CD4050B-MIL](#)

NOTE: Qualified Version Definitions:

- Catalog - TI's standard catalog product
- Military - QML certified for Military and Defense Applications

TAPE AND REEL INFORMATION

QUADRANT ASSIGNMENTS FOR PIN 1 ORIENTATION IN TAPE

*All dimensions are nominal

| Device | Package Type | Package Drawing | Pins | SPQ | Reel Diameter (mm) | Reel Width W1 (mm) | A0 (mm) | B0 (mm) | K0 (mm) | P1 (mm) | W (mm) | Pin1 Quadrant |
|-------------|--------------|-----------------|------|------|--------------------|--------------------|---------|---------|---------|---------|--------|---------------|
| CD4049UBDR | SOIC | D | 16 | 2500 | 330.0 | 16.4 | 6.5 | 10.3 | 2.1 | 8.0 | 16.0 | Q1 |
| CD4049UBNSR | SOP | NS | 16 | 2000 | 330.0 | 16.4 | 8.45 | 10.55 | 2.5 | 12.0 | 16.2 | Q1 |
| CD4049UBPWR | TSSOP | PW | 16 | 2000 | 330.0 | 12.4 | 6.9 | 5.6 | 1.6 | 8.0 | 12.0 | Q1 |
| CD4050BDR | SOIC | D | 16 | 2500 | 330.0 | 16.4 | 6.5 | 10.3 | 2.1 | 8.0 | 16.0 | Q1 |
| CD4050BDWR | SOIC | DW | 16 | 2000 | 330.0 | 16.4 | 10.75 | 10.7 | 2.7 | 12.0 | 16.0 | Q1 |
| CD4050BNSR | SOP | NS | 16 | 2000 | 330.0 | 16.4 | 8.45 | 10.55 | 2.5 | 12.0 | 16.2 | Q1 |
| CD4050BPWR | TSSOP | PW | 16 | 2000 | 330.0 | 12.4 | 6.9 | 5.6 | 1.6 | 8.0 | 12.0 | Q1 |

TAPE AND REEL BOX DIMENSIONS



*All dimensions are nominal

| Device | Package Type | Package Drawing | Pins | SPQ | Length (mm) | Width (mm) | Height (mm) |
|-------------|--------------|-----------------|------|------|-------------|------------|-------------|
| CD4049UBDR | SOIC | D | 16 | 2500 | 353.0 | 353.0 | 32.0 |
| CD4049UBNSR | SOP | NS | 16 | 2000 | 367.0 | 367.0 | 38.0 |
| CD4049UBPWR | TSSOP | PW | 16 | 2000 | 356.0 | 356.0 | 35.0 |
| CD4050BDR | SOIC | D | 16 | 2500 | 353.0 | 353.0 | 32.0 |
| CD4050BDWR | SOIC | DW | 16 | 2000 | 350.0 | 350.0 | 43.0 |
| CD4050BNSR | SOP | NS | 16 | 2000 | 356.0 | 356.0 | 35.0 |
| CD4050BPWR | TSSOP | PW | 16 | 2000 | 356.0 | 356.0 | 35.0 |

TUBE

*All dimensions are nominal

| Device | Package Name | Package Type | Pins | SPQ | L (mm) | W (mm) | T (μm) | B (mm) |
|--------------|--------------|--------------|------|-----|--------|--------|--------|--------|
| CD4049UBDW | DW | SOIC | 16 | 40 | 506.98 | 12.7 | 4826 | 6.6 |
| CD4049UBDWG4 | DW | SOIC | 16 | 40 | 506.98 | 12.7 | 4826 | 6.6 |
| CD4049UBE | N | PDIP | 16 | 25 | 506 | 13.97 | 11230 | 4.32 |
| CD4049UBEE4 | N | PDIP | 16 | 25 | 506 | 13.97 | 11230 | 4.32 |
| CD4050BE | N | PDIP | 16 | 25 | 506 | 13.97 | 11230 | 4.32 |
| CD4050BEE4 | N | PDIP | 16 | 25 | 506 | 13.97 | 11230 | 4.32 |



PACKAGE OUTLINE

NS0016A

SOP - 2.00 mm max height

SOP



4220735/A 12/2021

NOTES:

1. All linear dimensions are in millimeters. Dimensions in parenthesis are for reference only. Dimensioning and tolerancing per ASME Y14.5M.
2. This drawing is subject to change without notice.
3. This dimension does not include mold flash, protrusions, or gate burrs. Mold flash, protrusions, or gate burrs shall not exceed 0.15 mm, per side.
4. This dimension does not include interlead flash. Interlead flash shall not exceed 0.25 mm, per side.

EXAMPLE BOARD LAYOUT

NS0016A

SOP - 2.00 mm max height

SOP



4220735/A 12/2021

NOTES: (continued)

5. Publication IPC-7351 may have alternate designs.

6. Solder mask tolerances between and around signal pads can vary based on board fabrication site.

EXAMPLE STENCIL DESIGN

NS0016A

SOP - 2.00 mm max height

SOP



SOLDER PASTE EXAMPLE
BASED ON 0.125 mm THICK STENCIL
SCALE:7X

4220735/A 12/2021

NOTES: (continued)

7. Laser cutting apertures with trapezoidal walls and rounded corners may offer better paste release. IPC-7525 may have alternate design recommendations.
8. Board assembly site may have different recommendations for stencil design.

D (R-PDSO-G16)

PLASTIC SMALL OUTLINE



- NOTES:
- A. All linear dimensions are in inches (millimeters).
 - B. This drawing is subject to change without notice.
 - C. Body length does not include mold flash, protrusions, or gate burrs. Mold flash, protrusions, or gate burrs shall not exceed 0.006 (0,15) each side.
 - D. Body width does not include interlead flash. Interlead flash shall not exceed 0.017 (0,43) each side.
 - E. Reference JEDEC MS-012 variation AC.



4220204/A 02/2017

NOTES:

1. All linear dimensions are in millimeters. Any dimensions in parenthesis are for reference only. Dimensioning and tolerancing per ASME Y14.5M.
2. This drawing is subject to change without notice.
3. This dimension does not include mold flash, protrusions, or gate burrs. Mold flash, protrusions, or gate burrs shall not exceed 0.15 mm per side.
4. This dimension does not include interlead flash. Interlead flash shall not exceed 0.25 mm per side.
5. Reference JEDEC registration MO-153.

EXAMPLE BOARD LAYOUT

PW0016A

TSSOP - 1.2 mm max height

SMALL OUTLINE PACKAGE



LAND PATTERN EXAMPLE
EXPOSED METAL SHOWN
SCALE: 10X



SOLDER MASK DETAILS

4220204/A 02/2017

NOTES: (continued)

- 6. Publication IPC-7351 may have alternate designs.
- 7. Solder mask tolerances between and around signal pads can vary based on board fabrication site.

EXAMPLE STENCIL DESIGN

PW0016A

TSSOP - 1.2 mm max height

SMALL OUTLINE PACKAGE



SOLDER PASTE EXAMPLE
BASED ON 0.125 mm THICK STENCIL
SCALE: 10X

4220204/A 02/2017

NOTES: (continued)

8. Laser cutting apertures with trapezoidal walls and rounded corners may offer better paste release. IPC-7525 may have alternate design recommendations.
9. Board assembly site may have different recommendations for stencil design.

MECHANICAL DATA

NS (R-PDSO-G**)

PLASTIC SMALL-OUTLINE PACKAGE

14-PINS SHOWN



- NOTES:
- A. All linear dimensions are in millimeters.
 - B. This drawing is subject to change without notice.
 - C. Body dimensions do not include mold flash or protrusion, not to exceed 0,15.

GENERIC PACKAGE VIEW

DW 16

SOIC - 2.65 mm max height

7.5 x 10.3, 1.27 mm pitch

SMALL OUTLINE INTEGRATED CIRCUIT

This image is a representation of the package family, actual package may vary.
Refer to the product data sheet for package details.



4224780/A



DW0016A

PACKAGE OUTLINE SOIC - 2.65 mm max height

SOIC



NOTES:

1. All linear dimensions are in millimeters. Dimensions in parenthesis are for reference only. Dimensioning and tolerancing per ASME Y14.5M.
2. This drawing is subject to change without notice.
3. This dimension does not include mold flash, protrusions, or gate burrs. Mold flash, protrusions, or gate burrs shall not exceed 0.15 mm, per side.
4. This dimension does not include interlead flash. Interlead flash shall not exceed 0.25 mm, per side.
5. Reference JEDEC registration MS-013.

EXAMPLE BOARD LAYOUT

DW0016A

SOIC - 2.65 mm max height

SOIC

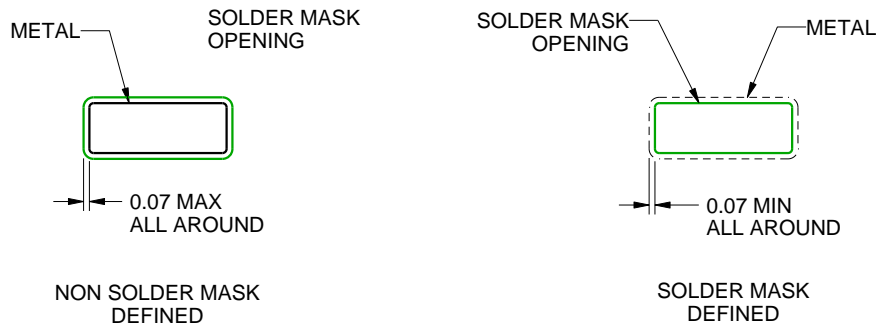

SOLDER MASK DETAILS

4220721/A 07/2016

NOTES: (continued)

6. Publication IPC-7351 may have alternate designs.

7. Solder mask tolerances between and around signal pads can vary based on board fabrication site.

EXAMPLE STENCIL DESIGN

DW0016A

SOIC - 2.65 mm max height

SOIC



SOLDER PASTE EXAMPLE
BASED ON 0.125 mm THICK STENCIL
SCALE:7X

4220721/A 07/2016

NOTES: (continued)

8. Laser cutting apertures with trapezoidal walls and rounded corners may offer better paste release. IPC-7525 may have alternate design recommendations.
9. Board assembly site may have different recommendations for stencil design.

J (R-GDIP-T**)

14 LEADS SHOWN

CERAMIC DUAL IN-LINE PACKAGE



| DIM \ PINS ** | 14 | 16 | 18 | 20 |
|---------------|------------------------|------------------------|------------------------|------------------------|
| A | 0.300 (7,62) BSC | 0.300 (7,62) BSC | 0.300 (7,62) BSC | 0.300 (7,62) BSC |
| B MAX | 0.785 (19,94) | .840 (21,34) | 0.960 (24,38) | 1.060 (26,92) |
| B MIN | — | — | — | — |
| C MAX | 0.300 (7,62) | 0.300 (7,62) | 0.310 (7,87) | 0.300 (7,62) |
| C MIN | 0.245 (6,22) | 0.245 (6,22) | 0.220 (5,59) | 0.245 (6,22) |



4040083/F 03/03

- NOTES:
- All linear dimensions are in inches (millimeters).
 - This drawing is subject to change without notice.
 - This package is hermetically sealed with a ceramic lid using glass frit.
 - Index point is provided on cap for terminal identification only on press ceramic glass frit seal only.
 - Falls within MIL STD 1835 GDIP1-T14, GDIP1-T16, GDIP1-T18 and GDIP1-T20.

N (R-PDIP-T**)

PLASTIC DUAL-IN-LINE PACKAGE

16 PINS SHOWN



- NOTES:
- A. All linear dimensions are in inches (millimeters).
 - B. This drawing is subject to change without notice.
 - Falls within JEDEC MS-001, except 18 and 20 pin minimum body length (Dim A).
 - The 20 pin end lead shoulder width is a vendor option, either half or full width.

IMPORTANT NOTICE AND DISCLAIMER

TI PROVIDES TECHNICAL AND RELIABILITY DATA (INCLUDING DATA SHEETS), DESIGN RESOURCES (INCLUDING REFERENCE DESIGNS), APPLICATION OR OTHER DESIGN ADVICE, WEB TOOLS, SAFETY INFORMATION, AND OTHER RESOURCES "AS IS" AND WITH ALL FAULTS, AND DISCLAIMS ALL WARRANTIES, EXPRESS AND IMPLIED, INCLUDING WITHOUT LIMITATION ANY IMPLIED WARRANTIES OF MERCHANTABILITY, FITNESS FOR A PARTICULAR PURPOSE OR NON-INFRINGEMENT OF THIRD PARTY INTELLECTUAL PROPERTY RIGHTS.

These resources are intended for skilled developers designing with TI products. You are solely responsible for (1) selecting the appropriate TI products for your application, (2) designing, validating and testing your application, and (3) ensuring your application meets applicable standards, and any other safety, security, regulatory or other requirements.

These resources are subject to change without notice. TI grants you permission to use these resources only for development of an application that uses the TI products described in the resource. Other reproduction and display of these resources is prohibited. No license is granted to any other TI intellectual property right or to any third party intellectual property right. TI disclaims responsibility for, and you will fully indemnify TI and its representatives against, any claims, damages, costs, losses, and liabilities arising out of your use of these resources.

TI's products are provided subject to [TI's Terms of Sale](#) or other applicable terms available either on [ti.com](https://www.ti.com) or provided in conjunction with such TI products. TI's provision of these resources does not expand or otherwise alter TI's applicable warranties or warranty disclaimers for TI products.

TI objects to and rejects any additional or different terms you may have proposed.

Mailing Address: Texas Instruments, Post Office Box 655303, Dallas, Texas 75265
Copyright © 2024, Texas Instruments Incorporated