

ESD321 1-Channel 30 kV ESD Protection Diode with Low Capacitance (< 1 pF) in 0402 and SOD-523 Packages

1 Features

- IEC 61000-4-2 Level 4 ESD protection:
 - ±30-kV contact discharge
 - ±30-kV air gap discharge
- IEC 61000-4-4 EFT protection:
 - 80 A (5/50 ns)
- IEC 61000-4-5 surge protection:
 - 6 A (8/20 μs)
- IO capacitance: 0.9 pF (typical)
- DC breakdown voltage: 4.5 V (minimum)
- Low leakage current: 0.1 nA (typical)
- Extremely Low ESD clamping voltage:
 - 6.8 V at 16 A TLP (I/O to GND)
 - R_{DYN} : 0.13 Ω (I/O to GND)
- Industrial temperature range: –40°C to +125°C
- Industry standard 0402 (DFN1006P2) and SOD-523 packages

2 Applications

- End equipment:
 - [Wearables](#)
 - [Industrial and service robots](#)
 - [Laptops and desktops](#)
 - [Mobile and tablets](#)
 - [Set-top boxes](#)
 - [DVR and NVR](#)
 - [TV and monitors](#)
 - [EPOS \(electronic point of sale\)](#)
- Interfaces:
 - USB 2.0/1.1
 - GPIO
 - Ethernet 10/100/1000 Mbps
 - Pushbuttons
 - [Audio](#)

3 Description

The ESD321 is a uni-directional TVS ESD protection diode featuring low dynamic resistance and low clamping voltage. The ESD321 is rated to dissipate ESD strikes up to ±30 kV per the IEC 61000-4-2 international standard (greater than Level 4).

The ultra-low dynamic resistance (0.13 Ω) and extremely low clamping voltage (6.8 V at 16 A TLP) ensure system level protection against transient events. This device has a low capacitance of 0.9 pF IO capacitance making it suitable for protecting interfaces such as USB 2.0 and Ethernet 10/100/1000 Mbps.

The ESD321 is offered in the industry standard 0402 (DPY/DFN1006P2) and SOD-523 (DYA) packages.

Package Information

| PART NUMBER | PACKAGE ⁽¹⁾ | PACKAGE SIZE ⁽²⁾ |
|-------------|------------------------|-----------------------------|
| ESD321 | DPY (X1SON, 2) | 1 mm × 0.6 mm |
| | DYA (SOD-523, 2) | 1.6 mm × 0.8 mm |

- (1) For all available packages, see the orderable addendum at the end of the data sheet.
- (2) The package size (length × width) is a nominal value and includes pins, where applicable.

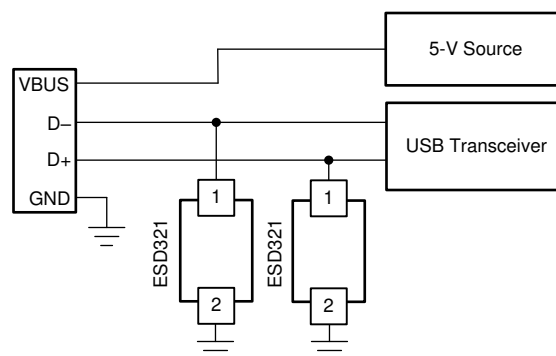

Typical USB 2.0 Application Schematic



Table of Contents

| | | | |
|--|---|--|----|
| 1 Features | 1 | 7.3 Feature Description..... | 8 |
| 2 Applications | 1 | 7.4 Device Functional Modes..... | 8 |
| 3 Description | 1 | 8 Application and Implementation | 9 |
| 4 Revision History | 2 | 8.1 Application Information..... | 9 |
| 5 Pin Configuration and Functions | 3 | 8.2 Typical Application..... | 9 |
| 6 Specifications | 4 | 8.3 Power Supply Recommendations..... | 10 |
| 6.1 Absolute Maximum Ratings..... | 4 | 8.4 Layout..... | 10 |
| 6.2 ESD Ratings – JEDEC Specifications..... | 4 | 9 Device and Documentation Support | 12 |
| 6.3 ESD Ratings – IEC Specifications..... | 4 | 9.1 Documentation Support..... | 12 |
| 6.4 Recommended Operating Conditions..... | 4 | 9.2 Receiving Notification of Documentation Updates.... | 12 |
| 6.5 Thermal Information..... | 4 | 9.3 Support Resources..... | 12 |
| 6.6 Electrical Characteristics..... | 5 | 9.4 Trademarks..... | 12 |
| 6.7 Typical Characteristics..... | 6 | 9.5 Electrostatic Discharge Caution..... | 12 |
| 7 Detailed Description | 8 | 9.6 Glossary..... | 12 |
| 7.1 Overview..... | 8 | 10 Mechanical, Packaging, and Orderable Information | 12 |
| 7.2 Functional Block Diagram..... | 8 | | |

4 Revision History

NOTE: Page numbers for previous revisions may differ from page numbers in the current version.

Changes from Revision A (December 2022) to Revision B (October 2023) Page

- Updated the *Package Information* table to include package size..... 1
- Changed voltage to power in the *Surge Curve* (IEC 61000-4-5, $t_p=8/20 \mu s$), *I/O Pin to GND* figure..... 6

Changes from Revision * (July 2018) to Revision A (December 2022) Page

- Updated the numbering format for tables, figures, and cross-references throughout the document..... 1
- Added the *DYA* package to the data sheet..... 1

5 Pin Configuration and Functions

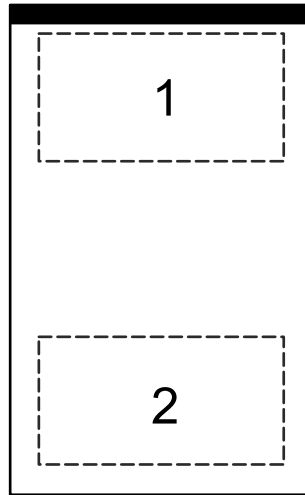

Figure 5-1. DPY Package, 2-Pin X1SON (Top View)

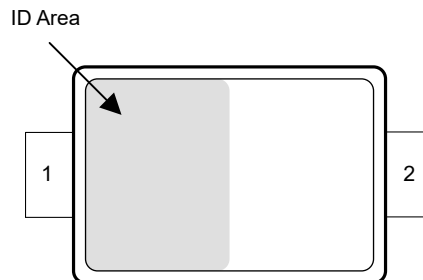

Figure 5-2. DYA Package, 2-Pin SOD-523 (Top View)

Table 5-1. Pin Functions

| NAME | PIN | | TYPE ⁽¹⁾ | DESCRIPTION |
|------|-----|-----|---------------------|---|
| | NO. | | | |
| | DPY | DYA | | |
| IO | 1 | 2 | I/O | ESD Protected Channel. Connect to the line being protected. |
| GND | 2 | 1 | GND | Connect to ground |

(1) I = input, O = output, GND = ground

6 Specifications

6.1 Absolute Maximum Ratings

over operating free-air temperature range (unless otherwise noted)⁽¹⁾

| | | MIN | MAX | UNIT |
|---------------------------|--|-----|-----|------|
| Electrical Fast Transient | IEC 61000-4-4 Peak Current at 25 °C | | 80 | A |
| Surge Pulse | IEC 61000-4-5 Surge (tp 8/20 μs) Peak Power at 25 °C | | 40 | W |
| | IEC 61000-4-5 Surge (tp 8/20 μs) Peak Current at 25 °C | | 6 | A |
| T _A | Operating free-air temperature | –40 | 125 | °C |
| T _{stg} | Storage temperature | –65 | 155 | °C |

- (1) Stresses beyond those listed under *Absolute Maximum Rating* may cause permanent damage to the device. These are stress ratings only, which do not imply functional operation of the device at these or any other conditions beyond those indicated under *Recommended Operating Condition*. Exposure to absolute-maximum-rated conditions for extended periods may affect device reliability.

6.2 ESD Ratings – JEDEC Specifications

| | | VALUE | UNIT |
|--------------------|-------------------------|--|-------|
| V _(ESD) | Electrostatic discharge | Human body model (HBM), per ANSI/ESDA/JEDEC JS-001, all pins ⁽¹⁾ | ±2500 |
| | | Charged device model (CDM), per JEDEC specification JESD22-C101, all pins ⁽²⁾ | ±1000 |

- (1) JEDEC document JEP155 states that 500-V HBM allows safe manufacturing with a standard ESD control process.
 (2) JEDEC document JEP157 states that 250-V CDM allows safe manufacturing with a standard ESD control process.

6.3 ESD Ratings – IEC Specifications

| | | VALUE | UNIT |
|--------------------|-------------------------|---|--------|
| V _(ESD) | Electrostatic discharge | IEC 61000-4-2 Contact Discharge, all pins | ±30000 |
| | | IEC 61000-4-2 Air Discharge, all pins | ±30000 |

6.4 Recommended Operating Conditions

over operating free-air temperature range (unless otherwise noted)

| | | MIN | NOM | MAX | UNIT |
|-----------------|--------------------------------|-----|-----|-----|------|
| V _{IN} | Input voltage | 0 | | 3.6 | V |
| T _A | Operating Free Air Temperature | –40 | | 125 | °C |

6.5 Thermal Information

| THERMAL METRIC ⁽¹⁾ | | ESD321 | | UNIT |
|-------------------------------|--|---------------|-------------|------|
| | | DYA (SOD-523) | DPY (X1SON) | |
| | | 2 Pins | 2 Pins | |
| R _{θJA} | Junction-to-ambient thermal resistance | 774.7 | 437.8 | °C/W |
| R _{θJC(top)} | Junction-to-case (top) thermal resistance | 462.3 | 249.5 | °C/W |
| R _{θJB} | Junction-to-board thermal resistance | 541.1 | 169.2 | °C/W |
| Ψ _{JT} | Junction-to-top characterization parameter | 164.4 | 99.3 | °C/W |
| Ψ _{JB} | Junction-to-board characterization parameter | 534.6 | 168.6 | °C/W |

- (1) For more information about traditional and new thermal metrics, see the [Semiconductor and IC Package Thermal Metrics](#) application report.

6.6 Electrical Characteristics

At TA = 25°C unless otherwise noted

| PARAMETER | | TEST CONDITIONS | MIN | TYP | MAX | UNIT |
|----------------------|--|---|-----|------|-----|------|
| V _{RWM} | Reverse stand-off voltage | I _{IO} < 50 nA, across operating temperature range | | | 3.6 | V |
| I _{LEAKAGE} | Leakage current at 3.6 V | V _{IO} = 3.6 V, I/O to GND | | 0.1 | 10 | nA |
| V _{BRF} | Breakdown voltage, I/O to GND ⁽¹⁾ | I _{IO} = 1 mA | 4.5 | | 7.5 | V |
| V _{FWD} | Forward Voltage, GND to I/O ⁽¹⁾ | I _{IO} = 1 mA | | 0.8 | | V |
| V _{HOLD} | Holding voltage, I/O to GND ⁽²⁾ | I _{IO} = 1 mA | | 5.1 | | V |
| V _{CLAMP} | Clamping voltage | I _{PP} = 6 A (8/20 μs Surge), I/O to GND | | 6.3 | | V |
| | | I _{PP} = 16 A (100 ns TLP), I/O to GND | | 6.8 | | V |
| | | I _{PP} = 16 A (100 ns TLP), GND to I/O | | 4.7 | | V |
| R _{DYN} | Dynamic resistance | I/O to GND, 100 ns TLP, between 10 to 20 A I _{PP} | | 0.13 | | Ω |
| | | GND to I/O, 100 ns TLP, between 10 to 20 A I _{PP} | | 0.2 | | |
| C _{LINE} | Line capacitance, IO to GND | V _{IO} = 0 V, V _{p-p} = 30 mV, f = 1 MHz | | 0.9 | 1.1 | pF |

- (1) V_{BRF} and V_{BRR} are defined as the voltage obtained at 1 mA when sweeping the voltage up, before the device latches into the snapback state
- (2) V_{HOLD} is defined as the voltage when 1 mA is applied, after the device has successfully latched into the snapback state.

6.7 Typical Characteristics

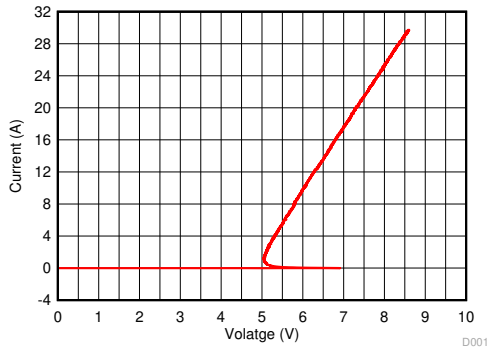

D001_TLP_IO_GND.grf

Figure 6-1. TLP I-V Curve, I/O Pin to GND ($t_p = 100$ ns)

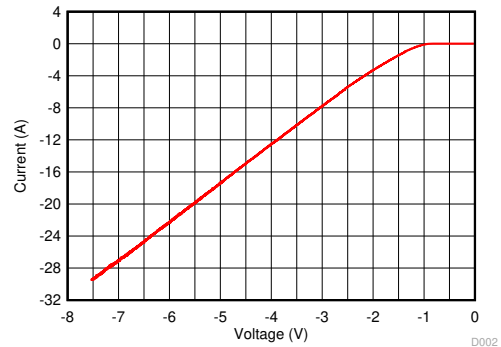

D002_TLP_GND_IO.grf

Figure 6-2. TLP I-V Curve, GND to I/O Pin ($t_p = 100$ ns)

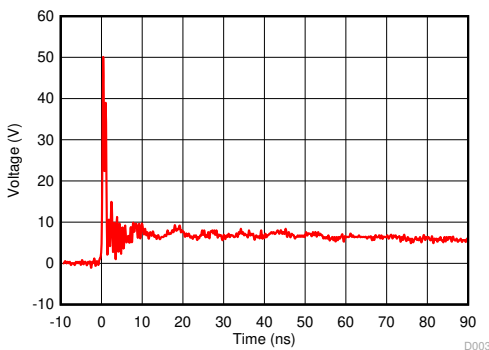

D003_8kV_pos.grf

Figure 6-3. 8-kV IEC 61000-4-2 Clamping Voltage Waveform, I/O Pin to GND

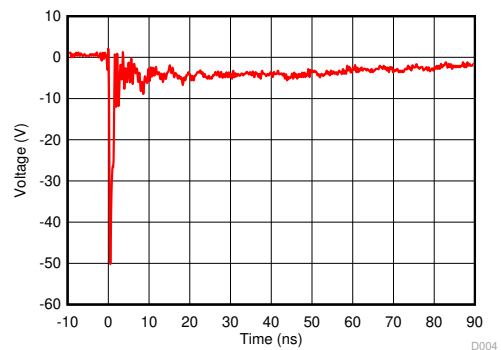

D004_8kV_neg.grf

Figure 6-4. 8-kV IEC 61000-4-2 Clamping Voltage Waveform, GND to I/O Pin

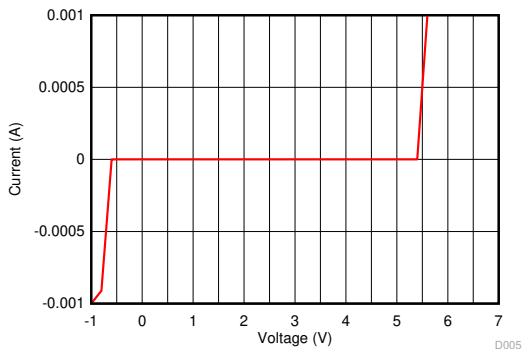

D005_DC_Plot.grf

Figure 6-5. DC Voltage Sweep I-V Curve, I/O Pin to GND

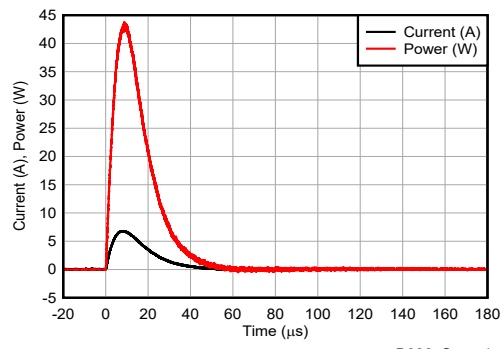

D006_Surge1.grf

Figure 6-6. Surge Curve (IEC 61000-4-5, $t_p=8/20$ μ s), I/O Pin to GND

6.7 Typical Characteristics (continued)

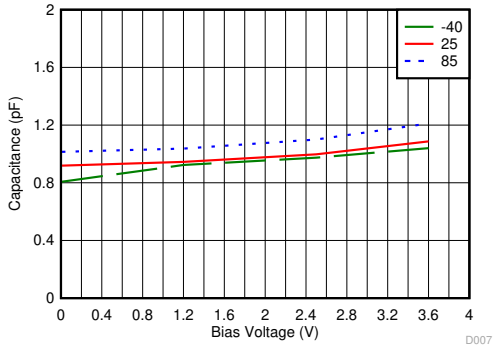

Figure 6-7. Capacitance vs. Bias Voltage For Different Temperatures (°C)

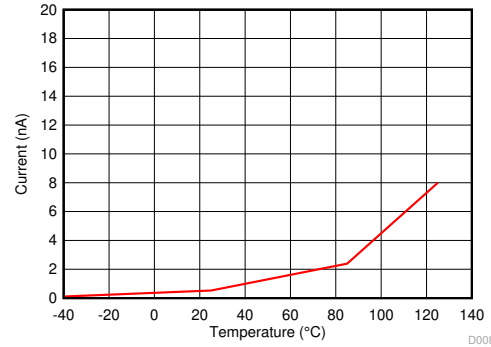

Figure 6-8. Leakage Current (at 3.6 V Bias) Across Temperature, I/O Pin to GND

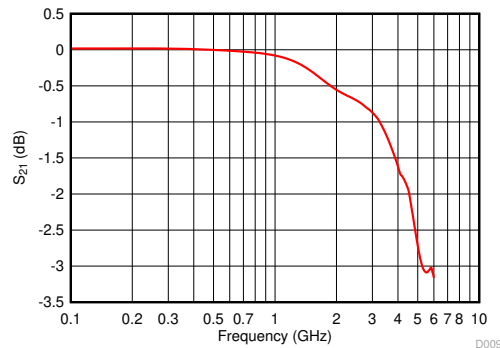

Figure 6-9. Insertion Loss vs. Frequency

7 Detailed Description

7.1 Overview

The ESD321 is a low capacitance uni-directional ESD Protection Diode with a low clamping voltage. This device can dissipate ESD strikes up to ± 30 kV (Contact and Air) per the IEC 61000-4-2 Standard. The low clamping makes this device suitable for protecting any ESD sensitive devices.

7.2 Functional Block Diagram



7.3 Feature Description

ESD321 provides ESD protection up to ± 30 -kV contact and ± 30 -kV air gap per IEC 61000-4-2 standard. During an ESD event, ESD diode connected to the I/O pin turns on and diverts the current to ground. Additionally, ESD321 also provides protection against IEC 61000-4-5 Surge currents up to 6 A (8/20 μ s waveform) and up to 80 A per IEC 61000-4-4 (5/50 ns waveform, 4 kV with 50- Ω impedance) electrical fast transient (EFT) standard. The capacitance between the I/O pin and ground is 0.9 pF (typical) and 1.1 pF (maximum). The device features a low leakage current of 0.1 nA (typical) and 50 nA (maximum, across operating temperature range) with a bias of 3.6 V. The ESD diode at the I/O pin protects the ESD-sensitive devices by clamping the voltage to a low value of 6.8 V ($I_{PP} = 16$ A 100 ns TLP). The layout of this device makes it simple and easy to add protection to an existing layout. The package offers flow-through routing, requiring minimal modification to an existing layout.

7.4 Device Functional Modes

The ESD321 is a passive integrated circuit that triggers when voltages are above V_{BRF} or below V_{FWD} . During ESD events, voltages as high as ± 30 kV (contact or air) can be directed to ground via the internal diode network. When the voltages on the protected line fall below the trigger levels of ESD321 (usually within 10s of nano-seconds) the device reverts to passive.

8 Application and Implementation

Note

Information in the following applications sections is not part of the TI component specification, and TI does not warrant its accuracy or completeness. TI's customers are responsible for determining suitability of components for their purposes, as well as validating and testing their design implementation to confirm system functionality.

8.1 Application Information

The ESD321 is a diode type TVS which is used to provide a path to ground for dissipating ESD events on high-speed signal lines between a human interface connector and a system. As the current from ESD passes through the TVS, only a small voltage drop is present across the diode. This is the voltage presented to the protected IC. The low R_{DYN} of the triggered TVS holds this voltage, V_{CLAMP} , to a safe level for the protected IC.

8.2 Typical Application

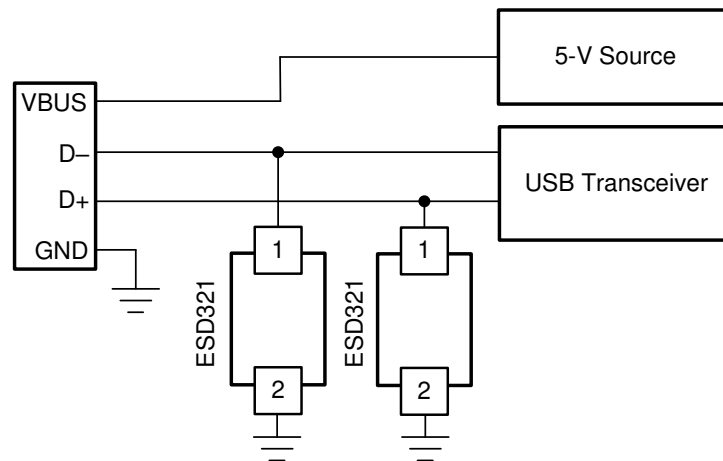

Figure 8-1. USB 2.0 ESD Schematic

8.2.1 Design Requirements

For this design example, two ESD321 devices are being used in a USB 2.0 application. This provides a complete ESD protection scheme.

Given the USB 2.0 application, the parameters listed in [Table 8-1](#) are known.

Table 8-1. Design Parameters

| DESIGN PARAMETER | VALUE |
|------------------------------------|---------------|
| Signal range on DP-DM lines | 0 V to 3.6 V |
| Operating frequency on DP-DM lines | up to 240 MHz |

8.2.2 Detailed Design Procedure

8.2.2.1 Signal Range

The ESD321 supports signal ranges between 0 V and 3.6 V, which supports the USB 2.0 signal pair on the USB 2.0 application.

8.2.2.2 Operating Frequency

The ESD321 has a 0.9 pF (typical) capacitance, which supports the USB 2.0 data rates of 480 Mbps.

8.2.3 Application Curve

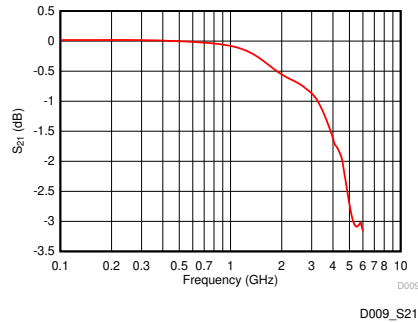

Figure 8-2. Insertion Loss Vs. Frequency

8.3 Power Supply Recommendations

The ESD321 is a passive ESD device so there is no need to power it. Take care not to violate the recommended I/O specification (0 V to 3.6 V) to ensure the device functions properly.

8.4 Layout

8.4.1 Layout Guidelines

- The optimum placement is as close to the connector as possible.
 - EMI during an ESD event can couple from the trace being struck to other nearby unprotected traces, resulting in early system failures.
 - The PCB designer must minimize the possibility of EMI coupling by keeping any unprotected traces away from the protected traces which are between the TVS and the connector.
- Route the protected traces as straight as possible.
- Eliminate any sharp corners on the protected traces between the TVS and the connector by using rounded corners with the largest radii possible.
 - Electric fields tend to build up on corners, increasing EMI coupling.

8.4.2 Layout Example

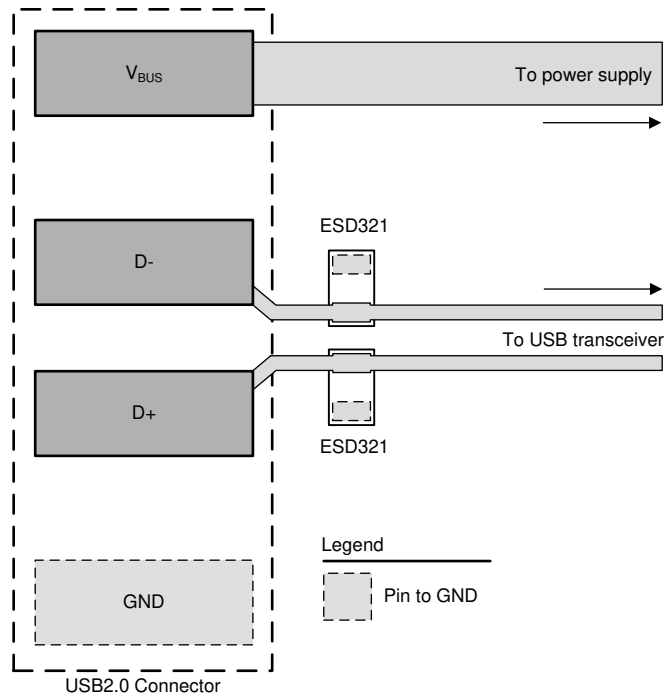

Figure 8-3. USB 2.0 ESD Layout

9 Device and Documentation Support

9.1 Documentation Support

9.1.1 Related Documentation

For related documentation, see the following:

- Texas Instruments, [Generic ESD Device Evaluation Module](#)

9.2 Receiving Notification of Documentation Updates

To receive notification of documentation updates, navigate to the device product folder on [ti.com](#). Click on *Notifications* to register and receive a weekly digest of any product information that has changed. For change details, review the revision history included in any revised document.

9.3 Support Resources

[TI E2E™ support forums](#) are an engineer's go-to source for fast, verified answers and design help — straight from the experts. Search existing answers or ask your own question to get the quick design help you need.

Linked content is provided "AS IS" by the respective contributors. They do not constitute TI specifications and do not necessarily reflect TI's views; see TI's [Terms of Use](#).

9.4 Trademarks

TI E2E™ is a trademark of Texas Instruments.

All trademarks are the property of their respective owners.

9.5 Electrostatic Discharge Caution



This integrated circuit can be damaged by ESD. Texas Instruments recommends that all integrated circuits be handled with appropriate precautions. Failure to observe proper handling and installation procedures can cause damage.

ESD damage can range from subtle performance degradation to complete device failure. Precision integrated circuits may be more susceptible to damage because very small parametric changes could cause the device not to meet its published specifications.

9.6 Glossary

[TI Glossary](#) This glossary lists and explains terms, acronyms, and definitions.

10 Mechanical, Packaging, and Orderable Information

The following pages include mechanical, packaging, and orderable information. This information is the most current data available for the designated devices. This data is subject to change without notice and revision of this document. For browser-based versions of this data sheet, refer to the left-hand navigation.

PACKAGING INFORMATION

| Orderable Device | Status (1) | Package Type | Package Drawing | Pins | Package Qty | Eco Plan (2) | Lead finish/ Ball material (6) | MSL Peak Temp (3) | Op Temp (°C) | Device Marking (4/5) | Samples |
|------------------|---------------|--------------|-----------------|------|-------------|-----------------|--------------------------------------|----------------------|--------------|-------------------------|-------------------------|
| ESD321DPYR | ACTIVE | X1SON | DPY | 2 | 10000 | RoHS & Green | NIPDAU | Level-1-260C-UNLIM | -40 to 125 | (A5, DD) | Samples |
| ESD321DYAR | ACTIVE | SOT-5X3 | DYA | 2 | 3000 | RoHS & Green | SN | Level-3-260C-168 HR | -55 to 150 | 1L8 | Samples |

(1) The marketing status values are defined as follows:

ACTIVE: Product device recommended for new designs.

LIFEBUY: TI has announced that the device will be discontinued, and a lifetime-buy period is in effect.

NRND: Not recommended for new designs. Device is in production to support existing customers, but TI does not recommend using this part in a new design.

PREVIEW: Device has been announced but is not in production. Samples may or may not be available.

OBSOLETE: TI has discontinued the production of the device.

(2) **RoHS:** TI defines "RoHS" to mean semiconductor products that are compliant with the current EU RoHS requirements for all 10 RoHS substances, including the requirement that RoHS substance do not exceed 0.1% by weight in homogeneous materials. Where designed to be soldered at high temperatures, "RoHS" products are suitable for use in specified lead-free processes. TI may reference these types of products as "Pb-Free".

RoHS Exempt: TI defines "RoHS Exempt" to mean products that contain lead but are compliant with EU RoHS pursuant to a specific EU RoHS exemption.

Green: TI defines "Green" to mean the content of Chlorine (Cl) and Bromine (Br) based flame retardants meet JS709B low halogen requirements of <=1000ppm threshold. Antimony trioxide based flame retardants must also meet the <=1000ppm threshold requirement.

(3) MSL, Peak Temp. - The Moisture Sensitivity Level rating according to the JEDEC industry standard classifications, and peak solder temperature.

(4) There may be additional marking, which relates to the logo, the lot trace code information, or the environmental category on the device.

(5) Multiple Device Markings will be inside parentheses. Only one Device Marking contained in parentheses and separated by a "~" will appear on a device. If a line is indented then it is a continuation of the previous line and the two combined represent the entire Device Marking for that device.

(6) Lead finish/Ball material - Orderable Devices may have multiple material finish options. Finish options are separated by a vertical ruled line. Lead finish/Ball material values may wrap to two lines if the finish value exceeds the maximum column width.

Important Information and Disclaimer:The information provided on this page represents TI's knowledge and belief as of the date that it is provided. TI bases its knowledge and belief on information provided by third parties, and makes no representation or warranty as to the accuracy of such information. Efforts are underway to better integrate information from third parties. TI has taken and continues to take reasonable steps to provide representative and accurate information but may not have conducted destructive testing or chemical analysis on incoming materials and chemicals. TI and TI suppliers consider certain information to be proprietary, and thus CAS numbers and other limited information may not be available for release.

In no event shall TI's liability arising out of such information exceed the total purchase price of the TI part(s) at issue in this document sold by TI to Customer on an annual basis.

TAPE AND REEL INFORMATION

QUADRANT ASSIGNMENTS FOR PIN 1 ORIENTATION IN TAPE

*All dimensions are nominal

| Device | Package Type | Package Drawing | Pins | SPQ | Reel Diameter (mm) | Reel Width W1 (mm) | A0 (mm) | B0 (mm) | K0 (mm) | P1 (mm) | W (mm) | Pin1 Quadrant |
|------------|--------------|-----------------|------|------|--------------------|--------------------|---------|---------|---------|---------|--------|---------------|
| ESD321DYAR | SOT-5X3 | DYA | 2 | 3000 | 178.0 | 9.5 | 0.5 | 1.94 | 0.73 | 2.0 | 8.0 | Q1 |

TAPE AND REEL BOX DIMENSIONS

*All dimensions are nominal

| Device | Package Type | Package Drawing | Pins | SPQ | Length (mm) | Width (mm) | Height (mm) |
|------------|--------------|-----------------|------|------|-------------|------------|-------------|
| ESD321DYAR | SOT-5X3 | DYA | 2 | 3000 | 210.0 | 200.0 | 42.0 |

DYA0002A



PACKAGE OUTLINE

SOT (SOD-523) - 0.77 mm max height

PLASTIC SMALL OUTLINE

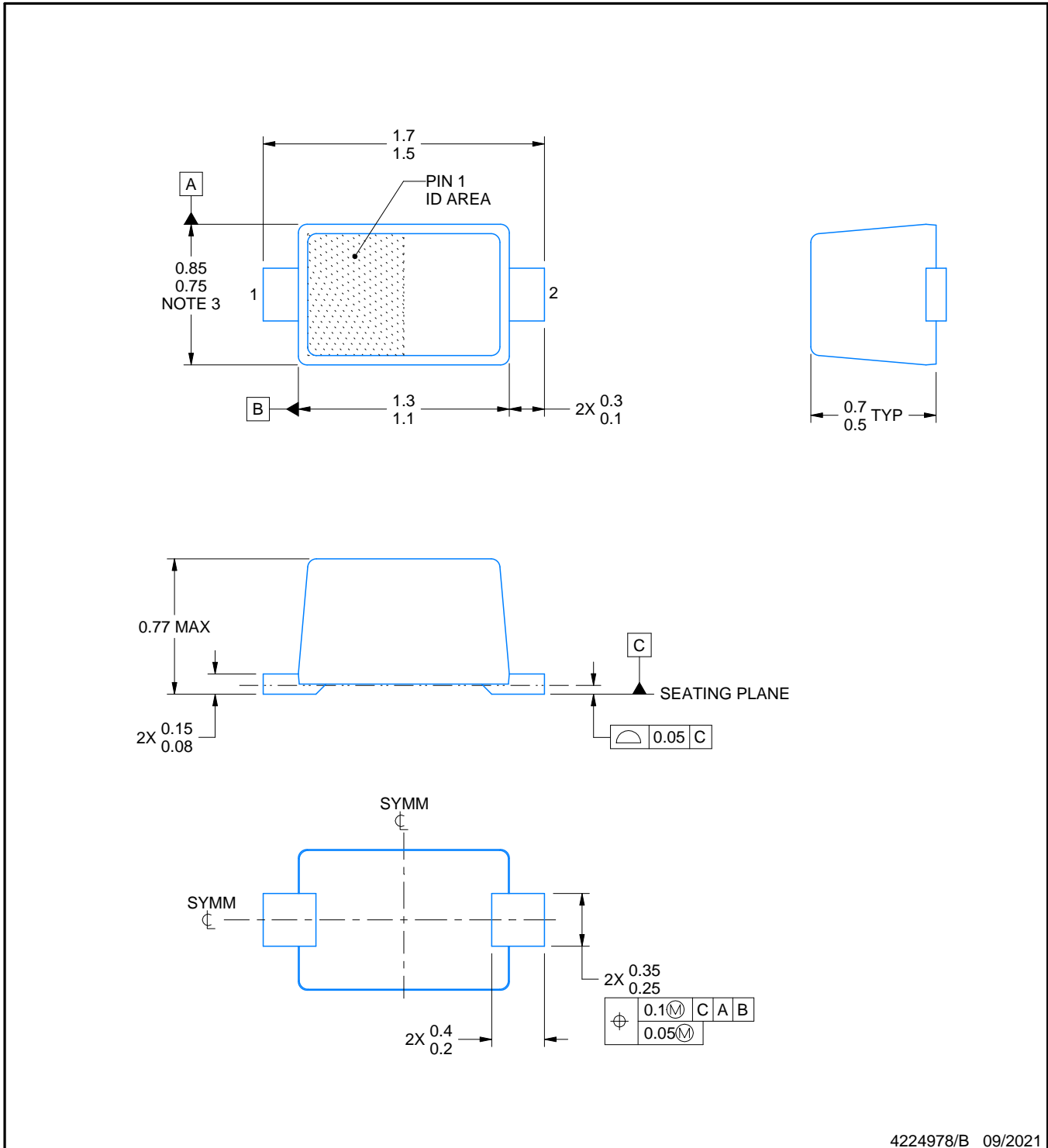

4224978/B 09/2021

NOTES:

1. All linear dimensions are in millimeters. Any dimensions in parenthesis are for reference only. Dimensioning and tolerancing per ASME Y14.5M.
2. This drawing is subject to change without notice.
3. This dimension does not include mold flash, protrusions, or gate burrs. Mold flash, protrusions, or gate burrs shall not exceed 0.15 mm per side.
4. Reference JEITA SC-79 registration except for package height

EXAMPLE BOARD LAYOUT

DYA0002A

SOT (SOD-523) - 0.77 mm max height

PLASTIC SMALL OUTLINE

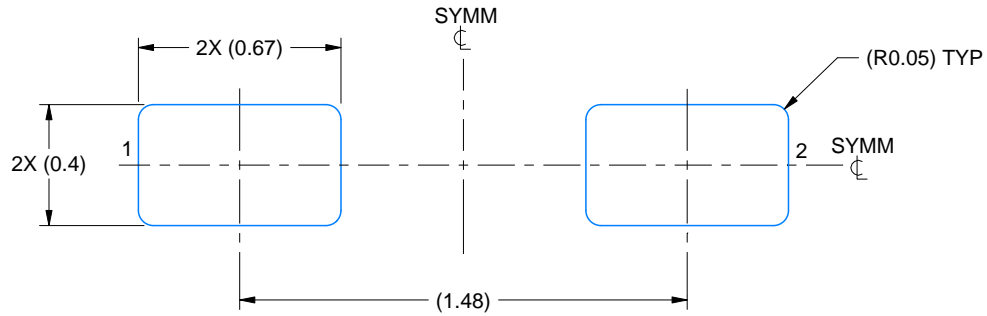

LAND PATTERN EXAMPLE
SCALE:40X

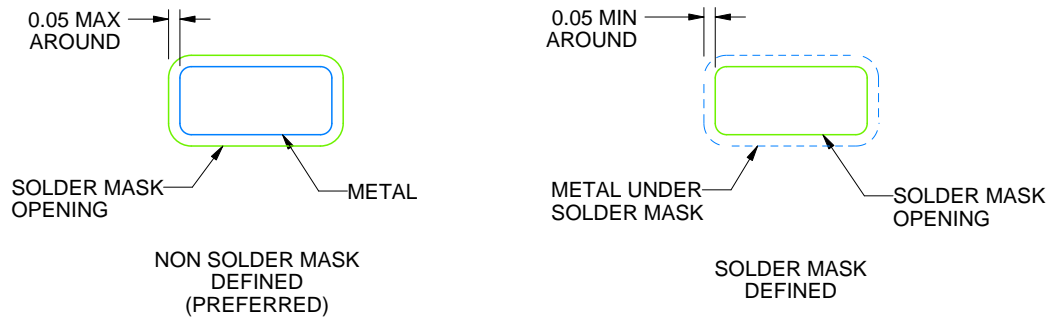

SOLDERMASK DETAILS

4224978/B 09/2021

NOTES: (continued)

- 5. Publication IPC-7351 may have alternate designs.
- 6. Solder mask tolerances between and around signal pads can vary based on board fabrication site.

EXAMPLE STENCIL DESIGN

DYA0002A

SOT (SOD-523) - 0.77 mm max height

PLASTIC SMALL OUTLINE

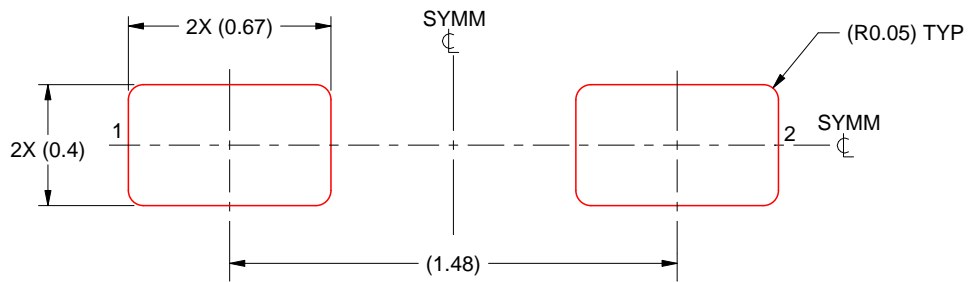

SOLDER PASTE EXAMPLE
BASED ON 0.1 mm THICK STENCIL
SCALE:40X

4224978/B 09/2021

NOTES: (continued)

7. Laser cutting apertures with trapezoidal walls and rounded corners may offer better paste release. IPC-7525 may have alternate design recommendations.
8. Board assembly site may have different recommendations for stencil design.

DPY0002A

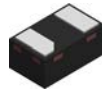

PACKAGE OUTLINE
X1SON - 0.45 mm max height

PLASTIC SMALL OUTLINE - NO LEAD

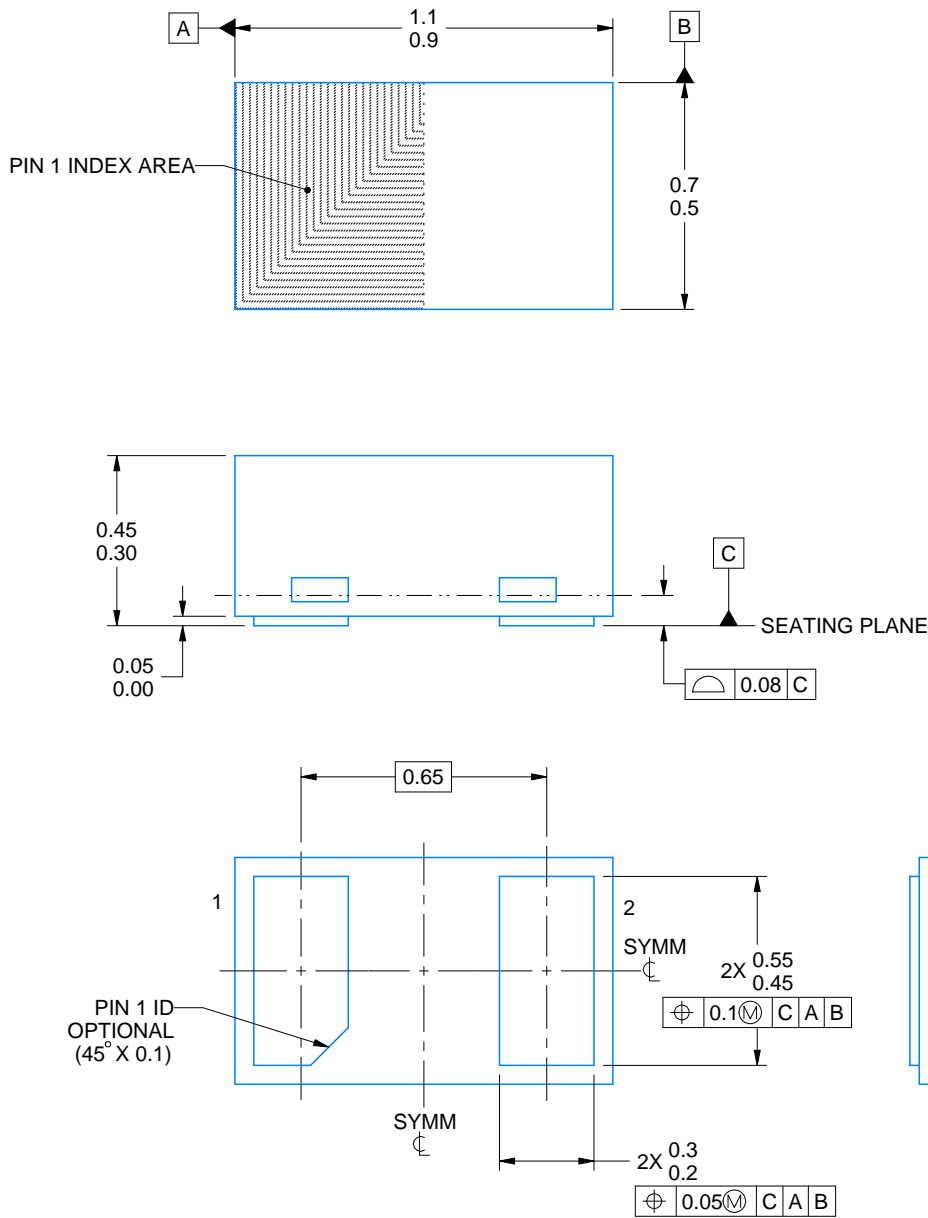

4224561/C 07/2024

NOTES:

1. All linear dimensions are in millimeters. Any dimensions in parenthesis are for reference only. Dimensioning and tolerancing per ASME Y14.5M
2. This drawing is subject to change without notice.

EXAMPLE BOARD LAYOUT

DPY0002A

X1SON - 0.45 mm max height

PLASTIC SMALL OUTLINE - NO LEAD

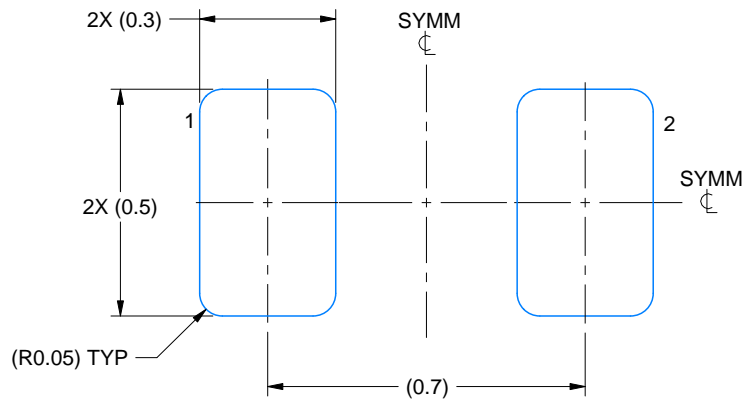

LAND PATTERN EXAMPLE
EXPOSED METAL SHOWN
SCALE:60X

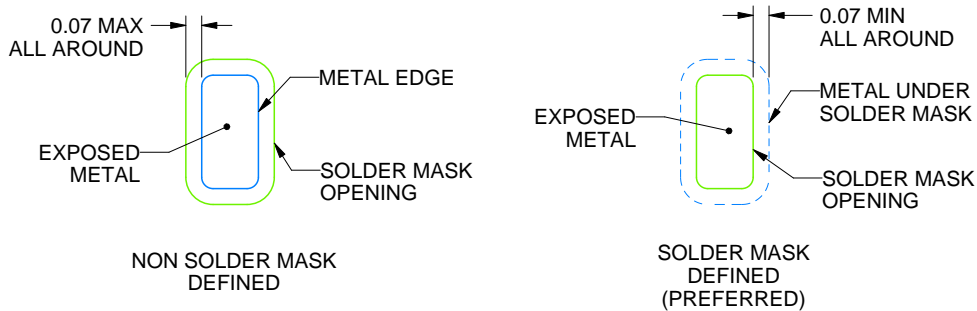

SOLDER MASK DETAILS

4224561/C 07/2024

NOTES: (continued)

3. For more information, see Texas Instruments literature number SLUA271 (www.ti.com/lit/sluea271).
4. Vias are optional depending on application, refer to device data sheet. If any vias are implemented, refer to their locations shown on this view. It is recommended that vias under paste be filled, plugged or tented.

EXAMPLE STENCIL DESIGN

DPY0002A

X1SON - 0.45 mm max height

PLASTIC SMALL OUTLINE - NO LEAD

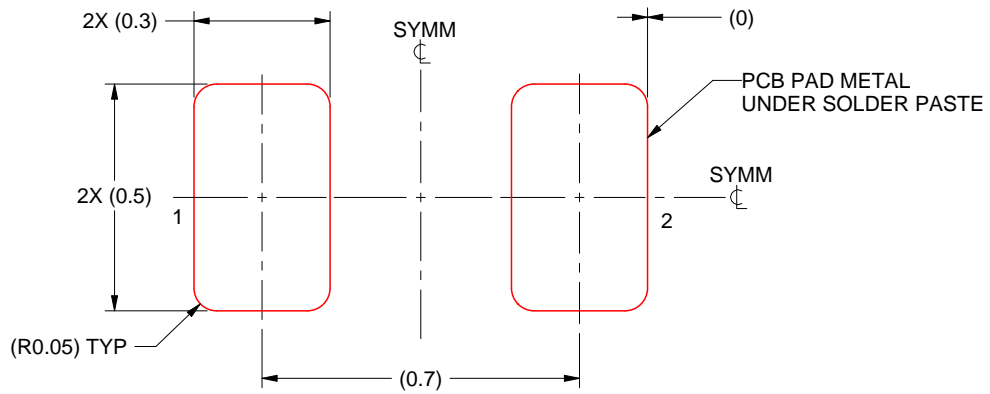

SOLDER PASTE EXAMPLE
BASED ON 0.1 mm THICK STENCIL
SCALE:60X

4224561/C 07/2024

NOTES: (continued)

5. Laser cutting apertures with trapezoidal walls and rounded corners may offer better paste release. IPC-7525 may have alternate design recommendations.

IMPORTANT NOTICE AND DISCLAIMER

TI PROVIDES TECHNICAL AND RELIABILITY DATA (INCLUDING DATA SHEETS), DESIGN RESOURCES (INCLUDING REFERENCE DESIGNS), APPLICATION OR OTHER DESIGN ADVICE, WEB TOOLS, SAFETY INFORMATION, AND OTHER RESOURCES "AS IS" AND WITH ALL FAULTS, AND DISCLAIMS ALL WARRANTIES, EXPRESS AND IMPLIED, INCLUDING WITHOUT LIMITATION ANY IMPLIED WARRANTIES OF MERCHANTABILITY, FITNESS FOR A PARTICULAR PURPOSE OR NON-INFRINGEMENT OF THIRD PARTY INTELLECTUAL PROPERTY RIGHTS.

These resources are intended for skilled developers designing with TI products. You are solely responsible for (1) selecting the appropriate TI products for your application, (2) designing, validating and testing your application, and (3) ensuring your application meets applicable standards, and any other safety, security, regulatory or other requirements.

These resources are subject to change without notice. TI grants you permission to use these resources only for development of an application that uses the TI products described in the resource. Other reproduction and display of these resources is prohibited. No license is granted to any other TI intellectual property right or to any third party intellectual property right. TI disclaims responsibility for, and you will fully indemnify TI and its representatives against, any claims, damages, costs, losses, and liabilities arising out of your use of these resources.

TI's products are provided subject to [TI's Terms of Sale](#) or other applicable terms available either on [ti.com](https://www.ti.com) or provided in conjunction with such TI products. TI's provision of these resources does not expand or otherwise alter TI's applicable warranties or warranty disclaimers for TI products.

TI objects to and rejects any additional or different terms you may have proposed.

Mailing Address: Texas Instruments, Post Office Box 655303, Dallas, Texas 75265
Copyright © 2024, Texas Instruments Incorporated