

INA1620 High-Fidelity Audio Operational Amplifier With Integrated Thin-Film Resistors and EMI Filters

1 Features

- High-Quality Thin-Film Resistors Matched to 0.004% (Typical)
- Integrated EMI Filters
- Ultra-low Noise: $2.8 \text{ nV}/\sqrt{\text{Hz}}$ at 1 kHz
- Ultra-low Total Harmonic Distortion + Noise: -119 dB THD+N (142 mW/Ch Into 32 Ω /Ch)
- Wide Gain Bandwidth Product: 32 MHz (G = +1000)
- High Slew Rate: 10 V/ μs
- High Capacitive-Load Drive Capability: > 600 pF
- High Open-Loop Gain: 136 dB (600- Ω Load)
- Low Quiescent Current: 2.6 mA per Channel
- Low-Power Shutdown Mode With Reduced Pop-and-Click Noise: 5 μA per Channel
- Short-Circuit Protection
- Wide Supply Range: $\pm 2 \text{ V}$ to $\pm 18 \text{ V}$
- Available in Small 24-pin WQFN Package

2 Applications

- High-Fidelity (HiFi) Headphone Drivers
- Professional Audio Equipment
- Analog and Digital Mixing Consoles
- Audio Test and Measurement

3 Description

The INA1620 integrates 4 precision-matched thin-film resistor pairs and EMI filtering on-chip with a low-distortion, high output current, dual audio operational amplifier. The amplifier achieves a very low, $2.8\text{-nV}/\sqrt{\text{Hz}}$ noise density with an ultra-low THD+N of -119.2 dB at 1 kHz and drives a 32- Ω load at 150-mW output power. The integrated thin-film resistors are matched to within 0.004% and can be used to create a large number of very high-performance audio circuits.

The INA1620 operates over a very wide supply range of $\pm 2 \text{ V}$ to $\pm 18 \text{ V}$ on only 2.6 mA of supply current per channel. The INA1620 also has a shutdown mode, allowing the amplifiers to be switched from normal operation to a standby current that is typically less than 5 μA . Shutdown mode is specifically designed to eliminate click-and-pop noise when transitioning into or out of shutdown mode.

The INA1620 has a unique internal layout for lowest crosstalk, and freedom from interactions between channels, even when overdriven or overloaded. This device is specified from -40°C to $+125^\circ\text{C}$.

Device Information⁽¹⁾

PART NUMBER	PACKAGE	BODY SIZE (NOM)
INA1620	WQFN (24)	4.00 mm x 4.00 mm

(1) For all available packages, see the package option addendum at the end of the data sheet.

INA1620 Simplified Internal Schematic

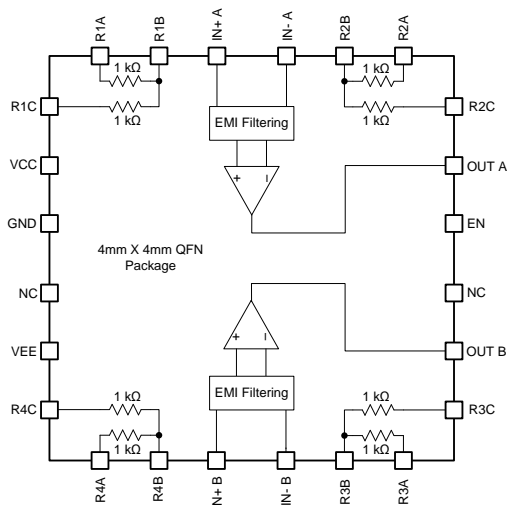

FFT: 1 kHz, 32- Ω Load, 50 mW

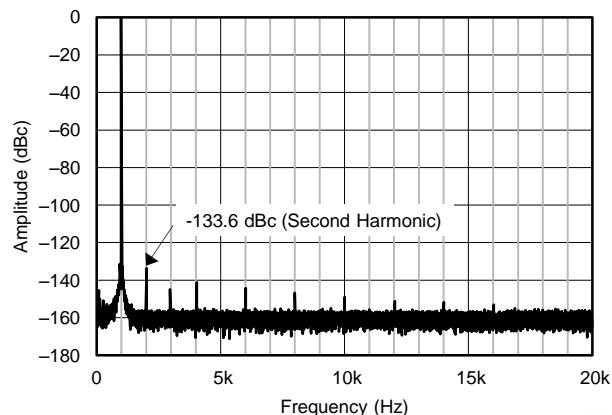

Table of Contents

1 Features	1	8 Application and Implementation	20
2 Applications	1	8.1 Application Information.....	20
3 Description	1	8.2 Typical Application	24
4 Revision History	2	8.3 Other Application Examples.....	27
5 Pin Configuration and Functions	3	9 Power Supply Recommendations	28
6 Specifications	4	10 Layout	28
6.1 Absolute Maximum Ratings	4	10.1 Layout Guidelines	28
6.2 ESD Ratings.....	4	10.2 Layout Example	28
6.3 Recommended Operating Conditions.....	4	11 Device and Documentation Support	29
6.4 Thermal Information	4	11.1 Device Support.....	29
6.5 Electrical Characteristics:	5	11.2 Documentation Support	29
6.6 Typical Characteristics.....	7	11.3 Receiving Notification of Documentation Updates	29
7 Detailed Description	15	11.4 Community Resources.....	29
7.1 Overview	15	11.5 Trademarks	30
7.2 Functional Block Diagram	15	11.6 Electrostatic Discharge Caution.....	30
7.3 Feature Description.....	15	11.7 Glossary	30
7.4 Device Functional Modes.....	18	12 Mechanical, Packaging, and Orderable Information	30

4 Revision History

NOTE: Page numbers for previous revisions may differ from page numbers in the current version.

Changes from Original (March 2018) to Revision A

Page

• First release of production-data data sheet	1
---	---

5 Pin Configuration and Functions

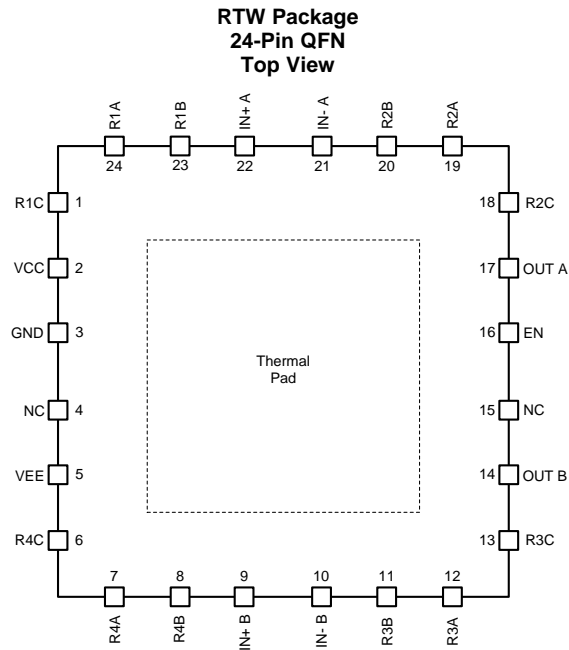

Pin Functions

PIN		I/O	DESCRIPTION
NAME	NO.		
GND	3	—	Connect to ground
EN	16	I	Shutdown (logic low), enable (logic high)
IN+ A	22	I	Noninverting input, channel A
IN- A	21	I	Inverting input, channel A
IN+ B	9	I	Noninverting input, channel B
IN- B	10	I	Inverting input, channel B
NC	4	—	No internal connection
NC	15	—	No internal connection
OUT A	17	O	Output, channel A
OUT B	14	O	Output, channel B
R1A	24	—	Resistor pair 1, end point A
R1B	23	—	Resistor pair 1, center point
R1C	1	—	Resistor pair 1, end point C
R2A	19	—	Resistor pair 2, end point A
R2B	20	—	Resistor pair 2, center point
R2C	18	—	Resistor pair 2, end point C
R3A	12	—	Resistor pair 3, end point A
R3B	11	—	Resistor pair 3, center point
R3C	13	—	Resistor pair 3, end point C
R4A	7	—	Resistor pair 4, end point A
R4B	8	—	Resistor pair 4, center point
R4C	6	—	Resistor pair 4, end point C
V+	2	—	Positive (highest) power supply
V-	5	—	Negative (lowest) power supply
Thermal pad			Exposed thermal die pad on underside; connect thermal die pad to V-.

6 Specifications

6.1 Absolute Maximum Ratings

 over operating free-air temperature range (unless otherwise noted)⁽¹⁾

		MIN	MAX	UNIT
Voltage	Supply voltage, $V_S = (V+) - (V-)$		40	V
	Input voltage (signal inputs, enable, ground)	$(V-) - 0.5$	$(V+) + 0.5$	
	Input differential voltage		± 0.5	
Current	Input current (all pins except power-supply and resistor pins)		± 10	mA
	Through each resistor		30	
	Output short-circuit ⁽²⁾		Continuous	
Temperature	Operating, T_A	-55	125	°C
	Junction, T_J		150	
	Storage, T_{stg}	-65	150	

- (1) Stresses beyond those listed under *Absolute Maximum Ratings* may cause permanent damage to the device. These are stress ratings only, which do not imply functional operation of the device at these or any other conditions beyond those indicated under *Recommended Operating Conditions*. Exposure to absolute-maximum-rated conditions for extended periods may affect device reliability.
- (2) Short-circuit to $V_S / 2$ (ground in symmetrical dual supply setups), one amplifier per package.

6.2 ESD Ratings

		VALUE	UNIT
$V_{(ESD)}$ Electrostatic discharge	Human-body model (HBM), per ANSI/ESDA/JEDEC JS-001 ⁽¹⁾	± 4000	V
	Charged-device model (CDM), per JEDEC specification JESD22-C101 ⁽²⁾	± 1000	

- (1) JEDEC document JEP155 states that 500-V HBM allows safe manufacturing with a standard ESD control process.
- (2) JEDEC document JEP157 states that 250-V CDM allows safe manufacturing with a standard ESD control process.

6.3 Recommended Operating Conditions

over operating free-air temperature range (unless otherwise noted)

		MIN	NOM	MAX	UNIT
Supply voltage, $(V+) - (V-)$	Single-supply	4		36	V
	Dual-supply	± 2		± 18	
Current per resistor				15	mA
Specified temperature		-40		125	°C

6.4 Thermal Information

THERMAL METRIC ⁽¹⁾		INA1620	UNIT
		RTW (QFN)	
		24 PINS	
$R_{\theta JA}$	Junction-to-ambient thermal resistance	33.7	°C/W
$R_{\theta JC(top)}$	Junction-to-case (top) thermal resistance	26.5	°C/W
$R_{\theta JB}$	Junction-to-board thermal resistance	13.1	°C/W
Ψ_{JT}	Junction-to-top characterization parameter	0.3	°C/W
Ψ_{JB}	Junction-to-board characterization parameter	13.1	°C/W
$R_{\theta JC(bot)}$	Junction-to-case (bottom) thermal resistance	3.8	°C/W

- (1) For more information about traditional and new thermal metrics, see the *Semiconductor and IC Package Thermal Metrics application report*, [SPRA953](#).

6.5 Electrical Characteristics:

at $T_A = 25^\circ\text{C}$, $V_S = \pm 2\text{ V}$ to $\pm 18\text{ V}$, $V_{CM} = V_{OUT} = \text{mid supply}$, and $R_L = 1\text{ k}\Omega$ (unless otherwise noted)

PARAMETER		TEST CONDITIONS	MIN	TYP	MAX	UNIT	
AUDIO PERFORMANCE							
THD+N	Total harmonic distortion + noise	G = 1, f = 1 kHz, $V_{OUT} = 3.5 V_{RMS}$, $R_L = 2\text{ k}\Omega$, 80-kHz measurement bandwidth		0.000025%			
				-132		dB	
		G = 1, f = 1 kHz, $V_{OUT} = 3.5 V_{RMS}$, $R_L = 600\ \Omega$, 80-kHz measurement bandwidth		0.000025%			
				-132		dB	
		G = 1, f = 1 kHz, $P_{OUT} = 10\text{ mW}$, $R_L = 128\ \Omega$, 80-kHz measurement bandwidth		0.000071%			
				-123		dB	
		G = 1, f = 1 kHz, $P_{OUT} = 10\text{ mW}$, $R_L = 32\ \Omega$, 80-kHz measurement bandwidth		0.000158%			
				-116		dB	
		G = 1, f = 1 kHz, $P_{OUT} = 10\text{ mW}$, $R_L = 16\ \Omega$, 80-kHz measurement bandwidth		0.000224%			
				-113		dB	
IMD	Intermodulation distortion	SMPTE/DIN two-tone, 4:1 (60 Hz and 7 kHz), G = 1, $V_O = 3 V_{RMS}$, $R_L = 2\text{ k}\Omega$, 90-kHz measurement bandwidth		0.000018%			
				-135		dB	
		CCIF twin-tone (19 kHz and 20 kHz), G = 1, $V_O = 3 V_{RMS}$, $R_L = 2\text{ k}\Omega$, 90-kHz measurement bandwidth		0.000032%			
				-130		dB	
FREQUENCY RESPONSE							
GBW	Gain-bandwidth product	G = 1000		32		MHz	
		G = 1		8			
SR	Slew rate	G = -1		10		V/ μs	
		Full-power bandwidth ⁽¹⁾	$V_O = 1 V_P$	1.6		MHz	
	Overload recovery time	G = -10		300		ns	
	Channel separation (dual)	f = 1 kHz		140		dB	
	EMI filter corner frequency			500		MHz	
NOISE							
	Input voltage noise	f = 20 Hz to 20 kHz		2.1		μV_{PP}	
e_n	Input voltage noise density ⁽²⁾	f = 10 Hz		6.5		nV/ $\sqrt{\text{Hz}}$	
		f = 100 Hz		3.5			
		f = 1 kHz		2.8			
i_n	Input current noise density	f = 10 Hz		1.6		pA/ $\sqrt{\text{Hz}}$	
		f = 1 kHz		0.8			
OFFSET VOLTAGE							
V_{OS}	Input offset voltage			± 0.1	± 1	mV	
		$T_A = -40^\circ\text{C}$ to 125°C			± 1.2		
dV_{OS}/dT	Input offset voltage drift ⁽²⁾	$T_A = -40^\circ\text{C}$ to 125°C		-0.5	± 2.5	$\mu\text{V}/^\circ\text{C}$	
PSRR	Power-supply rejection ratio			0.1	3	$\mu\text{V}/\text{V}$	
INPUT BIAS CURRENT							
I_B	Input bias current			1.2	2	μA	
		$T_A = -40^\circ\text{C}$ to 125°C ⁽²⁾			2.2		
I_{OS}	Input offset current			± 10	± 100	nA	
		$T_A = -40^\circ\text{C}$ to 125°C ⁽²⁾			± 140		
INPUT VOLTAGE RANGE							
V_{CM}	Common-mode voltage range		(V-) + 1.5		(V+) - 1	V	
CMRR	Common-mode rejection ratio	(V-) + 1.5 V $\leq V_{CM} \leq$ (V+) - 1 V, $T_A = -40^\circ\text{C}$ to 125°C , $V_S = \pm 18\text{ V}$	108	127		dB	

(1) Full-power bandwidth = $SR / (2\pi \times V_P)$, where SR = slew rate.

(2) Specified by design and characterization.

Electrical Characteristics: (continued)

 at $T_A = 25^\circ\text{C}$, $V_S = \pm 2\text{ V}$ to $\pm 18\text{ V}$, $V_{CM} = V_{OUT} = \text{midsupply}$, and $R_L = 1\text{ k}\Omega$ (unless otherwise noted)

PARAMETER		TEST CONDITIONS	MIN	TYP	MAX	UNIT
INPUT IMPEDANCE						
	Differential		60k 0.8			Ω pF
	Common-mode		500M 0.9			Ω pF
OPEN-LOOP GAIN						
A_{OL}	Open-loop voltage gain	$(V^-) + 2\text{ V} \leq V_O \leq (V^+) - 2\text{ V}$, $R_L = 32\ \Omega$, $V_S = \pm 5\text{ V}$	114	120		dB
		$(V^-) + 1.5\text{ V} \leq V_O \leq (V^+) - 1.5\text{ V}$, $R_L = 600\ \Omega$, $V_S = \pm 18\text{ V}$	120	136		
OUTPUT						
V_O	Voltage output swing from rail	Positive rail	No load	800		mV
			$R_L = 600\ \Omega$	1000		
		Negative rail	No load	800		
			$R_L = 600\ \Omega$	1000		
I_{OUT}	Output current			Figure 38		mA
Z_O	Open-loop output impedance			Figure 40		Ω
I_{SC}	Short-circuit current	$V_S = \pm 18\text{ V}$	+145 / -130			mA
C_{LOAD}	Capacitive load drive			Figure 24		pF
ENABLE PIN						
V_{IH}	Logic high threshold		0.82			V
		$T_A = -40^\circ\text{C}$ to $125^\circ\text{C}^{(2)}$			0.95	
V_{IL}	Logic low threshold		0.78			V
		$T_A = -40^\circ\text{C}$ to $125^\circ\text{C}^{(2)}$	0.65			
I_{IH}	Input current	$V_{EN} = 1.8\text{ V}$	1.5			μA
RESISTOR PAIRS						
	Resistor ratio matching ⁽³⁾	Resistors in same pair	0.004%		0.02%	
		$T_A = -40^\circ\text{C}$ to $125^\circ\text{C}^{(2)}$			0.023%	
	Resistor ratio matching temperature coefficient	Resistors in same pair	± 0.07		± 0.15	ppm/ $^\circ\text{C}$
	Individual resistor value		0.84	1	1.15	k Ω
	Individual resistor temperature coefficient		2		20	ppm/ $^\circ\text{C}$
POWER SUPPLY						
I_Q	Quiescent current (per channel)	$V_{EN} = 2\text{ V}$, $I_{OUT} = 0\text{ A}$		2.6	3.3	mA
			$T_A = -40^\circ\text{C}$ to $125^\circ\text{C}^{(2)}$			
		$V_{EN} = 0\text{ V}$, $I_{OUT} = 0\text{ A}$			5	10

(3) Resistor ratio matching refers to the matching between the two 1-k Ω resistors in each resistor pair. There are four pairs on each INA1620: RXA, RXB, RXC and RXD, where X is the terminal connection number. See [Resistor Tolerance](#) for more details.

6.6 Typical Characteristics

at $T_A = 25^\circ\text{C}$, $V_S = \pm 18\text{ V}$, and $R_L = 2\text{ k}\Omega$ (unless otherwise noted)

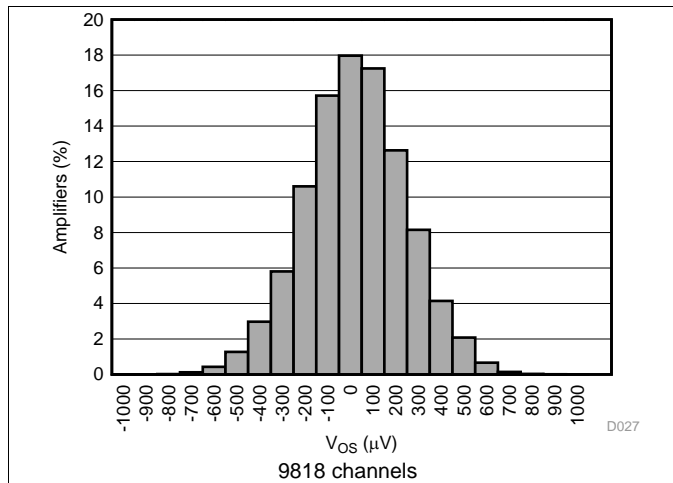

Figure 1. Input Offset Voltage Histogram

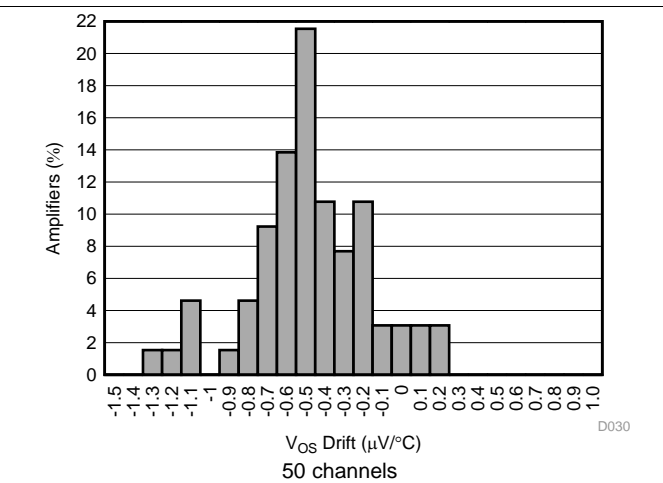

Figure 2. Input Offset Voltage Drift Histogram

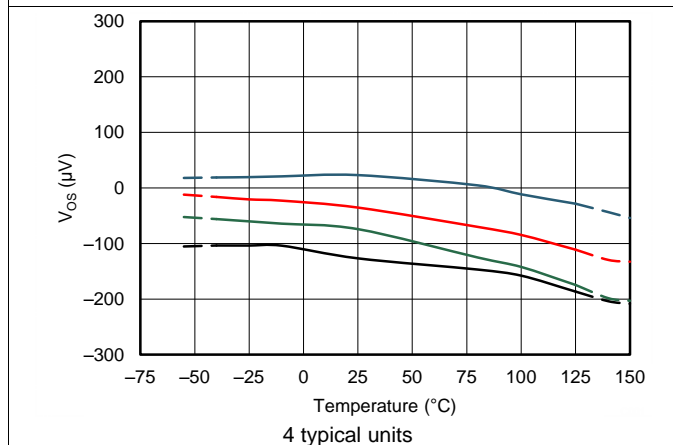

Figure 3. Input Offset Voltage vs Temperature

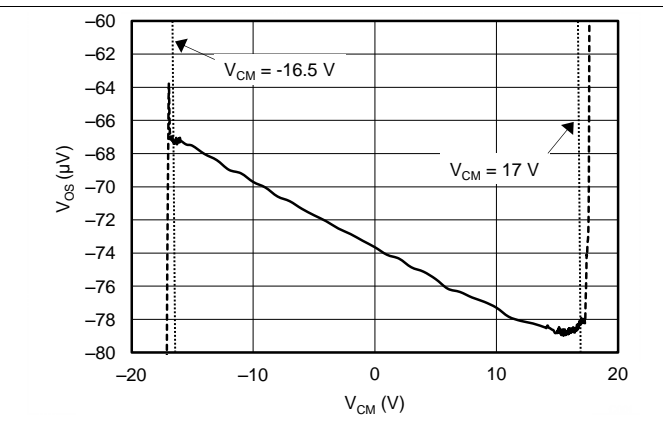

Figure 4. Input Offset Voltage vs Common-Mode Voltage

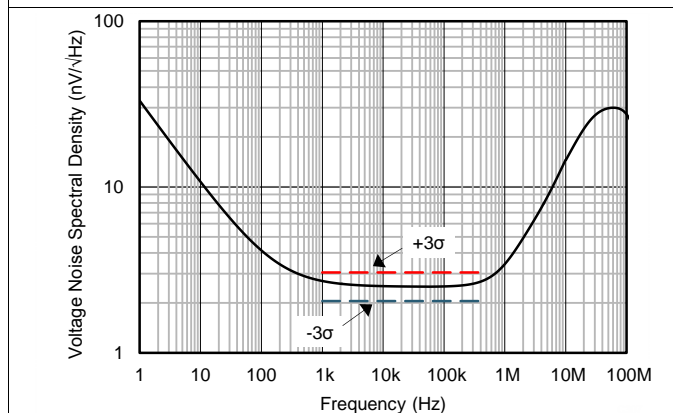

Figure 5. Input Voltage Noise Spectral Density vs Frequency

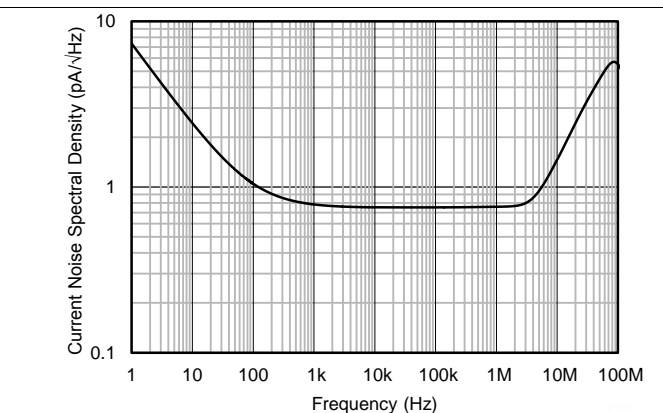

Figure 6. Input Current Noise Spectral Density vs Frequency

Typical Characteristics (continued)

at $T_A = 25^\circ\text{C}$, $V_S = \pm 18\text{ V}$, and $R_L = 2\text{ k}\Omega$ (unless otherwise noted)

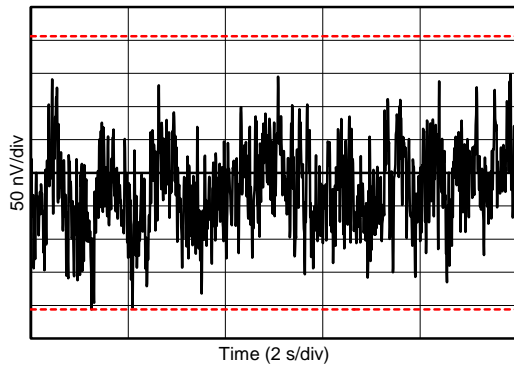

Figure 7. 0.1-Hz to 10-Hz Noise

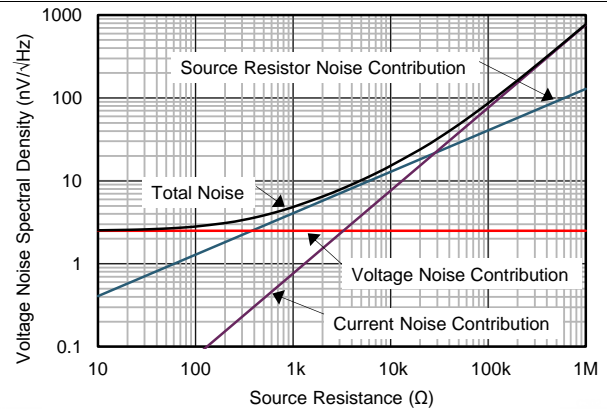

Figure 8. Voltage Noise vs Source Resistance

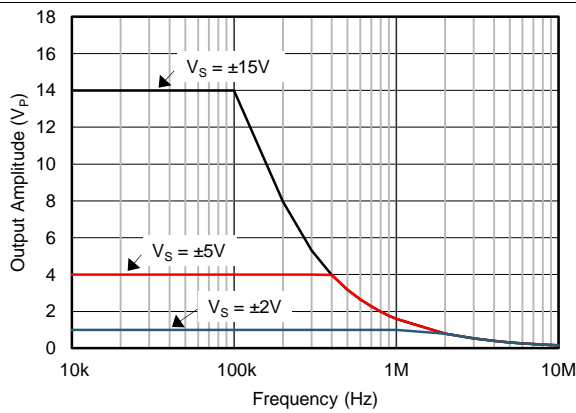

Figure 9. Maximum Output Voltage vs Frequency

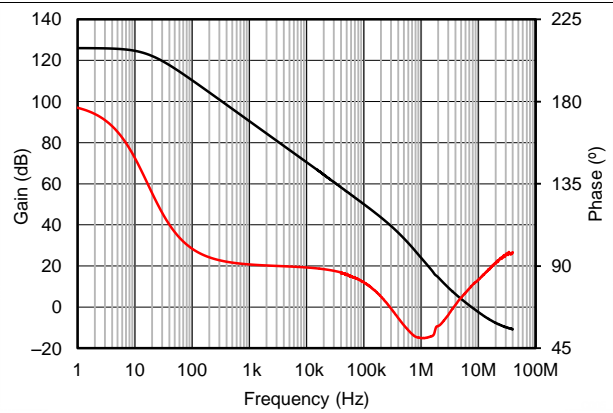

Figure 10. Open-Loop Gain and Phase vs Frequency

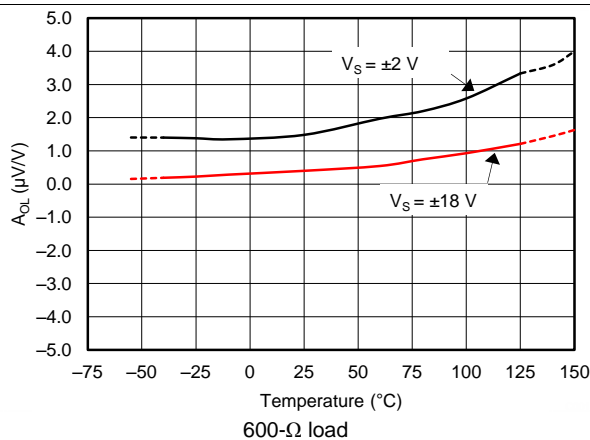

Figure 11. Open-Loop Gain vs Temperature

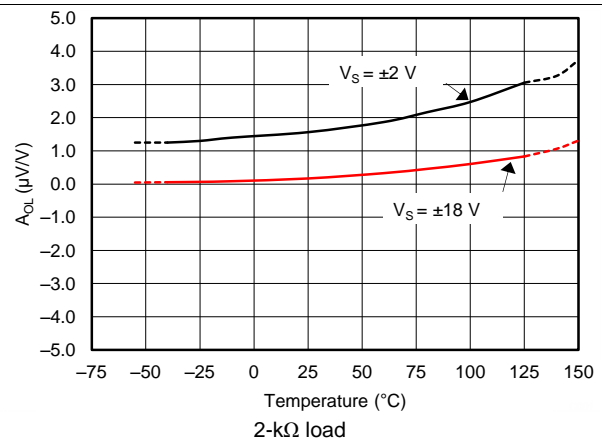
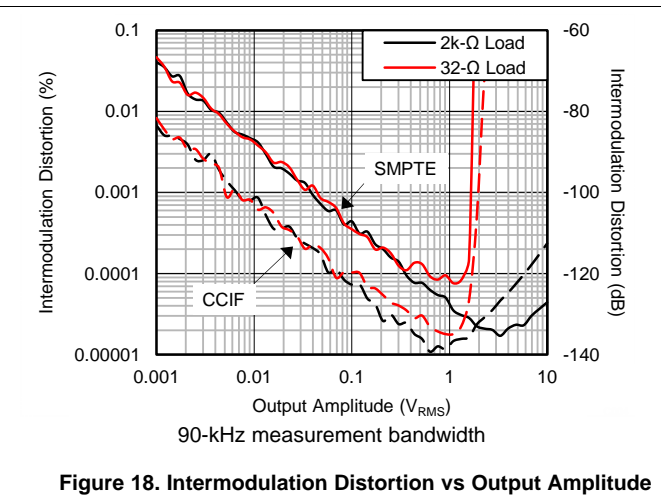
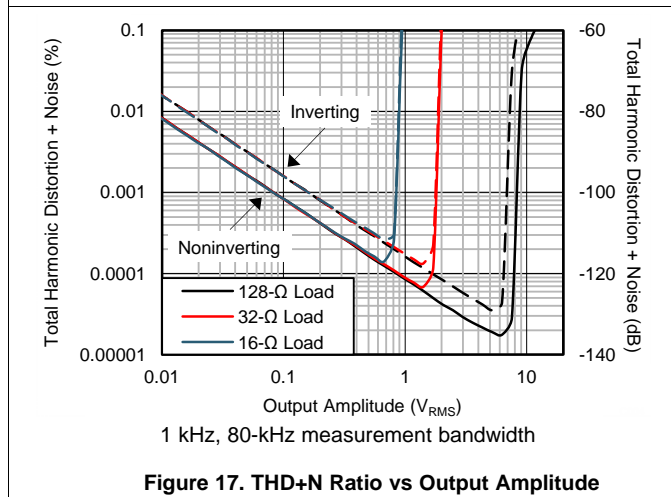
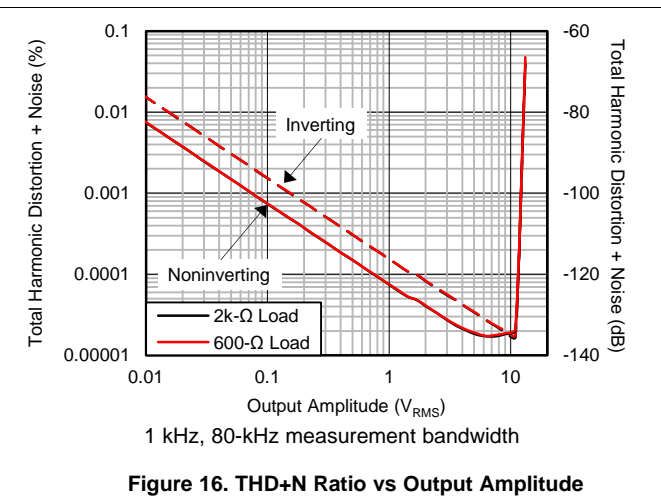
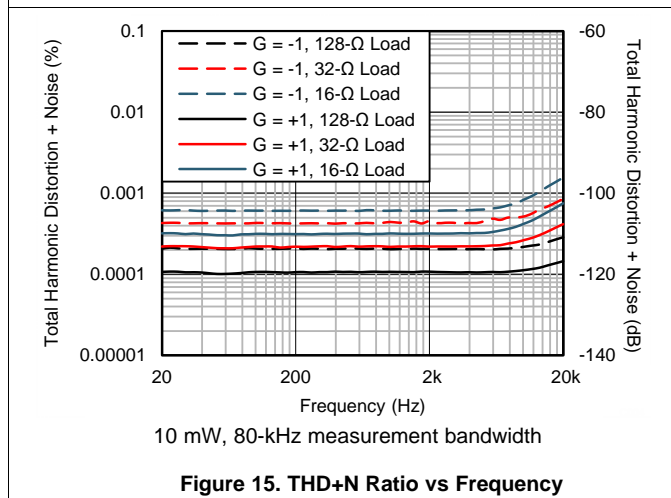
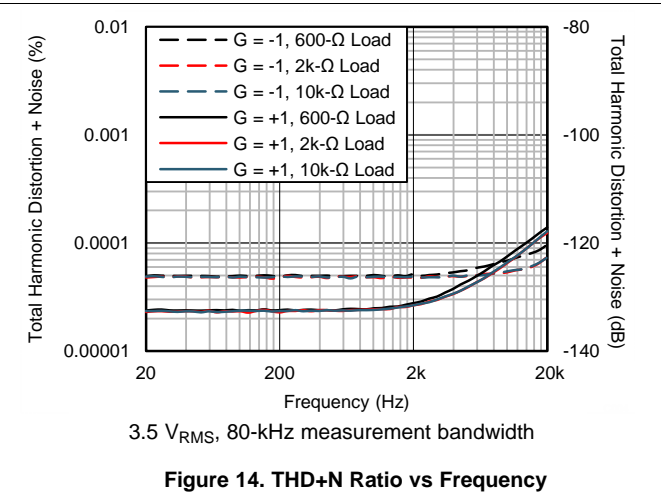
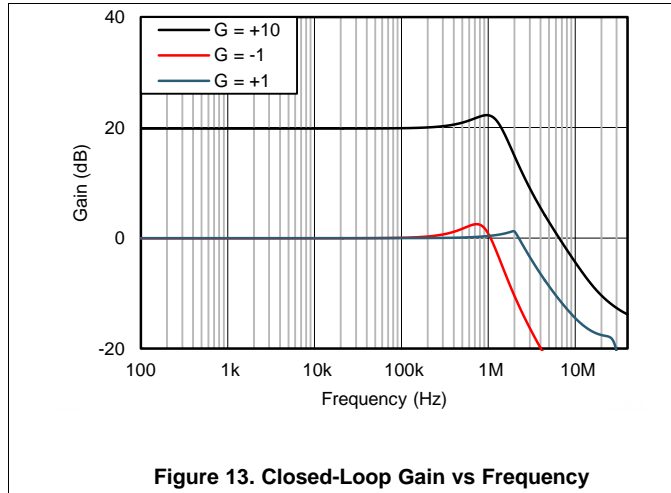

Figure 12. Open-Loop Gain vs Temperature

Typical Characteristics (continued)

at $T_A = 25^\circ\text{C}$, $V_S = \pm 18\text{ V}$, and $R_L = 2\text{ k}\Omega$ (unless otherwise noted)



Typical Characteristics (continued)

at $T_A = 25^\circ\text{C}$, $V_S = \pm 18\text{ V}$, and $R_L = 2\text{ k}\Omega$ (unless otherwise noted)

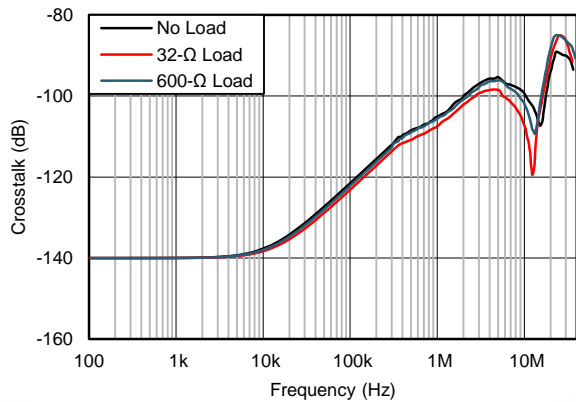

Figure 19. Channel Separation vs Frequency

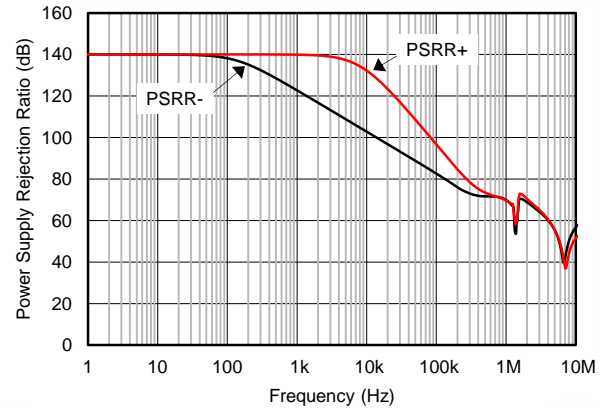

Figure 20. PSRR vs Frequency (Referred to Input)

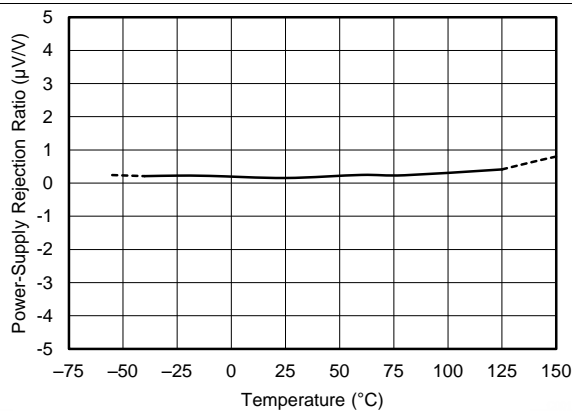

Figure 21. PSRR vs Temperature

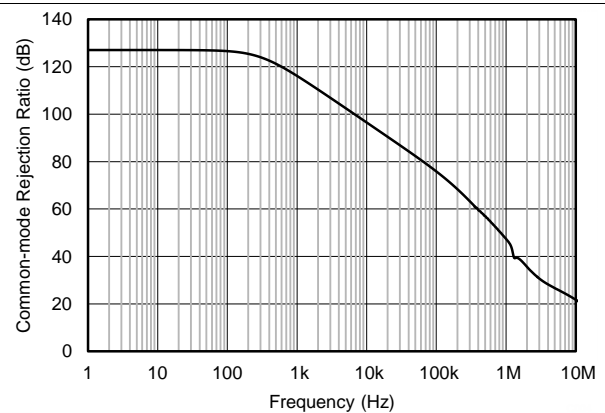

Figure 22. CMRR vs Frequency (Referred to Input)

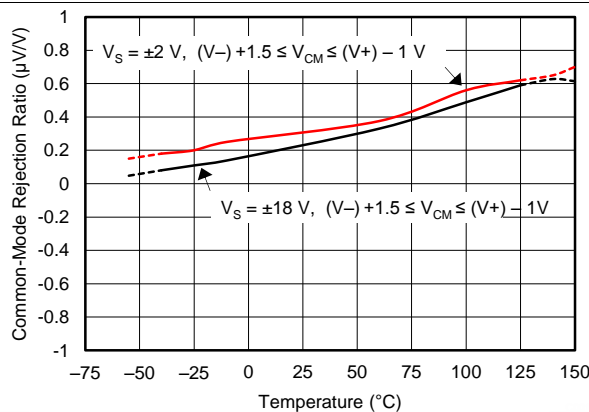

Figure 23. CMRR vs Temperature

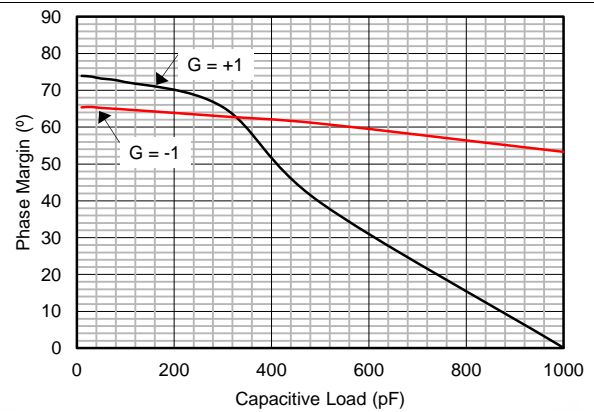
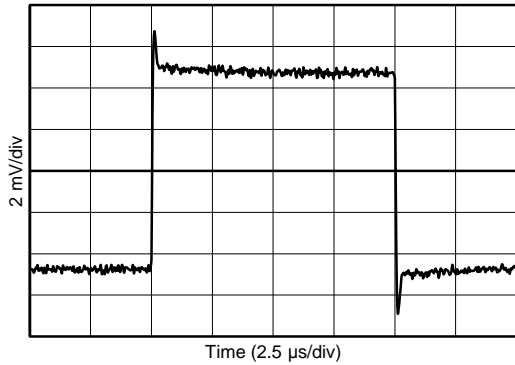

Figure 24. Phase Margin vs Capacitive Load

Typical Characteristics (continued)

at $T_A = 25^\circ\text{C}$, $V_S = \pm 18\text{ V}$, and $R_L = 2\text{ k}\Omega$ (unless otherwise noted)



$G = 1, 10\text{ mV}$

Figure 25. Small-Signal Step Response

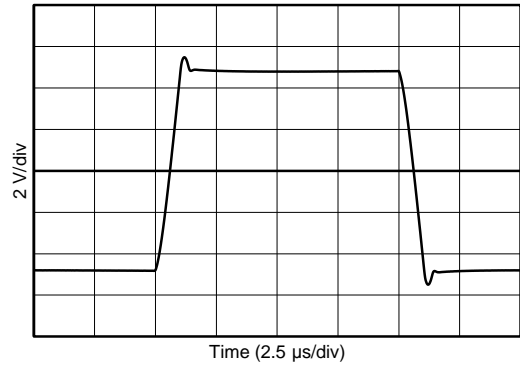

$G = 1, 10\text{ V}$

Figure 26. Large-Signal Step Response

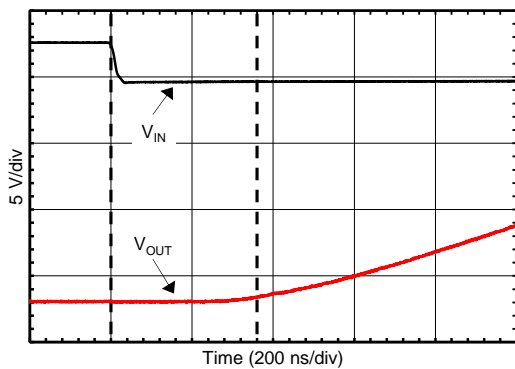

$G = -10$

Figure 27. Negative Overload Recovery

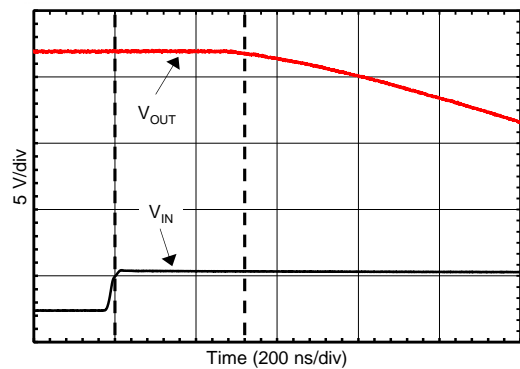

$G = -10$

Figure 28. Positive Overload Recovery

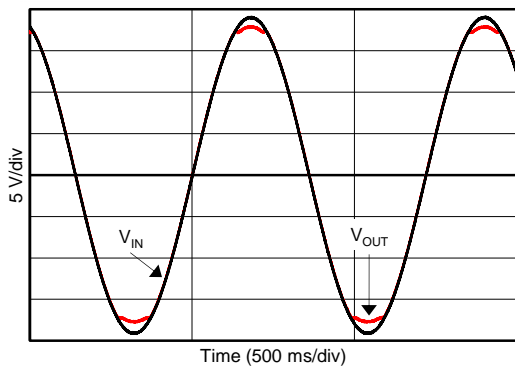

Figure 29. No Phase Reversal

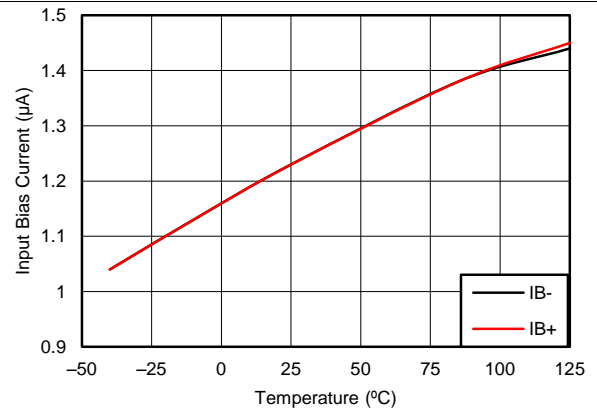

Figure 30. I_B vs Temperature

Typical Characteristics (continued)

at $T_A = 25^\circ\text{C}$, $V_S = \pm 18\text{ V}$, and $R_L = 2\text{ k}\Omega$ (unless otherwise noted)

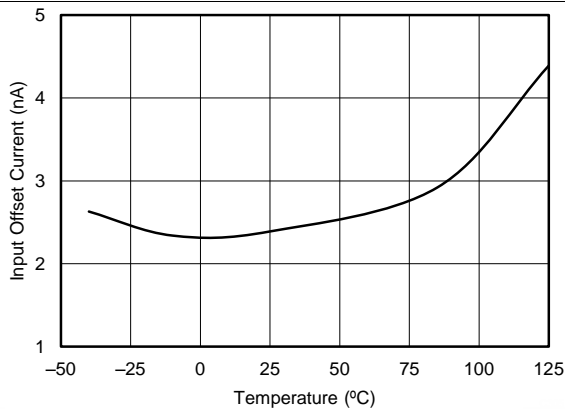

Figure 31. I_{OS} vs Temperature

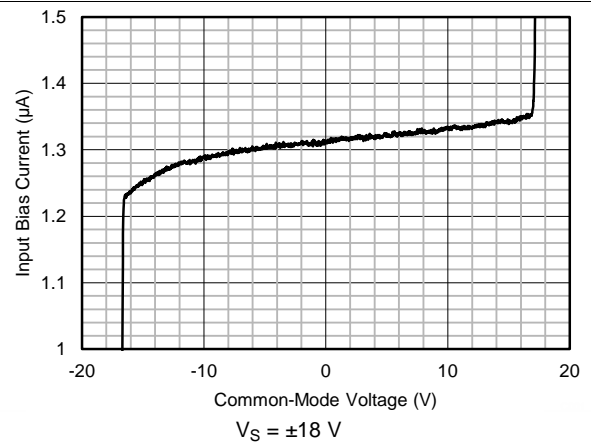

Figure 32. I_B vs Common-Mode Voltage

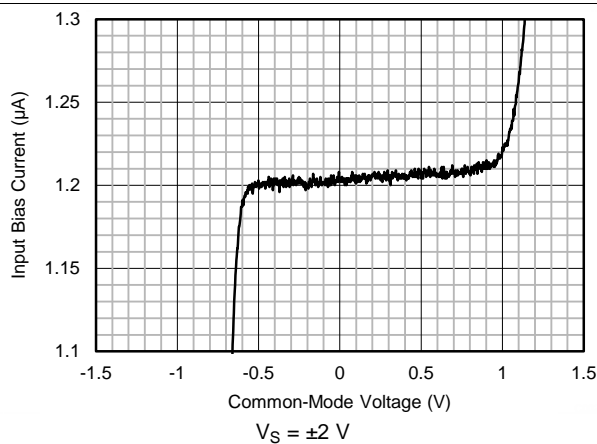

Figure 33. I_B vs Common-Mode Voltage

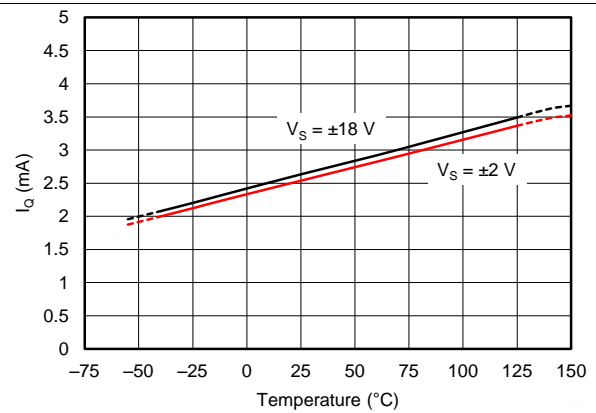

Figure 34. Quiescent Current vs Temperature

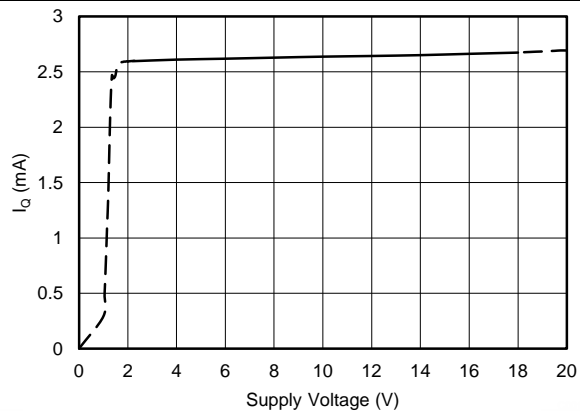

Figure 35. Quiescent Current vs Supply Voltage

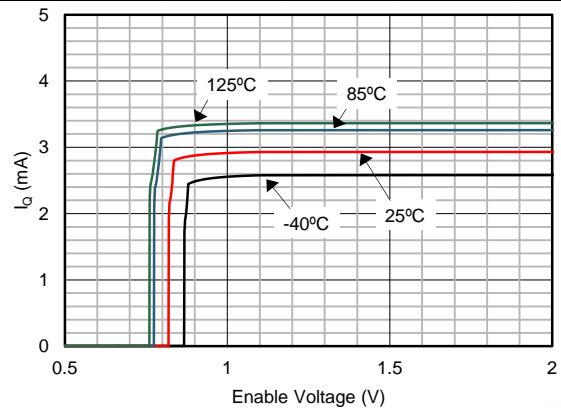

Figure 36. Quiescent Current vs Enable Voltage

Typical Characteristics (continued)

at $T_A = 25^\circ\text{C}$, $V_S = \pm 18\text{ V}$, and $R_L = 2\text{ k}\Omega$ (unless otherwise noted)

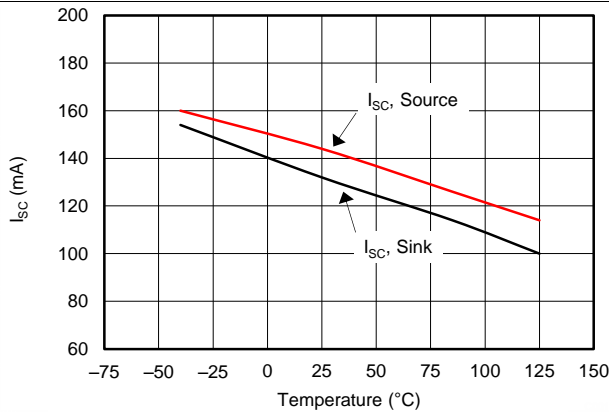

Figure 37. Short-Circuit Current vs Temperature

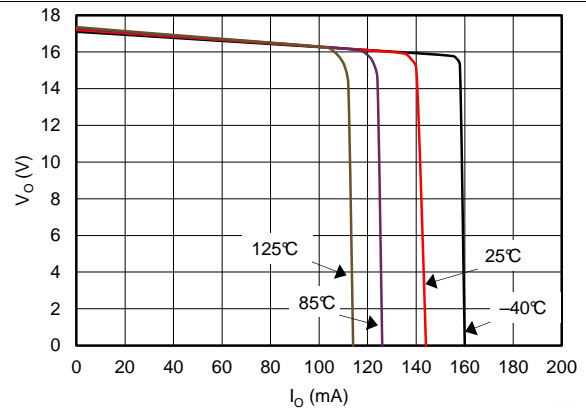

Figure 38. Positive Output Voltage vs Output Current

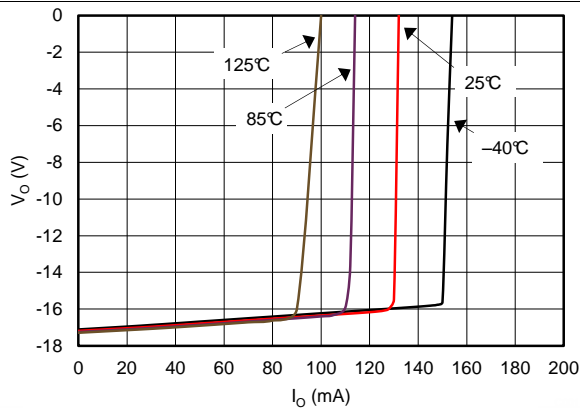

Figure 39. Negative Output Voltage vs Output Current

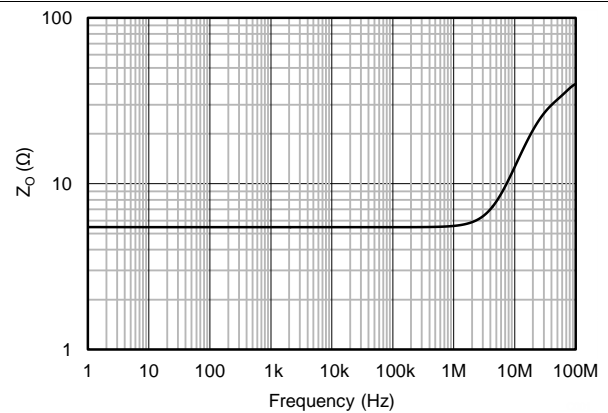

Figure 40. Open-Loop Output Impedance vs Frequency

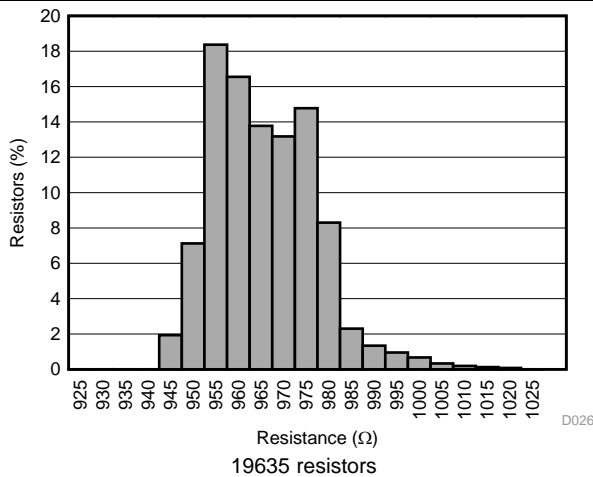

Figure 41. Resistor Absolute Value Histogram

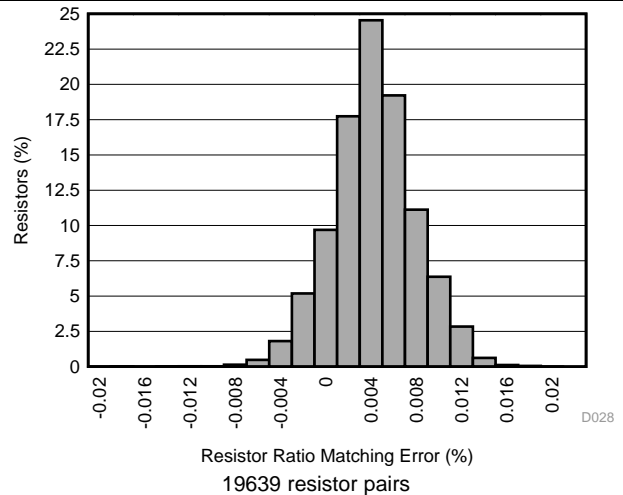
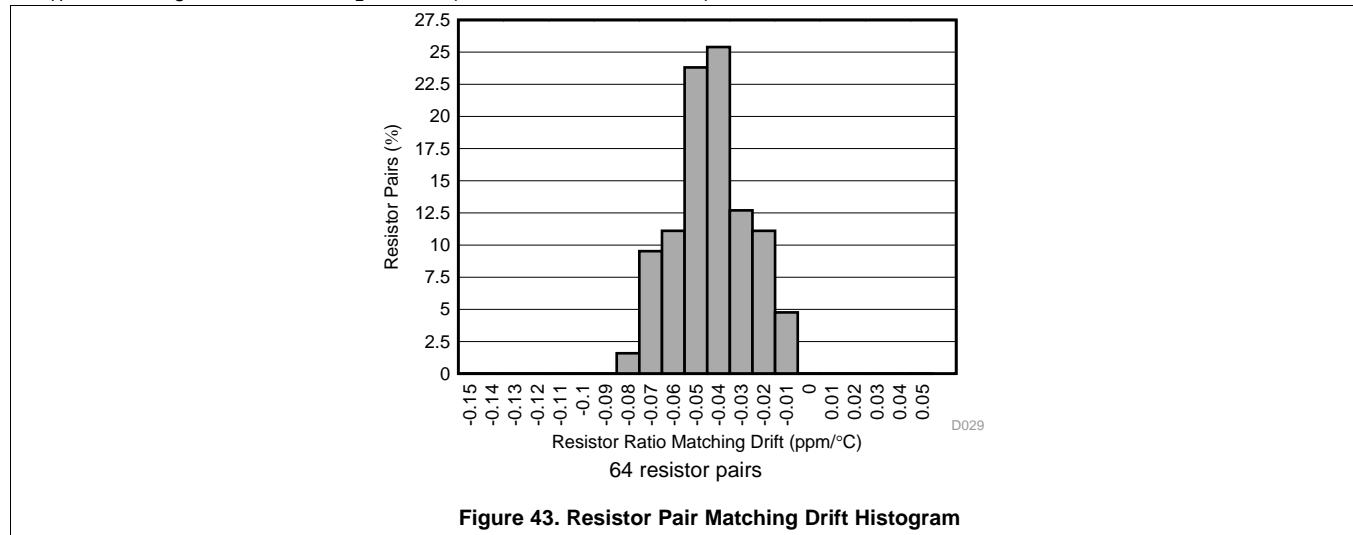

Figure 42. Resistor Pair Matching Histogram

Typical Characteristics (continued)

at $T_A = 25^\circ\text{C}$, $V_S = \pm 18\text{ V}$, and $R_L = 2\text{ k}\Omega$ (unless otherwise noted)



7 Detailed Description

7.1 Overview

The INA1620 integrates a dual, bipolar-input, audio operational amplifier with four high-precision thin-film resistor pairs on the same die. The internal amplifiers and resistor pairs are pinned out to allow for many circuit configurations.

The internal amplifiers of the INA1620 use a unique topology to deliver high output current with extremely low distortion while consuming minimal supply current. A single gain-stage architecture, combining a high-gain transconductance input stage and a unity-gain output stage, allows the INA1620 to achieve an open-loop gain of 136 dB, even with 600-Ω loads.

A separate enable circuit maintains control of the input and output stage when the amplifier is placed into its shutdown mode and limits transients at the amplifier output when transitioning to and from this state. The enable circuit features logic levels referenced to the amplifier ground pin. This configuration simplifies the interface between the amplifier and the ground-referenced GPIO pins of microcontrollers. The addition of a ground pin to the amplifier provides several additional benefits. For example, the compensation capacitor between the input and output stages of the INA1620 is referenced to the ground pin, greatly improving PSRR.

7.2 Functional Block Diagram

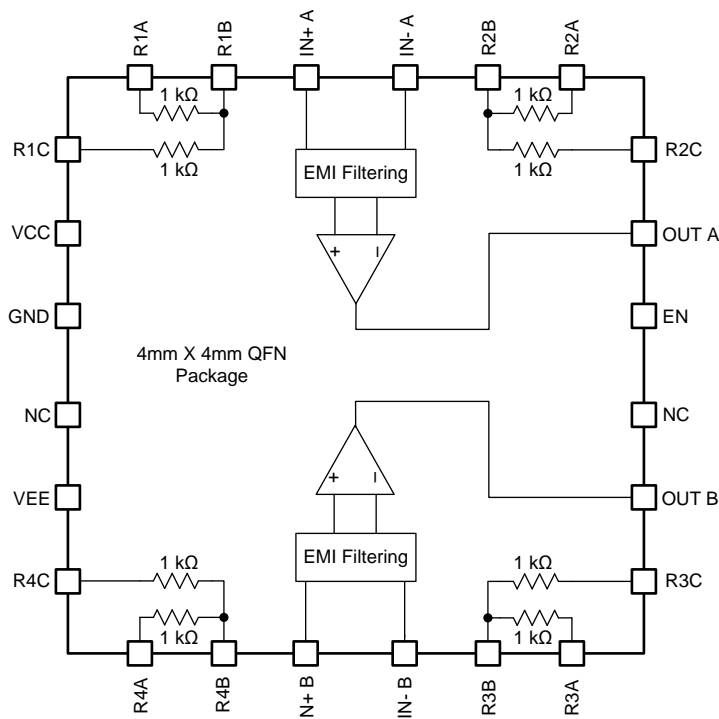

7.3 Feature Description

7.3.1 Matched Thin-Film Resistor Pairs

The INA1620 integrates four thin-film resistor pairs. Each pair is made up of two thin-film resistors with a nominal resistance of 1 kΩ. While the absolute value of the resistor is not trimmed and can vary significantly, the two resistors in an pair are designed to match each other extremely well. The resistors in an pair typically match to within 0.004% of each other's value. This matching is also preserved well over temperature, with the matching drift having a 0.2 ppm/°C maximum specification. Each node in the resistor pair is bonded out to a pad on the

Feature Description (continued)

INA1620 package allowing the resistor pairs to be used in multiple configurations. The nodes in the pair are protected from damage due to electrostatic discharge (ESD) events by diodes tied to the power supplies of the IC. For this reason, voltages beyond the power supplies cannot be applied to the resistors without forward-biasing the ESD protection diodes. The resistor pairs should not be used if there is no power applied to the INA1620. The configuration of the ESD protection diodes is shown in [Figure 44](#).

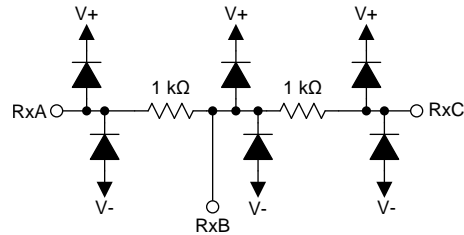

Figure 44. ESD Protection Diodes on Each Resistor Pair

Although the resistor pairs and amplifier core are fabricated on the same silicon substrate, they can be used in separate circuits as long as the previously-mentioned voltage limits are observed. The functional state of the amplifier (enabled or shutdown) does not affect the resistor pair's performance.

7.3.2 Power Dissipation

The INA1620 is capable of high output current with power-supply voltages up to ± 18 V. Internal power dissipation increases when operating at high supply voltages. The power dissipated in the op amp (P_{OPA}) is calculated using [Equation 1](#):

$$P_{OPA} = (V_+ - V_{OUT}) \times I_{OUT} = (V_+ - V_{OUT}) \times \frac{V_{OUT}}{R_L} \quad (1)$$

In order to calculate the worst-case power dissipation in the op amp, the ac and dc cases must be considered separately.

In the case of constant output current (dc) to a resistive load, the maximum power dissipation in the op amp occurs when the output voltage is half the positive supply voltage. This calculation assumes that the op amp is sourcing current from the positive supply to a grounded load. If the op amp sinks current from a grounded load, modify [Equation 2](#) to include the negative supply voltage instead of the positive.

$$P_{OPA(MAX_DC)} = P_{OPA} \left(\frac{V_+}{2} \right) = \frac{V_+^2}{4R_L} \quad (2)$$

The maximum power dissipation in the op amp for a sinusoidal output current (ac) to a resistive load occurs when the peak output voltage is $2/\pi$ times the supply voltage, given symmetrical supply voltages:

$$P_{OPA(MAX_AC)} = P_{OPA} \left(\frac{2V_+}{\pi} \right) = \frac{2 \cdot V_+^2}{\pi^2 \cdot R_L} \quad (3)$$

The dominant pathway for the INA1620 to dissipate heat is through the package thermal pad and pins to the PCB. Copper leadframe construction used in the INA1620 improves heat dissipation compared to conventional materials. PCB layout greatly affects thermal performance. Connect the INA1620 package thermal pad to a copper pour at the most negative supply potential. This copper pour can be connected to a larger copper plane within the PCB using vias to improve power dissipation. [Figure 45](#) shows an analogous thermal circuit that can be used for approximating the junction temperature of the INA1620. The power dissipated in the INA1620 is represented by current source P_D ; the ambient temperature is represented by voltage source 25°C ; and the junction-to-board and board-to-ambient thermal resistances are represented by resistors $R_{\theta JB}$ and $R_{\theta BA}$, respectively. The board-to-ambient thermal resistance is unique to every application. The sum of $R_{\theta JB}$ and $R_{\theta BA}$ is the junction-to-ambient thermal resistance of the system. The value for junction-to-ambient thermal resistance reported in the [Thermal Information](#) table is determined using the JEDEC standard test PCB. The voltages in the analogous thermal circuit at the points T_J and T_{PCB} represent the INA1620 junction and PCB temperatures, respectively.

Feature Description (continued)

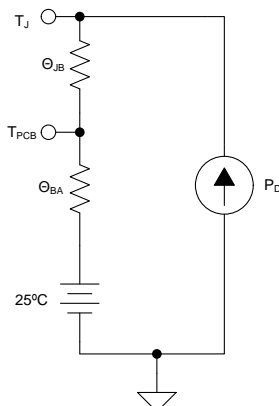

Figure 45. Approximate Thermal System Model of the INA1620 Soldered to a PCB

7.3.3 Thermal Shutdown

If the junction temperature of the INA1620 exceeds 175°C, a thermal shutdown circuit disables the amplifier in order to protect the device from damage. The amplifier is automatically re-enabled after the junction temperature falls below approximately 160°C. If the condition that caused excessive power dissipation has not been removed, the amplifier oscillates between a shutdown and enabled state until the output fault is corrected.

7.3.4 EN Pin

The enable pin (EN) of the INA1620 is used to toggle the amplifier enabled and disabled states. The logic levels defining these two states are: $V_{EN} \leq 0.78 \text{ V}$ (shutdown mode), and $V_{EN} \geq 0.82 \text{ V}$ (enabled). These threshold levels are referenced to the device ground (GND) pin. The EN pin can be driven by a GPIO pin from the system controller, discrete logic gates, or can be connected directly to the V+ supply. Do not leave the EN pin floating because the amplifier is prevented from being enabled. Likewise, do not place GPIO pins used to control the EN pin in a high-impedance state because this placement also prevents the amplifier from being enabled. A small current flows into the enable pin when a voltage is applied. Using the simplified internal schematic shown in Figure 46, use Equation 4 to estimate the enable pin current:

$$I_{EN} = \frac{V_{EN} - 0.7 \text{ V}}{700 \text{ k}\Omega} \quad (4)$$

As illustrated in Figure 46, the EN pin is protected by diodes to the amplifier power supplies. Do not connect the EN pin to voltages outside the limits defined in the [Specifications](#) section.

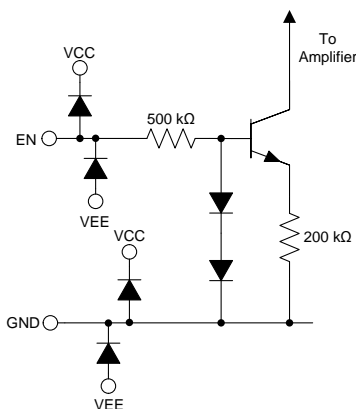

Figure 46. EN Pin Simplified Internal Schematic

Feature Description (continued)

7.3.5 GND Pin

The inclusion of a ground (GND) pin in the INA1620 architecture allows the internal enable circuitry to be referenced to the system ground, eliminating the need for level shifting circuitry in many applications. The internal amplifier compensation capacitors are also referenced to this pin, greatly increasing the ac PSRR. For highest performance, connect the GND pin to a low-impedance reference point with minimal noise present. As shown in [Figure 46](#), the GND pin is protected by ESD diodes to the amplifier power supplies. Do not connect the GND pin to voltages outside the limits defined in the [Specifications](#) section.

7.3.6 Input Protection

The amplifier input pins of the INA1620 are protected from excessive differential voltage with back-to-back diodes, as [Figure 47](#) shows. In most circuit applications, the input protection circuitry has no consequence. However, in low-gain or $G = +1$ circuits, fast-ramping input signals can forward bias these diodes because the output of the amplifier cannot respond quickly enough to the input ramp. If the input signal is fast enough to create this forward-bias condition, the input signal current must be limited to 10 mA or less. If the input signal current is not inherently limited, use an input series resistor (R_I) or a feedback resistor (R_F) to limit the signal input current. This input series resistor degrades the low-noise performance of the INA1620 and is examined in the [Noise Performance](#) section. [Figure 47](#) shows an example configuration when both current-limiting input and feedback resistors are used.

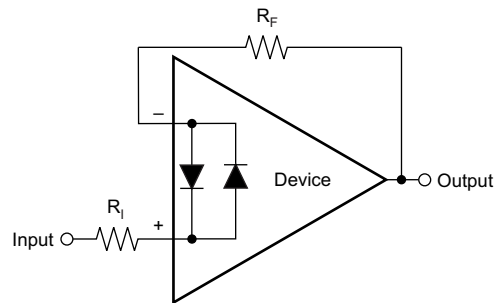

Figure 47. Pulsed Operation

7.4 Device Functional Modes

The INA1620 has two operating modes determined by the voltage between the EN and GND pins: a shutdown mode ($V_{EN} \leq 0.78$ V) and an enabled mode ($V_{EN} \geq 0.82$ V). The measured datasheet performance parameters specified in the [Typical Characteristics](#) and [Specifications](#) sections are given with the amplifier in the enabled mode, unless otherwise noted.

7.4.1 Shutdown Mode

When the EN pin voltage is below the logic low threshold, the INA1620 enters a shutdown mode with minimal power consumption. In this state the output transistors of the amplifier are not powered on. However, do not consider the amplifier output to be high-impedance. Applying signals to the output of the INA1620 while the device is in the shutdown mode can parasitically power the output stage, causing the INA1620 output to draw current.

The INA1620 enable circuitry limits transients at the output when transitioning into or out of shutdown mode. However, small output transients do still accompany this transition, as illustrated in [Figure 48](#) and [Figure 49](#). Note that in both figures the time scale is 1 μ s per division, indicating that the output transients are extremely brief in nature, and therefore not likely to be audible in headphone applications.

Device Functional Modes (continued)

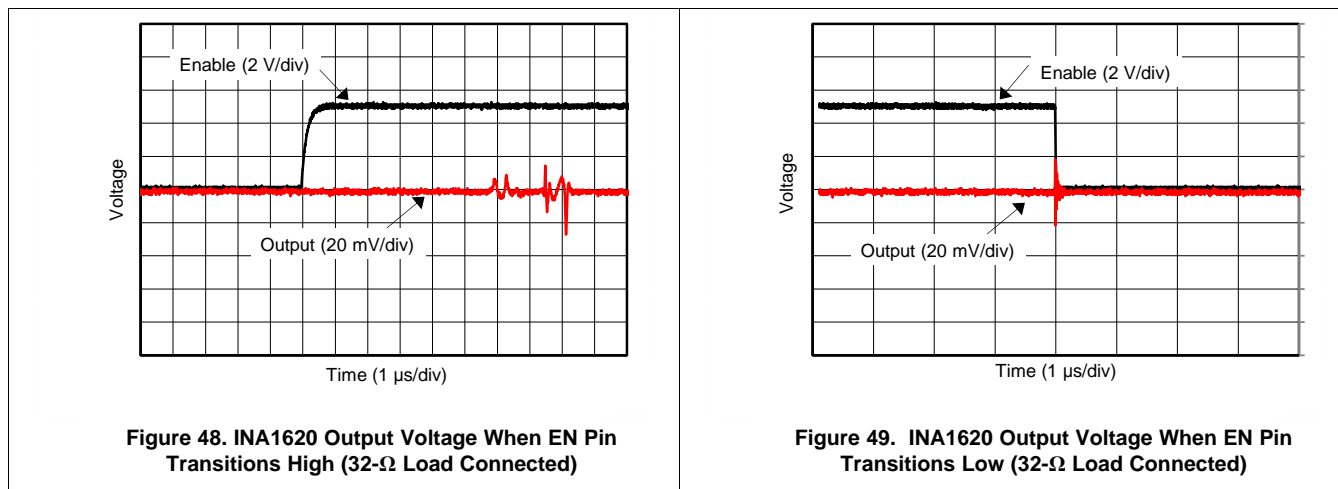

7.4.2 Output Transients During Power Up and Power Down

To minimize the possibility of output transients that might produce an audible *click* or *pop*, ramp the supply voltages for the INA1620 symmetrically to their nominal values. Asymmetrical supply ramping can cause output transients during power up that can be audible in headphone applications. If possible, hold the EN pin low while the power supplies are ramping up or down. If the EN pin is not being independently controlled (for example, by a GPIO pin), use a voltage divider to hold the enable pin voltage below the logic-high threshold until the power supplies reach the specified minimum voltage, as shown in Figure 50.

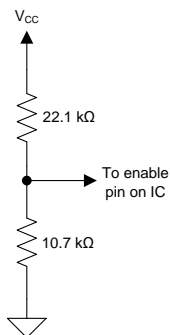

Figure 50. Voltage Divider Used to Hold Enable Low at Power-Up or Power-Down

8 Application and Implementation

NOTE

Information in the following applications sections is not part of the TI component specification, and TI does not warrant its accuracy or completeness. TI's customers are responsible for determining suitability of components for their purposes. Customers should validate and test their design implementation to confirm system functionality.

8.1 Application Information

The low noise and distortion of the INA1620 make the device useful for a variety of applications in professional and consumer audio products. However, these same performance metrics also make the INA1620 useful for industrial, test-and-measurement, and data-acquisition applications. The example shown here is only one possible application where the INA1620 provides exceptional performance.

8.1.1 Noise Performance

Figure 51 shows the total circuit noise for varying source impedances with the op amp in a unity-gain configuration (no feedback resistor network, and therefore no additional noise contributions).

The INA1620 is shown with total circuit noise calculated. The op amp contributes both a voltage noise component and a current noise component. The voltage noise is commonly modeled as a time-varying component of the offset voltage. The current noise is modeled as the time-varying component of the input bias current, and reacts with the source resistance to create a voltage component of noise. Therefore, the lowest noise op amp for a given application depends on the source impedance. For low source impedance, current noise is negligible, and voltage noise generally dominates. The low voltage and current noise of the INA1620 internal op amps make the device an excellent choice for use in applications where the source impedance is less than 10 kΩ as shown in Figure 51.

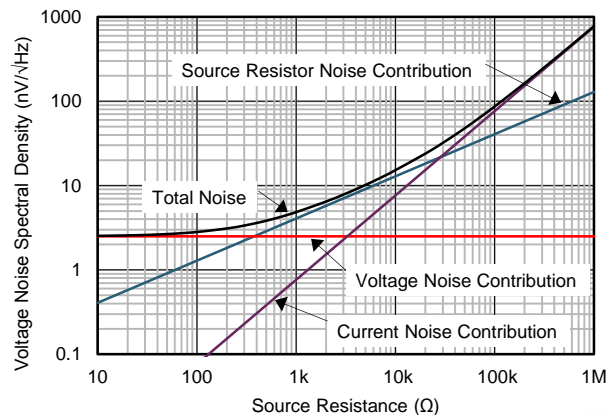

Figure 51. Noise Performance of the INA1620 Internal Amplifiers

Application Information (continued)

8.1.2 Resistor Tolerance

The INA1620 integrated resistor pairs use an advanced thin film process to create resistor pairs that have excellent matching. Each specific resistor pair is specifically designed for accurate matching between the two resistors. Figure 42 shows the distribution of resistor matching for a typical device population. The equation used to calculate matching between resistors in a pair is shown in Equation 5.

$$\text{Resistor Ratio Matching (\%)} = \frac{R_{XA} - R_{XB}}{\text{Average}(R_{XA}, R_{XB})} \times 100 \tag{5}$$

In addition to excellent matching between resistors in each resistor pair, all resistors on a single INA1620 achieve good matching due to inherent process matching across each device. Figure 52 shows a typical distribution of the worst-case matching across all resistors on a single INA1620. The matching was calculated using the highest value resistance on a device matched with the lowest resistance value on the same device.

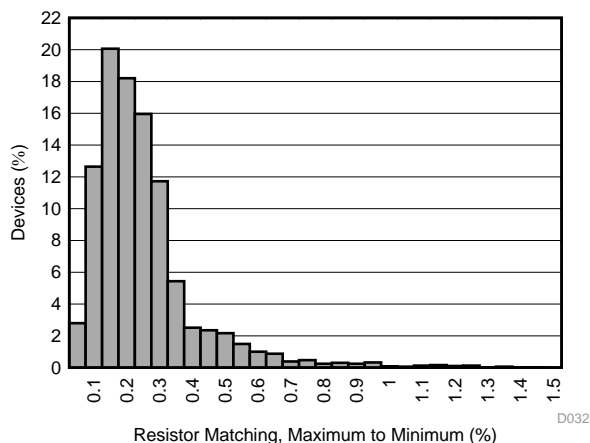

Figure 52. Matching Histogram, Maximum to Minimum

8.1.3 EMI Rejection

The electromagnetic interference (EMI) rejection ratio, or EMIRR, describes the EMI immunity of operational amplifiers. An adverse effect that is common to many op amps is a change in the offset voltage as a result of RF signal rectification. An op amp that is more efficient at rejecting this change in offset as a result of EMI has a higher EMIRR and is quantified by a decibel value. Measuring EMIRR can be performed in many ways, but this section provides the EMIRR IN+, which specifically describes the EMIRR performance when the RF signal is applied to the noninverting input pin of the op amp. In general, only the noninverting input is tested for EMIRR for the following three reasons:

- Op amp input pins are known to be the most sensitive to EMI, and typically rectify RF signals better than the supply or output pins.
- The noninverting and inverting op amp inputs have symmetrical physical layouts and exhibit approximately matching EMIRR performance.
- EMIRR is easier to measure on noninverting pins than on other pins because the noninverting input pin can be isolated on a PCB. This isolation allows the RF signal to be applied directly to the noninverting input terminal with no complex interactions from other components or connecting PCB traces.

High-frequency signals conducted or radiated to any pin of the operational amplifier result in adverse effects, as the amplifier does not have sufficient loop gain to correct for signals with spectral content outside its bandwidth. Conducted or radiated EMI on inputs, power supply, or output may result in unexpected DC offsets, transient voltages, or other unknown behavior. Take care to properly shield and isolate sensitive analog nodes from noisy radio signals and digital clocks and interfaces.

The EMIRR IN+ of the INA1620 amplifiers is plotted versus frequency as shown in Figure 53. See also *EMI Rejection Ratio of Operational Amplifiers*, available for download from www.ti.com.

Application Information (continued)

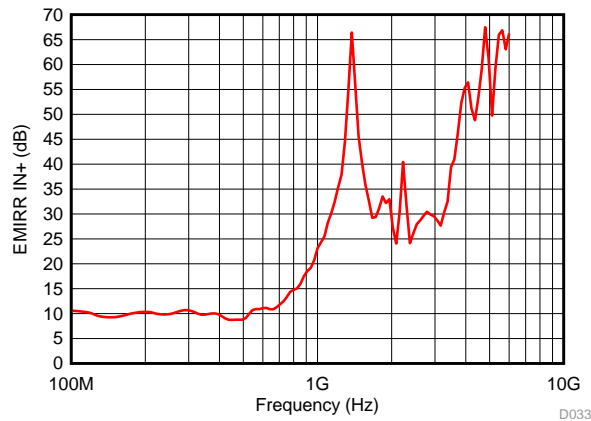

Figure 53. INA1620 EMIRR IN+

Table 1 lists the EMIRR IN+ values for the INA1620 at particular frequencies commonly encountered in real-world applications. Applications listed in Table 1 may be centered on or operated near the particular frequency shown. This information may be of special interest to designers working with these types of applications, or working in other fields likely to encounter RF interference from broad sources, such as the industrial, scientific, and medical (ISM) radio band.

Table 1. INA1620 EMIRR IN+ for Frequencies of Interest

FREQUENCY	APPLICATION OR ALLOCATION	EMIRR IN+
900 MHz	Global system for mobile communications (GSM) applications, radio communication, navigation, GPS (to 1.6 GHz), GSM, aeronautical mobile, UHF applications	18 dB
1.8 GHz	GSM applications, mobile personal communications, broadband, satellite, L-band (1 GHz to 2 GHz)	33 dB
2.4 GHz	802.11b, 802.11g, 802.11n, Bluetooth®, mobile personal communications, industrial, scientific and medical (ISM) radio band, amateur radio and satellite, S-band (2 GHz to 4 GHz)	26 dB
3.6 GHz	Radiolocation, aero communication and navigation, satellite, mobile, S-band	40 dB
5 GHz	802.11a, 802.11n, aero communication and navigation, mobile communication, space and satellite operation, C-band (4 GHz to 8 GHz)	55 dB

8.1.4 EMIRR +IN Test Configuration

Figure 54 shows the circuit configuration for testing the EMIRR IN+. An RF source connects to the op amp noninverting input pin using a transmission line. The op amp is configured in a unity-gain buffer topology with the output connected to a low-pass filter (LPF) and a digital multimeter (DMM). A large impedance mismatch at the op amp input causes a voltage reflection; however, this effect is characterized and accounted for when determining the EMIRR IN+. A multimeter samples and measures the resulting DC offset voltage. The LPF isolates the multimeter from residual RF signals that may interfere with multimeter accuracy.

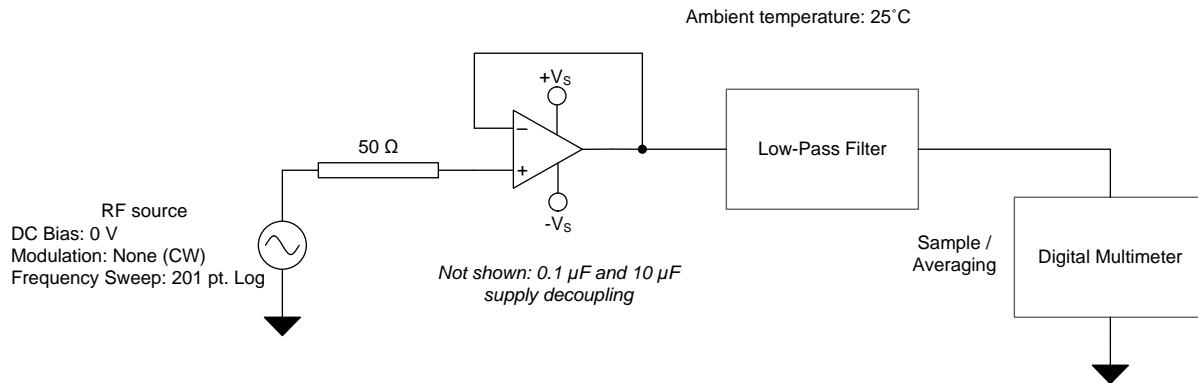

Figure 54. EMIRR +IN Test Configuration

8.2 Typical Application

The low distortion and high output-current capabilities of the INA1620 make this device an excellent choice for headphone-amplifier applications in portable or studio applications. These applications typically employ an audio digital-to-analog converter (DAC) and a separate headphone amplifier circuit connected to the DAC output. High-performance audio DACs can have an output signal that is either a varying current or voltage. Voltage output configurations require less external circuitry, and therefore have advantages in cost, power consumption, and solution size. However, these configurations can offer slightly lower performance than current output configurations. Differential outputs are standard on both types of DACs. Differential outputs double the output signal levels that can be delivered on a single, low-voltage supply, and also allow for even-harmonics common to both outputs to be cancelled by external circuitry. A simplified representation of a voltage-output audio DAC is shown in Figure 55. Two ac voltage sources (V_{AC}) deliver the output signal to the complementary outputs through their associated output impedances (R_{OUT}). Both output signals have a dc component as well, represented by dc voltage source V_{DC} . The headphone amplifier circuit connected to the output of an audio DAC must convert the differential output into a single-ended signal and be capable of producing signals of sufficient amplitude at the headphones to achieve reasonable listening levels.

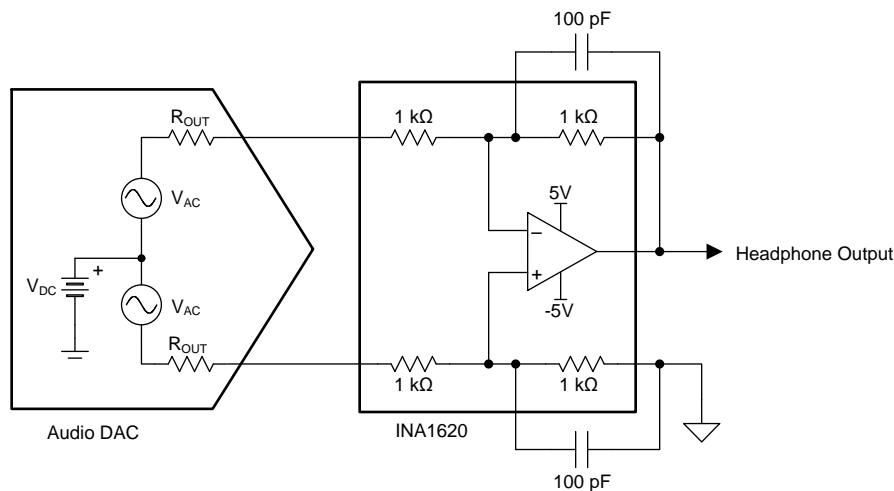

Figure 55. INA1620 Used as a Headphone Amplifier for a Voltage-Output Audio DAC

8.2.1 Design Requirements

- ± 5 -V power supplies
- 150-mW output power (32- Ω load)
- < -110 -dB THD+N at maximum output (32- Ω load)
- < 0.01 -dB magnitude deviation (20 Hz to 20 kHz)

8.2.2 Detailed Design Procedure

Figure 55 shows a schematic of a headphone amplifier circuit for voltage output DACs. An op amp is configured as a difference amplifier that converts the differential output voltage to single-ended.

The gain of the difference amplifier in Figure 55 is determined by the resistor values, and includes the output impedance of the DAC. For $R_2 = R_4$ and $R_1 = R_3$, the output voltage of the headphone amplifier circuit is shown in Equation 6:

$$V_{OUT} = V_{DAC} \frac{R_2}{R_1 + R_{OUT}} \quad (6)$$

The output voltage required for headphones depends on the headphone impedance, as well as the headphone efficiency (η), a measure of the sound pressure level (SPL, measured in dB) for a certain input power level (typically given at 1 mW). The headphone SPL at other power levels is calculated using Equation 7:

Typical Application (continued)

$$SPL(dB) = \eta + 10\log\left(\frac{P_{IN}}{1 \text{ mW}}\right)$$

where

- η = efficiency
- P_{IN} = input power to the headphones

(7)

Figure 56 shows the input power required to produce certain SPLs for different headphone efficiencies. Typically, over-the-ear style headphones have lower efficiencies than in-ear types with 95 dB/mW being a common value.

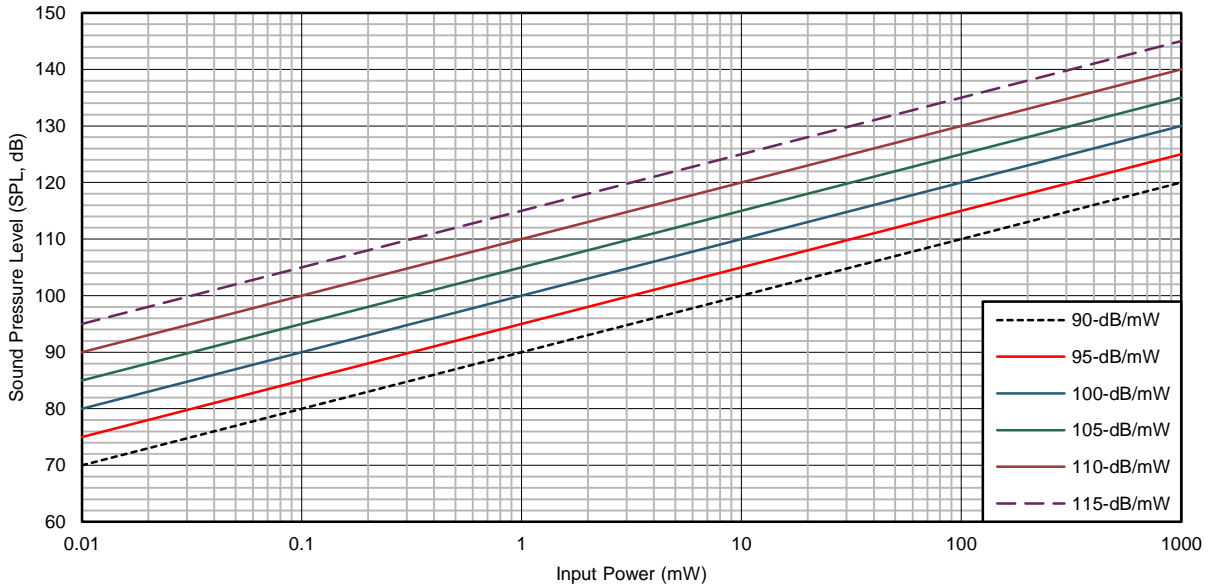

Figure 56. Sound Pressure Level vs Input Power for Headphones of Various Efficiencies

In-ear headphones can have efficiencies of 115 dB/mW or greater, and therefore have much lower power requirements. The output power goal for this design is 150 mW — sufficient power to produce extremely loud sound pressure levels in a wide range of headphones. A 32-Ω headphone impedance is used for this requirement because 32 Ω is a very common value in headphones for portable applications. Equation 8 shows the voltage required for 32-Ω headphones:

$$V_O = \sqrt{P \times R} = \sqrt{150 \text{ mW} \times 32 \Omega} = 2.191 V_{RMS} \tag{8}$$

Capacitors C_1 and C_2 limit the bandwidth of the circuit to prevent the unnecessary amplification of interfering signals. The maximum value of these capacitors is determined by the limitations on frequency response magnitude deviation detailed in the Design Requirements section. C_1 and C_2 combine with resistors R_2 and R_4 to form a pole, as shown in Equation 9:

$$f_p = \frac{1}{2\pi(R_2, R_4)(C_1, C_2)} \tag{9}$$

Calculate the minimum pole frequency allowable to meet the magnitude deviation requirements using Equation 10:

$$f_p \geq \frac{f}{\sqrt{\left(\frac{1}{G}\right)^2 - 1}} \geq \frac{20 \text{ kHz}}{\sqrt{\left(\frac{1}{0.999}\right)^2 - 1}} \geq 416.6 \text{ kHz}$$

where

- G represents the gain in decimal for a -0.01-dB deviation at 20 kHz.

(10)

Typical Application (continued)

Use Equation 11 to calculate the upper limit for the value of C_1 and C_2 in order to meet the goal for minimal magnitude deviation at 20 kHz.

$$C_1, C_2 \leq \frac{1}{2\pi(R_2, R_4)F_p} \leq \frac{1}{2\pi(1\text{ k}\Omega)(416.6\text{ kHz})} \leq 382\text{ pF} \tag{11}$$

For this design, 100-pF capacitors were used because they meet the design requirements for amplitude deviation in the audio bandwidth.

8.2.3 Application Curves

Figure 57 shows the maximum output voltage achievable for a 32-Ω load before the onset of clipping ($\pm 5\text{-V}$ supplies), indicated by a sharp increase in distortion. As more current is delivered by the output transistors of an amplifier, additional distortion is produced. At low frequencies, this distortion is corrected by the feedback loop of the amplifier. However, as the loop gain of the amplifier begins to decline at high frequencies, the overall distortion begins to climb. The unique output stage design of the INA1620 greatly reduces the additional distortion at high frequency when delivering large currents, as shown in Figure 58. High-order harmonics (above the 2nd and 3rd) are also kept to a minimal level at high output powers, as shown in Figure 59.

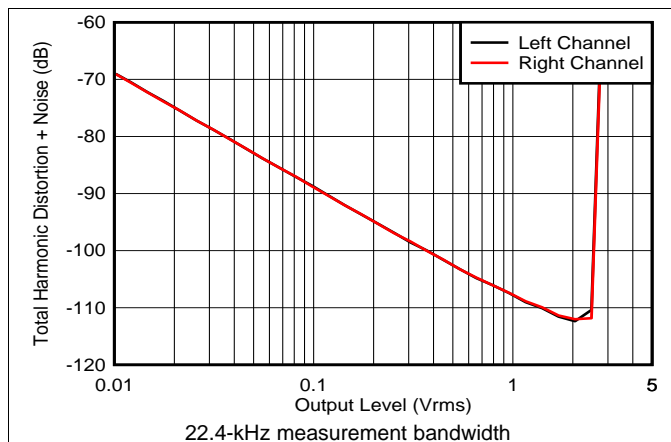

Figure 57. THD+N vs Output Voltage for a 32-Ω Load

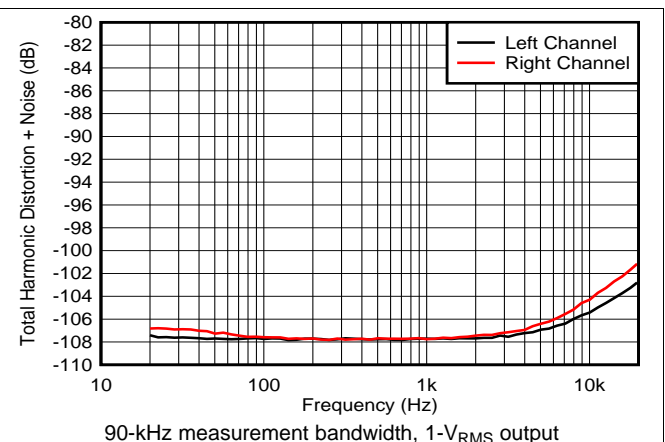

Figure 58. THD+N vs Frequency for a 32-Ω Load

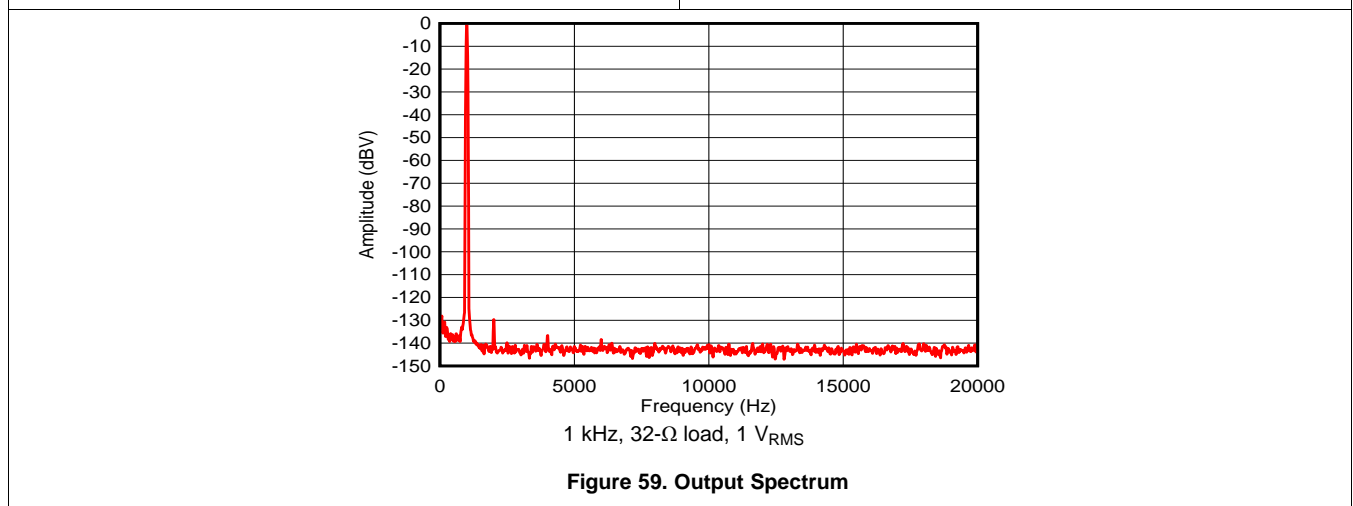
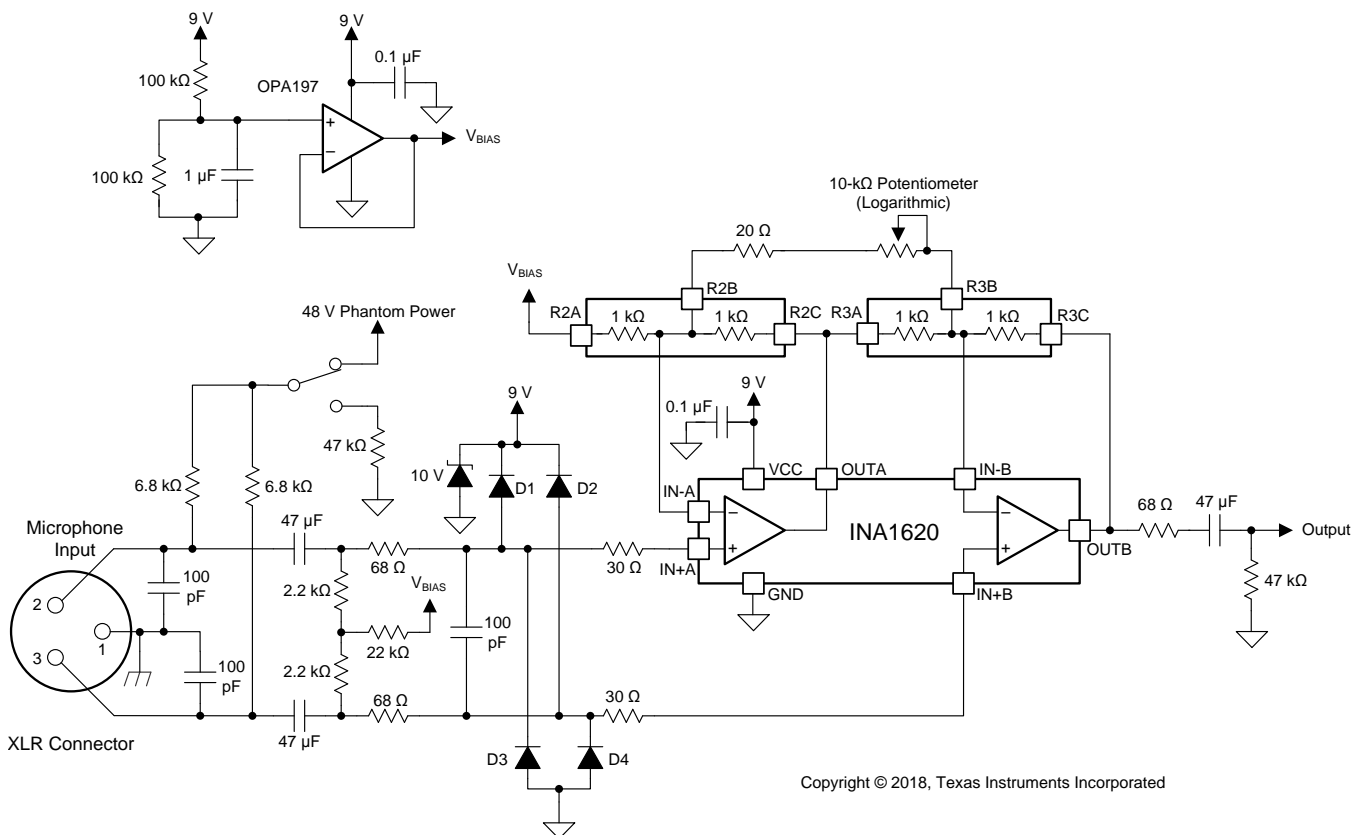

Figure 59. Output Spectrum

8.3 Other Application Examples

8.3.1 Preampifier for Professional Microphones

Figure 60 shows a preamplifier designed for high performance applications that require low-noise and high common-mode rejection. Both channels of the INA1620 are configured as a two-op amp instrumentation amplifier with a variable gain from 6 to 40 dB. The excellent matching of the integrated 1kΩ resistors allows for high common-mode rejection in the circuit. An OPA197 is configured as a buffered power supply divider to provide a biasing voltage to the circuit, allowing the system to operate properly on a single 9-V battery. The additional components at the INA1620 inputs are for phantom power, EMI, and ESD protection.



Copyright © 2018, Texas Instruments Incorporated

Figure 60. Preampifier for Professional Microphones

9 Power Supply Recommendations

The INA1620 operates from $\pm 2\text{-V}$ to $\pm 18\text{-V}$ supplies, while maintaining excellent performance. However, some applications do not require equal positive and negative output voltage swing. With the INA1620, power-supply voltages do not need to be equal. For example, the positive supply could be set to 25 V with the negative supply at -5 V .

In all cases, the common-mode voltage must be maintained within the specified range. Key parameters are specified over the temperature range of $T_A = -40^\circ\text{C}$ to 125°C . Parameters that vary with operating voltage or temperature are shown in the [Typical Characteristics](#) section.

10 Layout

10.1 Layout Guidelines

For best operational performance of the device, use good printed circuit board (PCB) layout practices, including:

- Connect low-ESR, $0.1\text{-}\mu\text{F}$ ceramic bypass capacitors between each supply pin and ground, placed as close as possible to the device. A single bypass capacitor from V_+ to ground is applicable for single-supply applications. The bypass capacitors are used to reduce the coupled noise by providing low-impedance power sources local to the analog circuitry, because noise can propagate into analog circuitry through the power pins of the circuit as a whole and the op amp specifically.
- Connect the device ground pin to a low-impedance, low-noise, system reference point, such as an analog ground.
- Place the external components as close to the device as possible. As shown in [Figure 61](#), keep feedback resistors close to the inverting input to minimize parasitic capacitance and the feedback loop area.
- Keep the length of input traces as short as possible. Always remember that the input traces are the most sensitive part of the circuit.
- For proper amplifier function, connect the package thermal pad to the most negative supply voltage (VEE).

10.2 Layout Example

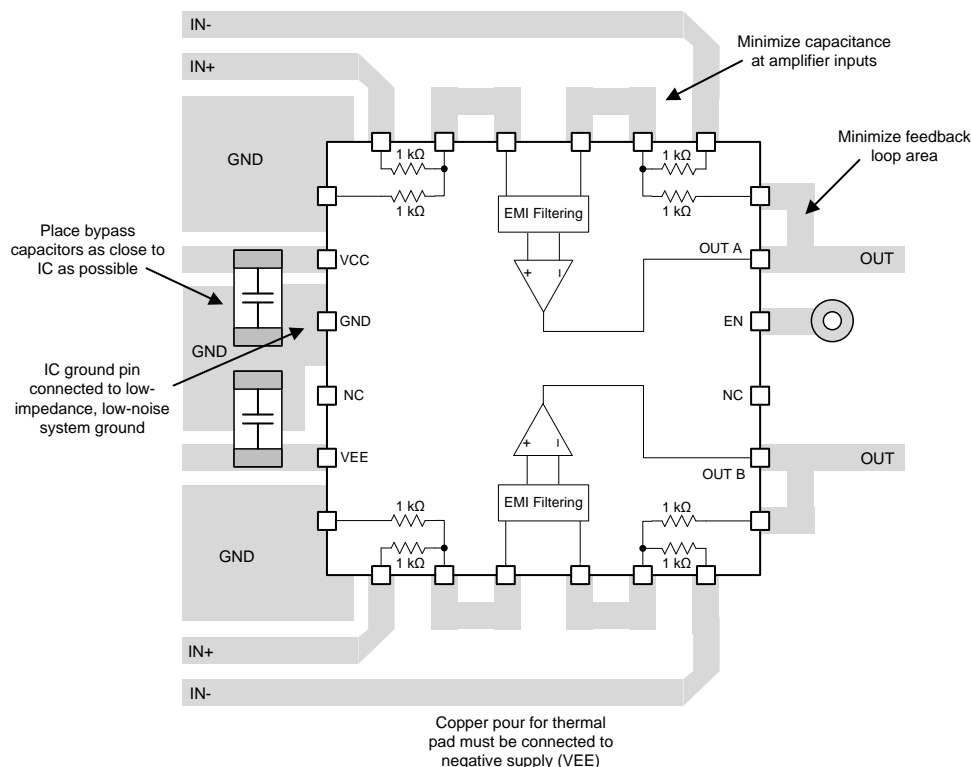

Figure 61. Board Layout for a Difference Amplifier Configuration

11 Device and Documentation Support

11.1 Device Support

11.1.1 Development Support

11.1.1.1 TINA-TI™ (Free Software Download)

TINA-TI software is a simple, powerful, and easy-to-use circuit simulation program based on a SPICE engine. TINA-TI software is a free, fully-functional version of the TINA software, preloaded with a library of macro models in addition to a range of both passive and active models. TINA-TI provides all the conventional dc, transient, and frequency domain analysis of SPICE, as well as additional design capabilities.

Available as a [free download](#) from the Analog eLab Design Center, TINA-TI software offers extensive post-processing capability that allows users to format results in a variety of ways. Virtual instruments offer the ability to select input waveforms and probe circuit nodes, voltages, and waveforms, creating a dynamic quick-start tool.

NOTE

These files require that either the TINA software (from DesignSoft™) or TINA-TI software be installed. Download the free TINA-TI software from the [TINA-TI folder](#).

11.1.1.2 TI Precision Designs

TI Precision Designs are available online at <http://www.ti.com/ww/en/analog/precision-designs/>. TI Precision Designs are analog solutions created by TI's precision analog applications experts and offer the theory of operation, component selection, simulation, complete PCB schematic and layout, bill of materials, and measured performance of many useful circuits.

11.2 Documentation Support

11.2.1 Related Documentation

For related documentation see the following:

- [Feedback Plots Define Op Amp AC Performance](#)
- [Circuit Board Layout Techniques, SLOA089](#)
- [Headphone Amplifier for Voltage-Output Audio DACs Reference Design](#)
- [Stabilizing Difference Amplifiers for Headphone Applications](#)
- [Reducing Distortion from CMOS Analog Switches](#)
- [EMI Rejection Ratio of Operational Amplifiers](#)
- [HiFi Audio Circuit Design](#)

11.3 Receiving Notification of Documentation Updates

To receive notification of documentation updates, find the device product folder on ti.com. In the upper right corner, click on *Alert me* to receive a weekly digest of any product information that has changed. For change details, see the revision history included in any revised document.

11.4 Community Resources

The following links connect to TI community resources. Linked contents are provided "AS IS" by the respective contributors. They do not constitute TI specifications and do not necessarily reflect TI's views; see TI's [Terms of Use](#).

TI E2E™ Online Community *TI's Engineer-to-Engineer (E2E) Community*. Created to foster collaboration among engineers. At e2e.ti.com, you can ask questions, share knowledge, explore ideas and help solve problems with fellow engineers.

Design Support *TI's Design Support* Quickly find helpful E2E forums along with design support tools and contact information for technical support.

11.5 Trademarks

E2E is a trademark of Texas Instruments.

TINA-TI is a trademark of Texas Instruments, Inc and DesignSoft, Inc.

Bluetooth is a registered trademark of Bluetooth SIG, Inc.

DesignSoft is a trademark of DesignSoft, Inc.

All other trademarks are the property of their respective owners.

11.6 Electrostatic Discharge Caution



These devices have limited built-in ESD protection. The leads should be shorted together or the device placed in conductive foam during storage or handling to prevent electrostatic damage to the MOS gates.

11.7 Glossary

[SLYZ022](#) — *TI Glossary*.

This glossary lists and explains terms, acronyms, and definitions.

12 Mechanical, Packaging, and Orderable Information

The following pages include mechanical, packaging, and orderable information. This information is the most current data available for the designated devices. This data is subject to change without notice and revision of this document. For browser-based versions of this data sheet, refer to the left-hand navigation.

PACKAGING INFORMATION

Orderable Device	Status (1)	Package Type	Package Drawing	Pins	Package Qty	Eco Plan (2)	Lead finish/ Ball material (6)	MSL Peak Temp (3)	Op Temp (°C)	Device Marking (4/5)	Samples
INA1620RTWR	ACTIVE	WQFN	RTW	24	3000	RoHS & Green	NIPDAU	Level-1-260C-UNLIM	-40 to 125	INA1620	Samples
INA1620RTWT	ACTIVE	WQFN	RTW	24	250	RoHS & Green	NIPDAU	Level-1-260C-UNLIM	-40 to 125	INA1620	Samples

(1) The marketing status values are defined as follows:

ACTIVE: Product device recommended for new designs.

LIFEBUY: TI has announced that the device will be discontinued, and a lifetime-buy period is in effect.

NRND: Not recommended for new designs. Device is in production to support existing customers, but TI does not recommend using this part in a new design.

PREVIEW: Device has been announced but is not in production. Samples may or may not be available.

OBSELETE: TI has discontinued the production of the device.

(2) **RoHS:** TI defines "RoHS" to mean semiconductor products that are compliant with the current EU RoHS requirements for all 10 RoHS substances, including the requirement that RoHS substance do not exceed 0.1% by weight in homogeneous materials. Where designed to be soldered at high temperatures, "RoHS" products are suitable for use in specified lead-free processes. TI may reference these types of products as "Pb-Free".

RoHS Exempt: TI defines "RoHS Exempt" to mean products that contain lead but are compliant with EU RoHS pursuant to a specific EU RoHS exemption.

Green: TI defines "Green" to mean the content of Chlorine (Cl) and Bromine (Br) based flame retardants meet JS709B low halogen requirements of <=1000ppm threshold. Antimony trioxide based flame retardants must also meet the <=1000ppm threshold requirement.

(3) MSL, Peak Temp. - The Moisture Sensitivity Level rating according to the JEDEC industry standard classifications, and peak solder temperature.

(4) There may be additional marking, which relates to the logo, the lot trace code information, or the environmental category on the device.

(5) Multiple Device Markings will be inside parentheses. Only one Device Marking contained in parentheses and separated by a "~" will appear on a device. If a line is indented then it is a continuation of the previous line and the two combined represent the entire Device Marking for that device.

(6) Lead finish/Ball material - Orderable Devices may have multiple material finish options. Finish options are separated by a vertical ruled line. Lead finish/Ball material values may wrap to two lines if the finish value exceeds the maximum column width.

Important Information and Disclaimer:The information provided on this page represents TI's knowledge and belief as of the date that it is provided. TI bases its knowledge and belief on information provided by third parties, and makes no representation or warranty as to the accuracy of such information. Efforts are underway to better integrate information from third parties. TI has taken and continues to take reasonable steps to provide representative and accurate information but may not have conducted destructive testing or chemical analysis on incoming materials and chemicals. TI and TI suppliers consider certain information to be proprietary, and thus CAS numbers and other limited information may not be available for release.

In no event shall TI's liability arising out of such information exceed the total purchase price of the TI part(s) at issue in this document sold by TI to Customer on an annual basis.

GENERIC PACKAGE VIEW

RTW 24

WQFN - 0.8 mm max height

4 x 4, 0.5 mm pitch

PLASTIC QUAD FLATPACK - NO LEAD

This image is a representation of the package family, actual package may vary.
Refer to the product data sheet for package details.

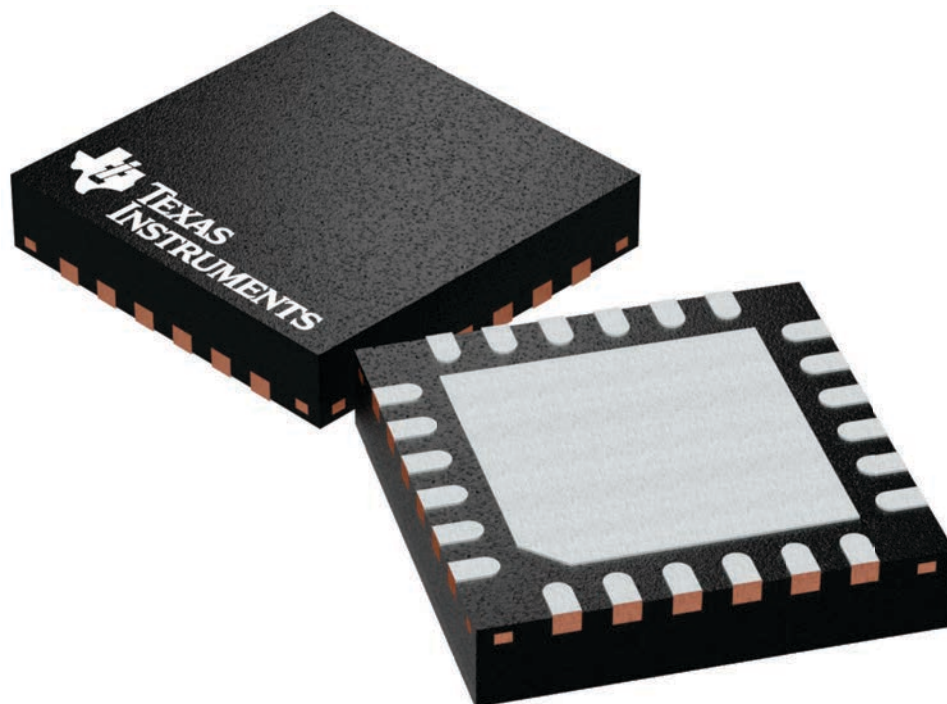

4224801/A

RTW (S-PWQFN-N24)

PLASTIC QUAD FLATPACK NO-LEAD

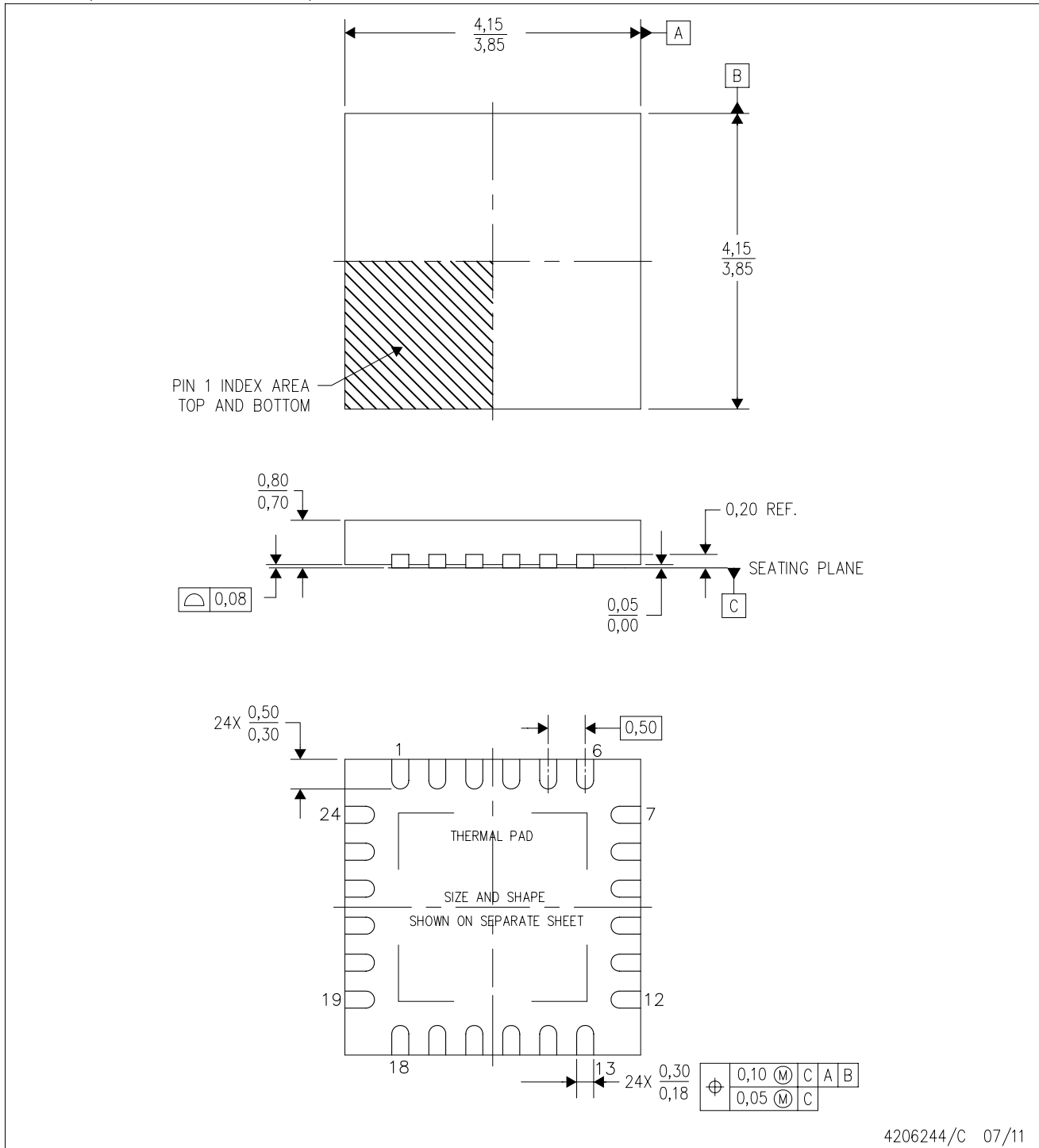

4206244/C 07/11

- NOTES:
- A. All linear dimensions are in millimeters. Dimensioning and tolerancing per ASME Y14.5M-1994.
 - B. This drawing is subject to change without notice.
 - C. Quad Flatpack, No-Leads (QFN) package configuration.
 - D. The package thermal pad must be soldered to the board for thermal and mechanical performance.
 - E. See the additional figure in the Product Data Sheet for details regarding the exposed thermal pad features and dimensions.
 - F. Falls within JEDEC MO-220.

THERMAL INFORMATION

This package incorporates an exposed thermal pad that is designed to be attached directly to an external heatsink. The thermal pad must be soldered directly to the printed circuit board (PCB). After soldering, the PCB can be used as a heatsink. In addition, through the use of thermal vias, the thermal pad can be attached directly to the appropriate copper plane shown in the electrical schematic for the device, or alternatively, can be attached to a special heatsink structure designed into the PCB. This design optimizes the heat transfer from the integrated circuit (IC).

For information on the Quad Flatpack No-Lead (QFN) package and its advantages, refer to Application Report, QFN/SON PCB Attachment, Texas Instruments Literature No. SLUA271. This document is available at www.ti.com.

The exposed thermal pad dimensions for this package are shown in the following illustration.

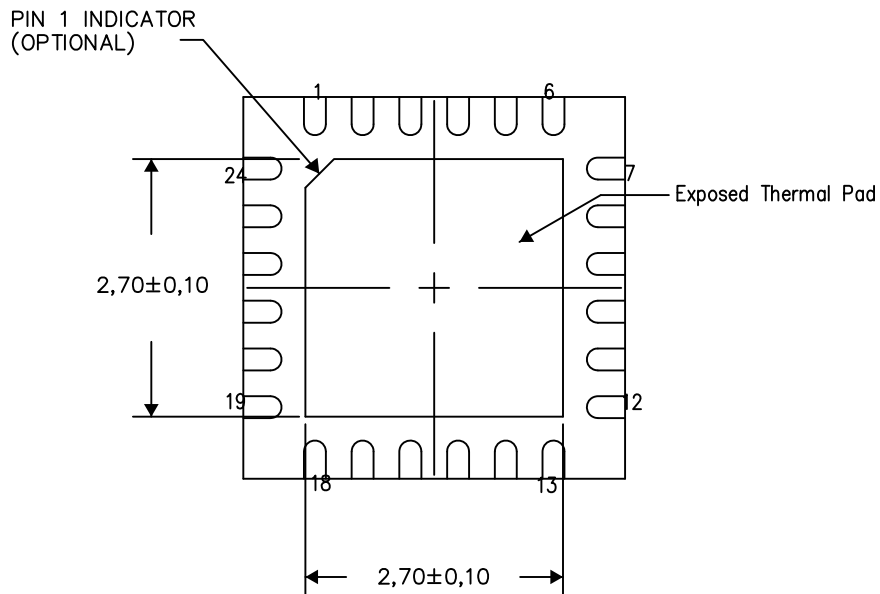

Bottom View

Exposed Thermal Pad Dimensions

4206249-5/P 05/15

NOTES: A. All linear dimensions are in millimeters

RTW (S-PWQFN-N24)

PLASTIC QUAD FLATPACK NO-LEAD

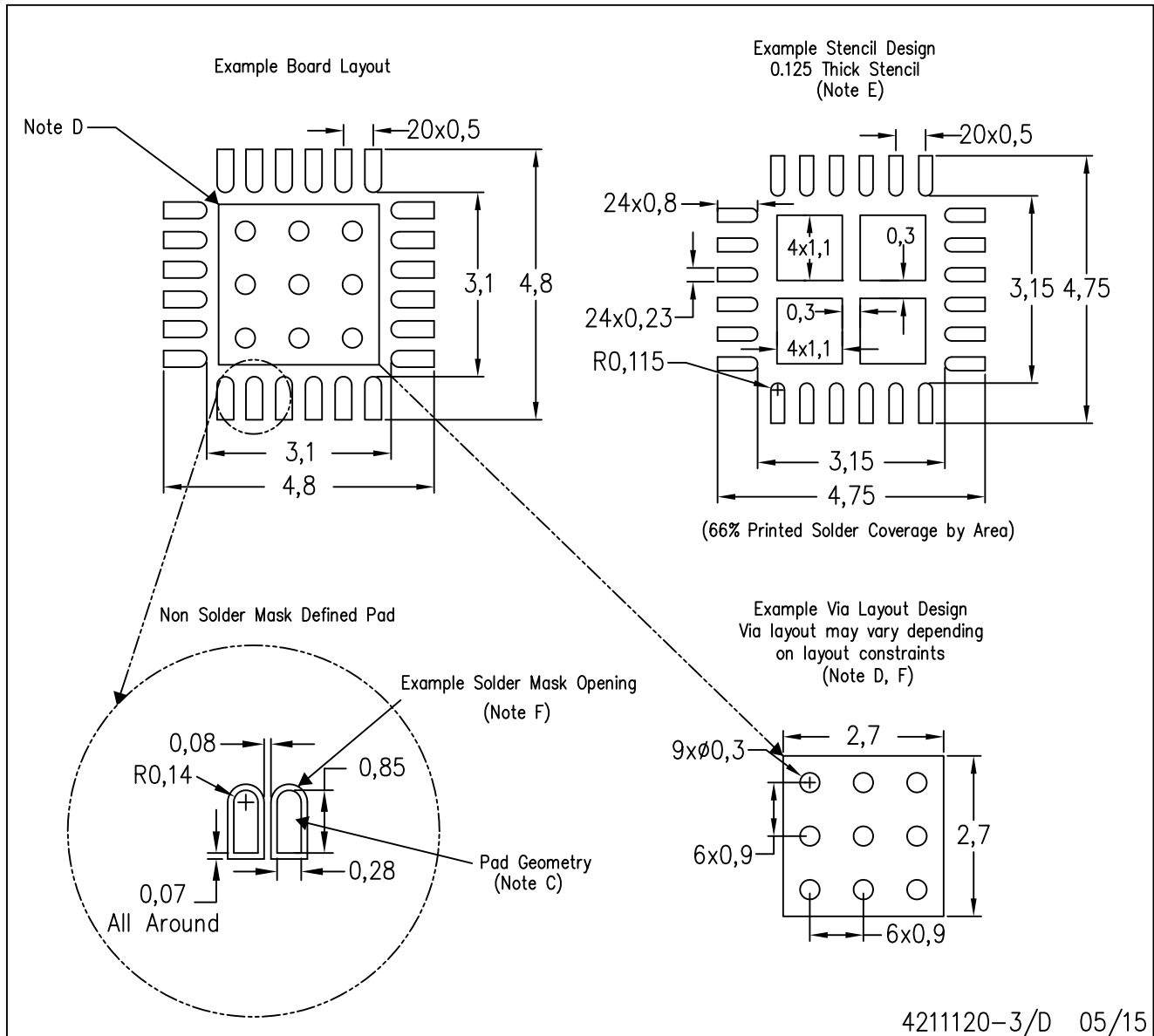

- NOTES:
- A. All linear dimensions are in millimeters.
 - B. This drawing is subject to change without notice.
 - C. Publication IPC-7351 is recommended for alternate designs.
 - D. This package is designed to be soldered to a thermal pad on the board. Refer to Application Note, Quad Flat-Pack Packages, Texas Instruments Literature No. SLUA271, and also the Product Data Sheets for specific thermal information, via requirements, and recommended board layout. These documents are available at www.ti.com <<http://www.ti.com>>.
 - E. Laser cutting apertures with trapezoidal walls and also rounding corners will offer better paste release. Customers should contact their board assembly site for stencil design recommendations. Refer to IPC 7525 for stencil design considerations.
 - F. Customers should contact their board fabrication site for recommended solder mask tolerances and via tenting recommendations for vias placed in the thermal pad.

IMPORTANT NOTICE AND DISCLAIMER

TI PROVIDES TECHNICAL AND RELIABILITY DATA (INCLUDING DATA SHEETS), DESIGN RESOURCES (INCLUDING REFERENCE DESIGNS), APPLICATION OR OTHER DESIGN ADVICE, WEB TOOLS, SAFETY INFORMATION, AND OTHER RESOURCES "AS IS" AND WITH ALL FAULTS, AND DISCLAIMS ALL WARRANTIES, EXPRESS AND IMPLIED, INCLUDING WITHOUT LIMITATION ANY IMPLIED WARRANTIES OF MERCHANTABILITY, FITNESS FOR A PARTICULAR PURPOSE OR NON-INFRINGEMENT OF THIRD PARTY INTELLECTUAL PROPERTY RIGHTS.

These resources are intended for skilled developers designing with TI products. You are solely responsible for (1) selecting the appropriate TI products for your application, (2) designing, validating and testing your application, and (3) ensuring your application meets applicable standards, and any other safety, security, regulatory or other requirements.

These resources are subject to change without notice. TI grants you permission to use these resources only for development of an application that uses the TI products described in the resource. Other reproduction and display of these resources is prohibited. No license is granted to any other TI intellectual property right or to any third party intellectual property right. TI disclaims responsibility for, and you will fully indemnify TI and its representatives against, any claims, damages, costs, losses, and liabilities arising out of your use of these resources.

TI's products are provided subject to [TI's Terms of Sale](#) or other applicable terms available either on ti.com or provided in conjunction with such TI products. TI's provision of these resources does not expand or otherwise alter TI's applicable warranties or warranty disclaimers for TI products.

TI objects to and rejects any additional or different terms you may have proposed.

Mailing Address: Texas Instruments, Post Office Box 655303, Dallas, Texas 75265
Copyright © 2022, Texas Instruments Incorporated