

## LM330-N 3-Terminal Positive Regulator

 Check for Samples: [LM330-N](#)

### FEATURES

- Input-output Differential Less than 0.6V
- Output Current of 150 mA
- Reverse Battery Protection
- Line Transient Protection
- Internal Short Circuit Current Limit
- Internal Thermal Overload Protection
- Mirror-image Insertion Protection
- P<sup>+</sup> Product Enhancement Tested

### DESCRIPTION

The LM330-N 5V 3-terminal positive voltage regulator features an ability to source 150 mA of output current with an input-output differential of 0.6V or less. Familiar regulator features such as current limit and thermal overload protection are also provided.

The low dropout voltage makes the LM330-N useful for certain battery applications since this feature allows a longer battery discharge before the output falls out of regulation. For example, a battery supplying the regulator input voltage may discharge to 5.6V and still properly regulate the system and load voltage. Supporting this feature, the LM330-N protects both itself and regulated systems from negative voltage inputs resulting from reverse installations of batteries.

Other protection features include line transient protection up to 26V, when the output actually shuts down to avoid damaging internal and external circuits. Also, the LM330-N regulator cannot be harmed by a temporary mirror-image insertion.

### Schematic and Connection Diagrams

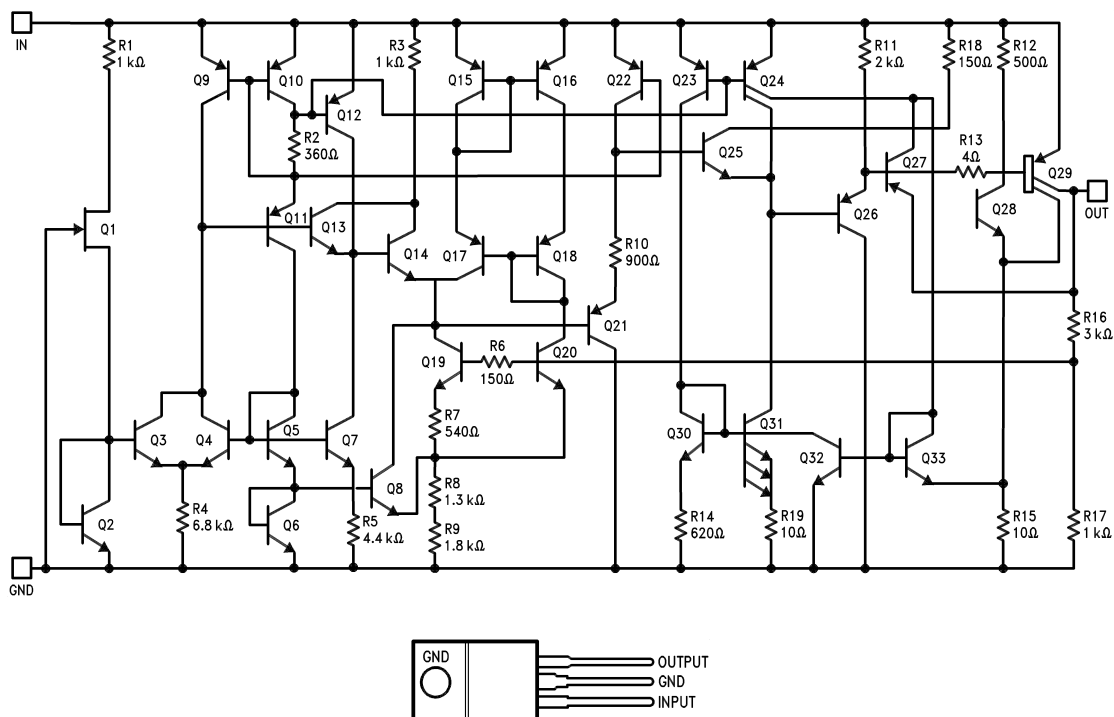

**Figure 1. (TO-220)  
Plastic Package  
Front View**

See Package Number NDE0003B



Please be aware that an important notice concerning availability, standard warranty, and use in critical applications of Texas Instruments semiconductor products and disclaimers thereto appears at the end of this data sheet.

All trademarks are the property of their respective owners.



These devices have limited built-in ESD protection. The leads should be shorted together or the device placed in conductive foam during storage or handling to prevent electrostatic damage to the MOS gates.

### Absolute Maximum Ratings<sup>(1)(2)</sup>

Input Voltage	
Operating Range	26V
Line Transient Protection (1000 ms)	40V
Internal Power Dissipation	Internally Limited
Operating Temperature Range	0°C to +70°C
Maximum Junction Temperature	+125°C
Storage Temperature Range	-65°C to +150°C
Lead Temperature	
(Soldering, 10 sec.)	+300°C

- (1) "Absolute Maximum Ratings" indicate limits beyond which damage to the device may occur. Operating Ratings indicate conditions for which the device is functional, but do not ensure specific performance limits.
- (2) If Military/Aerospace specified devices are required, please contact the Texas Instruments Sales Office/Distributors for availability and specifications.

### Electrical Characteristics<sup>(1)</sup>

Symbol	Parameter	Conditions	Min	Typ	Max	Units
$V_o$	Output Voltage	$T_j = 25^\circ\text{C}$	4.8	5	5.2	V
	Output Voltage Over Temp	$5 < I_o < 150 \text{ mA}$ $6 < V_{IN} < 26\text{V}; 0^\circ\text{C} \leq T_j \leq 100^\circ\text{C}$	4.75		5.25	
$\Delta V_o$	Line Regulation	$9 < V_{IN} < 16\text{V}, I_o = 5 \text{ mA}$ $6 < V_{IN} < 26\text{V}, I_o = 5 \text{ mA}$		7 30	25 60	mV
	Load Regulation	$5 < I_o < 150 \text{ mA}$		14	50	
	Long Term Stability			20		mV/1000 hrs
$I_Q$	Quiescent Current	$I_o = 10 \text{ mA}$ $I_o = 50 \text{ mA}$ $I_o = 150 \text{ mA}$		3.5 5 18	7 11 40	mA
	Line Transient Reverse Polarity	$V_{IN} = 40\text{V}, R_L = 100\Omega, 1\text{s}$ $V_{IN} = -6\text{V}, R_L = 100\Omega$		14 -80		
$\Delta I_Q$	Quiescent Current Change	$6 < V_{IN} < 26\text{V}$		10		%
$V_{IN}$	Overvoltage Shutdown Voltage		26	38		V
	Max Line Transient			60		
		1s, $V_o \leq 5.5\text{V}$		50		
	Reverse Polarity Input Voltage	DC $V_o > -0.3\text{V}, R_L = 100\Omega$		-30 -12		
	Output Noise Voltage	10 Hz–100 kHz		50		$\mu\text{V}$
	Output Impedance	$I_o = 100 \text{ mADC} + 10 \text{ mArms}$		200		$\text{m}\Omega$
	Ripple Rejection			56		dB
	Current Limit		150	400	700	mA
	Dropout Voltage	$I_o = 150 \text{ mA}$		0.32	0.6	V
	Thermal Resistance	Junction to Case		4		$^\circ\text{C}/\text{W}$
		Junction to Ambient		50		

- (1) Unless otherwise specified:  $V_{IN} = 14\text{V}$ ,  $I_o = 150 \text{ mA}$ ,  $T_j = 25^\circ\text{C}$ ,  $C1 = 0.1 \mu\text{F}$ ,  $C2 = 10 \mu\text{F}$ . All characteristics except noise voltage and ripple rejection are measured using pulse techniques ( $t_w \leq 10 \text{ ms}$ , duty cycle  $\leq 5\%$ ). Output voltage changes due to changes in internal temperature must be taken into account separately.

Typical Performance Characteristics

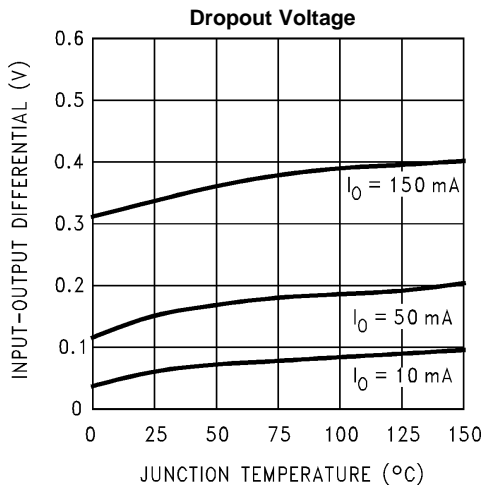

Figure 2.

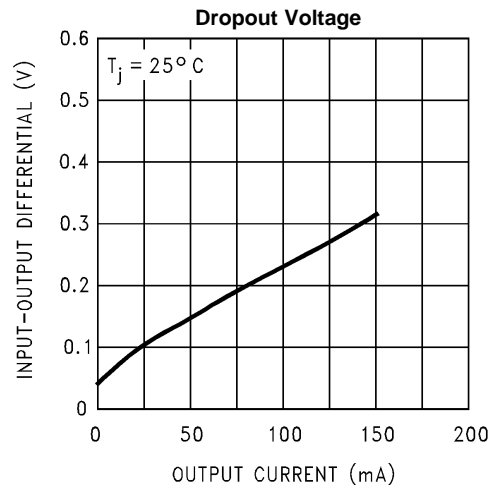

Figure 3.

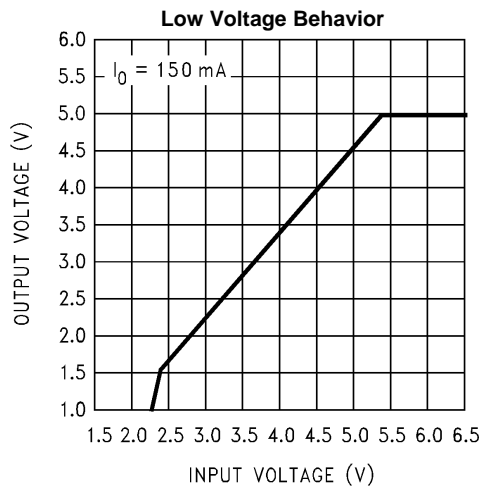

Figure 4.

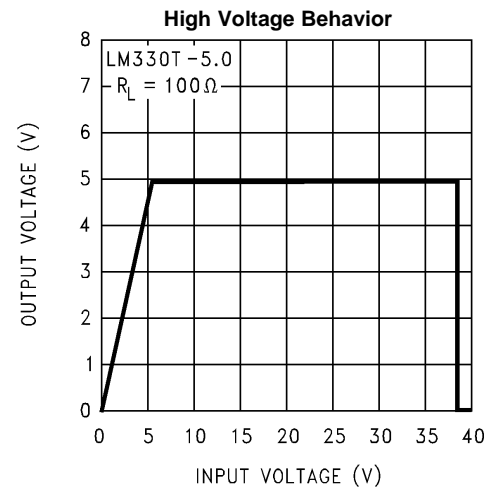

Figure 5.

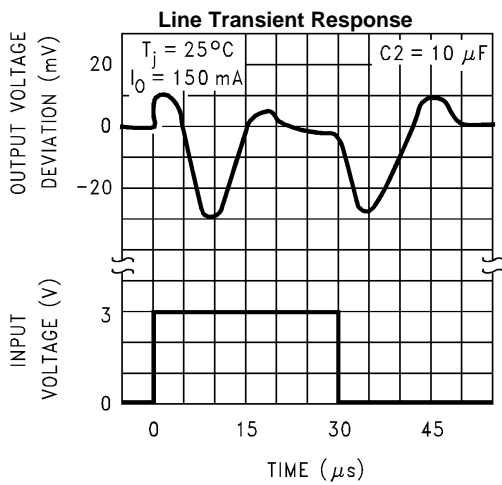

Figure 6.

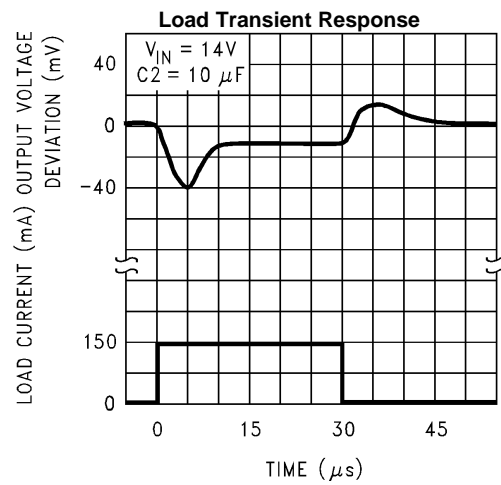
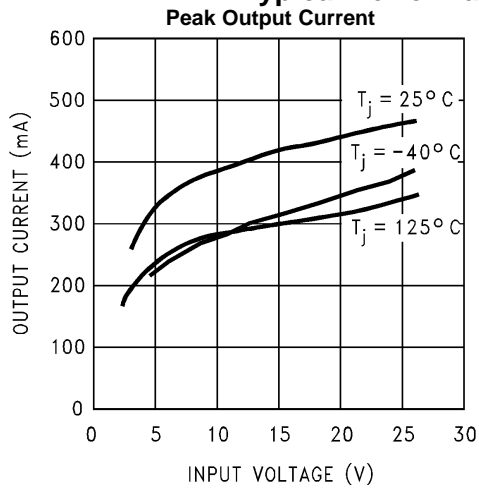
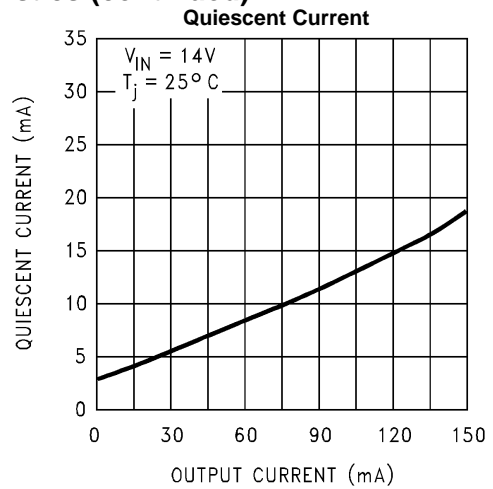

Figure 7.

**Typical Performance Characteristics (continued)**



**Figure 8.**



**Figure 9.**

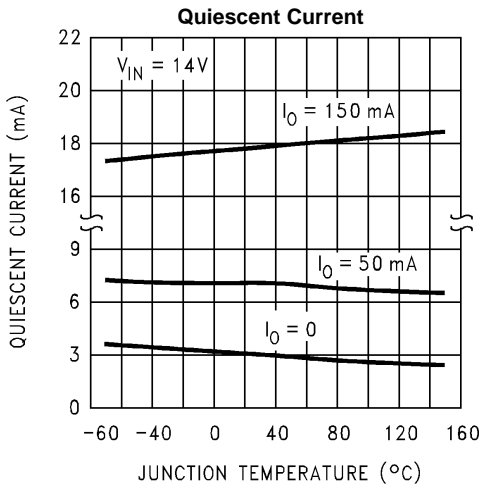

**Figure 10.**

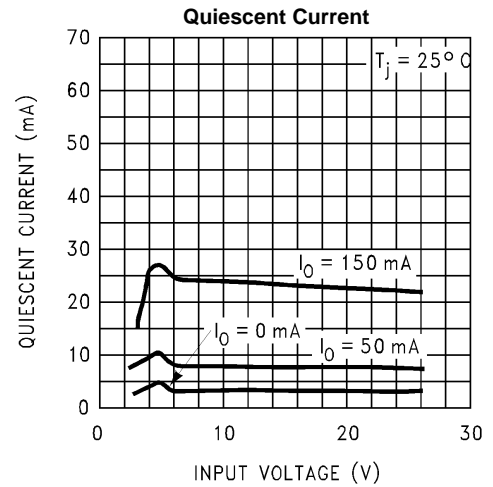

**Figure 11.**

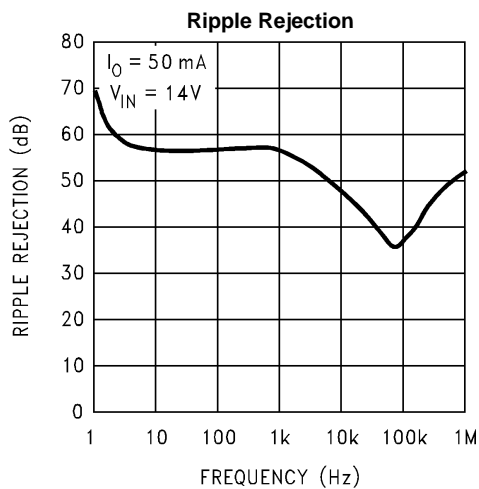

**Figure 12.**

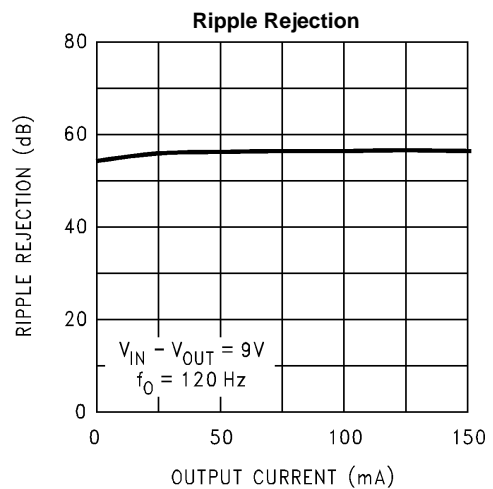

**Figure 13.**

Typical Performance Characteristics (continued)

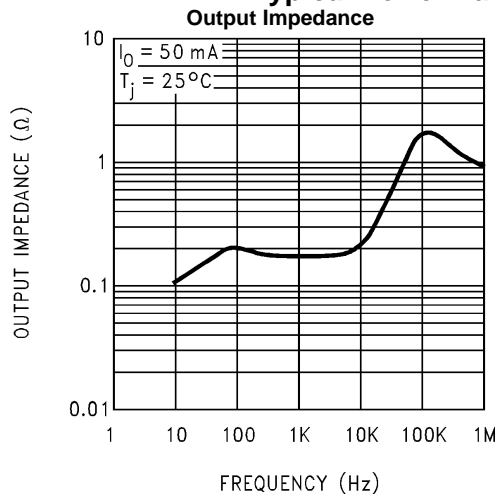

Figure 14.

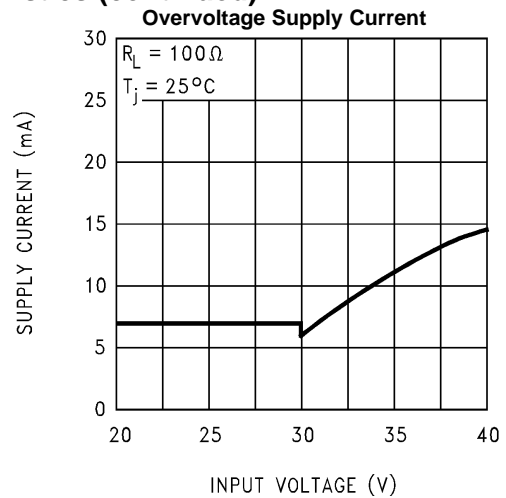

Figure 15.

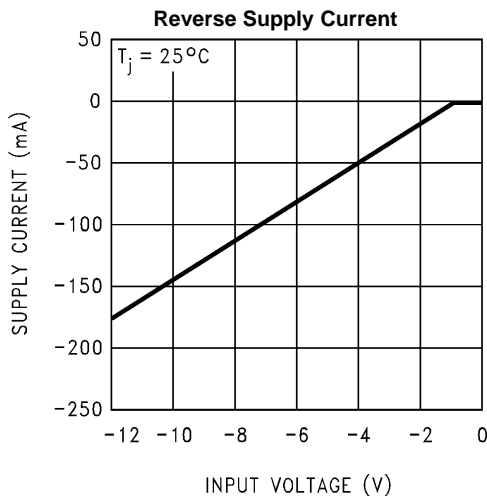

Figure 16.

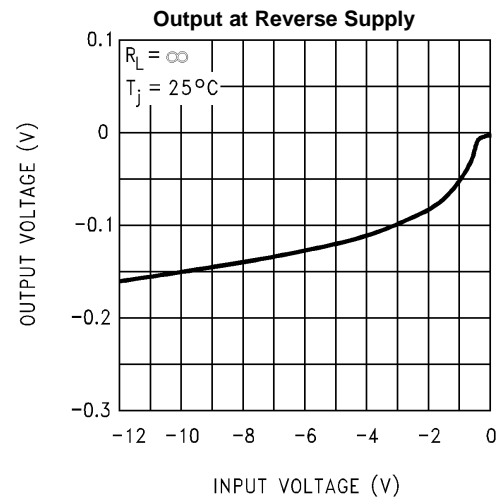

Figure 17.

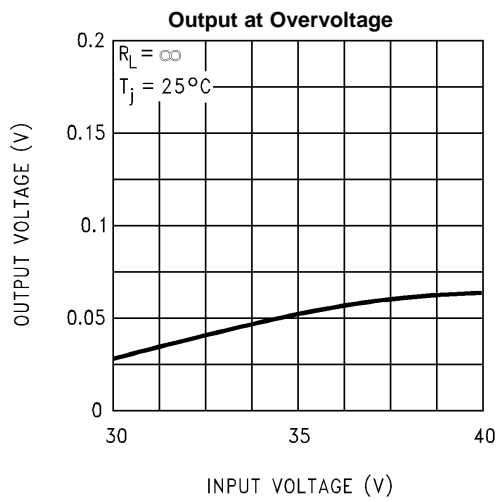

Figure 18.

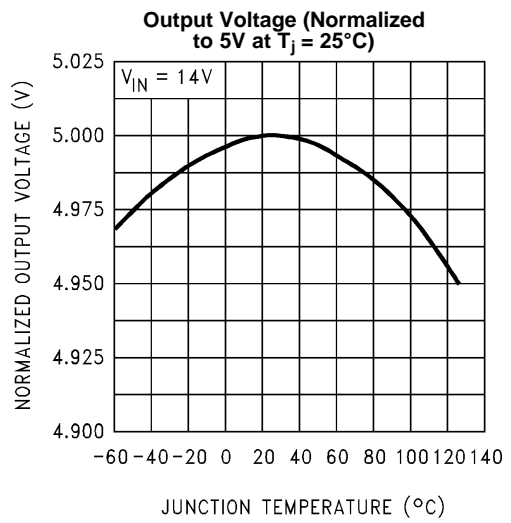
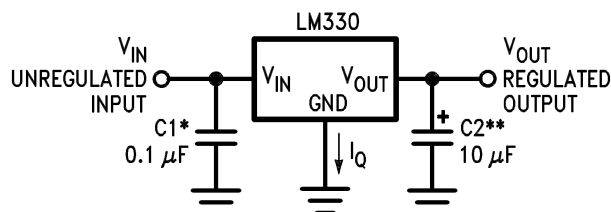

Figure 19.

## TYPICAL APPLICATIONS

The LM330-N is designed specifically to operate at lower input to output voltages. The device is designed utilizing a power lateral PNP transistor which reduces dropout voltage from 2.0V to 0.3V when compared to IC regulators using NPN pass transistors. Since the LM330-N can operate at a much lower input voltage, the device power dissipation is reduced, heat sinking can be simpler and device reliability improved through lower chip operating temperature. Also, a cost savings can be utilized through use of lower power/voltage components. In applications utilizing battery power, the LM330-N allows the battery voltage to drop to within 0.3V of output voltage prior to the voltage regulator dropping out of regulation.



\* Required if regulator is located far from power supply filter.

\*\* C2 may be either an Aluminum or Tantalum type capacitor but must be rated to operate at  $-40^{\circ}\text{C}$  to ensure regulator stability to that temperature extreme. 10  $\mu\text{F}$  is the minimum value required for stability and may be increased without bound. Locate as close as possible to the regulation.

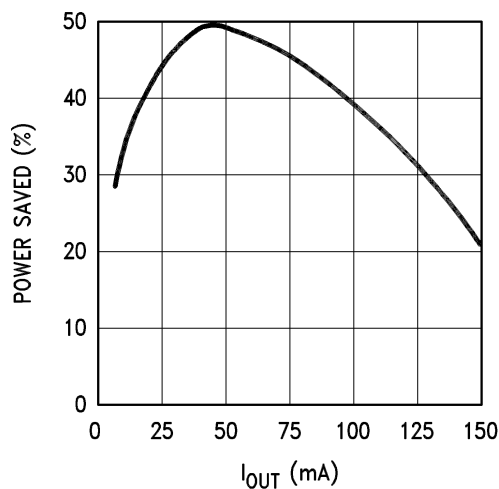

**Note:** Compared to IC regulator with 2.0V dropout voltage and  $I_{Qmax} = 6.0$  mA.

---

**REVISION HISTORY**

<b>Changes from Revision C (March 2013) to Revision D</b>	<b>Page</b>
<hr/> <ul style="list-style-type: none"><li>• Changed layout of National Data Sheet to TI format .....</li></ul>	<hr/> <b>6</b>

**PACKAGING INFORMATION**

Orderable Device	Status (1)	Package Type	Package Drawing	Pins	Package Qty	Eco Plan (2)	Lead finish/ Ball material (6)	MSL Peak Temp (3)	Op Temp (°C)	Device Marking (4/5)	Samples
LM330T-5.0/NOPB	ACTIVE	TO-220	NDE	3	45	RoHS & Green	SN	Level-1-NA-UNLIM	0 to 70	LM330T -5.0	<b>Samples</b>

(1) The marketing status values are defined as follows:

**ACTIVE:** Product device recommended for new designs.

**LIFEBUY:** TI has announced that the device will be discontinued, and a lifetime-buy period is in effect.

**NRND:** Not recommended for new designs. Device is in production to support existing customers, but TI does not recommend using this part in a new design.

**PREVIEW:** Device has been announced but is not in production. Samples may or may not be available.

**OBsolete:** TI has discontinued the production of the device.

(2) **RoHS:** TI defines "RoHS" to mean semiconductor products that are compliant with the current EU RoHS requirements for all 10 RoHS substances, including the requirement that RoHS substance do not exceed 0.1% by weight in homogeneous materials. Where designed to be soldered at high temperatures, "RoHS" products are suitable for use in specified lead-free processes. TI may reference these types of products as "Pb-Free".

**RoHS Exempt:** TI defines "RoHS Exempt" to mean products that contain lead but are compliant with EU RoHS pursuant to a specific EU RoHS exemption.

**Green:** TI defines "Green" to mean the content of Chlorine (Cl) and Bromine (Br) based flame retardants meet JS709B low halogen requirements of <=100ppm threshold. Antimony trioxide based flame retardants must also meet the <=1000ppm threshold requirement.

(3) MSL, Peak Temp. - The Moisture Sensitivity Level rating according to the JEDEC industry standard classifications, and peak solder temperature.

(4) There may be additional marking, which relates to the logo, the lot trace code information, or the environmental category on the device.

(5) Multiple Device Markings will be inside parentheses. Only one Device Marking contained in parentheses and separated by a "~" will appear on a device. If a line is indented then it is a continuation of the previous line and the two combined represent the entire Device Marking for that device.

(6) Lead finish/Ball material - Orderable Devices may have multiple material finish options. Finish options are separated by a vertical ruled line. Lead finish/Ball material values may wrap to two lines if the finish value exceeds the maximum column width.

**Important Information and Disclaimer:**The information provided on this page represents TI's knowledge and belief as of the date that it is provided. TI bases its knowledge and belief on information provided by third parties, and makes no representation or warranty as to the accuracy of such information. Efforts are underway to better integrate information from third parties. TI has taken and continues to take reasonable steps to provide representative and accurate information but may not have conducted destructive testing or chemical analysis on incoming materials and chemicals. TI and TI suppliers consider certain information to be proprietary, and thus CAS numbers and other limited information may not be available for release.

In no event shall TI's liability arising out of such information exceed the total purchase price of the TI part(s) at issue in this document sold by TI to Customer on an annual basis.



**TUBE**

\*All dimensions are nominal

Device	Package Name	Package Type	Pins	SPQ	L (mm)	W (mm)	T (μm)	B (mm)
LM330T-5.0/NOPB	NDE	TO-220	3	45	502	33	6985	4.06

NDE0003B



## IMPORTANT NOTICE AND DISCLAIMER

TI PROVIDES TECHNICAL AND RELIABILITY DATA (INCLUDING DATA SHEETS), DESIGN RESOURCES (INCLUDING REFERENCE DESIGNS), APPLICATION OR OTHER DESIGN ADVICE, WEB TOOLS, SAFETY INFORMATION, AND OTHER RESOURCES "AS IS" AND WITH ALL FAULTS, AND DISCLAIMS ALL WARRANTIES, EXPRESS AND IMPLIED, INCLUDING WITHOUT LIMITATION ANY IMPLIED WARRANTIES OF MERCHANTABILITY, FITNESS FOR A PARTICULAR PURPOSE OR NON-INFRINGEMENT OF THIRD PARTY INTELLECTUAL PROPERTY RIGHTS.

These resources are intended for skilled developers designing with TI products. You are solely responsible for (1) selecting the appropriate TI products for your application, (2) designing, validating and testing your application, and (3) ensuring your application meets applicable standards, and any other safety, security, regulatory or other requirements.

These resources are subject to change without notice. TI grants you permission to use these resources only for development of an application that uses the TI products described in the resource. Other reproduction and display of these resources is prohibited. No license is granted to any other TI intellectual property right or to any third party intellectual property right. TI disclaims responsibility for, and you will fully indemnify TI and its representatives against, any claims, damages, costs, losses, and liabilities arising out of your use of these resources.

TI's products are provided subject to [TI's Terms of Sale](#) or other applicable terms available either on [ti.com](http://ti.com) or provided in conjunction with such TI products. TI's provision of these resources does not expand or otherwise alter TI's applicable warranties or warranty disclaimers for TI products.

TI objects to and rejects any additional or different terms you may have proposed.

Mailing Address: Texas Instruments, Post Office Box 655303, Dallas, Texas 75265  
Copyright © 2022, Texas Instruments Incorporated