

LP38842-ADJ 1.5A Ultra Low Dropout Adjustable Linear Regulators

Stable with Ceramic Output Capacitors

Check for Samples: [LP38842-ADJ](#)

FEATURES

- Ideal for Conversion From 1.8V or 1.5V Inputs
- Designed for Use With Low ESR Ceramic Capacitors
- Ultra Low Dropout Voltage (115mV at 1.5A typ)
- 0.56V to 1.5V Adjustable Output Range
- Load Regulation of 0.1%/A (typ)
- 30nA Quiescent Current in Shutdown (typ)
- Low Ground Pin Current at all Loads
- Over Temperature/Over Current Protection
- Available in 8 Lead SO PowerPAD Package
- -40°C to +125°C Junction Temperature Range
- UVLO Disables Output When $V_{BIAS} < 3.8V$

APPLICATIONS

- ASIC Power Supplies In:
 - Desktops, Notebooks, and Graphics Cards, Servers
 - Gaming Set Top Boxes, Printers and Copiers
- Server Core and I/O Supplies
- DSP and FPGA Power Supplies
- SMPS Post-Regulators

TYPICAL APPLICATION CIRCUIT

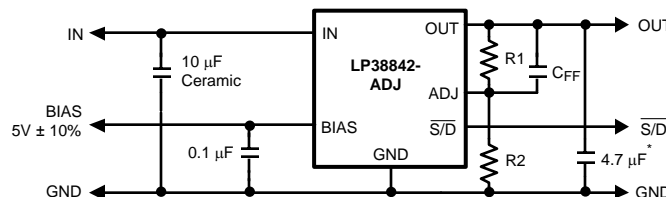

* Minimum value required if Tantalum capacitor is used (see [Application Hints](#)).

DESCRIPTION

The LP38842-ADJ is a high current, fast response regulator which can maintain output voltage regulation with minimum input to output voltage drop. Fabricated on a CMOS process, the device operates from two input voltages: V_{bias} provides voltage to drive the gate of the N-MOS power transistor, while V_{in} is the input voltage which supplies power to the load. The use of an external bias rail allows the part to operate from ultra low V_{in} voltages. Unlike bipolar regulators, the CMOS architecture consumes extremely low quiescent current at any output load current. The use of an N-MOS power transistor results in wide bandwidth, yet minimum external capacitance is required to maintain loop stability.

The fast transient response of these devices makes them suitable for use in powering DSP, Microcontroller Core voltages and Switch Mode Power Supply post regulators. The parts are available in the SO PowerPAD package.

Dropout Voltage: 115 mV (typ) at 1.5A load current.

Quiescent Current: 30 mA (typ) at full load.

Shutdown Current: 30 nA (typ) when S/D pin is low.

Precision Reference Voltage: 1.5% room temperature accuracy.



Please be aware that an important notice concerning availability, standard warranty, and use in critical applications of Texas Instruments semiconductor products and disclaimers thereto appears at the end of this data sheet.

All trademarks are the property of their respective owners.



These devices have limited built-in ESD protection. The leads should be shorted together or the device placed in conductive foam during storage or handling to prevent electrostatic damage to the MOS gates.

CONNECTION DIAGRAM

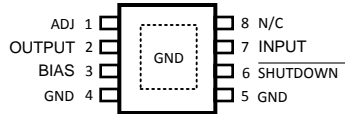

SO PowerPAD-8, Top View

PIN DESCRIPTION

Pin Name	Description
BIAS	The bias pin is used to provide the low current bias voltage to the chip which operates the internal circuitry and provides drive voltage for the N-FET.
OUTPUT	The regulated output voltage is connected to this pin.
GND	This is both the power and analog ground for the IC. Note that both pin three and the tab of the TO-220 and TO-263 packages are at ground potential. Pin three and the tab should be tied together using the PC board copper trace material and connected to circuit ground.
INPUT	The high current input voltage which is regulated down to the nominal output voltage must be connected to this pin. Because the bias voltage to operate the chip is provided separately, the input voltage can be as low as a few hundred millivolts above the output voltage.
SHUTDOWN	This provides a low power shutdown function which turns the regulated output OFF. Tie to V_{BIAS} if this function is not used.
ADJ	The adjust pin is used to set the regulated output voltage by connecting it to the external resistors R1 and R2 (see TYPICAL APPLICATION CIRCUIT).

BLOCK DIAGRAM

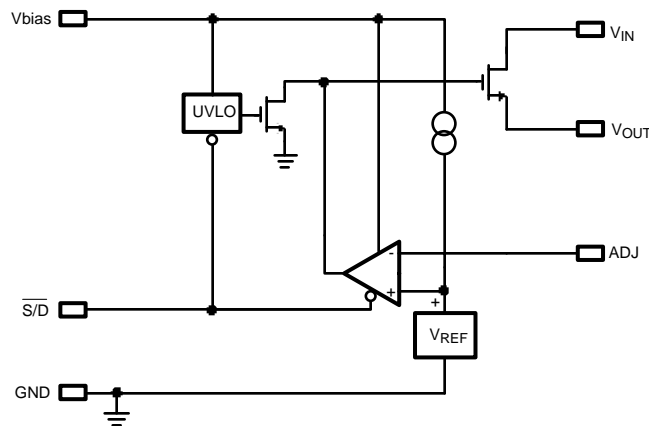

ABSOLUTE MAXIMUM RATINGS ⁽¹⁾

If Military/Aerospace specified devices are required, contact the Texas Instruments Semiconductor Sales Office/ Distributors for availability and specifications.

Storage Temperature Range	-65°C to +150°C
Lead Temp. (Soldering, 5 seconds)	260°C
ESD Rating Human Body Model ⁽²⁾ Machine Model ⁽³⁾	2 kV 200V
Power Dissipation ⁽⁴⁾	Internally Limited
V _{IN} Supply Voltage (Survival)	-0.3V to +6V
V _{BIAS} Supply Voltage (Survival)	-0.3V to +7V
Shutdown Input Voltage (Survival)	-0.3V to +7V
V _{ADJ}	-0.3V to +6V
I _{OUT} (Survival)	Internally Limited
Output Voltage (Survival)	-0.3V to +6V
Junction Temperature	-40°C to +150°C

- (1) Absolute maximum ratings indicate limits beyond which damage to the component may occur. Operating ratings indicate conditions for which the device is intended to be functional, but **do not** ensure specific performance limits. For specifications, see [ELECTRICAL CHARACTERISTICS⁰](#). Specifications do not apply when operating the device outside of its rated operating conditions.
- (2) The human body model is a 100 pF capacitor discharged through a 1.5k resistor into each pin.
- (3) The machine model is a 220 pF capacitor discharged directly into each pin.
- (4) At elevated temperatures, device power dissipation must be derated based on package thermal resistance and heatsink thermal values. If power dissipation causes the junction temperature to exceed specified limits, the device will go into thermal shutdown.

Operating Ratings

V _{IN} Supply Voltage	(V _{OUT} + V _{DO}) to 5.5V
Shutdown Input Voltage	0 to +5.5V
I _{OUT}	1.5A
Operating Junction Temperature Range	-40°C to +125°C
V _{BIAS} Supply Voltage	4.5V to 5.5V
V _{OUT}	0.56V to 1.5V

ELECTRICAL CHARACTERISTICS⁽¹⁾

Limits in standard typeface are for $T_J = 25^\circ\text{C}$, and limits in **boldface type** apply over the full operating temperature range. Unless otherwise specified: $V_{IN} = V_O(\text{NOM}) + 1\text{V}$, $V_{BIAS} = 4.5\text{V}$, $I_L = 10\text{ mA}$, $C_{IN} = 10\ \mu\text{F CER}$, $C_{OUT} = 22\ \mu\text{F CER}$, $V_{S/D} = V_{BIAS}$. Min/Max limits are specified through testing, statistical correlation, or design.

Symbol	Parameter	Conditions	MIN	TYP ⁽²⁾	MAX	Units
V_{ADJ}	Adjust Pin Voltage	$10\text{ mA} < I_L < 1.5\text{A}$ $V_O(\text{NOM}) + 1\text{V} \leq V_{IN} \leq 5.5\text{V}$ $4.5\text{V} \leq V_{BIAS} \leq 5.5\text{V}$	0.552 0.543	0.56	0.568 0.577	V
I_{ADJ}	Adjust Pin Bias Current	$10\text{ mA} < I_L < 1.5\text{A}$ $V_O(\text{NOM}) + 1\text{V} \leq V_{IN} \leq 5.5\text{V}$ $4.5\text{V} \leq V_{BIAS} \leq 5.5\text{V}$		1		μA
$\Delta V_O/\Delta V_{IN}$	Output Voltage Line Regulation ⁽³⁾	$V_O(\text{NOM}) + 1\text{V} \leq V_{IN} \leq 5.5\text{V}$		0.01		%/V
$\Delta V_O/\Delta I_L$	Output Voltage Load Regulation ⁽⁴⁾	$10\text{ mA} < I_L < 1.5\text{A}$		0.1	0.4 1.1	%/A
V_{DO}	Dropout Voltage ⁽⁵⁾	$I_L = 1.5\text{A}$		115	175 315	mV
$I_Q(V_{IN})$	Quiescent Current Drawn from V_{IN} Supply	$10\text{ mA} < I_L < 1.5\text{A}$		30	35 40	mA
		$V_{S/D} \leq 0.3\text{V}$		0.06	1 30	μA
$I_Q(V_{BIAS})$	Quiescent Current Drawn from V_{BIAS} Supply	$10\text{ mA} < I_L < 1.5\text{A}$		2	4 6	mA
		$V_{S/D} \leq 0.3\text{V}$		0.03	1 30	μA
UVLO	V_{BIAS} Voltage Where Regulator Output Is Enabled			3.8		V
I_{SC}	Short-Circuit Current	$V_{OUT} = 0\text{V}$		4		A
Shutdown Input						
V_{SDT}	Output Turn-off Threshold	Output = ON		0.7	1.3	V
		Output = OFF	0.3	0.7		
$T_d(\text{OFF})$	Turn-OFF Delay	$R_{LOAD} \times C_{OUT} \ll T_d(\text{OFF})$		20		μs
$T_d(\text{ON})$	Turn-ON Delay	$R_{LOAD} \times C_{OUT} \ll T_d(\text{ON})$		15		
$I_{S/D}$	$\overline{S/D}$ Input Current	$V_{S/D} = 1.3\text{V}$		1		μA
		$V_{S/D} \leq 0.3\text{V}$		-1		
θ_{J-A}	Junction to Ambient Thermal Resistance	SO PowerPAD-8 Package ⁽⁶⁾		43		$^\circ\text{C/W}$
AC Parameters						
PSRR (V_{IN})	Ripple Rejection for V_{IN} Input Voltage	$V_{IN} = V_{OUT} + 1\text{V}$, $f = 120\text{ Hz}$		80		dB
		$V_{IN} = V_{OUT} + 1\text{V}$, $f = 1\text{ kHz}$		65		
PSRR (V_{BIAS})	Ripple Rejection for V_{BIAS} Voltage	$V_{BIAS} = V_{OUT} + 3\text{V}$, $f = 120\text{ Hz}$		58		
		$V_{BIAS} = V_{OUT} + 3\text{V}$, $f = 1\text{ kHz}$		58		
	Output Noise Density	$f = 120\text{ Hz}$		1		$\mu\text{V}/\text{root-Hz}$
e_n	Output Noise Voltage $V_{OUT} = 1.5\text{V}$	$\text{BW} = 10\text{ Hz} - 100\text{ kHz}$		150		$\mu\text{V}(\text{rms})$
		$\text{BW} = 300\text{ Hz} - 300\text{ kHz}$		90		

- (1) If used in a dual-supply system where the regulator load is returned to a negative supply, the output pin must be diode clamped to ground.
- (2) Typical numbers represent the most likely parametric norm for 25°C operation.
- (3) Output voltage line regulation is defined as the change in output voltage from nominal value resulting from a change in input voltage.
- (4) Output voltage load regulation is defined as the change in output voltage from nominal value as the load current increases from no load to full load.
- (5) Dropout voltage is defined as the minimum input to output differential required to maintain the output with 2% of nominal value.
- (6) For optimum heat dissipation, the ground pad must be soldered to a copper plane or connected using vias to an internal copper plane.

TYPICAL PERFORMANCE CHARACTERISTICS

Unless otherwise specified: $T_J = 25^\circ\text{C}$, $C_{IN} = 10 \mu\text{F CER}$, $C_{OUT} = 22 \mu\text{F CER}$, $C_{BIAS} = 1 \mu\text{F CER}$, $\overline{S/D}$ Pin is tied to V_{BIAS} , $V_{OUT} = 1.2\text{V}$, $I_L = 10\text{mA}$, $V_{BIAS} = 5\text{V}$, $V_{IN} = V_{OUT} + 1\text{V}$.

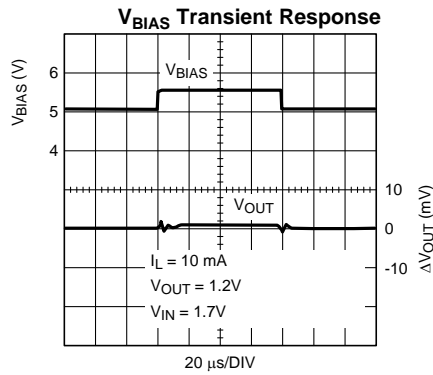

Figure 1.

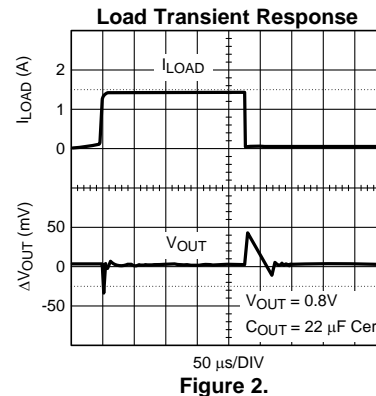

Figure 2.

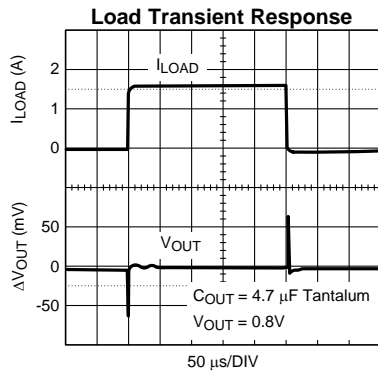

Figure 3.

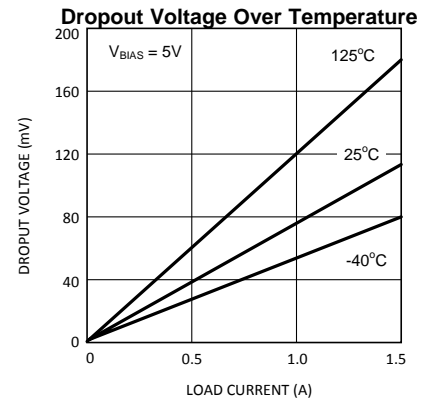

Figure 4.

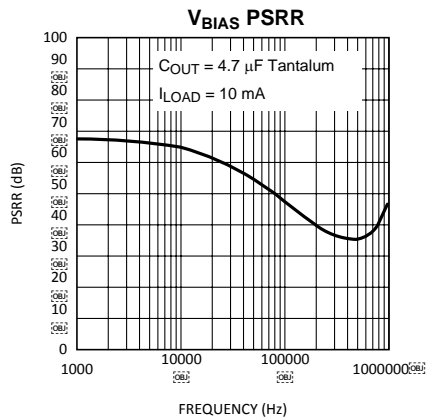

Figure 5.

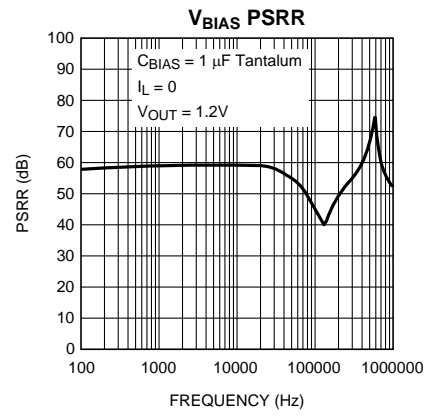

Figure 6.

TYPICAL PERFORMANCE CHARACTERISTICS (continued)

Unless otherwise specified: $T_J = 25^\circ\text{C}$, $C_{IN} = 10 \mu\text{F CER}$, $C_{OUT} = 22 \mu\text{F CER}$, $C_{BIAS} = 1 \mu\text{F CER}$, $\overline{S/D}$ Pin is tied to V_{BIAS} , $V_{OUT} = 1.2\text{V}$, $I_L = 10\text{mA}$, $V_{BIAS} = 5\text{V}$, $V_{IN} = V_{OUT} + 1\text{V}$.

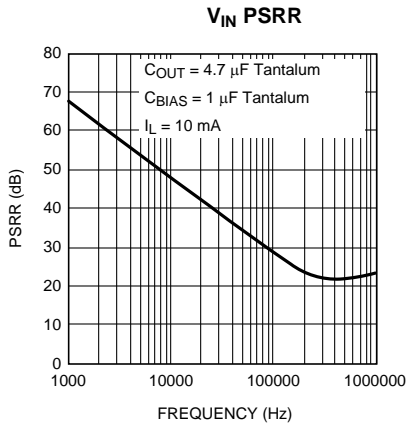

Figure 7.

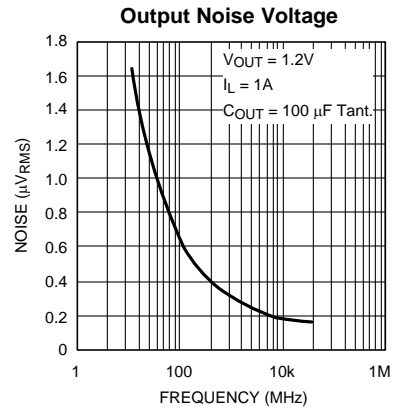

Figure 8.

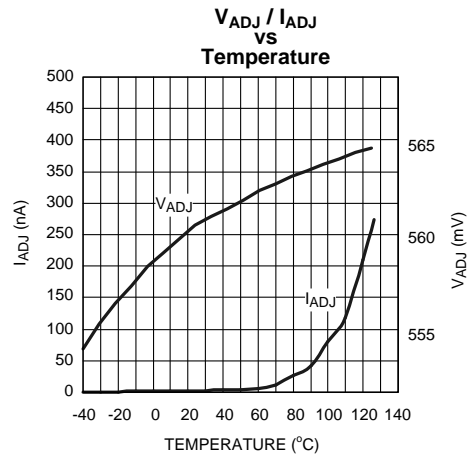

Figure 9.

Application Hints

SETTING THE OUTPUT VOLTAGE (Refer to [TYPICAL APPLICATION CIRCUIT](#))

The output voltage is set using the resistive divider R1 and R2. The output voltage is given by the formula:

$$V_{OUT} = V_{ADJ} \times (1 + R1 / R2) \quad (1)$$

The value of resistor R2 must be 10k or less for proper operation.

EXTERNAL CAPACITORS

To assure regulator stability, input and output capacitors are required as shown in the [TYPICAL APPLICATION CIRCUIT](#).

OUTPUT CAPACITOR

An output capacitor is required on the LP3884X devices for loop stability. The minimum value of capacitance necessary depends on type of capacitor: if a solid Tantalum capacitor is used, the part is stable with capacitor values as low as 4.7µF. If a ceramic capacitor is used, a minimum of 22 µF of capacitance must be used (capacitance may be increased without limit). The reason a larger ceramic capacitor is required is that the output capacitor sets a pole which limits the loop bandwidth. The Tantalum capacitor has a higher ESR than the ceramic which provides more phase margin to the loop, thereby allowing the use of a smaller output capacitor because adequate phase margin can be maintained out to a higher crossover frequency. The tantalum capacitor will typically also provide faster settling time on the output after a fast changing load transient occurs, but the ceramic capacitor is superior for bypassing high frequency noise.

The output capacitor must be located less than one centimeter from the output pin and returned to a clean analog ground. Care must be taken in choosing the output capacitor to ensure that sufficient capacitance is provided over the full operating temperature range. If ceramics are selected, only X7R or X5R types may be used because Z5U and Y5F types suffer severe loss of capacitance with temperature and applied voltage and may only provide 20% of their rated capacitance in operation.

INPUT CAPACITOR

The input capacitor is also critical to loop stability because it provides a low source impedance for the regulator. The minimum required input capacitance is 10 µF ceramic (Tantalum not recommended). The value of C_{IN} may be increased without limit. As stated above, X5R or X7R must be used to ensure sufficient capacitance is provided. The input capacitor must be located less than one centimeter from the input pin and returned to a clean analog ground.

FEED FORWARD CAPACITOR (Refer to [TYPICAL APPLICATION CIRCUIT](#))

A capacitor placed across R1 can provide some additional phase margin and improve transient response. The capacitor C_{FF} and R1 form a zero in the loop response given by the formula:

$$F_Z = 1 / (2 \times \pi \times C_{FF} \times R1) \quad (2)$$

For best effect, select C_{FF} so the zero frequency is approximately 70 kHz. The phase lead provided by C_{FF} drops as the output voltage gets closer to 0.56V (and R1 reduces in value). The reason is that C_{FF} also forms a pole whose frequency is given by:

$$F_P = 1 / (2 \times \pi \times C_{FF} \times R1 // R2) \quad (3)$$

As R1 reduces, the two equations come closer to being equal and the pole and zero begin to cancel each other out which removes the beneficial phase lead of the zero.

BIAS CAPACITOR

The 0.1µF capacitor on the bias line can be any good quality capacitor (ceramic is recommended).

BIAS VOLTAGE

The bias voltage is an external voltage rail required to get gate drive for the N-FET pass transistor. Bias voltage must be in the range of 4.5 - 5.5V to assure proper operation of the part.

UNDER VOLTAGE LOCKOUT

The bias voltage is monitored by a circuit which prevents the regulator output from turning on if the bias voltage is below approximately 3.8V.

SHUTDOWN OPERATION

Pulling down the shutdown ($\overline{S/D}$) pin will turn-off the regulator. The $\overline{S/D}$ pin must be actively terminated through a pull-up resistor (10 k Ω to 100 k Ω) for a proper operation. If this pin is driven from a source that actively pulls high and low (such as a CMOS rail to rail comparator), the pull-up resistor is not required. This pin must be tied to Vin if not used.



POWER DISSIPATION/HEATSINKING

Heatsinking for the SO PowerPAD-8 package is accomplished by allowing heat to flow through the ground slug on the bottom of the package into the copper on the PC board. The heat slug must be soldered down to a copper plane to get good heat transfer. It can also be connected through vias to internal copper planes. Since the heat slug is at ground potential, traces must not be routed under it which are not at ground potential. Under all possible conditions, the junction temperature must be within the range specified under operating conditions.

REVISION HISTORY

Changes from Original (April 2013) to Revision A	Page
<hr/> <ul style="list-style-type: none">• Changed layout of National Data Sheet to TI format <hr/>	<hr/> 8 <hr/>

PACKAGING INFORMATION

Orderable Device	Status (1)	Package Type	Package Drawing	Pins	Package Qty	Eco Plan (2)	Lead finish/ Ball material (6)	MSL Peak Temp (3)	Op Temp (°C)	Device Marking (4/5)	Samples
LP38842MR-ADJ/NOPB	ACTIVE	SO PowerPAD	DDA	8	95	RoHS & Green	SN	Level-3-260C-168 HR	-40 to 125	L38842 MRADJ	
LP38842MRX-ADJ/NOPB	ACTIVE	SO PowerPAD	DDA	8	2500	RoHS & Green	SN	Level-3-260C-168 HR		L38842 MRADJ	

(1) The marketing status values are defined as follows:

ACTIVE: Product device recommended for new designs.

LIFEBUY: TI has announced that the device will be discontinued, and a lifetime-buy period is in effect.

NRND: Not recommended for new designs. Device is in production to support existing customers, but TI does not recommend using this part in a new design.

PREVIEW: Device has been announced but is not in production. Samples may or may not be available.

OBsolete: TI has discontinued the production of the device.

(2) **RoHS:** TI defines "RoHS" to mean semiconductor products that are compliant with the current EU RoHS requirements for all 10 RoHS substances, including the requirement that RoHS substance do not exceed 0.1% by weight in homogeneous materials. Where designed to be soldered at high temperatures, "RoHS" products are suitable for use in specified lead-free processes. TI may reference these types of products as "Pb-Free".

RoHS Exempt: TI defines "RoHS Exempt" to mean products that contain lead but are compliant with EU RoHS pursuant to a specific EU RoHS exemption.

Green: TI defines "Green" to mean the content of Chlorine (Cl) and Bromine (Br) based flame retardants meet JS709B low halogen requirements of <=1000ppm threshold. Antimony trioxide based flame retardants must also meet the <=1000ppm threshold requirement.

(3) MSL, Peak Temp. - The Moisture Sensitivity Level rating according to the JEDEC industry standard classifications, and peak solder temperature.

(4) There may be additional marking, which relates to the logo, the lot trace code information, or the environmental category on the device.

(5) Multiple Device Markings will be inside parentheses. Only one Device Marking contained in parentheses and separated by a "~" will appear on a device. If a line is indented then it is a continuation of the previous line and the two combined represent the entire Device Marking for that device.

(6) Lead finish/Ball material - Orderable Devices may have multiple material finish options. Finish options are separated by a vertical ruled line. Lead finish/Ball material values may wrap to two lines if the finish value exceeds the maximum column width.

Important Information and Disclaimer:The information provided on this page represents TI's knowledge and belief as of the date that it is provided. TI bases its knowledge and belief on information provided by third parties, and makes no representation or warranty as to the accuracy of such information. Efforts are underway to better integrate information from third parties. TI has taken and continues to take reasonable steps to provide representative and accurate information but may not have conducted destructive testing or chemical analysis on incoming materials and chemicals. TI and TI suppliers consider certain information to be proprietary, and thus CAS numbers and other limited information may not be available for release.

In no event shall TI's liability arising out of such information exceed the total purchase price of the TI part(s) at issue in this document sold by TI to Customer on an annual basis.

TAPE AND REEL INFORMATION

QUADRANT ASSIGNMENTS FOR PIN 1 ORIENTATION IN TAPE

*All dimensions are nominal

Device	Package Type	Package Drawing	Pins	SPQ	Reel Diameter (mm)	Reel Width W1 (mm)	A0 (mm)	B0 (mm)	K0 (mm)	P1 (mm)	W (mm)	Pin1 Quadrant
LP38842MRX-ADJ/NOPB	SO PowerPAD	DDA	8	2500	330.0	12.4	6.5	5.4	2.0	8.0	12.0	Q1

TAPE AND REEL BOX DIMENSIONS

*All dimensions are nominal

Device	Package Type	Package Drawing	Pins	SPQ	Length (mm)	Width (mm)	Height (mm)
LP38842MRX-ADJ/NOPB	SO PowerPAD	DDA	8	2500	356.0	356.0	36.0

TUBE

*All dimensions are nominal

Device	Package Name	Package Type	Pins	SPQ	L (mm)	W (mm)	T (μm)	B (mm)
LP38842MR-ADJ/NOPB	DDA	HSOIC	8	95	495	8	4064	3.05



Images above are just a representation of the package family, actual package may vary.
Refer to the product data sheet for package details.

IMPORTANT NOTICE AND DISCLAIMER

TI PROVIDES TECHNICAL AND RELIABILITY DATA (INCLUDING DATA SHEETS), DESIGN RESOURCES (INCLUDING REFERENCE DESIGNS), APPLICATION OR OTHER DESIGN ADVICE, WEB TOOLS, SAFETY INFORMATION, AND OTHER RESOURCES "AS IS" AND WITH ALL FAULTS, AND DISCLAIMS ALL WARRANTIES, EXPRESS AND IMPLIED, INCLUDING WITHOUT LIMITATION ANY IMPLIED WARRANTIES OF MERCHANTABILITY, FITNESS FOR A PARTICULAR PURPOSE OR NON-INFRINGEMENT OF THIRD PARTY INTELLECTUAL PROPERTY RIGHTS.

These resources are intended for skilled developers designing with TI products. You are solely responsible for (1) selecting the appropriate TI products for your application, (2) designing, validating and testing your application, and (3) ensuring your application meets applicable standards, and any other safety, security, regulatory or other requirements.

These resources are subject to change without notice. TI grants you permission to use these resources only for development of an application that uses the TI products described in the resource. Other reproduction and display of these resources is prohibited. No license is granted to any other TI intellectual property right or to any third party intellectual property right. TI disclaims responsibility for, and you will fully indemnify TI and its representatives against, any claims, damages, costs, losses, and liabilities arising out of your use of these resources.

TI's products are provided subject to [TI's Terms of Sale](#) or other applicable terms available either on [ti.com](https://www.ti.com) or provided in conjunction with such TI products. TI's provision of these resources does not expand or otherwise alter TI's applicable warranties or warranty disclaimers for TI products.

TI objects to and rejects any additional or different terms you may have proposed.

Mailing Address: Texas Instruments, Post Office Box 655303, Dallas, Texas 75265
Copyright © 2024, Texas Instruments Incorporated