

## LPV542 Dual Nanopower 1.8 V, 490nA, RRIO CMOS Operational Amplifier

### 1 Features

- Wide Supply Range: 1.6 V to 5.5 V
- Low Supply Current: 490 nA (typical/channel)
- Good Offset Voltage: 3 mV (maximum/room)
- Good TcVos: 1 $\mu$ V/°C (typical)
- Gain-Bandwidth: 8 kHz (typical)
- Rail-to-Rail Input and Output
- Unity-Gain Stable
- Low Input Bias Current : 1 pA (typ)
- EMI Hardened
- Temperature Range: -40°C to 125°C
- Thin 3 mm x 3 mm x 0.45 mm X1SON package

### 2 Applications

- Wearables
- Personal Health Monitors
- Battery Packs
- Mobile Phones and Tablets
- Solar-Powered or Energy Harvested Systems
- PIR, Smoke, Gas, and Fire Detection Systems
- Battery Powered Internet of Things (IoT) Devices
- Remote Sensors
- Micropower Reference Buffer

### 3 Description

The LPV542 is an ultra-low-power, dual operational amplifier that provides 8kHz of bandwidth from 490nA of quiescent current making it well suited for battery-powered applications such as health and fitness wearables, building automation, and remote sensing nodes.

Each amplifier has a CMOS input stage with pico-amp bias currents which reduces errors commonly introduced in megaohm feedback resistance topologies such as photodiode and charge sense applications. In addition, the input common-mode range extends to the power supply rails and the output swings to within 3 mV of the rails, maintaining the widest dynamic range possible. Likewise, EMI protection is designed into the LPV542 in order to reduce system sensitivity to unwanted RF signals from mobile phones, WiFi, radio transmitters, and tag readers.

The LPV542 operates on a supply voltage as low as 1.6 V, ensuring continuous superior performance in low battery situations. The device is available in an 8-pad, low-profile, leadless 3 mm x 3 mm x 0.45 mm X1SON package and a standard 8 pin VSSOP.

#### Device Information<sup>(1)</sup>

PART NUMBER	PACKAGE	BODY SIZE (NOM)
LPV542	X1SON (8)	3.00 mm x 3.00 mm
	VSSOP (8)	3.00 mm x 3.00 mm

(1) For all available packages, see the orderable addendum at the end of the data sheet.

#### Nanopower Oxygen Sensor Amplifier

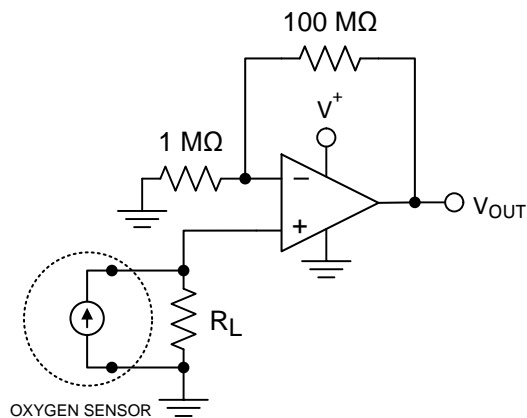

#### Supply Current vs. Supply Voltage

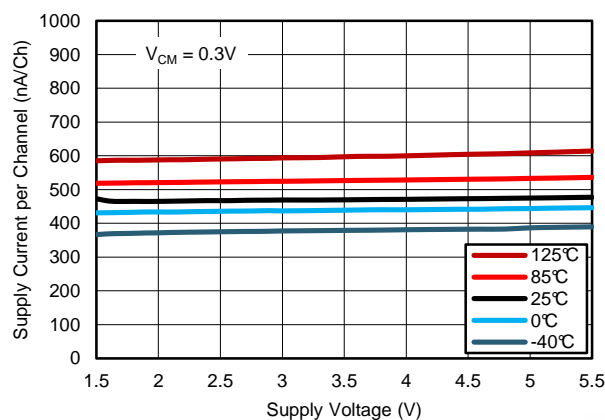

## Table of Contents

<b>1 Features</b> .....	<b>1</b>	7.4 Device Functional Modes.....	<b>14</b>
<b>2 Applications</b> .....	<b>1</b>	<b>8 Application and Implementation</b> .....	<b>16</b>
<b>3 Description</b> .....	<b>1</b>	8.1 Application Information.....	<b>16</b>
<b>4 Revision History</b> .....	<b>2</b>	8.2 Typical Application: 60 Hz Twin "T" Notch Filter.....	<b>16</b>
<b>5 Pin Configuration and Functions</b> .....	<b>3</b>	8.3 Do's and Don'ts .....	<b>17</b>
<b>6 Specifications</b> .....	<b>4</b>	<b>9 Power Supply Recommendations</b> .....	<b>18</b>
6.1 Absolute Maximum Ratings .....	<b>4</b>	<b>10 Layout</b> .....	<b>18</b>
6.2 ESD Ratings .....	<b>4</b>	10.1 Layout Guidelines .....	<b>18</b>
6.3 Recommended Operating Ratings.....	<b>4</b>	10.2 Layout Example .....	<b>18</b>
6.4 Thermal Information .....	<b>4</b>	<b>11 Device and Documentation Support</b> .....	<b>19</b>
6.5 Electrical Characteristics 1.8 V .....	<b>5</b>	11.1 Device Support .....	<b>19</b>
6.6 Electrical Characteristics 3.3 V .....	<b>6</b>	11.2 Documentation Support .....	<b>19</b>
6.7 Electrical Characteristics 5 V .....	<b>7</b>	11.3 Community Resources.....	<b>19</b>
6.8 Typical Characteristics.....	<b>8</b>	11.4 Trademarks .....	<b>19</b>
<b>7 Detailed Description</b> .....	<b>14</b>	11.5 Electrostatic Discharge Caution.....	<b>19</b>
7.1 Overview .....	<b>14</b>	11.6 Glossary .....	<b>19</b>
7.2 Functional Block Diagram .....	<b>14</b>	<b>12 Mechanical, Packaging, and Orderable Information</b> .....	<b>19</b>
7.3 Feature Description.....	<b>14</b>		

## 4 Revision History

<b>Changes from Original (March 2015) to Revision A</b>	<b>Page</b>
• Changed Front Page Bias Current to Typ .....	<b>1</b>
• Changed PSRR condition to 1.8V in all tables .....	<b>5</b>
• Changed PSRR Minimum in all tables .....	<b>5</b>
• Changed CMVR Condition to 57dB in 1.8V Table .....	<b>5</b>
• Changed CMRR Min in all tables .....	<b>5</b>
• Deleted Removed Maximum Bias Current Spec in all tables.....	<b>5</b>

## 5 Pin Configuration and Functions

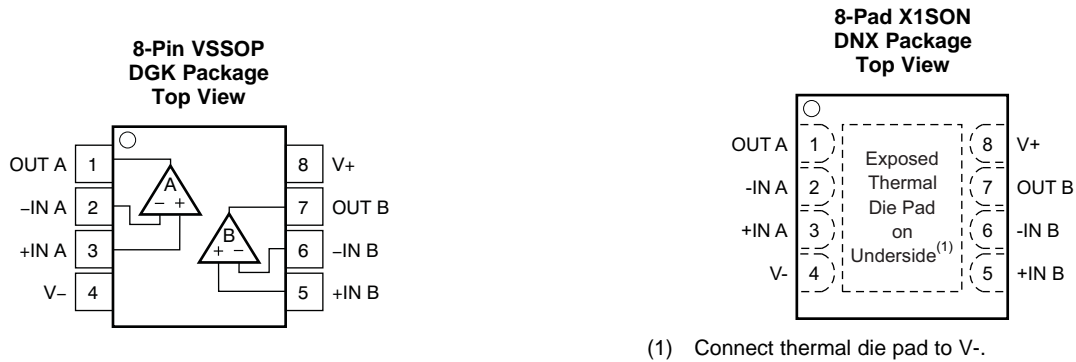

### Pin Functions

NAME	PIN		I/O	DESCRIPTION
	DGK	DNX		
OUT A	1	1	O	Channel A Output
-IN A	2	2	I	Channel A Inverting Input
+IN A	3	3	I	Channel A Non-Inverting Input
V-	4	4	P	Negative (lowest) power supply
+IN B	5	5	I	Channel B Non-Inverting Input
-IN B	6	6	I	Channel B Inverting Input
OUT B	7	7	O	Channel B Output
V+	8	8	P	Positive (highest) power supply
Die Pad	--	DAP	P	Die Attach Pad. Connect to V- (DNX package only)

## 6 Specifications

### 6.1 Absolute Maximum Ratings

Over operating free-air temperature range (unless otherwise noted)<sup>(1)(2)(3)</sup>

		MIN	MAX	UNIT
Supply voltage, V+ to V-		-0.3	6	V
Signal input pins	Voltage <sup>(2)</sup>	(V-) - 0.3	(V+) + 0.3	V
	Current <sup>(2)</sup>	-10	10	mA
Output short current		Continuous <sup>(4)</sup>		
Junction temperature		-40	150	°C
Storage temperature, T <sub>stg</sub>		-65	150	°C

- (1) Stresses beyond those listed under *Absolute Maximum Ratings* may cause permanent damage to the device. These are stress ratings only, which do not imply functional operation of the device at these or any other conditions beyond those indicated under *Recommended Operating Conditions*. Exposure to absolute-maximum-rated conditions for extended periods may affect device reliability.
- (2) Input pins are diode-clamped to the power-supply rails. Input signals that can swing more than 0.3 V beyond the supply rails should be current-limited to 10 mA or less.
- (3) If Military/Aerospace specified devices are required, please contact the Texas Instruments Sales Office/Distributors for availability and specifications.
- (4) Short-circuit to V-.

### 6.2 ESD Ratings

		VALUE	UNIT
V <sub>(ESD)</sub>	Electrostatic discharge	Human body model (HBM), per ANSI/ESDA/JEDEC JS-001, all pins <sup>(1)</sup>	±2000
		Charged device model (CDM), per JEDEC specification JESD22-C101, all pins <sup>(2)</sup>	±250

- (1) JEDEC document JEP155 states that 500-V HBM allows safe manufacturing with a standard ESD control process.
- (2) JEDEC document JEP157 states that 250-V CDM allows safe manufacturing with a standard ESD control process.

### 6.3 Recommended Operating Ratings

	MIN	NOM	MAX	UNIT
Supply Voltage (V <sup>+</sup> –V <sup>-</sup> )	1.6		5.5	V
Specified Temperature	-40		125	°C

### 6.4 Thermal Information

THERMAL METRIC <sup>(1)</sup>		DGK (VSSOP) 8 PINS	DNX (X1SON) 8 PINS	UNIT
R <sub>θJA</sub>	Junction-to-ambient thermal resistance	182.5	46.3	°C/W
R <sub>θJC(top)</sub>	Junction-to-case (top) thermal resistance	73.6	33.3	
R <sub>θJB</sub>	Junction-to-board thermal resistance	104.1	21	
ψ <sub>JT</sub>	Junction-to-top characterization parameter	13.7	0.2	
ψ <sub>JB</sub>	Junction-to-board characterization parameter	102.5	21.2	
R <sub>θJC(bot)</sub>	Junction-to-case (bottom) thermal resistance	N/A	7	

- (1) For more information about traditional and new thermal metrics, see the IC Package Thermal Metrics application report, [SPRA953](#).

## 6.5 Electrical Characteristics 1.8 V

 $T_A = 25^\circ\text{C}$ ,  $V^+ = 1.8\text{V}$ ,  $V^- = 0\text{V}$ ,  $V_{\text{CM}} = V_O = V^+/2$ , and  $R_L > 1\text{M}\Omega$ , unless otherwise noted.

PARAMETER	TEST CONDITIONS	MIN	TYP <sup>(1)</sup>	MAX	UNIT
<b>OFFSET VOLTAGE</b>					
Input offset voltage ( $V_{\text{OS}}$ )	$V_{\text{CM}} = 0.3\text{V}$		$\pm 1$	$\pm 2$	mV
	$V_{\text{CM}} = 1.5\text{V}$		$\pm 1$	$\pm 3$	
Over temperature	$V_{\text{CM}} = 0.3\text{V}$ and $1.5\text{V}$			$\pm 4$	
Drift ( $dV_{\text{OS}}/dT$ )			1		$\mu\text{V}/^\circ\text{C}$
Power-Supply Rejection Ratio (PSRR)	$V_S = 1.8\text{V}$ to $5.5\text{V}$ , $V_{\text{CM}} = 0.3\text{V}$	80	109		dB
<b>INPUT VOLTAGE RANGE</b>					
Common-mode voltage range ( $V_{\text{CM}}$ )	$\text{CMRR} \geq 57\text{dB}$	0		1.8	V
Common-Mode Rejection Ratio (CMRR)	$0\text{V} < V_{\text{CM}} < 1.8\text{V}$	57	92		dB
	$0\text{V} < V_{\text{CM}} < 0.7\text{V}$	87	92		
	$1.3\text{V} < V_{\text{CM}} < 1.8\text{V}$	57	98		
<b>INPUT BIAS CURRENT</b>					
Input bias current ( $I_B$ )			$\pm 0.1$		pA
Input offset current ( $I_{\text{OS}}$ )			$\pm 0.1$		
<b>INPUT IMPEDANCE</b>					
Differential			$10^{13} \parallel 2.5$		$\Omega \parallel \text{pF}$
Common mode			$10^{13} \parallel 2.5$		
<b>NOISE</b>					
Input voltage noise density, $f = 1\text{kHz}$ ( $e_n$ )			250		$\text{nV}/\sqrt{\text{Hz}}$
Current noise density, $f = 1\text{kHz}$ ( $i_n$ )			80		$\text{fA}/\sqrt{\text{Hz}}$
<b>OPEN-LOOP GAIN</b>					
Open-loop voltage gain ( $A_{\text{OL}}$ )	$R_L = 100\text{k}\Omega$ to $V^+/2$ , $0.5\text{V} < V_O < 1.3\text{V}$	91	101		dB
<b>OUTPUT</b>					
Voltage output swing from positive rail	$R_L = 100\text{k}\Omega$ to $V^+/2$		3	20	mV
Voltage output swing from negative rail	$R_L = 100\text{k}\Omega$ to $V^+/2$		2	20	
Output current sourcing	Sourcing, $V_O$ to $V^-$ , $V_{\text{IN}}(\text{diff}) = 100\text{mV}$	1	3		mA
Output current sinking	Sinking, $V_O$ to $V^+$ , $V_{\text{IN}}(\text{diff}) = -100\text{mV}$	1	5		
<b>FREQUENCY RESPONSE</b>					
Gain-bandwidth product (GBWP)	$C_L = 20\text{pF}$		7		kHz
Slew rate (SR)	$G = +1$ , Rising edge, $1V_{\text{p-p}}$ , $C_L = 20\text{pF}$		3.4		V/ms
	$G = +1$ , Falling edge, $1V_{\text{p-p}}$ , $C_L = 20\text{pF}$		3.7		
<b>POWER SUPPLY</b>					
Specified voltage range ( $V_S$ )		1.6		5.5	V
Quiescent current per channel ( $I_Q$ )	$V_{\text{CM}} = 0.3\text{V}$ , $I_O = 0$		490	800	nA
		Over temperature		1100	
Quiescent current per channel ( $I_Q$ )	$V_{\text{CM}} = 1.5\text{V}$ , $I_O = 0$		680	1100	
		Over temperature		1500	

(1) Refer to [Typical Characteristics](#).

## 6.6 Electrical Characteristics 3.3 V

 $T_A = 25^\circ\text{C}$ ,  $V^+ = 3.3\text{V}$ ,  $V^- = 0\text{V}$ ,  $V_{CM} = V_O = V^+/2$ , and  $R_L > 1\text{ M}\Omega$ , unless otherwise noted.

PARAMETER	TEST CONDITIONS	MIN	TYP <sup>(1)</sup>	MAX	UNIT
<b>OFFSET VOLTAGE</b>					
Input offset voltage ( $V_{OS}$ )	$V_{CM} = 0.3$		$\pm 1$	$\pm 2$	mV
	$V_{CM} = 3\text{ V}$		$\pm 1$	$\pm 3$	
Over temperature	$V_{CM} = 0.3\text{ V}$ and $3\text{ V}$			$\pm 4$	
Drift ( $dV_{OS}/dT$ )			1		$\mu\text{V}/^\circ\text{C}$
Power-Supply Rejection Ratio (PSRR)	$V_S = 1.8\text{ V}$ to $5.5\text{ V}$ , $V_{CM} = 0.3\text{ V}$	80	109		dB
<b>INPUT VOLTAGE RANGE</b>					
Common-mode voltage range ( $V_{CM}$ )	$\text{CMRR} \geq 60\text{ dB}$	0		3.3	V
Common-Mode Rejection Ratio (CMRR)	$0\text{ V} < V_{CM} < 3.3\text{ V}$	62	98		dB
	$0\text{ V} < V_{CM} < 2.2\text{ V}$	88	98		
	$2.7\text{ V} < V_{CM} < 3.3\text{ V}$	62	105		
<b>INPUT BIAS CURRENT</b>					
Input bias current ( $I_B$ )			$\pm 0.1$		pA
Input offset current ( $I_{OS}$ )			$\pm 0.1$		
<b>INPUT IMPEDANCE</b>					
Differential			$10^{13} \parallel 2.5$		$\Omega \parallel \text{pF}$
Common mode			$10^{13} \parallel 2.5$		
<b>NOISE</b>					
Input voltage noise density, $f = 1\text{ kHz}$ ( $e_n$ )			250		$\text{nV}/\sqrt{\text{Hz}}$
Current noise density, $f = 1\text{ kHz}$ ( $i_n$ )			60		$\text{fA}/\sqrt{\text{Hz}}$
<b>OPEN-LOOP GAIN</b>					
Open-loop voltage gain ( $A_{OL}$ )	$R_L = 100\text{ k}\Omega$ to $V^+/2$ , $0.5\text{ V} < V_O < 2.8\text{ V}$	91	101		dB
<b>OUTPUT</b>					
Voltage output swing from positive Rail	$R_L = 100\text{ k}\Omega$ to $V^+/2$		3	20	mV
Voltage output swing from negative Rail	$R_L = 100\text{ k}\Omega$ to $V^+/2$		2	20	
Output current sourcing	Sourcing, $V_O$ to $V^-$ , $V_{IN}(\text{diff}) = 100\text{ mV}$	5	14		mA
Output current sinking	Sinking, $V_O$ to $V^+$ , $V_{IN}(\text{diff}) = -100\text{ mV}$	5	19		
<b>FREQUENCY RESPONSE</b>					
Gain-bandwidth product (GBWP)	$C_L = 20\text{ pF}$		8		kHz
Slew rate (SR)	$G = +1$ , Rising edge, $1V_{p-p}$ , $C_L = 20\text{ pF}$		3.6		V/ms
	$G = +1$ , Falling edge, $1V_{p-p}$ , $C_L = 20\text{ pF}$		3.7		
<b>POWER SUPPLY</b>					
Specified voltage range ( $V_S$ )		1.6		5.5	V
Quiescent current per channel ( $I_Q$ )	$V_{CM} = 0.3\text{ V}$ , $I_O = 0$		480	800	nA
		Over temperature		1200	
Quiescent current per channel ( $I_Q$ )	$V_{CM} = 3\text{ V}$ , $I_O = 0$		650	1100	
		Over temperature		1500	

 (1) Refer to [Typical Characteristics](#).

## 6.7 Electrical Characteristics 5 V

 $T_A = 25^\circ\text{C}$ ,  $V^+ = 5\text{ V}$ ,  $V^- = 0\text{ V}$ ,  $V_{CM} = V_O = V^+/2$ , and  $R_L > 1\text{ M}\Omega$ , unless otherwise noted.

PARAMETER	TEST CONDITIONS	MIN	TYP <sup>(1)</sup>	MAX	UNIT
<b>OFFSET VOLTAGE</b>					
Input offset voltage ( $V_{OS}$ )	$V_{CM} = 0.3\text{ V}$		$\pm 1$	$\pm 2$	mV
	$V_{CM} = 4.7\text{ V}$		$\pm 1$	$\pm 3$	
Over temperature	$V_{CM} = 0.3\text{ V}$ and $4.7\text{ V}$			$\pm 4$	
Drift ( $dV_{OS}/dT$ )			1		$\mu\text{V}/^\circ\text{C}$
Power-Supply Rejection Ratio (PSRR)	$V_S = 1.8\text{ V}$ to $5.5\text{ V}$ , $V_{CM} = 0.3\text{ V}$	80	109		dB
<b>INPUT VOLTAGE RANGE</b>					
Common-Mode voltage range ( $V_{CM}$ )	$\text{CMRR} \geq 60\text{ dB}$	0		5	V
Common-Mode Rejection Ratio (CMRR)	$0\text{ V} < V_{CM} < 5\text{ V}$	65	101		dB
	$0\text{ V} < V_{CM} < 3.9\text{ V}$	88	101		
	$4.4\text{ V} < V_{CM} < 5\text{ V}$	65	109		
<b>INPUT BIAS CURRENT</b>					
Input bias current ( $I_B$ )			$\pm 0.1$		pA
Input offset current ( $I_{OS}$ )			$\pm 0.1$		
<b>INPUT IMPEDANCE</b>					
Differential			$10^{13} \parallel 2.5$		$\Omega \parallel \text{pF}$
Common mode			$10^{13} \parallel 2.5$		
<b>NOISE</b>					
Input voltage noise density, $f = 1\text{ kHz}$ ( $e_n$ )			250		$\text{nV}/\sqrt{\text{Hz}}$
Current noise density, $f = 1\text{ kHz}$ ( $i_n$ )			65		$\text{fA}/\sqrt{\text{Hz}}$
<b>OPEN-LOOP GAIN</b>					
Open-loop voltage gain ( $A_{OL}$ )	$R_L = 100\text{ k}\Omega$ to $V^+/2$ , $0.5\text{ V} < V_O < 4.5\text{ V}$	91	101		dB
<b>OUTPUT</b>					
Voltage output swing from positive rail	$R_L = 100\text{ k}\Omega$ to $V^+/2$		3	20	mV
Voltage output swing from negative rail	$R_L = 100\text{ k}\Omega$ to $V^+/2$		2	20	
Output current sourcing	Sourcing, $V_O$ to $V^-$ , $V_{IN}(\text{diff}) = 100\text{ mV}$	10	30		mA
Output current sinking	Sinking, $V_O$ to $V^+$ , $V_{IN}(\text{diff}) = -100\text{ mV}$	10	36		
<b>FREQUENCY RESPONSE</b>					
Gain-bandwidth product (GBWP)	$C_L = 20\text{ pF}$		8		kHz
Slew rate (SR)	$G = +1$ , Rising edge, $1V_{p-p}$ , $C_L = 20\text{ pF}$		3.6		V/ms
	$G = +1$ , Falling edge, $1V_{p-p}$ , $C_L = 20\text{ pF}$		3.7		
<b>POWER SUPPLY</b>					
Specified voltage range ( $V_S$ )		1.6		5.5	V
Quiescent current per channel ( $I_Q$ )	$V_{CM} = 0.3\text{ V}$ , $I_O = 0$		480	850	nA
	Over temperature			1300	
Quiescent current per channel ( $I_Q$ )	$V_{CM} = 4.7\text{ V}$ , $I_O = 0$		680	1100	
	Over temperature			1600	

(1) Refer to [Typical Characteristics](#).

### 6.8 Typical Characteristics

$T_A = 25\text{ }^\circ\text{C}$ ,  $V_S = 5\text{ V}$ ,  $V_{OUT} = V_{CM} = V_S/2$ ,  $R_{LOAD} = 1\text{ M}\Omega$  connected to  $V_S/2$ , and  $C_L = 20\text{ pF}$ , unless otherwise noted.

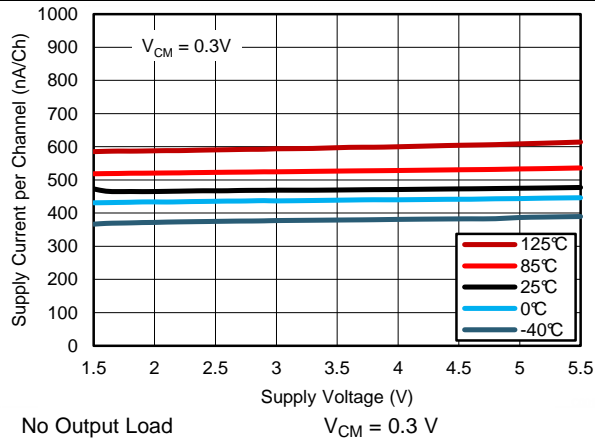

**Figure 1. Supply Voltage vs Supply Current per Channel, Low Vcm**

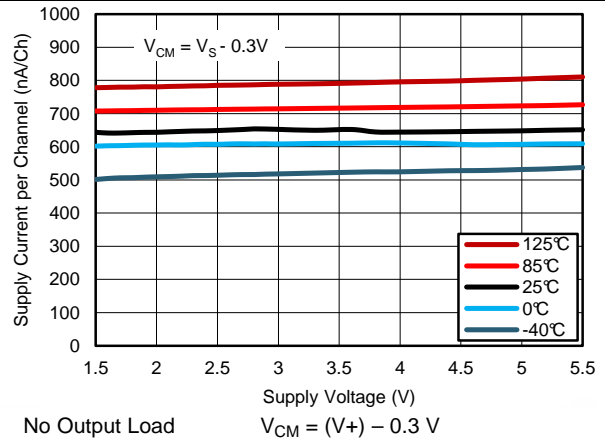

**Figure 2. Supply Voltage vs Supply Current per Channel, High Vcm**

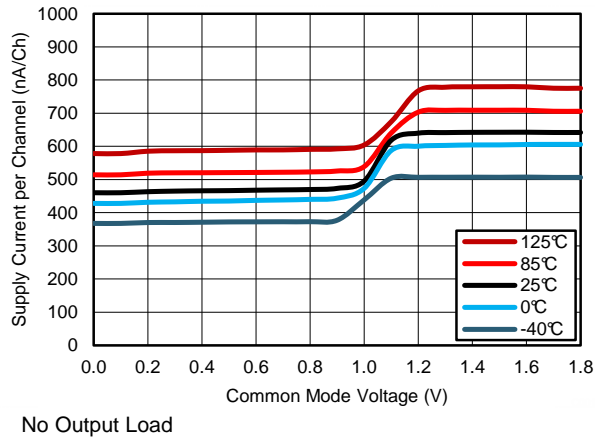

**Figure 3. Supply Current vs Common Mode at 1.8 V**

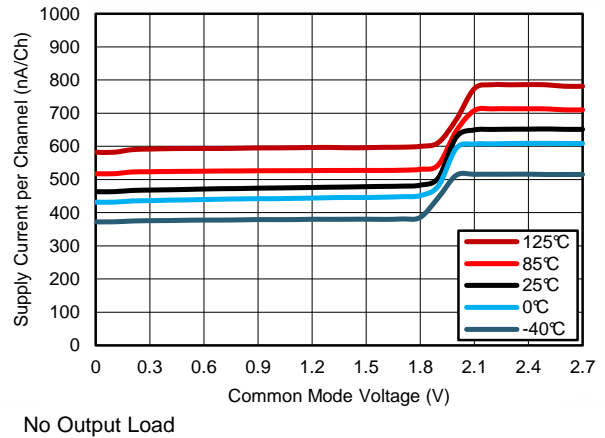

**Figure 4. Supply Current vs Common Mode at 2.7 V**

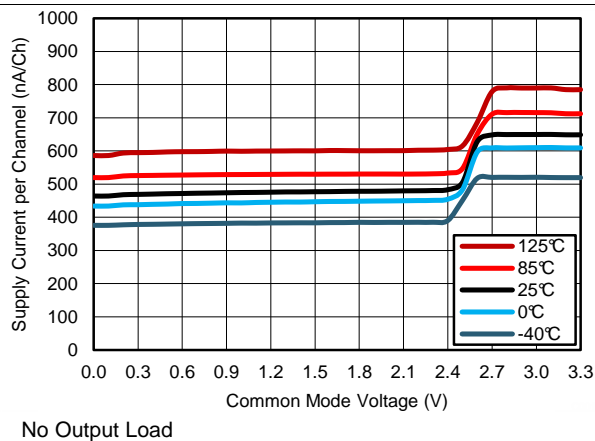

**Figure 5. Supply Current vs Common Mode at 3.3 V**

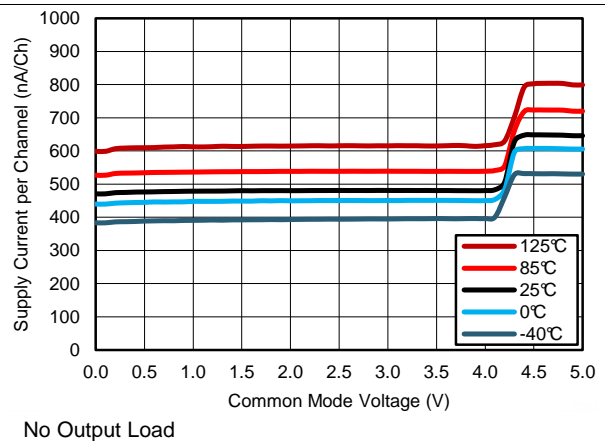
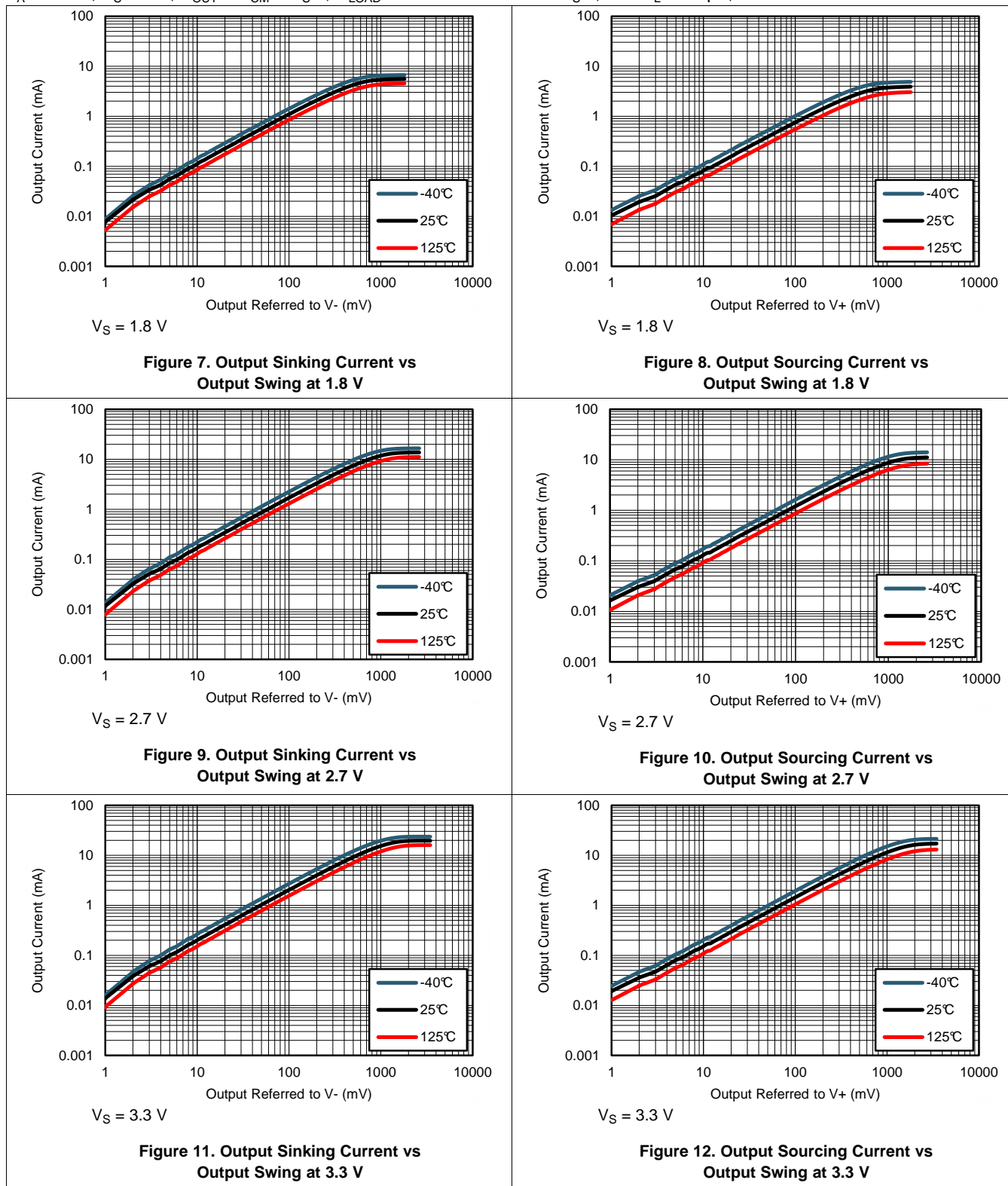

**Figure 6. Supply Current vs Common Mode at 5 V**



Typical Characteristics (continued)

$T_A = 25\text{ }^\circ\text{C}$ ,  $V_S = 5\text{ V}$ ,  $V_{OUT} = V_{CM} = V_S/2$ ,  $R_{LOAD} = 1\text{ M}\Omega$  connected to  $V_S/2$ , and  $C_L = 20\text{ pF}$ , unless otherwise noted.



Typical Characteristics (continued)

$T_A = 25\text{ }^\circ\text{C}$ ,  $V_S = 5\text{ V}$ ,  $V_{OUT} = V_{CM} = V_S/2$ ,  $R_{LOAD} = 1\text{ M}\Omega$  connected to  $V_S/2$ , and  $C_L = 20\text{ pF}$ , unless otherwise noted.

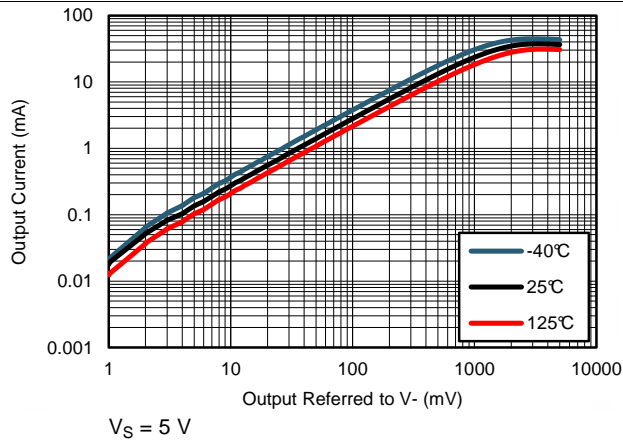

Figure 13. Output Sinking Current vs Output Swing at 5 V

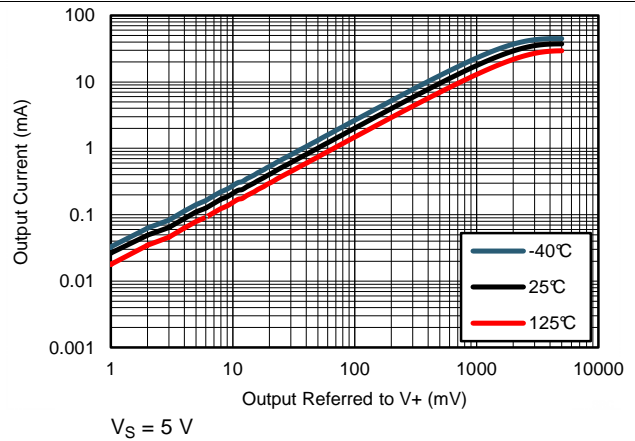

Figure 14. Output Sourcing Current vs Output Swing at 5 V

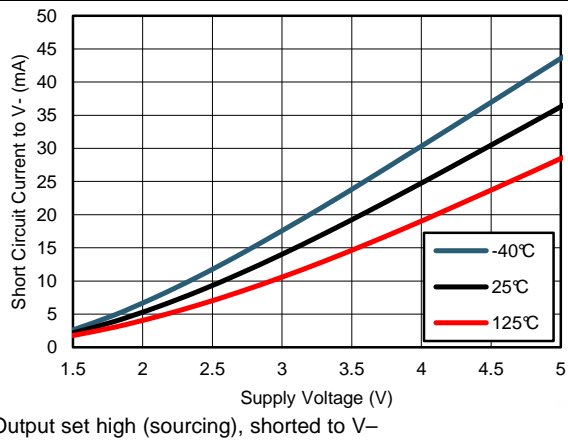

Figure 15. Output Short Circuit Current to V- vs Supply Voltage

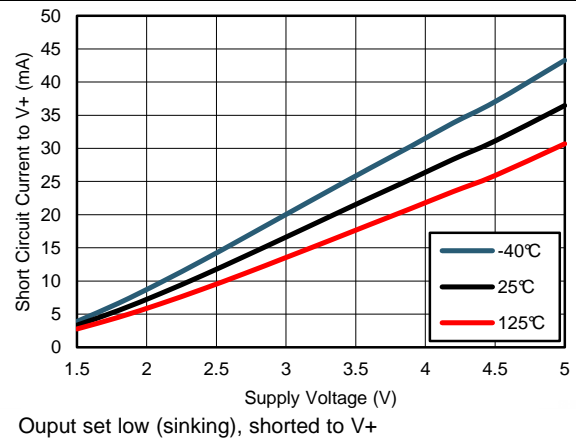

Figure 16. Output Short Circuit Current to V+ vs Supply Voltage

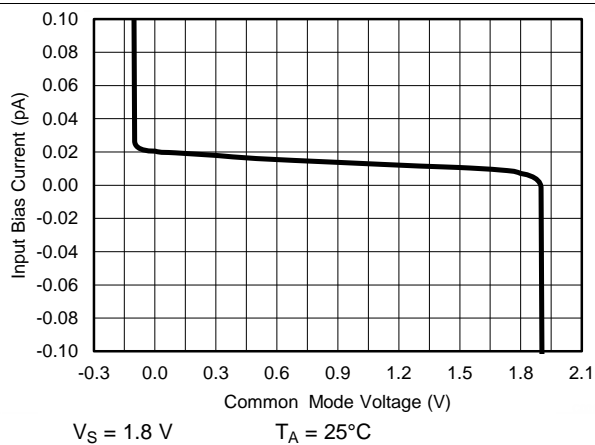

Figure 17. Input Bias Current vs Common Mode Voltage at 1.8 V

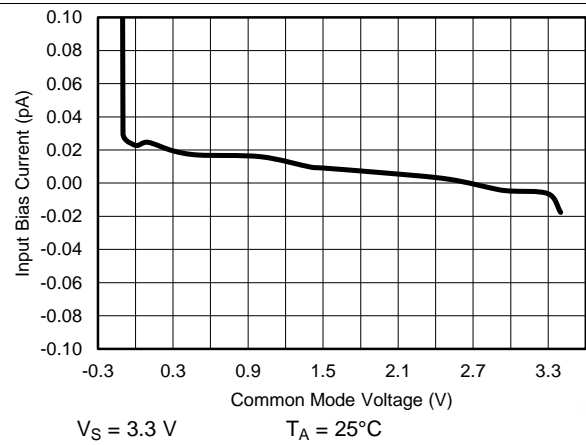

Figure 18. Input Bias Current vs Common Mode Voltage at 3.3 V

Typical Characteristics (continued)

$T_A = 25\text{ }^\circ\text{C}$ ,  $V_S = 5\text{ V}$ ,  $V_{OUT} = V_{CM} = V_S/2$ ,  $R_{LOAD} = 1\text{ M}\Omega$  connected to  $V_S/2$ , and  $C_L = 20\text{ pF}$ , unless otherwise noted.

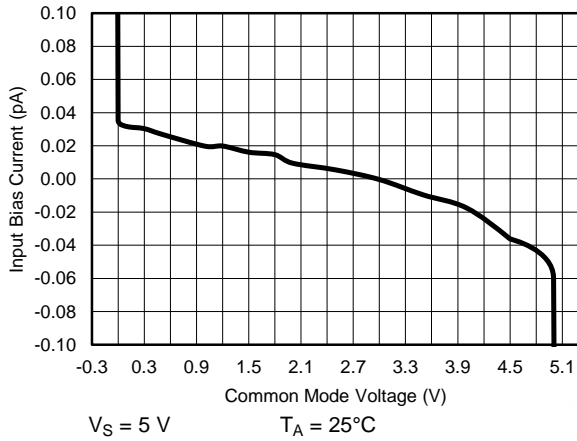

Figure 19. Input Bias Current vs Common Mode Voltage at 5V

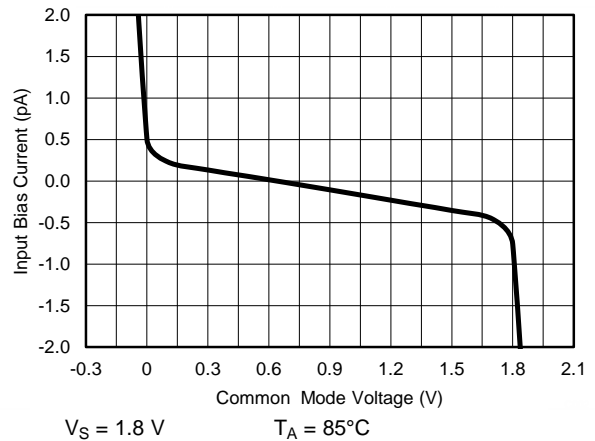

Figure 20. Input Bias Current vs Common Mode Voltage at 1.8V

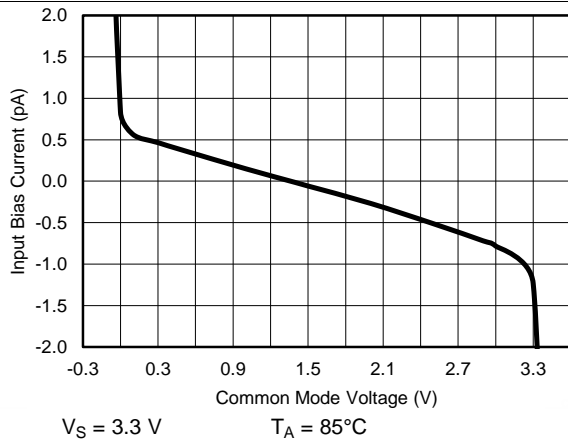

Figure 21. Input Bias Current vs Common Mode Voltage at 3.3 V

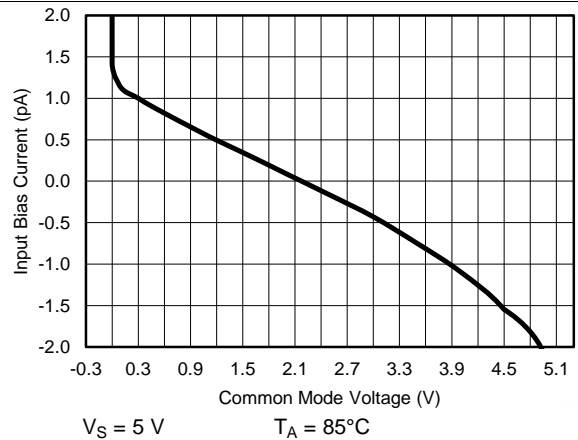

Figure 22. Input Bias Current vs Common Mode Voltage at 5 V

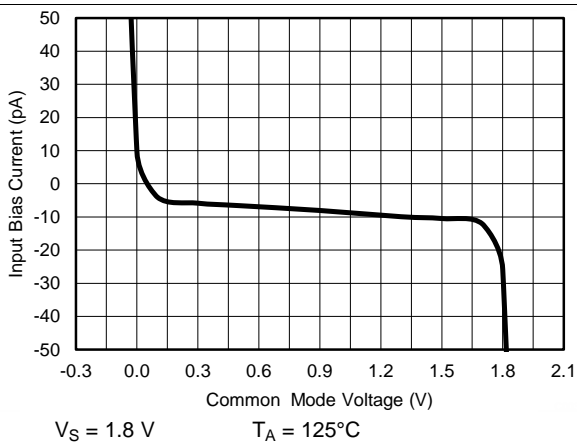

Figure 23. Input Bias Current vs Common Mode Voltage at 1.8 V

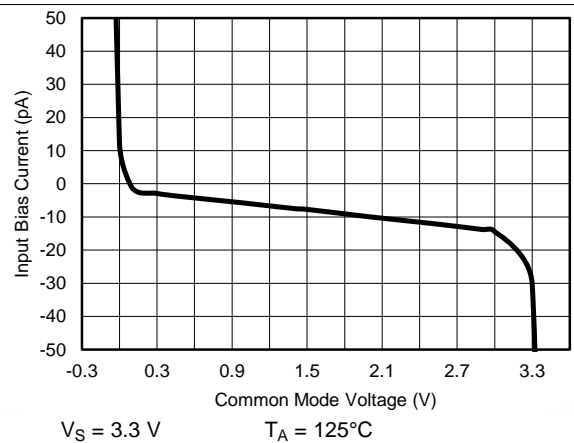

Figure 24. Input Bias Current vs Common Mode Voltage at 3.3 V

Typical Characteristics (continued)

$T_A = 25\text{ }^\circ\text{C}$ ,  $V_S = 5\text{ V}$ ,  $V_{OUT} = V_{CM} = V_S/2$ ,  $R_{LOAD} = 1\text{ M}\Omega$  connected to  $V_S/2$ , and  $C_L = 20\text{ pF}$ , unless otherwise noted.

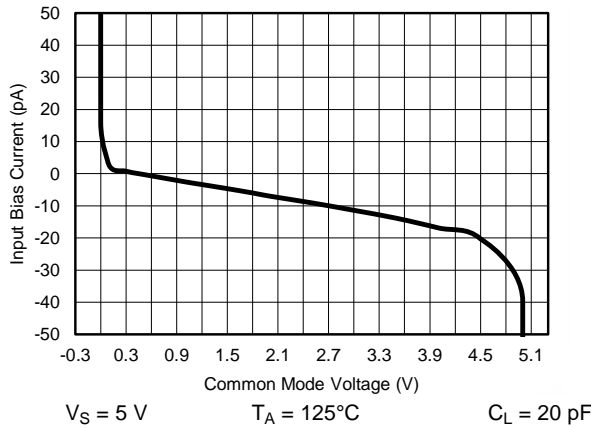

Figure 25. Input Bias Current vs Common Mode Voltage at 5 V

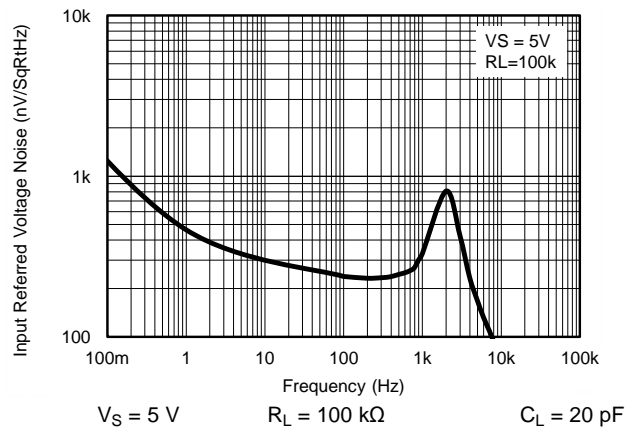

Figure 26. Input Referred Voltage Noise

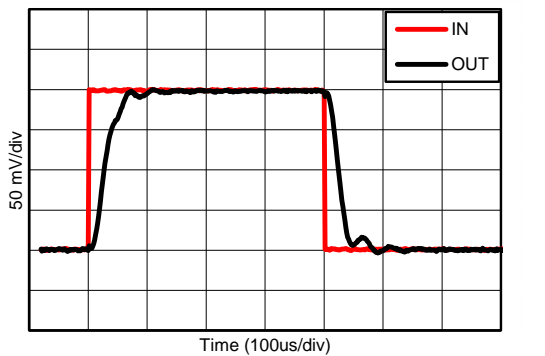

Figure 27. Pulse Response, 200mVpp at 1.8 V

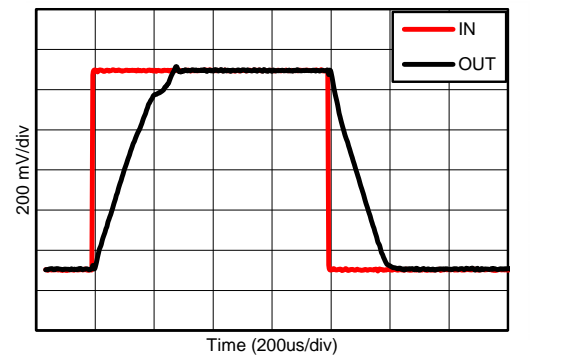

Figure 28. Pulse Response, 1Vpp at 1.8 V

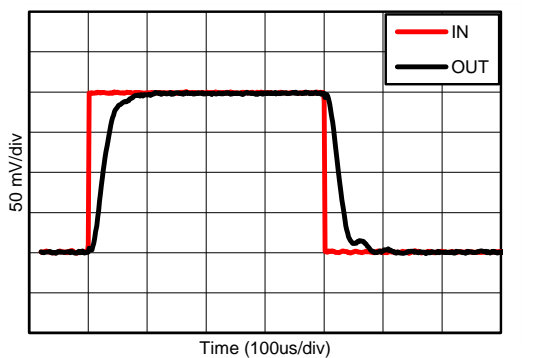

Figure 29. Pulse Response, 200mVpp at 5 V

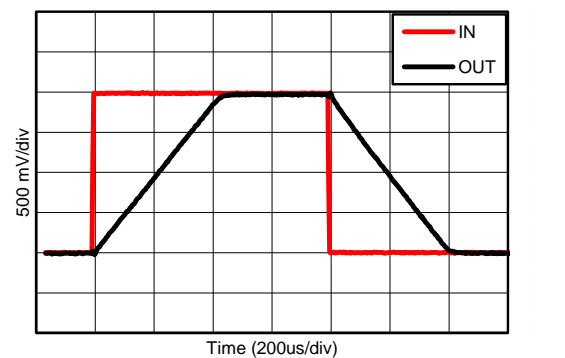

Figure 30. Pulse Response, 2Vpp at 5 V

Typical Characteristics (continued)

$T_A = 25\text{ }^\circ\text{C}$ ,  $V_S = 5\text{ V}$ ,  $V_{OUT} = V_{CM} = V_S/2$ ,  $R_{LOAD} = 1\text{ M}\Omega$  connected to  $V_S/2$ , and  $C_L = 20\text{ pF}$ , unless otherwise noted.

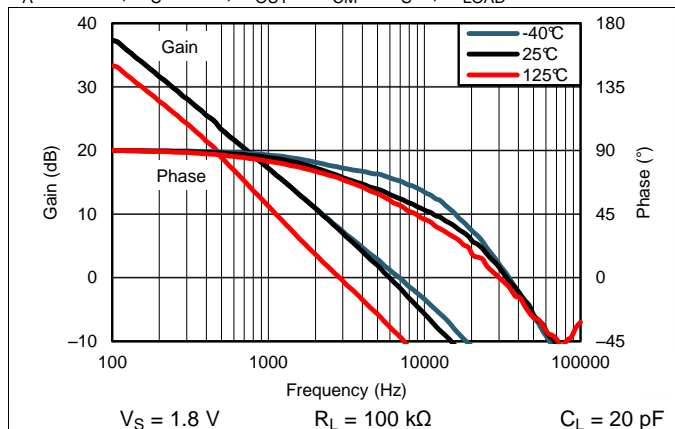

Figure 31. Gain and Phase vs Temperature at 1.8 V

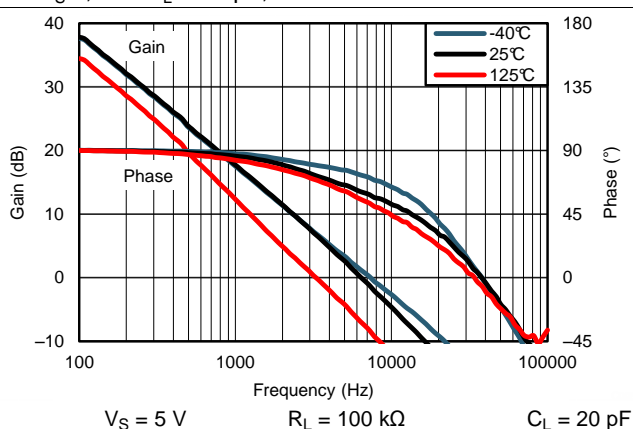

Figure 32. Gain and Phase vs Temperature at 5 V

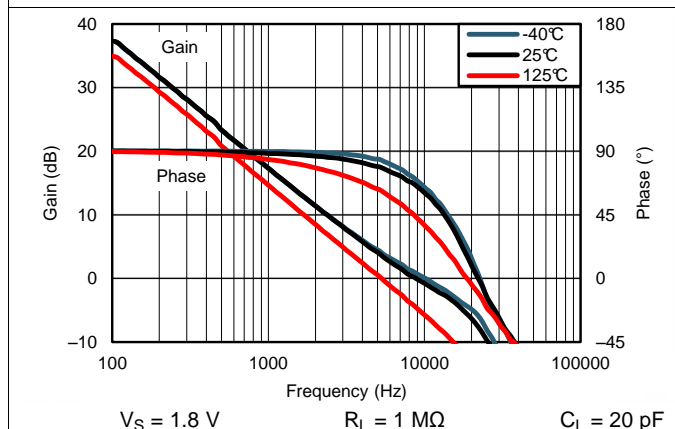

Figure 33. Gain and Phase vs Temperature at 1.8 V

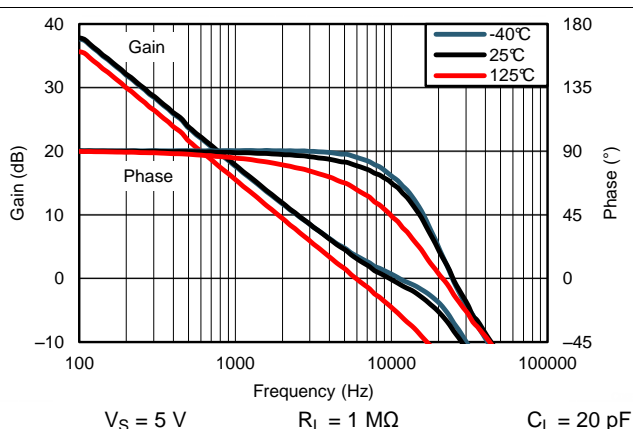

Figure 34. Gain and Phase vs Temperature at 5 V

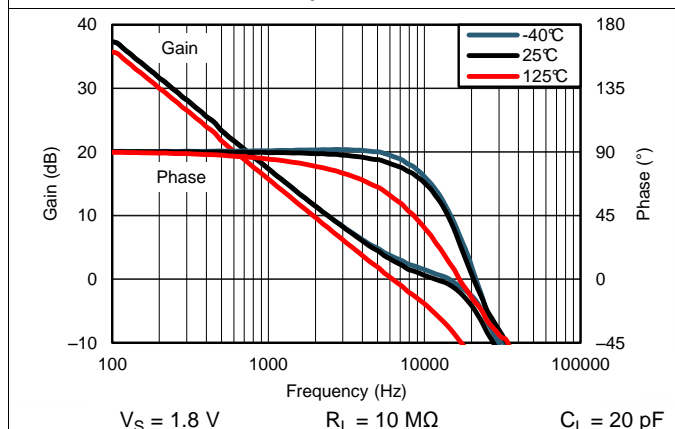

Figure 35. Gain and Phase vs Temperature at 1.8 V

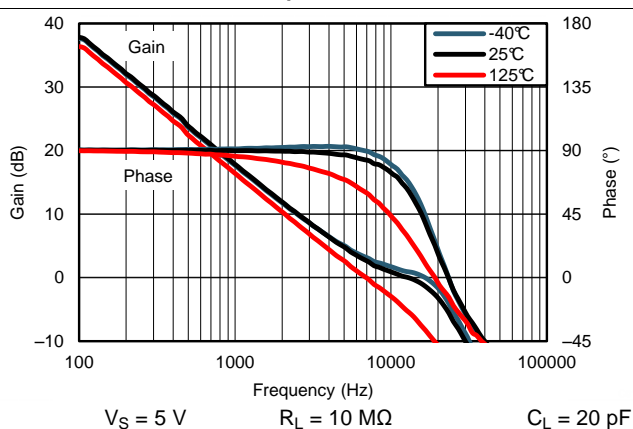

Figure 36. Gain and Phase vs Temperature at 5 V

## 7 Detailed Description

### 7.1 Overview

The LPV542 dual op amplifier is unity-gain stable and can operate on a single supply, making it highly versatile and easy to use.

The LPV542 is fully specified and tested from 1.6 V to 5.5 V. Parameters that vary significantly with operating voltages or temperature are shown in the *Typical Characteristics* curves.

### 7.2 Functional Block Diagram



### 7.3 Feature Description

The amplifier's differential inputs consist of a non-inverting input (+IN) and an inverting input (–IN). The amplifier amplifies only the difference in voltage between the two inputs, which is called the differential input voltage. The output voltage of the op-amp  $V_{OUT}$  is given by Equation 1:

$$V_{OUT} = A_{OL} (IN^+ - IN^-)$$

where

- $A_{OL}$  is the open-loop gain of the amplifier, typically around 100 dB (100,000x, or 100,000 Volts per microvolt). (1)

### 7.4 Device Functional Modes

#### 7.4.1 Rail-To-Rail Input

The input common-mode voltage range of the LPV542 extends to the supply rails. This is achieved with a complementary input stage — an N-channel input differential pair in parallel with a P-channel differential pair. The N-channel pair is active for input voltages close to the positive rail, typically  $(V+) - 800\text{ mV}$  to  $200\text{ mV}$  above the positive supply, while the P-channel pair is on for inputs from  $300\text{ mV}$  below the negative supply to approximately  $(V+) - 800\text{ mV}$ . There is a small transition region, typically  $(V+) - 1.2\text{ V}$  to  $(V+) - 0.8\text{ V}$ , in which both pairs are on. This 400 mV transition region can vary 200 mV with process variation. Within the 400 mV transition region PSRR, CMRR, offset voltage, offset drift, and THD may be degraded compared to operation outside this region.

#### 7.4.2 Supply Current Changes over Common Mode

Because of the ultra-low supply current, changes in common mode voltages will cause a noticeable change in the supply current as the input stages transition through the transition region, as shown in Figure 37 below.

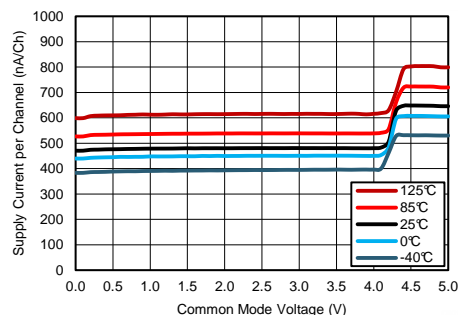

Figure 37. Supply Current Change over Common Mode at 5 V

For the lowest supply current operation, keep the input common mode range between  $V_-$  and 1 V below  $V_+$ .

## Device Functional Modes (continued)

### 7.4.3 Design Optimization With Rail-To-Rail Input

In most applications, operation is within the range of only one differential pair. However, some applications can subject the amplifier to a common-mode signal in the transition region. Under this condition, the inherent mismatch between the two differential pairs may lead to degradation of the CMRR and THD. The unity-gain buffer configuration is the most problematic as it will traverse through the transition region if a sufficiently wide input swing is required.

### 7.4.4 Design Optimization for Nanopower Operation

When designing for ultralow power, choose system components carefully. To minimize current consumption, select large-value resistors. Any resistors will react with stray capacitance in the circuit and the input capacitance of the operational amplifier. These parasitic RC combinations can affect the stability of the overall system. A feedback capacitor may be required to assure stability and limit overshoot or gain peaking.

When possible, use AC coupling and AC feedback to reduce static current draw through the feedback elements. Use film or ceramic capacitors since large electrolytics may have static leakage currents in the tens to hundreds of nanoamps.

### 7.4.5 Common-Mode Rejection

The CMRR for the LPV542 is specified in two ways so the best match for a given application may be used. First, the CMRR of the device in the common-mode range below the transition region ( $V_{CM} < (V+) - 0.9\text{ V}$ ) is given. This specification is the best indicator of the capability of the device when the application requires use of one of the differential input pairs. Second, the CMRR at  $V_S = 5\text{ V}$  over the entire common-mode range is specified.

### 7.4.6 Output Stage

The LPV542 output voltage swings 3 mV from rails at 3.3 V supply, which provides the maximum possible dynamic range at the output. This is particularly important when operating on low supply voltages.

The LPV542 Maximum Output Voltage Swing defines the maximum swing possible under a particular output load.

### 7.4.7 Driving Capacitive Load

The LPV542 is internally compensated for stable unity gain operation, with a 8 kHz typical gain bandwidth. However, the unity gain follower is the most sensitive configuration to capacitive load. The combination of a capacitive load placed directly on the output of an amplifier along with the amplifier's output impedance creates a phase lag, which reduces the phase margin of the amplifier. If the phase margin is significantly reduced, the response will be under damped which causes peaking in the transfer and, when there is too much peaking, the op amp might start oscillating.

In order to drive heavy (>50pF) capacitive loads, an isolation resistor,  $R_{ISO}$ , should be used, as shown in Figure 38. By using this isolation resistor, the capacitive load is isolated from the amplifier's output. The larger the value of  $R_{ISO}$ , the more stable the amplifier will be. If the value of  $R_{ISO}$  is sufficiently large, the feedback loop will be stable, independent of the value of  $C_L$ . However, larger values of  $R_{ISO}$  result in reduced output swing and reduced output current drive.

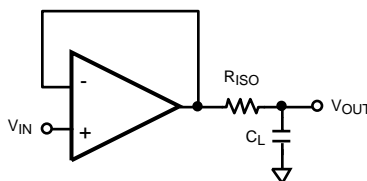

Figure 38. Resistive Isolation Of Capacitive Load

## 8 Application and Implementation

### NOTE

Information in the following applications sections is not part of the TI component specification, and TI does not warrant its accuracy or completeness. TI's customers are responsible for determining suitability of components for their purposes. Customers should validate and test their design implementation to confirm system functionality.

### 8.1 Application Information

The LPV542 is a ultra-low power operational amplifier that provides 8 kHz bandwidth with only 490nA quiescent current, and near precision offset and drift specifications at a low cost. These rail-to-rail input and output amplifiers are specifically designed for battery-powered applications. The input common-mode voltage range extends to the power-supply rails and the output swings to within millivolts of the rails, maintaining a wide dynamic range.

### 8.2 Typical Application: 60 Hz Twin "T" Notch Filter

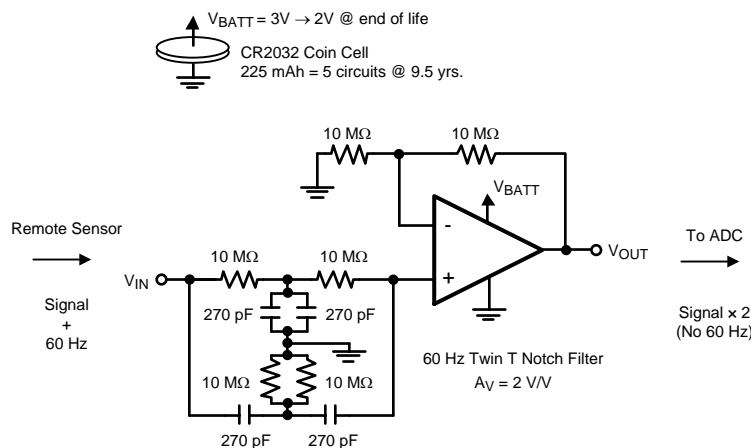

Figure 39. 60 Hz Notch Filter

#### 8.2.1 Design Requirements

Small signals from transducers in remote and distributed sensing applications commonly suffer strong 60 Hz interference from AC power lines. The circuit of Figure 39 notches out the 60 Hz and provides a gain  $A_V = 2$  for the sensor signal represented by a 1 kHz sine wave. Similar stages may be cascaded to remove 2<sup>nd</sup> and 3<sup>rd</sup> harmonics of 60 Hz. Thanks to the nA power consumption of the LPV542, even 5 such circuits can run for 9.5 years from a small CR2032 lithium cell. These batteries have a nominal voltage of 3 V and an end of life voltage of 2 V. With an operating voltage from 1.6 V to 5.5 V the LPV542 can function over this voltage range.

#### 8.2.2 Detailed Design Procedure

The notch frequency is set by:

$$F_0 = 1 / 2\pi RC. \tag{2}$$

To achieve a 60 Hz notch use  $R = 10 \text{ M}\Omega$  and  $C = 270 \text{ pF}$ . If eliminating 50 Hz noise, which is common in European systems, use  $R = 11.8 \text{ M}\Omega$  and  $C = 270 \text{ pF}$ .

The Twin T Notch Filter works by having two separate paths from  $V_{IN}$  to the amplifier's input. A low frequency path through the series input resistors and another separate high frequency path through the series input capacitors. However, at frequencies around the notch frequency, the two paths have opposing phase angles and the two signals will tend to cancel at the amplifier's input.



## Typical Application: 60 Hz Twin "T" Notch Filter (continued)

To ensure that the target center frequency is achieved and to maximize the notch depth (Q factor) the filter needs to be as balanced as possible. To obtain circuit balance, while overcoming limitations of available standard resistor and capacitor values, use passives in parallel to achieve the 2C and R/2 circuit requirements for the filter components that connect to ground.

To make sure passive component values stay as expected clean board with alcohol, rinse with deionized water, and air dry. Make sure board remains in a relatively low humidity environment to minimize moisture which may increase the conductivity of board components. Also large resistors come with considerable parasitic stray capacitance which effects can be reduced by cutting out the ground plane below components of concern.

Large resistors are used in the feedback network to minimize battery drain. When designing with large resistors, resistor thermal noise, op amp current noise, as well as op amp voltage noise, must be considered in the noise analysis of the circuit. The noise analysis for the circuit in [Figure 39](#) can be done over a bandwidth of 2 kHz, which takes the conservative approach of overestimating the bandwidth (LPV542 typical GBW/A<sub>V</sub> is lower). The total noise at the output is approximately 800 μVpp, which is excellent considering the total consumption of the circuit is only 900 nA. The dominant noise terms are op amp voltage noise, current noise through the feedback network (430 μVpp), and current noise through the notch filter network (280 μVpp). Thus the total circuit's noise is below 1/2 LSB of a 10-bit system with a 2 V reference, which is 1 mV.

### 8.2.3 Application Curve

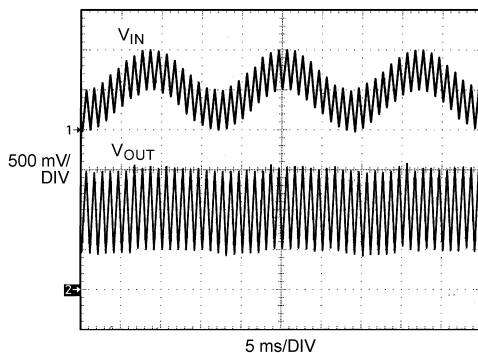

**Figure 40. 60 Hz Notch Filter Waveform**

### 8.3 Do's and Don'ts

Do properly bypass the power supplies.

Do add series resistance to the output when driving capacitive loads, particularly cables, Muxes and ADC inputs.

Do add series current limiting resistors and external schottky clamp diodes if input voltage is expected to exceed the supplies. Limit the current to 1 mA or less (1 KΩ per volt).

## 9 Power Supply Recommendations

The LPV542 is specified for operation from 1.6 V to 5.5 V ( $\pm 0.8$  V to  $\pm 2.75$  V) over a  $-40^{\circ}\text{C}$  to  $125^{\circ}\text{C}$  temperature range. Parameters that can exhibit significant variance with regard to operating voltage or temperature are presented in the [Typical Characteristics](#).

### CAUTION

Supply voltages larger than 6 V can permanently damage the device.

For proper operation, the power supplies must be properly decoupled. For decoupling the supply lines it is suggested that 10 nF capacitors be placed as close as possible to the operational amplifier power supply pins. For single supply, place a capacitor between  $V^+$  and  $V^-$  supply leads. For dual supplies, place one capacitor between  $V^+$  and ground, and one capacitor between  $V^-$  and ground.

Low bandwidth nanopower devices do not have good high frequency ( $> 1$  kHz) AC PSRR rejection against high-frequency switching supplies and other 1 kHz and above noise sources, so extra supply filtering is recommended if kilohertz or above noise is expected on the power supply lines.

## 10 Layout

### 10.1 Layout Guidelines

The  $V^+$  pin should be bypassed to ground with a low ESR capacitor.

The optimum placement is closest to the  $V^+$  and ground pins.

Care should be taken to minimize the loop area formed by the bypass capacitor connection between  $V^+$  and ground.

The ground pin should be connected to the PCB ground plane at the pin of the device.

The feedback components should be placed as close to the device as possible to minimize strays.

There is an internal electrical connection between the exposed Die Attach Pad (DAP) and the  $V^-$  pin. For best performance the DAP should be connected to the exact same potential as the  $V^-$  pin. Do not use the DAP as the primary  $V^-$  supply. Floating the DAP pad is not recommended. The DAP and  $V^-$  pin should be joined directly as shown in the [Layout Example](#).

### 10.2 Layout Example

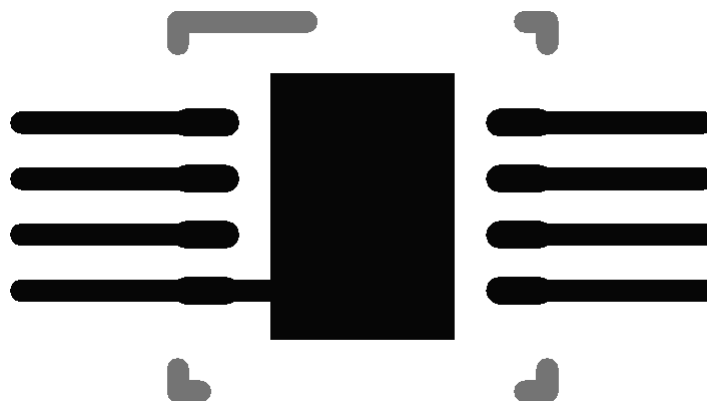

Figure 41. X1SON Layout Example (top view)

## 11 Device and Documentation Support

### 11.1 Device Support

#### 11.1.1 Development Support

TINA-TI SPICE-Based Analog Simulation Program, <http://www.ti.com/tool/tina-ti>

DIP Adapter Evaluation Module, <http://www.ti.com/tool/dip-adapter-evm>

TI Universal Operational Amplifier Evaluation Module, <http://www.ti.com/tool/opampevm>

TI FilterPro Filter Design software, <http://www.ti.com/tool/filterpro>

### 11.2 Documentation Support

#### 11.2.1 Related Documentation

For related documentation, see the following:

- AN-1798 Designing with Electro-Chemical Sensors, [SNOA514](#)
- AN-1803 Design Considerations for a Transimpedance Amplifier, [SNOA515](#)
- AN-1852 Designing With pH Electrodes, [SNOA529](#)
- Compensate Transimpedance Amplifiers Intuitively, [SBOA055](#)
- Transimpedance Considerations for High-Speed Operational Amplifiers, [SBOA112](#)
- Noise Analysis of FET Transimpedance Amplifiers, [SBOA060](#)
- Circuit Board Layout Techniques, [SLOA089](#)
- Handbook of Operational Amplifier Applications, [SBOA092](#)

### 11.3 Community Resources

The following links connect to TI community resources. Linked contents are provided "AS IS" by the respective contributors. They do not constitute TI specifications and do not necessarily reflect TI's views; see TI's [Terms of Use](#).

**TI E2E™ Online Community** *TI's Engineer-to-Engineer (E2E) Community*. Created to foster collaboration among engineers. At [e2e.ti.com](http://e2e.ti.com), you can ask questions, share knowledge, explore ideas and help solve problems with fellow engineers.

**Design Support** *TI's Design Support* Quickly find helpful E2E forums along with design support tools and contact information for technical support.

### 11.4 Trademarks

E2E is a trademark of Texas Instruments.  
All other trademarks are the property of their respective owners.

### 11.5 Electrostatic Discharge Caution



These devices have limited built-in ESD protection. The leads should be shorted together or the device placed in conductive foam during storage or handling to prevent electrostatic damage to the MOS gates.

### 11.6 Glossary

[SLYZ022](#) — *TI Glossary*.

This glossary lists and explains terms, acronyms, and definitions.

## 12 Mechanical, Packaging, and Orderable Information

The following pages include mechanical, packaging, and orderable information. This information is the most current data available for the designated devices. This data is subject to change without notice and revision of this document. For browser-based versions of this data sheet, refer to the left-hand navigation.

## PACKAGING INFORMATION

Orderable Device	Status (1)	Package Type	Package Drawing	Pins	Package Qty	Eco Plan (2)	Lead finish/ Ball material (6)	MSL Peak Temp (3)	Op Temp (°C)	Device Marking (4/5)	Samples
LPV542DGKR	ACTIVE	VSSOP	DGK	8	2500	RoHS & Green	NIPDAU   SN   NIPDAUAG	Level-1-260C-UNLIM	-40 to 125	(LP, V542)	<a href="#">Samples</a>
LPV542DGKT	ACTIVE	VSSOP	DGK	8	250	RoHS & Green	NIPDAU   SN   NIPDAUAG	Level-1-260C-UNLIM	-40 to 125	(LP, V542)	<a href="#">Samples</a>
LPV542DNXR	ACTIVE	X1SON	DNX	8	3000	RoHS & Green	NIPDAUAG	Level-1-260C-UNLIM	-40 to 125	LPV542	<a href="#">Samples</a>
LPV542DNXT	ACTIVE	X1SON	DNX	8	250	RoHS & Green	NIPDAUAG	Level-1-260C-UNLIM	-40 to 125	LPV542	<a href="#">Samples</a>

(1) The marketing status values are defined as follows:

**ACTIVE:** Product device recommended for new designs.

**LIFEBUY:** TI has announced that the device will be discontinued, and a lifetime-buy period is in effect.

**NRND:** Not recommended for new designs. Device is in production to support existing customers, but TI does not recommend using this part in a new design.

**PREVIEW:** Device has been announced but is not in production. Samples may or may not be available.

**OBSOLETE:** TI has discontinued the production of the device.

(2) **RoHS:** TI defines "RoHS" to mean semiconductor products that are compliant with the current EU RoHS requirements for all 10 RoHS substances, including the requirement that RoHS substance do not exceed 0.1% by weight in homogeneous materials. Where designed to be soldered at high temperatures, "RoHS" products are suitable for use in specified lead-free processes. TI may reference these types of products as "Pb-Free".

**RoHS Exempt:** TI defines "RoHS Exempt" to mean products that contain lead but are compliant with EU RoHS pursuant to a specific EU RoHS exemption.

**Green:** TI defines "Green" to mean the content of Chlorine (Cl) and Bromine (Br) based flame retardants meet JS709B low halogen requirements of <=1000ppm threshold. Antimony trioxide based flame retardants must also meet the <=1000ppm threshold requirement.

(3) MSL, Peak Temp. - The Moisture Sensitivity Level rating according to the JEDEC industry standard classifications, and peak solder temperature.

(4) There may be additional marking, which relates to the logo, the lot trace code information, or the environmental category on the device.

(5) Multiple Device Markings will be inside parentheses. Only one Device Marking contained in parentheses and separated by a "~" will appear on a device. If a line is indented then it is a continuation of the previous line and the two combined represent the entire Device Marking for that device.

(6) Lead finish/Ball material - Orderable Devices may have multiple material finish options. Finish options are separated by a vertical ruled line. Lead finish/Ball material values may wrap to two lines if the finish value exceeds the maximum column width.

**Important Information and Disclaimer:** The information provided on this page represents TI's knowledge and belief as of the date that it is provided. TI bases its knowledge and belief on information provided by third parties, and makes no representation or warranty as to the accuracy of such information. Efforts are underway to better integrate information from third parties. TI has taken and

continues to take reasonable steps to provide representative and accurate information but may not have conducted destructive testing or chemical analysis on incoming materials and chemicals. TI and TI suppliers consider certain information to be proprietary, and thus CAS numbers and other limited information may not be available for release.

In no event shall TI's liability arising out of such information exceed the total purchase price of the TI part(s) at issue in this document sold by TI to Customer on an annual basis.

## TAPE AND REEL INFORMATION



### QUADRANT ASSIGNMENTS FOR PIN 1 ORIENTATION IN TAPE



\*All dimensions are nominal

Device	Package Type	Package Drawing	Pins	SPQ	Reel Diameter (mm)	Reel Width W1 (mm)	A0 (mm)	B0 (mm)	K0 (mm)	P1 (mm)	W (mm)	Pin1 Quadrant
LPV542DGKR	VSSOP	DGK	8	2500	330.0	12.4	5.3	3.4	1.4	8.0	12.0	Q1
LPV542DGKT	VSSOP	DGK	8	250	180.0	12.4	5.3	3.4	1.4	8.0	12.0	Q1
LPV542DNXR	X1SON	DNX	8	3000	330.0	12.4	3.3	3.3	0.7	8.0	12.0	Q1
LPV542DNXT	X1SON	DNX	8	250	180.0	12.5	3.3	3.3	0.7	8.0	12.0	Q1

## TAPE AND REEL BOX DIMENSIONS



\*All dimensions are nominal

Device	Package Type	Package Drawing	Pins	SPQ	Length (mm)	Width (mm)	Height (mm)
LPV542DGKR	VSSOP	DGK	8	2500	353.0	353.0	32.0
LPV542DGKT	VSSOP	DGK	8	250	210.0	185.0	35.0
LPV542DNXR	X1SON	DNX	8	3000	338.0	355.0	50.0
LPV542DNXT	X1SON	DNX	8	250	338.0	355.0	50.0

DNX0008A

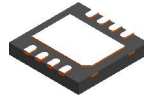

**PACKAGE OUTLINE**  
**X1SON - 0.5 mm max height**

PLASTIC SMALL OUTLINE - NO LEAD

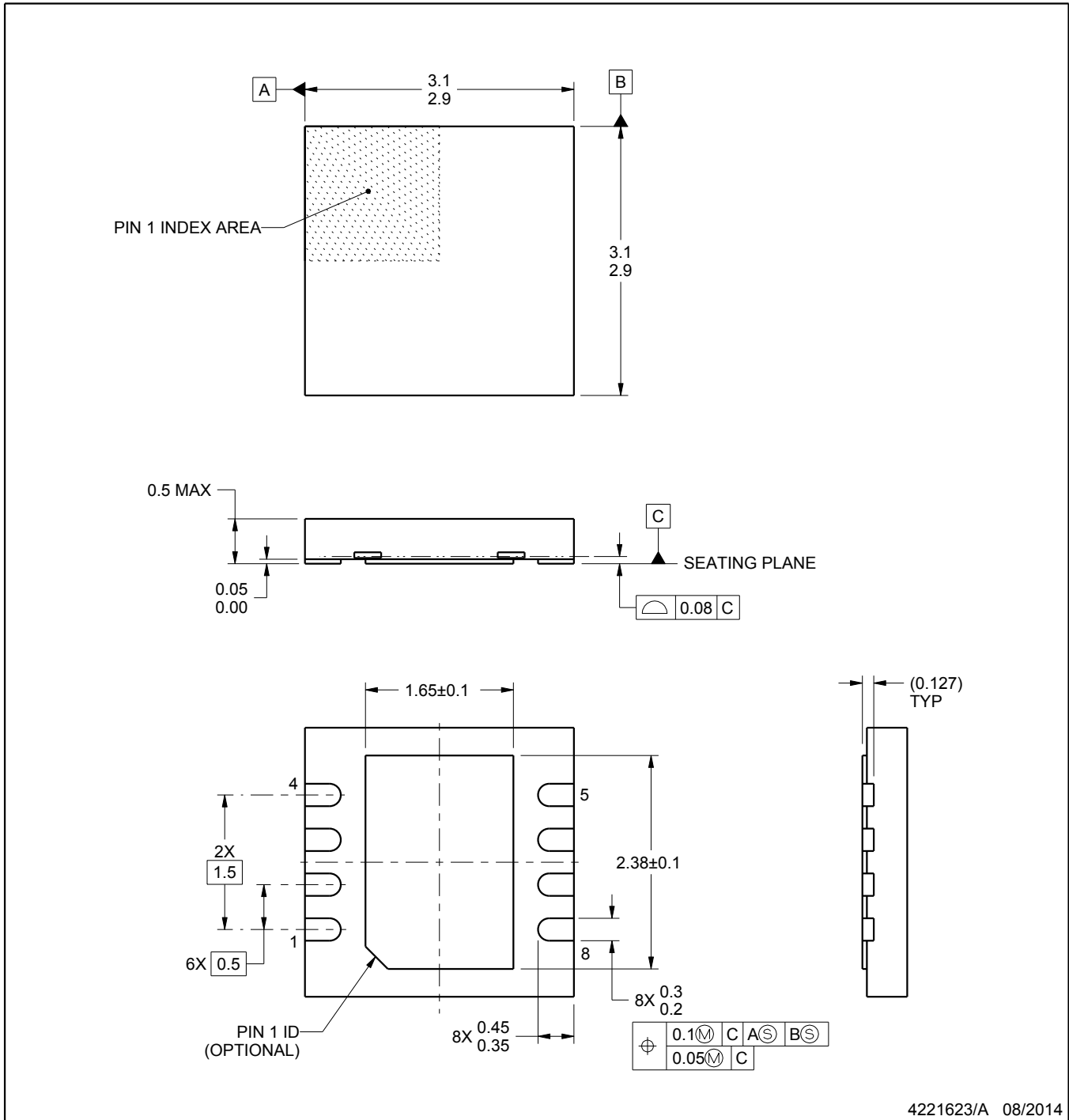

4221623/A 08/2014

NOTES:

1. All linear dimensions are in millimeters. Any dimensions in parenthesis are for reference only. Dimensioning and tolerancing per ASME Y14.5M.
2. This drawing is subject to change without notice.
3. The package thermal pad must be soldered to the printed circuit board for thermal and mechanical performance.



# EXAMPLE BOARD LAYOUT

DNX0008A

X1SON - 0.5 mm max height

PLASTIC SMALL OUTLINE - NO LEAD

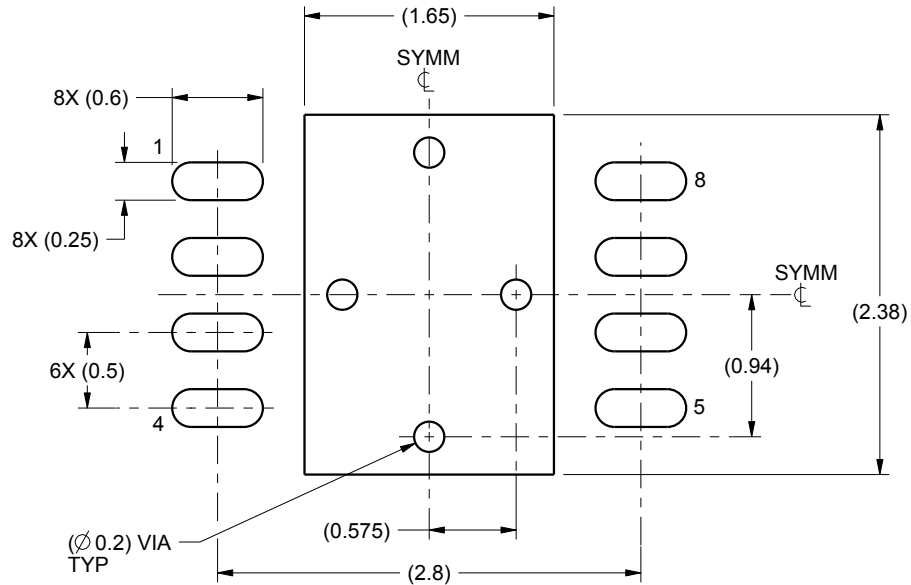

LAND PATTERN EXAMPLE  
SCALE:20X

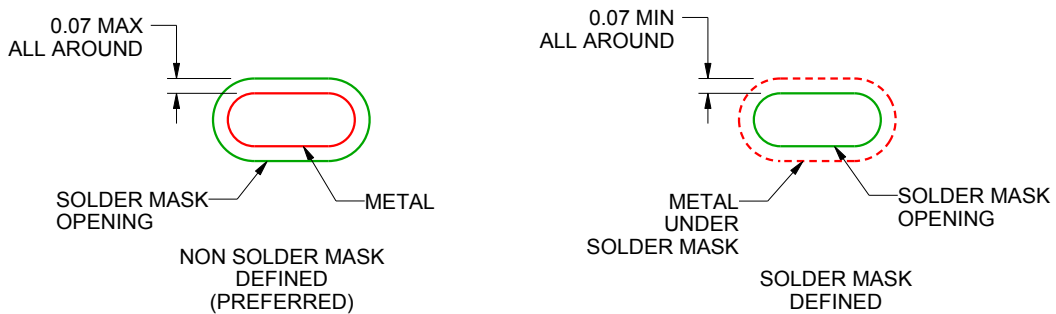

SOLDER MASK DETAILS

4221623/A 08/2014

NOTES: (continued)

4. This package is designed to be soldered to a thermal pad on the board. For more information, see Texas Instruments literature number SLUA271 ([www.ti.com/lit/slua271](http://www.ti.com/lit/slua271)).

# EXAMPLE STENCIL DESIGN

DNX0008A

X1SON - 0.5 mm max height

PLASTIC SMALL OUTLINE - NO LEAD

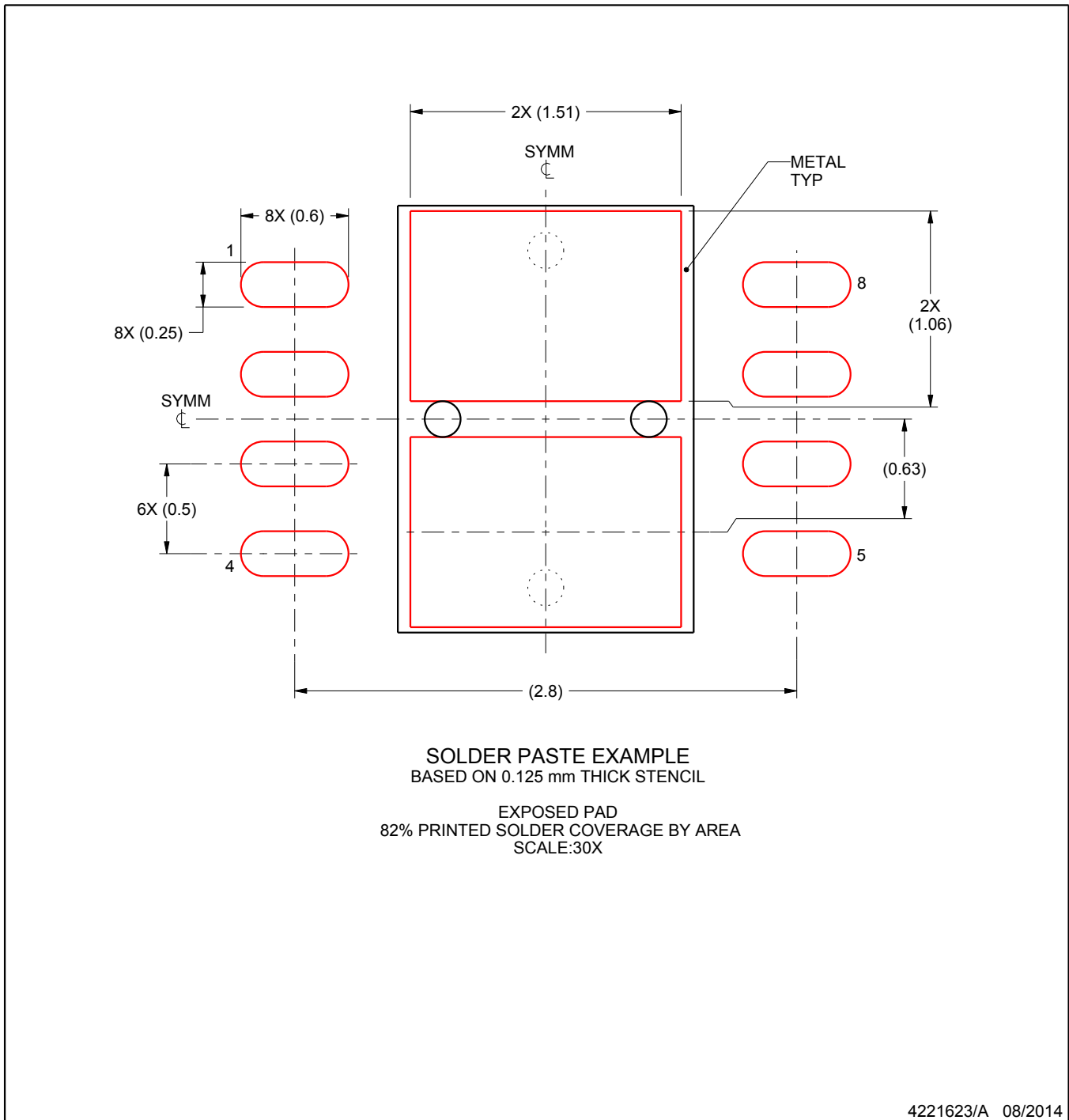

NOTES: (continued)

5. Laser cutting apertures with trapezoidal walls and rounded corners may offer better paste release. IPC-7525 may have alternate design recommendations.

# DGK0008A



# PACKAGE OUTLINE

VSSOP - 1.1 mm max height

SMALL OUTLINE PACKAGE



**NOTES:**

PowerPAD is a trademark of Texas Instruments.

1. All linear dimensions are in millimeters. Any dimensions in parenthesis are for reference only. Dimensioning and tolerancing per ASME Y14.5M.
2. This drawing is subject to change without notice.
3. This dimension does not include mold flash, protrusions, or gate burrs. Mold flash, protrusions, or gate burrs shall not exceed 0.15 mm per side.
4. This dimension does not include interlead flash. Interlead flash shall not exceed 0.25 mm per side.
5. Reference JEDEC registration MO-187.

# EXAMPLE BOARD LAYOUT

DGK0008A

™ VSSOP - 1.1 mm max height

SMALL OUTLINE PACKAGE

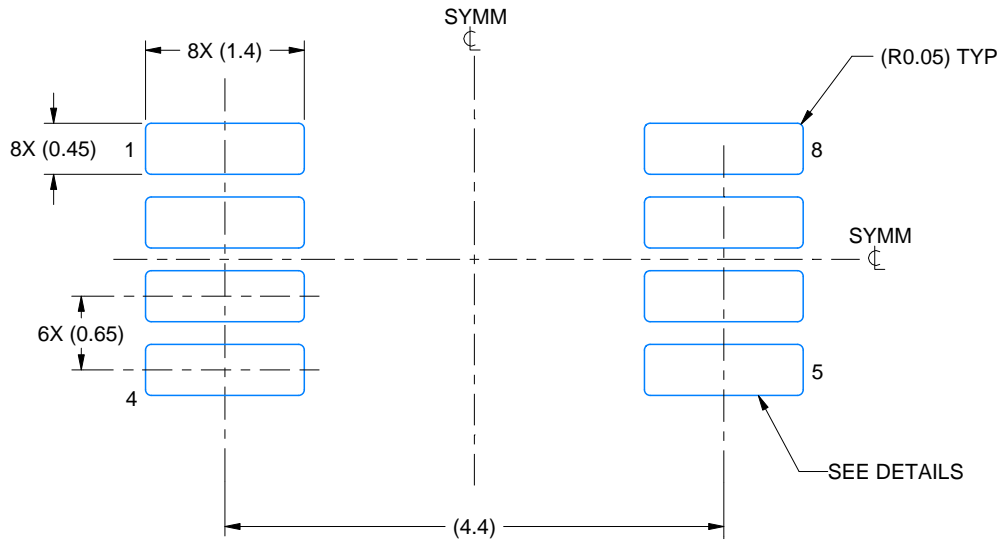

LAND PATTERN EXAMPLE  
EXPOSED METAL SHOWN  
SCALE: 15X

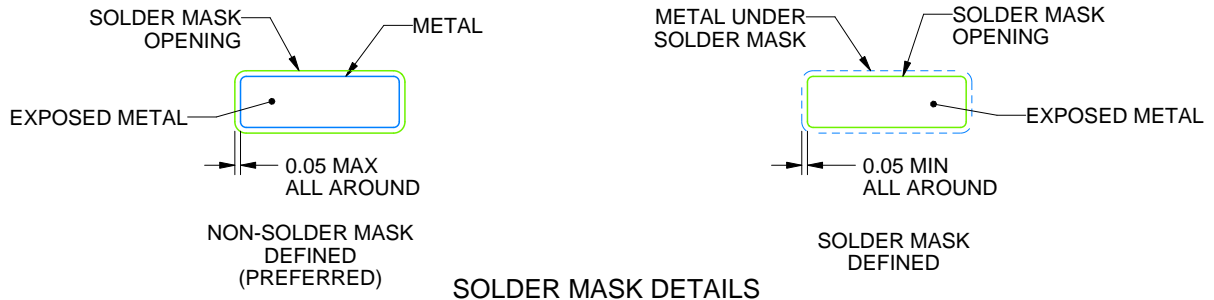

SOLDER MASK DETAILS

4214862/A 04/2023

NOTES: (continued)

6. Publication IPC-7351 may have alternate designs.
7. Solder mask tolerances between and around signal pads can vary based on board fabrication site.
8. Vias are optional depending on application, refer to device data sheet. If any vias are implemented, refer to their locations shown on this view. It is recommended that vias under paste be filled, plugged or tented.
9. Size of metal pad may vary due to creepage requirement.

# EXAMPLE STENCIL DESIGN

DGK0008A

<sup>TM</sup> VSSOP - 1.1 mm max height

SMALL OUTLINE PACKAGE



SOLDER PASTE EXAMPLE  
SCALE: 15X

4214862/A 04/2023

NOTES: (continued)

11. Laser cutting apertures with trapezoidal walls and rounded corners may offer better paste release. IPC-7525 may have alternate design recommendations.
12. Board assembly site may have different recommendations for stencil design.

## IMPORTANT NOTICE AND DISCLAIMER

TI PROVIDES TECHNICAL AND RELIABILITY DATA (INCLUDING DATA SHEETS), DESIGN RESOURCES (INCLUDING REFERENCE DESIGNS), APPLICATION OR OTHER DESIGN ADVICE, WEB TOOLS, SAFETY INFORMATION, AND OTHER RESOURCES "AS IS" AND WITH ALL FAULTS, AND DISCLAIMS ALL WARRANTIES, EXPRESS AND IMPLIED, INCLUDING WITHOUT LIMITATION ANY IMPLIED WARRANTIES OF MERCHANTABILITY, FITNESS FOR A PARTICULAR PURPOSE OR NON-INFRINGEMENT OF THIRD PARTY INTELLECTUAL PROPERTY RIGHTS.

These resources are intended for skilled developers designing with TI products. You are solely responsible for (1) selecting the appropriate TI products for your application, (2) designing, validating and testing your application, and (3) ensuring your application meets applicable standards, and any other safety, security, regulatory or other requirements.

These resources are subject to change without notice. TI grants you permission to use these resources only for development of an application that uses the TI products described in the resource. Other reproduction and display of these resources is prohibited. No license is granted to any other TI intellectual property right or to any third party intellectual property right. TI disclaims responsibility for, and you will fully indemnify TI and its representatives against, any claims, damages, costs, losses, and liabilities arising out of your use of these resources.

TI's products are provided subject to [TI's Terms of Sale](#) or other applicable terms available either on [ti.com](https://www.ti.com) or provided in conjunction with such TI products. TI's provision of these resources does not expand or otherwise alter TI's applicable warranties or warranty disclaimers for TI products.

TI objects to and rejects any additional or different terms you may have proposed.

Mailing Address: Texas Instruments, Post Office Box 655303, Dallas, Texas 75265  
Copyright © 2024, Texas Instruments Incorporated