

OPAx328 Precision, 40-MHz, 1.0-pA, Low-Noise, RRIO, CMOS Operational Amplifiers With Shutdown

1 Features

- Precision with zero-crossover distortion:
 - Low offset voltage: 50 μ V (maximum)
 - High CMRR: 120 dB
 - Rail-to-rail I/O
- Wide bandwidth: 40 MHz
- Low input bias current: 1 pA (maximum)
- Low noise: 6.1 nV/ $\sqrt{\text{Hz}}$ at 10 kHz
- Slew rate: 30 V/ μ s
- Fast 0.01% settling time: 180 ns
- Single-supply voltage range: 2.2 V to 5.5 V
- Unity-gain stable

2 Applications

- [Optical module](#)
- [Position sensor](#)
- [Multiparameter patient monitor](#)
- [CT and PET scanner](#)
- [Chemistry and gas analyzer](#)
- [Bidirectional 400-V and 800-V to LV](#)
- [Merchant network and server PSU](#)
- [String inverter](#)
- [Solar power optimizer](#)

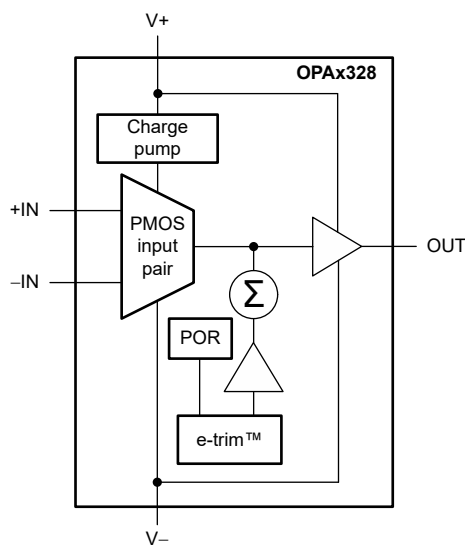

Block Diagram

3 Description

The single-channel OPA328 and dual-channel OPA2328 (OPAx328) are a new generation family of precision, low-voltage CMOS operational amplifiers optimized for very low noise and wide bandwidth.

The OPAx328 have a linear input stage with zero-crossover distortion that delivers excellent common-mode rejection ratio (CMRR) of 120 dB (typical) over the full input range. The input common-mode voltage range extends 100 mV beyond the negative and positive supply rails. The output voltage typically swings within 10 mV of the rails.

The OPAx328 also use Texas Instrument's proprietary e-trim™ operational amplifier technology, enabling a unique combination of ultra-low offset and low input offset drift without the need for any input switching or auto-zero techniques.

Low-noise (6.1 nV/ $\sqrt{\text{Hz}}$) and high-speed operation (40 MHz, 30 V/ μ s) make these devices a great choice for driving sampling analog-to-digital converters (ADCs).

The OPAx328 are also a great choice for high-impedance-input, single-supply applications. Low input bias current and low input capacitance allows for high-frequency transimpedance gains at low photocurrent operation (< 1 nA).

Device Information

PART NUMBER	CHANNELS / SHUTDOWN	PACKAGE ⁽¹⁾
OPA328	Single / No	DBV (SOT-23, 5)
OPA328S ⁽²⁾	Single / Yes	DBV (SOT-23, 6)
OPA2328	Dual / No	D (SOIC, 8)
		DGK (VSSOP, 8)
		DRG (WSON, 8)
OPA4328 ⁽²⁾	Quad / No	PW (TSSOP, 14)
	Quad / Yes	RUM (WQFN, 16)

(1) For more information, see [Section 10](#).

(2) Preview information (not Production Data).



Table of Contents

1 Features	1	7 Application and Implementation	17
2 Applications	1	7.1 Application Information.....	17
3 Description	1	7.2 Typical Applications.....	17
4 Pin Configuration and Functions	3	7.3 Power Supply Recommendations.....	21
5 Specifications	5	7.4 Layout.....	21
5.1 Absolute Maximum Ratings.....	5	8 Device and Documentation Support	22
5.2 ESD Ratings	5	8.1 Device Support.....	22
5.3 Recommended Operating Conditions.....	5	8.2 Documentation Support.....	23
5.4 Thermal Information - OPA328.....	6	8.3 Receiving Notification of Documentation Updates....	23
5.5 Thermal Information - OPA2328.....	6	8.4 Support Resources.....	23
5.6 Electrical Characteristics.....	7	8.5 Trademarks.....	23
5.7 Typical Characteristics.....	9	8.6 Electrostatic Discharge Caution.....	23
6 Detailed Description	15	8.7 Glossary.....	23
6.1 Overview.....	15	9 Revision History	23
6.2 Functional Block Diagram.....	15	10 Mechanical, Packaging, and Orderable Information	24
6.3 Feature Description.....	16		
6.4 Device Functional Modes.....	16		

4 Pin Configuration and Functions

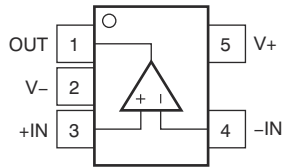

Figure 4-1. OPA328 DBV Package, 5-Pin SOT-23 (Top View)

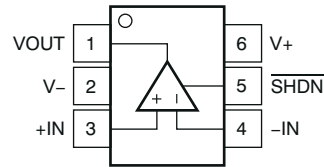

Figure 4-2. OPA328S DBV Package (Preview) 6-Pin SOT-23 (Top View)

Pin Functions: OPA328 and OPA328S

NAME	PIN		TYPE	DESCRIPTION
	OPA328	OPA328S		
-IN	4	4	Input	Negative (inverting) input
+IN	3	3	Input	Positive (noninverting) input
OUT, VOUT	1	1	Output	Output
SHDN	—	5	Input	Shutdown, active low
V-	2	2	Power	Negative (lowest) power supply
V+	5	6	Power	Positive (highest) power supply

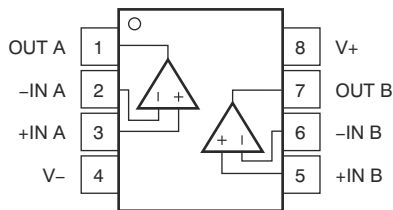

Figure 4-3. OPA2328 D Package, 8-pin SOIC and DGK Package, 8-Pin VSSOP (Top View)

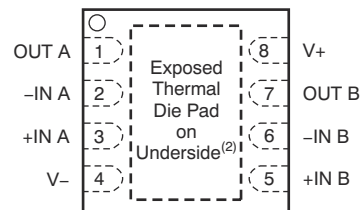

Figure 4-4. OPA2328 DRG Package, 8-Pin WSON (Top View)

Pin Functions: OPA2328

NAME	PIN		TYPE	DESCRIPTION
	NO.			
-IN A	2		Input	Inverting input, channel A
+IN A	3		Input	Noninverting input, channel A
-IN B	6		Input	Inverting input, channel B
+IN B	5		Input	Noninverting input, channel B
OUT A	1		Output	Output, channel A
OUT B	7		Output	Output, channel B
V-	4		Power	Negative (lowest) power supply
V+	8		Power	Positive (highest) power supply

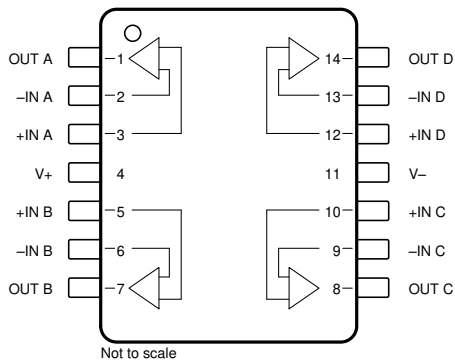

Figure 4-5. OPA4328 PW Package (Preview), 14-Pin TSSOP (Top View)

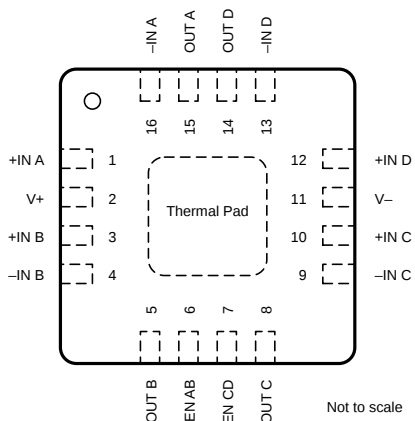

Figure 4-6. OPA4328 RUM Package (Preview), 16-Pin WQFN (Top View)

Table 4-1. Pin Functions: OPA4328

NAME	PIN		TYPE	DESCRIPTION
	NO.			
	PW (TSSOP)	RUM (WQFN)		
EN AB	—	6	Input	Enable pin for A and B amplifiers. High = amplifiers A and B are enabled.
EN CD	—	7	Input	Enable pin for C and D amplifiers. High = amplifiers C and D are enabled.
-IN A	2	16	Input	Inverting input, channel A
+IN A	3	1	Input	Noninverting input, channel A
-IN B	6	4	Input	Inverting input, channel B
+IN B	5	3	Input	Noninverting input, channel B
-IN C	9	9	Input	Inverting input, channel C
+IN C	10	10	Input	Noninverting input, channel C
-IN D	13	13	Input	Inverting input, channel D
+IN D	12	12	Input	Noninverting input, channel D
OUT A	1	15	Output	Output, channel A
OUT B	7	5	Output	Output, channel B
OUT C	8	8	Output	Output, channel C
OUT D	14	14	Output	Output, channel D
Thermal Pad	—	Thermal Pad	Power	Connect thermal pad to V-
V-	11	11	Power	Negative (lowest) power supply
V+	4	2	Power	Positive (highest) power supply

5 Specifications

5.1 Absolute Maximum Ratings

over operating free-air temperature range (unless otherwise noted) ⁽¹⁾

		MIN	MAX	UNIT
V _S	Supply voltage, V _S = (V+) – (V–)	–0.3	6	V
	Input voltage, all pins	(V–) – 0.3	(V+) + 0.3	V
	Input current (INA+, INA–, INB+, INB–, INSA/B, OUTSA/B/1/2/3)	–10	10	mA
	Output short-circuit ⁽²⁾	Continuous	Continuous	
T _A	Operating temperature	–55	150	°C
T _J	Junction temperature	–55	150	°C
T _{stg}	Storage temperature	–65	150	°C

- (1) Operation outside the Absolute Maximum Ratings may cause permanent device damage. Absolute Maximum Ratings do not imply functional operation of the device at these or any other conditions beyond those listed under Recommended Operating Conditions. If used outside the Recommended Operating Conditions but within the Absolute Maximum Ratings, the device may not be fully functional, and this may affect device reliability, functionality, performance, and shorten the device lifetime.
- (2) Short-circuit to ground, one amplifier per package.

5.2 ESD Ratings

			VALUE	UNIT
V _(ESD)	Electrostatic discharge	Human-body model (HBM), per ANSI/ESDA/JEDEC JS-001 ⁽¹⁾	2000	V
		Charged-device model (CDM), per ANSI/ESDA/JEDEC JS-002 ⁽²⁾	500	

- (1) JEDEC document JEP155 states that 500-V HBM allows safe manufacturing with a standard ESD control process.
- (2) JEDEC document JEP157 states that 250-V CDM allows safe manufacturing with a standard ESD control process.

5.3 Recommended Operating Conditions

over operating free-air temperature range (unless otherwise noted)

			MIN	NOM	MAX	UNIT
V _S	Supply voltage	Single-supply	2.2		5.5	V
		Dual-supply	±1.1		±2.75	V
T _A	Specified temperature		–40		125	°C

5.4 Thermal Information - OPA328

THERMAL METRIC ⁽¹⁾		OPA328	
		DBV (SOT-23)	
		5 PINS	
			UNIT
$R_{\theta JA}$	Junction-to-ambient thermal resistance	163.2	°C/W
$R_{\theta JC(top)}$	Junction-to-case (top) thermal resistance	97.6	°C/W
$R_{\theta JB}$	Junction-to-board thermal resistance	62.8	°C/W
Ψ_{JT}	Junction-to-top characterization parameter	40.7	°C/W
Ψ_{JB}	Junction-to-board characterization parameter	62.5	°C/W
$R_{\theta JC(bot)}$	Junction-to-case (bottom) thermal resistance	N/A	°C/W

(1) For more information about traditional and new thermal metrics, see the [Semiconductor and IC Package Thermal Metrics](#) application report.

5.5 Thermal Information - OPA2328

THERMAL METRIC ⁽¹⁾		OPA2328			UNIT
		D (SOIC)	DGK (VSSOP)	DRG (WSON)	
		8 PINS	8 PINS	8 PINS	
$R_{\theta JA}$	Junction-to-ambient thermal resistance	123.9	165	50.3	°C/W
$R_{\theta JC(top)}$	Junction-to-case (top) thermal resistance	63.1	53	50.2	°C/W
$R_{\theta JB}$	Junction-to-board thermal resistance	67.4	87	23.4	°C/W
Ψ_{JT}	Junction-to-top characterization parameter	15.7	4.9	0.8	°C/W
Ψ_{JB}	Junction-to-board characterization parameter	66.6	85	23.4	°C/W
$R_{\theta JC(bot)}$	Junction-to-case (bottom) thermal resistance	N/A	N/A	7.3	°C/W

(1) For more information about traditional and new thermal metrics, see the [Semiconductor and IC Package Thermal Metrics](#) application report.

5.6 Electrical Characteristics

at $T_A = 25^\circ\text{C}$, $V_S = \pm 1.1\text{ V}$ to $\pm 2.75\text{ V}$ ($V_S = 2.2\text{ V}$ to 5.5 V), $R_L = 10\text{ k}\Omega$ connected to $V_S / 2$, $V_{CM} = V_{OUT} = V_S / 2$, and min and max specification established from manufacturing final test (unless otherwise noted)

PARAMETER		TEST CONDITIONS		MIN	TYP	MAX	UNIT
OFFSET VOLTAGE							
V_{OS}	Input offset voltage	OPA2328D, DGK, and DRG			± 3	± 50	μV
		OPA328DBV			± 3	± 75	
dV_{OS}/dT	Input offset voltage drift	$T_A = -40^\circ\text{C}$ to $+125^\circ\text{C}$	OPA328DBV, OPA2328D, DGK		± 0.15	± 1	$\mu\text{V}/^\circ\text{C}$
			OPA2328DRG		± 0.15	± 1.5	
PSRR	Power-supply rejection ratio	$V_S = \pm 1.1\text{ V}$ to $\pm 2.75\text{ V}$			± 1	± 10	$\mu\text{V}/\text{V}$
		$V_S = \pm 1.1\text{ V}$ to $\pm 2.75\text{ V}$, $T_A = -40^\circ\text{C}$ to $+125^\circ\text{C}$			± 15	± 40	
	Channel separation (dual, quad)	$f = \text{dc}$			140		dB
		$f = 100\text{ kHz}$			75		
INPUT BIAS CURRENT							
I_B	Input bias current				± 0.2	± 1	pA
		$T_A = 0^\circ\text{C}$ to 85°C				10	
		$T_A = -40^\circ\text{C}$ to $+125^\circ\text{C}$				100	
I_{OS}	Input offset current				± 0.2	± 1	pA
		$T_A = 0^\circ\text{C}$ to 85°C				10	
		$T_A = -40^\circ\text{C}$ to $+125^\circ\text{C}$				100	
NOISE							
	Input voltage noise	$f = 0.1\text{ Hz}$ to 10 Hz			3		μV_{PP}
e_N	Input voltage noise density	$f = 100\text{ Hz}$			25		$\text{nV}/\sqrt{\text{Hz}}$
		$f = 1\text{ kHz}$			9.8		
		$f = 10\text{ kHz}$			6.1		
i_N	Input current noise	$f = 10\text{ kHz}$			0.125		$\text{pA}/\sqrt{\text{Hz}}$
INPUT VOLTAGE							
V_{CM}	Common-mode voltage			$(V-) - 0.1$		$(V+) + 0.1$	V
CMRR	Common-mode rejection ratio	$(V-) - 0.1\text{ V} < V_{CM} < (V+) + 0.1\text{ V}$			106	120	dB
		$T_A = -40^\circ\text{C}$ to $+125^\circ\text{C}$			96	110	
INPUT CAPACITANCE							
Z_{ID}	Differential				1 4		$\text{T}\Omega$ pF
Z_{ICM}	Common-mode				1 2		$\text{T}\Omega$ pF
OPEN-LOOP GAIN							
A_{OL}	Open-loop voltage gain	$(V-) + 100\text{ mV} < V_O < (V+) - 100\text{ mV}$	$T_A = -40^\circ\text{C}$ to $+125^\circ\text{C}$		108	132	dB
			$T_A = -40^\circ\text{C}$ to $+125^\circ\text{C}$		96	130	
		$(V-) + 200\text{ mV} < V_O < (V+) - 200\text{ mV}$, $R_L = 2\text{ k}\Omega$	$T_A = -40^\circ\text{C}$ to $+125^\circ\text{C}$		106	123	
			$T_A = -40^\circ\text{C}$ to $+125^\circ\text{C}$		90		
FREQUENCY RESPONSE							
GBW	Gain-bandwidth product	Gain = 100			40		MHz
SR	Slew rate	4-V step, gain = +1			30		V/ μs
t_s	Settling time	To 0.1%, 1-V step, gain = +1			0.1		μs
		To 0.01%, 1-V step, gain = +1			0.18		
	Overload recovery time	$V_{IN} \times \text{gain} > V_S$			0.5		μs
THD+N	Total harmonic distortion + noise	$V_O = 1\text{ V}_{RMS}$, gain = +1, $f = 1\text{ kHz}$			0.0001		%

5.6 Electrical Characteristics (continued)

at $T_A = 25^\circ\text{C}$, $V_S = \pm 1.1\text{ V}$ to $\pm 2.75\text{ V}$ ($V_S = 2.2\text{ V}$ to 5.5 V), $R_L = 10\text{ k}\Omega$ connected to $V_S / 2$, $V_{CM} = V_{OUT} = V_S / 2$, and min and max specification established from manufacturing final test (unless otherwise noted)

PARAMETER	TEST CONDITIONS	MIN	TYP	MAX	UNIT	
OUTPUT						
Voltage output swing from both rails	$V_S = 2.2\text{ V}$			5	mV	
		$R_L = 2\text{ k}\Omega$		15		
	$V_S = 5.5\text{ V}$	OPA328DBV, OPA2328D, DGK				5
		OPA2328DRG				10
		$R_L = 2\text{ k}\Omega$, OPA328DBV, OPA2328D, DGK				15
		$R_L = 2\text{ k}\Omega$, OPA2328DRG				20
I_{SC}	Short-circuit current	Sinking, $V_S = 5.5\text{ V}$		-65	mA	
		Sourcing, $V_S = 5.5\text{ V}$		55		
C_{LOAD}	Capacitive load drive	Gain = +1		28	pF	
R_O	Open-loop output impedance	f = 10 kHz		55	Ω	
POWER SUPPLY						
I_Q	Quiescent current per amplifier	$I_O = 0\text{ A}$		3.8	4.5	mA
		$I_O = 0\text{ A}$, $T_A = -40^\circ\text{C}$ to $+125^\circ\text{C}$			5.0	
SHUTDOWN (OPA328SDBV and OPA4328RUM)						
I_{QSD}	Quiescent current in shutdown	All amplifiers disabled		30	50	μA
Z_{OFF}	Output impedance in shutdown	All amplifiers disabled		100 16		$\text{G}\Omega$ pF
V_{IH}	High-level input voltage	Amplifier enabled		(V+) - 0.5		V
V_{IL}	Low-level input voltage	Amplifier disabled			(V-) + 0.5	V
t_{ON}	Output enable time	G = 1, $V_{OUT} = 0.9 \times V_S/2$, all amplifiers enabled		10		μs
t_{OFF}	Output disable time	G = 1, $V_{OUT} = 0.1 \times V_S/2$, all amplifiers disabled		3		μs
	EN pin input leakage current	$V_{IH} = V_+$		0.02		μA
		$V_{IL} = V_-$		1		

5.7 Typical Characteristics

at $T_A = 25^\circ\text{C}$, $V_S = 5.5\text{ V}$, $V_{CM} = V_{OUT} = \text{mid-supply}$, $C_L = 20\text{ pF}$, and $R_L = 10\text{ k}\Omega$ (unless otherwise noted)

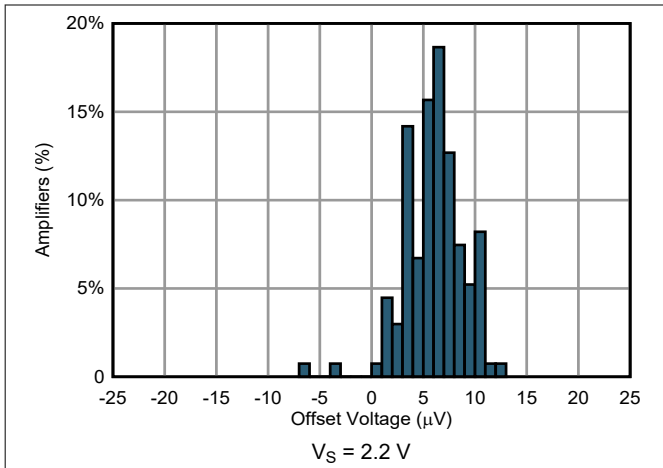

Figure 5-1. Offset Voltage Production Distribution

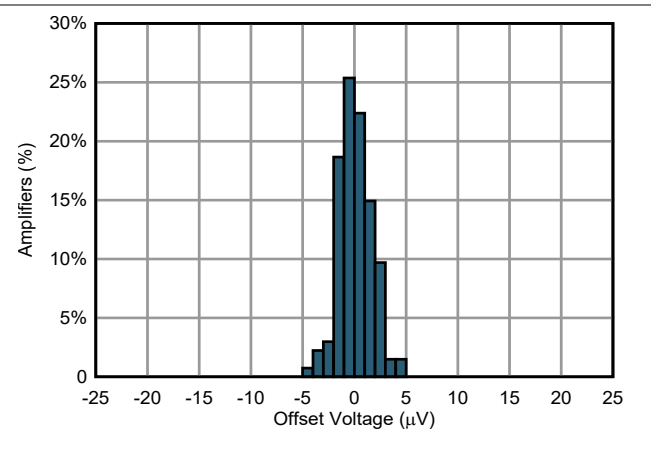

Figure 5-2. Offset Voltage Production Distribution

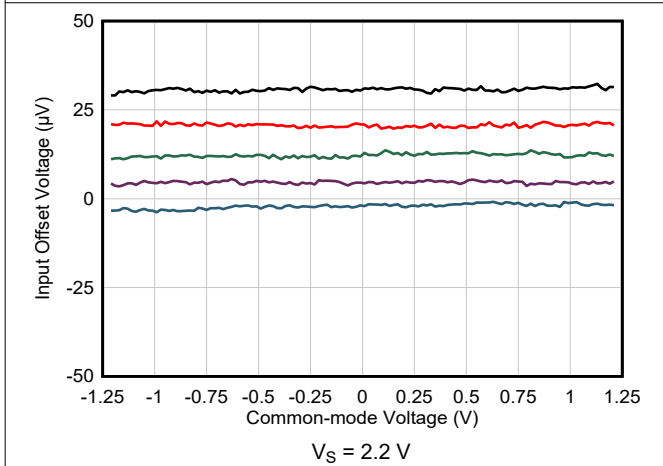

Figure 5-3. Offset Voltage vs Common-Mode Voltage

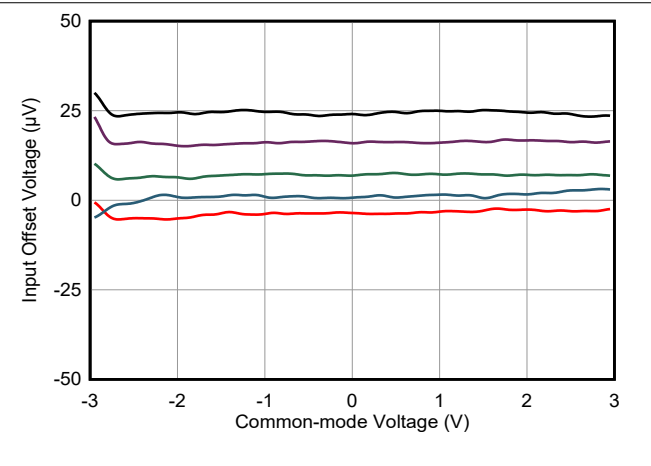

Figure 5-4. Offset Voltage vs Common-Mode Voltage

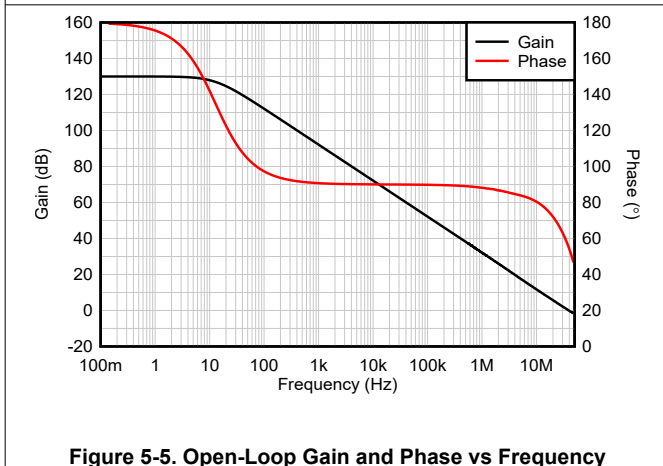

Figure 5-5. Open-Loop Gain and Phase vs Frequency

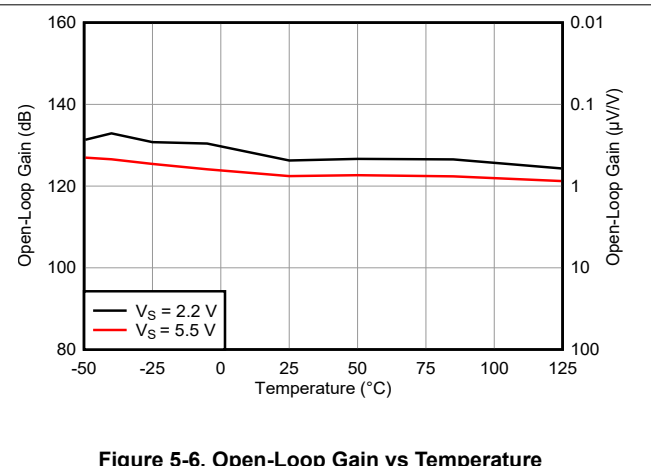

Figure 5-6. Open-Loop Gain vs Temperature

5.7 Typical Characteristics (continued)

at $T_A = 25^\circ\text{C}$, $V_S = 5.5\text{ V}$, $V_{CM} = V_{OUT} = \text{mid-supply}$, $C_L = 20\text{ pF}$, and $R_L = 10\text{ k}\Omega$ (unless otherwise noted)

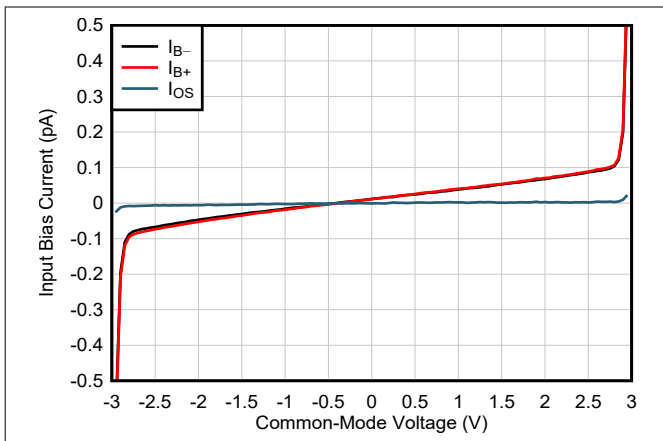

Figure 5-7. Input Bias Current vs Common-Mode Voltage

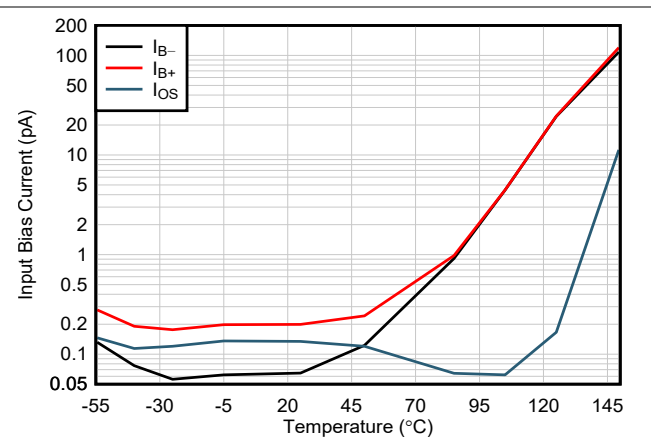

Figure 5-8. Input Bias Current vs Temperature

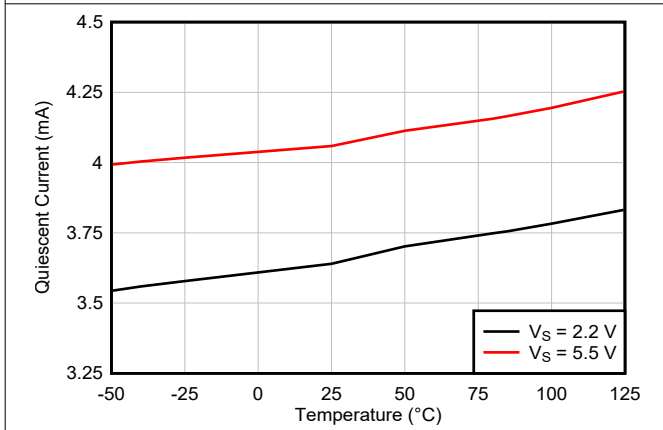

Figure 5-9. Quiescent Current vs Supply Voltage

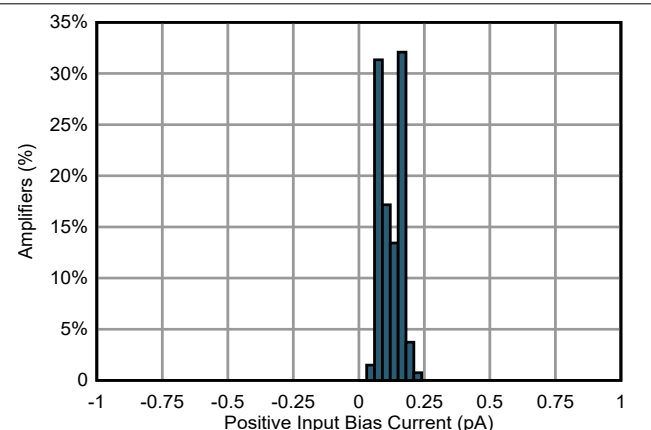

Figure 5-10. Positive Input Bias Current Distribution

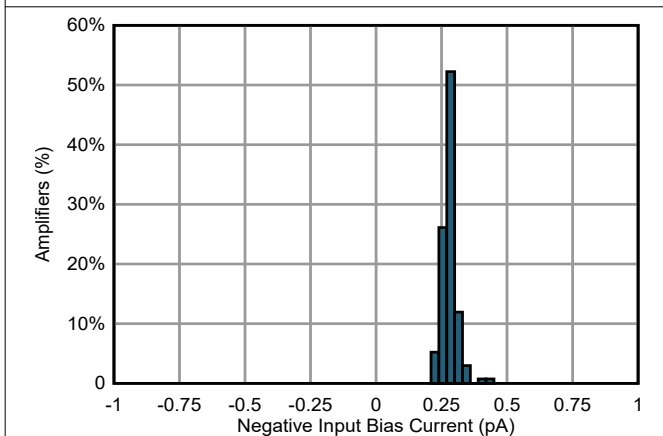

Figure 5-11. Negative Input Bias Current Distribution

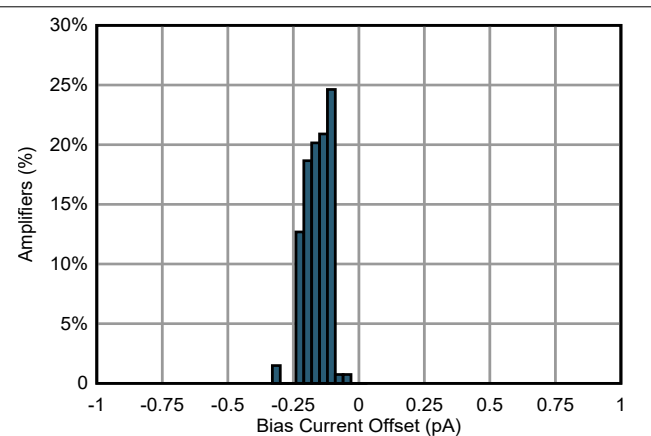
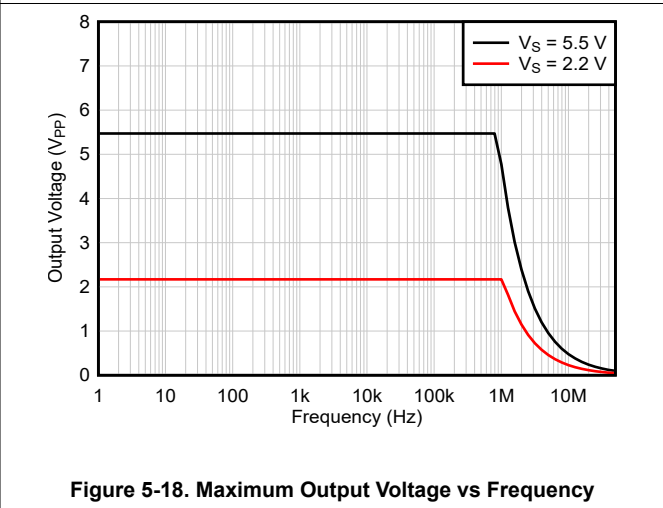
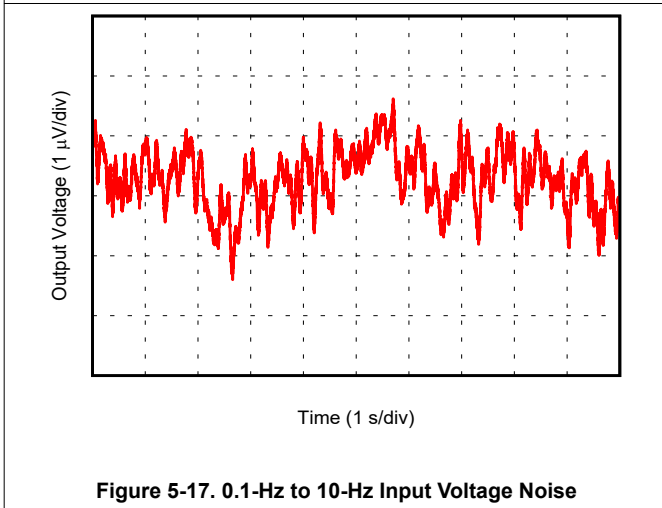
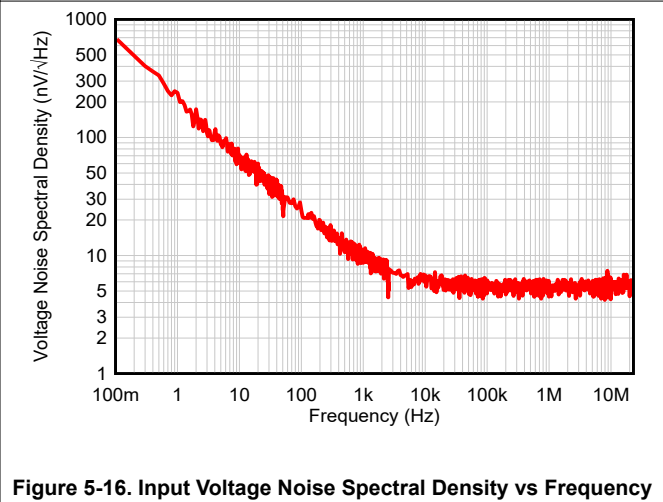
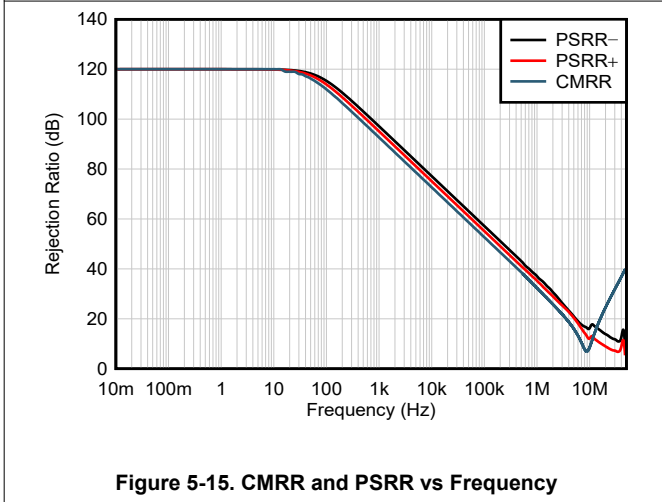
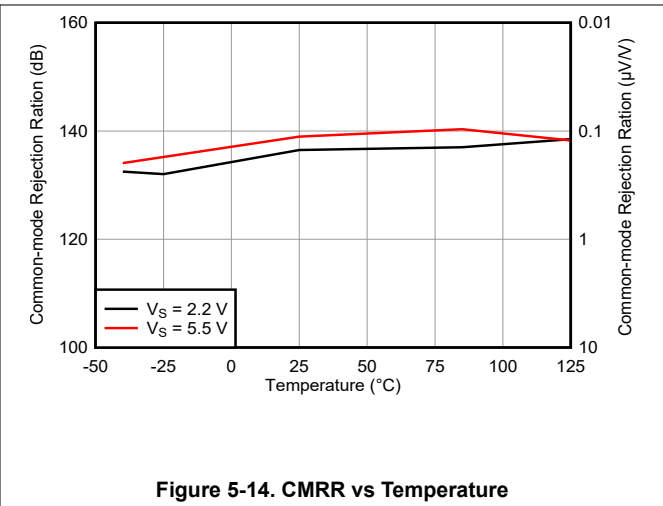
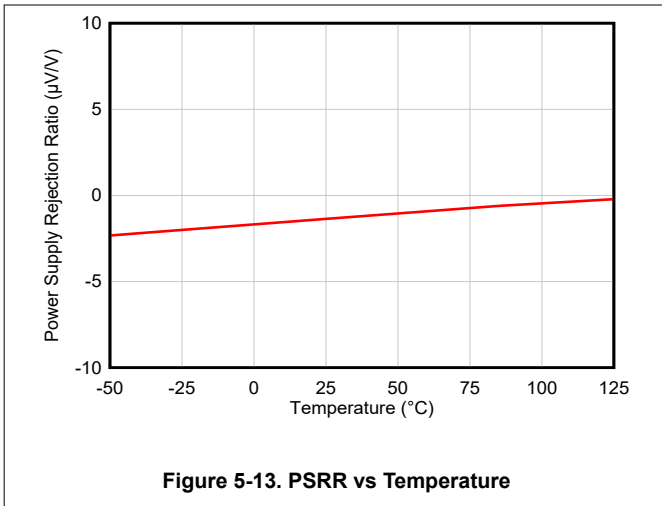

Figure 5-12. Input Bias Offset Current Distribution

5.7 Typical Characteristics (continued)

at $T_A = 25^\circ\text{C}$, $V_S = 5.5\text{ V}$, $V_{CM} = V_{OUT} = \text{mid-supply}$, $C_L = 20\text{ pF}$, and $R_L = 10\text{ k}\Omega$ (unless otherwise noted)



5.7 Typical Characteristics (continued)

at $T_A = 25^\circ\text{C}$, $V_S = 5.5\text{ V}$, $V_{CM} = V_{OUT} = \text{mid-supply}$, $C_L = 20\text{ pF}$, and $R_L = 10\text{ k}\Omega$ (unless otherwise noted)

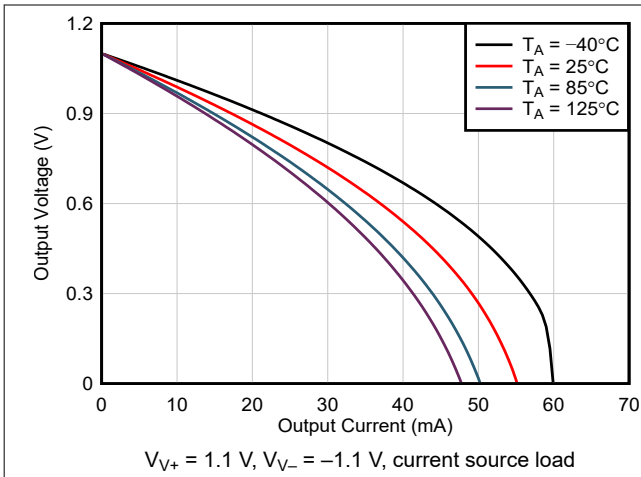

Figure 5-19. Output Voltage Swing vs Output Current

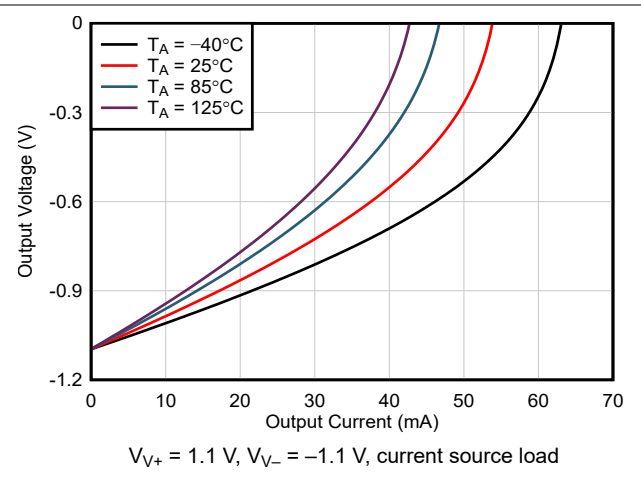

Figure 5-20. Output Voltage Swing vs Output Current

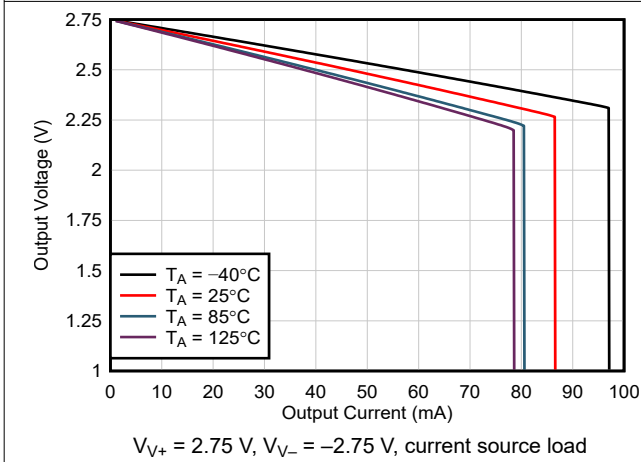

Figure 5-21. Output Voltage Swing vs Output Current

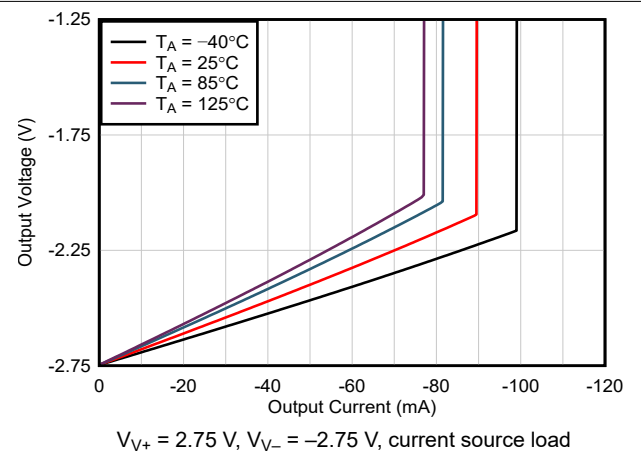

Figure 5-22. Output Voltage Swing vs Output Current

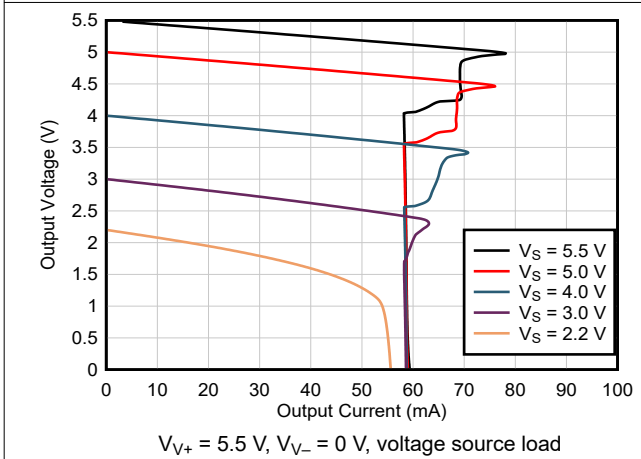

Figure 5-23. Output Voltage Swing vs Output Current

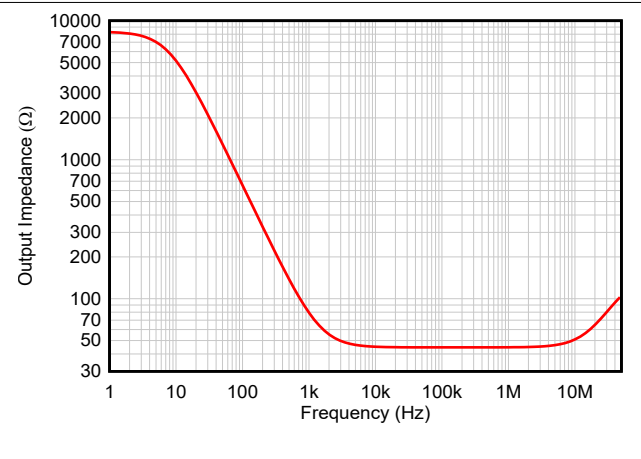

Figure 5-24. Open-Loop Output Impedance vs Frequency

5.7 Typical Characteristics (continued)

at $T_A = 25^\circ\text{C}$, $V_S = 5.5\text{ V}$, $V_{CM} = V_{OUT} = \text{mid-supply}$, $C_L = 20\text{ pF}$, and $R_L = 10\text{ k}\Omega$ (unless otherwise noted)

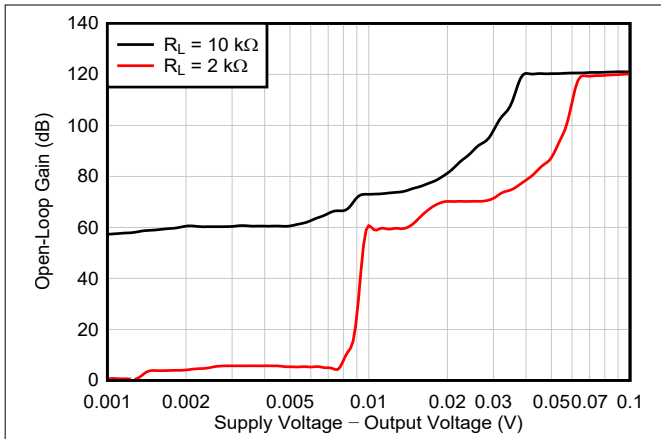

Figure 5-25. Open-Loop Gain vs Output to Supply Voltage Delta

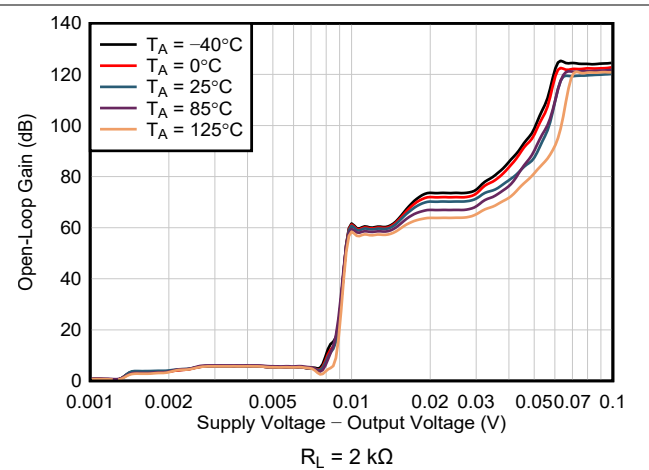

Figure 5-26. Open-Loop Gain vs Output to Supply Voltage Delta

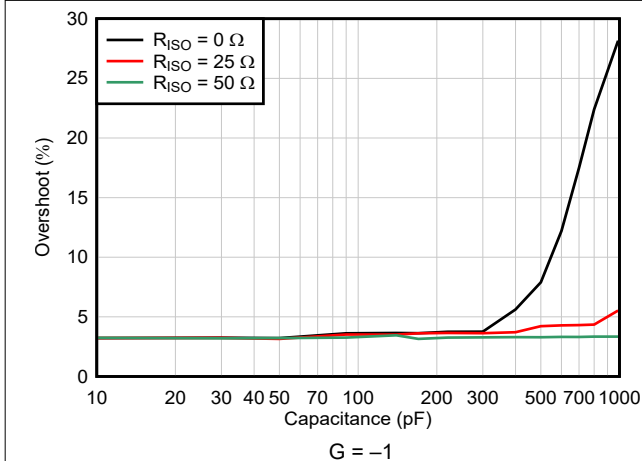

Figure 5-27. Small-Signal Overshoot vs Load Capacitance

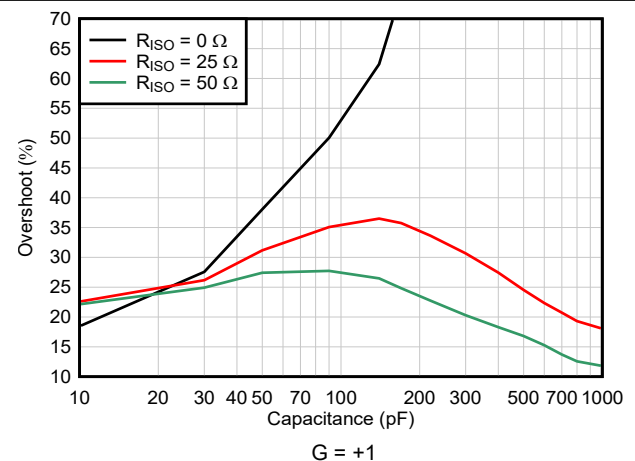

Figure 5-28. Small-Signal Overshoot vs Load Capacitance

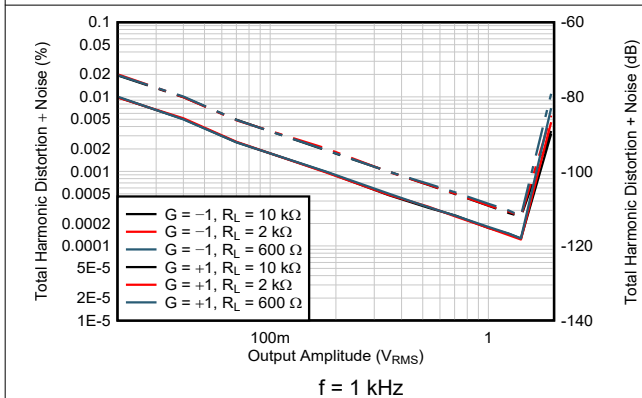

Figure 5-29. THD+N vs Amplitude

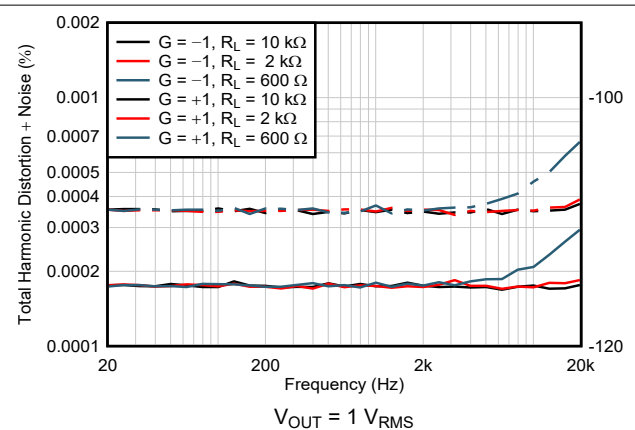

Figure 5-30. THD+N vs Frequency

5.7 Typical Characteristics (continued)

at $T_A = 25^\circ\text{C}$, $V_S = 5.5\text{ V}$, $V_{CM} = V_{OUT} = \text{mid-supply}$, $C_L = 20\text{ pF}$, and $R_L = 10\text{ k}\Omega$ (unless otherwise noted)

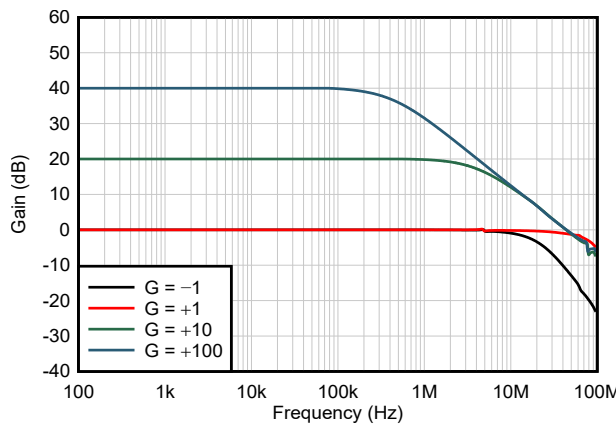

Figure 5-31. Closed-Loop Gain vs Frequency

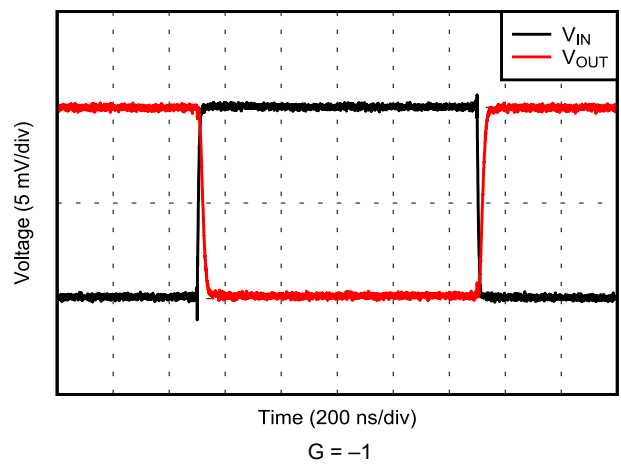

Figure 5-32. Small-Signal Step Response

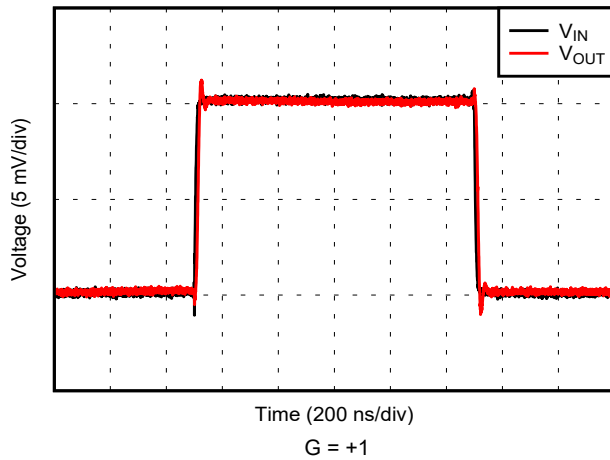

Figure 5-33. Small-Signal Step Response

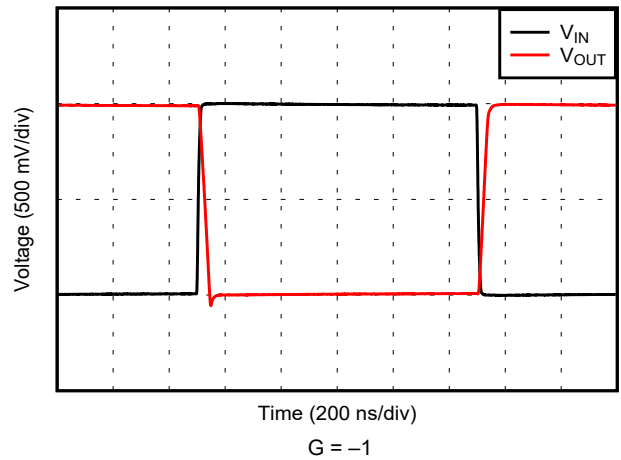

Figure 5-34. Large-Signal Step Response

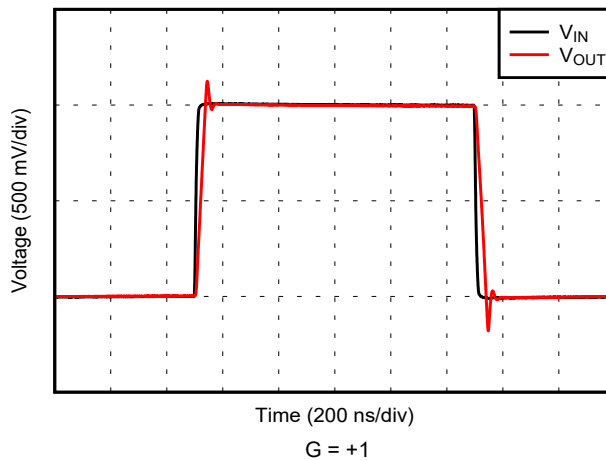

Figure 5-35. Large-Signal Step Response

6 Detailed Description

6.1 Overview

The OPAx328 family features high-speed, precision amplifiers that make this op amp family an excellent choice for driving high-resolution analog-to-digital converters (ADCs). Low output impedance with flat frequency characteristics and zero-crossover distortion circuitry enable high linearity over the full input common-mode range, achieving true rail-to-rail input from a 2.2-V to 5.5-V single supply.

6.2 Functional Block Diagram

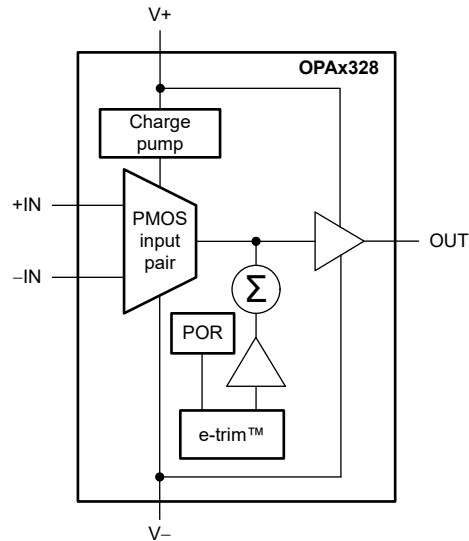

6.3 Feature Description

6.3.1 Input and ESD Protection

The OPAx328 incorporate internal electrostatic discharge (ESD) protection circuits on all pins. In the case of input and output pins, this protection primarily consists of current-steering diodes connected between the input and power-supply pins. These ESD protection diodes also provide in-circuit input overdrive protection if the current is limited to 10 mA. Many input signals are inherently current-limited to less than 10 mA; therefore, a limiting resistor is not required. Figure 6-1 shows how a series input resistor (R_{IN}) can be added to the driven input to limit the input current. The added resistor contributes thermal noise at the amplifier input; therefore, keep this value to a minimum in noise-sensitive applications.

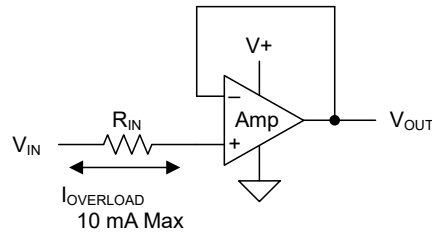

Figure 6-1. Input Current Protection

6.3.2 Rail-to-Rail Input

The OPAx328 feature true rail-to-rail input operation, with supply voltages as low as ± 1.1 V (2.2 V). The design of the OPAx328 amplifiers includes an internal charge-pump that powers the amplifier input stage with an internal supply rail at approximately 1.6 V greater than the external supply (V_{S+}). This internal supply rail allows the single differential input pair to operate and remain very linear over a very-wide input common-mode range. A unique zero-crossover input topology eliminates the input offset transition region typical of many rail-to-rail, complementary-input-stage operational amplifiers. This topology allows the OPAx328 to provide excellent common-mode performance (CMRR > 120 dB, typical) over the entire common-mode input range, which extends 100 mV beyond both power-supply rails. When driving analog-to-digital converters (ADCs), the highly linear V_{CM} range of the OPAx328 provides maximum linearity and lowest distortion.

6.3.3 Phase Reversal

The OPAx328 op amps are designed to be immune to phase reversal when the input pins exceed the supply voltages, and thus provide further in-system stability and predictability. Figure 6-2 shows the input voltage exceeding the supply voltage without any phase reversal.

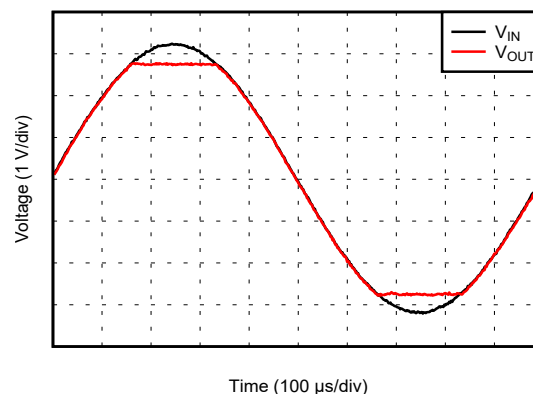

Figure 6-2. No Phase Reversal

6.4 Device Functional Modes

The OPAx328 operational amplifier is operational when power-supply voltages between 2.2 V to 5.5 V are applied. Devices with an S suffix have shutdown capability.

7 Application and Implementation

Note

Information in the following applications sections is not part of the TI component specification, and TI does not warrant its accuracy or completeness. TI's customers are responsible for determining suitability of components for their purposes, as well as validating and testing their design implementation to confirm system functionality.

7.1 Application Information

The OPAx328 offer outstanding dc and ac performance. These devices operate with up to a 5.5-V power supply, and offer an ultra-low input bias current and a 40-MHz bandwidth. These features make the OPAx328 family of robust operational amplifiers great for both communication and industrial applications.

7.1.1 Capacitive Load and Stability

The OPAx328 are designed for use in high-speed applications for transimpedance amplifiers (TIA) and ADC input-driving amplifiers. As with all op amps, there can be specific instances where the OPAx328 become unstable. The particular op-amp circuit configuration, layout, gain, and output loading are some of the factors to consider when establishing whether an amplifier is stable in operation. An op amp in the unity-gain (1-V/V) buffer configuration driving a capacitive load exhibits a greater tendency to become unstable compared to an amplifier operating at a higher noise gain (see [Figure 5-28](#)). The capacitive load, in conjunction with the op-amp output impedance, creates a pole within the loop gain that degrades the phase margin. The degradation of the phase margin increases as the capacitive loading increases. When operating in the unity-gain configuration, the OPAx328 remain stable with a pure capacitive load up to 100 pF.

[Figure 7-1](#) shows one technique to increase the capacitive load drive capability of an amplifier operating in a unity-gain configuration is to insert a small resistor (R_S), typically 10 Ω to 50 Ω , in series with the output. This resistor significantly reduces the overshoot and ringing associated with large capacitive loads.

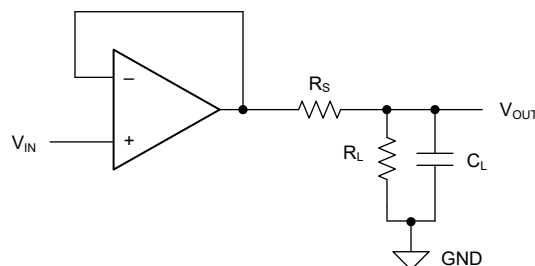

Figure 7-1. Improving Capacitive Load Drive

7.2 Typical Applications

7.2.1 Bidirectional Current-Sensing

This single-supply, low-side, bidirectional current-sensing design example detects load currents from -1 A to $+1$ A. The single-ended output spans from 110 mV to 3.19 V. This design uses the OPAx328 because of the low offset voltage and rail-to-rail input and output. One of the amplifiers is configured as a difference amplifier and the other amplifier provides the reference voltage.

[Figure 7-2](#) shows the schematic.

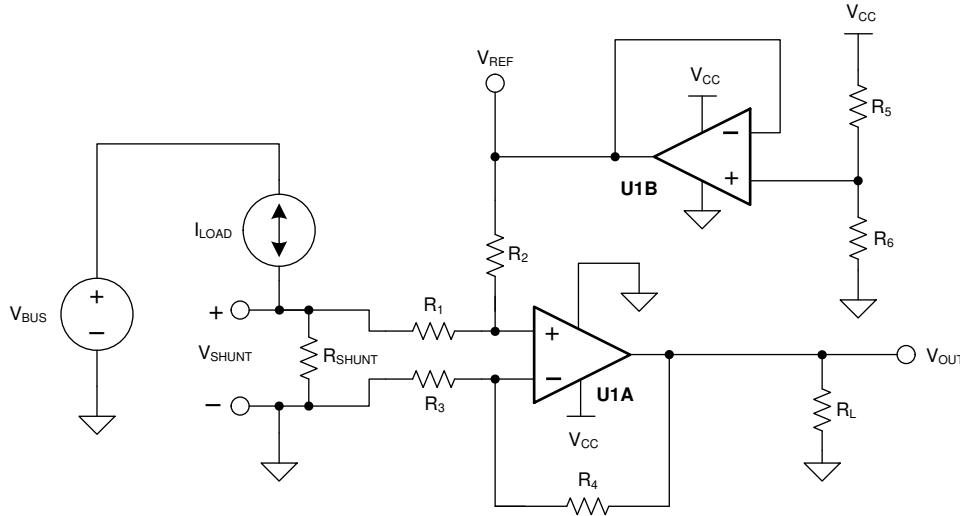

Figure 7-2. Bidirectional Current-Sensing Schematic

7.2.1.1 Design Requirements

This design example has the following requirements:

- Supply voltage: 3.3 V
- Input: –1 A to +1 A
- Output: 1.65 V ±1.54 V (110 mV to 3.19 V)

7.2.1.2 Detailed Design Procedure

The load current, I_{LOAD} , flows through the shunt resistor, R_{SHUNT} , to develop the shunt voltage, V_{SHUNT} . The shunt voltage is then amplified by the difference amplifier consisting of U1A and R_1 through R_4 . The gain of the difference amplifier is set by the ratio of R_4 to R_3 . To minimize errors, set $R_2 = R_4$ and $R_1 = R_3$. The reference voltage, V_{REF} , is supplied by buffering a resistor divider using U1B. The transfer function is given by Equation 1.

$$V_{OUT} = V_{SHUNT} \times \text{Gain}_{\text{Diff_Amp}} + V_{REF} \quad (1)$$

where

- $V_{SHUNT} = I_{LOAD} \times R_{SHUNT}$
- $\text{Gain}_{\text{Diff_Amp}} = \frac{R_4}{R_3}$
- $V_{REF} = V_{CC} \times \left(\frac{R_6}{R_5 + R_6} \right)$

There are two types of errors in this design: offset and gain. Gain errors are introduced by the tolerance of the shunt resistor and the ratios of R_4 to R_3 and, similarly, R_2 to R_1 . Offset errors are introduced by the voltage divider (R_5 and R_6) and how closely the ratio of R_4 / R_3 matches R_2 / R_1 . The latter value affects the CMRR of the difference amplifier, ultimately translating to an offset error.

The value of V_{SHUNT} is the ground potential for the system load because V_{SHUNT} is a low-side measurement. Therefore, a maximum value must be placed on V_{SHUNT} . In this design, the maximum value for V_{SHUNT} is set to 100 mV. Equation 2 calculates the maximum value of the shunt resistor given a maximum shunt voltage of 100 mV and maximum load current of 1 A.

$$R_{SHUNT(\text{Max})} = \frac{V_{SHUNT(\text{Max})}}{I_{LOAD(\text{Max})}} = \frac{100 \text{ mV}}{1 \text{ A}} = 100 \text{ m}\Omega \quad (2)$$

The tolerance of R_{SHUNT} is directly proportional to cost. For this design, a shunt resistor with a tolerance of 0.5% is selected. If greater accuracy is required, select a 0.1% resistor or better.

The load current is bidirectional; therefore, the shunt voltage range is -100 mV to $+100\text{ mV}$. This voltage is divided down by R_1 and R_2 before reaching the operational amplifier, U1A. Make sure that the voltage present at the noninverting node of U1A is within the common-mode range of the device. Therefore, use an operational amplifier, such as the OPAx328, that has a common-mode range that extends below the negative supply voltage. Finally, to minimize offset error, the OPAx328 have a typical offset voltage of merely $\pm 3\text{ }\mu\text{V}$ ($\pm 25\text{ }\mu\text{V}$ maximum).

Given a symmetric load current of -1 A to $+1\text{ A}$, the voltage divider resistors (R_5 and R_6) must be equal. To be consistent with the shunt resistor, a tolerance of 0.5% is selected. To minimize power consumption, 10-k Ω resistors are used.

To set the gain of the difference amplifier, the common-mode range and output swing of the OPAx328 must be considered. Equation 3 and Equation 4 depict the typical common-mode range and maximum output swing, respectively, of the OPAx328 given a 3.3-V supply.

$$-100\text{ mV} < V_{CM} < 3.4\text{ V} \quad (3)$$

$$100\text{ mV} < V_{OUT} < 3.2\text{ V} \quad (4)$$

The gain of the difference amplifier can now be calculated as shown in Equation 5:

$$\text{Gain}_{\text{Diff_Amp}} = \frac{V_{OUT_Max} - V_{OUT_Min}}{R_{SHUNT} \times (I_{MAX} - I_{MIN})} = \frac{3.2\text{ V} - 100\text{ mV}}{100\text{ m}\Omega \times [1\text{ A} - (-1\text{ A})]} = 15.5 \frac{\text{V}}{\text{V}} \quad (5)$$

The resistor value selected for R_1 and R_3 is 1 k Ω . A value of 15.4 k Ω is selected for R_2 and R_4 because this number is the nearest standard value. Therefore, the calculated gain of the difference amplifier is 15.4 V/V.

The gain error of the circuit primarily depends on R_1 through R_4 . As a result of this dependence, 0.1% resistors are selected. This configuration reduces the likelihood that the design requires a two-point calibration. A simple one-point calibration, if desired, removes the offset errors introduced by the 0.5% resistors.

7.2.1.3 Application Curve

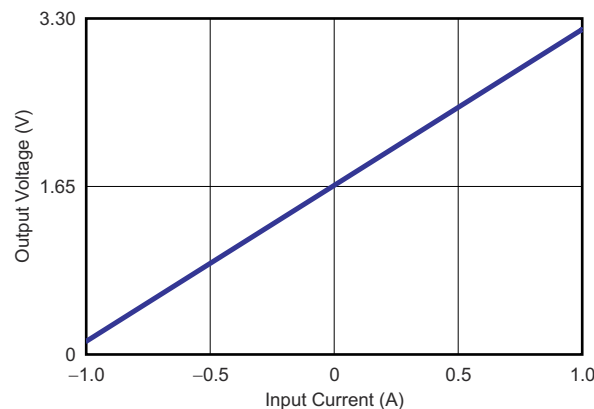

Figure 7-3. Bidirectional Current-Sensing Circuit Performance: Output Voltage vs Input Current

7.2.2 Transimpedance Amplifier

Wide gain bandwidth, low input bias current, low input voltage, and low current noise make the OPAx328 excellent wideband photodiode transimpedance amplifiers. Low-voltage noise is important because photodiode capacitance causes the effective noise gain of the circuit to increase at high frequency.

Figure 7-4 shows that the key elements to a transimpedance design are the:

- Expected diode capacitance (C_D), including the parasitic input common-mode voltage and differential-mode input capacitance
- Desired transimpedance gain (R_F)
- Gain-bandwidth (GBW) = 40 MHz

With these three variables set, the feedback capacitor (C_F) value can be set to control the frequency response. C_F includes the stray capacitance of R_F , which is 0.2 pF for a typical surface-mount resistor.

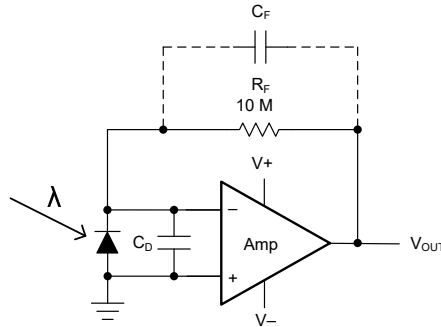

NOTE: C_F is optional to prevent gain peaking, and includes the stray capacitance of R_F .

Figure 7-4. Dual-Supply Transimpedance Amplifier

For an optimized frequency response, use Equation 6 to set the feedback pole:

$$\frac{1}{2\pi R_F C_F} = \sqrt{\frac{\text{GBW}}{4\pi R_F C_D}} \quad (6)$$

Equation 7 calculates the bandwidth:

$$f_{-3\text{dB}} = \sqrt{\frac{\text{GBW}}{2\pi R_F C_D}} \quad (\text{Hz}) \quad (7)$$

For single-supply applications, the +IN input can be biased with a positive dc voltage to allow the output to reach true zero when the photodiode is not exposed to any light, and respond without the added delay that results from coming out of the negative rail. Figure 7-5 shows this configuration. This bias voltage also appears across the photodiode, providing a reverse bias for faster operation.

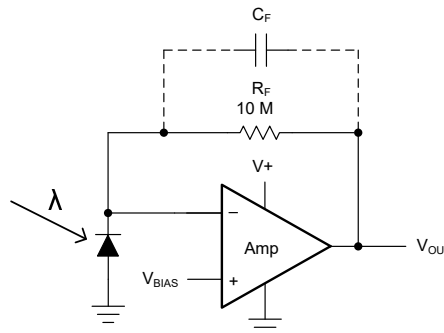

NOTE: C_F is optional to prevent gain peaking, and includes the stray capacitance of R_F .

Figure 7-5. Single-Supply Transimpedance Amplifier

For more information, see the [Compensate Transimpedance Amplifiers Intuitively](#) application report.

7.3 Power Supply Recommendations

The OPAx328 are specified for operation from 2.2 V to 5.5 V (± 1.1 V to ± 2.75 V); many specifications apply from -40°C to $+125^{\circ}\text{C}$. Parameters that can exhibit significant variance with regard to operating voltage or temperature are presented in [Section 5.7](#).

CAUTION

Supply voltages greater than 6 V can permanently damage the device; see [Section 5.1](#).

Place 0.1- μF bypass capacitors close to the power-supply pins to reduce errors coupling in from noisy or high-impedance power supplies. For more detailed information on bypass capacitor placement, see [Section 7.4](#).

7.4 Layout

7.4.1 Layout Guidelines

The OPA328 is a wideband amplifier. To realize the full operational performance of this device, use good, high-frequency PCB layout practices. Connect the bypass capacitors between each supply pin and ground, as close to the device as possible. Design the bypass capacitor traces for minimum inductance.

7.4.2 Layout Example

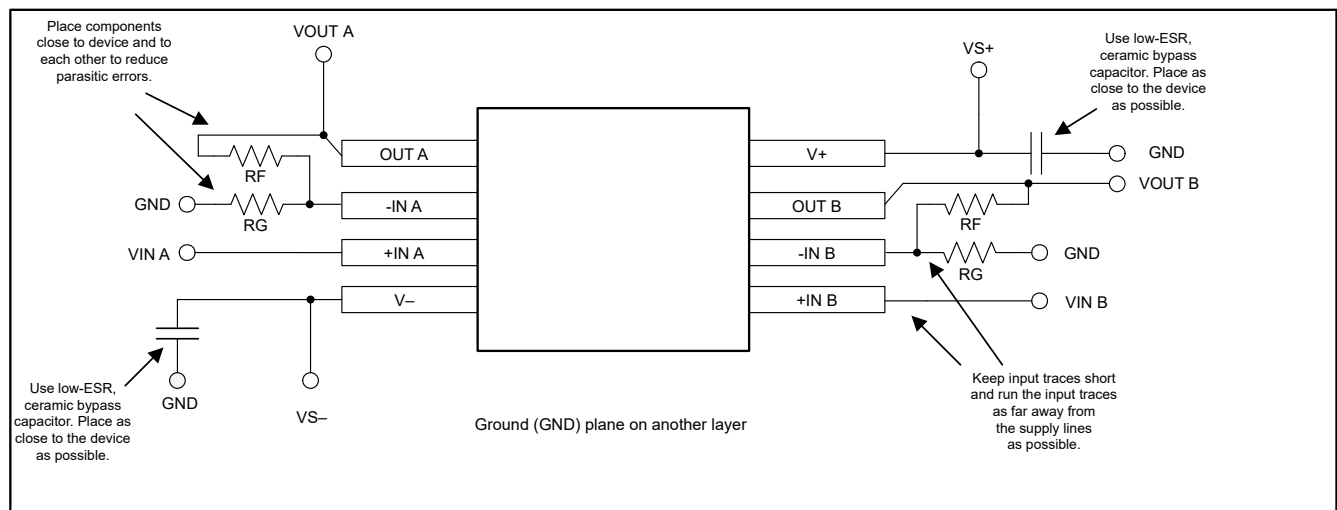
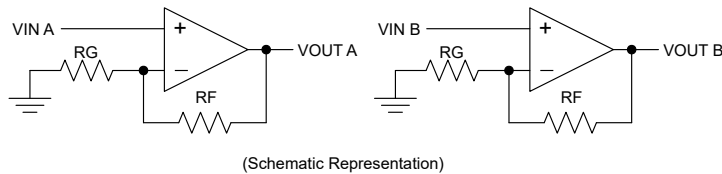

Figure 7-6. Operational Amplifier Board Layout for Noninverting Configuration

8 Device and Documentation Support

8.1 Device Support

8.1.1 Development Support

8.1.1.1 PSpice® for TI

PSpice® for TI is a design and simulation environment that helps evaluate performance of analog circuits. Create subsystem designs and prototype solutions before committing to layout and fabrication, reducing development cost and time to market.

8.1.1.2 TINA-TI™ Simulation Software (Free Download)

TINA-TI™ simulation software is a simple, powerful, and easy-to-use circuit simulation program based on a SPICE engine. TINA-TI simulation software is a free, fully-functional version of the TINA™ software, preloaded with a library of macromodels, in addition to a range of both passive and active models. TINA-TI simulation software provides all the conventional dc, transient, and frequency domain analysis of SPICE, as well as additional design capabilities.

Available as a [free download](#) from the [Design tools and simulation](#) web page, TINA-TI simulation software offers extensive post-processing capability that allows users to format results in a variety of ways. Virtual instruments offer the ability to select input waveforms and probe circuit nodes, voltages, and waveforms, creating a dynamic quick-start tool.

Note

These files require that either the TINA software or TINA-TI software be installed. Download the free TINA-TI simulation software from the [TINA-TI™ software folder](#).

8.1.1.3 DIP-Adapter-EVM

Speed up your op amp prototyping and testing with the [DIP-Adapter-EVM](#), which provides a fast, easy and inexpensive way to interface with small, surface-mount devices. Connect any supported op amp using the included Samtec terminal strips or wire them directly to existing circuits. The DIP-Adapter-EVM kit supports the following industry-standard packages: D or U (SOIC-8), PW (TSSOP-8), DGK (VSSOP-8), DBV (SOT-23-6, SOT-23-5 and SOT-23-3), DCK (SC70-6 and SC70-5), and DRL (SOT563-6).

8.1.1.4 DIYAMP-EVM

The [DIYAMP-EVM](#) is a unique evaluation module (EVM) that provides real-world amplifier circuits, enabling the user to quickly evaluate design concepts and verify simulations. This EVM is available in three industry-standard packages (SC70, SOT23, and SOIC) and 12 popular amplifier configurations, including amplifiers, filters, stability compensation, and comparator configurations for both single and dual supplies.

8.1.1.5 Filter Design Tool

The [filter design tool](#) is a simple, powerful, and easy-to-use active filter design program. The filter design tool allows the user to create optimized filter designs using a selection of TI operational amplifiers and passive components from TI's vendor partners.

Available as a web-based tool from the [Design tools and simulation](#) web page, the [filter design tool](#) allows the user to design, optimize, and simulate complete multistage active filter solutions within minutes.

8.2 Documentation Support

8.2.1 Related Documentation

The following documents are recommended as a reference for this device, and available for download at www.ti.com:

- Texas Instruments, [Software Pacemaker Detection Design Guide](#)
- Texas Instruments, [TIDA-00378 Schematic and Block Diagram](#)
- Texas Instruments, [PM2.5/PM10 Particle Sensor Analog Front-End for Air Quality Monitoring Design](#)
- Texas Instruments, [QFN/SON PCB Attachment](#)
- Texas Instruments, [Quad Flatpack No-Lead Logic Packages](#)
- Texas Instruments, [Compensate Transimpedance Amplifiers Intuitively](#)
- Texas Instruments, [Noise Analysis of FET Transimpedance Amplifiers](#)
- Texas Instruments, [Noise Analysis for High-Speed Op Amps](#)

8.3 Receiving Notification of Documentation Updates

To receive notification of documentation updates, navigate to the device product folder on ti.com. Click on *Notifications* to register and receive a weekly digest of any product information that has changed. For change details, review the revision history included in any revised document.

8.4 Support Resources

[TI E2E™ support forums](#) are an engineer's go-to source for fast, verified answers and design help — straight from the experts. Search existing answers or ask your own question to get the quick design help you need.

Linked content is provided "AS IS" by the respective contributors. They do not constitute TI specifications and do not necessarily reflect TI's views; see TI's [Terms of Use](#).

8.5 Trademarks

e-trim™, TINA-TI™, and TI E2E™ are trademarks of Texas Instruments.

TINA™ is a trademark of DesignSoft, Inc.

PSpice® is a registered trademark of Cadence Design Systems, Inc.

All trademarks are the property of their respective owners.

8.6 Electrostatic Discharge Caution



This integrated circuit can be damaged by ESD. Texas Instruments recommends that all integrated circuits be handled with appropriate precautions. Failure to observe proper handling and installation procedures can cause damage.

ESD damage can range from subtle performance degradation to complete device failure. Precision integrated circuits may be more susceptible to damage because very small parametric changes could cause the device not to meet its published specifications.

8.7 Glossary

[TI Glossary](#) This glossary lists and explains terms, acronyms, and definitions.

9 Revision History

NOTE: Page numbers for previous revisions may differ from page numbers in the current version.

Changes from Revision C (May 2023) to Revision D (December 2023)	Page
• Changed OPA2328 D (SOIC, 8) and DRG (WSON, 8) package status from preview to production data (active) and added associated content	1
Changes from Revision B (November 2022) to Revision C (May 2023)	Page
• Changed OPA328 DBV (SOT-23, 5) package from advanced information (preview) to production data (active)	1
• Added OPA4328 PW (TSSOP, 14) and RUM (WQFN, 16) pin configurations and pin functions table.....	3

Changes from Revision A (June 2022) to Revision B (November 2022)	Page
• Changed OPA328 device status from preview to advanced information.....	1
• Added junction temperature to <i>Absolute Maximum Ratings</i>	5

Changes from Revision * (February 2022) to Revision A (June 2022)	Page
• Changed OPA2328 from advanced information (preview) to production data (active).....	1

10 Mechanical, Packaging, and Orderable Information

The following pages include mechanical, packaging, and orderable information. This information is the most current data available for the designated devices. This data is subject to change without notice and revision of this document. For browser-based versions of this data sheet, refer to the left-hand navigation.

PACKAGING INFORMATION

Orderable Device	Status (1)	Package Type	Package Drawing	Pins	Package Qty	Eco Plan (2)	Lead finish/ Ball material (6)	MSL Peak Temp (3)	Op Temp (°C)	Device Marking (4/5)	Samples
OPA2328DGKR	ACTIVE	VSSOP	DGK	8	2500	RoHS & Green	NIPDAU	Level-2-260C-1 YEAR	-40 to 125	2K6S	Samples
OPA2328DGKT	ACTIVE	VSSOP	DGK	8	250	RoHS & Green	NIPDAU	Level-2-260C-1 YEAR	-40 to 125	2K6S	Samples
OPA2328DR	ACTIVE	SOIC	D	8	3000	RoHS & Green	NIPDAU	Level-2-260C-1 YEAR	-40 to 125	2328W	Samples
OPA2328DRGR	ACTIVE	SON	DRG	8	5000	RoHS & Green	NIPDAU	Level-1-260C-UNLIM	-40 to 125	2328W	Samples
OPA328DBVR	ACTIVE	SOT-23	DBV	5	3000	RoHS & Green	SN	Level-1-260C-UNLIM	-40 to 125	OP328	Samples

(1) The marketing status values are defined as follows:

ACTIVE: Product device recommended for new designs.

LIFEBUY: TI has announced that the device will be discontinued, and a lifetime-buy period is in effect.

NRND: Not recommended for new designs. Device is in production to support existing customers, but TI does not recommend using this part in a new design.

PREVIEW: Device has been announced but is not in production. Samples may or may not be available.

OBSELETE: TI has discontinued the production of the device.

(2) **RoHS:** TI defines "RoHS" to mean semiconductor products that are compliant with the current EU RoHS requirements for all 10 RoHS substances, including the requirement that RoHS substance do not exceed 0.1% by weight in homogeneous materials. Where designed to be soldered at high temperatures, "RoHS" products are suitable for use in specified lead-free processes. TI may reference these types of products as "Pb-Free".

RoHS Exempt: TI defines "RoHS Exempt" to mean products that contain lead but are compliant with EU RoHS pursuant to a specific EU RoHS exemption.

Green: TI defines "Green" to mean the content of Chlorine (Cl) and Bromine (Br) based flame retardants meet JS709B low halogen requirements of <=1000ppm threshold. Antimony trioxide based flame retardants must also meet the <=1000ppm threshold requirement.

(3) MSL, Peak Temp. - The Moisture Sensitivity Level rating according to the JEDEC industry standard classifications, and peak solder temperature.

(4) There may be additional marking, which relates to the logo, the lot trace code information, or the environmental category on the device.

(5) Multiple Device Markings will be inside parentheses. Only one Device Marking contained in parentheses and separated by a "~" will appear on a device. If a line is indented then it is a continuation of the previous line and the two combined represent the entire Device Marking for that device.

(6) Lead finish/Ball material - Orderable Devices may have multiple material finish options. Finish options are separated by a vertical ruled line. Lead finish/Ball material values may wrap to two lines if the finish value exceeds the maximum column width.

Important Information and Disclaimer: The information provided on this page represents TI's knowledge and belief as of the date that it is provided. TI bases its knowledge and belief on information provided by third parties, and makes no representation or warranty as to the accuracy of such information. Efforts are underway to better integrate information from third parties. TI has taken and continues to take reasonable steps to provide representative and accurate information but may not have conducted destructive testing or chemical analysis on incoming materials and chemicals. TI and TI suppliers consider certain information to be proprietary, and thus CAS numbers and other limited information may not be available for release.

In no event shall TI's liability arising out of such information exceed the total purchase price of the TI part(s) at issue in this document sold by TI to Customer on an annual basis.

TAPE AND REEL INFORMATION

QUADRANT ASSIGNMENTS FOR PIN 1 ORIENTATION IN TAPE

*All dimensions are nominal

Device	Package Type	Package Drawing	Pins	SPQ	Reel Diameter (mm)	Reel Width W1 (mm)	A0 (mm)	B0 (mm)	K0 (mm)	P1 (mm)	W (mm)	Pin1 Quadrant
OPA2328DGKR	VSSOP	DGK	8	2500	330.0	12.4	5.3	3.4	1.4	8.0	12.0	Q1
OPA2328DGKT	VSSOP	DGK	8	250	180.0	12.4	5.3	3.4	1.4	8.0	12.0	Q1
OPA2328DR	SOIC	D	8	3000	330.0	12.4	6.4	5.2	2.1	8.0	12.0	Q1
OPA2328DRGR	SON	DRG	8	5000	330.0	12.4	3.3	3.3	1.1	8.0	12.0	Q2

TAPE AND REEL BOX DIMENSIONS

*All dimensions are nominal

Device	Package Type	Package Drawing	Pins	SPQ	Length (mm)	Width (mm)	Height (mm)
OPA2328DGKR	VSSOP	DGK	8	2500	356.0	356.0	35.0
OPA2328DGKT	VSSOP	DGK	8	250	210.0	185.0	35.0
OPA2328DR	SOIC	D	8	3000	356.0	356.0	35.0
OPA2328DRGR	SON	DRG	8	5000	367.0	367.0	35.0

DBV0005A



PACKAGE OUTLINE

SOT-23 - 1.45 mm max height

SMALL OUTLINE TRANSISTOR



4214839/K 08/2024

NOTES:

1. All linear dimensions are in millimeters. Any dimensions in parenthesis are for reference only. Dimensioning and tolerancing per ASME Y14.5M.
2. This drawing is subject to change without notice.
3. Reference JEDEC MO-178.
4. Body dimensions do not include mold flash, protrusions, or gate burrs. Mold flash, protrusions, or gate burrs shall not exceed 0.25 mm per side.
5. Support pin may differ or may not be present.

EXAMPLE BOARD LAYOUT

DBV0005A

SOT-23 - 1.45 mm max height

SMALL OUTLINE TRANSISTOR



LAND PATTERN EXAMPLE
EXPOSED METAL SHOWN
SCALE:15X



SOLDER MASK DETAILS

4214839/K 08/2024

NOTES: (continued)

- 6. Publication IPC-7351 may have alternate designs.
- 7. Solder mask tolerances between and around signal pads can vary based on board fabrication site.

EXAMPLE STENCIL DESIGN

DBV0005A

SOT-23 - 1.45 mm max height

SMALL OUTLINE TRANSISTOR



SOLDER PASTE EXAMPLE
BASED ON 0.125 mm THICK STENCIL
SCALE:15X

4214839/K 08/2024

NOTES: (continued)

8. Laser cutting apertures with trapezoidal walls and rounded corners may offer better paste release. IPC-7525 may have alternate design recommendations.
9. Board assembly site may have different recommendations for stencil design.

DGK0008A



PACKAGE OUTLINE

VSSOP - 1.1 mm max height

SMALL OUTLINE PACKAGE



4214862/A 04/2023

NOTES:

PowerPAD is a trademark of Texas Instruments.

1. All linear dimensions are in millimeters. Any dimensions in parenthesis are for reference only. Dimensioning and tolerancing per ASME Y14.5M.
2. This drawing is subject to change without notice.
3. This dimension does not include mold flash, protrusions, or gate burrs. Mold flash, protrusions, or gate burrs shall not exceed 0.15 mm per side.
4. This dimension does not include interlead flash. Interlead flash shall not exceed 0.25 mm per side.
5. Reference JEDEC registration MO-187.

EXAMPLE BOARD LAYOUT

DGK0008A

™ VSSOP - 1.1 mm max height

SMALL OUTLINE PACKAGE



LAND PATTERN EXAMPLE
EXPOSED METAL SHOWN
SCALE: 15X



SOLDER MASK DETAILS

4214862/A 04/2023

NOTES: (continued)

6. Publication IPC-7351 may have alternate designs.
7. Solder mask tolerances between and around signal pads can vary based on board fabrication site.
8. Vias are optional depending on application, refer to device data sheet. If any vias are implemented, refer to their locations shown on this view. It is recommended that vias under paste be filled, plugged or tented.
9. Size of metal pad may vary due to creepage requirement.

EXAMPLE STENCIL DESIGN

DGK0008A

TM VSSOP - 1.1 mm max height

SMALL OUTLINE PACKAGE



SOLDER PASTE EXAMPLE
SCALE: 15X

4214862/A 04/2023

NOTES: (continued)

11. Laser cutting apertures with trapezoidal walls and rounded corners may offer better paste release. IPC-7525 may have alternate design recommendations.
12. Board assembly site may have different recommendations for stencil design.



D0008A

PACKAGE OUTLINE

SOIC - 1.75 mm max height

SMALL OUTLINE INTEGRATED CIRCUIT



4214825/C 02/2019

NOTES:

- Linear dimensions are in inches [millimeters]. Dimensions in parenthesis are for reference only. Controlling dimensions are in inches. Dimensioning and tolerancing per ASME Y14.5M.
- This drawing is subject to change without notice.
- This dimension does not include mold flash, protrusions, or gate burrs. Mold flash, protrusions, or gate burrs shall not exceed $.006$ [0.15] per side.
- This dimension does not include interlead flash.
- Reference JEDEC registration MS-012, variation AA.

EXAMPLE BOARD LAYOUT

D0008A

SOIC - 1.75 mm max height

SMALL OUTLINE INTEGRATED CIRCUIT



LAND PATTERN EXAMPLE
EXPOSED METAL SHOWN
SCALE:8X



SOLDER MASK DETAILS

4214825/C 02/2019

NOTES: (continued)

6. Publication IPC-7351 may have alternate designs.

7. Solder mask tolerances between and around signal pads can vary based on board fabrication site.

EXAMPLE STENCIL DESIGN

D0008A

SOIC - 1.75 mm max height

SMALL OUTLINE INTEGRATED CIRCUIT



SOLDER PASTE EXAMPLE
BASED ON .005 INCH [0.125 MM] THICK STENCIL
SCALE:8X

4214825/C 02/2019

NOTES: (continued)

8. Laser cutting apertures with trapezoidal walls and rounded corners may offer better paste release. IPC-7525 may have alternate design recommendations.
9. Board assembly site may have different recommendations for stencil design.

DRG (S-PWSON-N8)

PLASTIC SMALL OUTLINE NO-LEAD

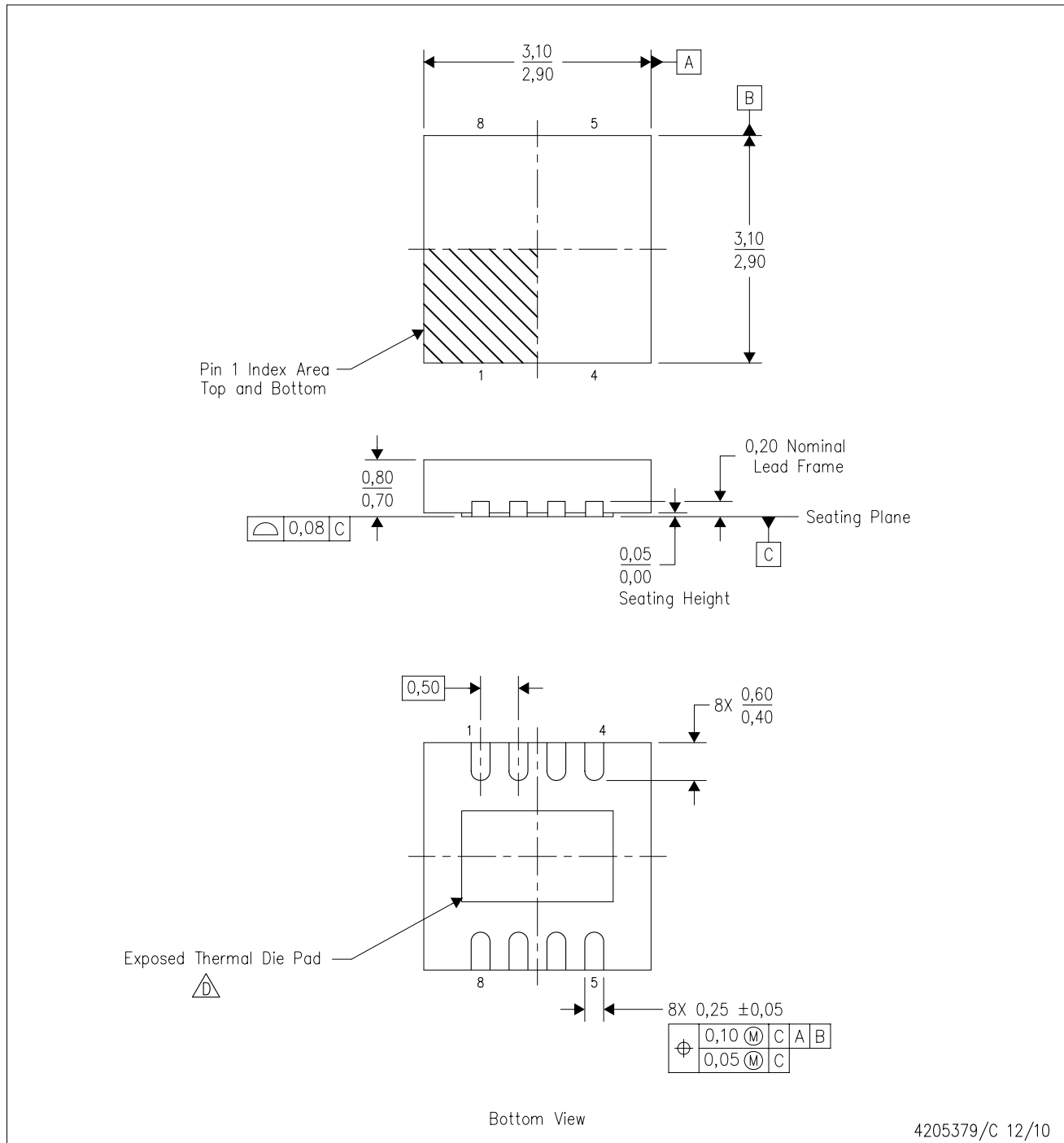

- NOTES:
- A. All linear dimensions are in millimeters. Dimensioning and tolerancing per ASME Y14.5M-1994.
 - B. This drawing is subject to change without notice.
 - C. SON (Small Outline No-Lead) package configuration.
 - △ The package thermal pad must be soldered to the board for thermal and mechanical performance. See the Product Data Sheet for details regarding the exposed thermal pad dimensions.
 - E. JEDEC MO-229 package registration pending.

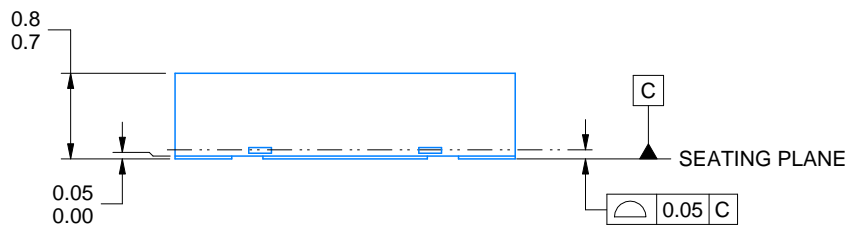
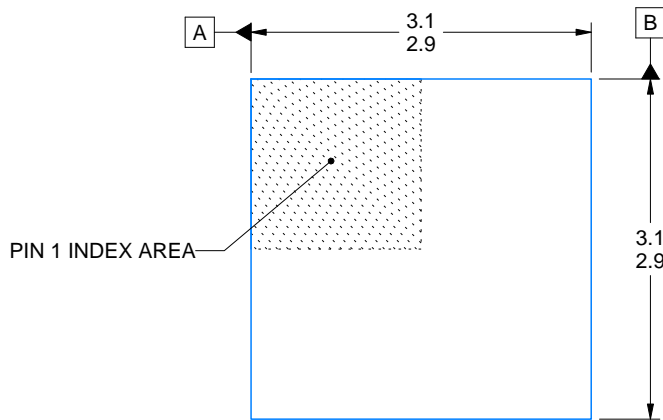
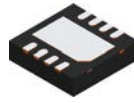

DIMENSION A	
OPTION 01	(0.1)
OPTION 02	(0.2)

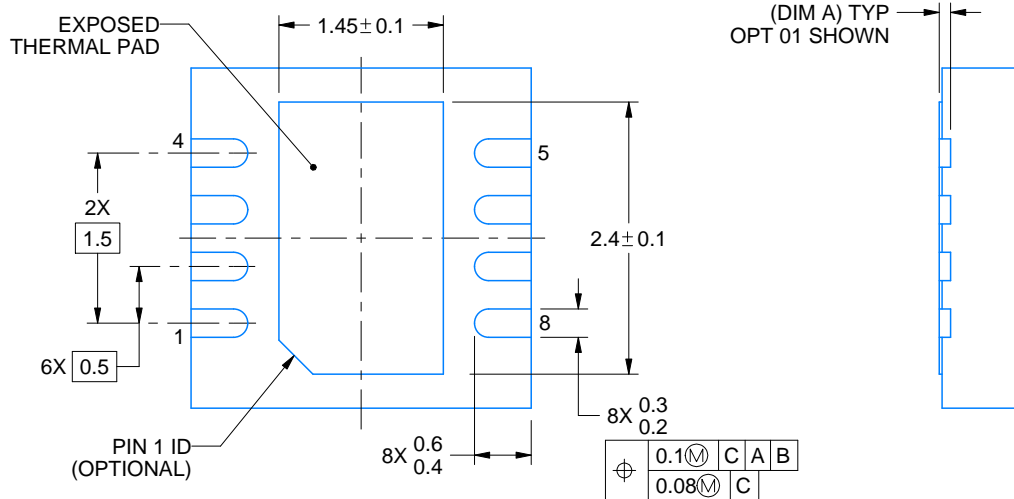

4218886/A 01/2020

NOTES:

1. All linear dimensions are in millimeters. Any dimensions in parenthesis are for reference only. Dimensioning and tolerancing per ASME Y14.5M.
2. This drawing is subject to change without notice.
3. The package thermal pad must be soldered to the printed circuit board for thermal and mechanical performance.

EXAMPLE BOARD LAYOUT

DRG0008B

WSON - 0.8 mm max height

PLASTIC SMALL OUTLINE - NO LEAD

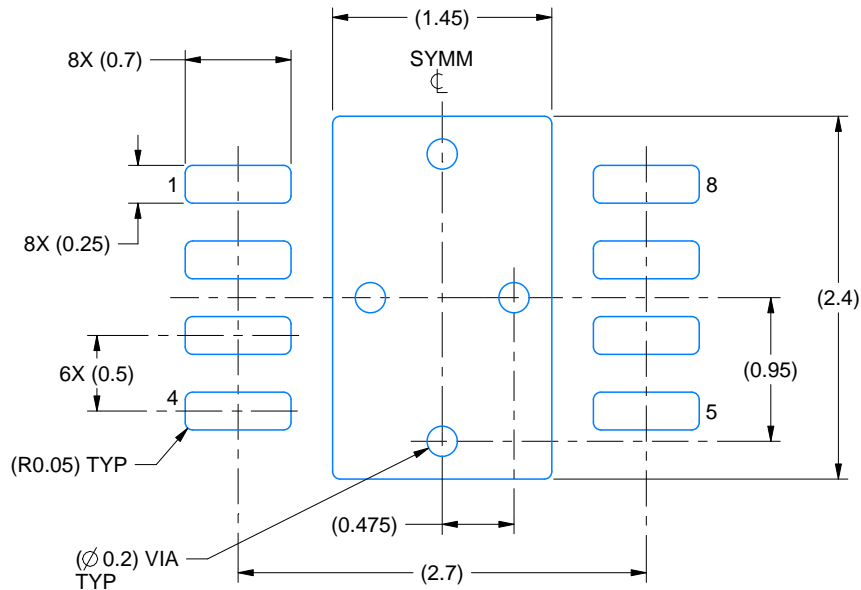

LAND PATTERN EXAMPLE
SCALE:20X

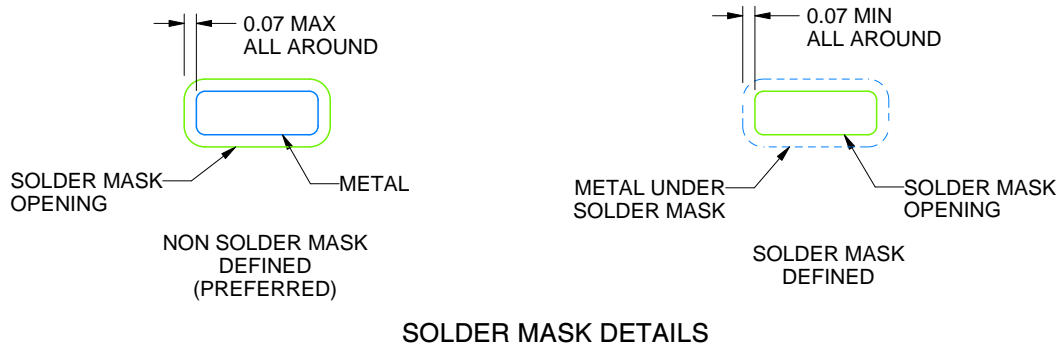

SOLDER MASK DETAILS

4218886/A 01/2020

NOTES: (continued)

4. This package is designed to be soldered to a thermal pad on the board. For more information, see Texas Instruments literature number SLUA271 (www.ti.com/lit/slua271).
5. Vias are optional depending on application, refer to device data sheet. If any vias are implemented, refer to their locations shown on this view. It is recommended that vias under paste be filled, plugged or tented.

EXAMPLE STENCIL DESIGN

DRG0008B

WSO - 0.8 mm max height

PLASTIC SMALL OUTLINE - NO LEAD

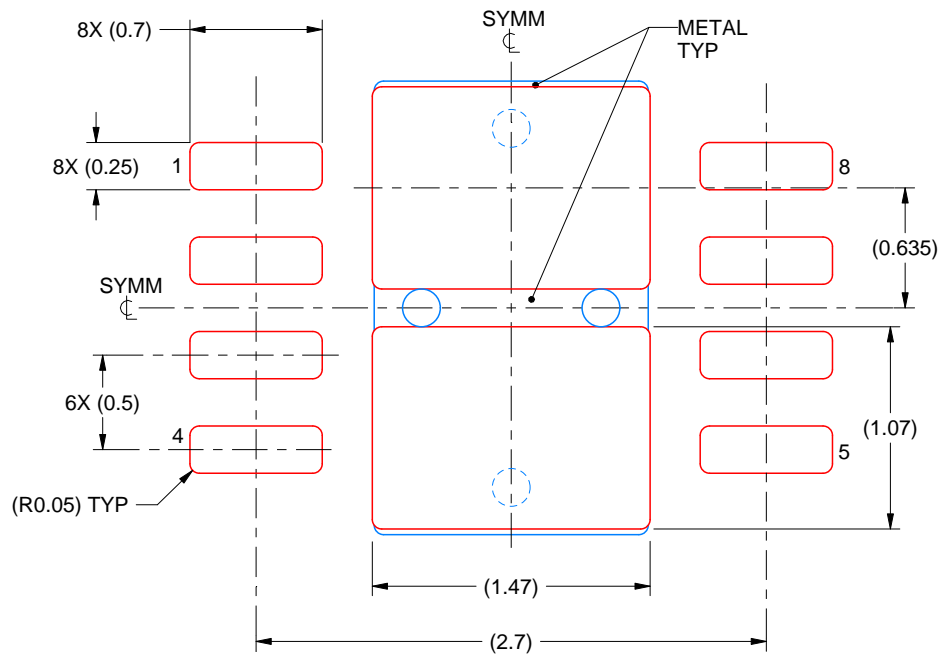

SOLDER PASTE EXAMPLE
BASED ON 0.125 mm THICK STENCIL

EXPOSED PAD
82% PRINTED SOLDER COVERAGE BY AREA
SCALE:25X

4218886/A 01/2020

NOTES: (continued)

6. Laser cutting apertures with trapezoidal walls and rounded corners may offer better paste release. IPC-7525 may have alternate design recommendations.

IMPORTANT NOTICE AND DISCLAIMER

TI PROVIDES TECHNICAL AND RELIABILITY DATA (INCLUDING DATA SHEETS), DESIGN RESOURCES (INCLUDING REFERENCE DESIGNS), APPLICATION OR OTHER DESIGN ADVICE, WEB TOOLS, SAFETY INFORMATION, AND OTHER RESOURCES "AS IS" AND WITH ALL FAULTS, AND DISCLAIMS ALL WARRANTIES, EXPRESS AND IMPLIED, INCLUDING WITHOUT LIMITATION ANY IMPLIED WARRANTIES OF MERCHANTABILITY, FITNESS FOR A PARTICULAR PURPOSE OR NON-INFRINGEMENT OF THIRD PARTY INTELLECTUAL PROPERTY RIGHTS.

These resources are intended for skilled developers designing with TI products. You are solely responsible for (1) selecting the appropriate TI products for your application, (2) designing, validating and testing your application, and (3) ensuring your application meets applicable standards, and any other safety, security, regulatory or other requirements.

These resources are subject to change without notice. TI grants you permission to use these resources only for development of an application that uses the TI products described in the resource. Other reproduction and display of these resources is prohibited. No license is granted to any other TI intellectual property right or to any third party intellectual property right. TI disclaims responsibility for, and you will fully indemnify TI and its representatives against, any claims, damages, costs, losses, and liabilities arising out of your use of these resources.

TI's products are provided subject to [TI's Terms of Sale](#) or other applicable terms available either on [ti.com](https://www.ti.com) or provided in conjunction with such TI products. TI's provision of these resources does not expand or otherwise alter TI's applicable warranties or warranty disclaimers for TI products.

TI objects to and rejects any additional or different terms you may have proposed.

Mailing Address: Texas Instruments, Post Office Box 655303, Dallas, Texas 75265
Copyright © 2024, Texas Instruments Incorporated