

# OPA857 Ultralow-Noise, Wideband, Selectable-Feedback Resistance Transimpedance Amplifier

## 1 Features

- Internal Midscale Reference Voltage
- Pseudo-Differential Output Voltage
- Wide Dynamic Range
- Closed-Loop Transimpedance Bandwidth:
  - 125 MHz (5-k $\Omega$  Transimpedance Gain, 1.5-pF External Parasitic Capacitance)
  - 105 MHz (20-k $\Omega$  Transimpedance Gain, 1.5-pF External Parasitic Capacitance)
- Ultralow Input-Referred Current Noise (Brickwall Filter BW = 135 MHz): 15 nA<sub>RMS</sub> (20-k $\Omega$  Transimpedance)
- Very Fast Overload Recovery Time: < 25 ns
- Internal Input Protection Diode
- Power Supply:
  - Voltage: 2.7 V to 3.6 V
  - Current: 23.4 mA
- Extended Temperature Range: –40°C to +85°C

## 2 Applications

- Photodiode Monitoring
- High-Speed I/V Conversion
- Optical Amplifiers
- CAT-Scanner Front-Ends

## 3 Description

The OPA857 is a wideband, fast overdrive recovery, fast-settling, ultralow-noise transimpedance amplifier targeted at photodiode monitoring applications. With selectable feedback resistance, the OPA857 simplifies the design of high-performance optical systems. Very fast overload recovery time and internal input protection provide the best combination to protect the remainder of the signal chain from overdrive while minimizing recovery time. The two selectable transimpedance gain configurations allow high dynamic range and flexibility required in modern transimpedance amplifier applications. The OPA857 is available in a 3-mm × 3-mm VQFN package.

The device is characterized for operation over the full industrial temperature range from –40°C to +85°C.

### Device Information<sup>(1)</sup>

DEVICE NAME	PACKAGE	BODY SIZE
OPA857	VQFN (16)	3 mm × 3 mm

(1) For all available packages, see the package option addendum at the end of the datasheet.

### Functional Block Diagram

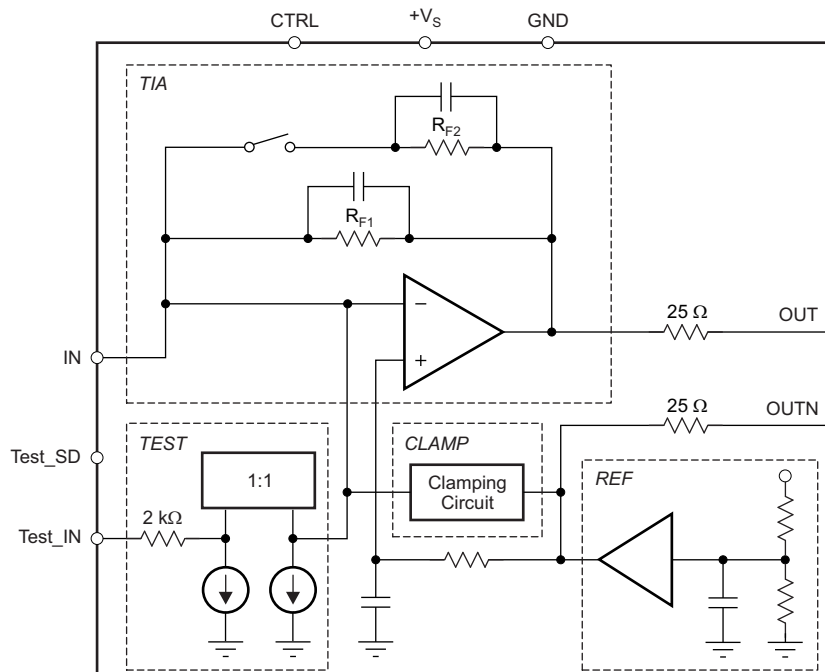

## Table of Contents

<b>1 Features</b> .....	<b>1</b>	<b>8 Application and Implementation</b> .....	<b>18</b>
<b>2 Applications</b> .....	<b>1</b>	8.1 Application Information.....	18
<b>3 Description</b> .....	<b>1</b>	8.2 Typical Application .....	18
<b>4 Revision History</b> .....	<b>2</b>	<b>9 Power-Supply Recommendations</b> .....	<b>23</b>
<b>5 Pin Configuration and Functions</b> .....	<b>4</b>	<b>10 Layout</b> .....	<b>23</b>
<b>6 Specifications</b> .....	<b>5</b>	10.1 Layout Guidelines .....	23
6.1 Absolute Maximum Ratings .....	5	10.2 Layout Example .....	24
6.2 ESD Ratings.....	5	<b>11 Device and Documentation Support</b> .....	<b>25</b>
6.3 Recommended Operating Conditions.....	5	11.1 Device Support.....	25
6.4 Thermal Information .....	5	11.2 Documentation Support .....	25
6.5 Electrical Characteristics.....	6	11.3 Receiving Notification of Documentation Updates	25
6.6 Typical Characteristics .....	8	11.4 Community Resources.....	25
<b>7 Detailed Description</b> .....	<b>14</b>	11.5 Trademarks .....	25
7.1 Overview .....	14	11.6 Electrostatic Discharge Caution.....	26
7.2 Functional Block Diagram .....	14	11.7 Glossary .....	26
7.3 Feature Description.....	15	<b>12 Mechanical, Packaging, and Orderable</b>	<b>26</b>
7.4 Device Functional Modes.....	17	<b>Information</b> .....	<b>26</b>

## 4 Revision History

NOTE: Page numbers for previous revisions may differ from page numbers in the current version.

<b>Changes from Revision C (April 2014) to Revision D</b>	<b>Page</b>
• Changed Features bullets .....	1
• Changed "Precision" to "High-Speed" in 2nd Applications bullet.....	1
• Changed pin configuration drawing and pin functions table.....	4
• Changed Handling Ratings table to ESD Ratings and moved storage temperature to Absolute Maximum Ratings .....	5
• Changed <i>Supply Input Voltage</i> min value from 3.0 to 2.7 in Recommended Operating Conditions .....	5
• Changed V <sub>OUT</sub> unit from V <sub>p</sub> to V <sub>pp</sub> in Electrical Characteristics condition line .....	6
• Changed all <i>AC Performance</i> values except <i>Closed-Loop Output Impedance</i> .....	6
• Changed test conditions for <i>Equivalent Input-Referred Current Noise</i> parameter in Electrical Characteristics .....	6
• Deleted <i>Operating Voltage</i> from Electrical Characteristics; already in Recommended Operating Conditions .....	7
• Deleted <i>Temperature Range</i> from Electrical Characteristics; already in Recommended Operating Conditions .....	7
• Changed all plots in Typical Characteristics section except figures 17, 35, and 36 .....	8
• Changed 4.5 kΩ and 18.2 kΩ to 5 kΩ and 20 kΩ, respectively, in first paragraph of <i>Overview</i> section.....	14
• Changed text in <i>Transimpedance Amplifier (TIA) Block</i> section .....	15
• Changed text in <i>Reference Voltage (REF) Block</i> section.....	15
• Changed text in <i>Integrated Test Structure (TEST) Block</i> section .....	15
• Changed Table 2 values.....	17
• Added <i>Test Mode</i> section.....	17
• Changed <i>Application Information</i> section .....	18
• Changed Figure 50; updated pin names .....	24

<b>Changes from Revision B (January 2014) to Revision C</b>	<b>Page</b>
• Changed document format to meet new data sheet standards; added <i>Handling Ratings</i> and <i>Device and Documentation Support</i> sections, and moved existing sections .....	1
• Changed OUTN to OUT in <i>Output Voltage Swing</i> parameter test conditions .....	6
• Changed <a href="#">Functional Block Diagram</a> .....	14

**Changes from Revision A (December 2013) to Revision B** **Page**

---

- Changed document status to Production Data ..... 1
  - Changed transimpedance value in both sub-bullets of *Bandwidth Features* bullet ..... 1
  - Changed *Extended Temperature Range Features* bullet to a range of –40°C to +85°C ..... 1
  - Changed first sentence of *Description* section: added "targeted at photodiode monitoring applications" ..... 1
  - Changed temperature range to –40°C to +85°C in last sentence of *Description* section ..... 1
  - Changed front-page graphic ..... 1
  - Added pages 2 through end of document ..... 4
- 

**Changes from Original (December 2013) to Revision A** **Page**

---

- Changed document status to Product Preview ..... 1
  - Deleted all pages past page 1 ..... 1
  - Deleted fourth Applications bullet ..... 1
  - Changed first sentence of *Description* section ..... 1
-

## 5 Pin Configuration and Functions

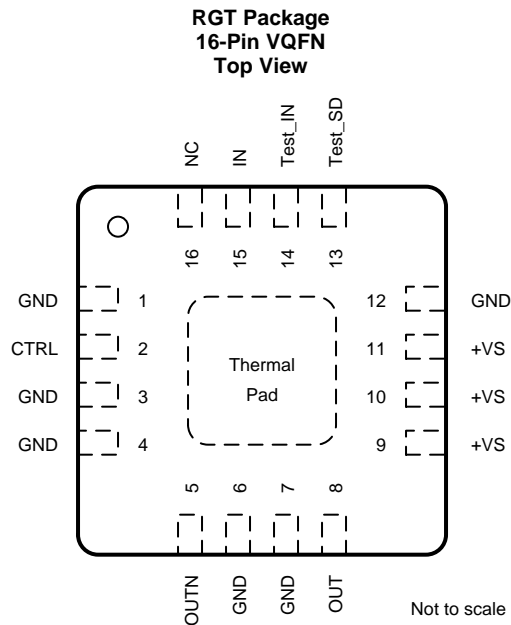

### Pin Functions

PIN		I/O	DESCRIPTION
NAME	NO.		
CTRL	2	I	Control pin for transimpedance gain. GND, logic 0 = 5-kΩ internal resistance; +V <sub>S</sub> , logic 1 = 20-kΩ internal resistance.
GND	1, 3, 4, 6, 7, 12	I	Ground
IN	15	I	Input
NC	16	—	Not connected
OUT	8	O	Signal output
OUTN	5	O	Common-mode voltage output reference
Test_IN	14	I	Test mode input. Connect to +V <sub>S</sub> during normal operation.
Test_SD	13	I	Test mode enable. Connect to GND for normal operation, and connect to +V <sub>S</sub> to enable test mode.
+V <sub>S</sub>	9, 10, 11	I	Supply voltage

## 6 Specifications

### 6.1 Absolute Maximum Ratings<sup>(1)</sup>

over operating free-air temperature range (unless otherwise noted)

		MIN	MAX	UNIT
Voltage	Supply voltage, $V_{S-}$ to $V_{S+}$		3.8	V
	Input and output voltage, $V_{IN}$ , $V_{OUT}$ pins	$(V_{S-}) - 0.7$	$(V_{S+}) + 0.7$	
	Differential input voltage		1	
Current	Output current		50	mA
	Input current, $V_{IN}$ pin		10	
Continuous power dissipation		See <a href="#">Thermal Information</a> table		
Temperature	Maximum junction, $T_J$		150	°C
	Maximum junction, $T_J$ (continuous operation, long-term reliability)		140	
	Operating free-air, $T_A$	-40	85	
	Storage, $T_{stg}$	-65	150	

(1) Stresses beyond those listed under absolute maximum ratings may cause permanent damage to the device. These are stress ratings only, and functional operation of the device at these or any other conditions beyond those indicated under recommended operating conditions is not implied. Exposure to absolute-maximum-rated conditions for extended periods may affect device reliability.

### 6.2 ESD Ratings

			VALUE	UNIT
$V_{(ESD)}$	Electrostatic discharge	Human-body model (HBM), per ANSI/ESDA/JEDEC JS-001 <sup>(1)</sup>	±2000	V
		Charged-device model (CDM), per JEDEC specification JESD22-C101 <sup>(2)</sup>	±500	

(1) JEDEC document JEP155 states that 500-V HBM allows safe manufacturing with a standard ESD control process.

(2) JEDEC document JEP157 states that 250-V CDM allows safe manufacturing with a standard ESD control process.

### 6.3 Recommended Operating Conditions

over operating free-air temperature range (unless otherwise noted)

		MIN	NOM	MAX	UNIT
$V_{SS}$	Supply input voltage	2.7	3.3	3.6	V
$T_J$	Operating junction temperature	-40		85	°C

### 6.4 Thermal Information

THERMAL METRIC <sup>(1)</sup>		OPA857	UNIT
		RGT (VQFN)	
		16 PINS	
$R_{\theta JA}$	Junction-to-ambient thermal resistance	67.1	°C/W
$R_{\theta JC(top)}$	Junction-to-case(top) thermal resistance	91.6	°C/W
$R_{\theta JB}$	Junction-to-board thermal resistance	41.6	°C/W
$\Psi_{JT}$	Junction-to-top characterization parameter	7.1	°C/W
$\Psi_{JB}$	Junction-to-board characterization parameter	41.7	°C/W
$R_{\theta JC(bot)}$	Junction-to-case(bottom) thermal resistance	23.1	°C/W

(1) For more information about traditional and new thermal metrics, see the *Semiconductor and IC Package Thermal Metrics* application report ([SPRA953](#)).

## 6.5 Electrical Characteristics

at  $T_A = 25^\circ\text{C}^{(1)}$ ,  $V_S = 3.3\text{ V}$ ,  $V_{S+} - V_{S-} = 3.3\text{ V}$ ,  $C_{\text{Source}} = 1.5\text{ pF}$ ,  $V_{\text{OUT}} = 0.5 V_{\text{PP}}$  (differential),  $R_L = 500\text{-}\Omega$  differential, single-ended input, pseudo-differential output, and input and output referenced to midsupply (unless otherwise noted)

PARAMETER		TEST CONDITIONS	MIN	TYP	MAX	UNIT	TEST LEVEL <sup>(2)</sup>	
<b>AC PERFORMANCE</b>								
Small-signal bandwidth	CTRL = 1, $T_A = -40^\circ\text{C}$ to $+85^\circ\text{C}$		105			MHz	C	
	CTRL = 0, $T_A = -40^\circ\text{C}$ to $+85^\circ\text{C}$		125			MHz	C	
SR	Slew rate (differential)		$V_{\text{OUT}} = 1\text{-V}$ step		215	V/ $\mu\text{s}$	C	
$t_s$	Settling time to 1%	$V_{\text{OUT}} = 0.5\text{-V}$ step, CTRL = 0, $T_A = 25^\circ\text{C}$		8		ns	B	
		$V_{\text{OUT}} = 0.5\text{-V}$ step, CTRL = 1, $T_A = 25^\circ\text{C}$		8		ns	B	
	Settling time to 0.001%	$V_{\text{OUT}} = 0.5\text{-V}$ step, CTRL = 0		600		ns	C	
		$V_{\text{OUT}} = 0.5\text{-V}$ step, CTRL = 1		700		ns	C	
HD2	Second-harmonic distortion	$V_{\text{OUT}} = 0.5 V_{\text{PP}}$ , $f = 10\text{ MHz}$ , $R_F = 5\text{ k}\Omega$ , $T_A = 25^\circ\text{C}$		-80		dBc	C	
		$V_{\text{OUT}} = 0.5 V_{\text{PP}}$ , $f = 10\text{ MHz}$ , $R_F = 20\text{ k}\Omega$ , $T_A = 25^\circ\text{C}$		-83		dBc	C	
HD3	Third-harmonic distortion	$V_{\text{OUT}} = 0.5 V_{\text{PP}}$ , $f = 10\text{ MHz}$ , $R_F = 5\text{ k}\Omega$ , $T_A = 25^\circ\text{C}$		-88		dBc	C	
		$V_{\text{OUT}} = 0.5 V_{\text{PP}}$ , $f = 10\text{ MHz}$ , $R_F = 20\text{ k}\Omega$ , $T_A = 25^\circ\text{C}$		-83		dBc	C	
Equivalent input-referred current noise	CTRL = 0, using 135-MHz brickwall filter		25			nA <sub>RMS</sub>	C	
	CTRL = 1, using 135-MHz brickwall filter		15			nA <sub>RMS</sub>	C	
Overdrive recovery time		$I_{\text{IN}} = 2\text{x}$ overload, CTRL = 1, settling to 1% of final value		25		ns	B	
Closed-loop output impedance		$f = 1\text{ MHz}$ (differential)		50		$\Omega$	C	
<b>DC PERFORMANCE</b>								
Transimpedance gain	CTRL = 1 into $500\text{ }\Omega^{(3)(4)}$		18.2			k $\Omega$	C	
	CTRL = 0 into $500\text{ }\Omega^{(3)(4)}$		4.5			k $\Omega$	C	
Transimpedance gain error		$T_A = 25^\circ\text{C}$ , $R_F = 20\text{ k}\Omega$ and $R_F = 5\text{ k}\Omega$		$\pm 1\%$	$\pm 15\%$		A	
$V_{\text{OO}}$	Output offset voltage	$T_A = +25^\circ\text{C}$		$\pm 1$	$\pm 5$	mV	A	
		$T_A = -40^\circ\text{C}$ to $+85^\circ\text{C}^{(5)}$			$\pm 6$	mV	B	
Output offset voltage drift		$T_A = -40^\circ\text{C}$ to $+85^\circ\text{C}^{(5)}$			$\pm 15$	$\mu\text{V}/^\circ\text{C}$	C	
$V_{\text{ICR}}$	Common-mode voltage range		$T_A = 25^\circ\text{C}$ , OUTN	1.78	1.83	1.88	V	A
<b>INPUT</b>								
Input pin capacitance				2		pF	C	
<b>OUTPUT</b>								
Output voltage swing	OUT, $T_A = 25^\circ\text{C}$		0.6		1.9	V	A	
	$T_A = -40^\circ\text{C}$ to $+85^\circ\text{C}^{(5)}$				1.9	V	B	
Output current drive (for linear operation)	OUT, differential $50\text{-}\Omega$ between OUT and OUTN		+5			mA	C	
			-20			mA	C	

- (1) Junction temperature = ambient for  $70^\circ\text{C}$  specifications.
- (2) Test levels: **(A)** 100% tested at  $25^\circ\text{C}$ . Overtemperature limits set by characterization and simulation. **(B)** Limits set by characterization and simulation. **(C)** Typical value only for information.
- (3) See the [Application and Implementation](#) section for details on loading and effective transimpedance gain.
- (4) Note that the effective transimpedance gain is reduced to  $18.2\text{ k}\Omega$  and  $4.5\text{ k}\Omega$ , respectively, with a  $500\text{-}\Omega$  load resulting from the internal series resistance on OUT and OUTN.
- (5) Junction temperature = ambient at low temperature; junction temperature = ambient +  $3.5^\circ\text{C}$  for overtemperature specifications.

## Electrical Characteristics (continued)

at  $T_A = 25^\circ\text{C}^{(1)}$ ,  $V_S = 3.3\text{ V}$ ,  $V_{S+} - V_{S-} = 3.3\text{ V}$ ,  $C_{\text{SOURCE}} = 1.5\text{ pF}$ ,  $V_{\text{OUT}} = 0.5\text{ V}_{\text{PP}}$  (differential),  $R_L = 500\text{-}\Omega$  differential, single-ended input, pseudo-differential output, and input and output referenced to midsupply (unless otherwise noted)

PARAMETER	TEST CONDITIONS	MIN	TYP	MAX	UNIT	TEST LEVEL <sup>(2)</sup>
<b>POWER SUPPLY</b>						
Quiescent operating current	CTRL = 0, $T_A = 25^\circ\text{C}$	20.5	23.4	26.3	mA	A
	CTRL = 0, $T_A = -40^\circ\text{C}$ to $+85^\circ\text{C}^{(5)}$	20.0		26.8	mA	B
	CTRL = 1, $T_A = 25^\circ\text{C}$	20.5	23.4	26.3	mA	A
	CTRL = 1, $T_A = -40^\circ\text{C}$ to $+85^\circ\text{C}^{(5)}$	20.0		26.8	mA	B
PSRR Power-supply rejection ratio	At dc, $T_A = 25^\circ\text{C}$	70	80		dB	A
	$f = 10\text{ MHz}$ , $T_A = -40^\circ\text{C}$ to $+85^\circ\text{C}^{(5)}$	15	18		dB	B
<b>LOGIC LEVEL (CTRL)</b>						
$V_{\text{IH}}$	High-level input voltage	2			V	A
$V_{\text{IL}}$	Low-level input voltage			0.8	V	A
	High-level control pin input bias current			1	$\mu\text{A}$	A
	Low-level control pin input bias current			1	$\mu\text{A}$	A

## 6.6 Typical Characteristics

At  $T_A = 25^\circ\text{C}$ ,  $C_S = 1.5\text{ pF}$ , and  $R_L = 500\text{-}\Omega$  differential between OUT and OUTN (unless otherwise noted).

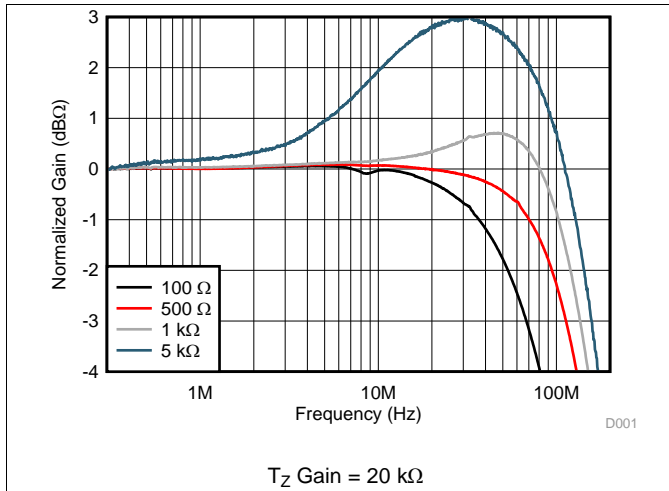

Figure 1. Frequency Response vs Load Resistance

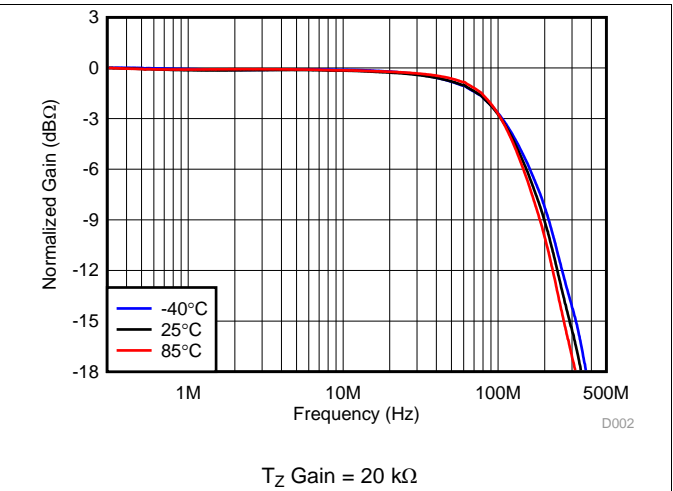

Figure 2. Frequency Response vs Temperature

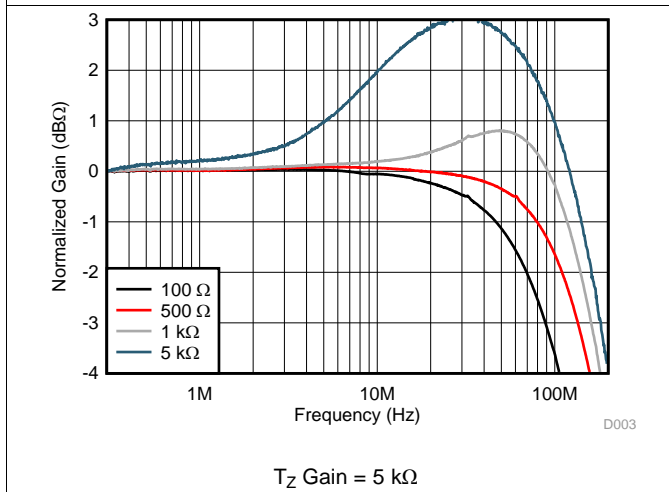

Figure 3. Frequency Response vs Load Resistance

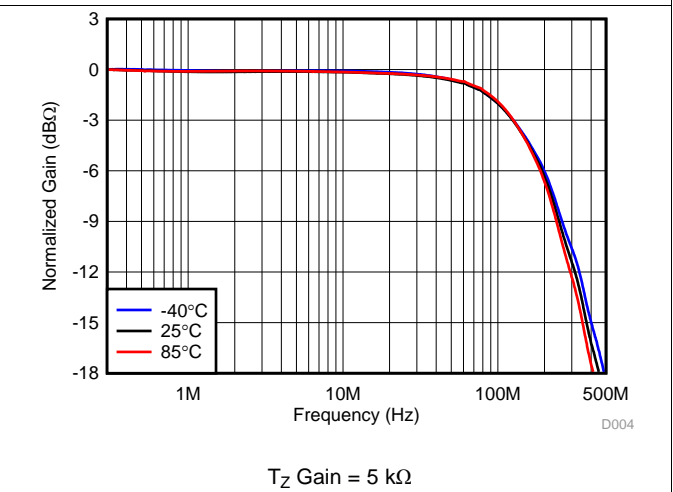

Figure 4. Frequency Response vs Temperature

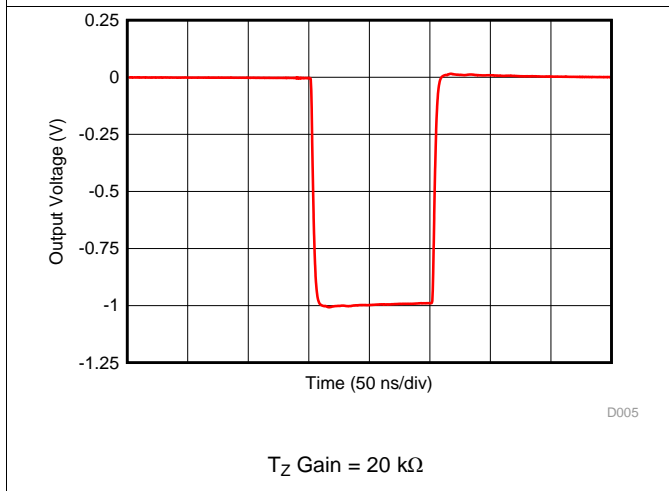

Figure 5. 1-V<sub>pp</sub> Pulse Response

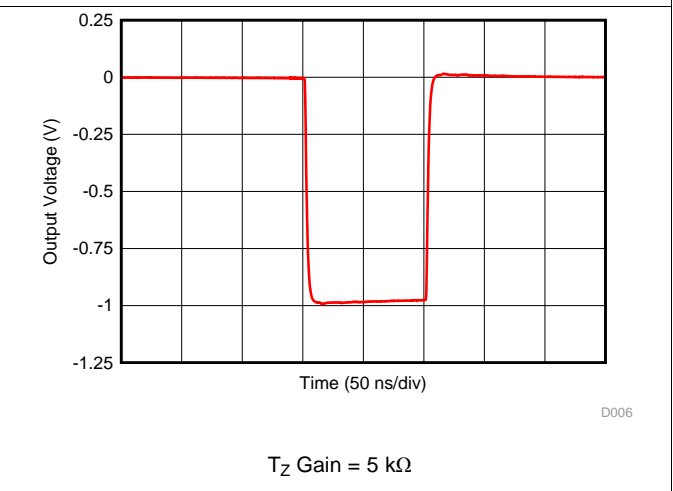

Figure 6. 1-V<sub>pp</sub> Pulse Response



Typical Characteristics (continued)

At  $T_A = 25^\circ\text{C}$ ,  $C_S = 1.5\text{ pF}$ , and  $R_L = 500\text{-}\Omega$  differential between OUT and OUTN (unless otherwise noted).

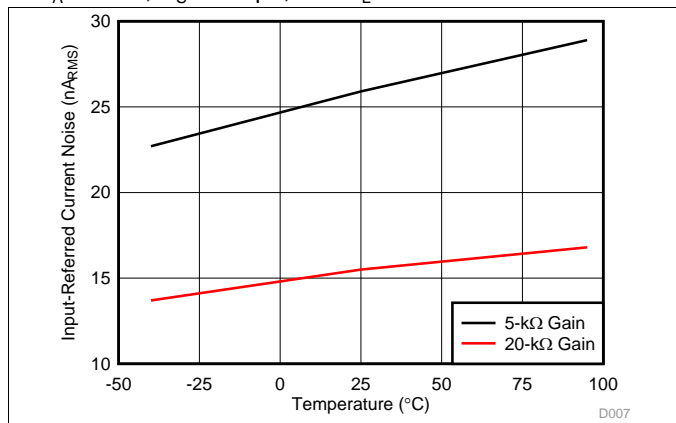

Figure 7. RMS Input-Referred Current Noise vs Temperature

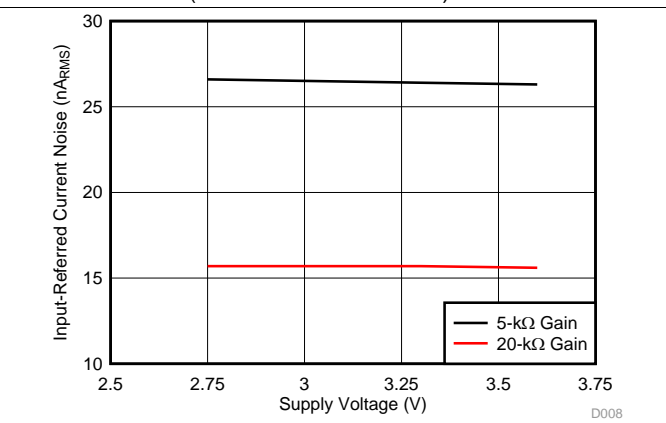

Figure 8. RMS Input-Referred Current Noise vs Supply Voltage

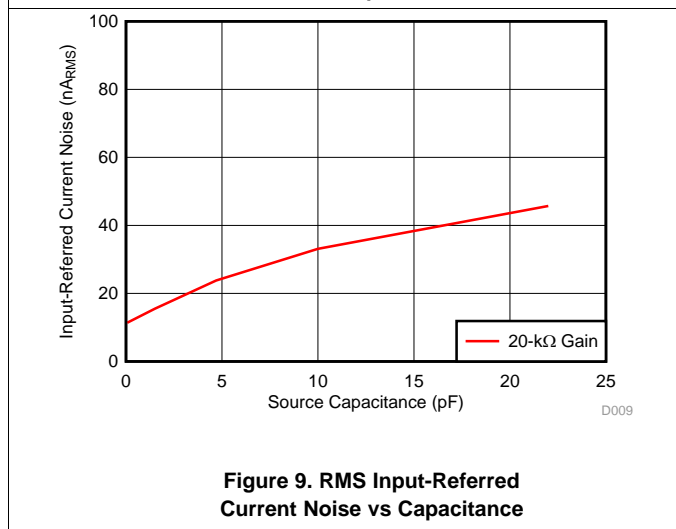

Figure 9. RMS Input-Referred Current Noise vs Capacitance

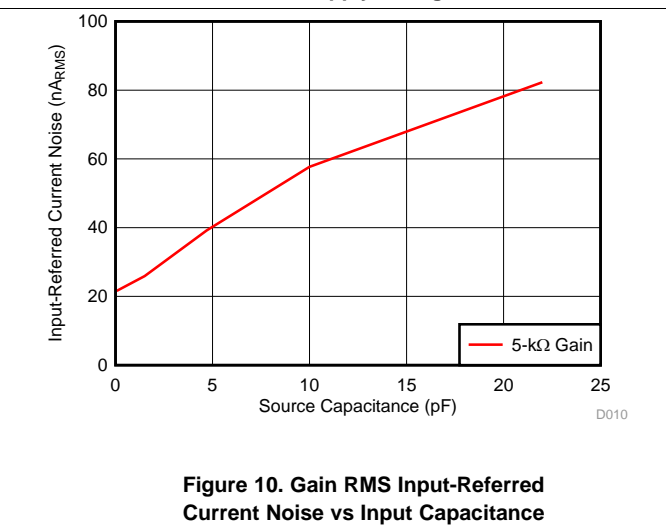

Figure 10. Gain RMS Input-Referred Current Noise vs Input Capacitance

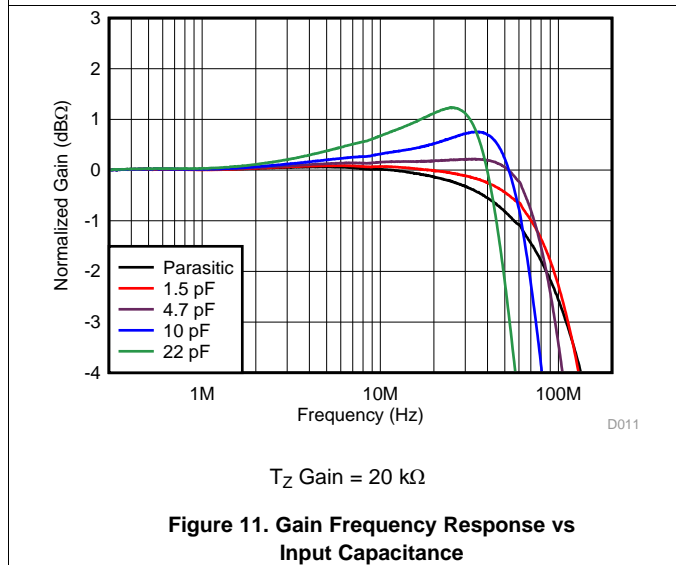

Figure 11. Gain Frequency Response vs Input Capacitance

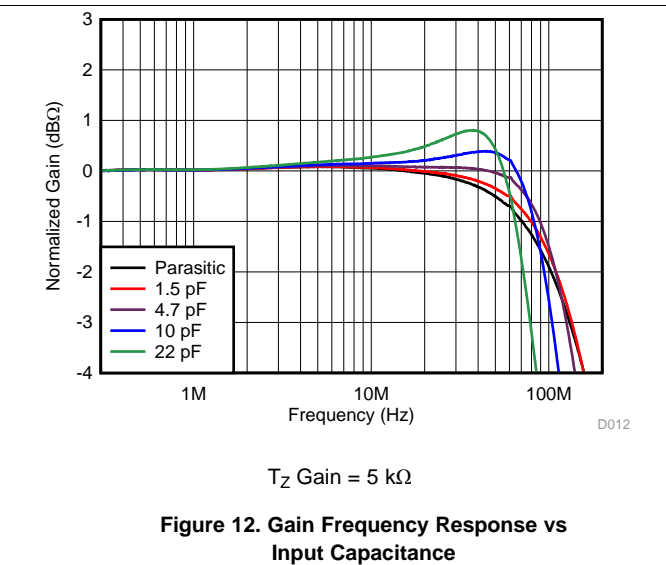
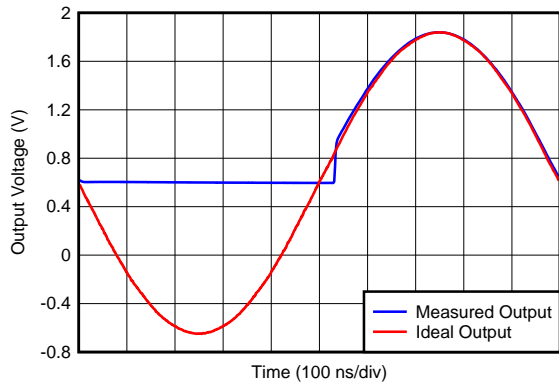

Figure 12. Gain Frequency Response vs Input Capacitance

Typical Characteristics (continued)

At  $T_A = 25^\circ\text{C}$ ,  $C_S = 1.5\text{ pF}$ , and  $R_L = 500\text{-}\Omega$  differential between OUT and OUTN (unless otherwise noted).



D013

$T_Z$  Gain = 20 k $\Omega$

Figure 13. 2x Overdrive Recovery

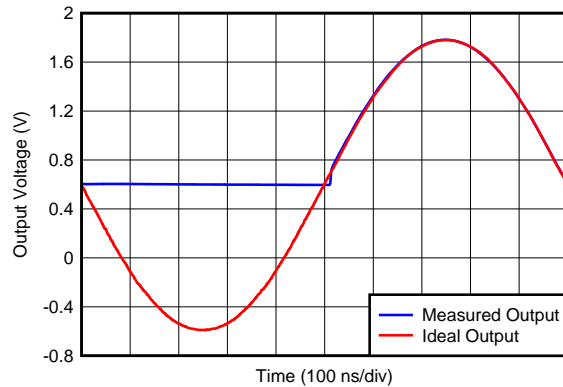

D014

$T_Z$  Gain = 5 k $\Omega$

Figure 14. 2x Overdrive Recovery

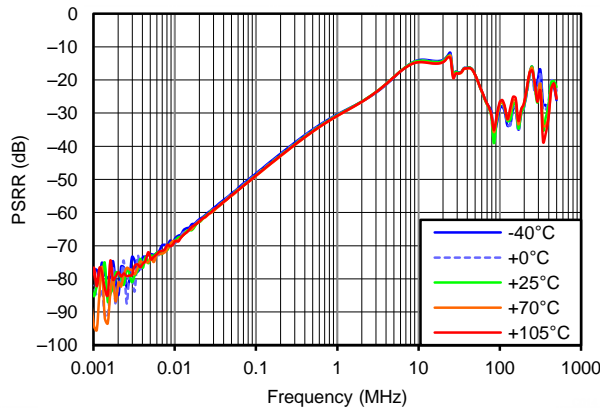

$T_Z$  Gain = 20-k $\Omega$

Figure 15. Power-Supply Rejection Ratio vs Frequency

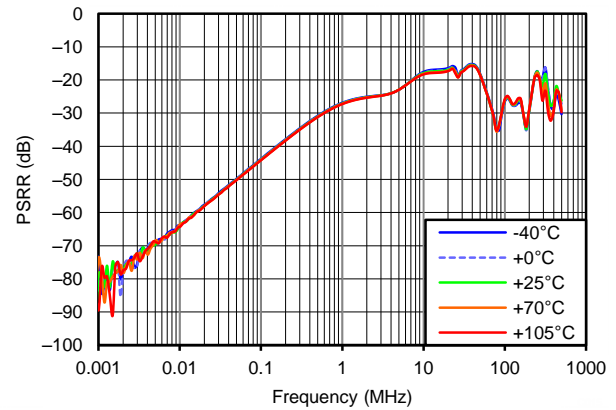

$T_Z$  Gain = 5 k $\Omega$

Figure 16. Power-Supply Rejection Ratio vs Frequency

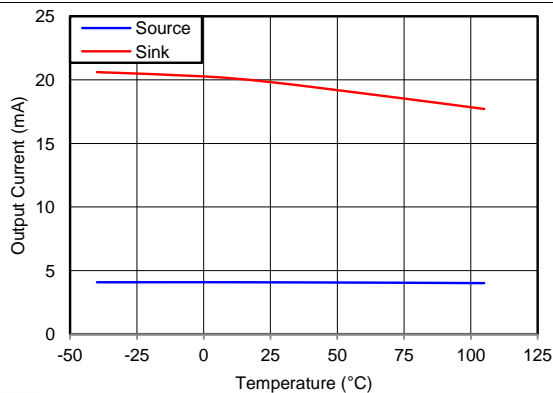
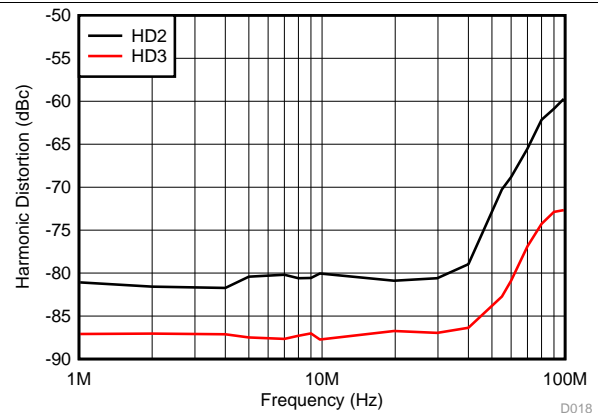

Figure 17. Output Current vs Temperature



D018

$T_Z$  Gain = 5 k $\Omega$ ,  $R_{LOAD} = 500\ \Omega$

Figure 18. Harmonic Distortion vs Frequency

Typical Characteristics (continued)

At  $T_A = 25^\circ\text{C}$ ,  $C_S = 1.5\text{ pF}$ , and  $R_L = 500\text{-}\Omega$  differential between OUT and OUTN (unless otherwise noted).

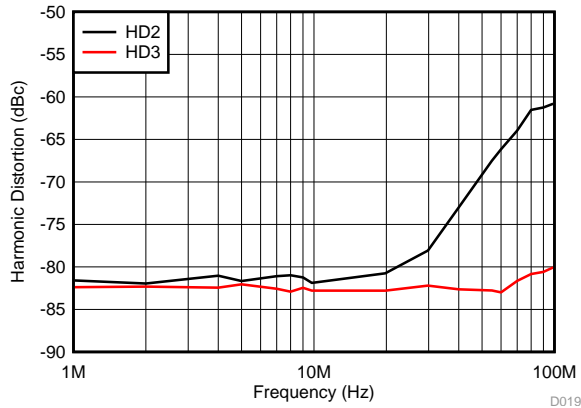

$T_Z$  Gain = 20 k $\Omega$ ,  $R_{LOAD} = 500\ \Omega$

Figure 19. Harmonic Distortion vs Frequency

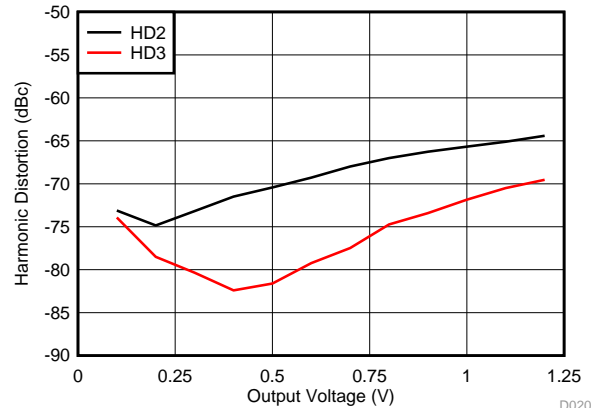

$T_Z$  Gain = 5 k $\Omega$ ,  $R_{LOAD} = 500\ \Omega$ ,  $f = 50\text{ MHz}$

Figure 20. Harmonic Distortion vs Output Voltage

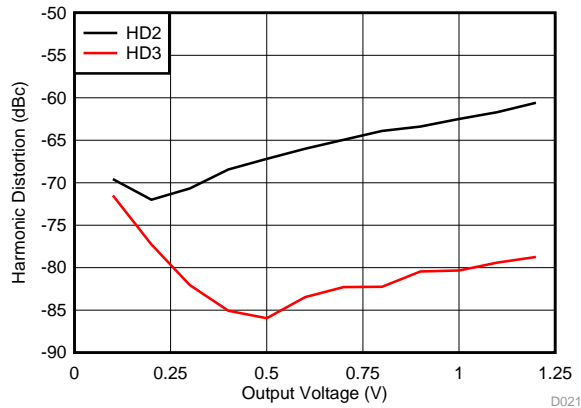

$T_Z$  Gain = 20 k $\Omega$ ,  $R_{LOAD} = 500\ \Omega$ ,  $f = 50\text{ MHz}$

Figure 21. Harmonic Distortion vs Output Voltage

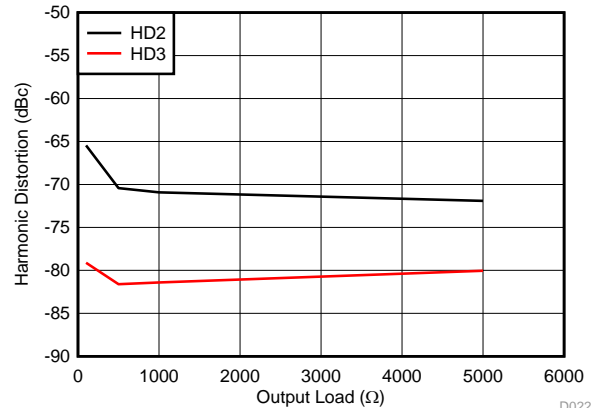

$T_Z$  Gain = 5 k $\Omega$ ,  $f = 50\text{ MHz}$

Figure 22. Harmonic Distortion vs  $R_{LOAD}$

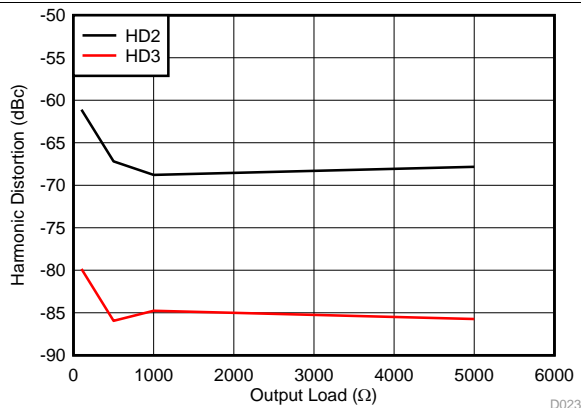

$T_Z$  Gain = 20 k $\Omega$ ,  $f = 50\text{ MHz}$

Figure 23. Harmonic Distortion vs  $R_{LOAD}$

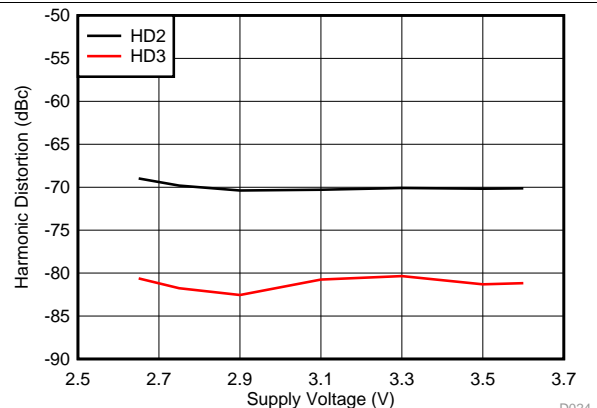

$T_Z$  Gain = 5 k $\Omega$ ,  $T_A = 25^\circ\text{C}$ ,  $R_{LOAD} = 500\ \Omega$ ,  $f = 50\text{ MHz}$

Figure 24. Harmonic Distortion vs Supply Voltage

### Typical Characteristics (continued)

At  $T_A = 25^\circ\text{C}$ ,  $C_S = 1.5\text{ pF}$ , and  $R_L = 500\text{-}\Omega$  differential between OUT and OUTN (unless otherwise noted).

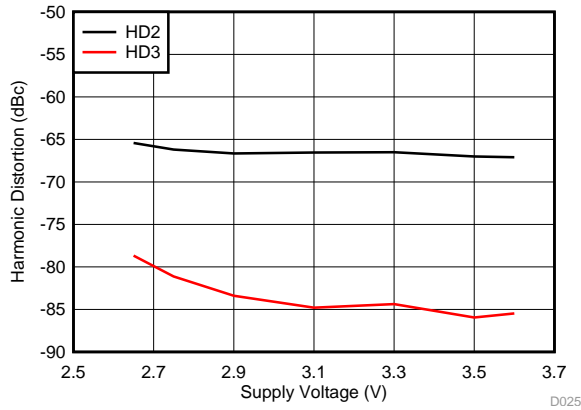

$T_Z$  Gain = 20 k $\Omega$ ,  $T_A = 25^\circ\text{C}$ ,  $R_{LOAD} = 500\ \Omega$ ,  $f = 50\text{ MHz}$

Figure 25. Harmonic Distortion vs Supply Voltage

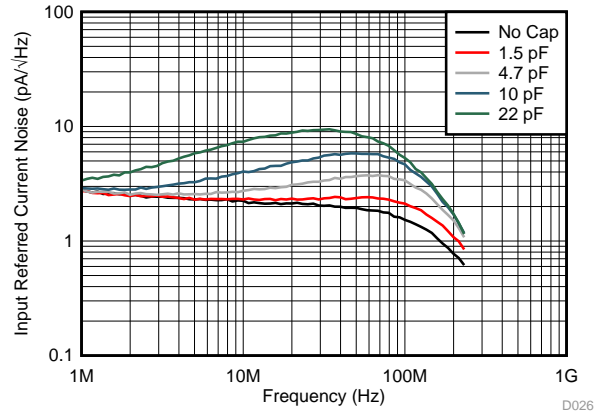

$T_Z$  Gain = 5 k $\Omega$

Figure 26. Input-Referred Current Noise Density vs Frequency

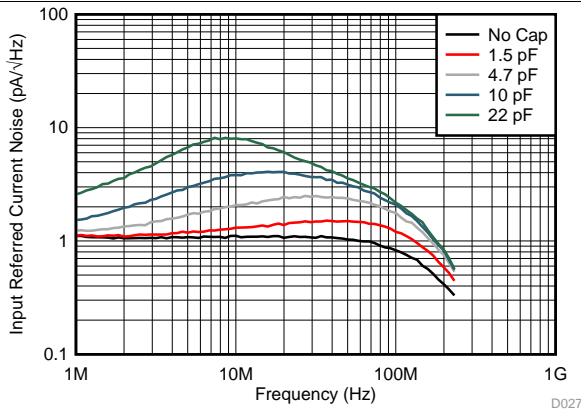

$T_Z$  Gain = 20 k $\Omega$

Figure 27. Input-Referred Current Noise Density vs Frequency

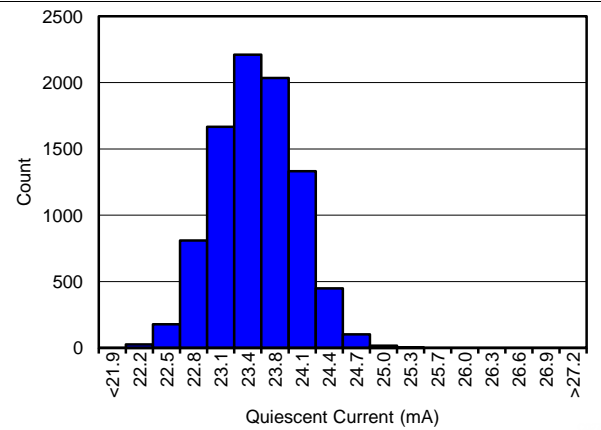

$T_Z$  Gain = 20 k $\Omega$

Figure 28.  $I_Q$  Histogram

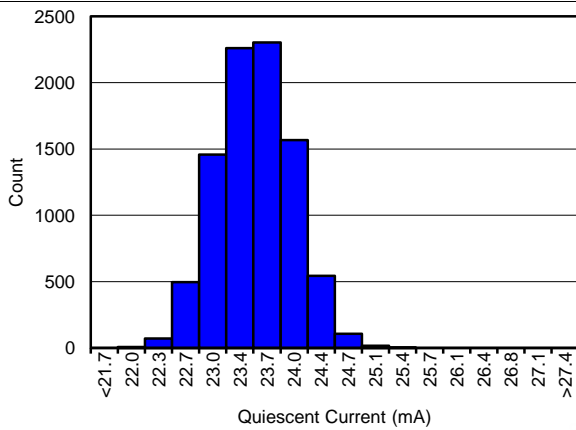

$T_Z$  Gain = 5 k $\Omega$

Figure 29.  $I_Q$  Histogram

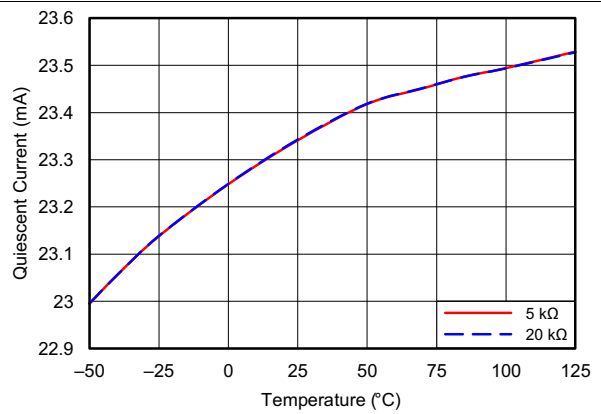

Figure 30. Quiescent Current vs Temperature

Typical Characteristics (continued)

At  $T_A = 25^\circ\text{C}$ ,  $C_S = 1.5\text{ pF}$ , and  $R_L = 500\text{-}\Omega$  differential between OUT and OUTN (unless otherwise noted).

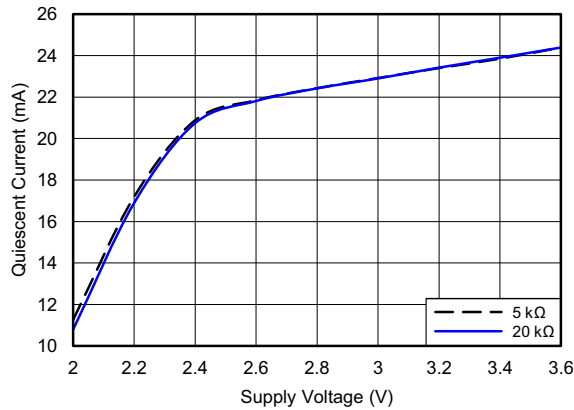

Figure 31. Quiescent Current vs Supply Voltage

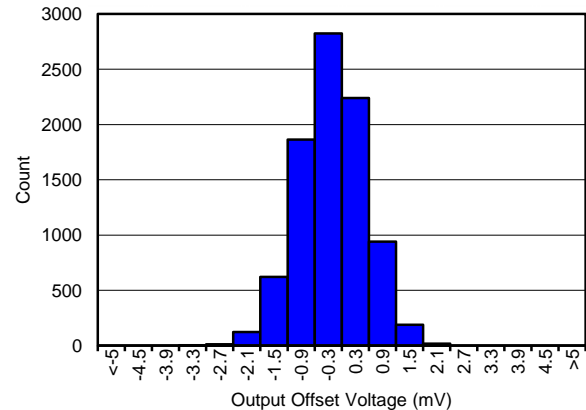

Figure 32. Differential  $V_{OSO}$  Histogram

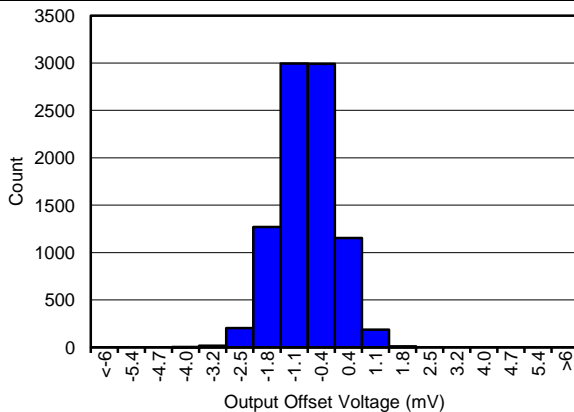

Figure 33. Differential  $V_{OSO}$  Histogram

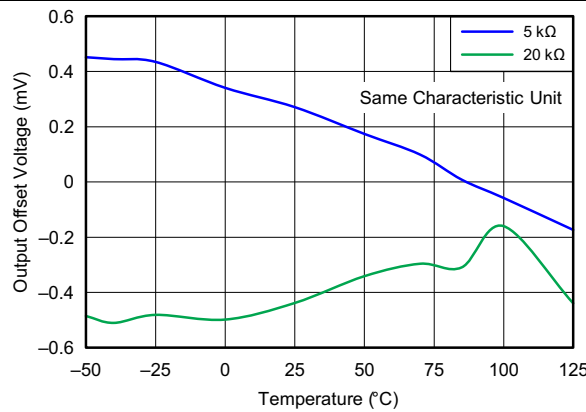

Figure 34. Output Offset Voltage vs Temperature

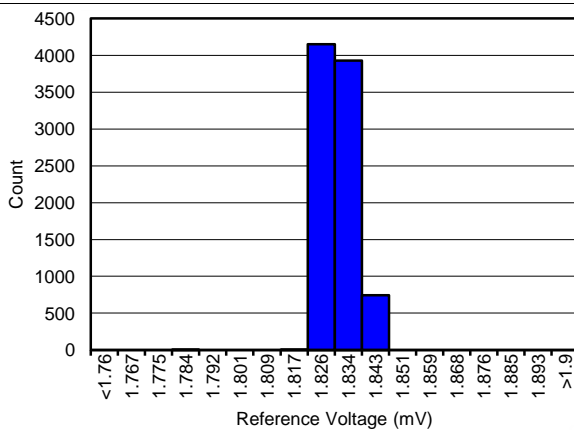

Figure 35. Reference Voltage ( $V_{OUTN}$ ) Distribution Histogram

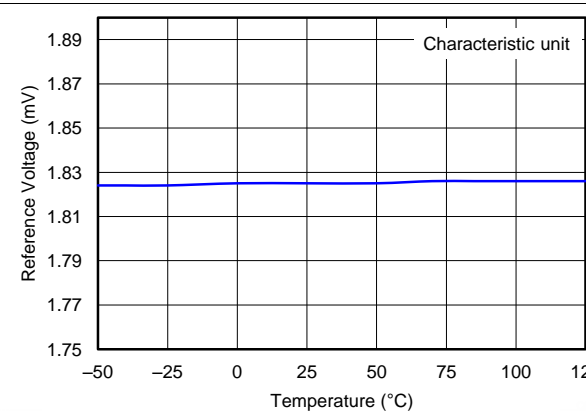

Figure 36. Reference Voltage ( $V_{OUTN}$ ) vs Temperature

## 7 Detailed Description

### 7.1 Overview

The OPA857 provides a unique combination of low-noise, high-bandwidth, and high-transimpedance gain. The amplifier is optimized to achieve greater than 100-MHz bandwidth on either the 5-k $\Omega$  or 20-k $\Omega$  transimpedance gain for the lowest possible RMS noise on the output for a targeted low input capacitance of 1.5 pF. Note that this 1.5-pF capacitance includes the board parasitic; thus, great attention must be placed on minimizing stray capacitance in the layout. This value is selected because the device is expected to be driven by a photodiode with biasing high enough to include the photodiode capacitance contribution between approximately 0.5 pF and 0.7 pF, leaving between 0.8 pF to 1 pF for the external parasitic.

The OPA857 is a dedicated transimpedance amplifier with a pseudo-differential output. A block diagram is provided in the [Functional Block Diagram](#) section.

There are four distinct blocks in this diagram: a transimpedance amplifier (TIA), a reference voltage (REF), a test structure (TEST), and an internal clamping circuit (CLAMP).

The TIA block of the [Functional Block Diagram](#) includes two selectable gain configurations:  $R_{F1}$  and  $R_{F2}$ . For a 500- $\Omega$  load, including the GND alternatives resulting from the internal 25- $\Omega$  series resistor on each output, the resulting gain is 4.5 k $\Omega$  or 18.2 k $\Omega$ . The TIA block is designed to provide excellent bandwidth (> 100 MHz) in both gain configurations with the lowest possible RMS noise over the entire bandwidth. This level of performance is achieved by minimizing the noise gain peaking at higher frequencies. The noise gain peaking resulting from feedback and source capacitance is the main noise contributor in high-speed transimpedance amplifiers.

The reference voltage block of the [Functional Block Diagram](#) has several purposes: this block provides an adequate dc reference voltage to the input, and provides a dc reference at the output (thus allowing the dc-coupled solution to interface to a fully-differential signal chain). The CMRR provided by the fully-differential signal chain reduces any feedthrough from the OPA857 power supply, thereby increasing the PSRR of the amplifier.

The test structure block is available on the pinout, but the main purpose of this structure is to allow the device characterization to proceed as smoothly as possible.

The internal clamping circuit block and ESD diodes on the IN pin are used for internal protection and to make sure that the amplifier can recover quickly after saturation.

These blocks are each described in further detail in the [Feature Description](#) section.

### 7.2 Functional Block Diagram

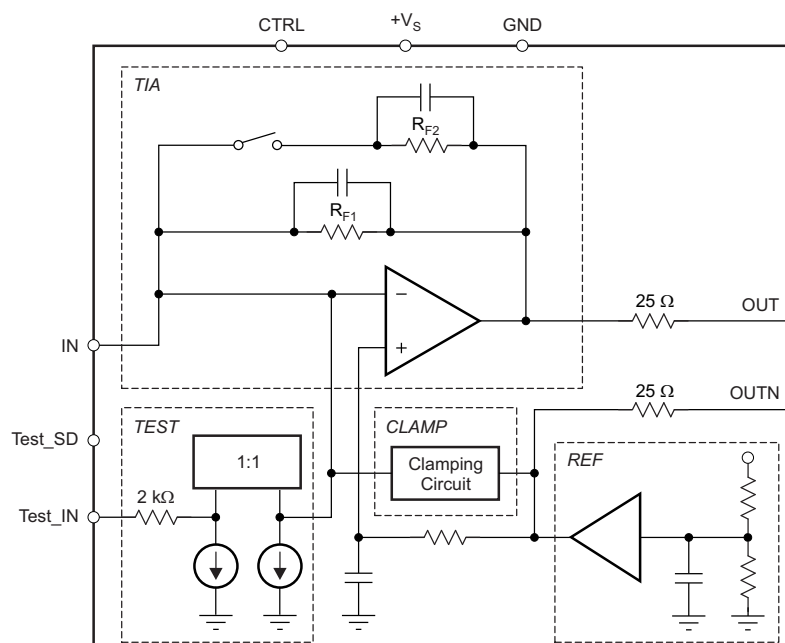

## 7.3 Feature Description

### 7.3.1 Transimpedance Amplifier (TIA) Block

The amplifier of the TIA block has a class-A output stage, which limits its usable swing from the common-mode voltage of 1.83 V to the negative rail. Because the internal protection allows excellent overdrive recovery, the negative swing cannot go closer than 0.6 V to the rail. The resulting output dynamic range of the OPA857 on a 3.3-V supply is 1.2 V. This 1.2-V swing corresponds to a maximum input current of 60  $\mu\text{A}$  in the high-gain configuration, and 240  $\mu\text{A}$  in the low-gain configuration. A 25- $\Omega$  series resistor between the internal output of the TIA block and OUT (pin 8) limits the amplifier load during short-circuit conditions. A similar 25- $\Omega$  series resistor also exists between the output of the reference voltage amplifier and OUTN (pin 5). The internal resistors on OUT and OUTN reduce the overall gain of the OPA857. With a 500- $\Omega$  differential load, the attenuation resulting from the load is 0.83 dB, which affects the overall transimpedance gain. Because of the load attenuation, the 20-k $\Omega$  transimpedance gain is reduced to an effective 18.2 k $\Omega$ , while the 5-k $\Omega$  internal resistor gain is reduced to an effective 4.5-k $\Omega$  internal resistor.

### 7.3.2 Reference Voltage (REF) Block

The reference output voltage is set to be 5/9th of the power supply. Thus, for a single 3.3-V supply, the reference voltage is 1.83 V. A wideband amplifier with low output impedance to high frequencies is used in the reference voltage block. The amplifier output drives two paths: the first path drives the output (OUTN) through a 25- $\Omega$  series resistor, while the second path drives the noninverting input of the TIA block. The output from the second path is filtered through an RC filter in order to reduce the noise contribution from the reference block.

### 7.3.3 Integrated Test Structure (TEST) Block

In order to evaluate the low input capacitance condition on the input of the OPA857, simply evaluate the OPA857 performance without the photodiode. An integrated voltage-to-current conversion is implemented and can be accessed with the use of Test\_SD (pin 13) and Test\_IN (pin 14). This V-to-I converter structure is represented in Figure 37. If required, a capacitor can be added to IN (pin 15) to match the target input capacitance during normal operation with an external photodiode. The test structure in Figure 37 allows for the evaluation of the OPA857 as a TIA using standard lab equipment, such as function generators and network analyzers.

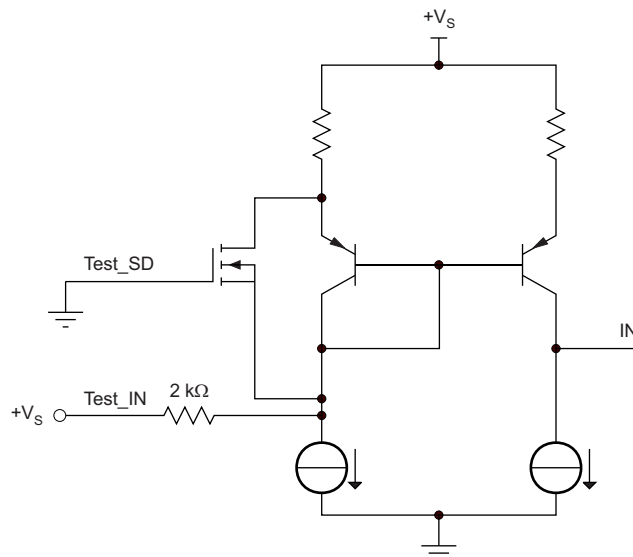

Figure 37. Internal V-to-I Converter

When using a photodiode, make sure that this source is turned off completely. This test structure is not intended to be used as a output dc-control voltage.

## Feature Description (continued)

### 7.3.4 Internal Clamping Circuit (CLAMP) Block

The OPA857 is built using a very high-speed, complementary, BICMOS process. The internal junction breakdown voltages are relatively low for these very small geometry devices. These breakdowns are reflected in the [Absolute Maximum Ratings](#)<sup>(1)</sup> table. All device pins are protected with internal ESD protection diodes to the power supplies, as shown in [Figure 38](#).

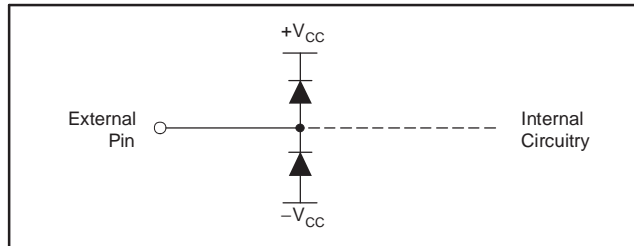

**Figure 38. Internal ESD Protection**

These diodes provide moderate protection to input overdrive voltages above the supplies as well. The protection diodes can typically support 30-mA continuous current. Use additional external low-capacitance protection where higher currents are possible.

- (1) Stresses beyond those listed under absolute maximum ratings may cause permanent damage to the device. These are stress ratings only, and functional operation of the device at these or any other conditions beyond those indicated under recommended operating conditions is not implied. Exposure to absolute-maximum-rated conditions for extended periods may affect device reliability.



## 7.4 Device Functional Modes

### 7.4.1 Gain Control

The device transimpedance gain is controlled with the CTRL pin. Setting the CTRL pin high results in selecting the high-gain configuration. Setting the CTRL pin low results in selecting the low-gain configuration, as described in [Table 1](#).

**Table 1. Gain Control Logic Table**

GAIN	CTRL (Pin 2)
5 k $\Omega$	Logic 0 (GND)
20 k $\Omega$	Logic 1 (+V <sub>S</sub> )

### 7.4.2 Test Mode

The OPA857 operates in normal mode when the input is driven by a photodiode. In test mode, the test structure described in the [Integrated Test Structure \(TEST\) Block](#) section is used to emulate a photodiode using a voltage input. [Table 2](#) describes how to configure the OPA857 in each mode.

**Table 2. Mode Configuration**

MODE	Test_IN PIN CONNECTED TO	Test_SD PIN CONNECTED TO
Normal mode	+V <sub>S</sub>	GND
Test mode	AC-coupled input using a series cap or dc-coupled signal on a 2.1-V (approx) offset voltage	+V <sub>S</sub>

Set an adequate dc voltage at the input to make sure that the output is operating within normal operation. At minimum, the output of the TIA block must be set to 5/9th of the supply voltage in preparation for a pulse configuration. For sine-wave operation, as required when measuring a frequency response, set the dc voltage on the OUT pin to allow the full sine-wave amplitude and avoid clipping. In such a case, the OUT pin voltage is set lower than 5/9th of the supply voltage.

Note that the 2-k $\Omega$  internal resistance used for the V-to-I conversion is not trimmed and can vary  $\pm 15\%$  with process. Therefore, the source must be capable of sourcing both dc and ac voltages to make sure that the output voltage swing is compliant with the class-A output stage of the TIA block. Any change in the test circuit configuration (such as gain change) requires a new calibration of the internal V-to-I converter.

Again if a photodiode is used, the internal V-to-I converter must be shut off completely. Failure to do so results in degraded performance and higher than normal quiescent current.

## 8 Application and Implementation

### NOTE

Information in the following applications sections is not part of the TI component specification, and TI does not warrant its accuracy or completeness. TI's customers are responsible for determining suitability of components for their purposes. Customers should validate and test their design implementation to confirm system functionality.

### 8.1 Application Information

The OPA857 is a transimpedance amplifier offering two selectable gains. This device is used in conjunction with a photodiode at its input. The output is pseudo differential and may or may not require the use of a fully differential amplifier, depending on the analog-to-digital converter (ADC) used for implementation.

The OPA857 requires a photodiode to be connected to the positive bias voltage because the output voltage can only swing down from the reference voltage (1.85 V for a 3.3-V supply) to ground.

### 8.2 Typical Application

#### 8.2.1 TIA With Associated Signal Chain

Figure 39 presents a complete end-to-end receive signal chain for an optical input. It includes a high-speed photodiode, the OPA857, a THS4541 fully-differential amplifier, and a 16-bit, 160-MSPS, high-speed ADC. For the complete wide-bandwidth, optical front-end reference design, go to <http://www.ti.com/tool/TIDA-00725>.

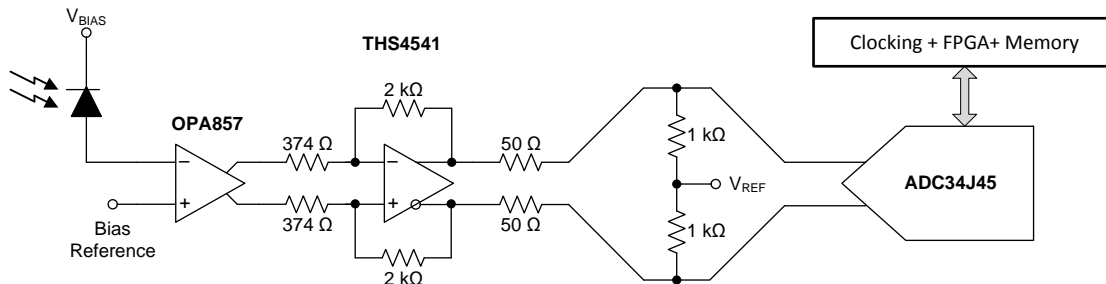

**Figure 39. TIA With Associated Signal Chain**

## Typical Application (continued)

### 8.2.1.1 Design Requirements

For this example, use the values listed in [Table 3](#) for the input parameters.

**Table 3. Design Parameters**

DESIGN PARAMETER	EXAMPLE VALUE
Supply voltage	5-V external supply
Analog bandwidth	120 MHz
ADC sampling rate	160 MSPS
Maximum system gain	100 k $\Omega$
Programmable transimpedance gain	5 k $\Omega$ / 20 k $\Omega$
Maximum signal swing	1 V <sub>PP</sub>
Noise performance	$\geq$ 60-dB SNR
Averaged noise performance	< 10- $\mu$ V <sub>RMS</sub>

### 8.2.1.2 Detailed Design Procedure

1. Use a high-speed, low input capacitance photodiode, such as the NR7500 or NR8300, as the front-end optical sensor. Take care during layout to minimize parasitic capacitance added because of the PCB.
2. Bias the photodiode with the cathode connected to a positive supply, and the anode connected to IN pin of the OPA857. These connections make sure that the photodiode sources an output current that results in the OPA857 output swinging down below the reference voltage =  $(5 / 9) \times 3.3 \text{ V} = 1.83 \text{ V}$ .
3. Disable the OPA857 test mode by setting Test\_IN = +V<sub>S</sub> and Test\_SD = GND. The transimpedance gain is selected by setting CTRL = +V<sub>S</sub> (gain = 20 k $\Omega$ ) or CTRL = GND (gain = 5 k $\Omega$ ).
4. The THS4541 is configured in a gain of 5 V/V in order to achieve a maximum signal transimpedance gain of 100 k $\Omega$ . It is important to carefully select the value of the RG gain resistors for the THS4541.
5. Setting RG very low increases the resistive loading on the previous OPA857 output stage, and reduces the bandwidth of the OPA857.
6. Setting R<sub>G</sub> very high results in a large value of feedback resistance, R<sub>F</sub>, on the THS4541 in order to achieve the desired 5V/V gain. R<sub>F</sub> interacts with the input capacitance of the THS4541 to create a zero in the noise-gain response of the amplifier, and if not properly compensated, results in reduced phase-margin and potential instability.
7. A value of R<sub>G</sub> = 374  $\Omega$  was selected that results in a total differential load of 798  $\Omega$  on the OPA857. The resultant R<sub>F</sub> = 2 k $\Omega$ .
8. The response to an optical pulsed input is shown in [Figure 40](#) to [Figure 43](#). To prevent signal reflections between the THS4541 output and the ADC34J45 input, the signal is doubly terminated through 50- $\Omega$  resistors. If the THS4541 and ADC34J45 are physically close together on the PCB, then the double-termination is eliminated, which increases the overall gain of the signal chain without affecting the transient response of the system. These results were verified, and the complete data is available in reference design TIDA-00725.
9. An optional antialiasing filter can be added between the THS4541 and the ADC34J45 to reduce system noise caused by aliasing.

8.2.1.3 Application Curves

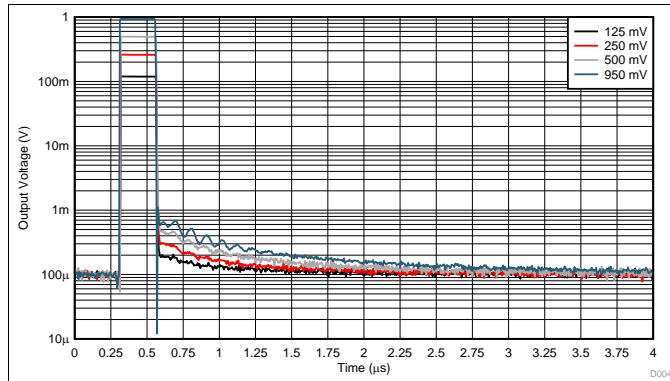

$T_Z$  Gain = 20 k $\Omega$

Figure 40. Pulse Response vs Output Voltage

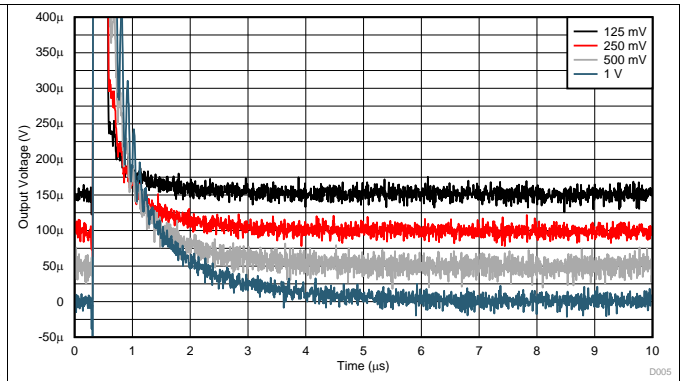

$T_Z$  Gain = 20 k $\Omega$

Figure 41. Long-Term Settling Response vs Output Voltage

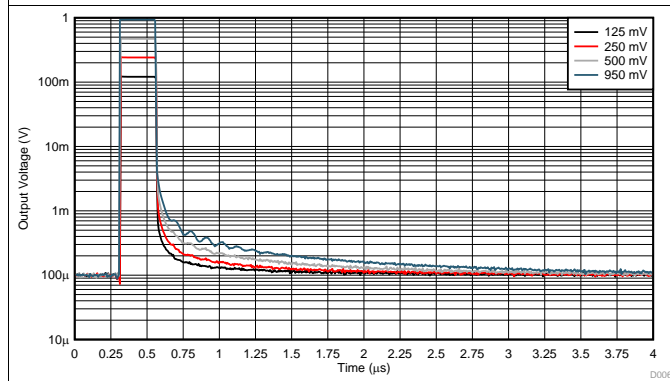

$T_Z$  Gain = 5 k $\Omega$

Figure 42. Pulse Response vs Output Voltage

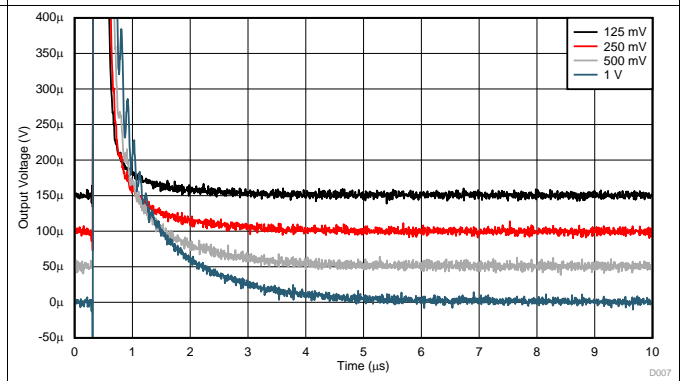

$T_Z$  Gain = 5 k $\Omega$

Figure 43. Long-Term Settling Response vs Output Voltage

### 8.2.2 Extending Transimpedance Bandwidth

At the core of the OPA857 is an ultrawide bandwidth op amp. One of the highlights of the OPA857 is the relatively small change in the transimpedance bandwidth as a function of the internal gain selected; 130 MHz (gain = 5 kΩ) and 105 MHz (gain = 20 kΩ). Theoretically, for a four times increase in gain, the bandwidth should reduce by two times; however, as observed in the case of the OPA857, the results do not follow theory. For more information on the various factors that contribute to an amplifier frequency-response performance when configured as a TIA, see [What You Need To Know About Transimpedance Amplifiers – Part 1](#) on the TI E2E Community website at e2e.ti.com. This blog also contains a reference to an excel calculator to simplify TIA designs when using discrete opamps. The OPA857 is unique in displaying this type of behavior because the CTRL logic controls an internal switch in the amplifier core that recompensates the amplifier open-loop gain characteristic depending upon the logic level. In this application, it is shown how the closed-loop transimpedance bandwidth can be increased to greater than 250 MHz. The circuit used for this test is shown in [Figure 44](#). An external feedback resistor,  $R_F$ , is added in parallel to the internal transimpedance gain resistors of the OPA857. This resistor has the effect of reducing the overall transimpedance gain, but with increased bandwidth.

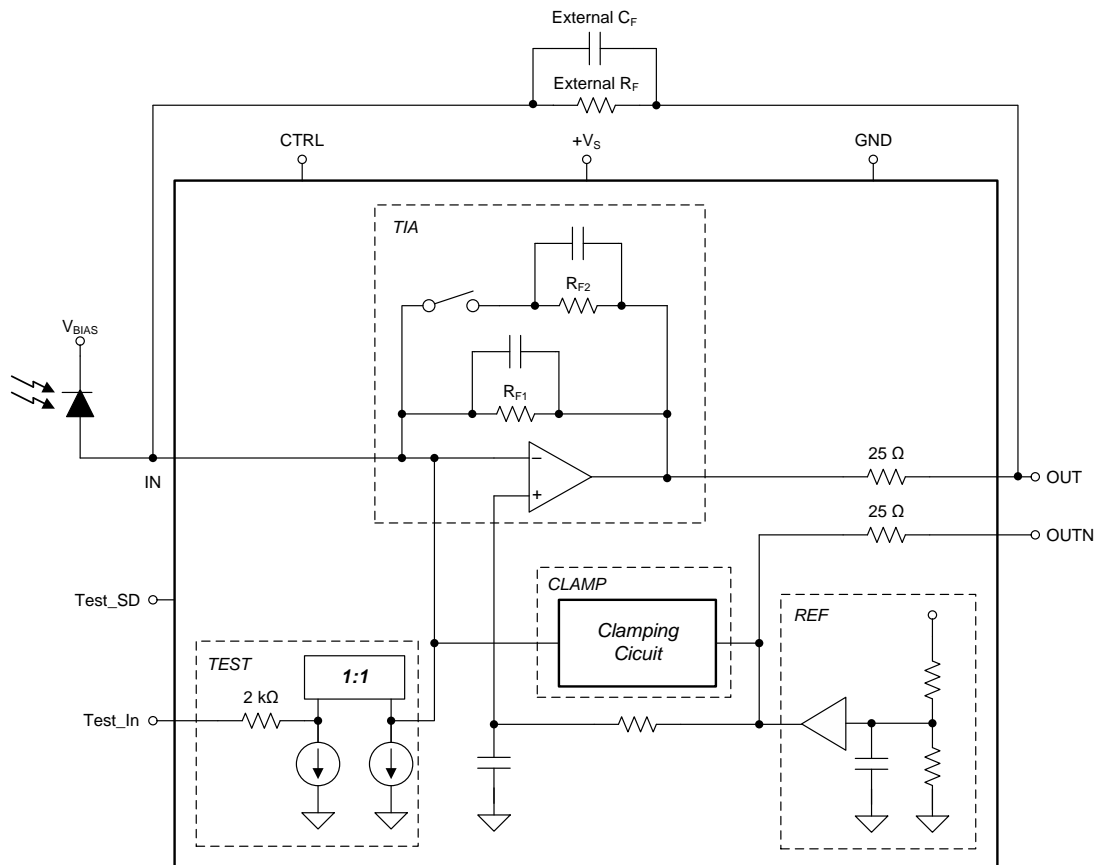

Figure 44. Extending Transimpedance Bandwidth

#### 8.2.2.1 Design Requirements

For this example, use the values listed in [Table 4](#) for the input parameters.

Table 4. Design Parameters

DESIGN PARAMETER	EXAMPLE VALUE
Supply voltage	3.3 V
Output swing	500 mV <sub>PP</sub>
Differential output load	500 kΩ and 1 kΩ
Target bandwidth	250 MHz
Effective transimpedance gain	5 kΩ

### 8.2.2.2 Application Curves

Figure 45 shows the frequency response with a feedback resistance of 6.8 kΩ and an output load of 500 Ω. The large amount of peaking indicates a low phase-margin and potential instability. Next, a 0.1-pF feedback capacitor,  $C_F$ , is added in parallel to the 6.8-kΩ  $R_F$ . Both  $R_F$  and  $C_F$  interact to create pole in the noise gain curve that counteracts the effect of the zero caused by  $R_F$ , and the total input capacitance at pin IN of the OPA857. The input capacitance is caused by the opamps inherent input capacitance, the photodiode capacitance, and the parasitic input capacitance from the PCB. The pole zero cancellation increases the phase margin, as is evident in the reduced peaking shown in Figure 46. In Figure 47, an output load of 1 kΩ was used, along with an  $R_F = 6.8$  kΩ and  $C_F = 0.1$  pF. The reduced load helps to increase the op amp open-loop gain, which in turn increases the closed-loop bandwidth of the OPA857 circuit.

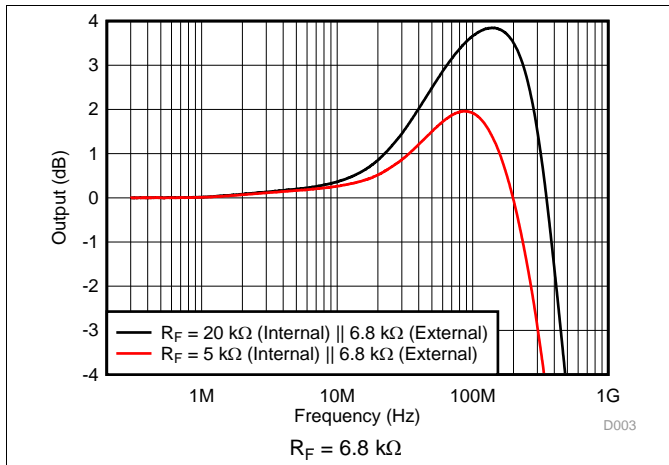

Figure 45. Frequency Response With External Feedback

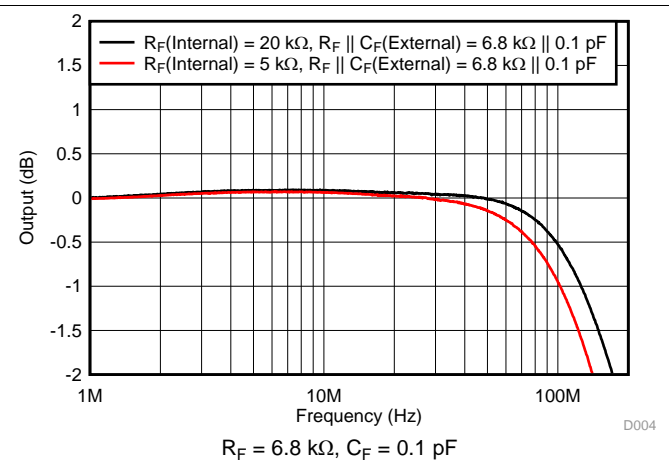

Figure 46. Frequency Response With External Feedback

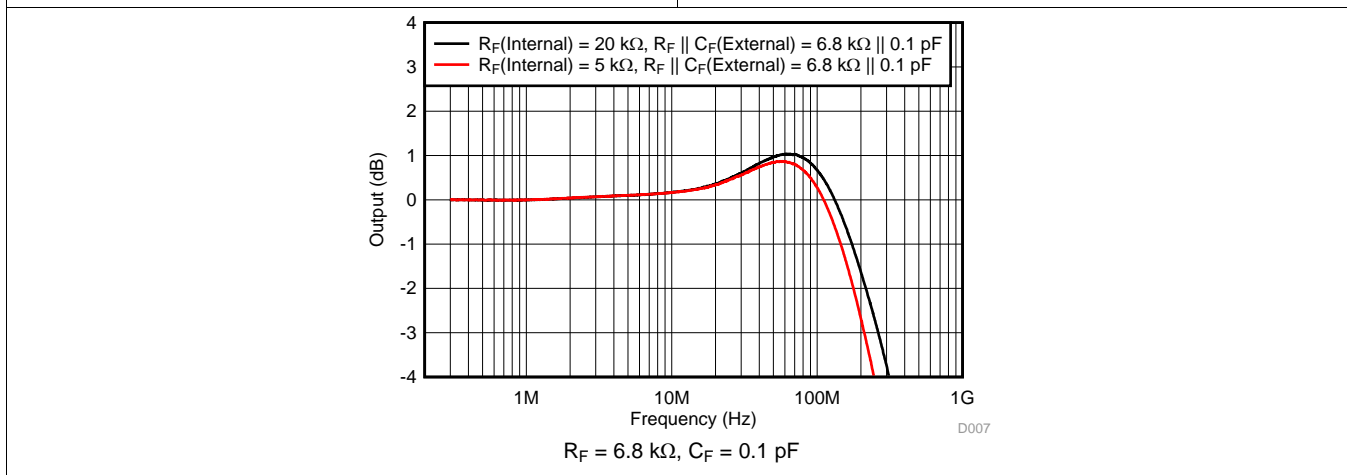

Figure 47. Frequency Response With External Feedback

## 9 Power-Supply Recommendations

Use a linear power supply with good PSRR. For a good, high-frequency, power-supply bypass, use a ceramic capacitor connected as close as possible to the  $+V_S$  pin.

## 10 Layout

### 10.1 Layout Guidelines

Achieving optimum performance with a high-frequency amplifier such as the OPA857 requires careful attention to board layout parasitics and external component types. Recommendations that optimize performance include:

- a. **Minimize parasitic capacitance** to any ac ground for all signal I/O pins. Parasitic capacitance on the inverting input pin can cause instability. To reduce unwanted capacitance, open a window around the signal I/O pins in all ground and power planes around those pins. Otherwise, make sure that ground and power planes are unbroken elsewhere on the board.
- b. **Minimize the distance** ( $< 0.25"$ ) from the power-supply pins to high-frequency 0.1- $\mu\text{F}$  decoupling capacitors, as shown in [Figure 48](#). At the device pins, make sure that the ground and power-plane layout are not in close proximity to the signal I/O pins. Avoid narrow power and ground traces to minimize inductance between the pins and decoupling capacitors. Always decouple the power-supply connections with these capacitors. An optional supply decoupling capacitor (0.1  $\mu\text{F}$ ) across the two power supplies (for bipolar operation) improves second-harmonic distortion performance. Use larger (2.2  $\mu\text{F}$  to 6.8  $\mu\text{F}$ ) decoupling capacitors, effective at lower frequencies, on the main supply pins. These capacitors can be placed somewhat farther from the device and can be shared among several devices in the same area of the PC board.
- c. **Careful selection and placement of external components preserves the high-frequency performance of the OPA857.** Use very low reactance type resistors. Surface-mount resistors function best and allow a tighter overall layout. Metal-film or carbon composition, axially-leaded resistors also provide good high-frequency performance. Again, keep the leads and PC board traces as short as possible. Never use wirewound type resistors in a high-frequency application.
- d. **Connections to other wideband devices** on the board can be made with short, direct traces or through onboard transmission lines. For short connections, consider the trace and the input to the next device as a lumped capacitive load. Use relatively wide traces (50 mils to 100 mils), preferably with ground and power planes opened up around them.
- e. **Do not socket a high-speed part such as the OPA857.** The additional lead length and pin-to-pin capacitance introduced by the socket can create an extremely troublesome parasitic network that makes achieving a smooth, stable frequency response almost impossible. Best results are obtained by soldering the OPA857 onto the board.

## 10.2 Layout Example

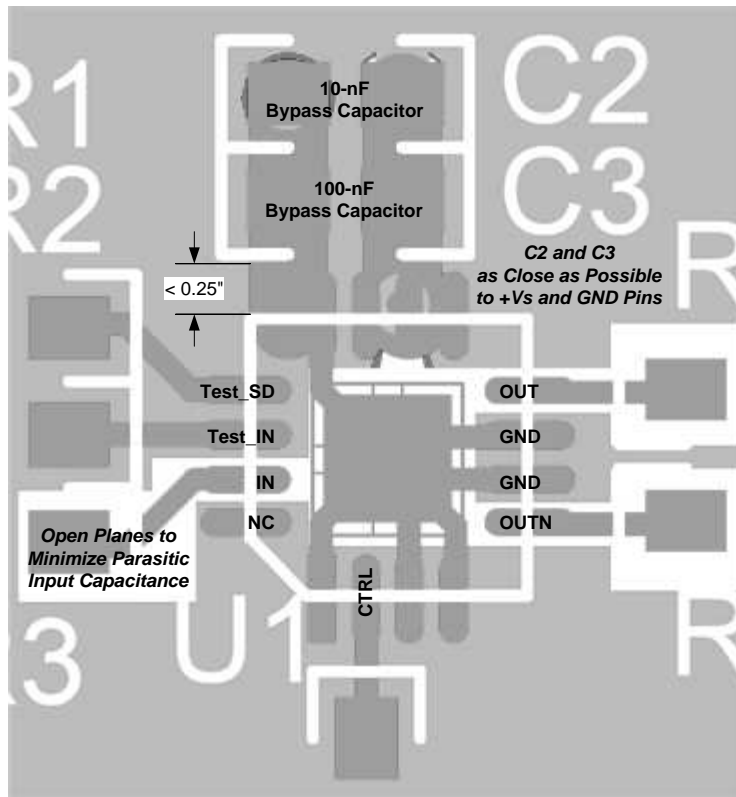

**Figure 48. Layout Example**



## 11 Device and Documentation Support

### 11.1 Device Support

#### 11.1.1 Development Support

##### 11.1.1.1 Evaluation Module

An evaluation module (EVM) is available to assist in the initial circuit performance evaluation using the OPA857. The summary information for this fixture is shown in [Table 5](#).

**Table 5. EVM Ordering Information**

PRODUCT	PACKAGE	ORDERING NUMBER	LITERATURE NUMBER
OPA857IRGT	RGT	OPA857EVM	<a href="#">SBOU138</a>

The EVM can be requested at the Texas Instruments web site ([www.ti.com](http://www.ti.com)) through the [OPA857 product folder](#).

##### 11.1.1.2 Spice Model

Computer simulation of circuit performance using spice is often useful when analyzing the performance of analog circuits and systems. The previous statement is particularly true for transimpedance applications where parasitic capacitance and inductance can have a major effect on circuit performance. A spice model for the OPA857 is available through the [OPA857 product folder](#) under simulation models. These models do a good job of predicting small-signal ac and transient performance under a wide variety of operating conditions. These models, however, do not do as well in predicting harmonic distortion.

### 11.2 Documentation Support

#### 11.2.1 Related Documentation

For related documentation, see the following:

- [OPA857EVM Evaluation Module](#) (SBOU138)
- [Transimpedance Considerations for High-speed Amplifiers](#) (SBOA122)
- [Wide Bandwidth Optical Front-end Reference Design](#) (TIDUAZ1)
- [Reference Design for Extending the OPA857 Transimpedance Bandwidth](#) (TIDUBX7)
- Learn how to compensate transimpedance amplifiers intuitively in:  
[What You Need To Know About Transimpedance Amplifiers – Part 1](#) (Cherian 2016)

#### 11.3 Receiving Notification of Documentation Updates

To receive notification of documentation updates, navigate to the device product folder on [ti.com](http://ti.com). In the upper right corner, click on *Alert me* to register and receive a weekly digest of any product information that has changed. For change details, review the revision history included in any revised document.

### 11.4 Community Resources

The following links connect to TI community resources. Linked contents are provided "AS IS" by the respective contributors. They do not constitute TI specifications and do not necessarily reflect TI's views; see TI's [Terms of Use](#).

**TI E2E™ Online Community** *TI's Engineer-to-Engineer (E2E) Community*. Created to foster collaboration among engineers. At [e2e.ti.com](http://e2e.ti.com), you can ask questions, share knowledge, explore ideas and help solve problems with fellow engineers.

**Design Support** *TI's Design Support* Quickly find helpful E2E forums along with design support tools and contact information for technical support.

### 11.5 Trademarks

E2E is a trademark of Texas Instruments.

All other trademarks are the property of their respective owners.

## 11.6 Electrostatic Discharge Caution



This integrated circuit can be damaged by ESD. Texas Instruments recommends that all integrated circuits be handled with appropriate precautions. Failure to observe proper handling and installation procedures can cause damage.

ESD damage can range from subtle performance degradation to complete device failure. Precision integrated circuits may be more susceptible to damage because very small parametric changes could cause the device not to meet its published specifications.

## 11.7 Glossary

[SLYZ022](#) — *TI Glossary*.

This glossary lists and explains terms, acronyms, and definitions.

## 12 Mechanical, Packaging, and Orderable Information

The following pages include mechanical packaging and orderable information. This information is the most current data available for the designated devices. This data is subject to change without notice and revision of this document. For browser-based versions of this data sheet, refer to the left-hand navigation.

**PACKAGING INFORMATION**

Orderable Device	Status (1)	Package Type	Package Drawing	Pins	Package Qty	Eco Plan (2)	Lead finish/ Ball material (6)	MSL Peak Temp (3)	Op Temp (°C)	Device Marking (4/5)	Samples
OPA857IRGTR	ACTIVE	VQFN	RGT	16	3000	RoHS & Green	NIPDAU	Level-2-260C-1 YEAR	-40 to 85	OPA857	<a href="#">Samples</a>
OPA857IRGTT	ACTIVE	VQFN	RGT	16	250	RoHS & Green	NIPDAU	Level-2-260C-1 YEAR	-40 to 85	OPA857	<a href="#">Samples</a>

(1) The marketing status values are defined as follows:

**ACTIVE:** Product device recommended for new designs.

**LIFEBUY:** TI has announced that the device will be discontinued, and a lifetime-buy period is in effect.

**NRND:** Not recommended for new designs. Device is in production to support existing customers, but TI does not recommend using this part in a new design.

**PREVIEW:** Device has been announced but is not in production. Samples may or may not be available.

**OBsolete:** TI has discontinued the production of the device.

(2) **RoHS:** TI defines "RoHS" to mean semiconductor products that are compliant with the current EU RoHS requirements for all 10 RoHS substances, including the requirement that RoHS substance do not exceed 0.1% by weight in homogeneous materials. Where designed to be soldered at high temperatures, "RoHS" products are suitable for use in specified lead-free processes. TI may reference these types of products as "Pb-Free".

**RoHS Exempt:** TI defines "RoHS Exempt" to mean products that contain lead but are compliant with EU RoHS pursuant to a specific EU RoHS exemption.

**Green:** TI defines "Green" to mean the content of Chlorine (Cl) and Bromine (Br) based flame retardants meet JS709B low halogen requirements of <=1000ppm threshold. Antimony trioxide based flame retardants must also meet the <=1000ppm threshold requirement.

(3) MSL, Peak Temp. - The Moisture Sensitivity Level rating according to the JEDEC industry standard classifications, and peak solder temperature.

(4) There may be additional marking, which relates to the logo, the lot trace code information, or the environmental category on the device.

(5) Multiple Device Markings will be inside parentheses. Only one Device Marking contained in parentheses and separated by a "~" will appear on a device. If a line is indented then it is a continuation of the previous line and the two combined represent the entire Device Marking for that device.

(6) Lead finish/Ball material - Orderable Devices may have multiple material finish options. Finish options are separated by a vertical ruled line. Lead finish/Ball material values may wrap to two lines if the finish value exceeds the maximum column width.

**Important Information and Disclaimer:**The information provided on this page represents TI's knowledge and belief as of the date that it is provided. TI bases its knowledge and belief on information provided by third parties, and makes no representation or warranty as to the accuracy of such information. Efforts are underway to better integrate information from third parties. TI has taken and continues to take reasonable steps to provide representative and accurate information but may not have conducted destructive testing or chemical analysis on incoming materials and chemicals. TI and TI suppliers consider certain information to be proprietary, and thus CAS numbers and other limited information may not be available for release.

In no event shall TI's liability arising out of such information exceed the total purchase price of the TI part(s) at issue in this document sold by TI to Customer on an annual basis.



**TAPE AND REEL INFORMATION**

**QUADRANT ASSIGNMENTS FOR PIN 1 ORIENTATION IN TAPE**

\*All dimensions are nominal

Device	Package Type	Package Drawing	Pins	SPQ	Reel Diameter (mm)	Reel Width W1 (mm)	A0 (mm)	B0 (mm)	K0 (mm)	P1 (mm)	W (mm)	Pin1 Quadrant
OPA857IRGTR	VQFN	RGT	16	3000	330.0	12.4	3.3	3.3	1.1	8.0	12.0	Q2
OPA857IRGTT	VQFN	RGT	16	250	180.0	12.4	3.3	3.3	1.1	8.0	12.0	Q2

**TAPE AND REEL BOX DIMENSIONS**

\*All dimensions are nominal

Device	Package Type	Package Drawing	Pins	SPQ	Length (mm)	Width (mm)	Height (mm)
OPA857IRGTR	VQFN	RGT	16	3000	346.0	346.0	33.0
OPA857IRGTT	VQFN	RGT	16	250	210.0	185.0	35.0

**RGT 16**

**GENERIC PACKAGE VIEW**

**VQFN - 1 mm max height**

PLASTIC QUAD FLATPACK - NO LEAD

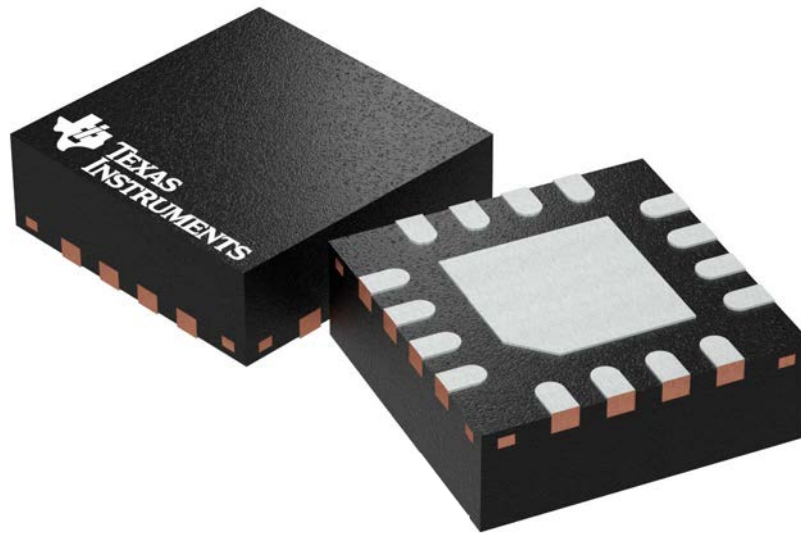

Images above are just a representation of the package family, actual package may vary.  
Refer to the product data sheet for package details.

4203495/1

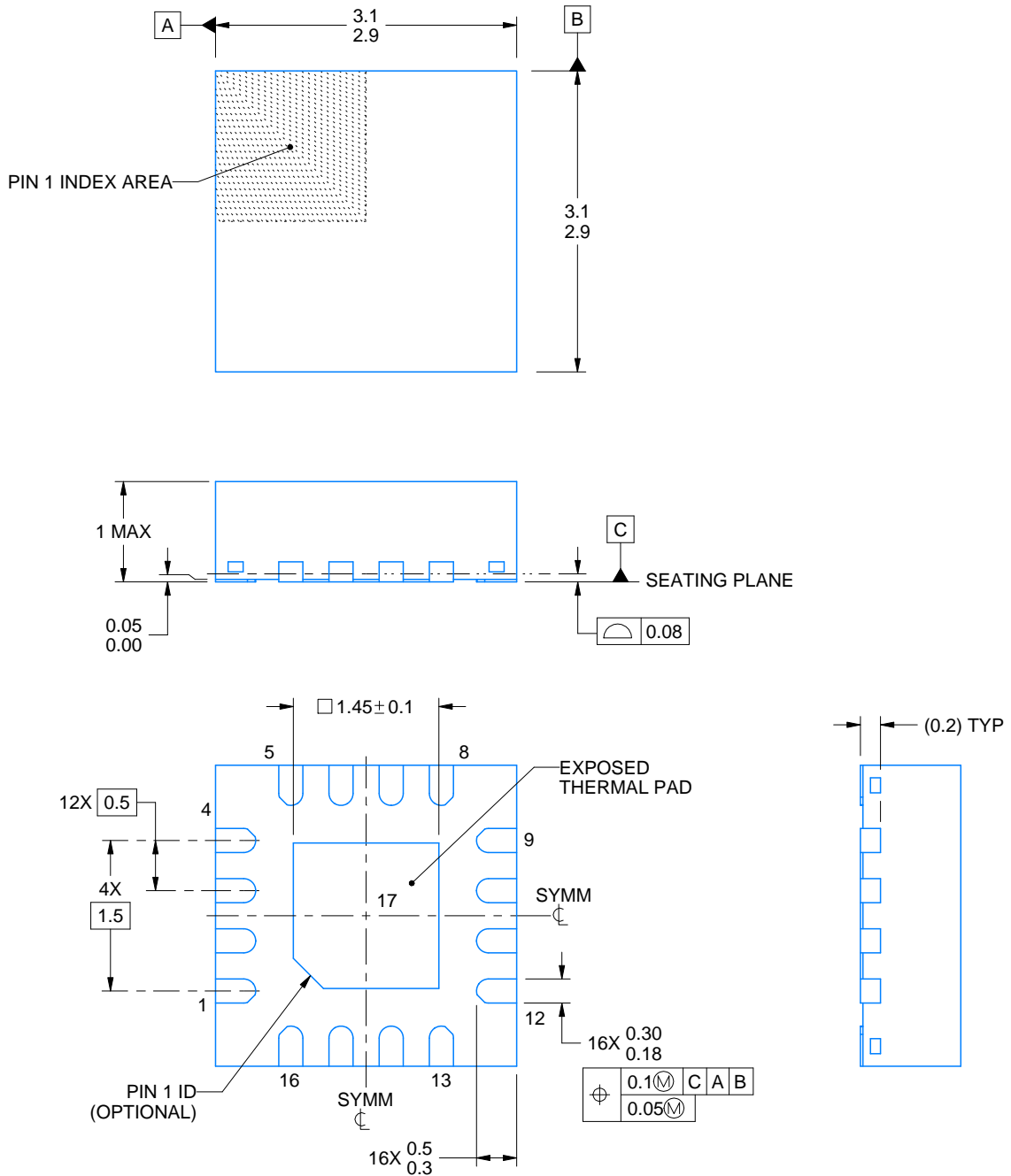
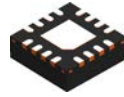

4219032/A 02/2017

NOTES:

1. All linear dimensions are in millimeters. Any dimensions in parenthesis are for reference only. Dimensioning and tolerancing per ASME Y14.5M.
2. This drawing is subject to change without notice.
3. The package thermal pad must be soldered to the printed circuit board for thermal and mechanical performance.
4. Reference JEDEC registration MO-220



# EXAMPLE BOARD LAYOUT

RGT0016A

VQFN - 1 mm max height

PLASTIC QUAD FLATPACK - NO LEAD

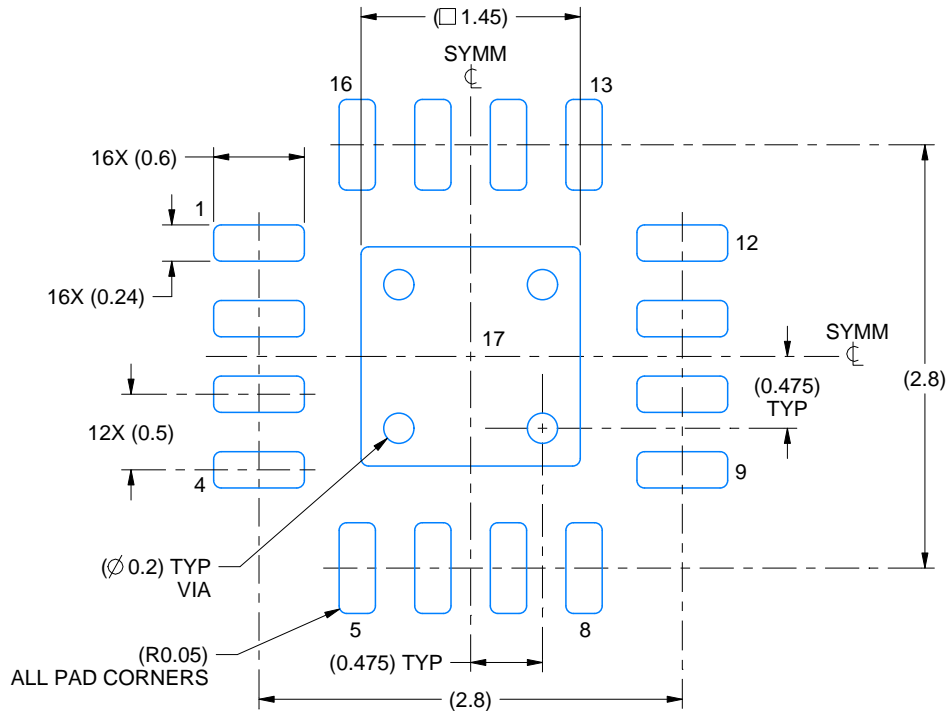

LAND PATTERN EXAMPLE  
EXPOSED METAL SHOWN  
SCALE:20X

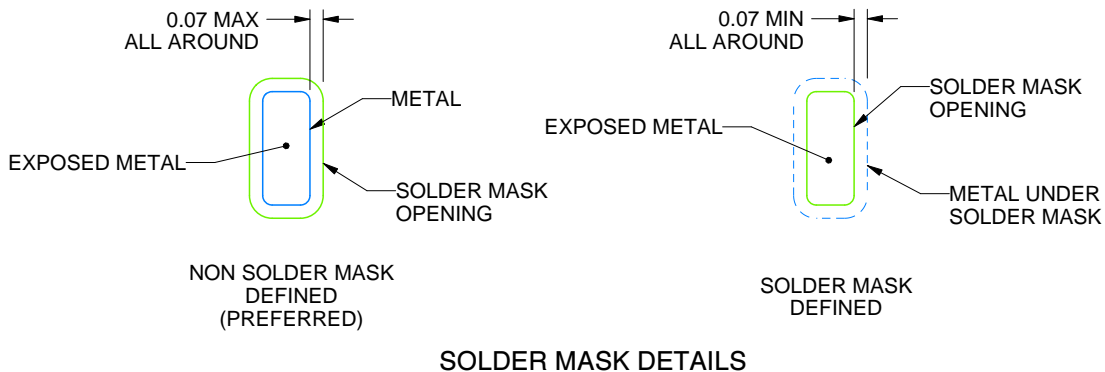

SOLDER MASK DETAILS

4219032/A 02/2017

NOTES: (continued)

5. This package is designed to be soldered to a thermal pad on the board. For more information, see Texas Instruments literature number SLUA271 ([www.ti.com/lit/slua271](http://www.ti.com/lit/slua271)).
6. Vias are optional depending on application, refer to device data sheet. If any vias are implemented, refer to their locations shown on this view. It is recommended that vias under paste be filled, plugged or tented.

# EXAMPLE STENCIL DESIGN

RGT0016A

VQFN - 1 mm max height

PLASTIC QUAD FLATPACK - NO LEAD

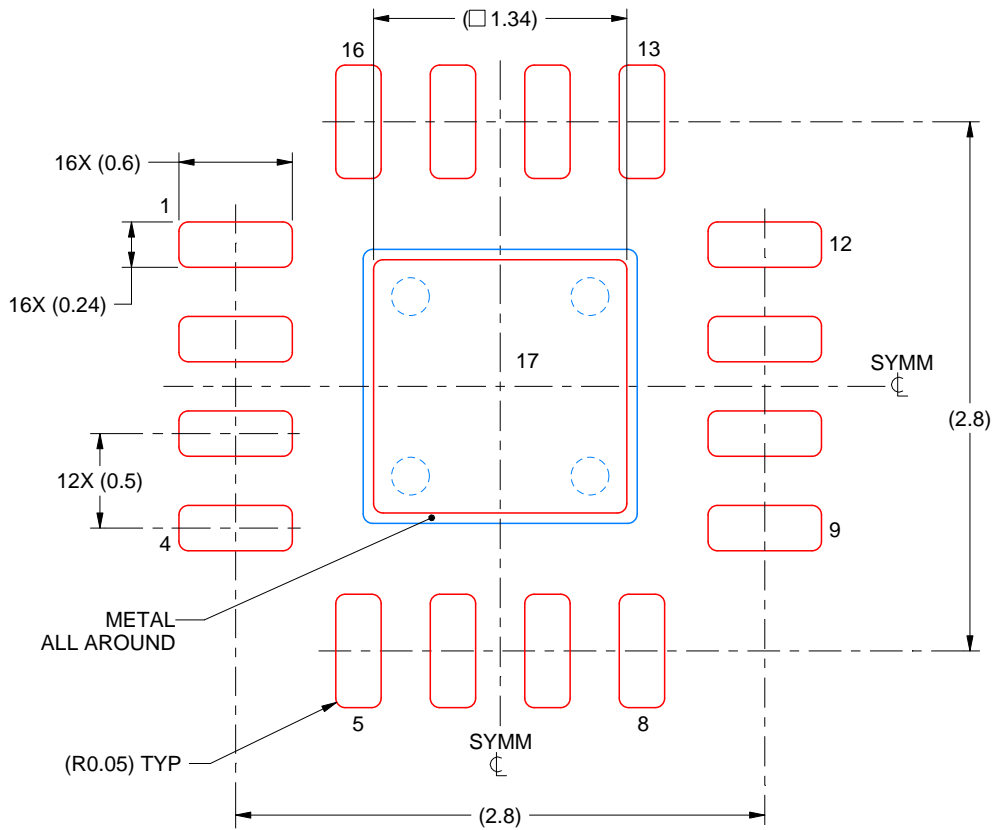

**SOLDER PASTE EXAMPLE**  
BASED ON 0.125 mm THICK STENCIL

EXPOSED PAD 17:  
86% PRINTED SOLDER COVERAGE BY AREA UNDER PACKAGE  
SCALE:25X

4219032/A 02/2017

NOTES: (continued)

7. Laser cutting apertures with trapezoidal walls and rounded corners may offer better paste release. IPC-7525 may have alternate design recommendations.

## IMPORTANT NOTICE AND DISCLAIMER

TI PROVIDES TECHNICAL AND RELIABILITY DATA (INCLUDING DATA SHEETS), DESIGN RESOURCES (INCLUDING REFERENCE DESIGNS), APPLICATION OR OTHER DESIGN ADVICE, WEB TOOLS, SAFETY INFORMATION, AND OTHER RESOURCES "AS IS" AND WITH ALL FAULTS, AND DISCLAIMS ALL WARRANTIES, EXPRESS AND IMPLIED, INCLUDING WITHOUT LIMITATION ANY IMPLIED WARRANTIES OF MERCHANTABILITY, FITNESS FOR A PARTICULAR PURPOSE OR NON-INFRINGEMENT OF THIRD PARTY INTELLECTUAL PROPERTY RIGHTS.

These resources are intended for skilled developers designing with TI products. You are solely responsible for (1) selecting the appropriate TI products for your application, (2) designing, validating and testing your application, and (3) ensuring your application meets applicable standards, and any other safety, security, regulatory or other requirements.

These resources are subject to change without notice. TI grants you permission to use these resources only for development of an application that uses the TI products described in the resource. Other reproduction and display of these resources is prohibited. No license is granted to any other TI intellectual property right or to any third party intellectual property right. TI disclaims responsibility for, and you will fully indemnify TI and its representatives against, any claims, damages, costs, losses, and liabilities arising out of your use of these resources.

TI's products are provided subject to [TI's Terms of Sale](#) or other applicable terms available either on [ti.com](https://www.ti.com) or provided in conjunction with such TI products. TI's provision of these resources does not expand or otherwise alter TI's applicable warranties or warranty disclaimers for TI products.

TI objects to and rejects any additional or different terms you may have proposed.

Mailing Address: Texas Instruments, Post Office Box 655303, Dallas, Texas 75265  
Copyright © 2023, Texas Instruments Incorporated