

STEREO AUDIO CODEC WITH USB INTERFACE, SINGLE-ENDED ANALOG INPUT/OUTPUT, AND S/PDIF

FEATURES

- **On-Chip USB Interface:**
 - With Full-Speed Transceivers
 - Fully Compliant with USB 2.0 Specification
 - Certified by USB-IF
 - Partially Programmable Descriptors ⁽¹⁾
 - USB Adaptive Mode for Playback
 - USB Asynchronous Mode for Record
 - Bus Powered
- **16-Bit Delta-Sigma ADC and DAC**
- **Sampling Rate:**
 - DAC: 32, 44.1, 48 kHz
 - ADC: 8, 11.025, 16, 22.05, 32, 44.1, 48 kHz
- **On-Chip Clock Generator with Single 12-MHz Clock Source**
- **S/PDIF Input/Output**
- **Single Power Supply:**
 - 5 V Typical (V_{BUS})
- **Stereo ADC:**
 - Analog Performance at $V_{BUS} = 5\text{ V}$:
 - THD+N = 0.01%
 - SNR = 89 dB
 - Dynamic Range = 89 dB
 - Decimation Digital Filter:
 - Passband Ripple = $\pm 0.05\text{ dB}$
 - Stop-Band Attenuation = -65 dB
 - Single-Ended Voltage Input
 - Antialiasing Filter Included
 - Digital HPF Included

- **Stereo DAC:**
 - Analog Performance at $V_{BUS} = 5\text{ V}$:
 - THD+N = 0.005%
 - SNR = 96 dB
 - Dynamic Range = 93 dB
 - Oversampling Digital Filter:
 - Passband Ripple = $\pm 0.1\text{ dB}$
 - Stop-Band Attenuation = -43 dB
 - Single-Ended Voltage Output
 - Analog LPF Included
- **Multifunctions:**
 - Human Interface Device (HID) Function:
 - Volume and Mute Controls
 - Suspend Flag Function
- **28-Pin SSOP Package**

APPLICATIONS

- **USB Audio Speaker**
- **USB Headset**
- **USB Monitor**
- **USB Audio Interface Box**

DESCRIPTION

The PCM2906B is Texas Instruments' single-chip, USB, stereo audio codec with a USB-compliant full-speed protocol controller and S/PDIF. The USB protocol controller requires no software code, but the USB descriptors can be modified in some areas (for example, vendor ID and/or product ID). The PCM2906B employs SpAct™ architecture, TI's unique system that recovers the audio clock from USB packet data. On-chip analog PLLs with SpAct enable playback and record with low clock jitter as well as independent playback and record sampling rates.

(1) The descriptor can be modified by changing a mask.



Please be aware that an important notice concerning availability, standard warranty, and use in critical applications of Texas Instruments semiconductor products and disclaimers thereto appears at the end of this data sheet.

SpAct is a trademark of Texas Instruments.

System Two, Audio Precision are trademarks of Audio Precision, Inc.

All other trademarks are the property of their respective owners.



This integrated circuit can be damaged by ESD. Texas Instruments recommends that all integrated circuits be handled with appropriate precautions. Failure to observe proper handling and installation procedures can cause damage.

ESD damage can range from subtle performance degradation to complete device failure. Precision integrated circuits may be more susceptible to damage because very small parametric changes could cause the device not to meet its published specifications.

PACKAGING/ORDERING INFORMATION⁽¹⁾

| PRODUCT | PACKAGE-LEAD | PACKAGE DESIGNATOR | SPECIFIED TEMPERATURE RANGE | PACKAGE MARKING | ORDERING NUMBER | TRANSPORT MEDIA, QUANTITY |
|------------|--------------|--------------------|-----------------------------|-----------------|-----------------|---------------------------|
| PCM2906BDB | SSOP-28 | DB | –25°C to +85°C | PCM2906B | PCM2906BDB | Rails, 47 |
| | | | | | PCM2906BDBR | Tape and Reel, 2000 |

(1) For the most current package and ordering information, see the Package Option Addendum at the end of this document, or see the TI website at www.ti.com.

ABSOLUTE MAXIMUM RATINGS⁽¹⁾

Over operating free-air temperature range (unless otherwise noted).

| PARAMETER | | PCM2906B | UNIT |
|--|---|--------------------------------|------|
| Supply voltage, V_{BUS} | | –0.3 to 6.5 | V |
| Ground voltage differences, AGNDC, AGNDP, AGNDX, DGND, DGNDU | | ±0.1 | V |
| Digital input voltage | SEL0, SEL1, DIN | –0.3 to 6.5 | V |
| | D+, D–, HID0, HID1, HID2, XTI, XTO, DOUT, \overline{SSPND} | –0.3 to $(V_{DDI} + 0.3) < 4$ | |
| Analog input voltage | V_{INL} , V_{INR} , V_{COM} , V_{OUTR} , V_{OUTL} | –0.3 to $(V_{CCCI} + 0.3) < 4$ | V |
| | V_{CCCI} , V_{CCP1I} , V_{CCP2I} , V_{CCXI} , V_{DDI} | –0.3 to 4 | |
| Input current (any pins except supplies) | | ±10 | mA |
| Ambient temperature under bias | | –40 to +125 | °C |
| Storage temperature, T_{stg} | | –55 to +150 | °C |
| Junction temperature, T_J | | +150 | °C |
| Lead temperature (soldering, 5s) | | +260 | °C |
| Package temperature (IR reflow, peak) | | +250 | °C |

(1) Stresses beyond those listed under *Absolute Maximum Ratings* may cause permanent damage to the device. These are stress ratings only, and functional operation of the device at these or any other conditions beyond those indicated under is not implied. Exposure to absolute-maximum-rated conditions for extended periods may affect device reliability.

ELECTRICAL CHARACTERISTICS

 All specifications at $T_A = +25^\circ\text{C}$, $V_{\text{BUS}} = 5\text{ V}$, $f_S = 44.1\text{ kHz}$, $f_{\text{IN}} = 1\text{ kHz}$, and 16-bit data (unless otherwise noted).

| PARAMETER | TEST CONDITIONS | PCM2906B | | | UNIT | |
|-----------------------------|------------------------------------|--------------------------------|--------------------------------|--------|----------|------|
| | | MIN | TYP | MAX | | |
| DIGITAL INPUT/OUTPUT | | | | | | |
| Host interface | Apply USB Revision 2.0, full speed | | | | | |
| Audio data format | USB isochronous data format | | | | | |
| INPUT LOGIC | | | | | | |
| $V_{\text{IH}}^{(1)}$ | Input logic level | | 2 | | VDC | |
| $V_{\text{IL}}^{(1)}$ | | | | 3.3 | | |
| $V_{\text{IH}}^{(2)(3)}$ | | | 2.52 | | | 3.3 |
| $V_{\text{IL}}^{(2)(3)}$ | | | | | | 0.9 |
| $V_{\text{IH}}^{(4)}$ | | | 2 | | | 5.25 |
| $V_{\text{IL}}^{(4)}$ | | | | | | 0.8 |
| $V_{\text{IH}}^{(5)}$ | | | 2.52 | | | 5.25 |
| $V_{\text{IL}}^{(5)}$ | | | | | | 0.9 |
| $I_{\text{IH}}^{(1)(2)(4)}$ | | Input logic current | $V_{\text{IN}} = 3.3\text{ V}$ | | | |
| $I_{\text{IL}}^{(1)(2)(4)}$ | $V_{\text{IN}} = 0\text{ V}$ | | | | ± 10 | |
| $I_{\text{IH}}^{(3)}$ | $V_{\text{IN}} = 3.3\text{ V}$ | | | 50 | 80 | |
| $I_{\text{IL}}^{(3)}$ | $V_{\text{IN}} = 0\text{ V}$ | | | | ± 10 | |
| $I_{\text{IH}}^{(5)}$ | $V_{\text{IN}} = 3.3\text{ V}$ | | | 65 | 100 | |
| $I_{\text{IL}}^{(5)}$ | $V_{\text{IN}} = 0\text{ V}$ | | | | ± 10 | |
| OUTPUT LOGIC | | | | | | |
| $V_{\text{OH}}^{(1)}$ | Output logic level | | 2.8 | | VDC | |
| $V_{\text{OL}}^{(1)}$ | | | | | | 0.3 |
| $V_{\text{OH}}^{(6)}$ | | $I_{\text{OH}} = -4\text{ mA}$ | 2.8 | | | |
| $V_{\text{OL}}^{(6)}$ | | $I_{\text{OL}} = 4\text{ mA}$ | | | | 0.5 |
| $V_{\text{OH}}^{(7)}$ | | $I_{\text{OH}} = -2\text{ mA}$ | 2.8 | | | |
| $V_{\text{OL}}^{(7)}$ | | $I_{\text{OL}} = 2\text{ mA}$ | | | | 0.5 |
| CLOCK FREQUENCY | | | | | | |
| Input clock frequency, XTI | | 11.994 | 12 | 12.006 | MHz | |

- (1) Pins 1, 2: D+, D–.
- (2) Pin 21: XTI.
- (3) Pins 5, 6, 7: HID0, HID1, HID2.
- (4) Pins 8, 9: SEL0, SEL1.
- (5) Pin 24: DIN.
- (6) Pin 25: DOUT.
- (7) Pin 28: SSPND.

ELECTRICAL CHARACTERISTICS (continued)

All specifications at $T_A = +25^\circ\text{C}$, $V_{\text{BUS}} = 5\text{ V}$, $f_s = 44.1\text{ kHz}$, $f_{\text{IN}} = 1\text{ kHz}$, and 16-bit data (unless otherwise noted).

| PARAMETER | TEST CONDITIONS | PCM2906B | | | UNIT |
|--|--|-------------|------------------------------------|-------------|-----------------|
| | | MIN | TYP | MAX | |
| ADC CHARACTERISTICS | | | | | |
| Resolution | | | 8, 16 | | Bits |
| Audio data channel | | | 1, 2 | | Channel |
| ADC Clock Frequency | | | | | |
| f_s Sampling frequency | | | 8, 11.025, 16, 22.05, 32, 44.1, 48 | | kHz |
| ADC DC Accuracy | | | | | |
| Gain mismatch, channel-to-channel | | | ± 1 | ± 5 | % of FSR |
| Gain error | | | ± 2 | ± 10 | % of FSR |
| Bipolar zero error | | | ± 0 | | % of FSR |
| ADC Dynamic Performance⁽⁸⁾ | | | | | |
| THD+N Total harmonic distortion plus noise | $V_{\text{IN}} = -1\text{ dB}^{(9)}$, $V_{\text{CCCI}} = 3.67\text{ V}$ | | 0.01 | 0.02 | % |
| | $V_{\text{IN}} = -1\text{ dB}^{(10)}$ | | 0.1 | | % |
| | $V_{\text{IN}} = -60\text{ dB}$ | | 5 | | % |
| Dynamic range | A-weighted | 81 | 89 | | dB |
| SNR Signal-to-noise ratio | A-weighted | 81 | 89 | | dB |
| Channel separation | | 80 | 85 | | dB |
| Analog Input | | | | | |
| Input voltage | | | $0.6 V_{\text{CCCI}}$ | | V_{PP} |
| Center voltage | | | $0.5 V_{\text{CCCI}}$ | | V |
| Input impedance | | | 30 | | k Ω |
| Antialiasing filter frequency response | -3 dB | | 150 | | kHz |
| | $f_{\text{IN}} = 20\text{ kHz}$ | | -0.08 | | dB |
| ADC Digital Filter Performance | | | | | |
| Passband | | | | $0.454 f_s$ | Hz |
| Stop band | | $0.583 f_s$ | | | Hz |
| Passband ripple | | | | ± 0.05 | dB |
| Stop-band attenuation | | -65 | | | dB |
| t_d Delay time | | | $17.4/f_s$ | | s |
| HPF frequency response | -3 dB | | $0.078 f_s/1000$ | | Hz |

(8) $f_{\text{IN}} = 1\text{ kHz}$, using the System Two™ audio measurement system by Audio Precision™ in RMS mode with 20-kHz LPF, 400-Hz HPF in calculation.

(9) Using external voltage regulator for V_{CCCI} (as shown in [Figure 36](#)).

(10) Using internal voltage regulator for V_{CCCI} (as shown in [Figure 37](#)).

ELECTRICAL CHARACTERISTICS (continued)

 All specifications at $T_A = +25^\circ\text{C}$, $V_{\text{BUS}} = 5\text{ V}$, $f_S = 44.1\text{ kHz}$, $f_{\text{IN}} = 1\text{ kHz}$, and 16-bit data (unless otherwise noted).

| PARAMETER | TEST CONDITIONS | PCM2906B | | | UNIT |
|---|----------------------------------|-------------|-----------------------|-------------|--------------------|
| | | MIN | TYP | MAX | |
| DAC CHARACTERISTICS | | | | | |
| Resolution | | | 8, 16 | | Bits |
| Audio data channel | | | 1, 2 | | Channel |
| DAC Clock Frequency | | | | | |
| f_s Sampling frequency | | | 32, 44.1, 48 | | kHz |
| DAC DC Accuracy | | | | | |
| Gain mismatch, channel-to-channel | | | ± 1 | ± 5 | % of FSR |
| Gain error | | | ± 2 | ± 10 | % of FSR |
| Bipolar zero error | | | ± 2 | | % of FSR |
| DAC Dynamic Performance⁽¹¹⁾ | | | | | |
| THD+N Total harmonic distortion plus noise | $V_{\text{OUT}} = 0\text{ dB}$ | | 0.005 | 0.016 | % |
| | $V_{\text{OUT}} = -60\text{ dB}$ | | 3 | | % |
| Dynamic range | EIAJ, A-weighted | 87 | 93 | | dB |
| SNR Signal-to-noise ratio | EIAJ, A-weighted | 90 | 96 | | dB |
| Channel separation | | 86 | 92 | | dB |
| Analog Output | | | | | |
| V_O Output voltage | | | $0.6 V_{\text{CCCI}}$ | | V_{PP} |
| Center voltage | | | $0.5 V_{\text{CCCI}}$ | | V |
| Load impedance | AC coupling | 10 | | | k Ω |
| LPF frequency response | -3 dB | | 250 | | kHz |
| | $f = 20\text{ kHz}$ | | -0.03 | | dB |
| DAC Digital Filter Performance | | | | | |
| Passband | | | | $0.445 f_s$ | Hz |
| Stop band | | $0.555 f_s$ | | | Hz |
| Passband ripple | | | | ± 0.1 | dB |
| Stop-band attenuation | | -43 | | | dB |
| t_d Delay time | | | $14.3 f_s$ | | s |
| POWER-SUPPLY REQUIREMENTS | | | | | |
| V_{BUS} Voltage range | | 4.35 | 5 | 5.25 | VDC |
| Supply current | ADC, DAC operation | | 56 | 67 | mA |
| | Suspend mode ⁽¹²⁾ | | 250 | | μA |
| P_D Power dissipation | ADC, DAC operation | | 280 | 352 | mW |
| | Suspend mode ⁽¹²⁾ | | 1.25 | | mW |
| Internal power-supply voltage ⁽¹³⁾ | | 3.1 | 3.3 | 3.5 | VDC |
| TEMPERATURE RANGE | | | | | |
| Operating temperature range | | -25 | | +85 | $^\circ\text{C}$ |
| θ_{JA} Thermal resistance | 28-pin SSOP | | 100 | | $^\circ\text{C/W}$ |

 (11) $f_{\text{OUT}} = 1\text{ kHz}$, using the System Two audio measurement system by Audio Precision in RMS mode with 20-kHz LPF, 400-Hz HPF.

(12) In USB suspend state.

 (13) Pins 10, 17, 19, 23, 27: V_{CCCI} , V_{CCP1} , V_{CCP2} , V_{CCX1} , V_{DDI} .

PIN ASSIGNMENTS

DB PACKAGE SSOP-28 (TOP VIEW)

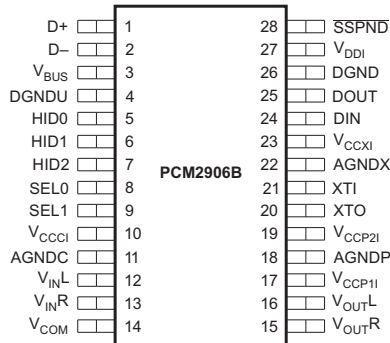

P0007-05

Table 1. TERMINAL FUNCTIONS

| TERMINAL | | I/O | DESCRIPTION |
|--------------------|-----|-----|---|
| NAME | NO. | | |
| AGNDC | 11 | – | Analog ground for codec |
| AGNDP | 18 | – | Analog ground for PLL |
| AGNDX | 22 | – | Analog ground for oscillator |
| D– | 2 | I/O | USB differential input/output minus ⁽¹⁾ |
| D+ | 1 | I/O | USB differential input/output plus ⁽¹⁾ |
| DGND | 26 | – | Digital ground |
| DGNDU | 4 | – | Digital ground for USB transceiver |
| DIN | 24 | I | S/PDIF input ⁽²⁾ |
| DOUT | 25 | O | S/PDIF output |
| HID0 | 5 | I | HID key state input (mute), active-high ⁽³⁾ |
| HID1 | 6 | I | HID key state input (volume up), active-high ⁽³⁾ |
| HID2 | 7 | I | HID key state input (volume down), active-high ⁽³⁾ |
| SEL0 | 8 | I | Must be set to high ⁽⁴⁾ |
| SEL1 | 9 | I | Must be set to high ⁽⁴⁾ |
| SSPND | 28 | O | Suspend flag, active-low (Low: suspend, High: operational) |
| V _{BUS} | 3 | – | Connect to USB power (V _{BUS}) |
| V _{CCCI} | 10 | – | Internal analog power supply for codec ⁽⁵⁾ |
| V _{CCP11} | 17 | – | Internal analog power supply for PLL ⁽⁵⁾ |
| V _{CCP21} | 19 | – | Internal analog power supply for PLL ⁽⁵⁾ |
| V _{CCXI} | 23 | – | Internal analog power supply for oscillator ⁽⁵⁾ |
| V _{COM} | 14 | – | Common for ADC/DAC (V _{CCCI} /2) ⁽⁵⁾ |
| V _{DDI} | 27 | – | Internal digital power supply ⁽⁵⁾ |
| V _{INL} | 12 | I | ADC analog input for L-channel |
| V _{INR} | 13 | I | ADC analog input for R-channel |
| V _{OUTL} | 16 | O | DAC analog output for L-channel |
| V _{OUTR} | 15 | O | DAC analog output for R-channel |
| XTI | 21 | I | Crystal oscillator input ⁽⁶⁾ |
| XTO | 20 | O | Crystal oscillator output |

(1) LV-TTL level.

(2) 3.3-V CMOS-level input with internal pulldown, 5-V tolerant.

(3) 3.3-V CMOS-level input with internal pulldown. This pin informs the PC of serviceable control signals such as mute, volume up, or volume down, which have no direct connection with the internal DAC or ADC. See the *Interface #3* and *End-Points* sections.

(4) TTL Schmitt trigger, 5-V tolerant.

(5) Connect a decoupling capacitor to GND.

(6) 3.3-V CMOS-level input.

FUNCTIONAL BLOCK DIAGRAM

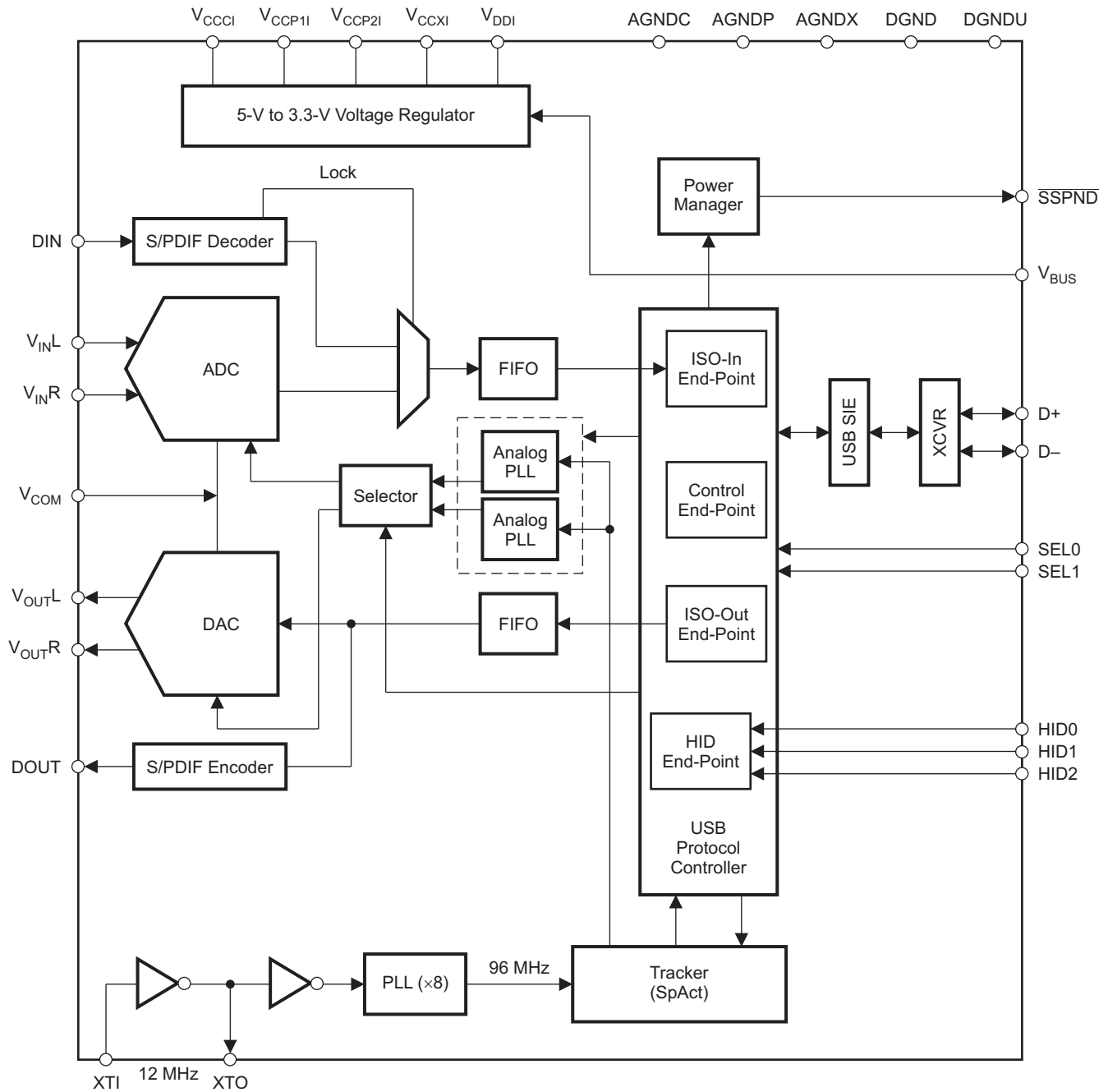

B0239-01

BLOCK DIAGRAM OF ANALOG FRONT-END (RIGHT CHANNEL)

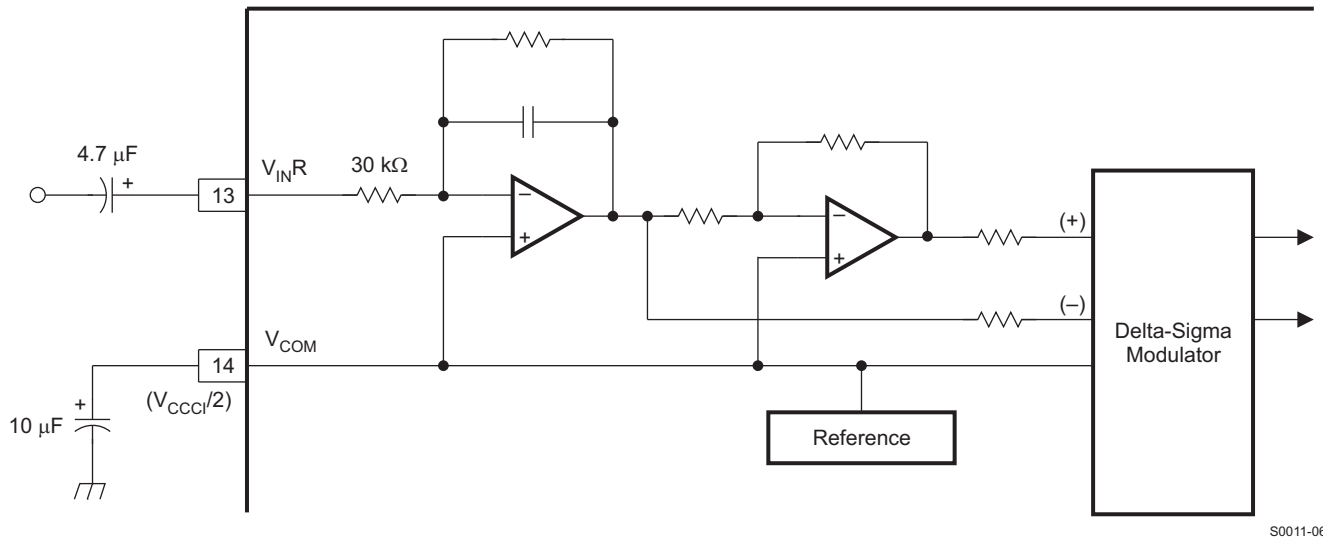

S0011-06

TYPICAL CHARACTERISTICS: ADC

All specifications at $T_A = +25^\circ\text{C}$, $V_{BUS} = 5\text{ V}$, $f_s = 44.1\text{ kHz}$, $f_{IN} = 1\text{ kHz}$, 16-bit data, using REG103xA-A, unless otherwise noted.

TOTAL HARMONIC DISTORTION + NOISE AT -1 dB
vs
FREE-AIR TEMPERATURE

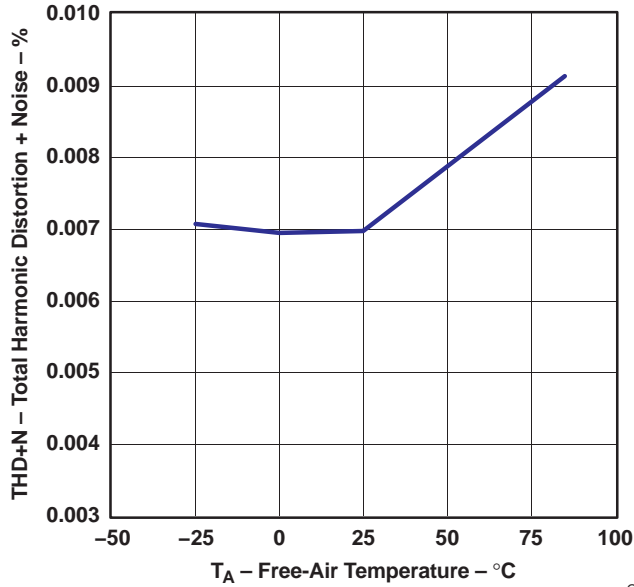

Figure 1.

G001

DYNAMIC RANGE and SNR
vs
FREE-AIR TEMPERATURE

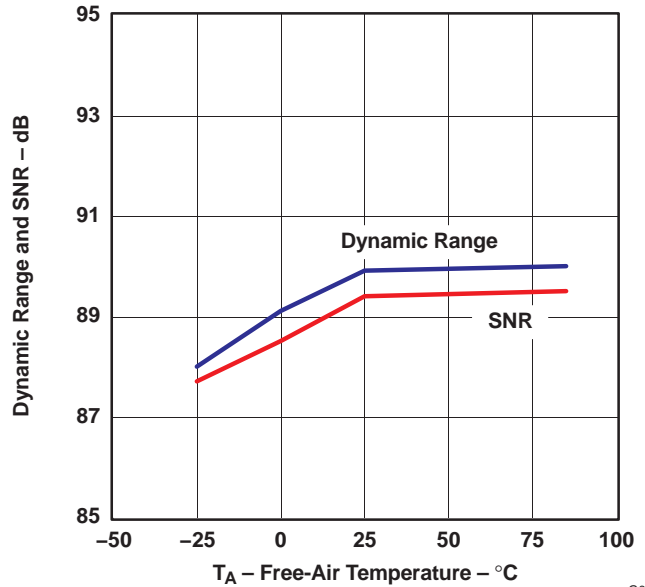

Figure 2.

G002

TOTAL HARMONIC DISTORTION + NOISE AT -1 dB
vs
SUPPLY VOLTAGE

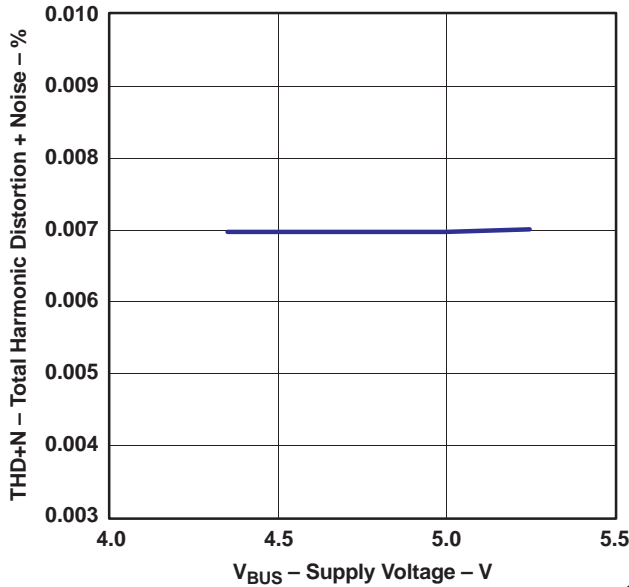

Figure 3.

G003

DYNAMIC RANGE and SNR
vs
SUPPLY VOLTAGE

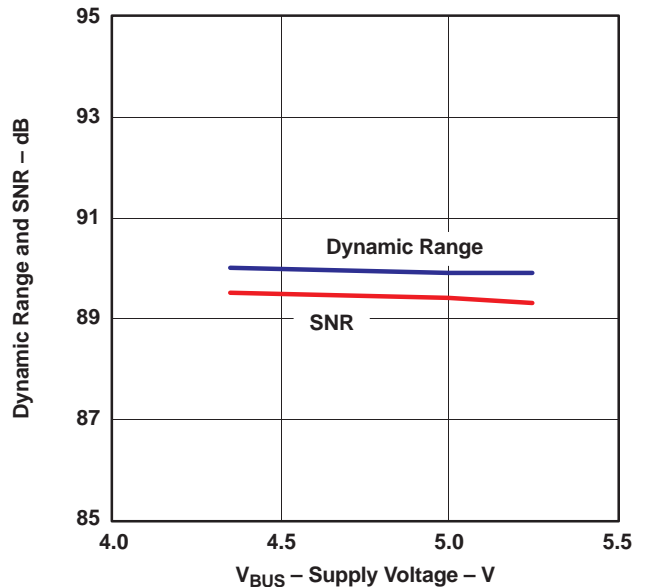

Figure 4.

G004

TYPICAL CHARACTERISTICS: ADC (continued)

All specifications at $T_A = +25^\circ\text{C}$, $V_{\text{BUS}} = 5\text{ V}$, $f_s = 44.1\text{ kHz}$, $f_{\text{IN}} = 1\text{ kHz}$, 16-bit data, using REG103xA-A, unless otherwise noted.

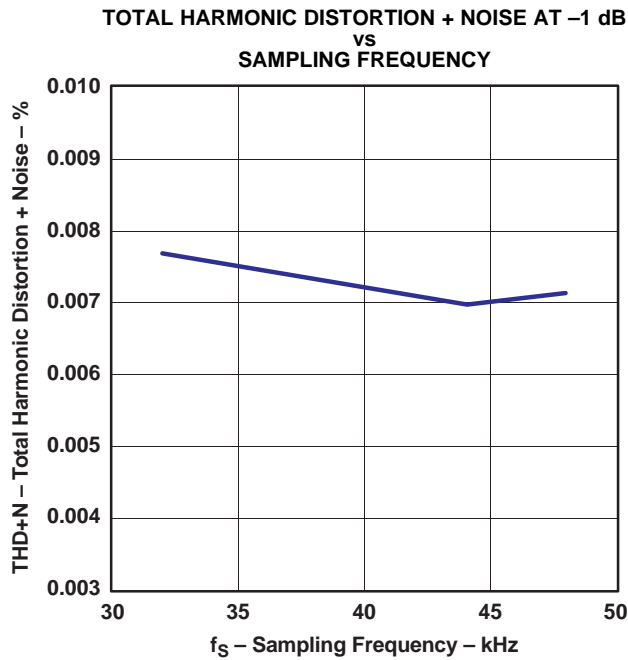

Figure 5.

G005

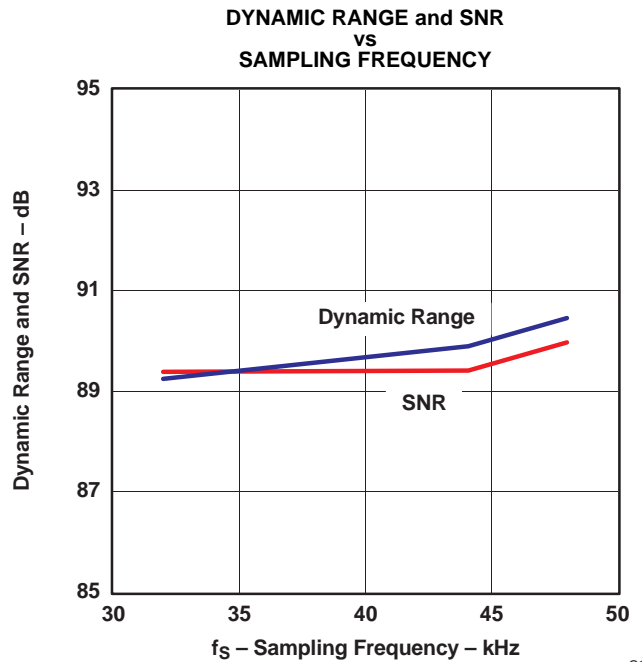

Figure 6.

G006

TYPICAL CHARACTERISTICS: DAC

All specifications at $T_A = +25^\circ\text{C}$, $V_{\text{BUS}} = 5\text{ V}$, $f_s = 44.1\text{ kHz}$, $f_{\text{IN}} = 1\text{ kHz}$, 16-bit data, using REG103xA-A, unless otherwise noted.

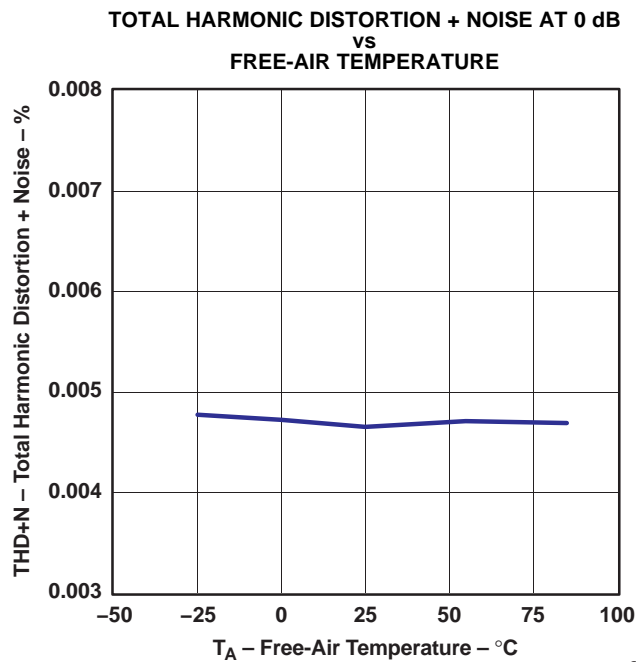

Figure 7.

G007

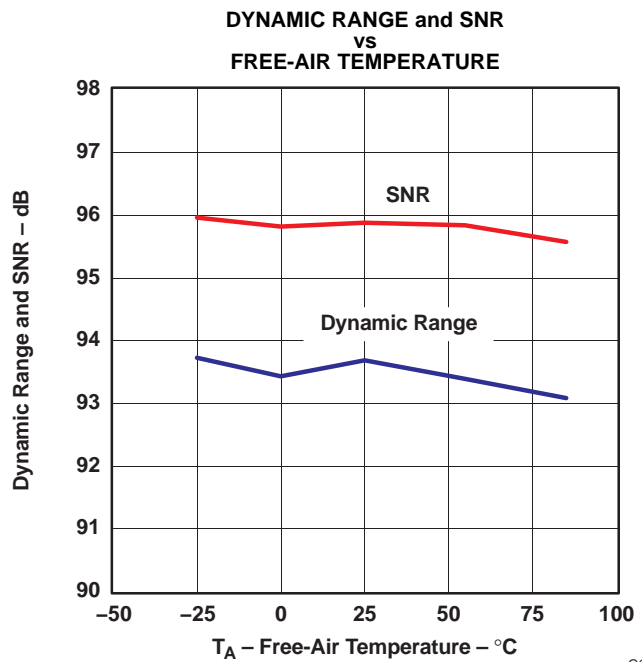

Figure 8.

G008

TYPICAL CHARACTERISTICS: DAC (continued)

All specifications at $T_A = +25^\circ\text{C}$, $V_{\text{BUS}} = 5\text{ V}$, $f_s = 44.1\text{ kHz}$, $f_{\text{IN}} = 1\text{ kHz}$, 16-bit data, using REG103xA-A, unless otherwise noted.

TOTAL HARMONIC DISTORTION + NOISE AT 0 dB
vs
SUPPLY VOLTAGE

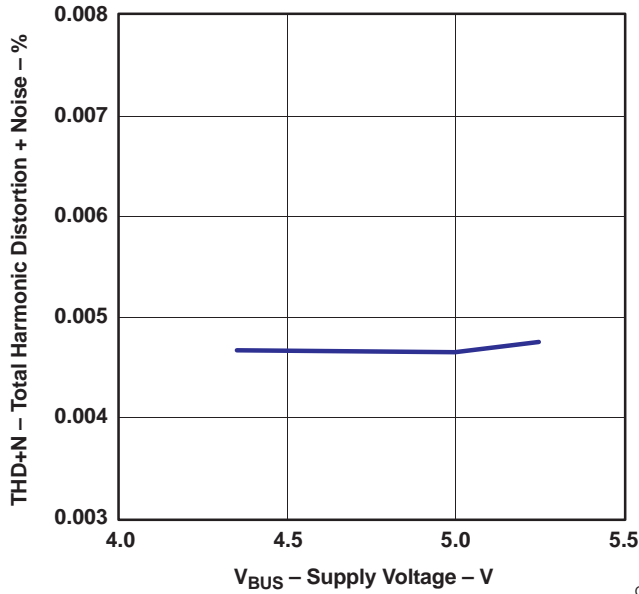

Figure 9.

G009

DYNAMIC RANGE and SNR
vs
SUPPLY VOLTAGE

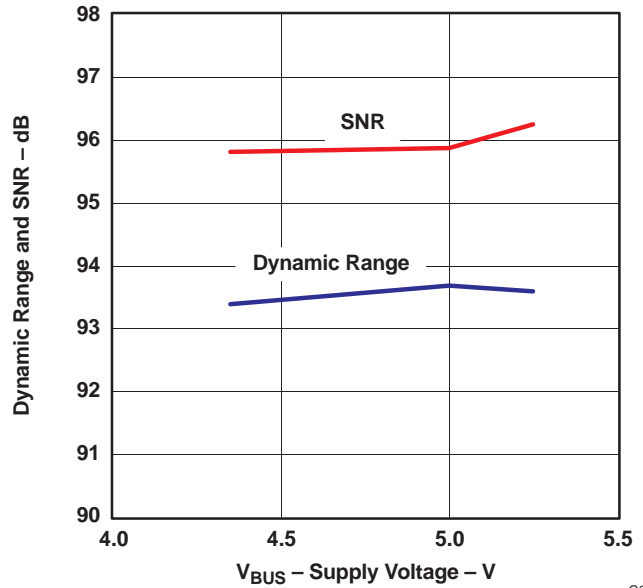

Figure 10.

G010

TOTAL HARMONIC DISTORTION + NOISE AT 0 dB
vs
SAMPLING FREQUENCY

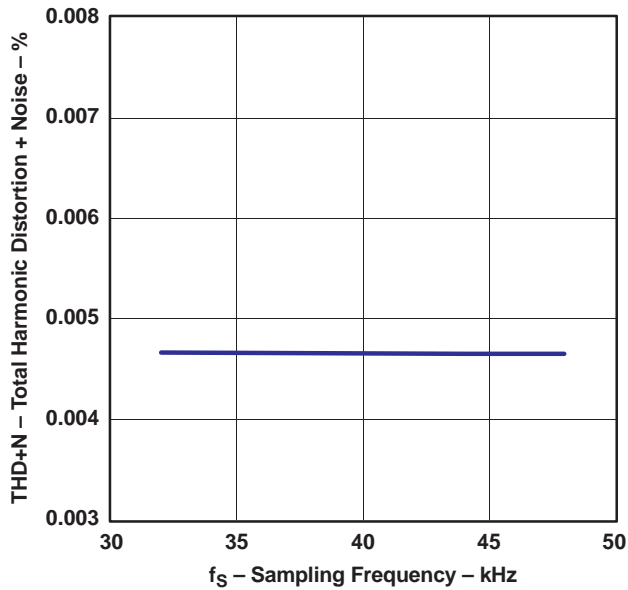

Figure 11.

G011

DYNAMIC RANGE and SNR
vs
SAMPLING FREQUENCY

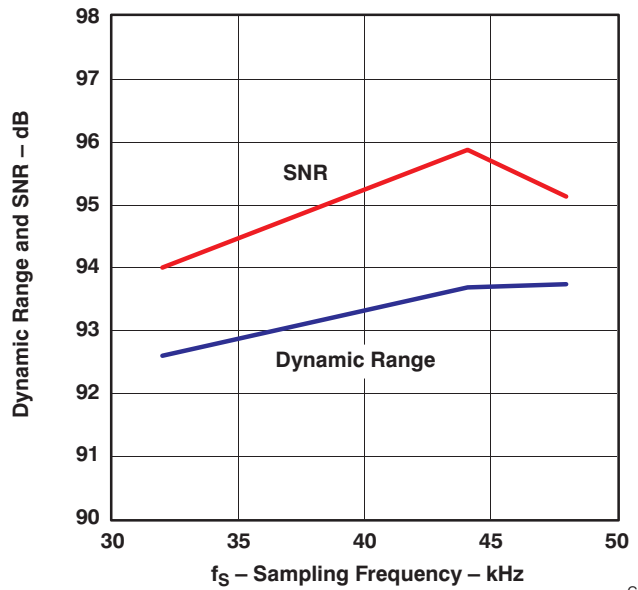

Figure 12.

G012

TYPICAL CHARACTERISTICS: SUPPLY CURRENT

All specifications at $T_A = +25^\circ\text{C}$, $V_{\text{BUS}} = 5\text{ V}$, $f_s = 44.1\text{ kHz}$, $f_{\text{IN}} = 1\text{ kHz}$, 16-bit data, using REG103xA-A, unless otherwise noted.

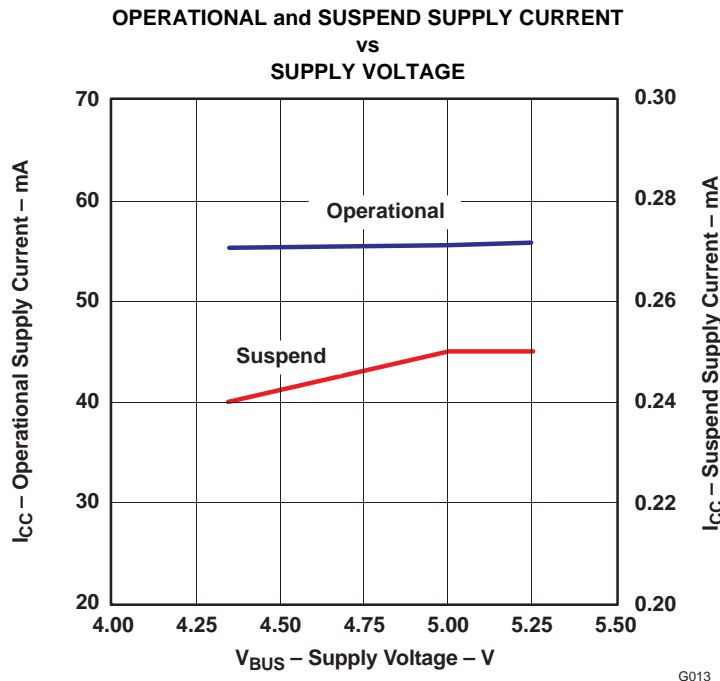

Figure 13.

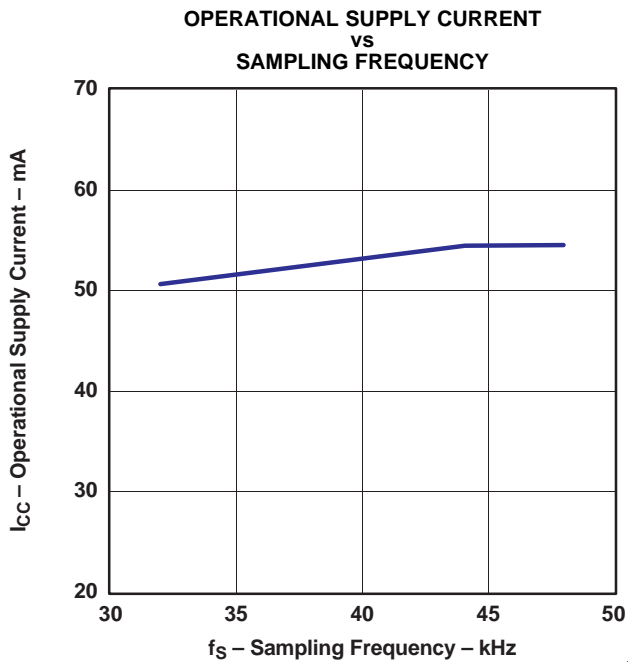

Figure 14.

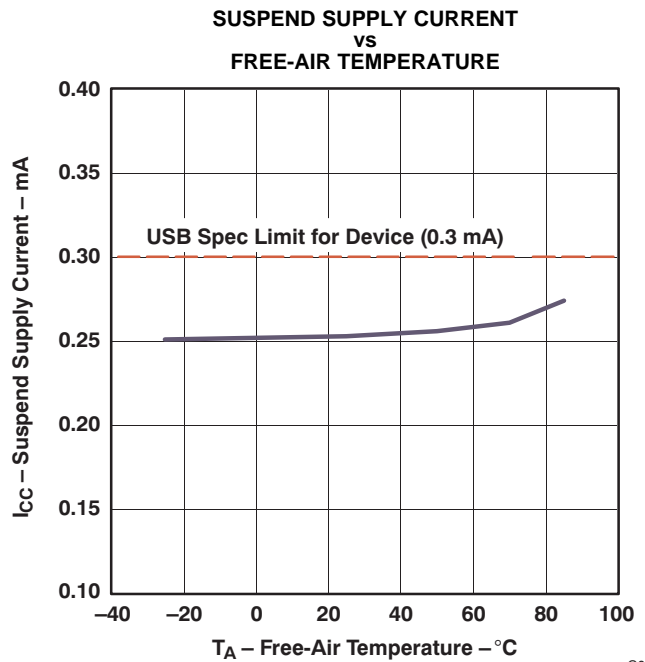
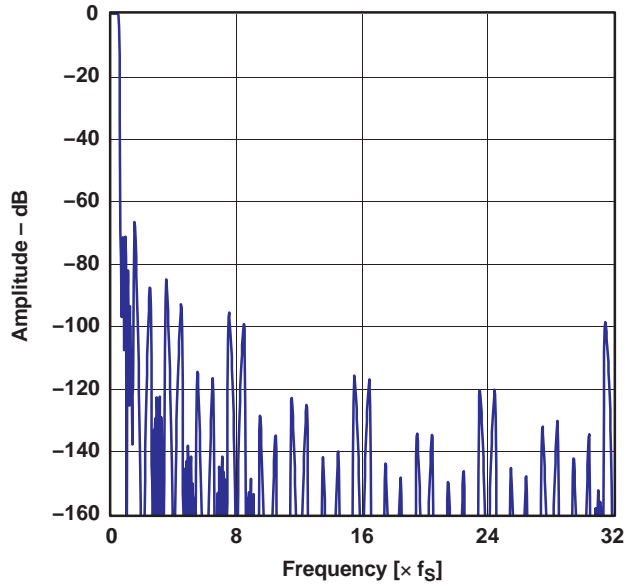

Figure 15.

TYPICAL CHARACTERISTICS: ADC DIGITAL DECIMATION FILTER FREQUENCY RESPONSE

All specifications at $T_A = +25^\circ\text{C}$, $V_{BUS} = 5\text{ V}$, $f_s = 44.1\text{ kHz}$, $f_{IN} = 1\text{ kHz}$, 16-bit data, unless otherwise noted.

OVERALL CHARACTERISTICS



G016

Figure 16.

STOP-BAND ATTENUATION

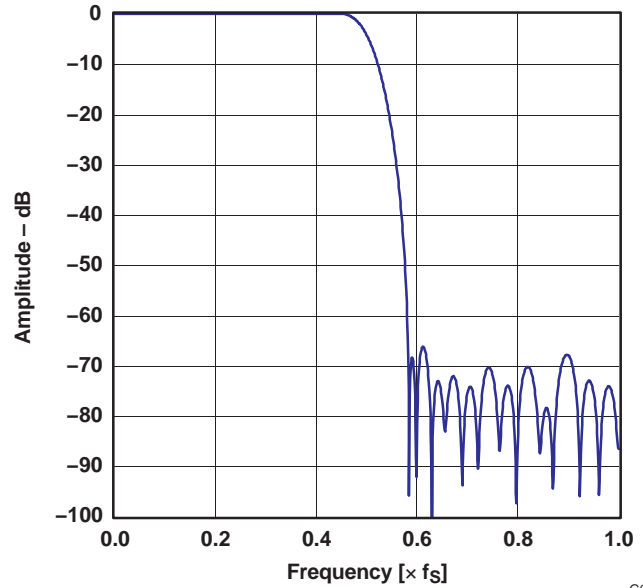

G017

Figure 17.

PASSBAND RIPPLE

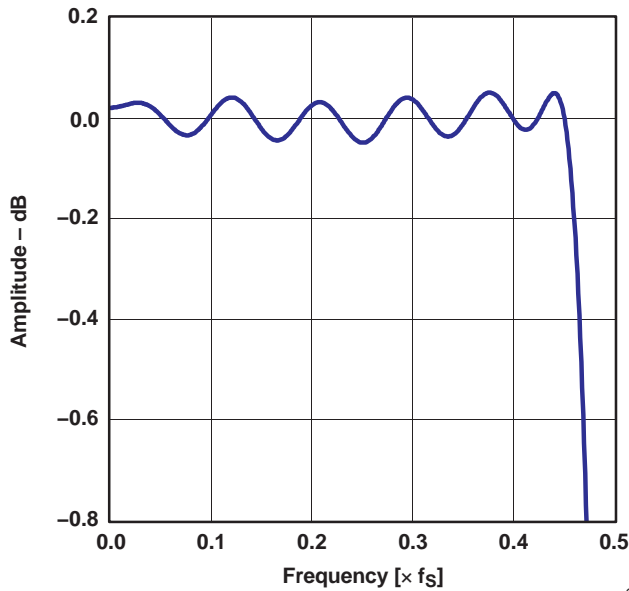

G018

Figure 18.

TRANSITION-BAND RESPONSE

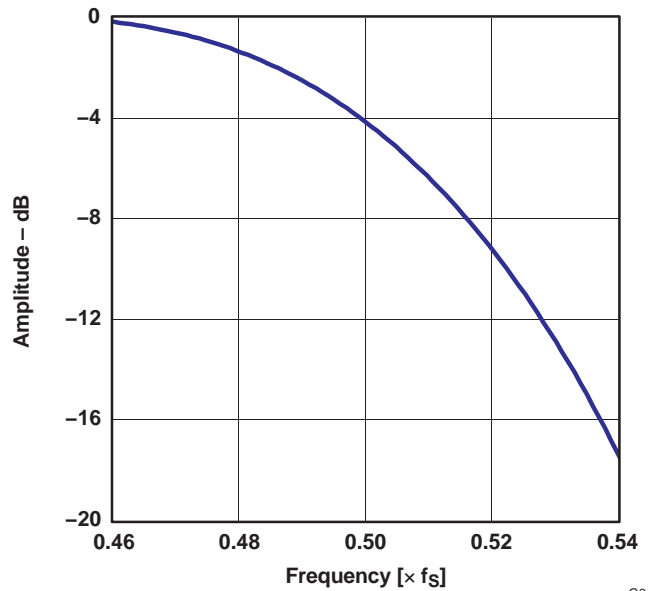

G019

Figure 19.

TYPICAL CHARACTERISTICS: ADC DIGITAL HIGH-PASS FILTER FREQUENCY RESPONSE

All specifications at $T_A = +25^\circ\text{C}$, $V_{BUS} = 5\text{ V}$, $f_s = 44.1\text{ kHz}$, $f_{IN} = 1\text{ kHz}$, 16-bit data, unless otherwise noted.

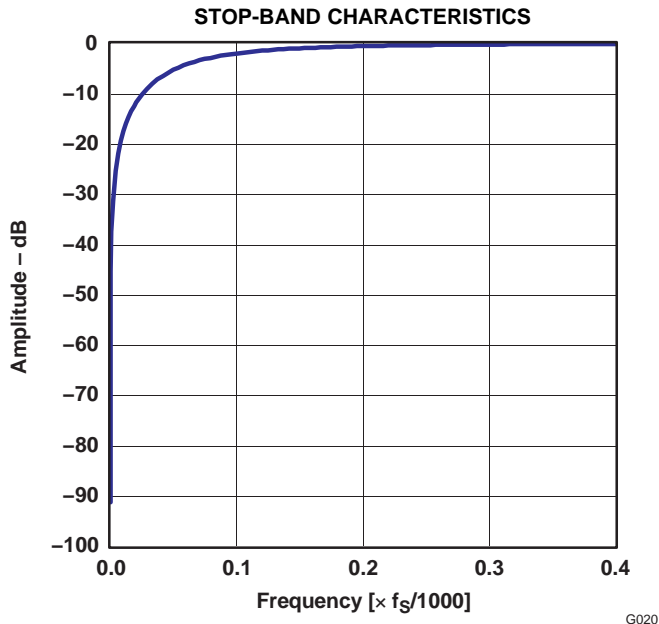

Figure 20.

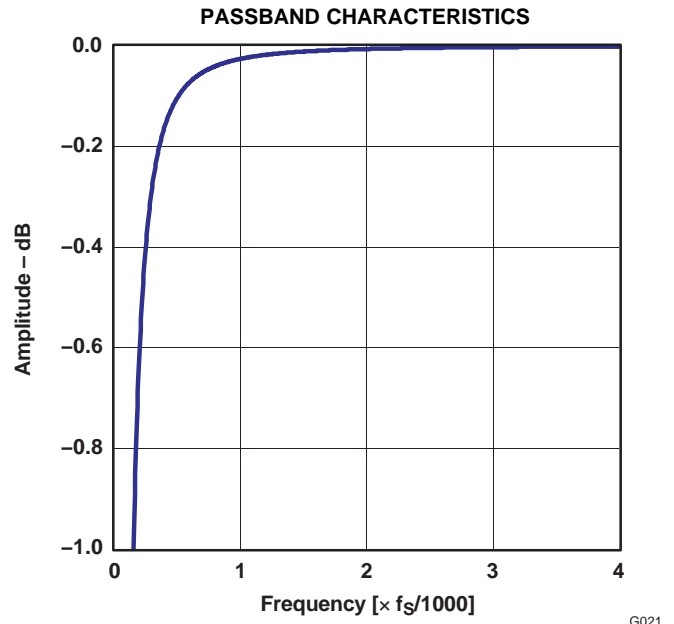

Figure 21.

TYPICAL CHARACTERISTICS: ADC ANALOG ANTIALIASING FILTER FREQUENCY RESPONSE

All specifications at $T_A = +25^\circ\text{C}$, $V_{BUS} = 5\text{ V}$, $f_s = 44.1\text{ kHz}$, $f_{IN} = 1\text{ kHz}$, 16-bit data, unless otherwise noted.

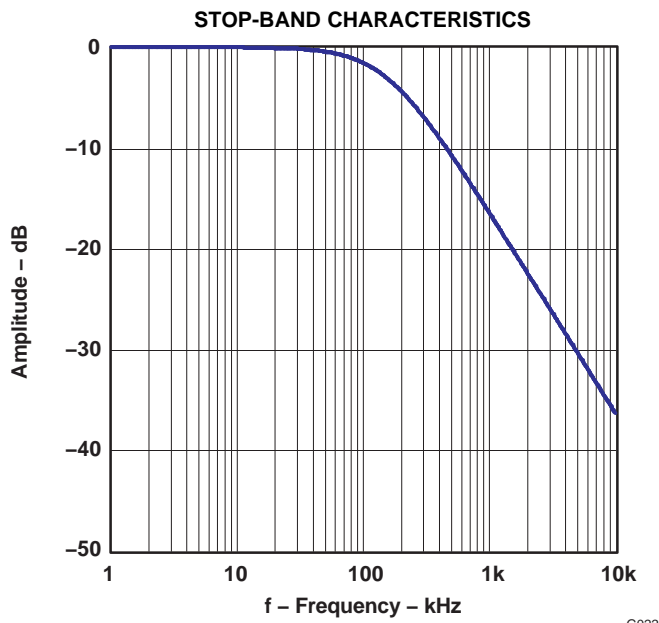

Figure 22.

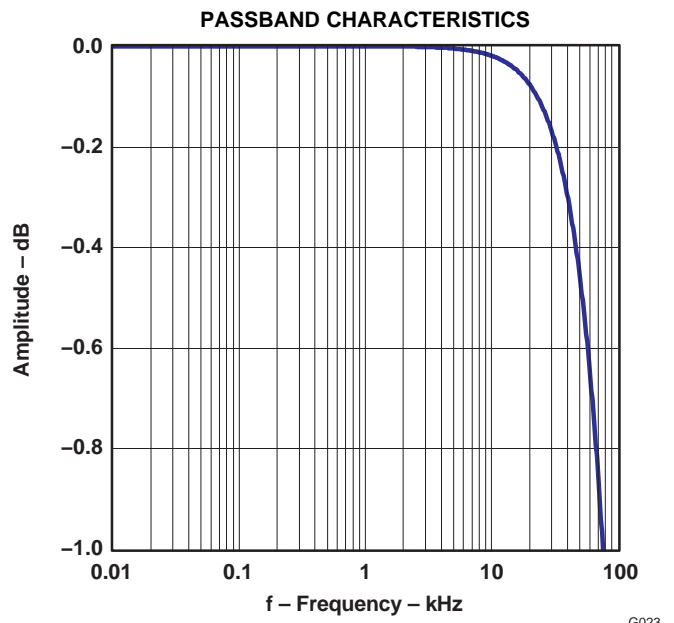

Figure 23.

TYPICAL CHARACTERISTICS: DAC DIGITAL INTERPOLATION FILTER FREQUENCY RESPONSE

All specifications at $T_A = +25^\circ\text{C}$, $V_{\text{BUS}} = 5\text{ V}$, $f_s = 44.1\text{ kHz}$, $f_{\text{IN}} = 1\text{ kHz}$, 16-bit data, unless otherwise noted.

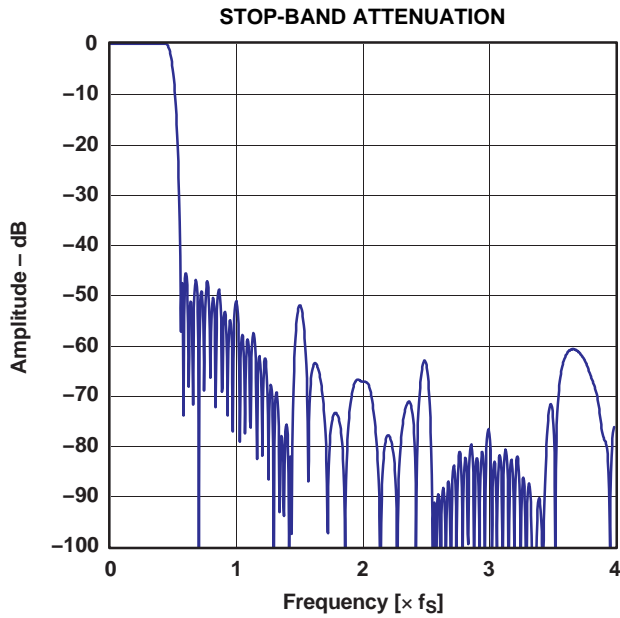

Figure 24.

G024

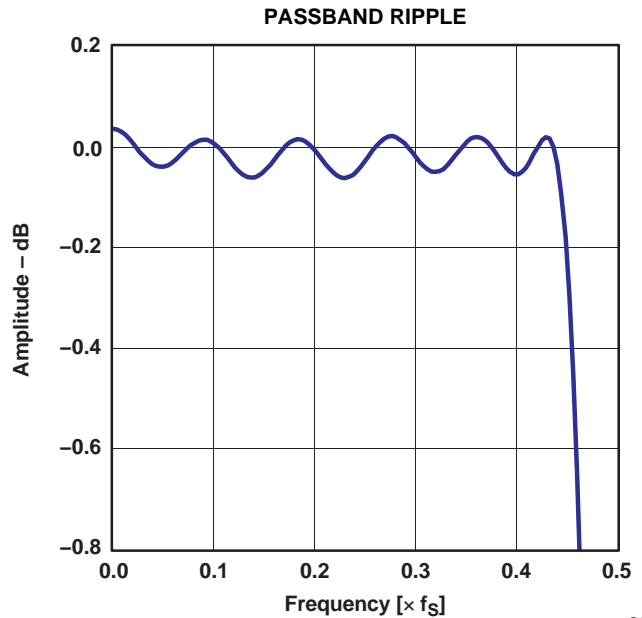

Figure 25.

G025

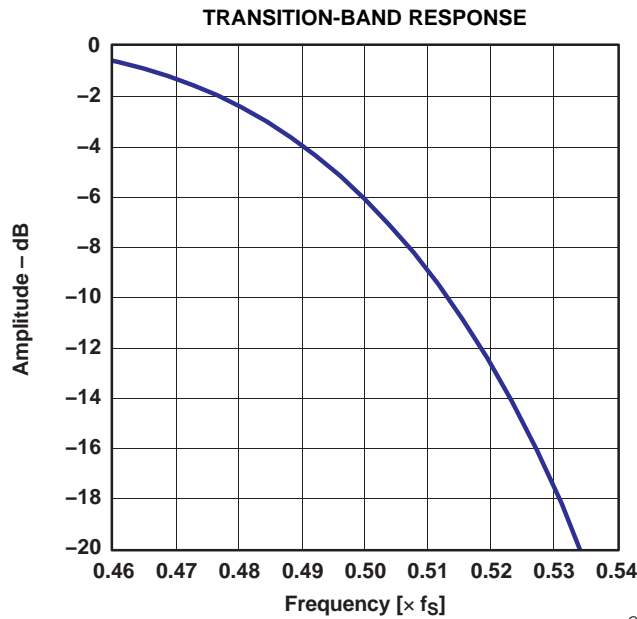

Figure 26.

G026

TYPICAL CHARACTERISTICS: DAC ANALOG FIR FILTER FREQUENCY RESPONSE

All specifications at $T_A = +25^\circ\text{C}$, $V_{BUS} = 5\text{ V}$, $f_s = 44.1\text{ kHz}$, $f_{IN} = 1\text{ kHz}$, 16-bit data, unless otherwise noted.

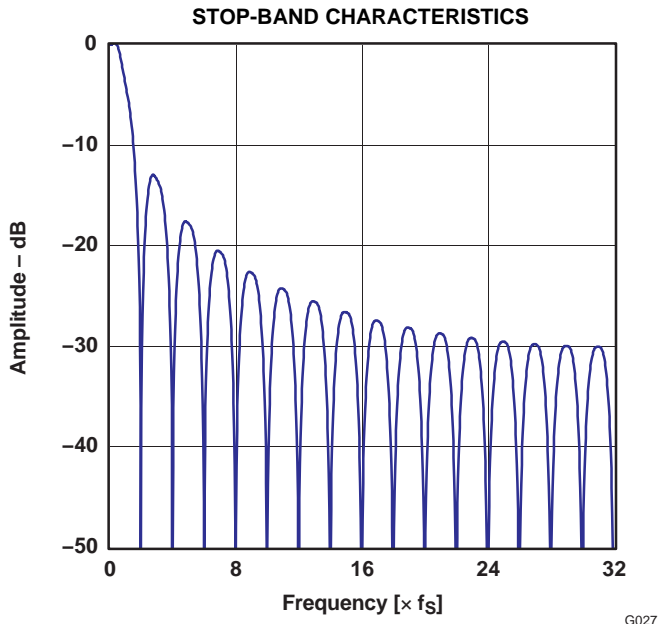

Figure 27.

G027

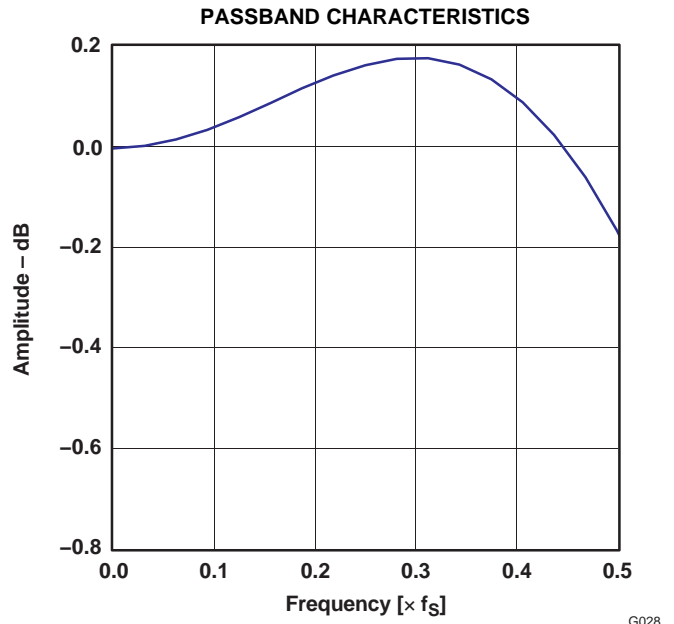

Figure 28.

G028

TYPICAL CHARACTERISTICS: DAC ANALOG LOW-PASS FILTER FREQUENCY RESPONSE

All specifications at $T_A = +25^\circ\text{C}$, $V_{BUS} = 5\text{ V}$, $f_s = 44.1\text{ kHz}$, $f_{IN} = 1\text{ kHz}$, 16-bit data, unless otherwise noted.

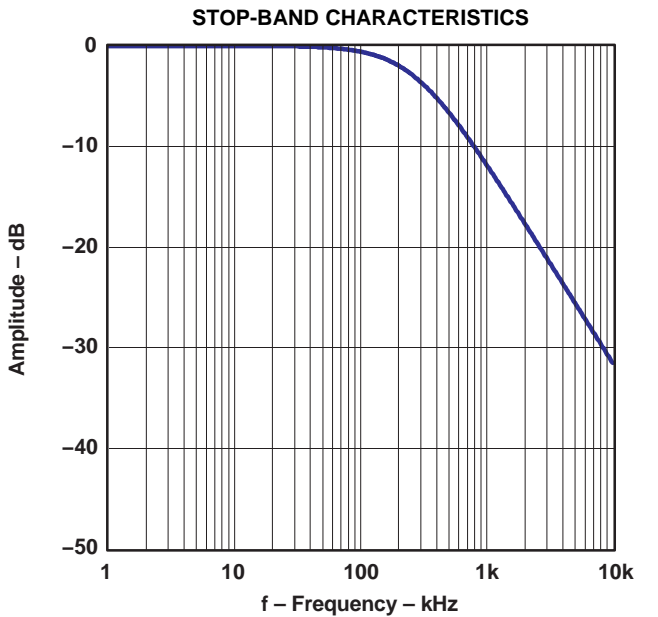

Figure 29.

G029

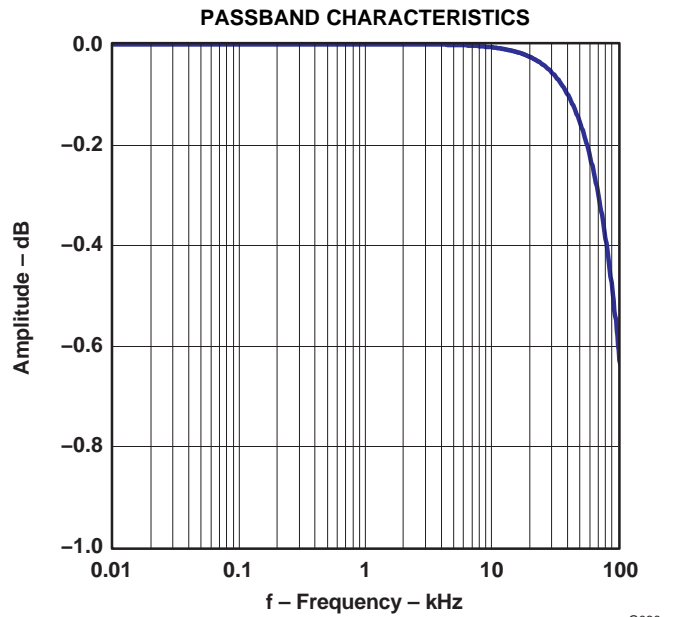

Figure 30.

G030

DETAILED DESCRIPTION

USB INTERFACE

Control data and audio data are transferred to the PCM2906B via D+ (pin 1) and D– (pin 2). All data to/from the PCM2906B are transferred at full speed. The device descriptor contains the information described in [Table 2](#). The device descriptor can be modified on request; contact a Texas Instruments representative about the details.

Table 2. Device Descriptor

| | |
|---------------------------------|--|
| USB revision | 2.0 compliant |
| Device class | 0x00 (device defined interface level) |
| Device sub class | 0x00 (not specified) |
| Device protocol | 0x00 (not specified) |
| Max packet size for end-point 0 | 8 byte |
| Vendor ID | 0x08BB (default value, can be modified) |
| Product ID | 0x29B6 (default value, can be modified) |
| Device release number | 1.0 (0x0100) |
| Number of configurations | 1 |
| Vendor string | String #1 (see Table 4) |
| Product string | String #2 (see Table 4) |
| Serial number | Not supported |

The configuration descriptor contains the information described in [Table 3](#). The configuration descriptor can be modified on request; contact a Texas Instruments representative about the details.

Table 3. Configuration Descriptor

| | |
|-----------------|---|
| Interface | Four interfaces |
| Power attribute | 0x80 (Bus powered, no remote wakeup) |
| Max power | 0xFA (500 mA. Default value, can be modified) |

The string descriptor contains the information described in [Table 4](#). The string descriptor can be modified on request; contact a Texas Instruments representative about the details.

Table 4. String Descriptor

| | |
|----|---|
| #0 | 0x0409 |
| #1 | Burr-Brown from TI (default value, can be modified) |
| #2 | USB Audio CODEC (default value, can be modified) |

DEVICE CONFIGURATION

Figure 31 illustrates the USB audio function topology. The PCM2906B has four interfaces. Each interface consists of alternative settings.

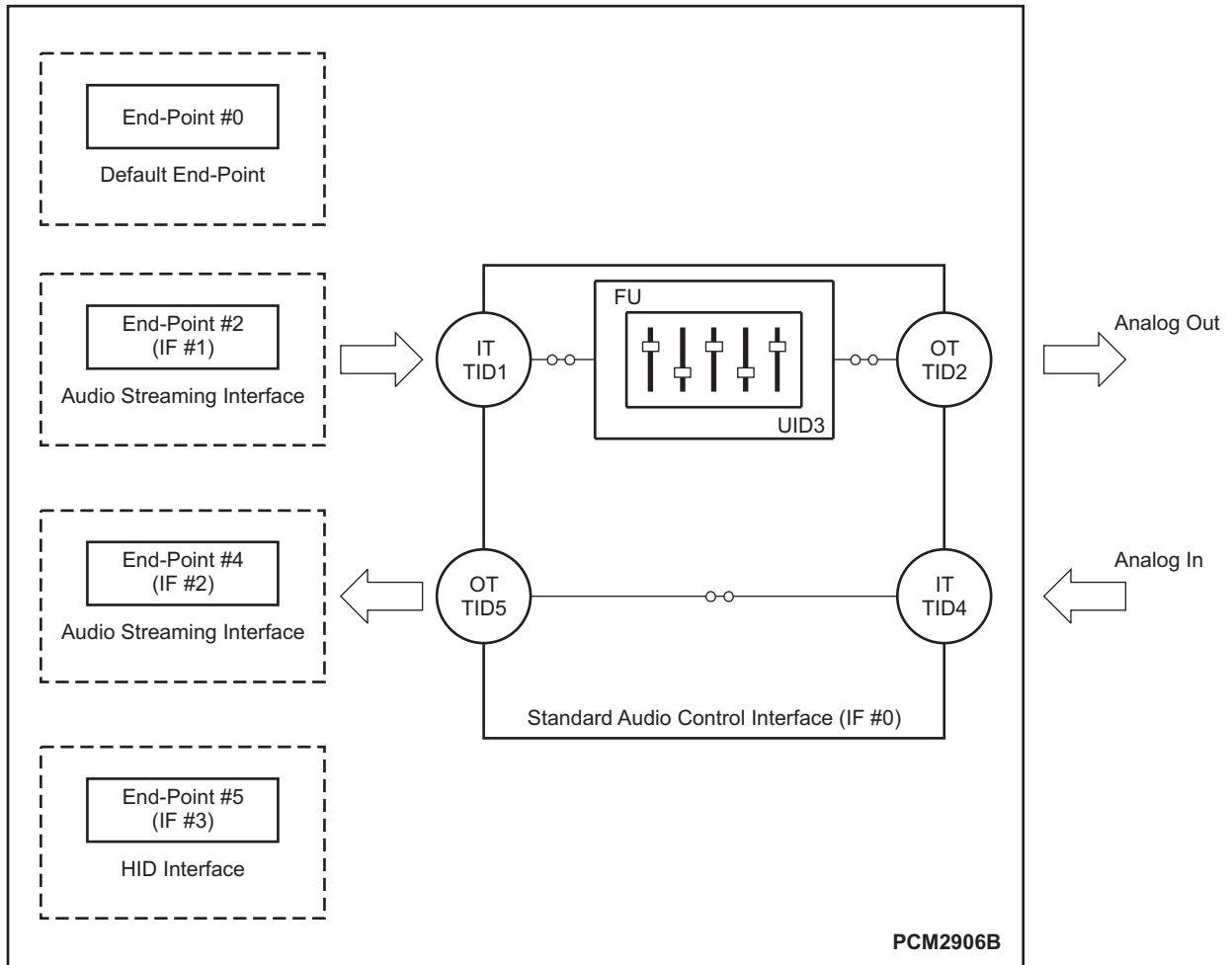

Figure 31. USB Audio Function Topology

M0024-02

Interface #0

Interface #0 is the control interface. Alternative setting #0 is the only possible setting for interface #0. Alternative setting #0 describes the standard audio control interface. The audio control interface consists of a single terminal. The PCM2906B has the following five terminals:

- Input terminal (IT #1) for isochronous-out stream
- Output terminal (OT #2) for audio analog output
- Feature unit (FU #3) for DAC digital attenuator
- Input terminal (IT #4) for audio analog input
- Output terminal (OT #5) for isochronous-in stream

Input terminal #1 is defined as a *USB stream* (terminal type 0x0101). Input terminal #1 can accept two-channel audio streams consisting of left and right channels. Output terminal #2 is defined as a *speaker* (terminal type 0x0301). Input terminal #4 is defined as a *microphone* (terminal type 0x0201). Output terminal #5 is defined as a *USB stream* (terminal type 0x0101). Output terminal #5 can generate two-channel audio streams composed of left and right channel data. Feature unit #3 supports the following sound control features:

- Volume control
- Mute control

The built-in digital volume controller can be manipulated by an audio-class-specific request from 0 dB to –64 dB in 1-dB steps. Changes are made by incrementing or decrementing by one step (1 dB) for every $1/f_s$ time interval until the volume level has reached the requested value. Each channel can be set for different values. The master volume control is not supported. A request to the master volume is stalled and ignored. The built-in digital mute controller can be manipulated by audio-class-specific request. A master mute control request is acceptable. A request to an individual channel is stalled and ignored.

Interface #1

Interface #1 is the audio streaming data-out interface. Interface #1 has the five alternative settings listed in [Table 5](#). Alternative setting #0 is the zero-bandwidth setting. All other alternative settings are operational settings.

Table 5. Interface #1 Alternative Settings

| ALTERNATIVE SETTING | DATA FORMAT | | | TRANSFER MODE | SAMPLING RATE (kHz) |
|---------------------|----------------|--------|-----------------------|---------------|---------------------|
| 00 | Zero bandwidth | | | | |
| 01 | 16-bit | Stereo | Twos complement (PCM) | Adaptive | 32, 44.1, 48 |
| 02 | 16-bit | Mono | Twos complement (PCM) | Adaptive | 32, 44.1, 48 |
| 03 | 8-bit | Stereo | Twos complement (PCM) | Adaptive | 32, 44.1, 48 |
| 04 | 8-bit | Mono | Twos complement (PCM) | Adaptive | 32, 44.1, 48 |

Interface #2

Interface #2 is the audio streaming data-in interface. Interface #2 has the 19 alternative settings listed in [Table 6](#). Alternative setting #0 is the zero-bandwidth setting. All other alternative settings are operational settings.

Table 6. Interface #2 Alternative Settings

| ALTERNATIVE SETTING | DATA FORMAT | | | TRANSFER MODE | SAMPLING RATE (kHz) |
|---------------------|----------------|--------|-----------------------|---------------|---------------------|
| 00 | Zero Bandwidth | | | | |
| 01 | 16-bit | Stereo | Twos complement (PCM) | Asynchronous | 48 |
| 02 | 16-bit | Mono | Twos complement (PCM) | Asynchronous | 48 |
| 03 | 16-bit | Stereo | Twos complement (PCM) | Asynchronous | 44.1 |
| 04 | 16-bit | Mono | Twos complement (PCM) | Asynchronous | 44.1 |
| 05 | 16-bit | Stereo | Twos complement (PCM) | Asynchronous | 32 |
| 06 | 16-bit | Mono | Twos complement (PCM) | Asynchronous | 32 |
| 07 | 16-bit | Stereo | Twos complement (PCM) | Asynchronous | 22.05 |
| 08 | 16-bit | Mono | Twos complement (PCM) | Asynchronous | 22.05 |
| 09 | 16-bit | Stereo | Twos complement (PCM) | Asynchronous | 16 |
| 0A | 16-bit | Mono | Twos complement (PCM) | Asynchronous | 16 |
| 0B | 8-bit | Stereo | Twos complement (PCM) | Asynchronous | 16 |
| 0C | 8-bit | Mono | Twos complement (PCM) | Asynchronous | 16 |
| 0D | 8-bit | Stereo | Twos complement (PCM) | Asynchronous | 8 |
| 0E | 8-bit | Mono | Twos complement (PCM) | Asynchronous | 8 |
| 0F | 16-bit | Stereo | Twos complement (PCM) | Synchronous | 11.025 |
| 10 | 16-bit | Mono | Twos complement (PCM) | Synchronous | 11.025 |
| 11 | 8-bit | Stereo | Twos complement (PCM) | Synchronous | 11.025 |
| 12 | 8-bit | Mono | Twos complement (PCM) | Synchronous | 11.025 |

Interface #3

Interface #3 is the interrupt data-in interface. Alternative setting #0 is the only possible setting for interface #3. Interface #3 consists of the HID consumer control device and reports the status of these three key parameters:

- Mute (0xE209)
- Volume up (0xE909)
- Volume down (0xEA09)

End-Points

The PCM2906B has the following four end-points:

- Control end-point (EP #0)
- Isochronous-out audio data stream end-point (EP #2)
- Isochronous-in audio data stream end-point (EP #4)
- HID end-point (EP #5)

The control end-point is a default end-point. The control end-point is used to control all functions of the PCM2906B by the standard USB request and USB audio class specific request from the host. The isochronous-out audio data stream end-point is an audio sink end-point, which receives the PCM audio data. The isochronous-out audio data stream end-point accepts the adaptive transfer mode. The isochronous-in audio data stream end-point is an audio source end-point that transmits the PCM audio data. The isochronous-in audio data stream end-point uses the asynchronous transfer mode. The HID end-point is an interrupt-in end-point. The HID end-point reports HID0, HID1, and HID2 pin status every 32 ms.

The human interface device (HID) pins are defined as consumer control devices. The HID function is designed as an independent end-point from both isochronous-in and -out end-points. Therefore, the result obtained from the HID operation depends on the host software. Typically, the HID function is used as the primary audio-out device.

Clock and Reset

The PCM2906B requires a 12-MHz (± 500 ppm) clock for the USB and audio functions. The clock can be generated by a built-in oscillator with a 12-MHz crystal resonator. The 12-MHz crystal resonator must be connected to XTI (pin 21) and XTO (pin 20) with one high-value (1-M Ω) resistor and two small capacitors, the capacitance of which depends on the load capacitance of the crystal resonator. An external clock can be supplied to XTI (pin 21). If an external clock is used, XTO (pin 20) must be left open. Because there is no clock disabling signal, use of the external clock supply is not recommended. $\overline{\text{SSPND}}$ (pin 28) is unable to use clock disabling.

The PCM2906B has an internal power-on reset circuit, which triggers automatically when V_{BUS} (pin 3) exceeds 2.5 V typical (2.7 V to 2.2 V). Approximately 700 μs is required until internal reset release.

Digital Audio Interface

The PCM2906 employs S/PDIF for both input and output. Isochronous-out data from the host are encoded to the S/PDIF output and the DAC analog output. Input data are selected from either the S/PDIF or ADC analog input. When the device detects S/PDIF input and successfully locks the received data, the isochronous-in transfer data source automatically selected is S/PDIF; otherwise, the data source selected is the ADC analog input.

This feature is a customer option. It is the responsibility of the user to implement this feature.

Supported Input/Output Data

The following data formats are accepted by S/PDIF for input and output. All other data formats are unusable as S/PDIF.

- 48-kHz 16-bit stereo
- 44.1-kHz 16-bit stereo
- 32-kHz 16-bit stereo

Any mismatch of the sampling rate between the input S/PDIF signal and the host command is not acceptable. Any mismatch of the data format between the input S/PDIF signal and the host command may cause unexpected results, with the following exceptions:

- Recording in monaural format from stereo data input at the same data rate
- Recording in 8-bit format from 16-bit data input at the same data rate

A combination of these two conditions is not acceptable.

For playback, all possible data-rate sources are converted to the 16-bit stereo format at the same source data rate.

Channel Status Information

The channel status information is fixed as consumer application, PCM mode, copyright, and digital/digital converter. All other bits are fixed as 0's except for the sample frequency, which is set automatically according to the data received through the USB.

Copyright Management

Isochronous-in data are affected by the serial copy management system (SCMS). When the control bit indicates that the received digital audio data are original, the input digital audio data are transferred to the host. If the data are indicated as first generation or higher, the transferred data are routed to the analog input.

Digital audio data output is always encoded as original with SCMS control.

INTERFACE SEQUENCE

Power-On, Attach, and Playback Sequence

The PCM2906B is ready for setup when the reset sequence has finished and the USB device is attached. After a connection has been established by setup, the PCM2906B is ready to accept USB audio data. While waiting for the audio data (idle state), the analog output is set to bipolar zero (BPZ).

When receiving the audio data, the PCM2906B stores the first audio packet, which contains 1-ms audio data, into the internal storage buffer. The PCM2906B starts playing the audio data when detecting the next start-of-frame (SOF) packet, as illustrated in Figure 32.

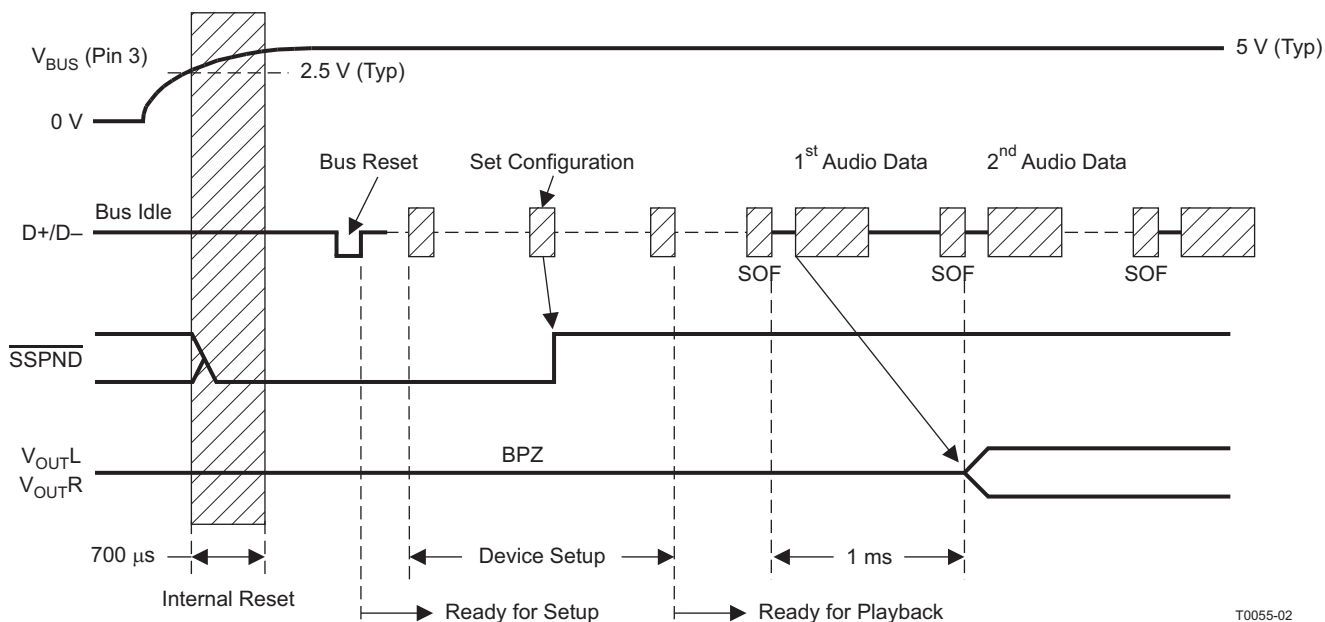

Figure 32. Initial Sequence

Play, Stop, and Detach Sequence

When the host finishes or aborts the playback, the PCM2906B stops playing after the last audio data have played, as shown in Figure 33.

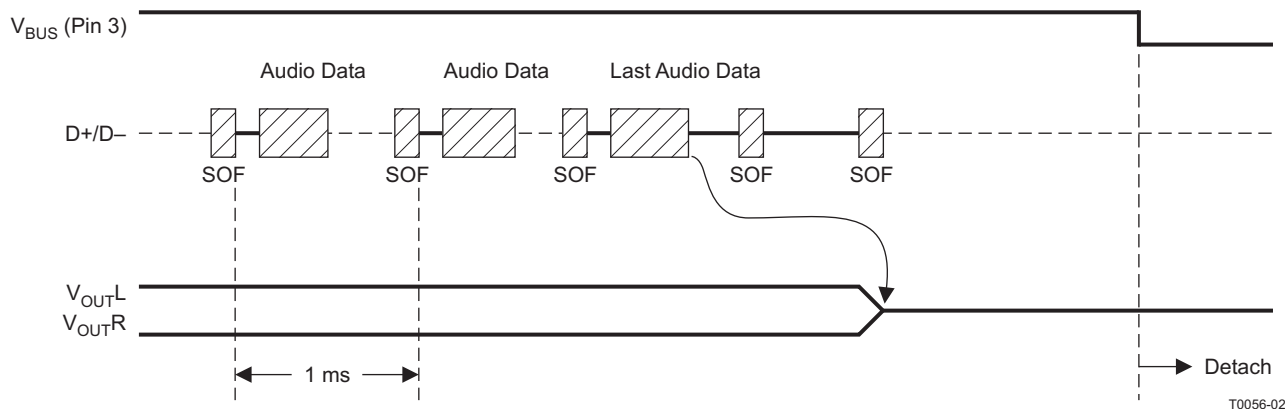

Figure 33. Play, Stop, and Detach Sequence

Record Sequence

The PCM2906B starts audio capture into the internal memory after receiving the SET_INTERFACE command, as shown in Figure 34.

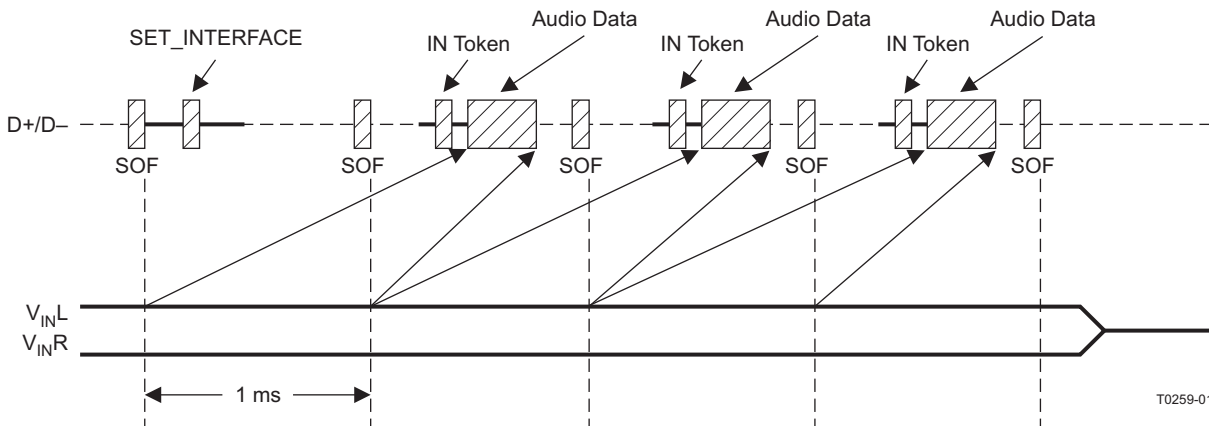

Figure 34. Record Sequence

Suspend and Resume Sequence

The PCM2906B enters the suspend state after a constant idle state on the USB bus (approximately 5 ms), as shown in Figure 35. While the PCM2906B enters the suspend state, the \overline{SSPND} flag (pin 28) is asserted. The PCM2906B wakes up immediately upon detecting a non-idle state on the USB.

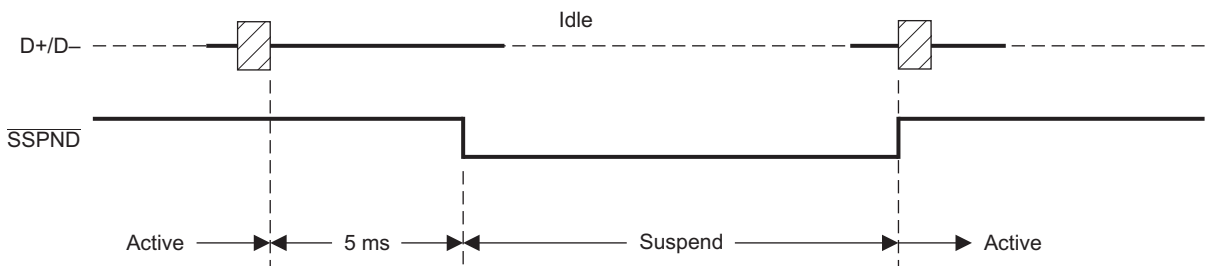
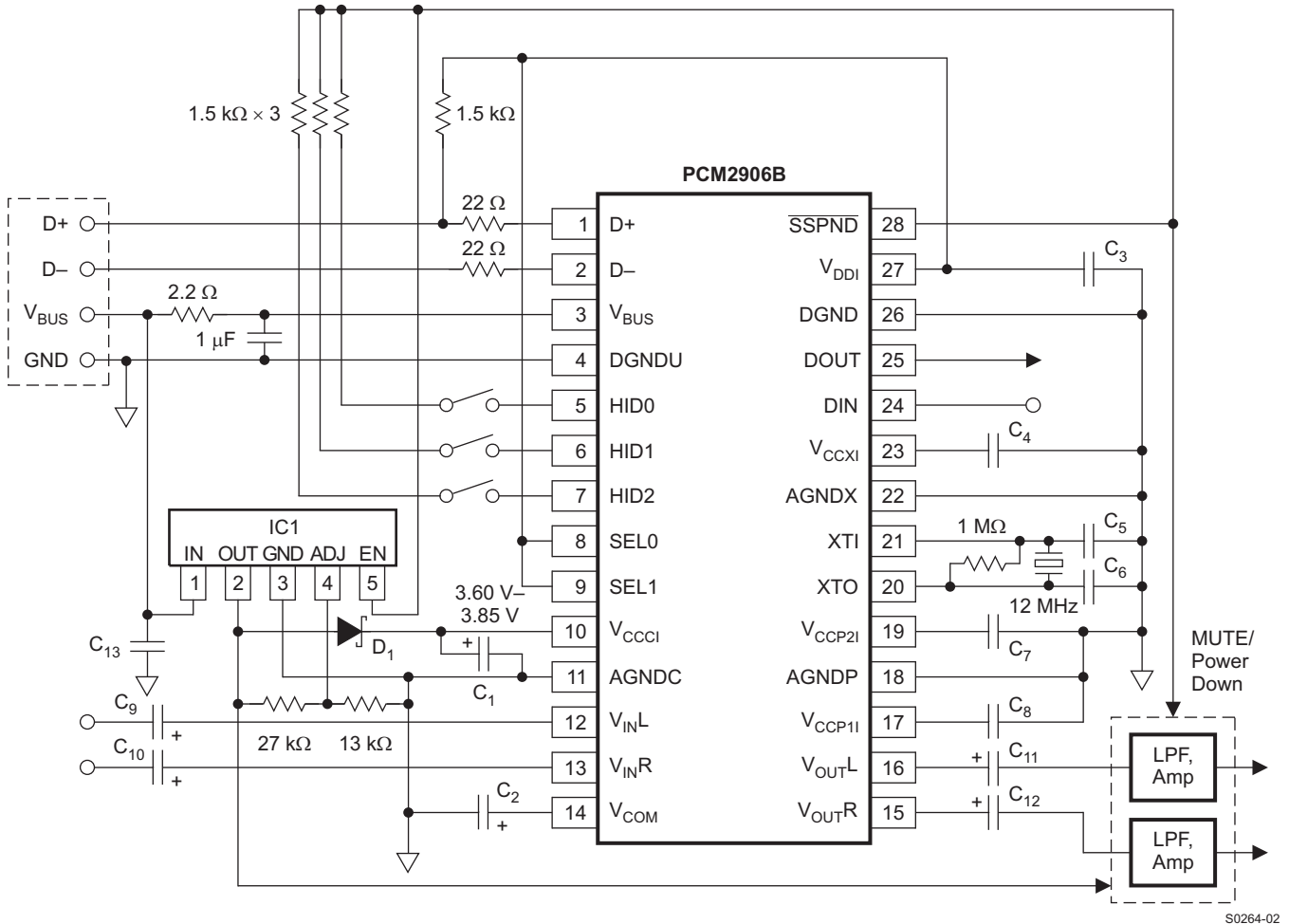

Figure 35. Suspend and Resume Sequence

APPLICATION INFORMATION

TYPICAL CIRCUIT CONNECTION 1

Figure 36 illustrates a typical circuit connection for a simple application. The circuit illustrated is for information only. The entire board design should be considered to meet the USB specification as a USB-compliant product.



S0264-02

NOTE: C_1, C_2 : 10 μF
 $C_3, C_4, C_7, C_8, C_{13}$: 1 μF (These capacitors must be less than 2 μF .)
 C_5, C_6 : 10 pF to 33 pF (depending on crystal resonator)
 $C_9, C_{10}, C_{11}, C_{12}$: The capacitance may vary depending on design.
 IC1: REG103xA-A (TI) or equivalent. Analog performance may vary depending on IC1.
 D_1 : Schottky barrier diode ($V_F \leq 350 \text{ mV}$ at 10 mA, $I_R \leq 2 \mu\text{A}$ at 4 V)

Figure 36. Bus-Powered Configuration for High-Performance Application

TYPICAL CIRCUIT CONNECTION 2

Figure 37 illustrates a typical circuit connection for a simple application. The circuit illustrated is for information only. The entire board design should be considered to meet the USB specification as a USB-compliant product.

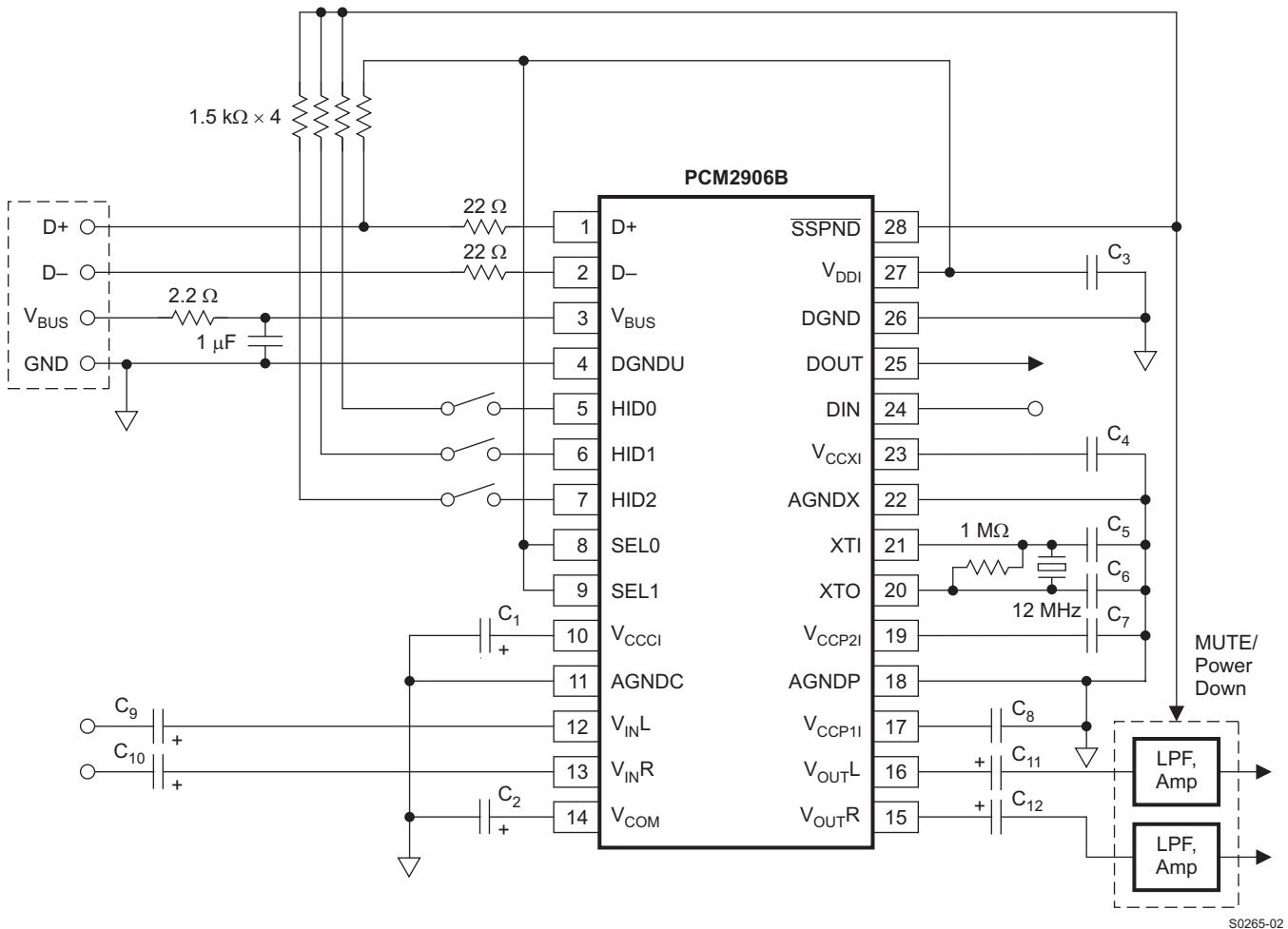

S0265-02

NOTE: C₁, C₂: 10 μF
 C₃, C₄, C₇, C₈: 1 μF (These capacitors must be less than 2 μF.)
 C₅, C₆: 10 pF to 33 pF (depending on crystal resonator)
 C₉, C₁₀, C₁₁, C₁₂: The capacitance may vary depending on design.
 In this case, the analog performance of the ADC may be degraded.

Figure 37. Bus-Powered Configuration

OPERATING ENVIRONMENT

For current information on the PCM2906B operating environment, see the *Updated Operating Environments for PCM270X, PCM290X Applications* application report, [SLAA374](#).

PACKAGING INFORMATION

| Orderable Device | Status (1) | Package Type | Package Drawing | Pins | Package Qty | Eco Plan (2) | Lead finish/ Ball material (6) | MSL Peak Temp (3) | Op Temp (°C) | Device Marking (4/5) | Samples |
|------------------|---------------|--------------|-----------------|------|-------------|-----------------|--------------------------------------|----------------------|--------------|-------------------------|---------|
| PCM2906BDB | NRND | SSOP | DB | 28 | 50 | RoHS & Green | Call TI NIPDAU | Level-1-260C-UNLIM | -25 to 85 | PCM2906B | |
| PCM2906BDBR | NRND | SSOP | DB | 28 | 2000 | RoHS & Green | Call TI NIPDAU | Level-1-260C-UNLIM | -25 to 85 | PCM2906B | |

(1) The marketing status values are defined as follows:

ACTIVE: Product device recommended for new designs.

LIFEBUY: TI has announced that the device will be discontinued, and a lifetime-buy period is in effect.

NRND: Not recommended for new designs. Device is in production to support existing customers, but TI does not recommend using this part in a new design.

PREVIEW: Device has been announced but is not in production. Samples may or may not be available.

OBSOLETE: TI has discontinued the production of the device.

(2) **RoHS:** TI defines "RoHS" to mean semiconductor products that are compliant with the current EU RoHS requirements for all 10 RoHS substances, including the requirement that RoHS substance do not exceed 0.1% by weight in homogeneous materials. Where designed to be soldered at high temperatures, "RoHS" products are suitable for use in specified lead-free processes. TI may reference these types of products as "Pb-Free".

RoHS Exempt: TI defines "RoHS Exempt" to mean products that contain lead but are compliant with EU RoHS pursuant to a specific EU RoHS exemption.

Green: TI defines "Green" to mean the content of Chlorine (Cl) and Bromine (Br) based flame retardants meet JS709B low halogen requirements of <=1000ppm threshold. Antimony trioxide based flame retardants must also meet the <=1000ppm threshold requirement.

(3) MSL, Peak Temp. - The Moisture Sensitivity Level rating according to the JEDEC industry standard classifications, and peak solder temperature.

(4) There may be additional marking, which relates to the logo, the lot trace code information, or the environmental category on the device.

(5) Multiple Device Markings will be inside parentheses. Only one Device Marking contained in parentheses and separated by a "~" will appear on a device. If a line is indented then it is a continuation of the previous line and the two combined represent the entire Device Marking for that device.

(6) Lead finish/Ball material - Orderable Devices may have multiple material finish options. Finish options are separated by a vertical ruled line. Lead finish/Ball material values may wrap to two lines if the finish value exceeds the maximum column width.

Important Information and Disclaimer:The information provided on this page represents TI's knowledge and belief as of the date that it is provided. TI bases its knowledge and belief on information provided by third parties, and makes no representation or warranty as to the accuracy of such information. Efforts are underway to better integrate information from third parties. TI has taken and continues to take reasonable steps to provide representative and accurate information but may not have conducted destructive testing or chemical analysis on incoming materials and chemicals. TI and TI suppliers consider certain information to be proprietary, and thus CAS numbers and other limited information may not be available for release.

In no event shall TI's liability arising out of such information exceed the total purchase price of the TI part(s) at issue in this document sold by TI to Customer on an annual basis.

TAPE AND REEL INFORMATION

QUADRANT ASSIGNMENTS FOR PIN 1 ORIENTATION IN TAPE

*All dimensions are nominal

| Device | Package Type | Package Drawing | Pins | SPQ | Reel Diameter (mm) | Reel Width W1 (mm) | A0 (mm) | B0 (mm) | K0 (mm) | P1 (mm) | W (mm) | Pin1 Quadrant |
|-------------|--------------|-----------------|------|------|--------------------|--------------------|---------|---------|---------|---------|--------|---------------|
| PCM2906BDBR | SSOP | DB | 28 | 2000 | 330.0 | 16.4 | 8.2 | 10.5 | 2.5 | 12.0 | 16.0 | Q1 |

TAPE AND REEL BOX DIMENSIONS

*All dimensions are nominal

| Device | Package Type | Package Drawing | Pins | SPQ | Length (mm) | Width (mm) | Height (mm) |
|-------------|--------------|-----------------|------|------|-------------|------------|-------------|
| PCM2906BDBR | SSOP | DB | 28 | 2000 | 356.0 | 356.0 | 35.0 |

TUBE

*All dimensions are nominal

| Device | Package Name | Package Type | Pins | SPQ | L (mm) | W (mm) | T (μm) | B (mm) |
|------------|--------------|--------------|------|-----|--------|--------|--------|--------|
| PCM2906BDB | DB | SSOP | 28 | 50 | 530 | 10.5 | 4000 | 4.1 |
| PCM2906BDB | DB | SSOP | 28 | 50 | 530 | 10.5 | 4000 | 4.1 |

DB0028A



PACKAGE OUTLINE

SSOP - 2 mm max height

SMALL OUTLINE PACKAGE



4214853/B 03/2018

NOTES:

1. All linear dimensions are in millimeters. Any dimensions in parenthesis are for reference only. Dimensioning and tolerancing per ASME Y14.5M.
2. This drawing is subject to change without notice.
3. This dimension does not include mold flash, protrusions, or gate burrs. Mold flash, protrusions, or gate burrs shall not exceed 0.15 mm per side.
4. This dimension does not include interlead flash. Interlead flash shall not exceed 0.25 mm per side.
5. Reference JEDEC registration MO-150.

EXAMPLE BOARD LAYOUT

DB0028A

SSOP - 2 mm max height

SMALL OUTLINE PACKAGE

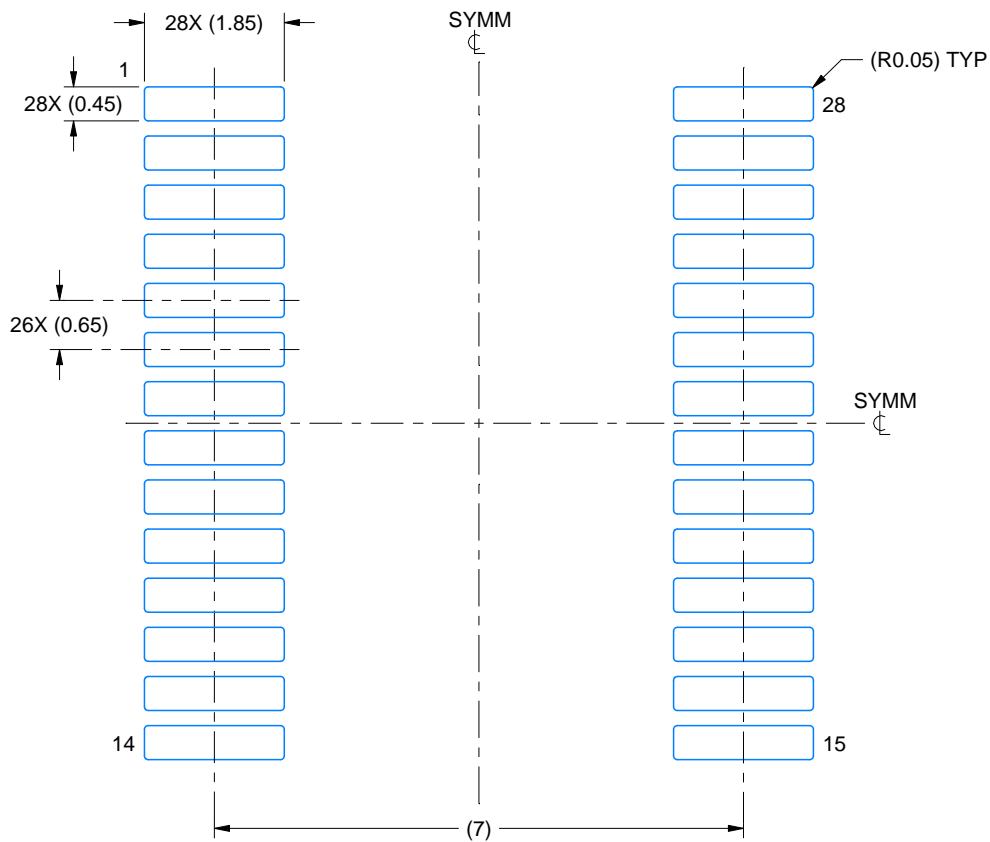

LAND PATTERN EXAMPLE
EXPOSED METAL SHOWN
SCALE: 10X



4214853/B 03/2018

NOTES: (continued)

- 6. Publication IPC-7351 may have alternate designs.
- 7. Solder mask tolerances between and around signal pads can vary based on board fabrication site.

EXAMPLE STENCIL DESIGN

DB0028A

SSOP - 2 mm max height

SMALL OUTLINE PACKAGE

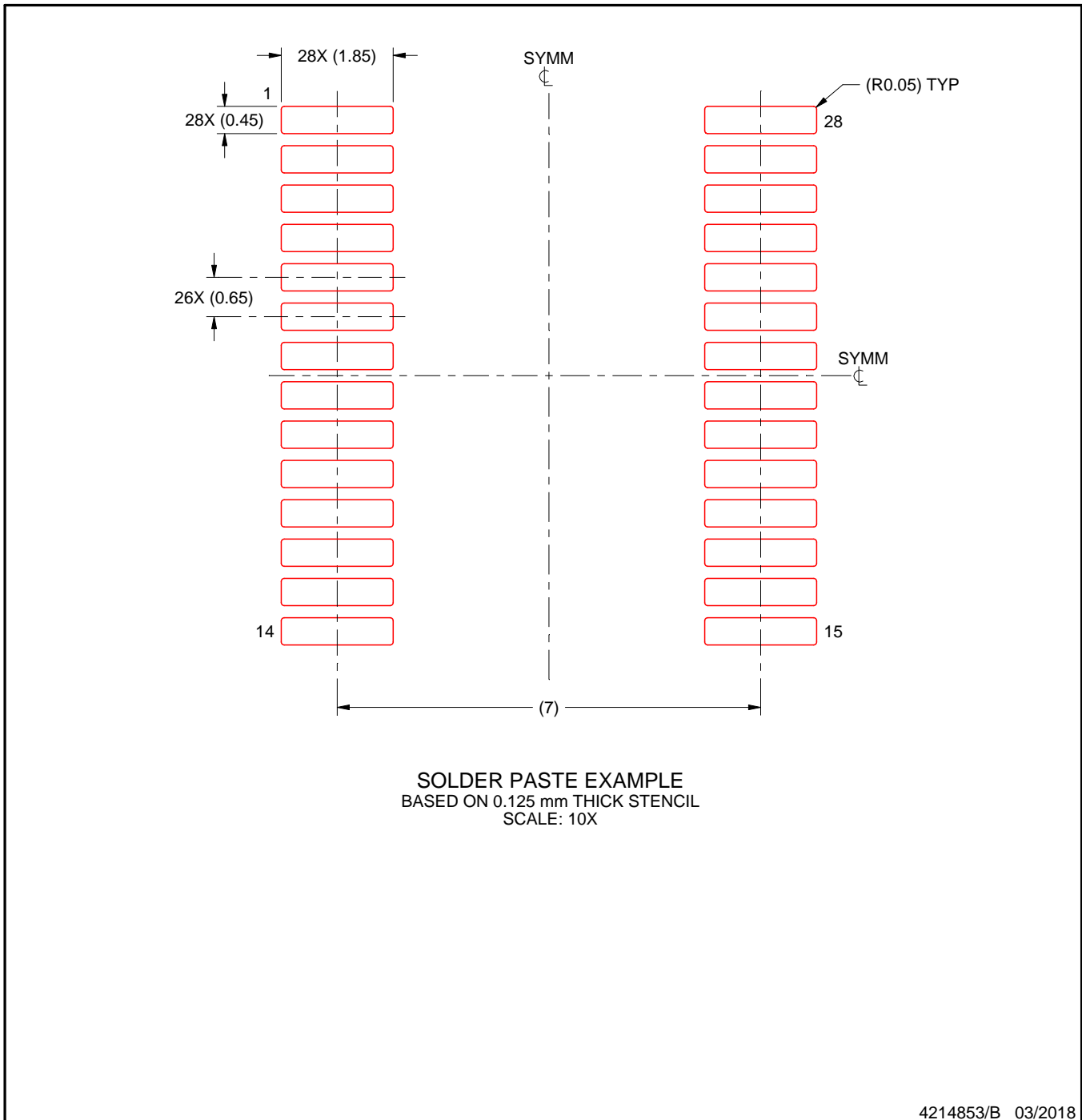

NOTES: (continued)

8. Laser cutting apertures with trapezoidal walls and rounded corners may offer better paste release. IPC-7525 may have alternate design recommendations.
9. Board assembly site may have different recommendations for stencil design.

IMPORTANT NOTICE AND DISCLAIMER

TI PROVIDES TECHNICAL AND RELIABILITY DATA (INCLUDING DATA SHEETS), DESIGN RESOURCES (INCLUDING REFERENCE DESIGNS), APPLICATION OR OTHER DESIGN ADVICE, WEB TOOLS, SAFETY INFORMATION, AND OTHER RESOURCES "AS IS" AND WITH ALL FAULTS, AND DISCLAIMS ALL WARRANTIES, EXPRESS AND IMPLIED, INCLUDING WITHOUT LIMITATION ANY IMPLIED WARRANTIES OF MERCHANTABILITY, FITNESS FOR A PARTICULAR PURPOSE OR NON-INFRINGEMENT OF THIRD PARTY INTELLECTUAL PROPERTY RIGHTS.

These resources are intended for skilled developers designing with TI products. You are solely responsible for (1) selecting the appropriate TI products for your application, (2) designing, validating and testing your application, and (3) ensuring your application meets applicable standards, and any other safety, security, regulatory or other requirements.

These resources are subject to change without notice. TI grants you permission to use these resources only for development of an application that uses the TI products described in the resource. Other reproduction and display of these resources is prohibited. No license is granted to any other TI intellectual property right or to any third party intellectual property right. TI disclaims responsibility for, and you will fully indemnify TI and its representatives against, any claims, damages, costs, losses, and liabilities arising out of your use of these resources.

TI's products are provided subject to [TI's Terms of Sale](#) or other applicable terms available either on [ti.com](https://www.ti.com) or provided in conjunction with such TI products. TI's provision of these resources does not expand or otherwise alter TI's applicable warranties or warranty disclaimers for TI products.

TI objects to and rejects any additional or different terms you may have proposed.

Mailing Address: Texas Instruments, Post Office Box 655303, Dallas, Texas 75265

Copyright © 2025, Texas Instruments Incorporated