

RC4558 Dual General-Purpose Operational Amplifier

1 Features

- Wide common-mode and differential voltage ranges
- No frequency compensation required
- Low power consumption
- No latch-up
- Gain bandwidth product: 4MHz typical
- Gain and phase match between amplifiers
- Low noise: 6.5nV/ $\sqrt{\text{Hz}}$ typical at 10kHz
- Low distortion and noise: 0.0001% at 1kHz

2 Applications

- [AV receivers](#)
- [Professional audio mixers](#)
- [Soundbars](#)
- [Wireless speakers](#)

3 Description

The RC4558 device is a dual general-purpose operational amplifier. The combination of the wide supply voltage range (10V to 30V), low noise (6.5nV/ $\sqrt{\text{Hz}}$), and distortion performance (0.0001% THD+N) of the device allow the RC4558 to be used in various audio applications.

The high common-mode input voltage range and the absence of latch-up of the device are designed for voltage-follower applications. The internal frequency compensation of the device allows for stability without external components.

Package Information (1)

PART NUMBER	PACKAGE	PACKAGE SIZE ⁽²⁾
RC4558	D (SOIC, 8)	4.9mm × 6mm
	DGK (VSSOP, 8)	3mm × 4.9mm
	P (PDIP, 8)	9.81mm × 9.43mm
	PW (TSSOP, 8)	3mm × 6.4mm
	PS (SOP, 8)	6.2mm × 7.8mm

- (1) For all available packages, see [Section 10](#).
 (2) The package size (length × width) is a nominal value and includes pins, where applicable.

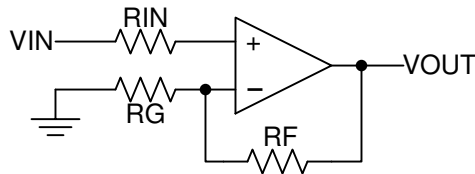

Noninverting Amplifier Schematic



Table of Contents

1 Features	1	6.3 Feature Description.....	12
2 Applications	1	6.4 Device Functional Modes.....	12
3 Description	1	7 Application and Implementation	13
4 Pin Configuration and Functions	3	7.1 Application Information.....	13
5 Specifications	4	7.2 Typical Application.....	13
5.1 Absolute Maximum Ratings.....	4	7.3 Power Supply Recommendations.....	16
5.2 ESD Ratings.....	4	7.4 Layout.....	16
5.3 Recommended Operating Conditions.....	4	8 Device and Documentation Support	18
5.4 Thermal Information.....	5	8.1 Trademarks.....	18
5.5 Electrical Characteristics.....	6	8.2 Electrostatic Discharge Caution.....	18
5.6 Typical Characteristics.....	7	8.3 Glossary.....	18
6 Detailed Description	12	9 Revision History	18
6.1 Overview.....	12	10 Mechanical, Packaging, and Orderable Information	19
6.2 Functional Block Diagram.....	12		

4 Pin Configuration and Functions

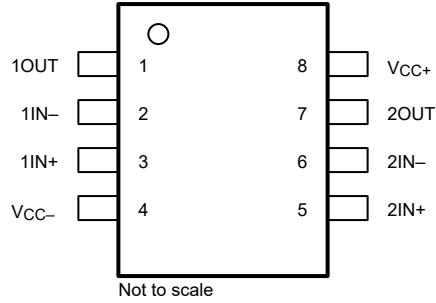

**Figure 4-1. D, DGK, P, PS, or PW Package
8-Pin SOIC, VSSOP, PDIP, TSSOP or SOP
(Top View)**

Table 4-1. Pin Functions

PIN		TYPE	DESCRIPTION
NAME	NO.		
1IN+	3	I	Noninverting input
1IN-	2	I	Inverting Input
1OUT	1	O	Output
2IN+	5	I	Noninverting input
2IN-	6	I	Inverting Input
2OUT	7	O	Output
V _{CC+}	8	—	Positive Supply
V _{CC-}	4	—	Negative Supply

5 Specifications

5.1 Absolute Maximum Ratings

over operating ambient temperature range (unless otherwise noted)⁽¹⁾

		MIN	MAX	UNIT
V _{CC+}	Supply voltage ⁽²⁾		18	V
V _{CC-}			-18	
V _{ID}	Differential input voltage ⁽³⁾		±30	V
V _I	Input voltage (any input) ^{(2) (4)}		±15	V
I _O	Output Current ⁽⁵⁾		±125	mA
T _J	Operating virtual junction temperature		150	°C
T _{STG}	Storage temperature	-65	150	°C

- (1) Operation outside the Absolute Maximum Ratings may cause permanent device damage. Absolute Maximum Ratings do not imply functional operation of the device at these or any other conditions beyond those listed under Recommended Operating Conditions. If used outside the Recommended Operating Conditions but within the Absolute Maximum Ratings, the device may not be fully functional, and this may affect device reliability, functionality, performance, and shorten the device lifetime.
- (2) All voltage values, unless otherwise noted, are with respect to the midpoint between V_{CC+} and V_{CC-}.
- (3) Differential voltages are at IN+ with respect to IN-.
- (4) The magnitude of the input voltage must never exceed the magnitude of the supply voltage or 15V, whichever is less.
- (5) Temperature and supply voltages must be limited to ensure that the dissipation rating is not exceeded.

5.2 ESD Ratings

		VALUE	UNIT
V _(ESD)	Electrostatic discharge	Human-body model (HBM), per ANSI/ESDA/JEDEC JS-001 ⁽¹⁾	±2500
		Charged-device model (CDM), per ANSI/ESDA/JEDEC JS-002 ⁽²⁾	±1500

- (1) JEDEC document JEP155 states that 500V HBM allows safe manufacturing with a standard ESD control process.
- (2) JEDEC document JEP157 states that 250V CDM allows safe manufacturing with a standard ESD control process.

5.3 Recommended Operating Conditions

		MIN	MAX	UNIT
V _{CC+}	Supply voltage	5	15	V
V _{CC-}		-5	-15	
T _A	Operating free-air temperature	RC4558	0	70
		RC4558I	-40	85

5.4 Thermal Information

THERMAL METRIC ⁽¹⁾		RC4558					Unit
		D (SOIC)	DGK (VSSOP)	P (PDIP)	PS (SOP)	PW (TSSOP)	
		8 PINS	8 PINS	8 PINS	8 PINS	8 PINS	
R _{θJA}	Junction-to-ambient thermal resistance	120.2	164.8	106	122.9	173.1	°C/W
R _{θJC(top)}	Junction-to-case (top) thermal resistance	59.6	58.8	84.9	60.1	81.8	°C/W
R _{θJB}	Junction-to-board thermal resistance	67.7	99.5	68.6	77.5	112.5	°C/W
ψ _{JT}	Junction-to-top characterization parameter	11.0	3.7	51.6	15.7	16.5	°C/W
ψ _{JB}	Junction-to-board characterization parameter	66.7	97.7	67.8	76.0	110.7	°C/W
R _{θJC(bot)}	Junction-to-case (bottom) thermal resistance	N/A	N/A	N/A	N/A	N/A	°C/W

(1) For more information about traditional and new thermal metrics, see the [Semiconductor and IC Package Thermal Metrics](#) application note.

5.5 Electrical Characteristics

For $V_{CC+} = 15\text{ V}$, $V_{CC-} = -15\text{ V}$ at $T_A \cong 25^\circ\text{C}$, $R_L = 2\text{ k}\Omega$ unless otherwise noted.

PARAMETER		TEST CONDITIONS ⁽¹⁾	T_A	MIN	TYP	MAX	UNIT	
V_{OS}	Input offset voltage	$V_O = 0\text{V}$			0.3	6	mV	
			Full range ⁽²⁾			7.5		
I_{IO}	Input offset current	$V_O = 0\text{V}$			5	200	nA	
			Full range ⁽²⁾			300		
I_{IB}	Input bias current	$V_O = 0\text{V}$			80	500	nA	
			Full range ⁽²⁾			800		
V_{ICR}	Common-mode input voltage range			± 12	± 14		V	
V_{OUT}	Maximum output voltage swing	$R_L = 10\text{ k}\Omega$		± 12	± 14.1		V	
			$R_L = 2\text{ k}\Omega$		± 10	± 13.8		
				Full range ⁽²⁾		± 10		
A_{VD}	Large-signal differential voltage amplification	$R_L \geq 2\text{ k}\Omega$, $V_O = \pm 10\text{V}$		20	830		V/mV	
				86	118		dB	
			Full range ⁽²⁾		15			V/mV
					83			dB
GBW	Gain-bandwidth product	$f = 10\text{ kHz}$		4		MHz		
SSBW	Small-signal bandwidth	$V_O = 200\text{ mV}_{PP}$, $< 1\text{ dB}$ peaking		3		MHz		
CMRR	Common-mode rejection ratio	$(V-) + 3\text{V} < V_{ICR} < (V+) - 3\text{V}$		70	94		dB	
	Input impedance	Common-mode		550 5.6			M Ω pF	
		Differential		450 0.8			k Ω pF	
k_{SVS}	Supply-voltage sensitivity ($\Delta V_{IO}/\Delta V_{CC}$)	$V_{CC} = \pm 5\text{V}$ to $\pm 15\text{V}$		25	150		$\mu\text{V}/\text{V}$	
				76	92		dB	
e_N	Input voltage noise	$f = 0.1\text{ Hz}$ to 10 Hz		0.38			μV_{PP}	
				0.063			μV_{RMS}	
	Input voltage noise density		$f = 1\text{ kHz}$	7			nV/ $\sqrt{\text{Hz}}$	
		$f = 10\text{ kHz}$	6.5					
I_N	Input current noise density	$f = 1\text{ kHz}$		0.15			pA/ $\sqrt{\text{Hz}}$	
THD+N	Total harmonic distortion + noise	$V_{CC} = 30\text{V}$, $A_{VD} = 1\text{V}/\text{V}$, $f = 1\text{ kHz}$, $V_O = 3\text{V}_{RMS}$, $R_L = 2\text{ k}\Omega$		0.0001			%	
				120			dB	
I_{CC}	Supply current (both amplifiers)	$V_O = 0\text{V}$, No load		2.5	5.6		mA	
			Full range ⁽²⁾		2.65	6.6		
V_{O1}/V_{O2}	Crosstalk attenuation	$R_S = 1\text{ k}\Omega$, $f = 10\text{ kHz}$, $A_{VD} = 1\text{V}/\text{V}$		120			dB	
t_r	Rise time	$V_I = 20\text{ mV}$, $C_L = 100\text{ pF}$		67			ns	
	Overshoot	$V_I = 20\text{ mV}$, $C_L = 100\text{ pF}$		16.8			%	
SR	Slew rate	$V_{STEP} = 10\text{V}$, $C_L = 100\text{ pF}$		1.1	2.2		V/ μs	

(1) All characteristics are measured under open-loop conditions with zero common-mode input voltage, unless otherwise specified.

(2) Full range is 0°C to 70°C for RC4558 and -40°C to 85°C for RC4558I.

5.6 Typical Characteristics

at $T_A \cong 25^\circ\text{C}$, $V_{CC} = 30\text{V} (\pm 15\text{V})$, $V_{CM} = V_{CC} / 2$, $R_L = 2\text{k}\Omega$ connected to $V_{CC} / 2$ (unless otherwise noted)

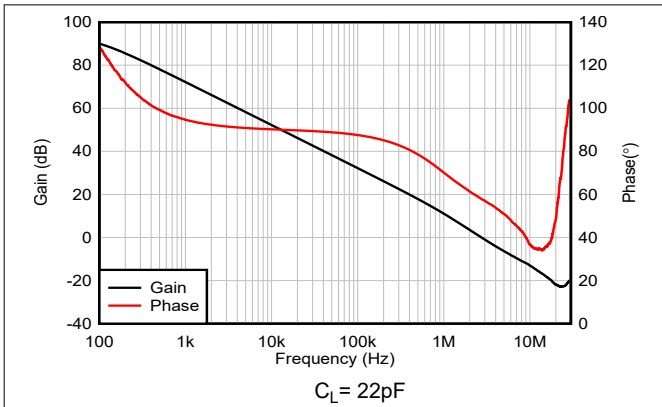

Figure 5-1. Open-Loop Gain and Phase vs Frequency

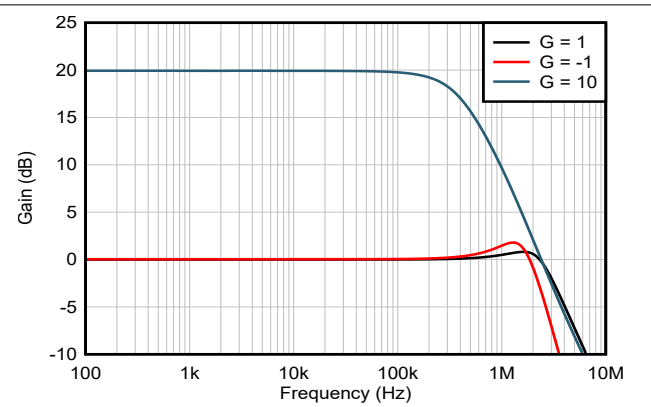

Figure 5-2. Closed-Loop Gain vs Frequency

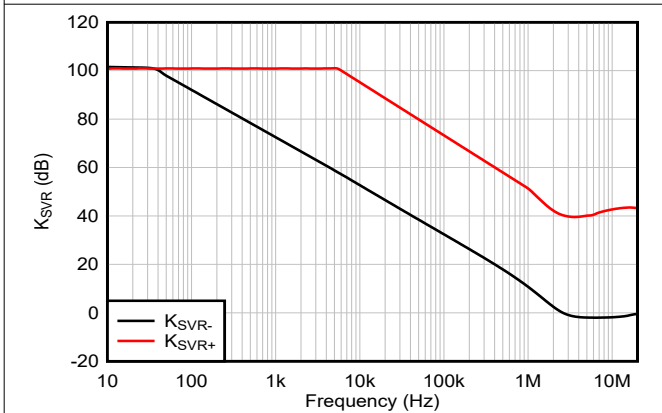

Figure 5-3. Supply Voltage Sensitivity vs Frequency

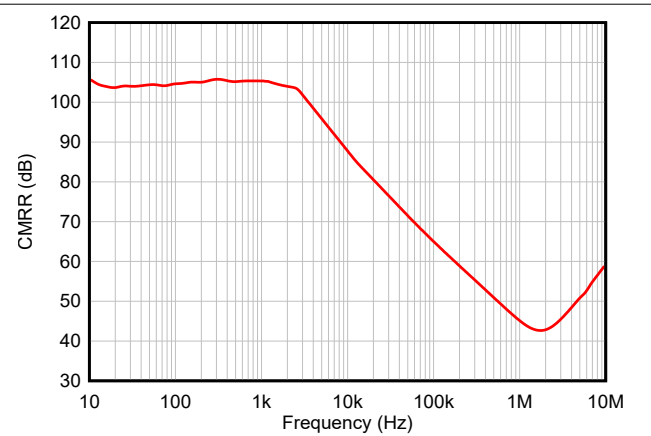

Figure 5-4. Common-Mode Rejection Ratio vs Frequency

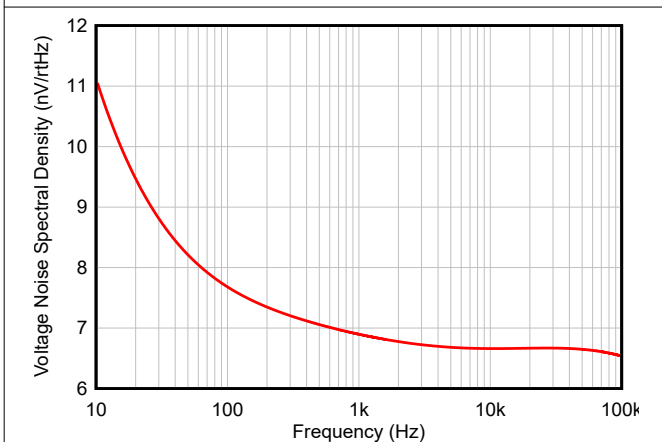

Figure 5-5. Input Noise Voltage vs Frequency

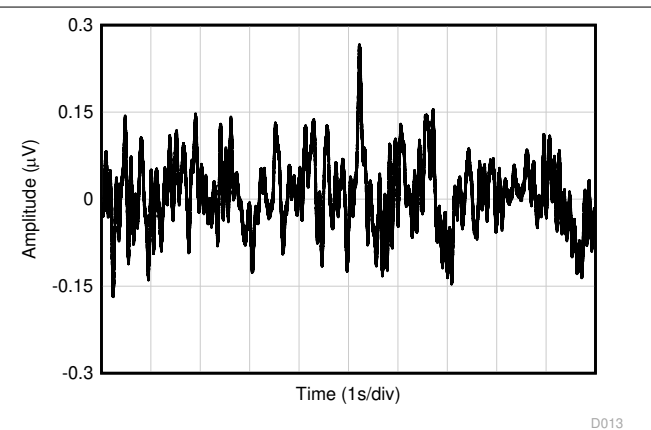

Figure 5-6. 0.1Hz to 10Hz Noise

D013

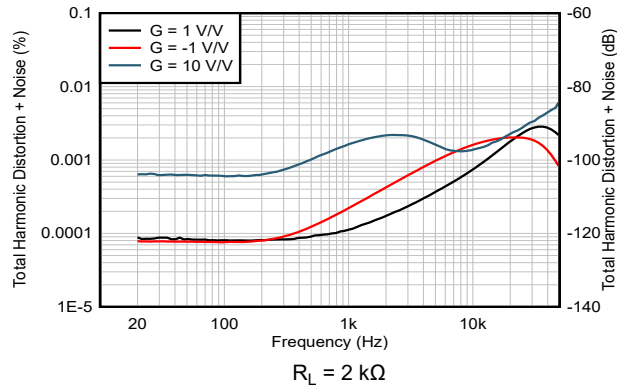

Figure 5-7. THD+N vs Frequency

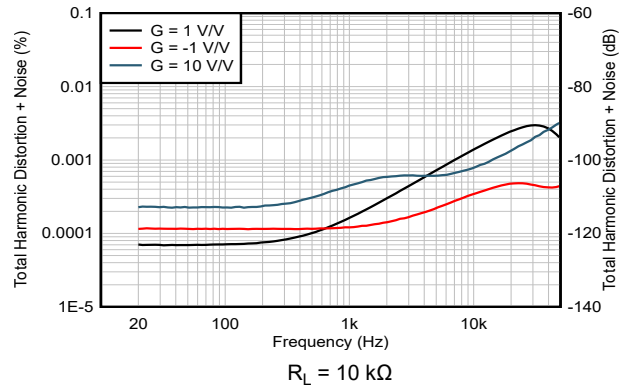

Figure 5-8. THD+N vs Frequency

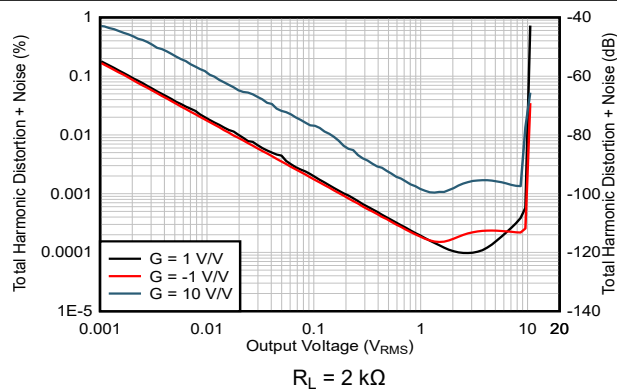

Figure 5-9. THD+N vs Amplitude

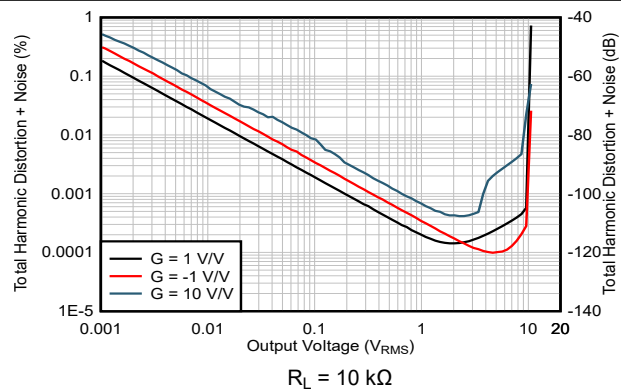

Figure 5-10. THD+N vs Amplitude

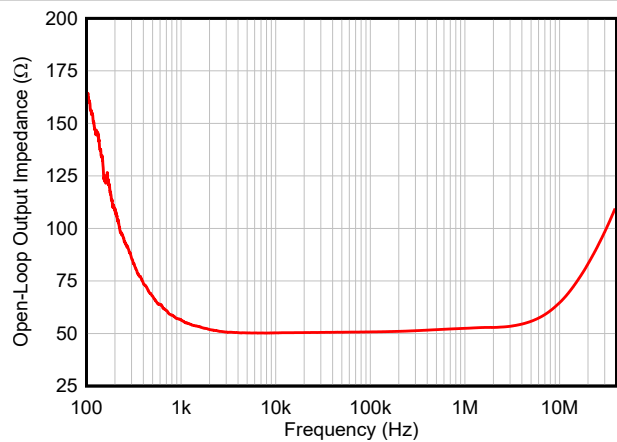

Figure 5-11. Open-Loop Output Impedance vs Frequency

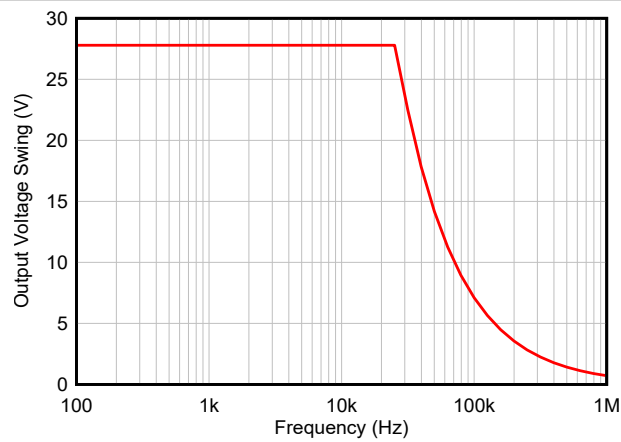

Figure 5-12. Output Voltage Swing vs Frequency

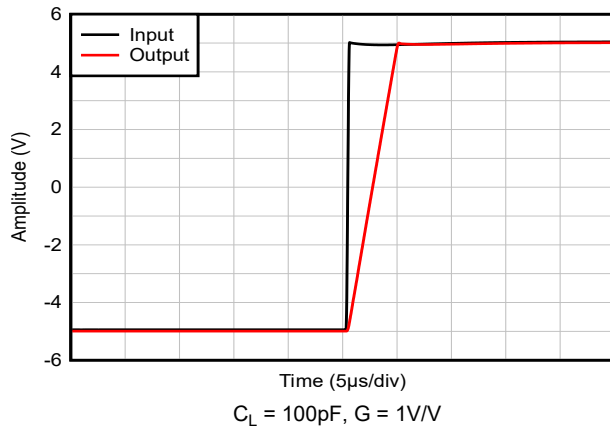

Figure 5-13. Large Signal Step Response

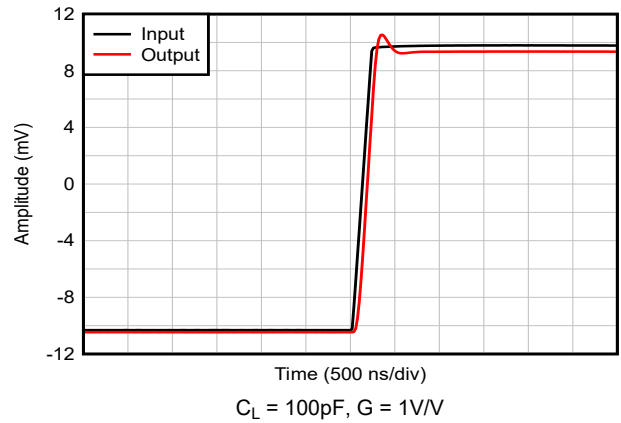

Figure 5-14. Small Signal Step Response

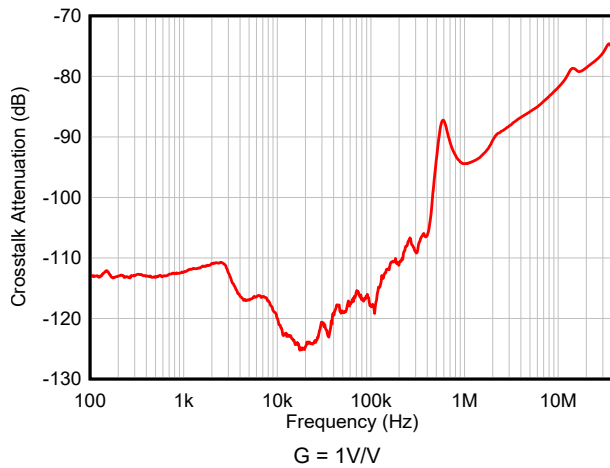

Figure 5-15. Crosstalk Attenuation vs Frequency

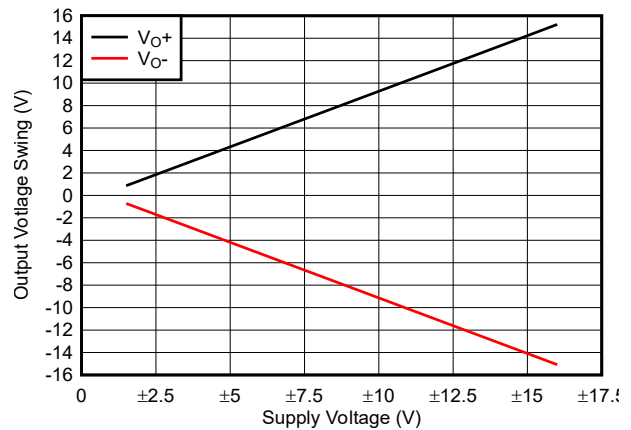

Figure 5-16. Maximum Output Voltage Swing vs Operating Voltage

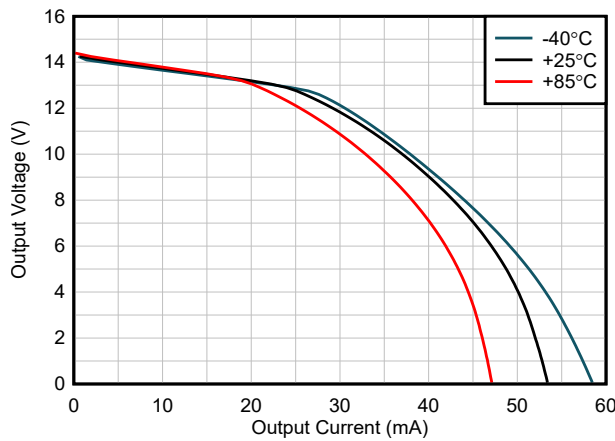

Figure 5-17. Output Voltage Swing vs Output Current (Sourcing)

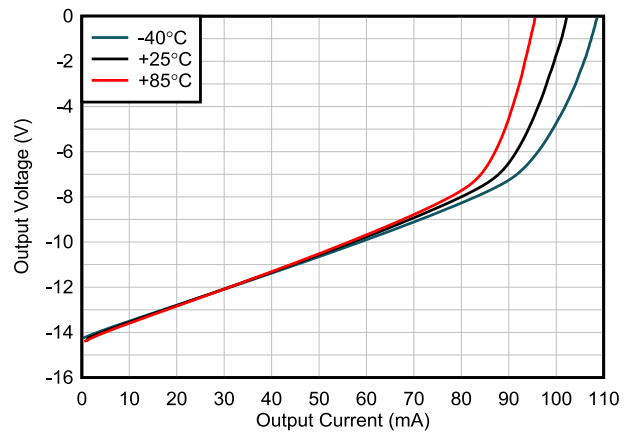

Figure 5-18. Output Voltage Swing vs Output Current (Sinking)

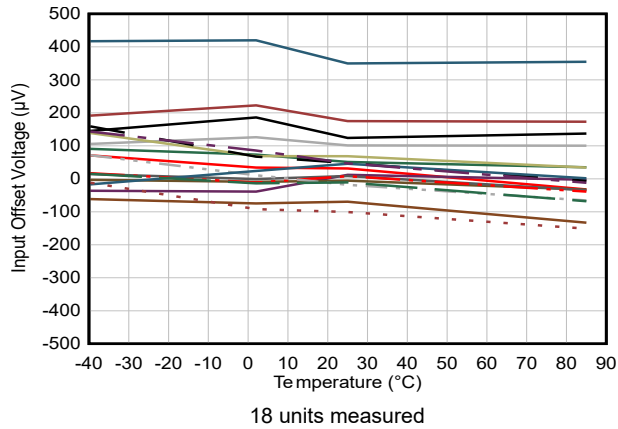

Figure 5-19. Offset Voltage vs Temperature

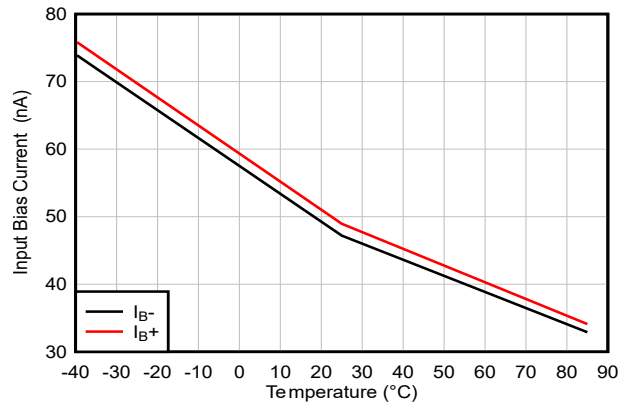

Figure 5-20. Bias Current vs Temperature

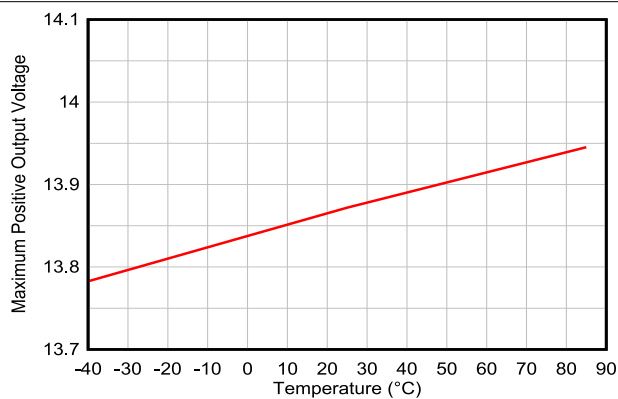

Figure 5-21. Positive Output Voltage Swing vs Temperature

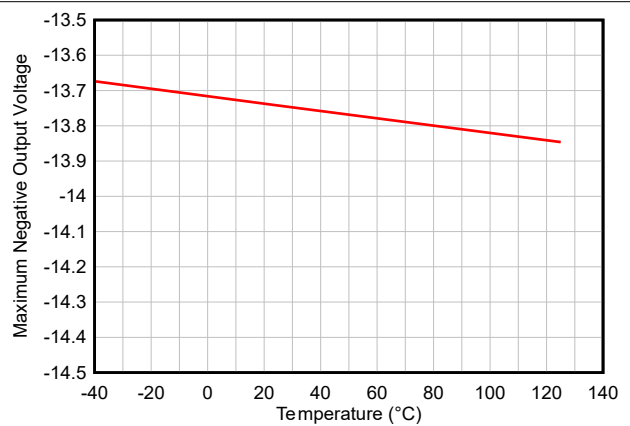

Figure 5-22. Negative Output Voltage Swing vs Temperature

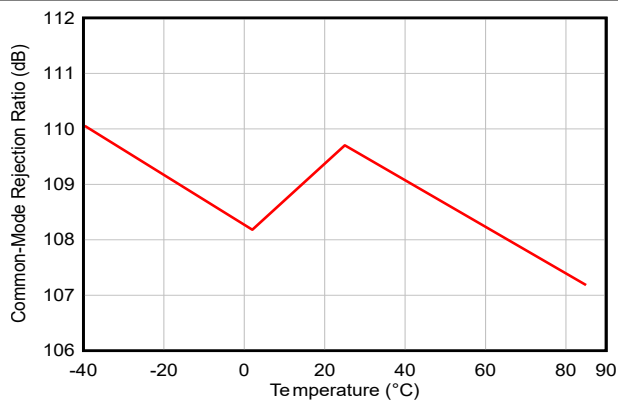

Figure 5-23. Common-Mode Rejection Ratio vs Temperature

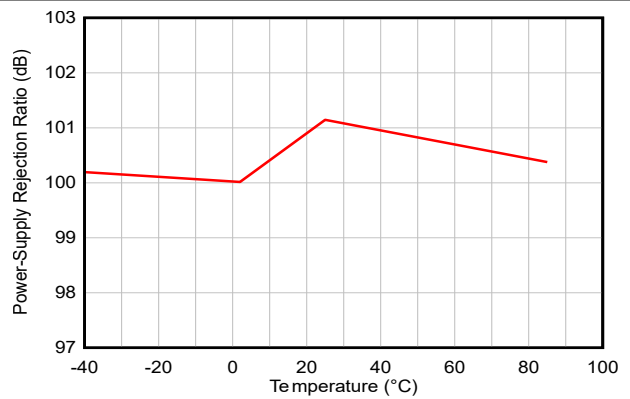

Figure 5-24. Power Supply Rejection Ratio vs Temperature

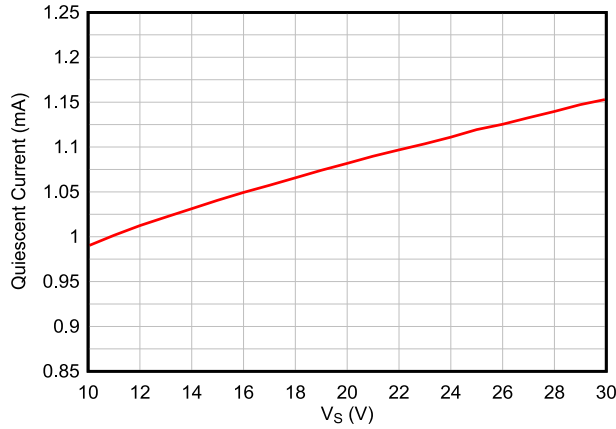

Figure 5-25. Supply Current vs Supply Voltage

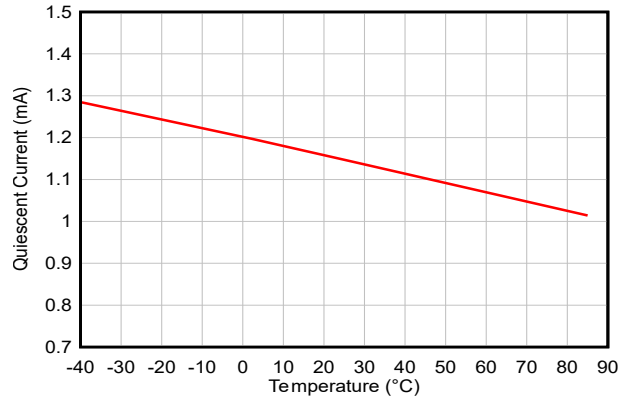

Figure 5-26. Supply Current vs Temperature

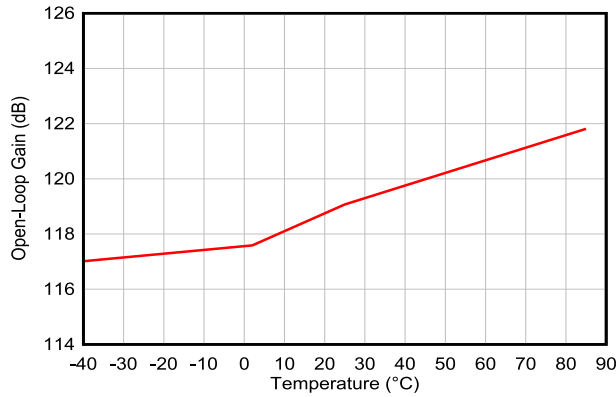

Figure 5-27. Open-Loop Gain vs Temperature

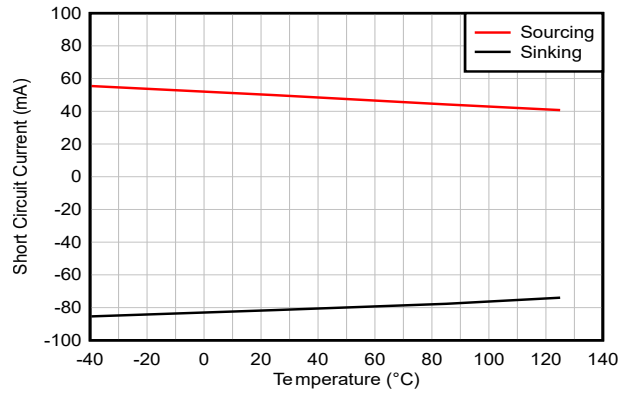

Figure 5-28. Short-Circuit Current vs Temperature

6 Detailed Description

6.1 Overview

The RC4558 device is a dual general-purpose operational amplifier. The combination of the wide supply voltage range (10V to 30V), low noise ($6.5\text{nV}/\sqrt{\text{Hz}}$), and distortion performance (0.0001% THD+N) of the device allow the RC4558 to be used in various audio applications.

The high common-mode input voltage range and the absence of latch-up of this device are designed for voltage-follower applications. The internal frequency compensation of the device allows for stability without external components.

6.2 Functional Block Diagram

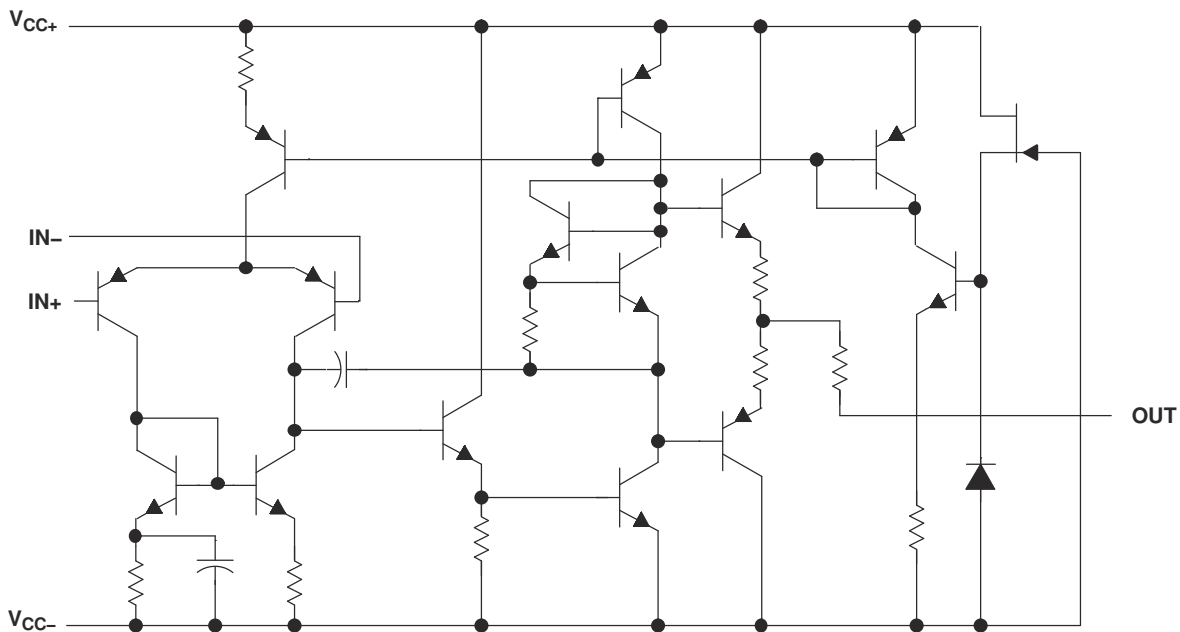

6.3 Feature Description

6.3.1 Unity-Gain Bandwidth

The unity-gain bandwidth is the frequency up to which an amplifier with a unity gain can be operated without greatly distorting the signal. The RC4558 device has a 4MHz gain-bandwidth product.

6.3.2 Common-Mode Rejection Ratio

The common-mode rejection ratio (CMRR) of an amplifier is a measure of how well the device rejects unwanted input signals common to both input leads. The CMRR is found by taking the ratio of the change in input offset voltage to the change in the input voltage, then converting the ratio to decibels. Ideally the CMRR is infinite, but in practice, amplifiers are designed to have the CMRR as high as possible. The CMRR of the RC4558 device is 94dB.

6.3.3 Slew Rate

The slew rate is the rate at which an operational amplifier can change the output when there is a change on the input. The RC4558 device has a $2.2\text{V}/\mu\text{s}$ slew rate.

6.4 Device Functional Modes

The RC4558 device is powered on when the supply is connected. Each of these devices can be operated as a single-supply operational amplifier or dual-supply amplifier depending on the application.

7 Application and Implementation

Note

Information in the following applications sections is not part of the TI component specification, and TI does not warrant its accuracy or completeness. TI's customers are responsible for determining suitability of components for their purposes, as well as validating and testing their design implementation to confirm system functionality.

7.1 Application Information

The RC4558 is a dual general-purpose device that offers a wide supply range and excellent AC performance. This device operates up to 30V supply rails and offers low noise ($6.5\text{nV}/\sqrt{\text{Hz}}$) and distortion performance (0.0001% THD+N). These RC4558 features are designed for both audio and industrial applications.

7.2 Typical Application

Some applications require differential signals. [Figure 7-1](#) shows a simple circuit to convert a single-ended input of 2V to 10V into differential output of $\pm 8\text{V}$ on a single 15V supply. The output range is intentionally limited to maximize linearity. The circuit is composed of two amplifiers. One amplifier acts as a buffer and creates a voltage, $V_{\text{OUT}+}$. The second amplifier inverts the input and adds a reference voltage to generate $V_{\text{OUT}-}$. Both $V_{\text{OUT}+}$ and $V_{\text{OUT}-}$ range from 2V to 10V. The difference, V_{DIFF} , is the difference between $V_{\text{OUT}+}$ and $V_{\text{OUT}-}$.

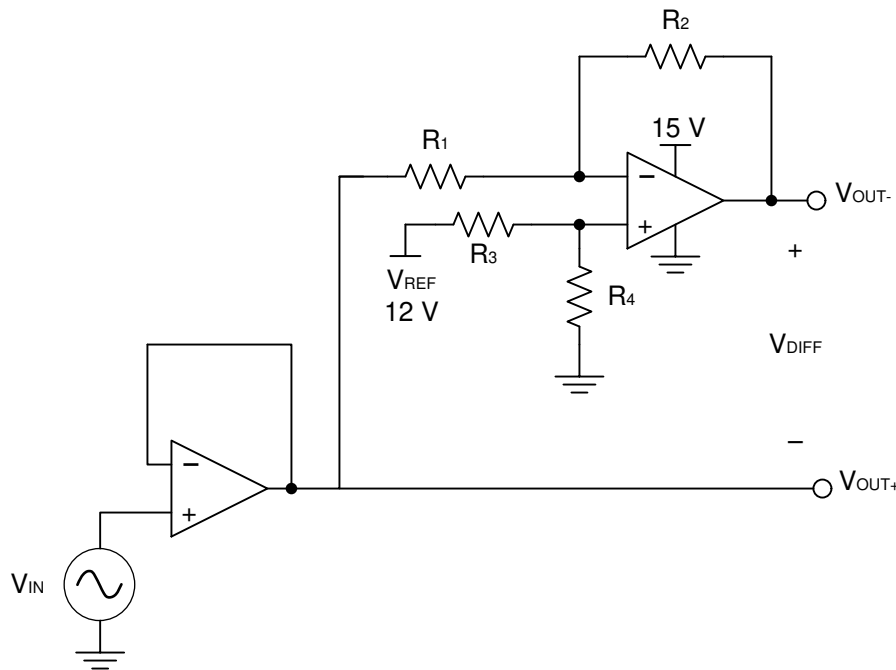

Figure 7-1. Schematic for Single-Ended Input to Differential Output Conversion

7.2.1 Design Requirements

The design requirements are as follows:

- Supply voltage: 15V
- Reference voltage: 12V
- Input: 2V to 10V
- Output differential: $\pm 8V$

7.2.2 Detailed Design Procedure

The circuit in [Figure 7-1](#) takes a single-ended input signal, V_{IN} , and generates two output signals, V_{OUT+} and V_{OUT-} , using two amplifiers and a reference voltage, V_{REF} . V_{OUT+} is the output of the first amplifier and is a buffered version of the input signal, V_{IN} (see [Equation 1](#)). V_{OUT-} is the output of the second amplifier which uses V_{REF} to add an offset voltage to V_{IN} and feedback to add inverting gain. The transfer function for V_{OUT-} is [Equation 2](#).

$$V_{OUT+} = V_{IN} \quad (1)$$

$$V_{OUT-} = V_{REF} \times \left(\frac{R_4}{R_3 + R_4} \right) \times \left(1 + \frac{R_2}{R_1} \right) - V_{IN} \times \frac{R_2}{R_1} \quad (2)$$

The differential output signal, V_{DIFF} , is the difference between the two single-ended output signals, V_{OUT+} and V_{OUT-} . [Equation 3](#) shows the transfer function for V_{DIFF} . By applying the conditions that $R_1 = R_2$ and $R_3 = R_4$, the transfer function is simplified into [Equation 6](#). Using this configuration, the maximum input signal is equal to the reference voltage and the maximum output of each amplifier is equal to the V_{REF} . The differential output range is $2 \times V_{REF}$. Furthermore, the common-mode voltage is one half of V_{REF} (see [Equation 7](#)).

$$V_{DIFF} = V_{OUT+} - V_{OUT-} = V_{IN} \times \left(1 + \frac{R_2}{R_1} \right) - V_{REF} \times \left(\frac{R_4}{R_3 + R_4} \right) \left(1 + \frac{R_2}{R_1} \right) \quad (3)$$

$$V_{OUT+} = V_{IN} \quad (4)$$

$$V_{OUT-} = V_{REF} - V_{IN} \quad (5)$$

$$V_{DIFF} = 2 \times V_{IN} - V_{REF} \quad (6)$$

$$V_{CM} = \left(\frac{V_{OUT+} + V_{OUT-}}{2} \right) = \frac{1}{2} V_{REF} \quad (7)$$

7.2.2.1 Amplifier Selection

Linearity over the input range is key for good DC accuracy. The common-mode input range and the output swing limitations determine the linearity. In general, an amplifier with rail-to-rail input and output swing is required. Bandwidth is a key concern for this design. The RC4558 device has a bandwidth of 4MHz, therefore this circuit can only process signals with frequencies of less than 4MHz.

7.2.2.2 Passive Component Selection

The transfer function of V_{OUT-} is heavily reliant on resistors (R_1 , R_2 , R_3 , and R_4), therefore TI recommends to use resistors with low tolerances to maximize performance and minimize error. This design uses resistors with resistance values of

36k Ω with tolerances measured to be within 2% of these resistor values. If the noise of the system is a key parameter, the user can select smaller resistance values (6k Ω or lower) to keep the overall system noise low and the noise from the resistors lower than the amplifier noise.

7.2.3 Application Curves

The measured transfer functions in [Figure 7-2](#), [Figure 7-3](#), and [Figure 7-4](#) were generated by sweeping the input voltage from 0V to 12V. However, this design must only be used between 2V and 10V for optimum linearity.

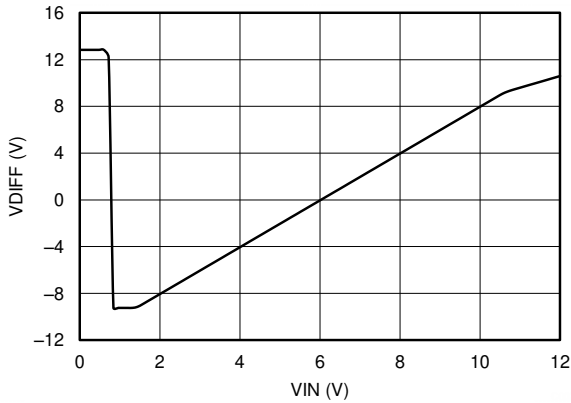

Figure 7-2. Differential Output Voltage Node vs Input Voltage

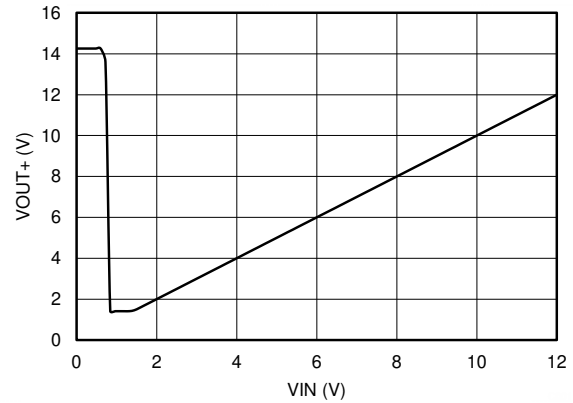

Figure 7-3. Positive Output Voltage Node vs Input Voltage

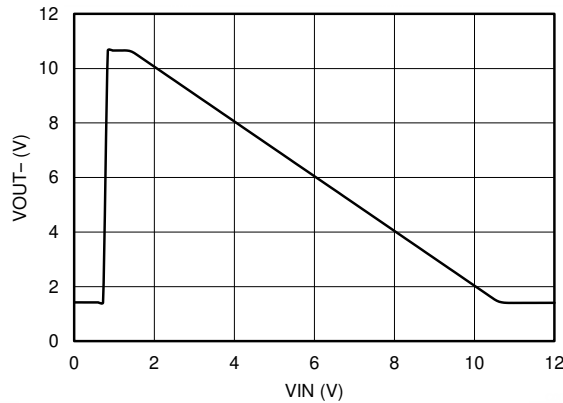

Figure 7-4. Positive Output Voltage Node vs Input Voltage

7.3 Power Supply Recommendations

The RC4558 device is specified for $\pm 5\text{V}$ to $\pm 15\text{V}$ operation; many specifications apply for -0°C to 70°C . The [Typical Characteristics](#) section presents parameters that can exhibit significant variance with regard to operating voltage or temperature.

CAUTION

Supply voltages outside of the $\pm 18\text{V}$ range can permanently damage the device (see the [Absolute Maximum Ratings](#)).

Place $0.1\mu\text{F}$ bypass capacitors close to the power-supply pins to reduce errors coupling in from noisy or high impedance power supplies. For more detailed information on bypass capacitor placement, refer to the [Layout Guidelines](#).

7.4 Layout

7.4.1 Layout Guidelines

For best operational performance of the device, use good printed circuit board (PCB) layout practices, including:

- Noise can propagate into analog circuitry through the operational amplifier and the power pins of the circuit as a whole. Bypass capacitors are used to reduce the coupled noise by providing low impedance power sources local to the analog circuitry.
 - Connect low-ESR, $0.1\mu\text{F}$ ceramic bypass capacitors between each supply pin and ground, placed as close to the device as possible. A single bypass capacitor from $V+$ to ground is applicable for single-supply applications.
- Separating grounding for analog and digital portions of circuitry is one of the simplest and most effective methods of noise suppression. One or more layers on multilayer PCBs are usually devoted to ground planes. A ground plane helps distribute heat and reduces EMI noise pickup. Make sure to physically separate digital and analog grounds, paying attention to the flow of the ground current.
- To reduce parasitic coupling, run the input traces as far away from the supply or output traces as possible. If it is not possible to keep the traces separate, it is much better to cross the sensitive trace perpendicular as opposed to in parallel with the noisy trace.
- Place the external components as close to the device as possible. Keeping R_F and R_G close to the inverting input minimizes parasitic capacitance, as shown in [Layout Example](#).
- Keep the length of input traces as short as possible. Always remember that the input traces are the most sensitive part of the circuit.
- Consider a driven, low-impedance guard ring around the critical traces. A guard ring can significantly reduce leakage currents from nearby traces that are at different potentials.

7.4.2 Layout Example

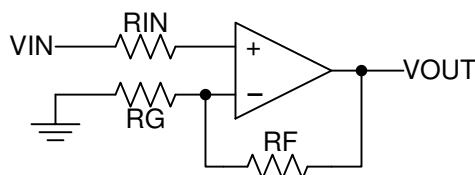

Figure 7-5. Operational Amplifier Schematic for Noninverting Configuration

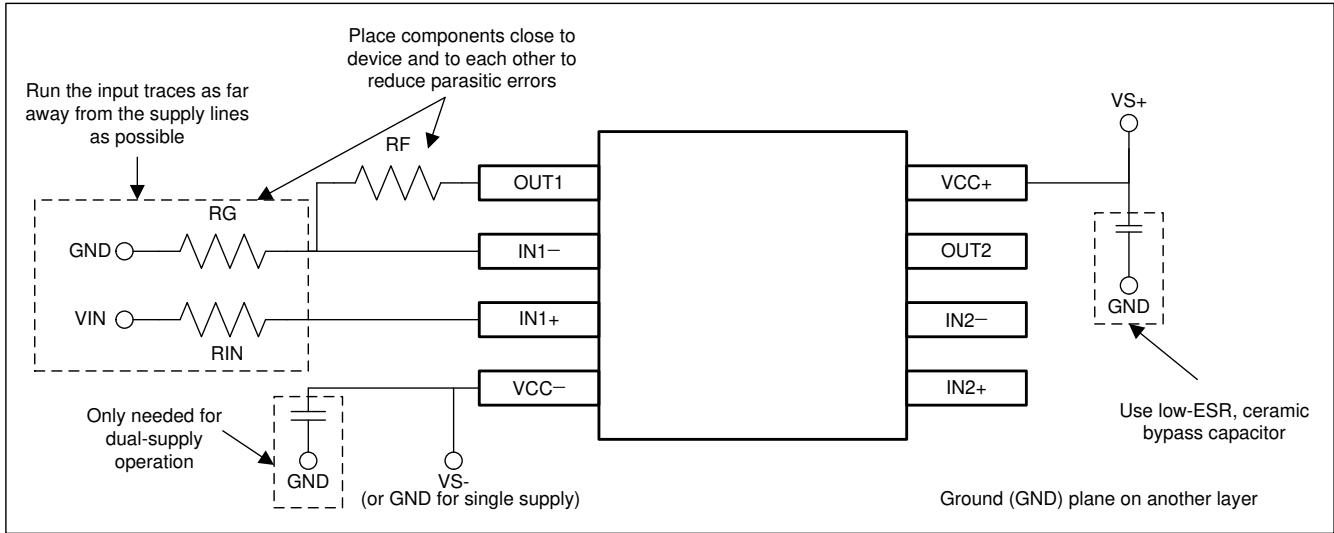

Figure 7-6. Operational Amplifier Board Layout for Noninverting Configuration

8 Device and Documentation Support

8.1 Trademarks

All trademarks are the property of their respective owners.

8.2 Electrostatic Discharge Caution



This integrated circuit can be damaged by ESD. Texas Instruments recommends that all integrated circuits be handled with appropriate precautions. Failure to observe proper handling and installation procedures can cause damage.

ESD damage can range from subtle performance degradation to complete device failure. Precision integrated circuits may be more susceptible to damage because very small parametric changes could cause the device not to meet its published specifications.

8.3 Glossary

[SLYZ022](#) — TI Glossary.

This glossary lists and explains terms, acronyms and definitions.

9 Revision History

Changes from Revision G (November 2014) to Revision H (October 2024)	Page
• Updated <i>Features, Applications, Description, Detailed Description, Feature Description, Detailed Design Procedure</i> , and <i>Layout Guidelines</i> sections to reflect the changes listed in the Specifications section.....	1
• Changed <i>Device Information</i> table to <i>Package Information</i>	1
• Removed <i>Duration of output short circuit to ground</i> specification and added maximum output current of $\pm 125\text{mA}$ in <i>Absolute Maximum Ratings</i> table.....	4
• Updated <i>Handling Ratings</i> table to <i>ESD Ratings</i> table.....	4
• Updated <i>Thermal Information</i> table.....	5
• Changed the typical <i>input offset voltage</i> value from: 0.5mV to 0.3mV in the <i>Electrical Characteristics</i> table....	6
• Changed the typical <i>Input bias current</i> value from: 150nA to 80nA in the <i>Electrical Characteristics</i> table.....	6
• Changed the typical <i>maximum output voltage swing</i> value at $R_L = 10\text{k}\Omega$ from $\pm 14\text{V}$ to $\pm 14.1\text{V}$ in the <i>Electrical Characteristics</i> table.....	6
• Changed the typical <i>maximum output voltage swing</i> value at $R_L = 2\text{k}\Omega$ from: $\pm 13\text{V}$ to $\pm 13.8\text{V}$ in the <i>Electrical Characteristics</i> table.....	6
• Changed the typical <i>large-signal differential voltage amplification</i> value from: 300V/mV to 830V/mV in the <i>Electrical Characteristics</i> table.....	6
• Added line items for the <i>large-signal voltage amplification</i> parameter to show values in dB units in the <i>Electrical Characteristics</i> table.....	6
• Changed <i>unity gain-bandwidth</i> parameter to <i>gain-bandwidth product</i> and changed the typical value from: 3MHz to 4MHz in the <i>Electrical Characteristics</i> table.....	6
• Added the <i>small-signal bandwidth</i> parameter in the <i>Electrical Characteristics</i> table.....	6
• Added test condition to the <i>common-mode rejection ratio</i> parameter in the <i>Electrical Characteristics</i> table....	6
• Changed the typical <i>common-mode rejection ratio</i> value from: 90dB to 94dB in the <i>Electrical Characteristics</i> table.....	6
• Removed the minimum limit for the <i>input resistance</i> parameter in the <i>Electrical Characteristics</i> table.....	6
• Updated the <i>input resistance</i> parameter to <i>input impedance</i> to better reflect device characteristics in the <i>Electrical Characteristics</i> table.....	6
• Changed the test condition of the <i>supply-voltage sensitivity</i> parameter from: $V_{CC} = \pm 15\text{V}$ to $\pm 9\text{V}$ to $V_{CC} = \pm 5\text{V}$ to $\pm 15\text{V}$ in the <i>Electrical Characteristics</i> table.....	6
• Updated the typical <i>supply-voltage sensitivity</i> value from: 30 $\mu\text{V/V}$ to 25 $\mu\text{V/V}$ in the <i>Electrical Characteristics</i> table.....	6
• Added line items for <i>supply-voltage sensitivity</i> parameter to show values in dB units in the <i>Electrical Characteristics</i> table.....	6
• Added <i>input voltage noise</i> parameter to the <i>Electrical Characteristics</i> table.....	6

• Changed test conditions of <i>equivalent input noise voltage (closed loop)</i> parameter to $f = 1$ kHz in the <i>Electrical Characteristics</i> table.....	6
• Changed typical <i>equivalent input noise voltage (closed loop)</i> at $f = 1$ kHz from 8 nV/ $\sqrt{\text{Hz}}$ to 7 nV/ $\sqrt{\text{Hz}}$ in the <i>Electrical Characteristics</i> table.....	6
• Changed <i>equivalent input noise voltage (closed loop)</i> specification to <i>input voltage noise density</i> in the <i>Electrical Characteristics</i> table.....	6
• Added $f = 10$ kHz test condition to <i>equivalent input noise voltage (closed loop)</i> specification in the <i>Electrical Characteristics</i> table.....	6
• Added the <i>input current noise density</i> parameter to the <i>Electrical Characteristics</i> table.....	6
• Removed the <i>total power dissipation</i> parameter in the <i>Electrical Characteristics</i> table.....	6
• Changed T_A min and T_A max conditions for supply current to one full range temperature condition in the <i>Electrical Characteristics</i> table.....	6
• Changed the typical <i>supply current (both amplifiers)</i> value at full temperature range from: 3 mA to 2.65 mA in the <i>Electrical Characteristics</i> table.....	6
• Changed the test condition for the <i>crosstalk attenuation</i> parameter from <i>Open loop</i> & $A_{VD} = 100$ V/V to $A_{VD} = 1$ V/V in the <i>Electrical Characteristics</i> table.....	6
• Changed the typical <i>crosstalk attenuation</i> value from: 105dB to 120 dB in the <i>Electrical Characteristics</i> table.....	6
• Changed the <i>rise time</i> typical value from: 0.13 ns to 67 ns in the <i>Electrical Characteristics</i> table.....	6
• Changed the <i>overshoot</i> typical value from: 5% to 16.8% in the <i>Electrical Characteristics</i> table.....	6
• Changed the <i>slew rate</i> typical value from: 1.7V/ μs to 2.2V/ μs in the <i>Electrical Characteristics</i> table.....	6
• Changed and added graphs to the <i>Typical Characteristics</i> section.....	7

Changes from Revision F (September 2010) to Revision G (November 2014)	Page
• Added <i>Applications</i> , <i>Device Information</i> table, <i>Handling Ratings</i> table, <i>Feature Description</i> section, <i>Device Functional Modes</i> , <i>Application and Implementation</i> section, <i>Power Supply Recommendations</i> section, <i>Layout</i> section, <i>Device and Documentation Support</i> section, and <i>Mechanical, Packaging, and Orderable Information</i> section.....	1
• Removed <i>Ordering Information</i> table.....	1

10 Mechanical, Packaging, and Orderable Information

The following pages include mechanical packaging and orderable information. This information is the most current data available for the designated devices. This data is subject to change without notice and revision of this document. For browser based versions of this data sheet, refer to the left hand navigation.

PACKAGING INFORMATION

Orderable Device	Status (1)	Package Type	Package Drawing	Pins	Package Qty	Eco Plan (2)	Lead finish/ Ball material (6)	MSL Peak Temp (3)	Op Temp (°C)	Device Marking (4/5)	Samples
RC4558D	OBSOLETE	SOIC	D	8		TBD	Call TI	Call TI	0 to 70	RC4558	
RC4558DGKR	ACTIVE	VSSOP	DGK	8	2500	RoHS & Green	NIPDAU NIPDAUAG	Level-1-260C-UNLIM	0 to 70	(YRP, YRS, YRU)	Samples
RC4558DGKRG4	ACTIVE	VSSOP	DGK	8	2500	TBD	Call TI	Call TI	0 to 70		Samples
RC4558DR	ACTIVE	SOIC	D	8	2500	RoHS & Green	NIPDAU SN	Level-1-260C-UNLIM	0 to 70	RC4558	Samples
RC4558DRG3	OBSOLETE	SOIC	D	8		TBD	Call TI	Call TI	0 to 70	RC4558	
RC4558DRG4	OBSOLETE	SOIC	D	8		TBD	Call TI	Call TI	0 to 70	RC4558	
RC4558ID	OBSOLETE	SOIC	D	8		TBD	Call TI	Call TI	-40 to 85	R4558I	
RC4558IDGKR	ACTIVE	VSSOP	DGK	8	2500	RoHS & Green	NIPDAU	Level-1-260C-UNLIM	-40 to 85	(YSP, YSS, YSU)	Samples
RC4558IDR	ACTIVE	SOIC	D	8	2500	RoHS & Green	NIPDAU	Level-1-260C-UNLIM	-40 to 85	R4558I	Samples
RC4558IP	ACTIVE	PDIP	P	8	50	RoHS & Green	NIPDAU	N / A for Pkg Type	-40 to 85	RC4558IP	Samples
RC4558IPW	OBSOLETE	TSSOP	PW	8		TBD	Call TI	Call TI	-40 to 85	R4558I	
RC4558IPWR	ACTIVE	TSSOP	PW	8	2000	RoHS & Green	NIPDAU SN	Level-1-260C-UNLIM	-40 to 85	R4558I	Samples
RC4558P	ACTIVE	PDIP	P	8	50	RoHS & Green	NIPDAU	N / A for Pkg Type	0 to 70	RC4558P	Samples
RC4558PSR	ACTIVE	SO	PS	8	2000	RoHS & Green	NIPDAU	Level-1-260C-UNLIM	0 to 70	R4558	Samples
RC4558PSRG4	ACTIVE	SO	PS	8	2000	RoHS & Green	NIPDAU	Level-1-260C-UNLIM	0 to 70	R4558	Samples
RC4558PW	OBSOLETE	TSSOP	PW	8		TBD	Call TI	Call TI	0 to 70	R4558	
RC4558PWR	ACTIVE	TSSOP	PW	8	2000	RoHS & Green	NIPDAU SN	Level-1-260C-UNLIM	0 to 70	R4558	Samples

(1) The marketing status values are defined as follows:

ACTIVE: Product device recommended for new designs.

LIFEBUY: TI has announced that the device will be discontinued, and a lifetime-buy period is in effect.

NRND: Not recommended for new designs. Device is in production to support existing customers, but TI does not recommend using this part in a new design.

PREVIEW: Device has been announced but is not in production. Samples may or may not be available.

OBSOLETE: TI has discontinued the production of the device.

(2) **RoHS:** TI defines "RoHS" to mean semiconductor products that are compliant with the current EU RoHS requirements for all 10 RoHS substances, including the requirement that RoHS substance do not exceed 0.1% by weight in homogeneous materials. Where designed to be soldered at high temperatures, "RoHS" products are suitable for use in specified lead-free processes. TI may reference these types of products as "Pb-Free".

RoHS Exempt: TI defines "RoHS Exempt" to mean products that contain lead but are compliant with EU RoHS pursuant to a specific EU RoHS exemption.

Green: TI defines "Green" to mean the content of Chlorine (Cl) and Bromine (Br) based flame retardants meet JS709B low halogen requirements of ≤ 1000 ppm threshold. Antimony trioxide based flame retardants must also meet the ≤ 1000 ppm threshold requirement.

(3) MSL, Peak Temp. - The Moisture Sensitivity Level rating according to the JEDEC industry standard classifications, and peak solder temperature.

(4) There may be additional marking, which relates to the logo, the lot trace code information, or the environmental category on the device.

(5) Multiple Device Markings will be inside parentheses. Only one Device Marking contained in parentheses and separated by a "~" will appear on a device. If a line is indented then it is a continuation of the previous line and the two combined represent the entire Device Marking for that device.

(6) Lead finish/Ball material - Orderable Devices may have multiple material finish options. Finish options are separated by a vertical ruled line. Lead finish/Ball material values may wrap to two lines if the finish value exceeds the maximum column width.

Important Information and Disclaimer: The information provided on this page represents TI's knowledge and belief as of the date that it is provided. TI bases its knowledge and belief on information provided by third parties, and makes no representation or warranty as to the accuracy of such information. Efforts are underway to better integrate information from third parties. TI has taken and continues to take reasonable steps to provide representative and accurate information but may not have conducted destructive testing or chemical analysis on incoming materials and chemicals. TI and TI suppliers consider certain information to be proprietary, and thus CAS numbers and other limited information may not be available for release.

In no event shall TI's liability arising out of such information exceed the total purchase price of the TI part(s) at issue in this document sold by TI to Customer on an annual basis.

TAPE AND REEL INFORMATION

QUADRANT ASSIGNMENTS FOR PIN 1 ORIENTATION IN TAPE

*All dimensions are nominal

Device	Package Type	Package Drawing	Pins	SPQ	Reel Diameter (mm)	Reel Width W1 (mm)	A0 (mm)	B0 (mm)	K0 (mm)	P1 (mm)	W (mm)	Pin1 Quadrant
RC4558DGKR	VSSOP	DGK	8	2500	330.0	12.4	5.3	3.3	1.3	8.0	12.0	Q1
RC4558DGKR	VSSOP	DGK	8	2500	330.0	12.4	5.3	3.4	1.4	8.0	12.0	Q1
RC4558DGKR	VSSOP	DGK	8	2500	330.0	12.4	5.3	3.4	1.4	8.0	12.0	Q1
RC4558DR	SOIC	D	8	2500	330.0	12.4	6.4	5.2	2.1	8.0	12.0	Q1
RC4558IDGKR	VSSOP	DGK	8	2500	330.0	12.4	5.3	3.4	1.4	8.0	12.0	Q1
RC4558IDGKR	VSSOP	DGK	8	2500	330.0	12.4	5.3	3.3	1.3	8.0	12.0	Q1
RC4558IDR	SOIC	D	8	2500	330.0	12.4	6.4	5.2	2.1	8.0	12.0	Q1
RC4558IPWR	TSSOP	PW	8	2000	330.0	12.4	7.0	3.6	1.6	8.0	12.0	Q1
RC4558IPWR	TSSOP	PW	8	2000	330.0	12.4	7.0	3.6	1.6	8.0	12.0	Q1
RC4558PSR	SO	PS	8	2000	330.0	16.4	8.35	6.6	2.4	12.0	16.0	Q1
RC4558PWR	TSSOP	PW	8	2000	330.0	12.4	7.0	3.6	1.6	8.0	12.0	Q1
RC4558PWR	TSSOP	PW	8	2000	330.0	12.4	7.0	3.6	1.6	8.0	12.0	Q1

TAPE AND REEL BOX DIMENSIONS

*All dimensions are nominal

Device	Package Type	Package Drawing	Pins	SPQ	Length (mm)	Width (mm)	Height (mm)
RC4558DGKR	VSSOP	DGK	8	2500	370.0	355.0	55.0
RC4558DGKR	VSSOP	DGK	8	2500	358.0	335.0	35.0
RC4558DGKR	VSSOP	DGK	8	2500	364.0	364.0	27.0
RC4558DR	SOIC	D	8	2500	353.0	353.0	32.0
RC4558IDGKR	VSSOP	DGK	8	2500	358.0	335.0	35.0
RC4558IDGKR	VSSOP	DGK	8	2500	370.0	355.0	55.0
RC4558IDR	SOIC	D	8	2500	340.5	338.1	20.6
RC4558IPWR	TSSOP	PW	8	2000	353.0	353.0	32.0
RC4558IPWR	TSSOP	PW	8	2000	356.0	356.0	35.0
RC4558PSR	SO	PS	8	2000	356.0	356.0	35.0
RC4558PWR	TSSOP	PW	8	2000	356.0	356.0	35.0
RC4558PWR	TSSOP	PW	8	2000	353.0	353.0	32.0

TUBE

*All dimensions are nominal

Device	Package Name	Package Type	Pins	SPQ	L (mm)	W (mm)	T (μm)	B (mm)
RC4558IP	P	PDIP	8	50	506	13.97	11230	4.32
RC4558P	P	PDIP	8	50	506	13.97	11230	4.32



D0008A

PACKAGE OUTLINE

SOIC - 1.75 mm max height

SMALL OUTLINE INTEGRATED CIRCUIT



4214825/C 02/2019

NOTES:

- Linear dimensions are in inches [millimeters]. Dimensions in parenthesis are for reference only. Controlling dimensions are in inches. Dimensioning and tolerancing per ASME Y14.5M.
- This drawing is subject to change without notice.
- This dimension does not include mold flash, protrusions, or gate burrs. Mold flash, protrusions, or gate burrs shall not exceed $.006$ [0.15] per side.
- This dimension does not include interlead flash.
- Reference JEDEC registration MS-012, variation AA.

EXAMPLE BOARD LAYOUT

D0008A

SOIC - 1.75 mm max height

SMALL OUTLINE INTEGRATED CIRCUIT



LAND PATTERN EXAMPLE
 EXPOSED METAL SHOWN
 SCALE:8X



SOLDER MASK DETAILS

4214825/C 02/2019

NOTES: (continued)

- 6. Publication IPC-7351 may have alternate designs.
- 7. Solder mask tolerances between and around signal pads can vary based on board fabrication site.

EXAMPLE STENCIL DESIGN

D0008A

SOIC - 1.75 mm max height

SMALL OUTLINE INTEGRATED CIRCUIT



SOLDER PASTE EXAMPLE
BASED ON .005 INCH [0.125 MM] THICK STENCIL
SCALE:8X

4214825/C 02/2019

NOTES: (continued)

8. Laser cutting apertures with trapezoidal walls and rounded corners may offer better paste release. IPC-7525 may have alternate design recommendations.
9. Board assembly site may have different recommendations for stencil design.

MECHANICAL DATA

PS (R-PDSO-G8)

PLASTIC SMALL-OUTLINE PACKAGE



- NOTES:
- A. All linear dimensions are in millimeters.
 - B. This drawing is subject to change without notice.
 - C. Body dimensions do not include mold flash or protrusion, not to exceed 0,15.

PS (R-PDSO-G8)

PLASTIC SMALL OUTLINE



- NOTES:
- A. All linear dimensions are in millimeters.
 - B. This drawing is subject to change without notice.
 - C. Publication IPC-7351 is recommended for alternate designs.
 - D. Laser cutting apertures with trapezoidal walls and also rounding corners will offer better paste release. Customers should contact their board assembly site for stencil design recommendations. Refer to IPC-7525 for other stencil recommendations.
 - E. Customers should contact their board fabrication site for solder mask tolerances between and around signal pads.

P (R-PDIP-T8)

PLASTIC DUAL-IN-LINE PACKAGE



- NOTES:
- A. All linear dimensions are in inches (millimeters).
 - B. This drawing is subject to change without notice.
 - C. Falls within JEDEC MS-001 variation BA.

PW0008A



PACKAGE OUTLINE
TSSOP - 1.2 mm max height

SMALL OUTLINE PACKAGE



4221848/A 02/2015

NOTES:

1. All linear dimensions are in millimeters. Any dimensions in parenthesis are for reference only. Dimensioning and tolerancing per ASME Y14.5M.
2. This drawing is subject to change without notice.
3. This dimension does not include mold flash, protrusions, or gate burrs. Mold flash, protrusions, or gate burrs shall not exceed 0.15 mm per side.
4. This dimension does not include interlead flash. Interlead flash shall not exceed 0.25 mm per side.
5. Reference JEDEC registration MO-153, variation AA.

EXAMPLE BOARD LAYOUT

PW0008A

TSSOP - 1.2 mm max height

SMALL OUTLINE PACKAGE



LAND PATTERN EXAMPLE
SCALE:10X



SOLDER MASK DETAILS
NOT TO SCALE

4221848/A 02/2015

NOTES: (continued)

- 6. Publication IPC-7351 may have alternate designs.
- 7. Solder mask tolerances between and around signal pads can vary based on board fabrication site.

EXAMPLE STENCIL DESIGN

PW0008A

TSSOP - 1.2 mm max height

SMALL OUTLINE PACKAGE



SOLDER PASTE EXAMPLE
BASED ON 0.125 mm THICK STENCIL
SCALE:10X

4221848/A 02/2015

NOTES: (continued)

8. Laser cutting apertures with trapezoidal walls and rounded corners may offer better paste release. IPC-7525 may have alternate design recommendations.
9. Board assembly site may have different recommendations for stencil design.

DGK0008A



PACKAGE OUTLINE

VSSOP - 1.1 mm max height

SMALL OUTLINE PACKAGE



4214862/A 04/2023

PowerPAD is a trademark of Texas Instruments.

NOTES:

- All linear dimensions are in millimeters. Any dimensions in parenthesis are for reference only. Dimensioning and tolerancing per ASME Y14.5M.
- This drawing is subject to change without notice.
- This dimension does not include mold flash, protrusions, or gate burrs. Mold flash, protrusions, or gate burrs shall not exceed 0.15 mm per side.
- This dimension does not include interlead flash. Interlead flash shall not exceed 0.25 mm per side.
- Reference JEDEC registration MO-187.

EXAMPLE BOARD LAYOUT

DGK0008A

™ VSSOP - 1.1 mm max height

SMALL OUTLINE PACKAGE



LAND PATTERN EXAMPLE
EXPOSED METAL SHOWN
SCALE: 15X



4214862/A 04/2023

NOTES: (continued)

6. Publication IPC-7351 may have alternate designs.
7. Solder mask tolerances between and around signal pads can vary based on board fabrication site.
8. Vias are optional depending on application, refer to device data sheet. If any vias are implemented, refer to their locations shown on this view. It is recommended that vias under paste be filled, plugged or tented.
9. Size of metal pad may vary due to creepage requirement.

EXAMPLE STENCIL DESIGN

DGK0008A

TM VSSOP - 1.1 mm max height

SMALL OUTLINE PACKAGE



SOLDER PASTE EXAMPLE
SCALE: 15X

4214862/A 04/2023

NOTES: (continued)

11. Laser cutting apertures with trapezoidal walls and rounded corners may offer better paste release. IPC-7525 may have alternate design recommendations.
12. Board assembly site may have different recommendations for stencil design.

IMPORTANT NOTICE AND DISCLAIMER

TI PROVIDES TECHNICAL AND RELIABILITY DATA (INCLUDING DATA SHEETS), DESIGN RESOURCES (INCLUDING REFERENCE DESIGNS), APPLICATION OR OTHER DESIGN ADVICE, WEB TOOLS, SAFETY INFORMATION, AND OTHER RESOURCES "AS IS" AND WITH ALL FAULTS, AND DISCLAIMS ALL WARRANTIES, EXPRESS AND IMPLIED, INCLUDING WITHOUT LIMITATION ANY IMPLIED WARRANTIES OF MERCHANTABILITY, FITNESS FOR A PARTICULAR PURPOSE OR NON-INFRINGEMENT OF THIRD PARTY INTELLECTUAL PROPERTY RIGHTS.

These resources are intended for skilled developers designing with TI products. You are solely responsible for (1) selecting the appropriate TI products for your application, (2) designing, validating and testing your application, and (3) ensuring your application meets applicable standards, and any other safety, security, regulatory or other requirements.

These resources are subject to change without notice. TI grants you permission to use these resources only for development of an application that uses the TI products described in the resource. Other reproduction and display of these resources is prohibited. No license is granted to any other TI intellectual property right or to any third party intellectual property right. TI disclaims responsibility for, and you will fully indemnify TI and its representatives against, any claims, damages, costs, losses, and liabilities arising out of your use of these resources.

TI's products are provided subject to [TI's Terms of Sale](#) or other applicable terms available either on [ti.com](https://www.ti.com) or provided in conjunction with such TI products. TI's provision of these resources does not expand or otherwise alter TI's applicable warranties or warranty disclaimers for TI products.

TI objects to and rejects any additional or different terms you may have proposed.

Mailing Address: Texas Instruments, Post Office Box 655303, Dallas, Texas 75265
Copyright © 2024, Texas Instruments Incorporated