

SN74LV4T125-EP Single Power Supply Quadruple Buffer Translator GATE With 3-State Output CMOS Logic Level Shifter

1 Features

- Wide operating range of 1.8V to 5.5V
- Single-supply voltage translator (refer to *LVxT Enhanced Input Voltage*):
 - Up translation:
 - 1.2V to 1.8V
 - 1.5V to 2.5V
 - 1.8V to 3.3V
 - 3.3V to 5.0V
 - Down translation:
 - 5.0V, 3.3V, 2.5V to 1.8V
 - 5.0V, 3.3V to 2.5V
 - 5.0V to 3.3V
- 5.5V tolerant input pins
- Supports standard pinouts
- Up to 150Mbps with 5V or 3.3V V_{CC}
- Latch-up performance exceeds 250mA per JESD 17

2 Applications

- [Enable or disable a digital signal](#)
- [Controlling an indicator LED](#)
- [Translation between communication modules and system controllers](#)

3 Description

The SN74LV4T125-EP contains four independent buffers with 3-state outputs and extended voltage operation to allow for level translation. Each buffer performs the Boolean function $Y = A$ in positive logic. The outputs can be put into a high impedance (Hi-Z) state by applying a HIGH on the \overline{OE} pin. The output level is referenced to the supply voltage (V_{CC}) and supports 1.8V, 2.5V, 3.3V, and 5V CMOS levels.

The input is designed with a lower threshold circuit to support up translation for lower voltage CMOS inputs (for example, 1.2V input to 1.8V output or 1.8V input to 3.3V output). In addition, the 5V tolerant input pins enable down translation (for example, 3.3V to 2.5V output).

Package Information

PART NUMBER ⁽¹⁾	PACKAGE ⁽²⁾	PACKAGE SIZE ⁽³⁾	BODY SIZE (NOM) ⁽⁴⁾
SN74LV4T125-EP	PW (TSSOP, 14)	5 mm × 6.4 mm	5 mm × 4.4 mm

- (1) See, [Additional Product Selection](#)
- (2) For more information, see [Section 12](#).
- (3) The package size (length × width) is a nominal value and includes pins, where applicable.
- (4) The body size (length × width) is a nominal value and does not include pins.

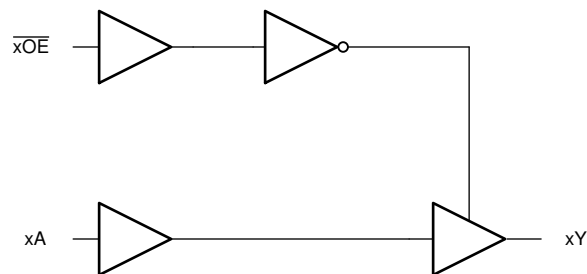

Simplified Logic Diagram (Positive Logic)



Table of Contents

1 Features	1	8.2 Functional Block Diagram.....	11
2 Applications	1	8.3 Feature Description.....	11
3 Description	1	8.4 Device Functional Modes.....	14
4 Additional Product Selection	2	9 Applications and Implementation	15
5 Pin Configuration and Functions	3	9.1 Application Information.....	15
6 Specifications	4	9.2 Typical Application.....	15
6.1 Absolute Maximum Ratings.....	4	9.3 Power Supply Recommendations.....	16
6.2 ESD Ratings.....	4	9.4 Layout.....	16
6.3 Recommended Operating Conditions.....	4	10 Device and Documentation Support	17
6.4 Thermal Information.....	5	10.1 Receiving Notification of Documentation Updates..	17
6.5 Electrical Characteristics.....	5	10.2 Support Resources.....	17
6.6 Switching Characteristics.....	6	10.3 Trademarks.....	17
6.7 Noise Characteristics.....	7	10.4 Electrostatic Discharge Caution.....	17
6.8 Typical Characteristics.....	7	10.5 Glossary.....	17
7 Parameter Measurement Information	10	11 Revision History	17
8 Detailed Description	11	12 Mechanical, Packaging, and Orderable Information	17
8.1 Overview.....	11		

4 Additional Product Selection

DEVICE	PACKAGE	DESCRIPTION
SN74LV1T00	DCK, DBV	2-Input Positive-NAND Gate
SN74LV1T02	DCK, DBV	2-Input Positive-NOR Gate
SN74LV1T04	DCK, DBV	Inverter Gate
SN74LV1T08	DCK, DBV	2-Input Positive-AND Gate
SN74LV1T34	DCK, DBV, DRL	Single Buffer Gate
SN74LV1T14	DCK, DBV	Single Schmitt-Trigger Inverter Gate
SN74LV1T32	DCK, DBV	2-Input Positive-OR Gate
SN74LV1T86	DCK, DBV	Single 2-Input Exclusive-Or Gate
SN74LV1T125	DCK, DBV, DRL	Single Buffer Gate with 3-state Output
SN74LV1T126	DCK, DBV, DRL	Single Buffer Gate with 3-state Output
SN74LV4T125-EP	RGY, PW	Quadruple Bus Buffer Gate With 3-State Outputs

5 Pin Configuration and Functions

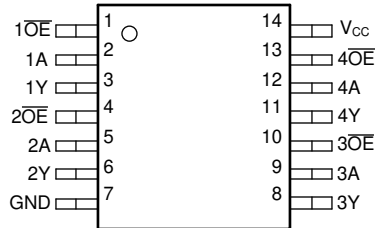

**Figure 5-1. PW Package,
14-Pin TSSOP
(Top View)**

Table 5-1. Pin Functions

PIN		TYPE ⁽¹⁾	DESCRIPTION
NAME	NO.		
1OE	1	I	Channel 1, output enable, active low
1A	2	I	Channel 1, input A
1Y	3	O	Channel 1, output Y
2OE	4	I	Channel 2, output enable, active low
2A	5	I	Channel 2, input A
2Y	6	O	Channel 2, output Y
GND	7	G	Ground
3Y	8	O	Channel 3, output Y
3A	9	I	Channel 3, input A
3OE	10	I	Channel 3, output enable, active low
4Y	11	O	Channel 4, output Y
4A	12	I	Channel 4, input A
4OE	13	I	Channel 4, output enable, active low
V _{CC}	14	P	Positive supply

(1) I = input, O = output, I/O = input or output, G = ground, P = power.

6 Specifications

6.1 Absolute Maximum Ratings

over operating free-air temperature range (unless otherwise noted)⁽¹⁾

		MIN	MAX	UNIT
V _{CC}	Supply voltage range	-0.5	7	V
V _I	Input voltage range ⁽²⁾	-0.5	7	V
V _O	Voltage range applied to any output in the high-impedance or power-off state ⁽²⁾	-0.5	7	V
V _O	Output voltage range ⁽²⁾	-0.5	V _{CC} + 0.5	V
I _{IK}	Input clamp current	V _I < -0.5V	-20	mA
I _{OK}	Output clamp current	V _O < -0.5V or V _O > V _{CC} + 0.5V	±20	mA
I _O	Continuous output current	V _O = 0 to V _{CC}	±25	mA
	Continuous output current through V _{CC} or GND		±50	mA
T _{stg}	Storage temperature	-65	150	°C

- (1) Operation outside the *Absolute Maximum Ratings* may cause permanent device damage. Absolute maximum ratings do not imply functional operation of the device at these or any other conditions beyond those listed under *Recommended Operating Conditions*. If briefly operating outside the *Recommended Operating Conditions* but within the *Absolute Maximum Ratings*, the device may not sustain damage, but it may not be fully functional. Operating the device in this manner may affect device reliability, functionality, performance, and shorten the device lifetime.
- (2) The input and output voltage ratings may be exceeded if the input and output current ratings are observed.

6.2 ESD Ratings

		VALUE	UNIT
V _(ESD)	Electrostatic discharge	Human-body model (HBM), per ANSI/ESDA/JEDEC JS-001 ⁽¹⁾	±2000
		Charged-device model (CDM), per ANSI/ESDA/JEDEC JS-002 ⁽²⁾	±1000

- (1) JEDEC document JEP155 states that 500-V HBM allows safe manufacturing with a standard ESD control process.
- (2) JEDEC document JEP157 states that 250-V CDM allows safe manufacturing with a standard ESD control process.

6.3 Recommended Operating Conditions

over operating free-air temperature range (unless otherwise noted)

		MIN	MAX	UNIT
V _{CC}	Supply voltage	1.6	5.5	V
V _I	Input voltage	0	5.5	V
V _O	Output voltage	0	V _{CC}	V
V _{IH}	High-level input voltage	V _{CC} = 1.65V to 2V	1.1	V
		V _{CC} = 2.25V to 2.75V	1.28	
		V _{CC} = 3V to 3.6V	1.45	
		V _{CC} = 4.5V to 5.5V	2	
V _{IL}	Low-Level input voltage	V _{CC} = 1.65V to 2V	0.5	V
		V _{CC} = 2.25V to 2.75V	0.65	
		V _{CC} = 3V to 3.6V	0.75	
		V _{CC} = 4.5V to 5.5V	0.85	
I _O	Output current	V _{CC} = 1.6V to 2V	±3	mA
		V _{CC} = 2.25V to 2.75V	±7	
		V _{CC} = 3.3V to 5.0V	±15	
Δt/Δv	Input transition rise or fall rate	V _{CC} = 1.6V to 5.0V	20	ns/V
T _A	Operating free-air temperature	-55	125	°C

6.4 Thermal Information

THERMAL METRIC ⁽¹⁾		SN74LV4T125-EP-EP	
		PW (TSSOP)	
		14 PINS	
Parameter	Description	Value	Unit
$R_{\theta JA}$	Junction-to-ambient thermal resistance	147.7	°C/W
$R_{\theta JC(top)}$	Junction-to-case (top) thermal resistance	77.4	°C/W
$R_{\theta JB}$	Junction-to-board thermal resistance	90.9	°C/W
Ψ_{JT}	Junction-to-top characterization parameter	27.2	°C/W
Ψ_{JB}	Junction-to-board characterization parameter	90.2	°C/W
$R_{\theta JC(bot)}$	Junction-to-case (bottom) thermal resistance	N/A	°C/W

(1) For more information about traditional and new thermal metrics, see the [Semiconductor and IC Package Thermal Metrics](#) application report.

6.5 Electrical Characteristics

over operating free-air temperature range (unless otherwise noted)

PARAMETER	TEST CONDITIONS	V_{CC}	$T_A = 25^\circ\text{C}$			$-55^\circ\text{C to } 125^\circ\text{C}$			UNIT
			MIN	TYP	MAX	MIN	TYP	MAX	
V_{OH}	$I_{OH} = -50\mu\text{A}$	1.65V to 5.5V	$V_{CC}-0.1$			$V_{CC}-0.1$			V
	$I_{OH} = -2\text{mA}$	1.65V to 2V	1.28	1.7 ⁽¹⁾		1.21			
	$I_{OH} = -3\text{mA}$	2.25V to 2.75V	2	2.4 ⁽¹⁾		1.93			
	$I_{OH} = -5.5\text{mA}$	3V to 3.6V	2.6	3.08 ⁽¹⁾		2.49			
	$I_{OH} = -8\text{mA}$	4.5V to 5.5V	4.1	4.65 ⁽¹⁾		3.95			
V_{OL}	$I_{OL} = 50\mu\text{A}$	1.65V to 5.5V			0.1			0.1	V
	$I_{OL} = 2\text{mA}$	1.65V to 2V		0.1 ⁽¹⁾	0.2			0.25	
	$I_{OL} = 3\text{mA}$	2.25V to 2.75V		0.1 ⁽¹⁾	0.15			0.2	
	$I_{OL} = 5.5\text{mA}$	3V to 3.6V		0.2 ⁽¹⁾	0.2			0.25	
	$I_{OL} = 8\text{mA}$	4.5V to 5.5V		0.3 ⁽¹⁾	0.3			0.35	
I_I	$V_I = 0\text{V or } V_{CC}$	0V to 5.5V			± 0.1			± 1	μA
I_{OZ}	$V_O = V_{CC}$ or GND and $V_{CC} = 5.5\text{V}$	5.5V			± 0.25			± 2.5	μA
I_{CC}	$V_I = 0\text{V or } V_{CC}$, $I_O = 0$; open on loading	1.65V to 5.5V			2			20	μA
ΔI_{CC}	One input at 0.3V or 3.4V, other inputs at 0 or V_{CC} , $I_O = 0$	5.5V			1.35			1.5	mA
	One input at 0.3V or 1.1V, other inputs at 0 or V_{CC} , $I_O = 0$	1.8V			10			20	μA
C_I	$V_I = V_{CC}$ or GND	5V		4	10			10	pF
C_O	$V_O = V_{CC}$ or GND	5V		3					pF
C_{PD}	No load, $F = 1\text{MHz}$	5V		14					pF

(1) Typical value at nearest nominal voltage (1.8V, 2.5V, 3.3V, and 5V)

6.6 Switching Characteristics

over operating free-air temperature range; typical ratings measured at $T_A = 25^\circ\text{C}$ (unless otherwise noted).

PARAMETER	FROM (INPUT)	TO (OUTPUT)	LOAD CAPACITANCE	V_{CC}	MIN	TYP	MAX	UNIT
t_{PHL}	A	Y	$C_L = 15\text{pF}$	1.8V		15.6	40.1	ns
t_{PLH}	A	Y	$C_L = 15\text{pF}$	1.8V		11.8	40.1	ns
t_{PHZ}	OE	Y	$C_L = 15\text{pF}$	1.8V		13.0	20.9	ns
t_{PLZ}	OE	Y	$C_L = 15\text{pF}$	1.8V		11.7	18.5	ns
t_{PZH}	OE	Y	$C_L = 15\text{pF}$	1.8V		17.4	33.3	ns
t_{PZL}	OE	Y	$C_L = 15\text{pF}$	1.8V		16.8	32.3	ns
t_{PHL}	A	Y	$C_L = 50\text{pF}$	1.8V		21.0	46.7	ns
t_{PLH}	A	Y	$C_L = 50\text{pF}$	1.8V		16.1	46.7	ns
t_{PHZ}	OE	Y	$C_L = 50\text{pF}$	1.8V		19.7	28.2	ns
t_{PLZ}	OE	Y	$C_L = 50\text{pF}$	1.8V		18.6	25.9	ns
t_{PZH}	OE	Y	$C_L = 50\text{pF}$	1.8V		19.9	37.1	ns
t_{PZL}	OE	Y	$C_L = 50\text{pF}$	1.8V		19.1	35.8	ns
t_{PHL}	A	Y	$C_L = 15\text{pF}$	2.5V		10.6	24.0	ns
t_{PLH}	A	Y	$C_L = 15\text{pF}$	2.5V		7.1	24.0	ns
t_{PHZ}	OE	Y	$C_L = 15\text{pF}$	2.5V		8.2	12.6	ns
t_{PLZ}	OE	Y	$C_L = 15\text{pF}$	2.5V		7.4	11.1	ns
t_{PZH}	OE	Y	$C_L = 15\text{pF}$	2.5V		10.4	19.8	ns
t_{PZL}	OE	Y	$C_L = 15\text{pF}$	2.5V		9.9	19.0	ns
t_{PHL}	A	Y	$C_L = 50\text{pF}$	2.5V		13.5	25.4	ns
t_{PLH}	A	Y	$C_L = 50\text{pF}$	2.5V		10.1	25.4	ns
t_{PHZ}	OE	Y	$C_L = 50\text{pF}$	2.5V		13.1	18.5	ns
t_{PLZ}	OE	Y	$C_L = 50\text{pF}$	2.5V		12.0	16.4	ns
t_{PZH}	OE	Y	$C_L = 50\text{pF}$	2.5V		12.0	22.5	ns
t_{PZL}	OE	Y	$C_L = 50\text{pF}$	2.5V		11.1	21.5	ns
t_{PHL}	A	Y	$C_L = 15\text{pF}$	3.3V		7.9	15.2	ns
t_{PLH}	A	Y	$C_L = 15\text{pF}$	3.3V		5.4	13.8	ns
t_{PHZ}	OE	Y	$C_L = 15\text{pF}$	3.3V		6.0	9.9	ns
t_{PLZ}	OE	Y	$C_L = 15\text{pF}$	3.3V		5.3	8.2	ns
t_{PZH}	OE	Y	$C_L = 15\text{pF}$	3.3V		7.9	14.1	ns
t_{PZL}	OE	Y	$C_L = 15\text{pF}$	3.3V		7.4	13.5	ns
t_{PHL}	A	Y	$C_L = 50\text{pF}$	3.3V		10.2	18.3	ns
t_{PLH}	A	Y	$C_L = 50\text{pF}$	3.3V		7.8	16.0	ns
t_{PHZ}	OE	Y	$C_L = 50\text{pF}$	3.3V		9.7	15.1	ns
t_{PLZ}	OE	Y	$C_L = 50\text{pF}$	3.3V		9.2	12.9	ns
t_{PZH}	OE	Y	$C_L = 50\text{pF}$	3.3V		9.1	16.4	ns
t_{PZL}	OE	Y	$C_L = 50\text{pF}$	3.3V		8.3	15.3	ns
$t_{sk(o)}$	OE	Y	$C_L = 50\text{pF}$	3.3V			1.5	ns
t_{PHL}	A	Y	$C_L = 15\text{pF}$	5V		5.3	10.2	ns
t_{PLH}	A	Y	$C_L = 15\text{pF}$	5V		4.2	9.9	ns
t_{PHZ}	OE	Y	$C_L = 15\text{pF}$	5V		4.6	7.5	ns
t_{PLZ}	OE	Y	$C_L = 15\text{pF}$	5V		4.2	6.1	ns
t_{PZH}	OE	Y	$C_L = 15\text{pF}$	5V		5.6	9.6	ns
t_{PZL}	OE	Y	$C_L = 15\text{pF}$	5V		5.1	8.9	ns

6.6 Switching Characteristics (continued)

over operating free-air temperature range; typical ratings measured at $T_A = 25^\circ\text{C}$ (unless otherwise noted).

PARAMETER	FROM (INPUT)	TO (OUTPUT)	LOAD CAPACITANCE	V _{CC}	MIN	TYP	MAX	UNIT
t _{PHL}	A	Y	C _L = 50pF	5V		7.1	12.5	ns
t _{PLH}	A	Y	C _L = 50pF	5V		5.8	11.5	ns
t _{PHZ}	OE	Y	C _L = 50pF	5V		6.9	10.9	ns
t _{PLZ}	OE	Y	C _L = 50pF	5V		6.8	9.1	ns
t _{PZH}	OE	Y	C _L = 50pF	5V		6.6	11.0	ns
t _{PZL}	OE	Y	C _L = 50pF	5V		5.7	10.0	ns

6.7 Noise Characteristics

V_{CC} = 5V, C_L = 50pF, T_A = 25°C

PARAMETER	DESCRIPTION	MIN	TYP	MAX	UNIT
V _{OL(P)}	Quiet output, maximum dynamic V _{OL}		1	1.2	V
V _{OL(V)}	Quiet output, minimum dynamic V _{OL}	-0.8	-0.3		V
V _{OH(V)}	Quiet output, minimum dynamic V _{OH}	4.4	5		V
V _{IH(D)}	High-level dynamic input voltage	2.1			V
V _{IL(D)}	Low-level dynamic input voltage			0.5	V

6.8 Typical Characteristics

T_A = 25°C (unless otherwise noted)

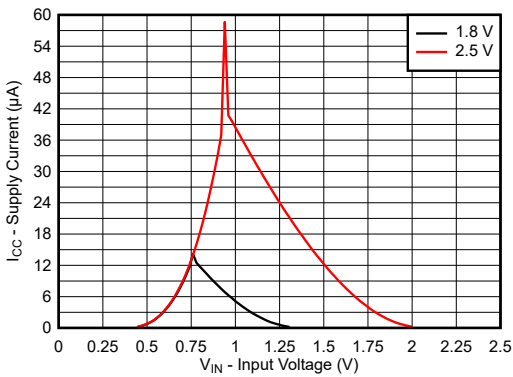

Figure 6-1. Supply Current Across Input Voltage 1.8V and 2.5V Supply

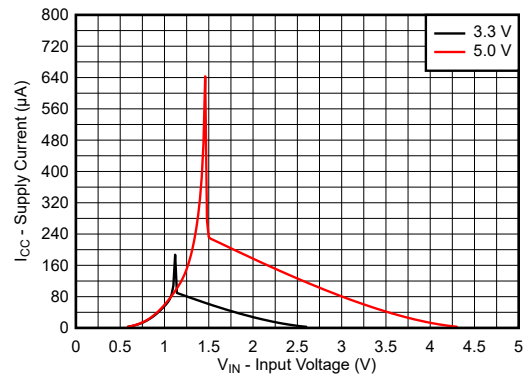

Figure 6-2. Supply Current Across Input Voltage 3.3V and 5.0V Supply

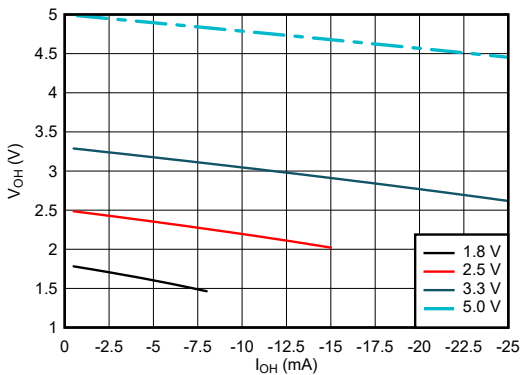

Figure 6-3. Output Voltage vs Current in HIGH State

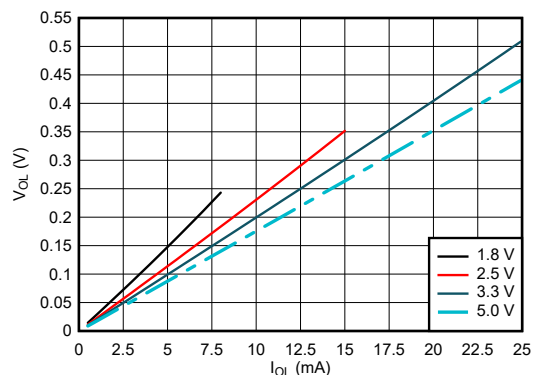

Figure 6-4. Output Voltage vs Current in LOW State

6.8 Typical Characteristics (continued)

$T_A = 25^\circ\text{C}$ (unless otherwise noted)

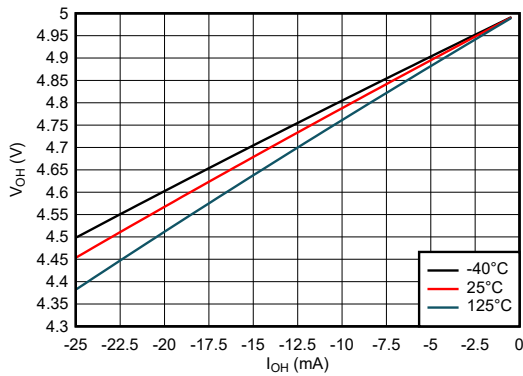

Figure 6-5. Output Voltage vs Current in HIGH State; 5V Supply

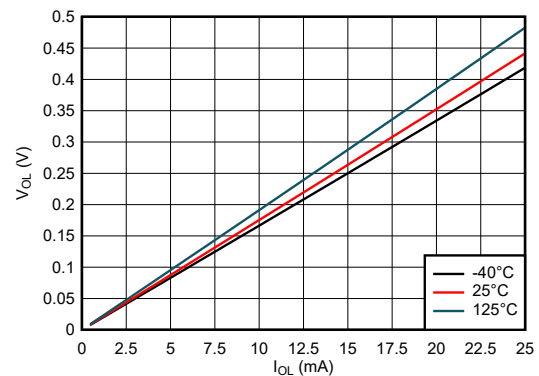

Figure 6-6. Output Voltage vs Current in LOW State; 5V Supply

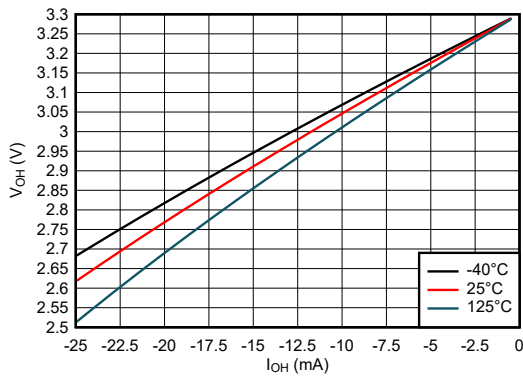

Figure 6-7. Output Voltage vs Current in HIGH State; 3.3V Supply

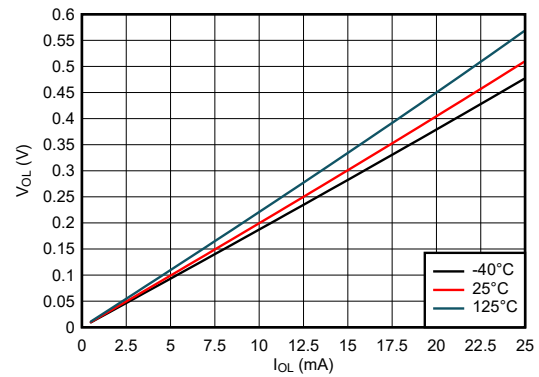

Figure 6-8. Output Voltage vs Current in LOW State; 3.3V Supply

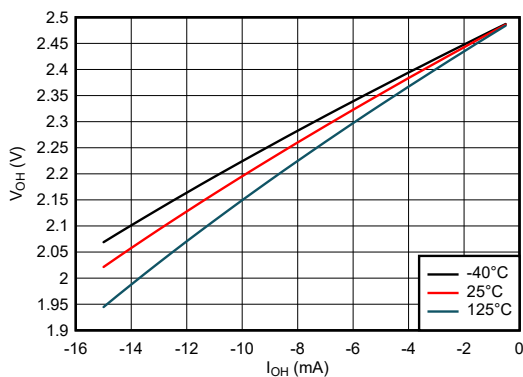

Figure 6-9. Output Voltage vs Current in HIGH State; 2.5V Supply

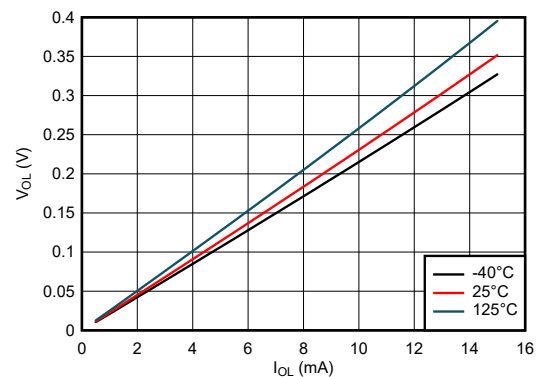

Figure 6-10. Output Voltage vs Current in LOW State; 2.5V Supply

6.8 Typical Characteristics (continued)

$T_A = 25^\circ\text{C}$ (unless otherwise noted)

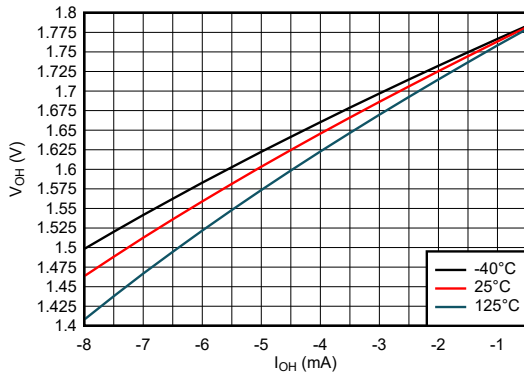

Figure 6-11. Output Voltage vs Current in HIGH State; 1.8V Supply

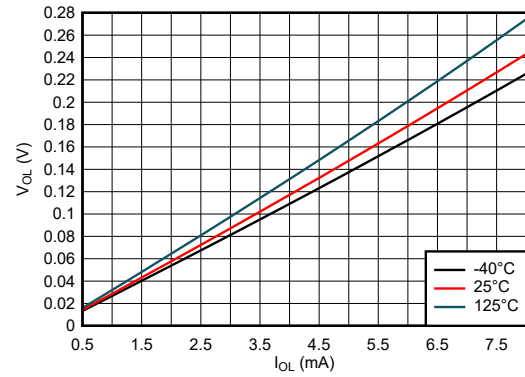
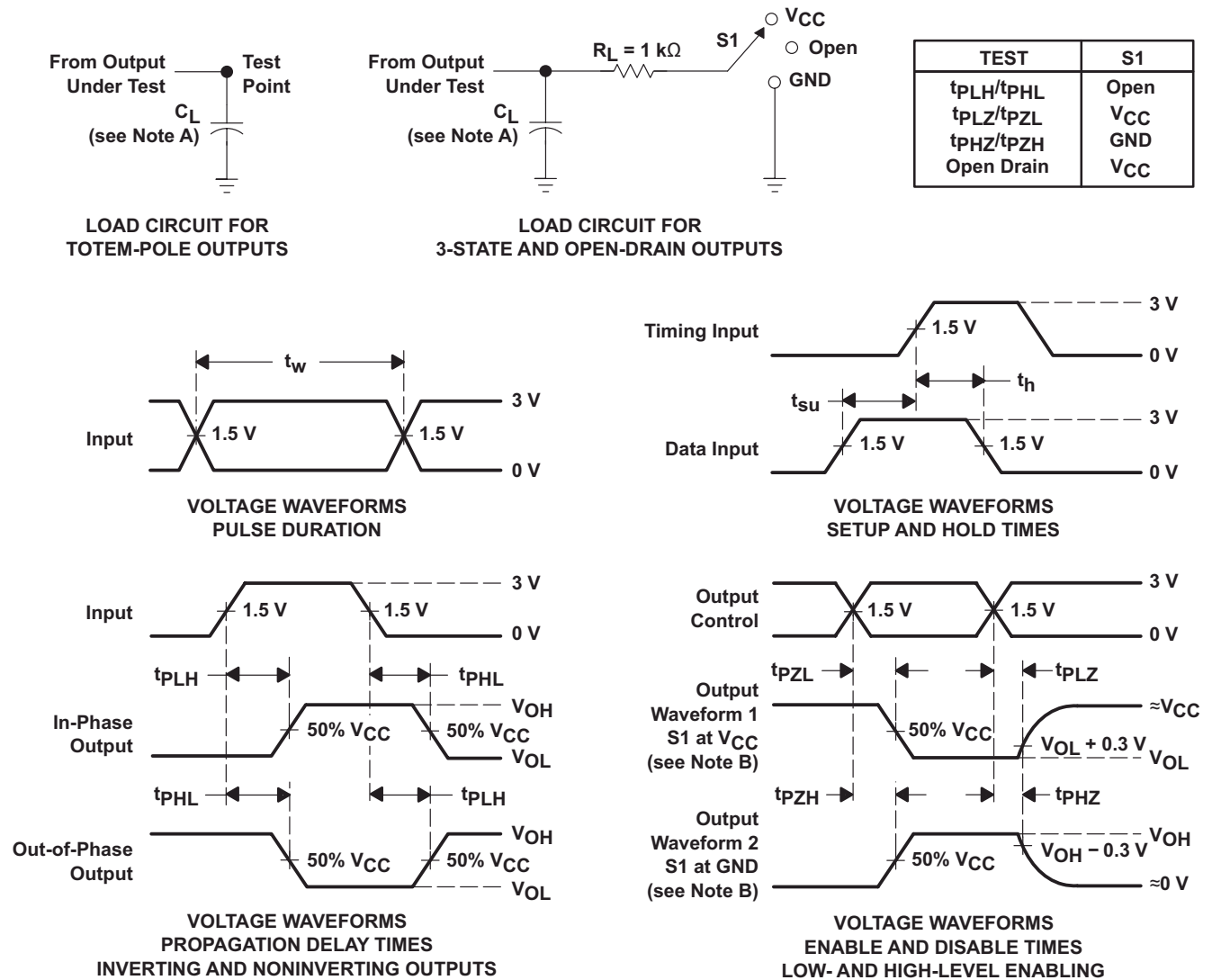

Figure 6-12. Output Voltage vs Current in LOW State; 1.8V Supply

7 Parameter Measurement Information



- NOTES: A. C_L includes probe and jig capacitance.
 B. Waveform 1 is for an output with internal conditions such that the output is low, except when disabled by the output control. Waveform 2 is for an output with internal conditions such that the output is high, except when disabled by the output control.
 C. All input pulses are supplied by generators having the following characteristics: $PRR \leq 1$ MHz, $Z_O = 50 \Omega$, $t_r \leq 3$ ns, $t_f \leq 3$ ns.
 D. The outputs are measured one at a time, with one input transition per measurement.
 E. All parameters and waveforms are not applicable to all devices.

Figure 7-1. Load Circuit and Voltage Waveforms

8 Detailed Description

8.1 Overview

The SN74LV4T125-EP contains four independent buffers with 3-state outputs and extended voltage operation to allow for level translation. Each buffer performs the Boolean function $Y = A$ in positive logic. The outputs can be put into a Hi-Z state by applying a High on the \overline{OE} pin. The output level is referenced to the supply voltage (V_{CC}) and supports 1.8V, 2.5V, 3.3V, and 5V CMOS levels.

8.2 Functional Block Diagram

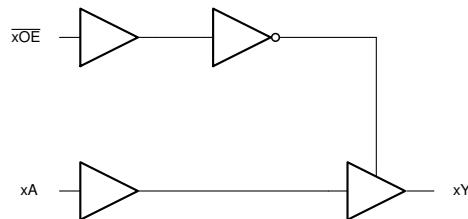

8.3 Feature Description

8.3.1 Balanced CMOS 3-State Outputs

This device includes balanced CMOS 3-state outputs. Driving high, driving low, and high impedance are the three states that these outputs can be in. The term *balanced* indicates that the device can sink and source similar currents. The drive capability of this device may create fast edges into light loads, so routing and load conditions should be considered to prevent ringing. Additionally, the outputs of this device are capable of driving larger currents than the device can sustain without being damaged. It is important for the output power of the device to be limited to avoid damage due to overcurrent. The electrical and thermal limits defined in the *Absolute Maximum Ratings* must be followed at all times.

When placed into the high-impedance mode, the output will neither source nor sink current, with the exception of minor leakage current as defined in the *Electrical Characteristics* table. In the high-impedance state, the output voltage is not controlled by the device and is dependent on external factors. If no other drivers are connected to the node, then this is known as a floating node and the voltage is unknown. A pull-up or pull-down resistor can be connected to the output to provide a known voltage at the output while it is in the high-impedance state. The value of the resistor will depend on multiple factors, including parasitic capacitance and power consumption limitations. Typically, a 10k Ω resistor can be used to meet these requirements.

Unused 3-state CMOS outputs should be left disconnected.

8.3.2 Clamp Diode Structure

The outputs to this device have both positive and negative clamping diodes, and the inputs to this device have negative clamping diodes only as depicted in [Figure 8-1](#).

CAUTION

Voltages beyond the values specified in the *Absolute Maximum Ratings* table can cause damage to the device. The input and output voltage ratings may be exceeded if the input and output clamp-current ratings are observed.

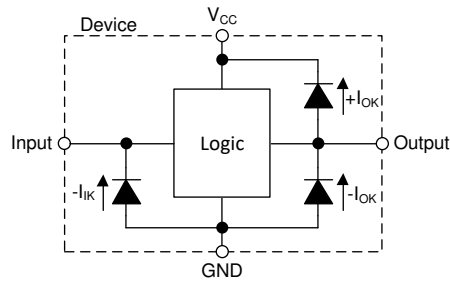

Figure 8-1. Electrical Placement of Clamping Diodes for Each Input and Output

8.3.3 LVxT Enhanced Input Voltage

The SN74LV4T125-EP belongs to TI's LVxT family of logic devices with integrated voltage level translation. This family of devices was designed with reduced input voltage thresholds to support up-translation, and inputs tolerant of signals with up to 5.5V levels to support down-translation. The output voltage will always be referenced to the supply voltage (V_{CC}), as described in the *Electrical Characteristics* table. For proper functionality, input signals must remain at or below the specified $V_{IH(MIN)}$ level for a HIGH input state, and at or below the specified $V_{IL(MAX)}$ for a LOW input state. Figure 8-2 shows the typical V_{IH} and V_{IL} levels for the LVxT family of devices, as well as the voltage levels for standard CMOS devices for comparison.

The inputs are high impedance and are typically modeled as a resistor in parallel with the input capacitance given in the *Electrical Characteristics*. The worst case resistance is calculated with the maximum input voltage, given in the *Absolute Maximum Ratings*, and the maximum input leakage current, given in the *Electrical Characteristics*, using Ohm's law ($R = V \div I$).

The inputs require that input signals transition between valid logic states quickly, as defined by the input transition time or rate in the *Recommended Operating Conditions* table. Failing to meet this specification will result in excessive power consumption and could cause oscillations. More details can be found in the [Implications of Slow or Floating CMOS Inputs](#) application report.

Do not leave inputs floating at any time during operation. Unused inputs must be terminated at V_{CC} or GND. If a system will not be actively driving an input at all times, a pull-up or pull-down resistor can be added to provide a valid input voltage during these times. The resistor value will depend on multiple factors; however, a 10k Ω resistor is recommended and will typically meet all requirements.

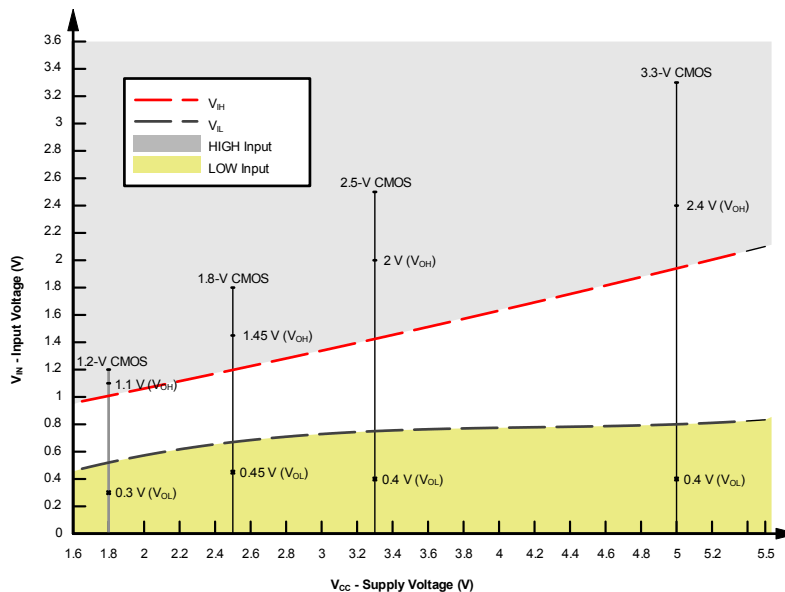

Figure 8-2. LVxT Input Voltage Levels

8.3.3.1 Down Translation

Signals can be translated down using the SN74LV4T125-EP. The voltage applied at the V_{CC} will determine the output voltage and the input thresholds as described in the *Recommended Operating Conditions* and *Electrical Characteristics* tables.

When connected to a high-impedance input, the output voltage will be approximately V_{CC} in the HIGH state, and 0V in the LOW state. Ensure that the input signals in the HIGH state are between $V_{IH(MIN)}$ and 5.5V, and input signals in the LOW state are lower than $V_{IL(MAX)}$ as shown in [Figure 8-2](#).

For example, standard CMOS inputs for devices operating at 5.0V, 3.3V or 2.5V can be down-translated to match 1.8V CMOS signals when operating from 1.8V V_{CC} . See [Figure 8-3](#).

Down Translation Combinations are as follows:

- 1.8V V_{CC} – Inputs from 2.5V, 3.3V, and 5.0V
- 2.5V V_{CC} – Inputs from 3.3V and 5.0V
- 3.3V V_{CC} – Inputs from 5.0V

8.3.3.2 Up Translation

Input signals can be up translated using the SN74LV4T125-EP. The voltage applied at V_{CC} will determine the output voltage and the input thresholds as described in the *Recommended Operating Conditions* and *Electrical Characteristics* tables. When connected to a high-impedance input, the output voltage will be approximately V_{CC} in the HIGH state, and 0V in the LOW state.

The inputs have reduced thresholds that allow for input HIGH state levels which are much lower than standard values. For example, standard CMOS inputs for a device operating at a 5V supply will have a $V_{IH(MIN)}$ of 3.5V. For the SN74LV4T125-EP, $V_{IH(MIN)}$ with a 5V supply is only 2V, which would allow for up-translation from a typical 2.5V to 5V signals.

As shown in [Figure 8-3](#), ensure that the input signals in the HIGH state are above $V_{IH(MIN)}$ and input signals in the LOW state are lower than $V_{IL(MAX)}$.

Up Translation Combinations are as follows:

- 1.8V V_{CC} – Inputs from 1.2V
- 2.5V V_{CC} – Inputs from 1.8V
- 3.3V V_{CC} – Inputs from 1.8V and 2.5V
- 5.0V V_{CC} – Inputs from 2.5V and 3.3V

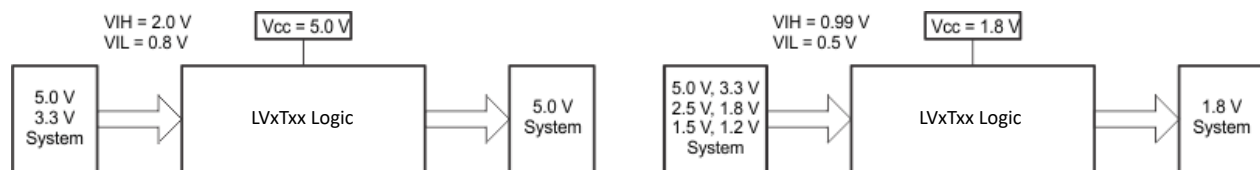

Figure 8-3. LVxT Up and Down Translation Example

8.4 Device Functional Modes

[Function Table](#) lists the functional modes of the SN74LV4T125-EP.

Table 8-1. Function Table

INPUTS ⁽¹⁾		OUTPUT
\overline{OE}	A	Y
L	H	H
L	L	L
H	X	Z

(1) H = high voltage level, L = low voltage level, X = do not care, Z = high impedance

9 Applications and Implementation

Note

Information in the following applications sections is not part of the TI component specification, and TI does not warrant its accuracy or completeness. TI's customers are responsible for determining suitability of components for their purposes, as well as validating and testing their design implementation to confirm system functionality.

9.1 Application Information

In this application, a buffer with a 3-state output is used to disable a data signal as shown in [Figure 9-1](#). The remaining three buffers can be used for signal conditioning in other places in the system, or the inputs can be grounded and the channels left unused.

9.2 Typical Application

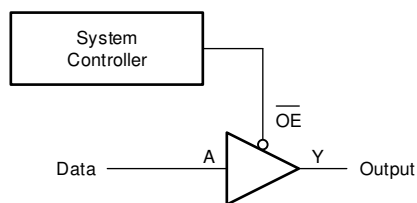

Figure 9-1. Typical Application Block Diagram

9.2.1 Design Requirements

This device uses CMOS technology and has balanced output drive. The input threshold levels are lowered to allow for up translation. At 5V the device has equivalent TTL input levels.

9.2.2 Detailed Design Procedure

1. Add a decoupling capacitor from V_{CC} to GND. The capacitor needs to be placed physically close to the device and electrically close to both the V_{CC} and GND pins. An example layout is shown in the *Layout* section.
2. Ensure the capacitive load at the output is $\leq 50\text{pF}$. This is not a hard limit; by design, however, it will optimize performance. This can be accomplished by providing short, appropriately sized traces from the SN74LV4T125-EP to one or more of the receiving devices.
3. Ensure the resistive load at the output is larger than $(V_{CC} / I_{O(max)}) \Omega$. Doing this will not violate the maximum output current from the *Absolute Maximum Ratings*. Most CMOS inputs have a resistive load measured in $\text{M}\Omega$; much larger than the minimum calculated previously.
4. Thermal issues are rarely a concern for logic gates; the power consumption and thermal increase, however, can be calculated using the steps provided in the application report, [CMOS Power Consumption and Cpd Calculation](#).

9.2.3 Application Curves

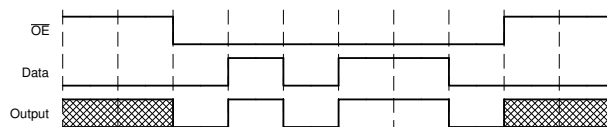

Figure 9-2. Application Timing Diagram

9.3 Power Supply Recommendations

The power supply can be any voltage between the Min and Max supply voltage rating located in the [Recommended Operating Conditions](#).

Each V_{CC} pin should have a good bypass capacitor to prevent power disturbance. For devices with a single supply, 0.1 μ F is recommended. If there are multiple V_{CC} pins, then 0.01 μ F or 0.022 μ F is recommended for each power pin. It is acceptable to parallel multiple bypass capacitors to reject different frequencies of noise. A 0.1 μ F and 1 μ F are commonly used in parallel. The bypass capacitor should be installed as close to the power pin as possible for best results.

9.4 Layout

9.4.1 Layout Guidelines

When using multiple bit logic devices inputs should not ever float.

In many cases, functions or parts of functions of digital logic devices are unused, for example, when only two inputs of a triple-input AND gate are used or only 3 of the 4 buffer gates are used. Such input pins should not be left unconnected because the undefined voltages at the outside connections result in undefined operational states. Specified in [Figure 9-3](#) are the rules that must be observed under all circumstances.

All unused inputs of digital logic devices must be connected to a high or low bias to prevent them from floating. The logic level that should be applied to any particular unused input depends on the function of the device. Generally they will be tied to GND or V_{CC} whichever make more sense or is more convenient.

It is generally acceptable to float outputs unless the part is a transceiver. If the transceiver has an output enable pin it will disable the outputs section of the part when asserted. This will not disable the input section of the IOs so they also cannot float when disabled.

9.4.2 Layout Example

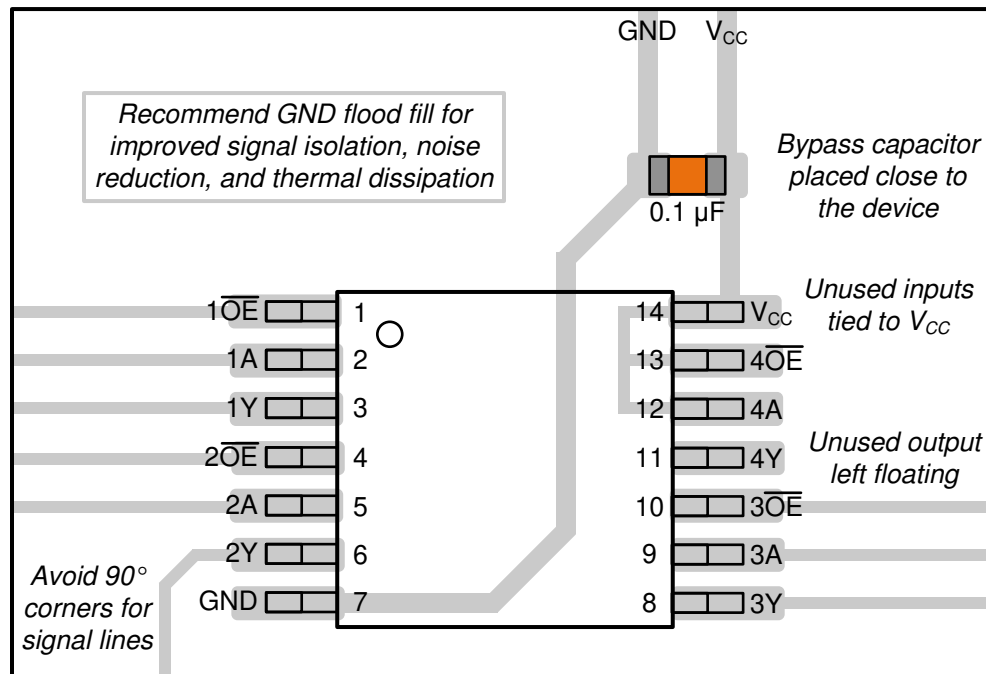

Figure 9-3. Example Layout for the SN74LV4T125-EP

10 Device and Documentation Support

10.1 Receiving Notification of Documentation Updates

To receive notification of documentation updates, navigate to the device product folder on ti.com. Click on *Notifications* to register and receive a weekly digest of any product information that has changed. For change details, review the revision history included in any revised document.

10.2 Support Resources

[TI E2E™ support forums](#) are an engineer's go-to source for fast, verified answers and design help — straight from the experts. Search existing answers or ask your own question to get the quick design help you need.

Linked content is provided "AS IS" by the respective contributors. They do not constitute TI specifications and do not necessarily reflect TI's views; see TI's [Terms of Use](#).

10.3 Trademarks

TI E2E™ is a trademark of Texas Instruments.
All trademarks are the property of their respective owners.

10.4 Electrostatic Discharge Caution



This integrated circuit can be damaged by ESD. Texas Instruments recommends that all integrated circuits be handled with appropriate precautions. Failure to observe proper handling and installation procedures can cause damage.

ESD damage can range from subtle performance degradation to complete device failure. Precision integrated circuits may be more susceptible to damage because very small parametric changes could cause the device not to meet its published specifications.

10.5 Glossary

[TI Glossary](#) This glossary lists and explains terms, acronyms, and definitions.

11 Revision History

DATE	REVISION	NOTES
January 2024	*	Initial Release

12 Mechanical, Packaging, and Orderable Information

The following pages include mechanical packaging and orderable information. This information is the most current data available for the designated devices. This data is subject to change without notice and revision of this document. For browser-based versions of this data sheet, refer to the left-hand navigation.

PACKAGING INFORMATION

Orderable Device	Status (1)	Package Type	Package Drawing	Pins	Package Qty	Eco Plan (2)	Lead finish/ Ball material (6)	MSL Peak Temp (3)	Op Temp (°C)	Device Marking (4/5)	Samples
SN74LV4T125PWREP	ACTIVE	TSSOP	PW	14	3000	RoHS & Green	NIPDAU	Level-1-260C-UNLIM	-55 to 125	L4125EP	Samples
V62/24608-01XE	ACTIVE	TSSOP	PW	14	3000	RoHS & Green	NIPDAU	Level-1-260C-UNLIM		L4125EP	Samples

(1) The marketing status values are defined as follows:

ACTIVE: Product device recommended for new designs.

LIFEBUY: TI has announced that the device will be discontinued, and a lifetime-buy period is in effect.

NRND: Not recommended for new designs. Device is in production to support existing customers, but TI does not recommend using this part in a new design.

PREVIEW: Device has been announced but is not in production. Samples may or may not be available.

OBSOLETE: TI has discontinued the production of the device.

(2) **RoHS:** TI defines "RoHS" to mean semiconductor products that are compliant with the current EU RoHS requirements for all 10 RoHS substances, including the requirement that RoHS substance do not exceed 0.1% by weight in homogeneous materials. Where designed to be soldered at high temperatures, "RoHS" products are suitable for use in specified lead-free processes. TI may reference these types of products as "Pb-Free".

RoHS Exempt: TI defines "RoHS Exempt" to mean products that contain lead but are compliant with EU RoHS pursuant to a specific EU RoHS exemption.

Green: TI defines "Green" to mean the content of Chlorine (Cl) and Bromine (Br) based flame retardants meet JS709B low halogen requirements of <=1000ppm threshold. Antimony trioxide based flame retardants must also meet the <=1000ppm threshold requirement.

(3) MSL, Peak Temp. - The Moisture Sensitivity Level rating according to the JEDEC industry standard classifications, and peak solder temperature.

(4) There may be additional marking, which relates to the logo, the lot trace code information, or the environmental category on the device.

(5) Multiple Device Markings will be inside parentheses. Only one Device Marking contained in parentheses and separated by a "~" will appear on a device. If a line is indented then it is a continuation of the previous line and the two combined represent the entire Device Marking for that device.

(6) Lead finish/Ball material - Orderable Devices may have multiple material finish options. Finish options are separated by a vertical ruled line. Lead finish/Ball material values may wrap to two lines if the finish value exceeds the maximum column width.

Important Information and Disclaimer:The information provided on this page represents TI's knowledge and belief as of the date that it is provided. TI bases its knowledge and belief on information provided by third parties, and makes no representation or warranty as to the accuracy of such information. Efforts are underway to better integrate information from third parties. TI has taken and continues to take reasonable steps to provide representative and accurate information but may not have conducted destructive testing or chemical analysis on incoming materials and chemicals. TI and TI suppliers consider certain information to be proprietary, and thus CAS numbers and other limited information may not be available for release.

In no event shall TI's liability arising out of such information exceed the total purchase price of the TI part(s) at issue in this document sold by TI to Customer on an annual basis.

OTHER QUALIFIED VERSIONS OF SN74LV4T125-EP :

- Catalog : [SN74LV4T125](#)
- Automotive : [SN74LV4T125-Q1](#)

NOTE: Qualified Version Definitions:

- Catalog - TI's standard catalog product
- Automotive - Q100 devices qualified for high-reliability automotive applications targeting zero defects

TAPE AND REEL INFORMATION

QUADRANT ASSIGNMENTS FOR PIN 1 ORIENTATION IN TAPE

*All dimensions are nominal

Device	Package Type	Package Drawing	Pins	SPQ	Reel Diameter (mm)	Reel Width W1 (mm)	A0 (mm)	B0 (mm)	K0 (mm)	P1 (mm)	W (mm)	Pin1 Quadrant
SN74LV4T125PWREP	TSSOP	PW	14	3000	330.0	12.4	6.9	5.6	1.6	8.0	12.0	Q1

TAPE AND REEL BOX DIMENSIONS

*All dimensions are nominal

Device	Package Type	Package Drawing	Pins	SPQ	Length (mm)	Width (mm)	Height (mm)
SN74LV4T125PWREP	TSSOP	PW	14	3000	356.0	356.0	35.0

PW (R-PDSO-G14)

PLASTIC SMALL OUTLINE



4040064-3/G 02/11

- NOTES:
- A. All linear dimensions are in millimeters. Dimensioning and tolerancing per ASME Y14.5M-1994.
 - B. This drawing is subject to change without notice.
 - C. Body length does not include mold flash, protrusions, or gate burrs. Mold flash, protrusions, or gate burrs shall not exceed 0,15 each side.
 - D. Body width does not include interlead flash. Interlead flash shall not exceed 0,25 each side.
 - E. Falls within JEDEC MO-153

IMPORTANT NOTICE AND DISCLAIMER

TI PROVIDES TECHNICAL AND RELIABILITY DATA (INCLUDING DATA SHEETS), DESIGN RESOURCES (INCLUDING REFERENCE DESIGNS), APPLICATION OR OTHER DESIGN ADVICE, WEB TOOLS, SAFETY INFORMATION, AND OTHER RESOURCES "AS IS" AND WITH ALL FAULTS, AND DISCLAIMS ALL WARRANTIES, EXPRESS AND IMPLIED, INCLUDING WITHOUT LIMITATION ANY IMPLIED WARRANTIES OF MERCHANTABILITY, FITNESS FOR A PARTICULAR PURPOSE OR NON-INFRINGEMENT OF THIRD PARTY INTELLECTUAL PROPERTY RIGHTS.

These resources are intended for skilled developers designing with TI products. You are solely responsible for (1) selecting the appropriate TI products for your application, (2) designing, validating and testing your application, and (3) ensuring your application meets applicable standards, and any other safety, security, regulatory or other requirements.

These resources are subject to change without notice. TI grants you permission to use these resources only for development of an application that uses the TI products described in the resource. Other reproduction and display of these resources is prohibited. No license is granted to any other TI intellectual property right or to any third party intellectual property right. TI disclaims responsibility for, and you will fully indemnify TI and its representatives against, any claims, damages, costs, losses, and liabilities arising out of your use of these resources.

TI's products are provided subject to [TI's Terms of Sale](#) or other applicable terms available either on [ti.com](https://www.ti.com) or provided in conjunction with such TI products. TI's provision of these resources does not expand or otherwise alter TI's applicable warranties or warranty disclaimers for TI products.

TI objects to and rejects any additional or different terms you may have proposed.

Mailing Address: Texas Instruments, Post Office Box 655303, Dallas, Texas 75265
Copyright © 2024, Texas Instruments Incorporated