

FOUR-CHANNEL AUTOMOTIVE DIGITAL AMPLIFIERS

Check for Samples: [TAS5414B-Q1](#), [TAS5424B-Q1](#)

FEATURES

- TAS5414B-Q1 – Single-Ended Input
- TAS5424B-Q1 – Differential Input
- Four-Channel Digital Power Amplifier
- Four Analog Inputs, Four BTL Power Outputs
- Typical Output Power at 10% THD+N
 - 28 W/Ch Into 4 Ω at 14.4 V
 - 50 W/Ch Into 2 Ω at 14.4 V
 - 79 W/Ch Into 4 Ω at 24 V
 - 150 W/Ch Into 2 Ω at 24 V (PBTL)
- Channels Can Be Paralleled (PBTL) for High Current Applications
- THD+N < 0.02%, 1 kHz, 1 W Into 4 Ω
- Patented Pop- and Click-Reduction Technology
 - Soft Muting With Gain Ramp Control
 - Common-Mode Ramping
- Patented AM Interference Avoidance
- Patented Cycle-by-Cycle Current Limit
- 75-dB PSRR
- Four-Address I²C Serial Interface for Device Configuration and Control
- Channel Gains: 12-dB, 20-dB, 26-dB, 32-dB
- Load Diagnostic Functions:
 - Output Open and Shorted Load
 - Output-to-Power and -to-Ground Shorts
 - Patented Tweeter Detection
- Protection and Monitoring Functions:
 - Short-Circuit Protection
 - Load-Dump Protection to 50 V
 - Fortuitous Open Ground and Power Tolerant
 - Patented Output DC Level Detection While Music Playing
 - Over-temperature Protection
 - Over- and Undervoltage Conditions
 - Clip Detection

- 36-Pin PSOP3 (DKD) Power SOP Package With Heat Slug Up for the TAS5414B-Q1
- 44-Pin PSOP3 (DKD) Power SOP Package With Heat Slug Up for the TAS5424B-Q1
- 44-Pin PSOP3 (DKE) Low-Standoff Power SOP Package With Heat Slug Up for the TAS5424B-Q1
- 64-Pin QFP (PHD) Power Package With Heat Slug Up for TAS5414B-Q1
- Designed for Automotive EMC Requirements
- Qualified According to AEC-Q100
- ISO9000:2002 TS16949 Certified
- –40°C to 105°C Ambient Temperature Range

APPLICATIONS

- OEM/Retail Head Units and Amplifier Modules Where Feature Densities and System Configurations Require Reduction in Heat From the Audio Power Amplifier

DESCRIPTION

The TAS5414B-Q1 and TAS5424B-Q1 are four-channel digital audio amplifiers designed for use in automotive head units and external amplifier modules. They provide four channels at 23 W continuously into 4 Ω at less than 1% THD+N from a 14.4-V supply. Each channel can also deliver 38 W into 2 Ω at 1% THD+N. The TAS5414B-Q1 uses single-ended analog inputs, while the TAS5424B-Q1 employs differential inputs for increased immunity to common-mode system noise. The digital PWM topology of the device provides dramatic improvements in efficiency over traditional linear amplifier solutions. This reduces the power dissipated by the amplifier by a factor of ten under typical music playback conditions. The device incorporates all the functionality needed to perform in the demanding OEM applications area. They have built-in load diagnostic functions for detecting and diagnosing misconnected outputs to help to reduce test time during the manufacturing process.



Please be aware that an important notice concerning availability, standard warranty, and use in critical applications of Texas Instruments semiconductor products and disclaimers thereto appears at the end of this data sheet.



These devices have limited built-in ESD protection. The leads should be shorted together or the device placed in conductive foam during storage or handling to prevent electrostatic damage to the MOS gates.

FUNCTIONAL BLOCK DIAGRAM

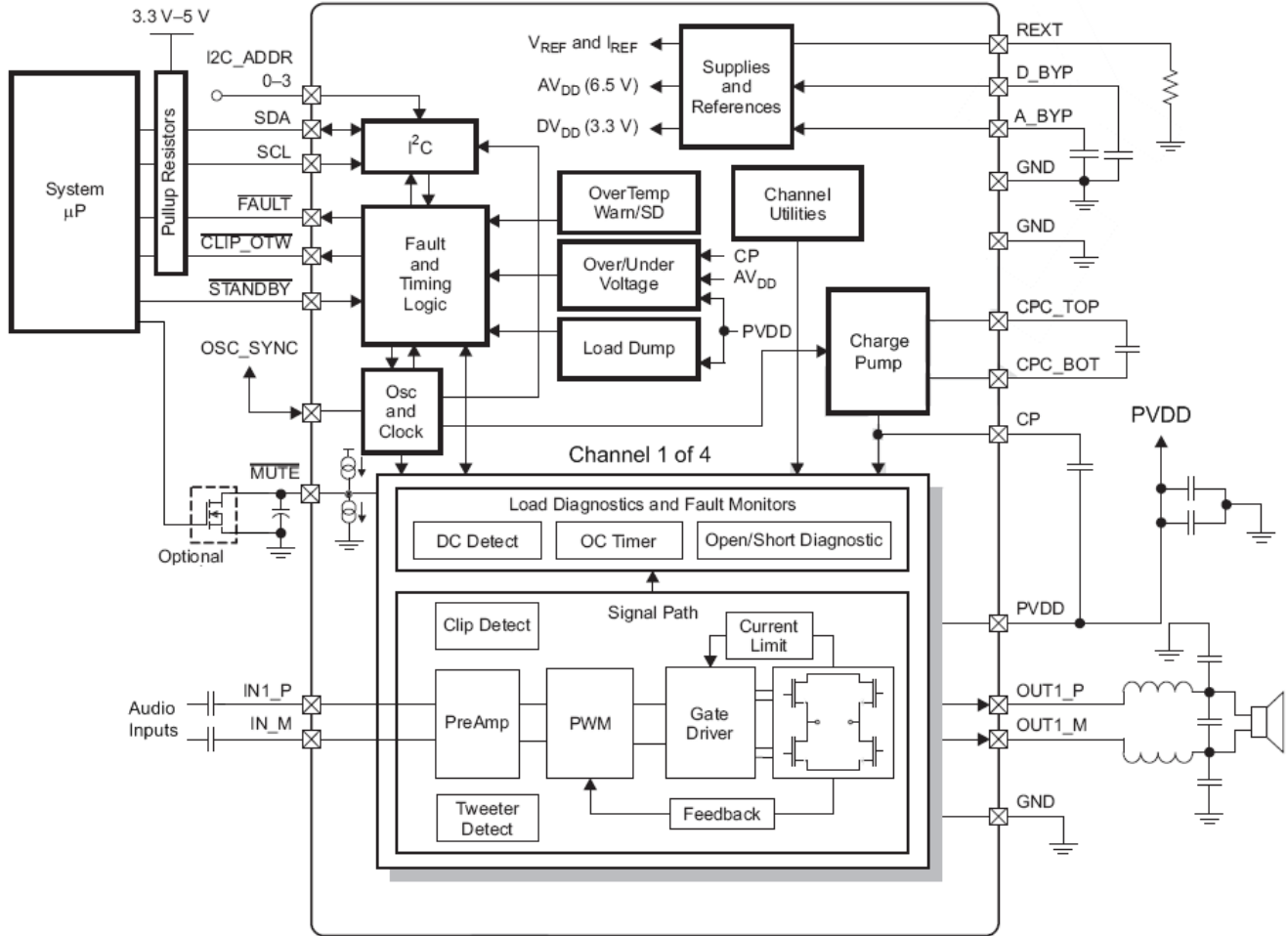

PIN ASSIGNMENTS AND FUNCTIONS

The pin assignments are shown as follows.

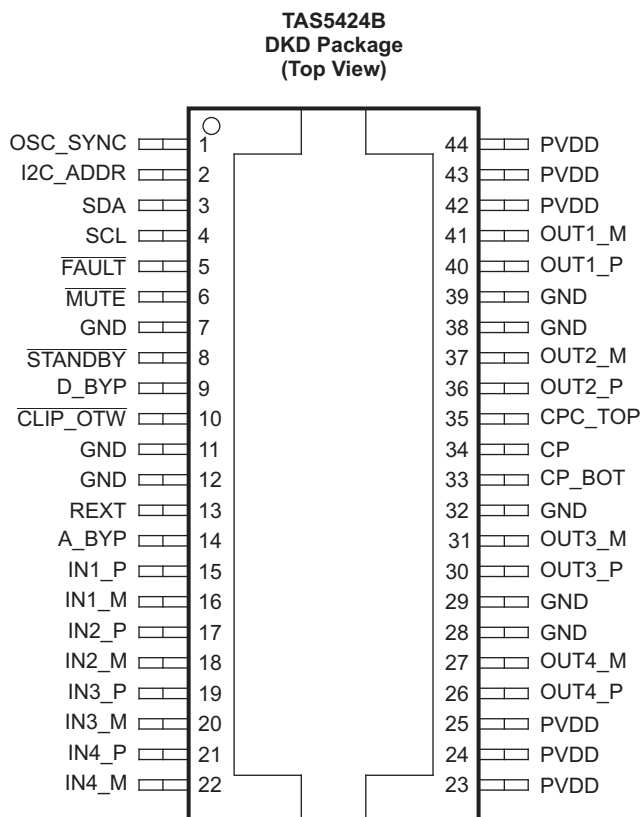
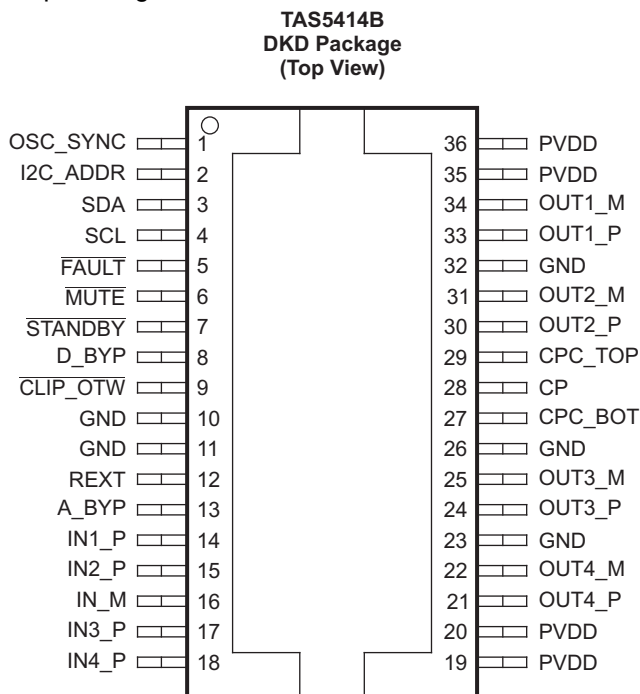

TAS5414B
PHD Package
(Top View)

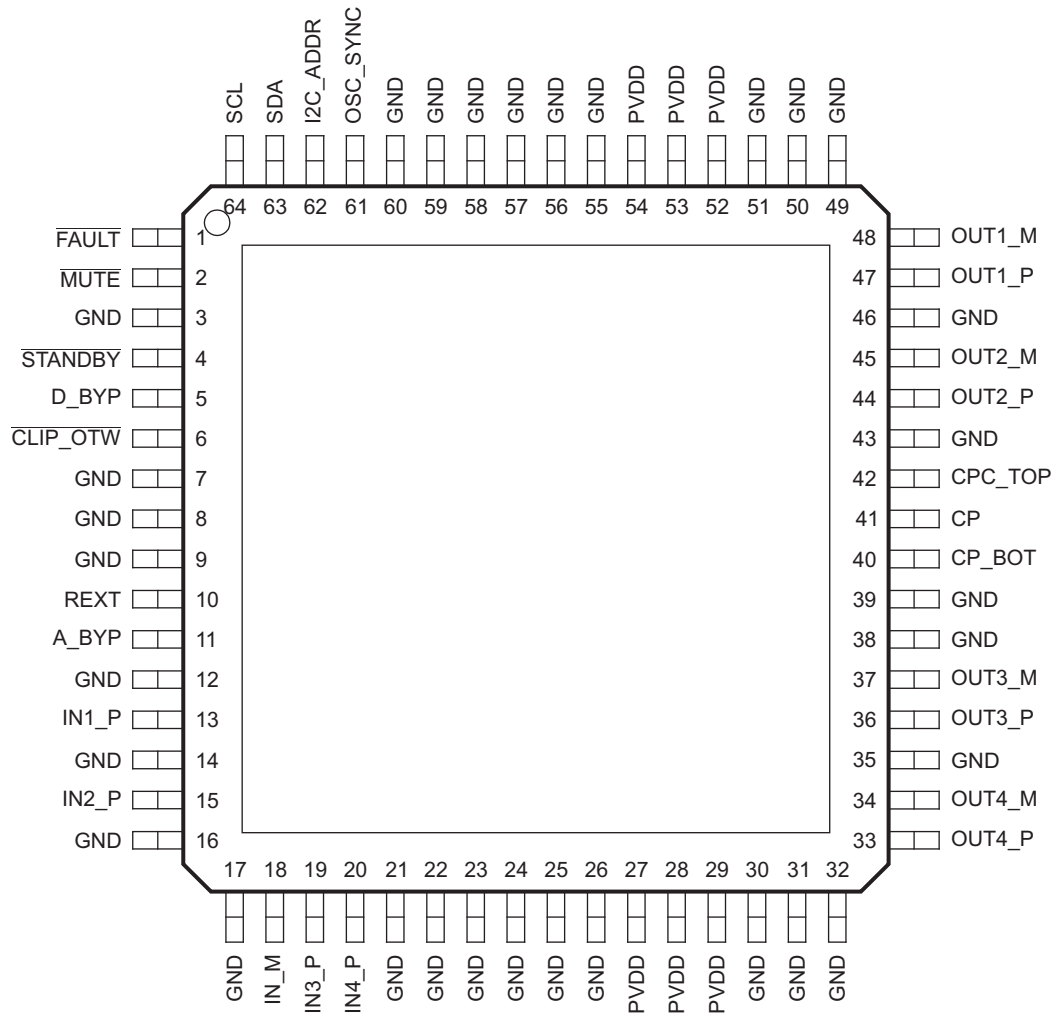

Table 1. PIN FUNCTIONS

NAME	PIN			TYPE ⁽¹⁾	DESCRIPTION
	DKD/DKE PACKAGE		PHD PACKAGE		
	TAS5414B-Q1 NO.	TAS5424B-Q1 NO.	TAS5414B-Q1 NO.		
A_BYP	13	14	11	PBY	Bypass pin for the AVDD analog regulator
$\overline{\text{CLIP_OTW}}$	9	10	6	DO	Reports CLIP, OTW, or both. It also reports tweeter detection during tweeter mode. Open-Drain.
CP	28	34	41	CP	Top of main storage capacitor for charge pump (bottom goes to PVDD)
CPC_BOT	27	33	40	CP	Bottom of flying capacitor for charge pump
CPC_TOP	29	35	42	CP	Top of flying capacitor for charge pump
D_BYP	8	9	5	PBY	Bypass pin for DVDD regulator output
$\overline{\text{FAULT}}$	5	5	1	DO	Global fault output (open drain): UV, OV, OTSD, OCSO, DC
GND	10, 11, 23, 26, 32	7, 11, 12, 28, 29, 32, 38, 39	3, 7, 8, 9, 12, 14, 16, 17, 21, 22, 23, 24, 25, 26, 30, 31, 32, 35, 38, 39, 43, 46, 49, 50, 51, 55, 56, 57, 58, 59, 60	GND	Ground
I2C_ADDR	2	2	62	AI	I ² C address bit
IN1_M	N/A	16	N/A	AI	Inverting analog input for channel 1 (TAS5424B-Q1 only)
IN1_P	14	15	13	AI	Non-inverting analog input for channel 1
IN2_M	N/A	18	N/A	AI	Inverting analog input for channel 2 (TAS5424B-Q1 only)
IN2_P	15	17	15	AI	Non-inverting analog input for channel 2
IN3_M	N/A	20	N/A	AI	Inverting analog input for channel 3 (TAS5424B-Q1 only)
IN3_P	17	19	19	AI	Non-inverting analog input for channel 3
IN4_M	N/A	22	N/A	AI	Inverting analog input for channel 4 (TAS5424B-Q1 only)
IN4_P	18	21	20	AI	Non-inverting analog input for channel 4
IN_M	16	N/A	18	ARTN	Signal return for the 4 analog channel inputs (TAS5414B-Q1 only)
$\overline{\text{MUTE}}$	6	6	2	AI	Gain ramp control: mute (low), play (high)
OSC_SYNC	1	1	61	DI/DO	Oscillator input from master or output to slave amplifiers
OUT1_M	34	41	48	PO	– polarity output for bridge 1
OUT1_P	33	40	47	PO	+ polarity output for bridge 1
OUT2_M	31	37	45	PO	– polarity output for bridge 2
OUT2_P	30	36	44	PO	+ polarity output for bridge 2
OUT3_M	25	31	37	PO	– polarity output for bridge 3
OUT3_P	24	30	36	PO	+ polarity output for bridge 3
OUT4_M	22	27	34	PO	– polarity output for bridge 4
OUT4_P	21	26	33	PO	+ polarity output for bridge 4
PVDD	19, 20, 35, 36	23, 24, 25, 42, 43, 44	27, 28, 29, 52, 53, 54	PWR	PVDD supply
REXT	12	13	10	AI	Precision resistor pin to set analog reference
SCL	4	4	64	DI	I ² C clock input from system I ² C master
SDA	3	3	63	DI/DO	I ² C data I/O for communication with system I ² C master
$\overline{\text{STANDBY}}$	7	8	4	DI	Active-low STANDBY pin. Standby (low), power up (high)

(1) DI = digital input, DO = digital output, AI = analog input, ARTN = analog signal return, PWR = power supply, PBY = power bypass, PO = power output, GND = ground, CP = charge pump.

ABSOLUTE MAXIMUM RATINGS

over operating free-air temperature range (unless otherwise noted)

			VALUE	UNIT
PVDD	DC supply voltage range	Relative to GND	–0.3 to 30	V
PVDD _{MAX}	Pulsed supply voltage range	t ≤ 100 ms exposure	–1 to 50	V
PVDD _{RAMP}	Supply voltage ramp rate		15	V/ms
I _{PVDD}	Externally imposed dc supply current per PVDD or GND pin		±12	A
I _{PVDD_MAX}	Pulsed supply current per PVDD pin (one shot)	t < 100 ms	17	A
I _O	Maximum allowed dc current per output pin		±13.5	A
I _{O_MAX} ⁽¹⁾	Pulsed output current per output pin (single pulse)	t < 100 ms	±17	A
I _{IN_MAX}	Maximum current, all digital and analog input pins ⁽²⁾	DC or pulsed	±1	mA
I _{MUTE_MAX}	Maximum current on $\overline{\text{MUTE}}$ pin	DC or pulsed	±20	mA
I _{IN_ODMAX}	Maximum sink current for open-drain pins		7	mA
V _{LOGIC}	Input voltage range for pin relative to GND (SCL, SDA, I2C_ADDR pins)	Supply voltage range: 6V < PVDD < 24 V	–0.3 to 6	V
V _{MUTE}	Voltage range for $\overline{\text{MUTE}}$ pin relative to GND	Supply voltage range: 6 V < PVDD < 24 V	–0.3 to 7.5	V
V _{STANDBY}	Input voltage range for $\overline{\text{STANDBY}}$ pin	Supply voltage range: 6 V < PVDD < 24 V	–0.3 to 5.5	V
V _{OSC_SYNC}	Input voltage range for OSC_SYNC pin relative to GND	Supply voltage range: 6 V < PVDD < 24 V	–0.3 to 3.6	V
V _{GND}	Maximum voltage between GND pins		±0.3	V
V _{AIN_AC_MAX_5414}	Maximum ac-coupled input voltage for TAS5414B-Q1 ⁽²⁾ , analog input pins	Supply voltage range: 6 V < PVDD < 24 V	1.9	V _{rms}
V _{AIN_AC_MAX_5424}	Maximum ac-coupled differential input voltage for TAS5424B-Q1 ⁽²⁾ , analog input pins	Supply voltage range: 6 V < PVDD < 24 V	3.8	V _{rms}
T _J	Maximum operating junction temperature range		–55 to 150	°C
T _{stg}	Storage temperature range		–55 to 150	°C

(1) Pulsed current ratings are maximum survivable currents externally applied to the device. High currents may be encountered during reverse battery, fortuitous open ground, and fortuitous open supply fault conditions.

(2) See [Application Information](#) section for information on analog input voltage and ac coupling.

THERMAL CHARACTERISTICS

PARAMETER	VALUE (Typical)	UNIT
R _{θJC} Junction-to-case (heat slug) thermal resistance, DKD package	1.0	°C/W
R _{θJC} Junction-to-case (heat slug) thermal resistance, PHD package	1.2	
R _{θJA} Junction-to-ambient thermal resistance	This device is not intended to be used without a heatsink. Therefore, R _{θJA} is not specified. See the Thermal Information section.	
Exposed pad dimensions, DKD package	13.8 × 5.8	mm
Exposed pad dimensions, PHD package	8 × 8	

ELECTROSTATIC DISCHARGE (ESD)

PARAMETER	Package	Pins	VALUE (Typical)	UNIT
Human Body Model (HBM) AEC-Q100-002	All	All	3000	V
Charged Device Model (CDM) AEC-Q100-011	DKD/DKE	Corner Pins excluding OSC_SYNC	1000	
		All other pins (including OSC_SYNC) except CP pin CP Pin (Non-Corner Pin)	500 400	
	PHD	Corner Pins excluding SCL All Pins (including SCL) except CP and CP_Top CP and CP_Top Pins	750 600 400	
Machine Model (MM) AEC-Q100-003	DKD/DKE		150	
	PHD		100	

RECOMMENDED OPERATING CONDITIONS⁽¹⁾

			MIN	TYP	MAX	UNIT
PVDD _{OP}	DC supply voltage range relative to GND		6	14.4	24	V
V _{AIN_5414} ⁽²⁾	Analog audio input signal level (TAS5414B-Q1)	AC-coupled input voltage	0		0.25–1 ⁽³⁾	Vrms
V _{AIN_5424} ⁽²⁾	Analog audio input signal level (TAS5424B-Q1)	AC-coupled input voltage	0		0.5–2 ⁽³⁾	Vrms
T _A	Ambient temperature		–40		105	°C
T _J	Junction temperature	An adequate heat sink is required to keep T _J within specified range.	–40		115	°C
R _L	Nominal speaker load impedance		2	4		Ω
V _{PU}	Pullup voltage supply (for open-drain logic outputs)		3	3.3 or 5	5.5	V
R _{PU_EXT}	External pullup resistor on open-drain logic outputs	Resistor connected between open-drain logic output and V _{PU} supply	10		50	kΩ
R _{PU_I2C}	I ² C pullup resistance on SDA and SCL pins		1	4.7	10	kΩ
R _{I2C_ADD}	Total resistance of voltage divider for I ² C address slave 1 or slave 2, connected between D_BYP and GND pins		10		50	kΩ
R _{REXT}	External resistance on REXT pin	1% tolerance required	19.8	20	20.2	kΩ
C _{D_BYP} , C _{A_BYP}	External capacitance on D_BYP and A_BYP pins		10		120	nF
C _{OUT}	External capacitance to GND on OUT_X pins			150	680	nF
C _{IN}	External capacitance to analog input pin in series with input signal			0.47		μF
C _{FLY}	Flying capacitor on charge pump		0.47	1	1.5	μF
C _P	Charge pump capacitor	50V needed for Load Dump	0.47	1	1.5	μF
C _{MUTE}	MUTE pin capacitor		100	220	1000	nF
C _{OSCSYNC_MAX}	Allowed loading capacitance on OSC_SYNC pin			75		pF

- (1) The *Recommended Operating Conditions* table specifies only that the device is functional in the given range. See the *Electrical Characteristics* table for specified performance limits.
- (2) Signal input for full unclipped output with gains of 32 dB, 26 dB, 20 dB, and 12 dB
- (3) Maximum recommended input voltage is determined by the gain setting.

ELECTRICAL CHARACTERISTICS

Test conditions (unless otherwise noted): $T_{Case} = 25^{\circ}C$, $PVDD = 14.4 V$, $R_L = 4 \Omega$, $f_S = 417 kHz$, $P_{out} = 1 W/ch$, $R_{ext} = 20 k\Omega$, AES17 Filter, default I²C settings, master mode operation (see application diagram)

PARAMETER		TEST CONDITIONS	MIN	TYP	MAX	UNIT	
OPERATING CURRENT							
I_{PVDD_IDLE}	PVDD idle current	All four channels in MUTE mode		170	220	mA	
I_{PVDD_Hi-Z}		All four channels in Hi-Z mode		93			
I_{PVDD_STBY}	PVDD standby current	STANDBY mode, $T_J \leq 85^{\circ}C$		2	10	μA	
OUTPUT POWER							
P_{OUT}	Output power per channel	4 Ω , PVDD = 14.4 V, THD+N $\leq 1\%$, 1 kHz, $T_c = 75^{\circ}C$		23		W	
		4 Ω , PVDD = 14.4 V, THD+N = 10%, 1 kHz, $T_c = 75^{\circ}C$		25	28		
		4 Ω , PVDD = 24 V, THD+N = 10%, 1 kHz, $T_c = 75^{\circ}C$		63	79		
		2 Ω , PVDD = 14.4 V, THD+N = 1%, 1 kHz, $T_c = 75^{\circ}C$			38		
		2 Ω , PVDD = 14.4 V, THD+N = 10%, 1 kHz, $T_c = 75^{\circ}C$		40	50		
		PBTL 2- Ω operation, PVDD = 24 V, THD+N = 10%, 1 kHz, $T_c = 75^{\circ}C$			150		
		PBTL 1- Ω operation, PVDD = 14.4 V, THD+N = 10%, 1 kHz, $T_c = 75^{\circ}C$			90		
EFF_p	Power efficiency	4 channels operating, 23-W output power/ch, $L = 10 \mu H$, $T_J \leq 85^{\circ}C$		90%			
AUDIO PERFORMANCE							
V_{NOISE}	Noise voltage at output	Zero input, and A-weighting		60	100	μV	
Crosstalk	Channel crosstalk	$P = 1W$, $f = 1 kHz$, Enhanced Crosstalk Enabled via I ² C (reg 0x10)	70	85		dB	
$CMRR_{5424}$	Common-mode rejection ratio (TAS5424B-Q1)	$f = 1 kHz$, 1 Vrms referenced to GND, $G = 26 dB$	60	75		dB	
PSRR	Power supply rejection ratio	PVDD = 14.4 Vdc + 1 Vrms, $f = 1 kHz$	60	75		dB	
THD+N	Total harmonic distortion + noise	$P = 1W$, $f = 1 kHz$		0.02%	0.1%		
f_S	Switching frequency	Switching frequency selectable for AM interference avoidance		336	357	378	kHz
				392	417	442	
				470	500	530	
R_{AIN}	Analog input resistance	Internal shunt resistance on each input pin	63	85	106	k Ω	
V_{IN_CM}	Common-mode input voltage	AC coupled common-mode input voltage (zero differential input)		1.3		Vrms	
V_{CM_INT}	Internal common-mode input bias voltage	Internal bias applied to IN_M pin		3.3		V	
G	Voltage gain (V_O/V_{IN})	Source impedance = 0 Ω , gain measurement taken at 1 W of power per channel		11	12	13	dB
				19	20	21	
				25	26	27	
				31	32	33	
G_{CH}	Channel-to-channel variation	Any gain commanded	-1	0	1	dB	
PWM OUTPUT STAGE							
R_{DSon}	FET drain-to-source resistance	Not including bond wire resistance, $T_J = 25^{\circ}C$		65	90	m Ω	
V_{O_OFFSET}	Output offset voltage	Zero input signal, $G = 26 dB$		± 10	± 50	mV	
PVDD OVERVOLTAGE (OV) PROTECTION							
V_{OV_SET}	PVDD overvoltage shutdown set		24.6	26.4	28.2	V	
V_{OV_CLEAR}	PVDD overvoltage shutdown clear		24.4	25.9	27.4		
PVDD UNDERVOLTAGE (UV) PROTECTION							
V_{UV_SET}	PVDD undervoltage shutdown set		4.9	5.3	5.6	V	
V_{UV_CLEAR}	PVDD undervoltage shutdown clear		6.2	6.6	7.0	V	
AVDD							
V_{A_BYP}	A_BYP pin voltage			6.5		V	
$V_{A_BYP_UV_SET}$	A_BYP UV voltage			4.8		V	
$V_{A_BYP_UV_CLEAR}$	Recovery voltage A_BYP UV			5.3		V	
DVDD							
V_{D_BYP}	D_BYP pin voltage			3.3		V	

ELECTRICAL CHARACTERISTICS (continued)

Test conditions (unless otherwise noted): $T_{Case} = 25^{\circ}C$, $PVDD = 14.4 V$, $R_L = 4 \Omega$, $f_S = 417 kHz$, $P_{out} = 1 W/ch$, $R_{ext} = 20 k\Omega$, AES17 Filter, default I²C settings, master mode operation (see application diagram)

PARAMETER		TEST CONDITIONS	MIN	TYP	MAX	UNIT
POWER-ON RESET (POR)						
V_{POR}	PVDD voltage for POR	I ² C active above this voltage			3.5	V
V_{POR_HY}	PVDD recovery hysteresis voltage for POR			0.1		V
REXT						
V_{REXT}	Rext pin voltage			1.27		V
CHARGE PUMP (CP)						
V_{CPUV_SET}	CP undervoltage			4.8		V
V_{CPUV_CLEAR}	Recovery voltage for CP UV			4.9		V
OVERTEMPERATURE (OT) PROTECTION						
T_{OTW1_CLEAR}	Junction temperature for overtemperature warning		96	112	128	°C
$T_{OTW1_SET} / T_{OTW2_CLEAR}$			106	122	138	
$T_{OTW2_SET} / T_{OTW3_CLEAR}$			116	132	148	
$T_{OTW3_SET} / T_{OTSD_CLEAR}$			126	142	158	
T_{OTSD}	Junction temperature for overtemperature shutdown		136	152	168	
T_{FB}	Junction temperature for overtemperature foldback	Per channel	130	150	170	
CURRENT LIMITING PROTECTION						
I_{LIM}	Current limit (load current)	Level 1	5.5	7.3	9.0	A
		Level 2 (default)	10.6	12.7	15.0	
OVERCURRENT (OC) SHUTDOWN PROTECTION						
I_{MAX}	Maximum current (peak output current)	Level 1	7.8	9.8	12.2	A
		Level 2 (default), Any short to supply, ground, or other channels	11.9	14.8	17.7	
TWEETER DETECT						
I_{TH_TW}	Load current threshold for tweeter detect		330	445	560	mA
I_{LIM_TW}	Load current limit for tweeter detect			2.1		A
STANDBY MODE						
V_{IH_STBY}	$\overline{STANDBY}$ input voltage for logic-level high		2			V
V_{IL_STBY}	$\overline{STANDBY}$ input voltage for logic-level low				0.7	V
I_{STBY_PIN}	$\overline{STANDBY}$ pin current			0.1	0.2	μA
MUTE MODE						
G_{MUTE}	Output attenuation	MUTE pin $\leq 0.5 V + 200mS$ or I ² C Mute Enabled		100		dB
DC DETECT						
$V_{TH_DC_TOL}$	DC detect threshold tolerance			25		%
t_{DCD}	DC detect step response time for four channels				5.3	s
CLIP_OTW REPORT						
$V_{OH_CLIPOTW}$	$\overline{CLIP_OTW}$ pin output voltage for logic level high (open-drain logic output)	External 47-kΩ pullup resistor to 3 V–5.5 V	2.4			V
$V_{OL_CLIPOTW}$	$\overline{CLIP_OTW}$ pin output voltage for logic level low (open-drain logic output)				0.5	
$t_{DELAY_CLIPDET}$	$\overline{CLIP_OTW}$ signal delay when output clipping detected				20	μs
FAULT REPORT						
V_{OH_FAULT}	\overline{FAULT} pin output voltage for logic-level high (open-drain logic output)	External 47-kΩ pullup resistor to 3 V–5.5 V	2.4			V
V_{OL_FAULT}	\overline{FAULT} pin output voltage for logic-level low (open-drain logic output)				0.5	
OPEN/SHORT DIAGNOSTICS						

ELECTRICAL CHARACTERISTICS (continued)

Test conditions (unless otherwise noted): $T_{Case} = 25^{\circ}C$, $PVDD = 14.4 V$, $R_L = 4 \Omega$, $f_S = 417 kHz$, $P_{out} = 1 W/ch$, $R_{ext} = 20 k\Omega$, AES17 Filter, default I²C settings, master mode operation (see application diagram)

PARAMETER		TEST CONDITIONS	MIN	TYP	MAX	UNIT
R_{S2P} , R_{S2G}	Maximum resistance to detect a short from OUT pin(s) to PVDD or ground				200	Ω
R_{OPEN_LOAD}	Minimum load resistance to detect open circuit	Including speaker wires	300	740	1300	Ω
$R_{SHORTED_LOAD}$	Maximum load resistance to detect short circuit	Including speaker wires	0.5	1.0	1.5	Ω
I²C ADDRESS DECODER						
$t_{LATCH_I2CADDR}$	Time delay to latch I ² C address after POR			300		μs
V_{I2C_ADDR}	Voltage on I2C_ADDR pin for address 0	Connect to GND	0%	0%	15%	V_{D_BYP}
	Voltage on I2C_ADDR pin for address 1	External resistors in series between D_BYP and GND as a voltage divider	25%	35%	45%	
	Voltage on I2C_ADDR pin for address 2		55%	65%	75%	
	Voltage on I2C_ADDR pin for address 3	Connect to D_BYP	85%	100%	100%	
I²C						
t_{HOLD_I2C}	Power-on hold time before I ² C communication	$\overline{STANDBY}$ high		1		ms
f_{SCL}	SCL clock frequency				400	kHz
V_{IH_SCL}	SCL pin input voltage for logic-level high	$R_{PU_I2C} = 5\text{-k}\Omega$ pullup, supply voltage = 3.3 V or 5 V	2.1		5.5	V
V_{IL_SCL}	SCL pin input voltage for logic-level low		-0.5		1.1	V
V_{OH_SDA}	SDA pin output voltage for logic-level high	I ² C read, $R_{I2C} = 5\text{-k}\Omega$ pullup, supply voltage = 3.3 V or 5 V	2.4			V
V_{OL_SDA}	SDA pin output voltage for logic-level low	I ² C read, 3-mA sink current			0.4	V
V_{IH_SDA}	SDA pin input voltage for logic-level high	I ² C write, $R_{I2C} = 5\text{-k}\Omega$ pullup, supply voltage = 3.3 V or 5 V	2.1		5.5	V
V_{IL_SDA}	SDA pin input voltage for logic-level low	I ² C write, $R_{I2C} = 5\text{-k}\Omega$ pullup, supply voltage = 3.3 V or 5 V	-0.5		1.1	V
C_i	Capacitance for SCL and SDA pins				10	pF
OSCILLATOR						
$V_{OH_OSCSYNC}$	OSC_SYNC pin output voltage for logic-level high	I2C_ADDR pin set to MASTER mode	2.4			V
$V_{OL_OSCSYNC}$	OSC_SYNC pin output voltage for logic-level low		0.5			V
$V_{IH_OSCSYNC}$	OSC_SYNC pin input voltage for logic-level high	I2C_ADDR pin set to SLAVE mode	2			V
$V_{IL_OSCSYNC}$	OSC_SYNC pin input voltage for logic-level low		0.8			V
f_{OSC_SYNC}	OSC_SYNC pin clock frequency	I2C_ADDR pin set to MASTER mode, $f_S = 500 kHz$	3.76	4.0	4.24	MHz
		I2C_ADDR pin set to MASTER mode, $f_S = 417 kHz$	3.13	3.33	3.63	
		I2C_ADDR pin set to MASTER mode, $f_S = 357 kHz$	2.68	2.85	3.0	

TIMING REQUIREMENTS FOR I²C INTERFACE SIGNALS

over recommended operating conditions (unless otherwise noted)

PARAMETER		MIN	TYP	MAX	UNIT
t_r	Rise time for both SDA and SCL signals			300	ns
t_f	Fall time for both SDA and SCL signals			300	ns
$t_{w(H)}$	SCL pulse duration, high	0.6			μ s
$t_{w(L)}$	SCL pulse duration, low	1.3			μ s
t_{su2}	Setup time for START condition	0.6			μ s
t_{h2}	START condition hold time after which first clock pulse is generated	0.6			μ s
t_{su1}	Data setup time	100			ns
t_{h1}	Data hold time	0 ⁽¹⁾			ns
t_{su3}	Setup time for STOP condition	0.6			μ s
C_B	Load capacitance for each bus line			400	pF

- (1) A device must internally provide a hold time of at least 300 ns for the SDA signal to bridge the undefined region of the falling edge of SCL.

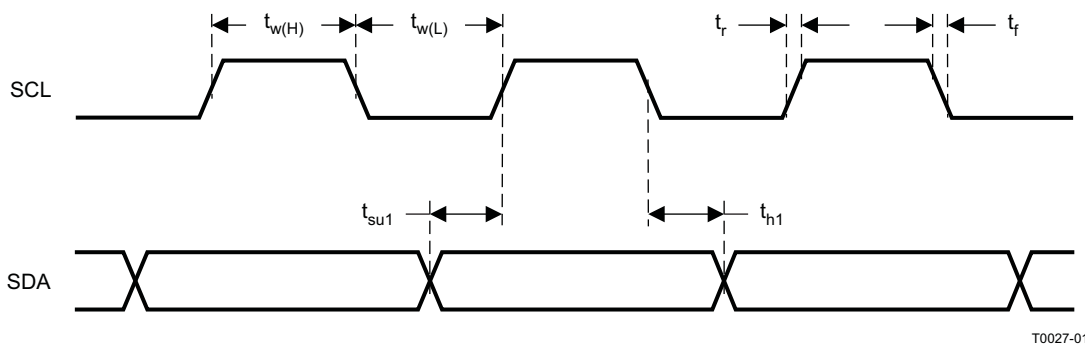

Figure 1. SCL and SDA Timing

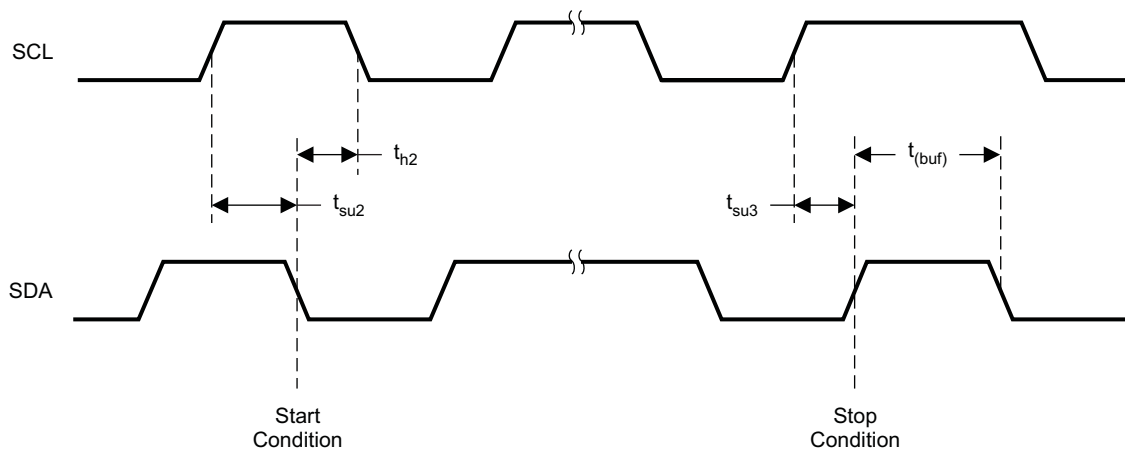

Figure 2. Timing for Start and Stop Conditions

TYPICAL CHARACTERISTICS

**THD+N
vs
BTL OUTPUT POWER at 1kHz**

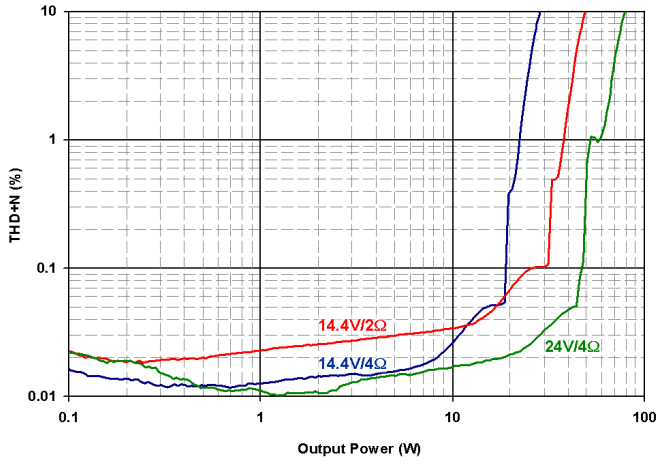

Figure 3.

**THD+N
vs
PBTL OUTPUT POWER at 1kHz**

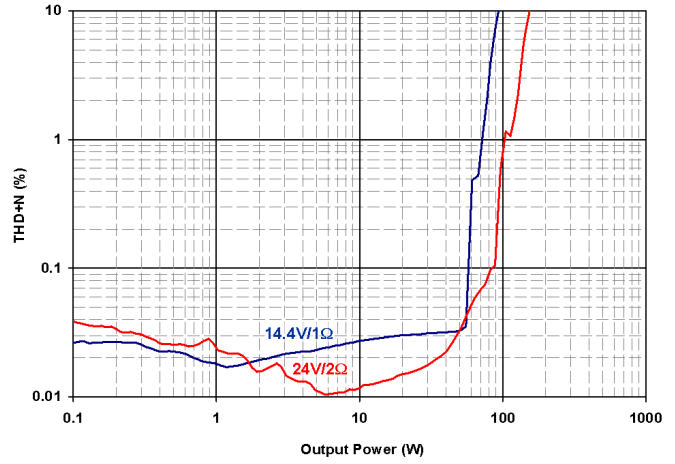

Figure 4.

**THD+N
vs
FREQUENCY at 1 Watt**

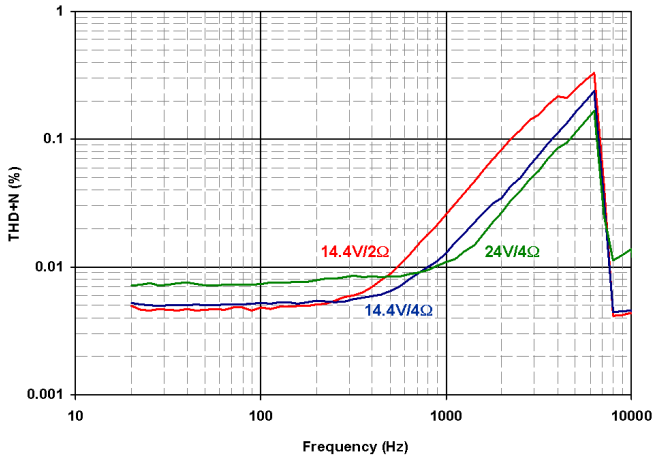

Figure 5.

**TAS5424B-Q1
COMMON-MODE REJECTION RATIO
vs
FREQUENCY**

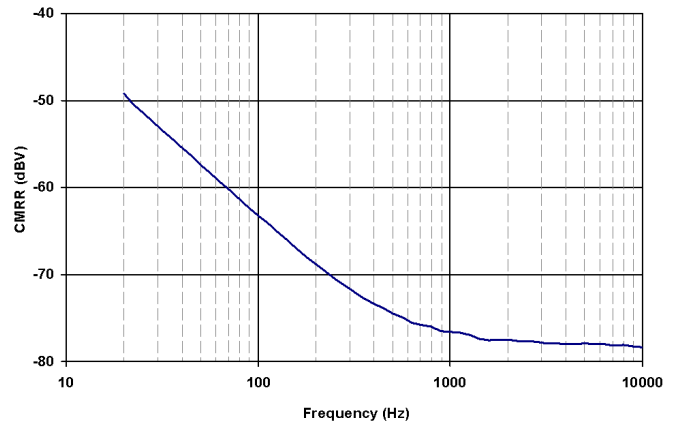

Figure 6.

TYPICAL CHARACTERISTICS (continued)

CROSSTALK
VS
FREQUENCY

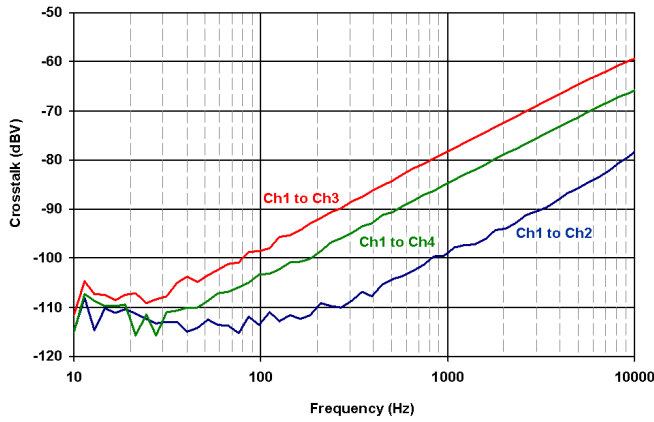

Figure 7.

NOISE FFT

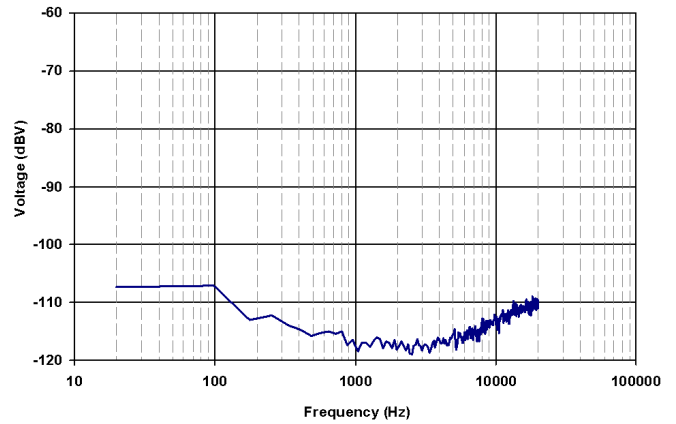

Figure 8.

EFFICIENCY,
FOUR CHANNELS AT 4 Ω EACH

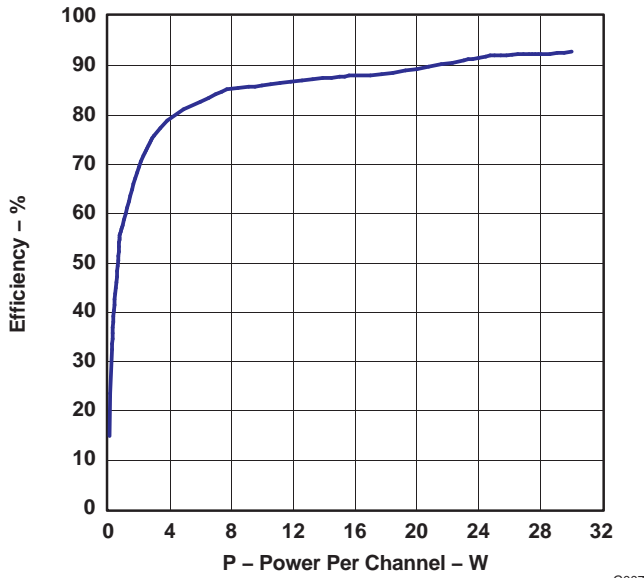

Figure 9.

DEVICE POWER DISSIPATION
FOUR CHANNELS AT 4 Ω EACH

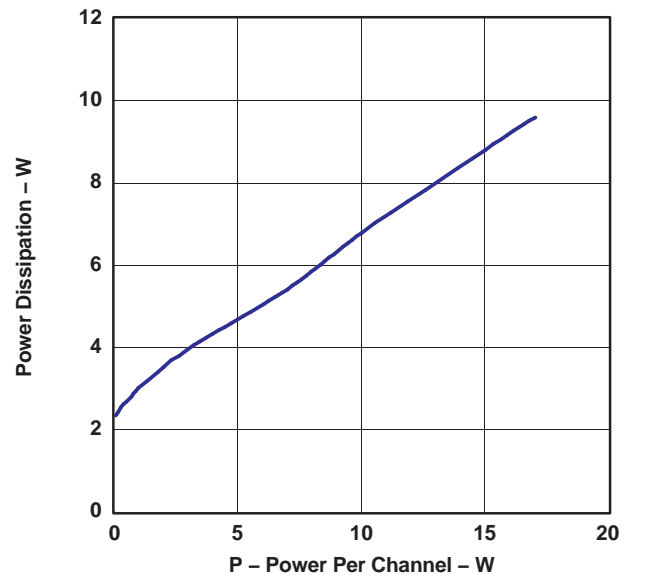

Figure 10.

DESCRIPTION OF OPERATION

OVERVIEW

The TAS5414B-Q1 and TAS5424B-Q1 are single-chip, four-channel, analog-input audio amplifiers for use in the automotive environment. The design uses an ultra-efficient class-D technology developed by Texas Instruments, but with changes needed by the automotive industry. This technology allows for reduced power consumption, reduced heat, and reduced peak currents in the electrical system. The device realizes an audio sound system design with smaller size and lower weight than traditional class-AB solutions.

There are eight core design blocks:

- Preamplifier
- PWM
- Gate drive
- Power FETs
- Diagnostics
- Protection
- Power supply
- I²C serial communication bus

Preamplifier

The preamplifier is a high-input-impedance, low-noise, low-offset-voltage input stage with adjustable gain. The high input impedance allows the use of low-cost input capacitors while still achieving extended low-frequency response. The preamplifier is powered by a dedicated, internally regulated supply, which gives it excellent noise immunity and channel separation. Also included in the preamp are:

1. **Mute Pop-and-Click Control**— The device ramps the gain gradually when a mute or play command is received. Another form of click and pop can be caused by the start or stopping of switching in a class-D amplifier. The TAS5414B-Q1 and TAS5424B-Q1 incorporate a patented method to reduce the pop energy during the switching startup and shutdown sequence. Fault conditions require rapid protection response by the TAS5414B-Q1 and the TAS5424B-Q1, which do not have time to ramp the gain down in a pop-free manner. The device transitions into Hi-Z mode when an OV, UV, OC, OT, or DC fault is encountered. Also, activation of the STANDBY pin may not be pop-free.
2. **Gain Control**—The four gain settings are set in the preamplifier via I²C control registers. The gain is set outside of the global feedback resistors of the device, thus allowing for stability of the system at all gain settings with properly loaded conditions.

Pulse-Width Modulator (PWM)

The PWM converts the analog signal from the preamplifier into a switched signal of varying duty cycle. This is the critical stage that defines the class-D architecture. In the TAS5414B-Q1 and TAS5424B-Q1, the modulator is an advanced design with high bandwidth, low noise, low distortion, excellent stability, and full 0–100% modulation capability. The patented PWM uses clipping recovery circuitry to eliminate the deep saturation characteristic of PWMs when the input signal exceeds the modulator waveform.

Gate Drive

The gate driver accepts the low-voltage PWM signal and level shifts it to drive a high-current, full-bridge, power FET stage. The device uses proprietary techniques to optimize EMI and audio performance.

Power FETs

The BTL output for each channel comprises four rugged N-channel 30-V 65 mΩ FETs for high efficiency and maximum power transfer to the load. These FETs are designed to handle large voltage transients during load dump.

Load Diagnostics

The device incorporates load diagnostic circuitry designed to help pinpoint the nature of output misconnections during installation. The TAS5414B-Q1 and the TAS5424B-Q1 include functions for detecting and determining the status of output connections. The following diagnostics are supported:

- Short to GND
- Short to PVDD
- Short across load
- Open load
- Tweeter detection

The presence of any of the short or open conditions is reported to the system via I²C register read. The tweeter detect status can be read from the CLIP_OTW pin when properly configured.

1. **Output Short and Open Diagnostics**—The device contains circuitry designed to detect shorts and open conditions on the outputs. The load diagnostic function can only be invoked when the output is in the Hi-Z mode. There are four phases of test during load diagnostics and two levels of test. In the full level, all channels must be in the Hi-Z state. All four phases are tested on each channel, all four channels at the same time. When fewer than four channels are in Hi-Z, the reduced level of test is the only available option. In the reduced level, only short to PVDD and short to GND can be tested. Load diagnostics can occur at power up before the amplifier is moved out of Hi-Z mode. If the amplifier is already in play mode, it must *Mute* and then *Hi-Z* before the load diagnostic can be performed. By performing the mute function, the normal pop- and click-free transitions occur before the diagnostics begin. The diagnostics are performed as shown in Figure 11. Figure 12 shows the impedance ranges for the open-load and shorted-load diagnostics. The results of the diagnostic are read from the diagnostic register for each channel via I²C. With the default settings and MUTE capacitor the S2G and S2P phase take ~20mS each, the OL phase takes ~100mS, and the SL takes ~230mS.

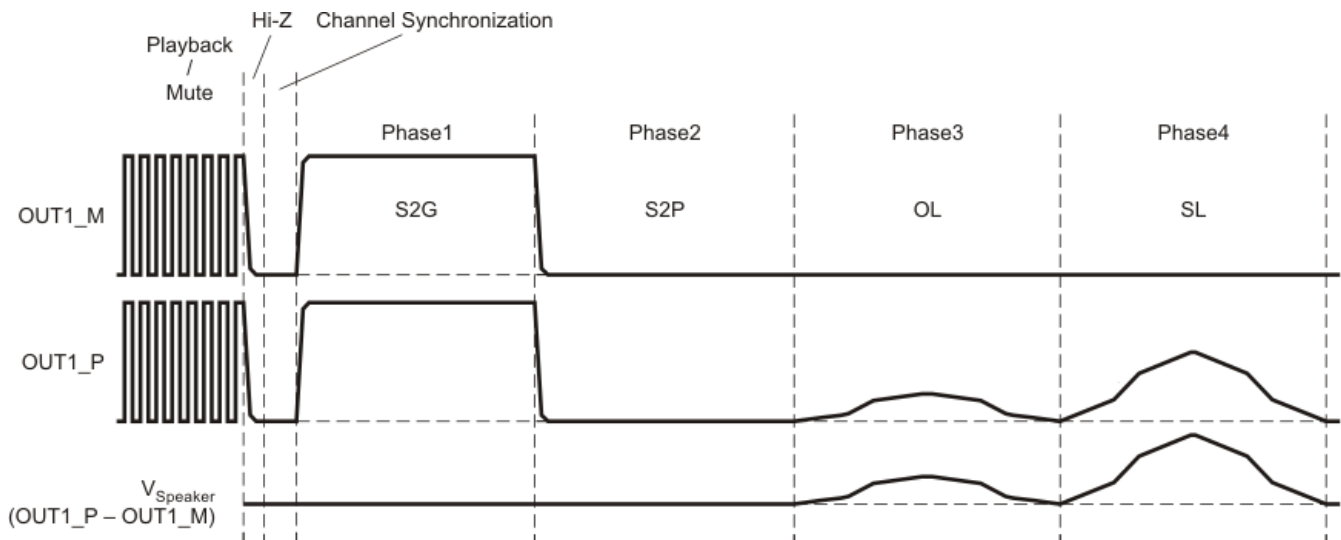

T0188-01

Figure 11. Load Diagnostics Sequence of Events

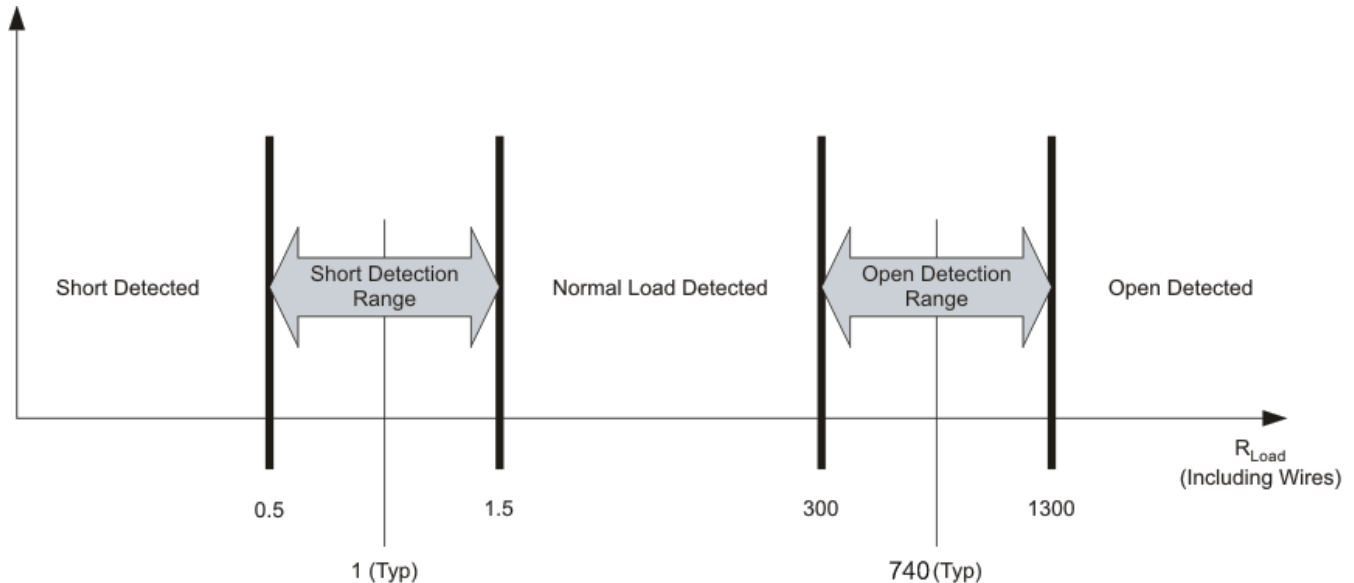

M0067-01

Figure 12. Open and Shorted Load Detection

- 2. Tweeter Detection**—Tweeter detection is an alternate operating mode that is used to determine the proper connection of a frequency dependent load (such as a speaker with a crossover). Tweeter detection is invoked via I²C, and all four channels should be tested individually. Tweeter detection uses the average cycle-by-cycle current limit circuit (see [CBC](#) section) to measure the current delivered to the load. The proper implementation of this diagnostic function is dependent on the amplitude of a user-supplied test signal and on the impedance versus frequency curve of the acoustic load. The system (external to the TAS5414B-Q1 and TAS5424B-Q1) must generate a signal to which the load will respond. The frequency and amplitude of this signal must be calibrated by the user to result in a current draw that is greater than the tweeter detection threshold when the load under test is present, and less than the detection threshold if the load is not properly connected. The current level for the tweeter detection threshold, as well as the maximum current that can safely be delivered to a load when in tweeter detection mode, can be found in the Electrical Characteristics section of the datasheet. The tweeter detection results are reported on the CLIP_OTW pin during the application of the test signal. When tweeter detection is activated (indicating that the tested load is present), pulses on the CLIP_OTW pin begin to toggle. The pulses on the CLIP_OTW pins will report low whenever the current detection threshold is exceeded, and the pin will remain low until the threshold is no longer exceeded. The minimum low-pulse period that can be expected is equal to one period of the switching frequency. Having an input signal that increases the amount of time that the detector is activated (e. g. increasing the amplitude of the input signal) will increase the amount of time for which the pin reports low. **NOTE:** Because tweeter detection is an alternate *operating mode*, the channels to be tested must be placed in Play mode (via register 0x0C) after tweeter detection has been activated in order to commence the detection process. Additionally, the CLIP_OTW pin must be set up via register 0x0A to report the results of tweeter detection.

Protection and Monitoring

- 1. Cycle-By-Cycle Current Limit (CBC)**—The CBC current-limiting circuit terminates each PWM pulse to limit the output current flow when the average current limit (I_{LIM}) threshold is exceeded. The overall effect on the audio in the case of a current overload is quite similar to a voltage-clipping event, where power is temporarily limited at the peaks of the musical signal and normal operation continues without disruption when the overload is removed. The TAS5414B-Q1 and TAS5424B-Q1 do not prematurely shut down in this condition. All four channels continue in play mode and pass signal.
- 2. Overcurrent Shutdown (OCS)**—Under severe short-circuit events, such as a short to PVDD or ground, a peak-current detector is used, and the affected channel shuts down in 200 μ s to 390 μ s if the conditions are severe enough. The shutdown speed depends on a number of factors, such as the impedance of the short circuit, supply voltage, and switching frequency. Only the shorted channels are shut down in such a scenario.

The user may restart the affected channel via I²C. An OCSD event activates the fault pin, and the affected channel(s) are recorded in the I²C fault register. If the supply or ground short is strong enough to exceed the peak current threshold but not severe enough to trigger the OCSD, the peak current limiter prevents excess current from damaging the output FETs, and operation returns to normal after the short is removed.

3. **DC Detect**—This circuit detects a dc offset continuously during normal operation at the output of the amplifier. If the dc offset reaches the level defined in the I²C registers for the specified time period, the circuit triggers. By default a dc detection event does not shut the output down. The shutdown function can be enabled or disabled via I²C. If enabled, the triggered channel shuts down, but the others remain playing and the FAULT pin is asserted. The dc level is defined in I²C registers.
4. **Clip Detect**—The clip detect circuit alerts the user to the presence of a 100% duty-cycle PWM due to a clipped waveform. When this occurs, a signal is passed to the CLIP_OTW pin and it is asserted until the 100% duty-cycle PWM signal is no longer present. All four channels are connected to the same CLIP_OTW pin. Through I²C, the CLIP_OTW signal can be changed to clip-only, OTW-only, or both. A fourth mode, used only during diagnostics, is the option to report tweeter detection events on this pin (see the [Tweeter Detection](#) section). The microcontroller in the system can monitor the signal at the CLIP_OTW pin and may be configured to reduce the volume to all four channels in an active clipping-prevention circuit.
5. **Overtemperature Warning (OTW), Overtemperature Shutdown (OTSD) and Thermal Foldback**—By default, the CLIP_OTW pin is set to indicate an OTW. This can be changed via I²C commands. If selected to indicate a temperature warning, the CLIP_OTW pin is asserted when the die temperature reaches warning level 1 as shown in the electrical specs. The OTW has three temperature thresholds with a 10°C hysteresis. Each threshold is indicated in I²C register 0x04 bits 5, 6, and 7. The device still functions until the temperature reaches the OTSD threshold, at which time the outputs are placed into Hi-Z mode and the FAULT pin is asserted. I²C is still active in the event of an OTSD and the registers can be read for faults, but all audio ceases abruptly. After the OTSD resets the device can be turned back on through I²C. The OTW is still indicated until the temperature drops below warning level 1. The Thermal Foldback decreases the channel gain.
6. **Undervoltage (UV) and Power-on-Reset (POR)**—The undervoltage (UV) protection detects low voltages on PVDD, AVDD, and CP. In the event of an undervoltage, the FAULT pin is asserted and the I²C register is updated, depending on which voltage caused the event. Power-on-reset (POR) occurs when PVDD drops low enough. A POR event causes the I²C to go into a high-impedance state. After the device recovers from the POR event, the device must be re-initialized via I²C.
7. **Overvoltage (OV) and Load Dump**—The OV protection detects high voltages on PVDD. If PVDD reaches the overvoltage threshold, the FAULT pin is asserted and the I²C register is updated. The device can withstand 50-V load-dump voltage spikes. Also depicted in this graph are the voltage thresholds for normal operation region, overvoltage operation region, and load-dump protection region. [Figure 11](#) shows the regions of operating voltage and the profile of the load dump event.

Power Supply

The power for the device is most commonly provided by a car battery that can have a large voltage range. PVDD is a filtered battery voltage, and it is the supply for the output FETs and the low-side FET gate driver. The high-side FET gate driver is supplied by a charge pump (CP) supply. The charge pump supplies the gate drive voltage for all four channels. The analog circuitry is powered by AVDD, which is provided by an internal linear regulator. A 0.1µF/10V external bypass capacitor is needed at the A_BYP pin for this supply. It is recommended that no external components except the bypass capacitor be attached to this pin. The digital circuitry is powered by DVDD, which is provided by an internal linear regulator. A 0.1µF/10V external bypass capacitor is needed at the D_BYP pin. It is recommended that no external components except the bypass capacitor be attached to this pin.

The TAS5414B-Q1 and TAS5424B-Q1 can withstand fortuitous open ground and power conditions. Fortuitous open ground usually occurs when a speaker wire is shorted to ground, allowing for a second ground path through the body diode in the output FETs. The diagnostic capability allows the speakers and speaker wires to be debugged, eliminating the need to remove the amplifier to diagnose the problem.

I²C Serial Communication Bus

The device communicates with the system processor via the I²C serial communication bus as an I²C slave-only device. The processor can poll the device via I²C to determine the operating status. All fault conditions and detections are reported via I²C. There are also numerous features and operating conditions that can be set via I²C.

The I²C bus allows control of the following configurations:

- Independent gain control of each channel. The gain can be set to 12 dB, 20 dB, 26 dB, and 32 dB.
- Select AM non-interference switching frequency
- Select the function of OTW_CLIP pin
- Enable or disable dc detect function with selectable threshold
- Place channel in Hi-Z (switching stopped) mode (mute)
- Select tweeter detect, set detect threshold and initiate function
- Initiate open/short load diagnostic
- Reset faults and return to normal switching operation from Hi-Z mode (unmute)

In addition to the standard SDA and SCL pins for the I²C bus, the TAS5414B-Q1 and the TAS5424B-Q1 include a single pin that allows up to four devices to work together in a system with no additional hardware required for communication or synchronization. The I2C_ADDR pin sets the device in master or slave mode and selects the I²C address for that device. Tie I2C_ADDR to DGND for master, to 1.2 Vdc for slave 1, to 2.4 Vdc for slave 2, and to D_BYP for slave 3. The OSC_SYNC pin is used to synchronize the internal clock oscillators and thereby avoid beat frequencies. An external oscillator can also be applied to this pin for external control of the switching frequency.

Table 2. Table 7. I2C_ADDR Pin Connection

DESCRIPTION	I2C_ADDR PIN CONNECTION	I ² C ADDRESS
TAS5414B-Q1/5424 0 (OSC MASTER)	To SGND pin	0xD8/D9
TAS5414B-Q1/5424 1 (OSC SLAVE1)	35% DVDD (resistive voltage divider between D_BYP pin and SGND pin) ⁽¹⁾	0xDA/DB
TAS5414B-Q1/5424 2 (OSC SLAVE2)	65% DVDD (resistive voltage divider between D_BYP pin and SGND pin) ⁽¹⁾	0xDC/DD
TAS5414B-Q1/5424 3 (OSC SLAVE3)	To D_BYP pin	0xDE/DF

(1) R_{I2C_ADDR} with 5% or better tolerance is recommended.

I²C Bus Protocol

The TAS5414B-Q1 and TAS5424B-Q1 have a bidirectional serial control interface that is compatible with the Inter IC (I²C) bus protocol and supports 400-kbps data transfer rates for random and sequential write and read operations. This is a slave-only device that does not support a multimaster bus environment or wait state insertion. The control interface is used to program the registers of the device and to read device status.

The I²C bus employs two signals, SDA (data) and SCL (clock), to communicate between integrated circuits in a system. Data is transferred on the bus serially, one bit at a time. The address and data are transferred in byte (8-bit) format with the most-significant bit (MSB) transferred first. In addition, each byte transferred on the bus is acknowledged by the receiving device with an acknowledge bit. Each transfer operation begins with the master device driving a start condition on the bus and ends with the master device driving a stop condition on the bus. The bus uses transitions on the data terminal (SDA) while the clock is HIGH to indicate a start and stop conditions. A HIGH-to-LOW transition on SDA indicates a start, and a LOW-to-HIGH transition indicates a stop. Normal data bit transitions must occur within the low time of the clock period. These conditions are shown in [Figure 13](#). The master generates the 7-bit slave address and the read/write (R/W) bit to open communication with another device and then wait for an acknowledge condition. The TAS5414B-Q1 and TAS5424B-Q1 hold SDA LOW during the acknowledge-clock period to indicate an acknowledgment. When this occurs, the master

transmits the next byte of the sequence. Each device is addressed by a unique 7-bit slave address plus R/W bit (1 byte). All compatible devices share the same signals via a bidirectional bus using a wired-AND connection. An external pullup resistor must be used for the SDA and SCL signals to set the HIGH level for the bus. There is no limit on the number of bytes that can be transmitted between start and stop conditions. When the last word transfers, the master generates a stop condition to release the bus.

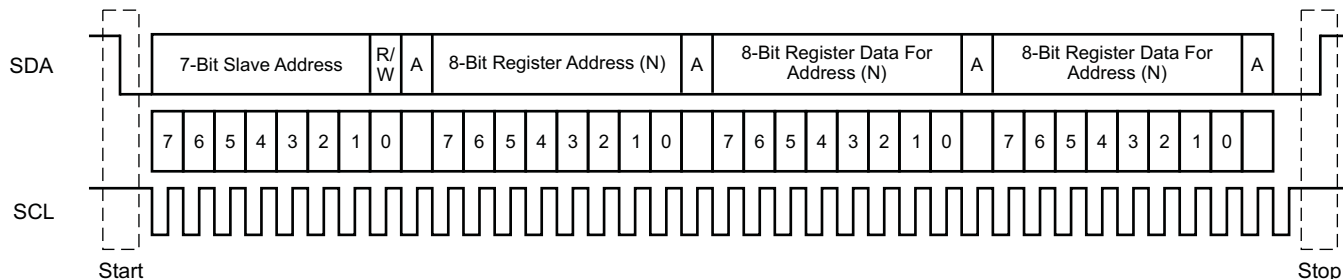

T0035-01

Figure 13. Typical I²C Sequence

Use the I2C_ADDR pin (pin 2) to program the device for one of four addresses. These four addresses are licensed I²C addresses and do not conflict with other licensed I²C audio devices. To communicate with the TAS5414B-Q1 and the TAS5424B-Q1, the I²C master uses addresses shown in Figure 13. Read and write data can be transmitted using single-byte or multiple-byte data transfers.

Random Write

As shown in Figure 14, a single-byte data-write transfer begins with the master device transmitting a start condition followed by the I²C device address and the read/write bit. The read/write bit determines the direction of the data transfer. For a write data transfer, the read/write bit is a 0. After receiving the correct I²C device address and the read/write bit, the TAS5414B-Q1 or TAS5424B-Q1 device responds with an acknowledge bit. Next, the master transmits the address byte or bytes corresponding to the internal memory address being accessed. After receiving the address byte, the TAS5414B-Q1 or TAS5424B-Q1 again responds with an acknowledge bit. Next, the master device transmits the data byte to be written to the memory address being accessed. After receiving the data byte, the TAS5414B-Q1 or TAS5424B-Q1 again responds with an acknowledge bit. Finally, the master transmits a stop condition to complete the single-byte data-write transfer.

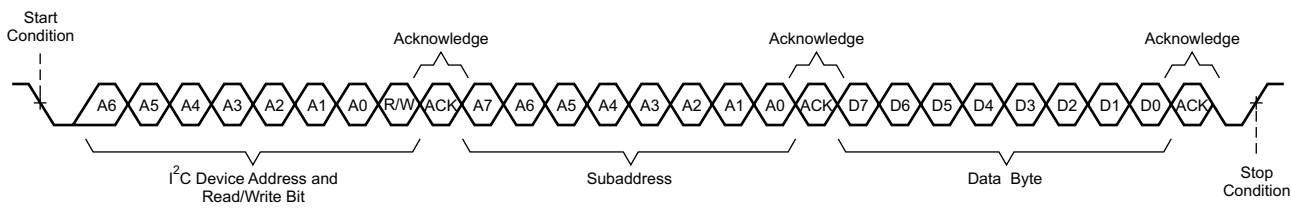

T0036-01

Figure 14. Random Write Transfer

Sequential Write

A sequential data-write transfer is identical to a single-byte data-write transfer except that multiple data bytes are transmitted by the master device to TAS5414B-Q1 or TAS5424B-Q1 as shown in Figure 14. After receiving each data byte, the TAS5414B-Q1 or TAS5424B-Q1 responds with an acknowledge bit and the I²C subaddress is automatically incremented by one.

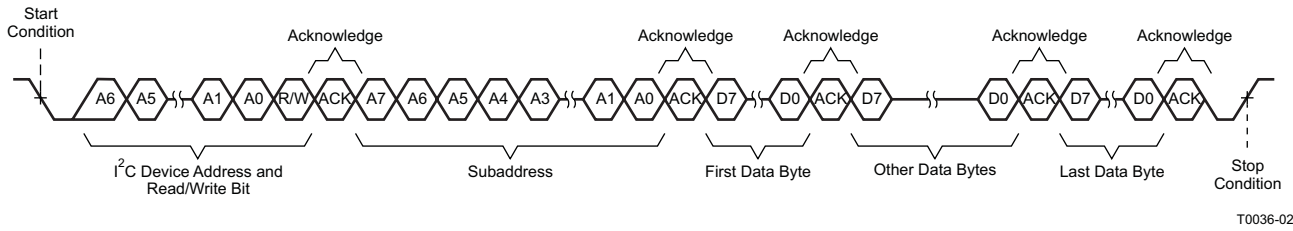

Figure 15. Sequential Write Transfer

Random Read

As shown in Figure 16, a single-byte data-read transfer begins with the master device transmitting a start condition followed by the I²C device address and the read/write bit. For the data-read transfer, both a write followed by a read are actually done. Initially, a write is done to transfer the address byte or bytes of the internal memory address to be read. As a result, the read/write bit is a 0. After receiving the address and the read/write bit, the TAS5414B-Q1 or TAS5424B-Q1 responds with an acknowledge bit. In addition, after sending the internal memory address byte or bytes, the master device transmits another start condition followed by the TAS5414B-Q1 or TAS5424B-Q1 address and the read/write bit again. This time the read/write bit is a 1, indicating a read transfer. After receiving the address and the read/write bit, the TAS5414B-Q1 or TAS5424B-Q1 again responds with an acknowledge bit. Next, the TAS5414B-Q1 or TAS5424B-Q1 transmits the data byte from the memory address being read. After receiving the data byte, the master device transmits a not-acknowledge followed by a stop condition to complete the single-byte data-read transfer.

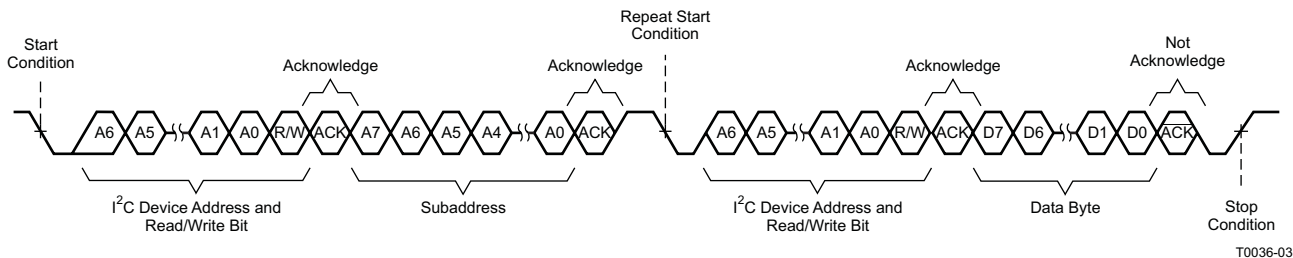

Figure 16. Random Read Transfer

Sequential Read

A sequential data-read transfer is identical to a single-byte data-read transfer except that multiple data bytes are transmitted by the TAS5414B-Q1 or TAS5424B-Q1 to the master device as shown in Figure 17. Except for the last data byte, the master device responds with an acknowledge bit after receiving each data byte and automatically increments the I²C subaddress by one. After receiving the last data byte, the master device transmits a not-acknowledge followed by a stop condition to complete the transfer.

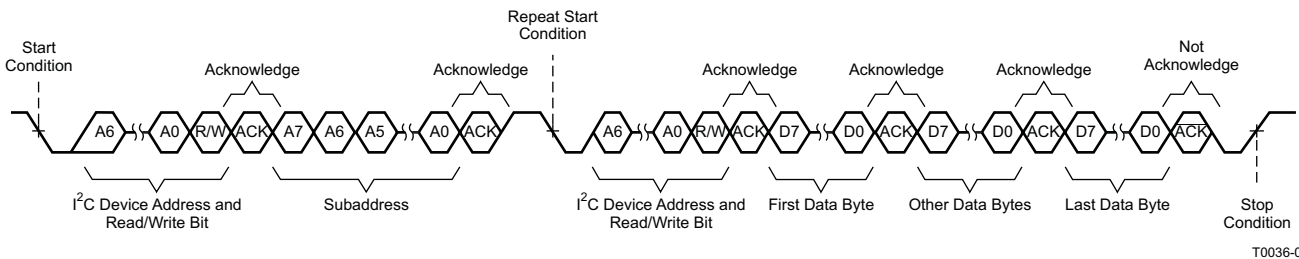

Figure 17. Sequential Read Transfer

Table 3. TAS5414B-Q1/5424 I²C Addresses

DESCRIPTION		FIXED ADDRESS					SELECTABLE WITH ADDRESS PIN		READ/WRITE BIT	I ² C ADDRESS
		MSB	6	5	4	3	2	1	LSB	
TAS5414B-Q1/5424B 0 (OSC MASTER)	I ² C WRITE	1	1	0	1	1	0	0	0	0xD8
	I ² C READ	1	1	0	1	1	0	0	1	0xD9
TAS5414B-Q1/5424B 1 (OSC SLAVE1)	I ² C WRITE	1	1	0	1	1	0	1	0	0xDA
	I ² C READ	1	1	0	1	1	0	1	1	0xDB
TAS5414B-Q1/5424B 2 (OSC SLAVE2)	I ² C WRITE	1	1	0	1	1	1	0	0	0xDC
	I ² C READ	1	1	0	1	1	1	0	1	0xDD
TAS5414B-Q1/5424B 3 (OSC SLAVE3)	I ² C WRITE	1	1	0	1	1	1	1	0	0xDE
	I ² C READ	1	1	0	1	1	1	1	1	0xDF

Table 4. I²C Address Register Definitions

ADDRESS	R/W	REGISTER DESCRIPTION
0x00	R	Latched fault register 1, global and channel fault
0x01	R	Latched fault register 2, dc offset and overcurrent detect
0x02	R	Latched diagnostic register 1, load diagnostics
0x03	R	Latched diagnostic register 2, load diagnostics
0x04	R	External status register 1, temperature and voltage detect
0x05	R	External status register 2, Hi-Z and low-low state
0x06	R	External status register 3, mute and play modes
0x07	R	External status register 4, load diagnostics
0x08	R/W	External control register 1, channel gain select
0x09	R/W	External control register 2, over current control
0x0A	R/W	External control register 3, switching frequency and clip pin select
0x0B	R/W	External control register 4, load diagnostic, master mode select
0x0C	R/W	External control register 5, output state control
0x0D	R/W	External control register 6, output state control
0x0E, 0x0F	-	Not Used
0x10	R/W	External control register 7, DC detect threshold selection
0x13	R	External status register 5, over temperature shutdown and thermal foldback

Table 5. Fault Register 1 (0x00) Protection

D7	D6	D5	D4	D3	D2	D1	D0	FUNCTION
0	0	0	0	0	0	0	0	No protection-created faults, default value
-	-	-	-	-	-	-	1	Overtemperature warning has occurred
-	-	-	-	-	-	1	-	DC offset has occurred in any channel
-	-	-	-	-	1	-	-	Overcurrent shutdown has occurred in any channel
-	-	-	-	1	-	-	-	Overtemperature shutdown has occurred
-	-	-	1	-	-	-	-	Charge pump undervoltage has occurred
-	-	1	-	-	-	-	-	AVDD, analog voltage, undervoltage has occurred
-	1	-	-	-	-	-	-	PVDD undervoltage has occurred
1	-	-	-	-	-	-	-	PVDD overvoltage has occurred

Table 6. Fault Register 2 (0x01) Protection

D7	D6	D5	D4	D3	D2	D1	D0	FUNCTION
0	0	0	0	0	0	0	0	No protection-created faults, default value
-	-	-	-	-	-	-	1	Overcurrent shutdown channel 1 has occurred

Table 6. Fault Register 2 (0x01) Protection (continued)

D7	D6	D5	D4	D3	D2	D1	D0	FUNCTION
–	–	–	–	–	–	1	–	Overcurrent shutdown channel 2 has occurred
–	–	–	–	–	1	–	–	Overcurrent shutdown channel 3 has occurred
–	–	–	–	1	–	–	–	Overcurrent shutdown channel 4 has occurred
–	–	–	1	–	–	–	–	DC offset channel 1 has occurred
–	–	1	–	–	–	–	–	DC offset channel 2 has occurred
–	1	–	–	–	–	–	–	DC offset channel 3 has occurred
1	–	–	–	–	–	–	–	DC offset channel 4 has occurred

Table 7. Diagnostic Register 1 (0x02) Load Diagnostics

D7	D6	D5	D4	D3	D2	D1	D0	FUNCTION
0	0	0	0	0	0	0	0	No load-diagnostic-created faults, default value
–	–	–	–	–	–	–	1	Output short to ground channel 1 has occurred
–	–	–	–	–	–	1	–	Output short to PVDD channel 1 has occurred
–	–	–	–	–	1	–	–	Shorted load channel 1 has occurred
–	–	–	–	1	–	–	–	Open load channel 1 has occurred
–	–	–	1	–	–	–	–	Output short to ground channel 2 has occurred
–	–	1	–	–	–	–	–	Output short to PVDD channel 2 has occurred
–	1	–	–	–	–	–	–	Shorted load channel 2 has occurred
1	–	–	–	–	–	–	–	Open load channel 2 has occurred

Table 8. Diagnostic Register 2 (0x03) Load Diagnostics

D7	D6	D5	D4	D3	D2	D1	D0	FUNCTION
0	0	0	0	0	0	0	0	No load-diagnostic-created faults, default value
–	–	–	–	–	–	–	1	Output short to ground channel 3 has occurred
–	–	–	–	–	–	1	–	Output short to PVDD channel 3 has occurred
–	–	–	–	–	1	–	–	Shorted load channel 3 has occurred
–	–	–	–	1	–	–	–	Open load channel 3 has occurred
–	–	–	1	–	–	–	–	Output short to ground channel 4 has occurred
–	–	1	–	–	–	–	–	Output short to PVDD channel 4 has occurred
–	1	–	–	–	–	–	–	Shorted load channel 4 has occurred
1	–	–	–	–	–	–	–	Open load channel 4 has occurred

Table 9. External Status Register 1 (0x04) Fault Detection

D7	D6	D5	D4	D3	D2	D1	D0	FUNCTION
0	0	0	0	0	0	0	0	No protection-created faults are present, default value
–	–	–	–	–	–	–	1	PVDD overvoltage fault is present
–	–	–	–	–	–	1	–	PVDD undervoltage fault is present
–	–	–	–	–	1	–	–	AVDD, analog voltage fault is present
–	–	–	–	1	–	–	–	Charge-pump voltage fault is present
–	–	–	1	–	–	–	–	Overtemperature shutdown is present
–	–	1	–	–	–	–	–	Overtemperature warning
–	1	1	–	–	–	–	–	Overtemperature warning level 1
1	0	1	–	–	–	–	–	Overtemperature warning level 2
1	1	1	–	–	–	–	–	Overtemperature warning level 3

Table 10. External Status Register 2 (0x05) Output State of Individual Channels

D7	D6	D5	D4	D3	D2	D1	D0	FUNCTION
0	0	0	0	1	1	1	1	Output is in Hi-Z mode, not in low-low mode ⁽¹⁾ , default value
–	–	–	–	–	–	–	0	Channel 1 Hi-Z mode (0 = not Hi-Z, 1 = Hi-Z)
–	–	–	–	–	–	0	–	Channel 2 Hi-Z mode (0 = not Hi-Z, 1 = Hi-Z)
–	–	–	–	–	0	–	–	Channel 3 Hi-Z mode (0 = not Hi-Z, 1 = Hi-Z)
–	–	–	–	0	–	–	–	Channel 4 Hi-Z mode (0 = not Hi-Z, 1 = Hi-Z)
–	–	–	1	–	–	–	–	Channel 1 low-low mode (0 = not low-low, 1 = low-low) ⁽¹⁾
–	–	1	–	–	–	–	–	Channel 2 low-low mode (0 = not low-low, 1 = low-low) ⁽¹⁾
–	1	–	–	–	–	–	–	Channel 3 low-low mode (0 = not low-low, 1 = low-low) ⁽¹⁾
1	–	–	–	–	–	–	–	Channel 4 low-low mode (0 = not low-low, 1 = low-low) ⁽¹⁾

(1) Low-low is defined as both outputs actively pulled to ground.

Table 11. External Status Register 3 (0x06) Play and Mute Modes

D7	D6	D5	D4	D3	D2	D1	D0	FUNCTION
0	0	0	0	0	0	0	0	Mute mode is disabled, play mode disabled, default value, (Hi-Z mode)
–	–	–	–	–	–	–	1	Channel 1 play mode is enabled
–	–	–	–	–	–	1	–	Channel 2 play mode is enabled
–	–	–	–	–	1	–	–	Channel 3 play mode is enabled
–	–	–	–	1	–	–	–	Channel 4 play mode is enabled
–	–	–	1	–	–	–	–	Channel 1 mute mode is enabled
–	–	1	–	–	–	–	–	Channel 2 mute mode is enabled
–	1	–	–	–	–	–	–	Channel 3 mute mode is enabled
1	–	–	–	–	–	–	–	Channel 4 mute mode is enabled

Table 12. External Status Register 4 (0x07) Load Diagnostics

D7	D6	D5	D4	D3	D2	D1	D0	FUNCTION
0	0	0	0	0	0	0	0	No channels are set in load diagnostics mode, default value
–	–	–	–	–	–	–	1	Channel 1 is in load diagnostics mode
–	–	–	–	–	–	1	–	Channel 2 is in load diagnostics mode
–	–	–	–	–	1	–	–	Channel 3 is in load diagnostics mode
–	–	–	–	1	–	–	–	Channel 4 is in load diagnostics mode
–	–	–	1	–	–	–	–	Channel 1 is in Over Temperature Foldback
–	–	1	–	–	–	–	–	Channel 2 is in Over Temperature Foldback
–	1	–	–	–	–	–	–	Channel 3 is in Over Temperature Foldback
1	–	–	–	–	–	–	–	Channel 4 is in Over Temperature Foldback

Table 13. External Control Register 1 (0x08) Gain Select

D7	D6	D5	D4	D3	D2	D1	D0	FUNCTION
1	0	1	0	1	0	1	0	Set gain for all channels to 26 dB, default value
–	–	–	–	–	–	0	0	Set channel 1 gain to 12 dB
–	–	–	–	–	–	0	1	Set channel 1 gain to 20 dB
–	–	–	–	–	–	1	1	Set channel 1 gain to 32 dB
–	–	–	–	0	0	–	–	Set channel 2 gain to 12 dB
–	–	–	–	0	1	–	–	Set channel 2 gain to 20 dB
–	–	–	–	1	1	–	–	Set channel 2 gain to 32 dB
–	–	0	0	–	–	–	–	Set channel 3 gain to 12 dB
–	–	0	1	–	–	–	–	Set channel 3 gain to 20 dB
–	–	1	1	–	–	–	–	Set channel 3 gain to 32 dB

Table 13. External Control Register 1 (0x08) Gain Select (continued)

D7	D6	D5	D4	D3	D2	D1	D0	FUNCTION
0	0	–	–	–	–	–	–	Set channel 4 gain to 12 dB
0	1	–	–	–	–	–	–	Set channel 4 gain to 20 dB
1	1	–	–	–	–	–	–	Set channel 4 gain to 32 dB

Table 14. External Control Register 2(0x09) Over Current Control

D7	D6	D5	D4	D3	D2	D1	D0	FUNCTION
1	1	1	1	0	0	0	0	Current Limit Level 2 for all channels
			0					Set Channel 1 Over Current Limit (0 - level 1, 1 - level 2)
		0						Set Channel 2 Over Current Limit (0 - level 1, 1 - level 2)
	0							Set Channel 3 Over Current Limit (0 - level 1, 1 - level 2)
0								Set Channel 4 Over Current Limit (0 - level 1, 1 - level 2)
				X	X	X	X	Reserved

Table 15. External Control Register 3 (0x0A) Switching Frequency Select and Clip_OTW Configuration

D7	D6	D5	D4	D3	D2	D1	D0	FUNCTION
0	0	0	0	1	1	0	1	Set $f_S = 417$ kHz, report clip and OTW, 45° phase, disable hard stop
–	–	–	–	–	–	0	0	Set $f_S = 500$ kHz
–	–	–	–	–	–	1	0	Set $f_S = 357$ kHz
–	–	–	–	–	–	1	1	Invalid frequency selection (do not set)
–	–	–	–	0	0	–	–	Configure $\overline{\text{CLIP_OTW}}$ pin to report tweeter detect only
–	–	–	–	0	1	–	–	Configure $\overline{\text{CLIP_OTW}}$ pin to report clip detect only
–	–	–	–	1	0	–	–	Configure $\overline{\text{CLIP_OTW}}$ pin to report overtemperature warning only
–	–	–	1	–	–	–	–	Enable hard-stop mode
–	–	1	–	–	–	–	–	Set f_S to a 180° phase difference between adjacent channels
–	1	–	–	–	–	–	–	Send Sync Pulse from OSC_SYNC pin (Device must be in master mode)
X	–	–	–	–	–	–	–	Reserved

Table 16. External Control Register 4 (0x0B) Load Diagnostics and Master/Slave Control

D7	D6	D5	D4	D3	D2	D1	D0	FUNCTION
0	1	0	1	0	0	0	0	Clock output disabled, Master clock mode, DC Detection Enabled, Load diagnostics disabled
–	–	–	–	–	–	–	1	Run channel 1 load diagnostics
–	–	–	–	–	–	1	–	Run channel 2 load diagnostics
–	–	–	–	–	1	–	–	Run channel 3 load diagnostics
–	–	–	–	1	–	–	–	Run channel 4 load diagnostics
–	–	–	0	–	–	–	–	Disable dc detection on all channels
–	–	1	–	–	–	–	–	Enable tweeter-detect mode
–	0	–	–	–	–	–	–	Enable slave mode (external oscillator must be provided)
1	–	–	–	–	–	–	–	Enable clock output on OSC_SYNC pin (valid only in master mode)

Table 17. External Control Register 5 (0x0C) Output Control

D7	D6	D5	D4	D3	D2	D1	D0	FUNCTION
0	0	0	1	1	1	1	1	All channels, Hi-Z, mute, reset disabled
–	–	–	–	–	–	–	0	Set channel 1 to mute mode, non-Hi-Z
–	–	–	–	–	–	0	–	Set channel 2 to mute mode, non-Hi-Z
–	–	–	–	–	0	–	–	Set channel 3 to mute mode, non-Hi-Z
–	–	–	–	0	–	–	–	Set channel 4 to mute mode, non-Hi-Z

Table 17. External Control Register 5 (0x0C) Output Control (continued)

D7	D6	D5	D4	D3	D2	D1	D0	FUNCTION
–	–	–	0	–	–	–	–	Set non-Hi-Z channels to play mode, (unmute)
–	1	1	–	–	–	–	–	Reserved
1	–	–	–	–	–	–	–	Reset device

Table 18. External Control Register 6 (0x0D) Output Control

D7	D6	D5	D4	D3	D2	D1	D0	FUNCTION
0	0	0	0	0	0	0	0	Low-low state disabled all channels
–	–	–	–	–	–	–	1	Set channel 1 to low-low state
–	–	–	–	–	–	1	–	Set channel 2 to low-low state
–	–	–	–	–	1	–	–	Set channel 3 to low-low state
–	–	–	–	1	–	–	–	Set channel 4 to low-low state
X	X	X	X	–	–	–	–	Reserved

Table 19. External Control Register 7 (0x10) Miscellaneous Selection

D7	D6	D5	D4	D3	D2	D1	D0	FUNCTION
0	0	0	0	0	0	0	1	Normal speed CM ramp, normal S2P & S2G timing, no delay between LDG phases, Crosstalk Enhancement Disabled, Default DC detect value (1.6V)
–	–	–	–	–	–	0	0	Minimum DC detect value (0.8V)
–	–	–	–	–	–	1	0	Maximum DC detect value (2.4V)
–	–	–	–	–	1	–	–	Enable Crosstalk Enhancement
–	–	–	–	1	–	–	–	Adds a 20mS delay between load diagnostic phases
–	–	–	1	–	–	–	–	Short-to-Power (S2P) and Short-to-Ground (S2G) Load Diagnostic phases take 4x longer
1	–	–	–	–	–	–	–	Slower common mode (CM) ramp down from Mute mode
–	X	X	–	–	–	–	–	Reserved

Table 20. External Status Register 5 (0x13) Over Temperature and Thermal Foldback Status

D7	D6	D5	D4	D3	D2	D1	D0	FUNCTION
0	0	0	0	0	0	0	0	Default Over temperature foldback status, no channel is in foldback
0	0	0	0	0	0	0	1	Channel 1 in thermal foldback
0	0	0	0	0	0	1	0	Channel 2 in thermal foldback
0	0	0	0	0	1	0	0	Channel 3 in thermal foldback
0	0	0	0	1	0	0	0	Channel 4 in thermal foldback
0	0	0	1	0	0	0	0	Channel 1 in Over temperature shutdown
0	0	1	0	0	0	0	0	Channel 2 in Over temperature shutdown
0	1	0	0	0	0	0	0	Channel 3 in Over temperature shutdown
1	0	0	0	0	0	0	0	Channel 4 in Over temperature shutdown

Hardware Control Pins

There are four discrete hardware pins for real-time control and indication of device status.

$\overline{\text{FAULT}}$ pin: This active-low open-drain output pin indicates the presence of a fault condition that requires the device to go into the Hi-Z mode or standby mode. When this pin is asserted, the device has protected itself and the system from potential damage. The exact nature of the fault can be read via I²C with the exception of PVDD under-voltage faults below POR in which case the I²C bus is no longer operational. However, the fault is still indicated due to the fact that the $\overline{\text{FAULT}}$ pin is asserted.

CLIP_OTW pin: This active-low open-drain pin is configured via I²C to indicate one of the following conditions: overtemperature warning, the detection of clipping, or the logical OR of both of these conditions. During tweeter detect diagnostics, this pin also is asserted when a tweeter is present.

MUTE pin: This active-low pin is used for hardware control of the mute/unmute function for all four channels. Capacitor C_{MUTE} is used to control the time constant for the gain ramp needed to produce a pop- and click-free mute function. For pop- and click-free operation, the mute function should be implemented through I²C commands. The use of a hard mute with an external transistor does not ensure pop- and click-free operation, and is not recommended unless an *emergency hard mute* function is required in case of a loss of I²C control. The C_{MUTE} capacitor may not be shared between multiple devices.

STANDBY pin: When this active-low pin is asserted, the device goes into a complete shutdown, and current draw is limited to 2 μA, typical. It can be used to shut down the device rapidly. If all channels are in Hi-Z the device will enter standby in ~1mS and if not a quick ramp down will occur that takes ~20mS. The outputs are ramped down quickly if not already in Hi-Z so externally biasing the **MUTE** pin will prevent the device from entering standby. All I²C register content is lost when this pin is asserted. The I²C bus goes into the high-impedance state when the **STANDBY** pin is asserted.

EMI Considerations

Automotive level EMI performance depends on both careful integrated circuit design and good system level design. Controlling sources of electromagnetic interference (EMI) was a major consideration in all aspects of the design.

The design has minimal parasitic inductances due to the short leads on the package. This dramatically reduces the EMI that results from current passing from the die to the system PCB. Each channel also operates at a different phase. The phase between channels is I²C selectable to either 45° or 180°, to reduce EMI caused by high-current switching. The design also incorporates circuitry that optimizes output transitions that cause EMI.

AM Radio Avoidance

To reduce interference in the AM radio band, the device has the ability to change the switching frequency via I²C commands. The recommended frequencies are listed in Table 21. The fundamental frequency and its second harmonic straddle the AM radio band listed. This eliminates the tones that can be present due to the switching frequency being demodulated by the AM radio.

Table 21. Recommended Switching Frequencies for AM Mode Operation

US		EUROPEAN	
AM FREQUENCY (kHz)	SWITCHING FREQUENCY (kHz)	AM FREQUENCY (kHz)	SWITCHING FREQUENCY (kHz)
540 - 670	417	522 - 675	417
680 - 980	500	676 - 945	500
990 - 1180	417	946 - 1188	417
1190 - 1420	500	1189 - 1422	500
1430 - 1580	417	1423 - 1584	417
1590 - 1700	500	1585 - 1701	500

Operating Modes and Faults

The operating modes and faults are depicted in the following tables.

Table 22. Operating Modes

STATE NAME	OUTPUT FETS	CHARGE PUMP	OSCILLATOR	I ² C	AVDD and DVDD
STANDBY	Hi-Z, floating	Stopped	Stopped	Stopped	OFF
Hi-Z	Hi-Z, weak pulldown	Active	Active	Active	ON
Mute	Switching at 50%	Active	Active	Active	ON

Table 22. Operating Modes (continued)

STATE NAME	OUTPUT FETS	CHARGE PUMP	OSCILLATOR	I ² C	AVDD and DVDD
Normal operation	Switching with audio	Active	Active	Active	ON

Table 23. Global Faults and Actions

FAULT/ EVENT	FAULT/EVENT CATEGORY	MONITORING MODES	REPORTING METHOD	ACTION TYPE	ACTION RESULT	LATCHED/ SELF- CLEARING
POR	Voltage fault	All	$\overline{\text{FAULT}}$ pin	Hard mute (no ramp)	Standby	Self-clearing
UV		Hi-Z, mute, normal	I ² C + $\overline{\text{FAULT}}$ pin		Hi-Z	Latched
CP UV					Standby	Self-clearing
OV		All	$\overline{\text{FAULT}}$ pin			
Load dump						
OTW	Thermal warning	Hi-Z, mute, normal	I ² C + $\overline{\text{CLIP_OTW}}$ pin	None	None	Self-clearing
OTSD	Thermal fault	Hi-Z, mute, normal	I ² C + $\overline{\text{FAULT}}$ pin	Hard mute (no ramp)	Standby	Latched

Table 24. Channel Faults and Actions

FAULT/ EVENT	FAULT/EVENT CATEGORY	MONITORING MODES	REPORTING METHOD	ACTION TYPE	ACTION RESULT	LATCHED/ SELF- CLEARING
Open/short diagnostic	Diagnostic	Hi-Z (I ² C activated)	I ² C	None	None	Latched
Clipping	Warning	Mute / Play	$\overline{\text{CLIP_OTW}}$ pin	None	None	Self-clearing
CBC load current limit	Online protection			Current Limit	Start OC timer	Self-clearing
OC fault	Output channel fault		I ² C + $\overline{\text{FAULT}}$ pin	Hard mute	Hi-Z	Latched
DC detect				Hard mute	Hi-Z	Latched
OT Foldback	Warning		I ² C + $\overline{\text{CLIP_OTW}}$ pin	Reduce Gain	None	Self-clearing

Audio Shutdown and Restart Sequence

The gain ramp of the filtered output signal and the updating of the I²C registers correspond to the MUTE pin voltage during the ramping process. The length of time that the MUTE pin takes to complete its ramp is dictated by the value of the external capacitor on the MUTE pin. With the default 220nF capacitor the turn-on common mode ramp takes ~26mS and the gain ramp takes ~76mS.

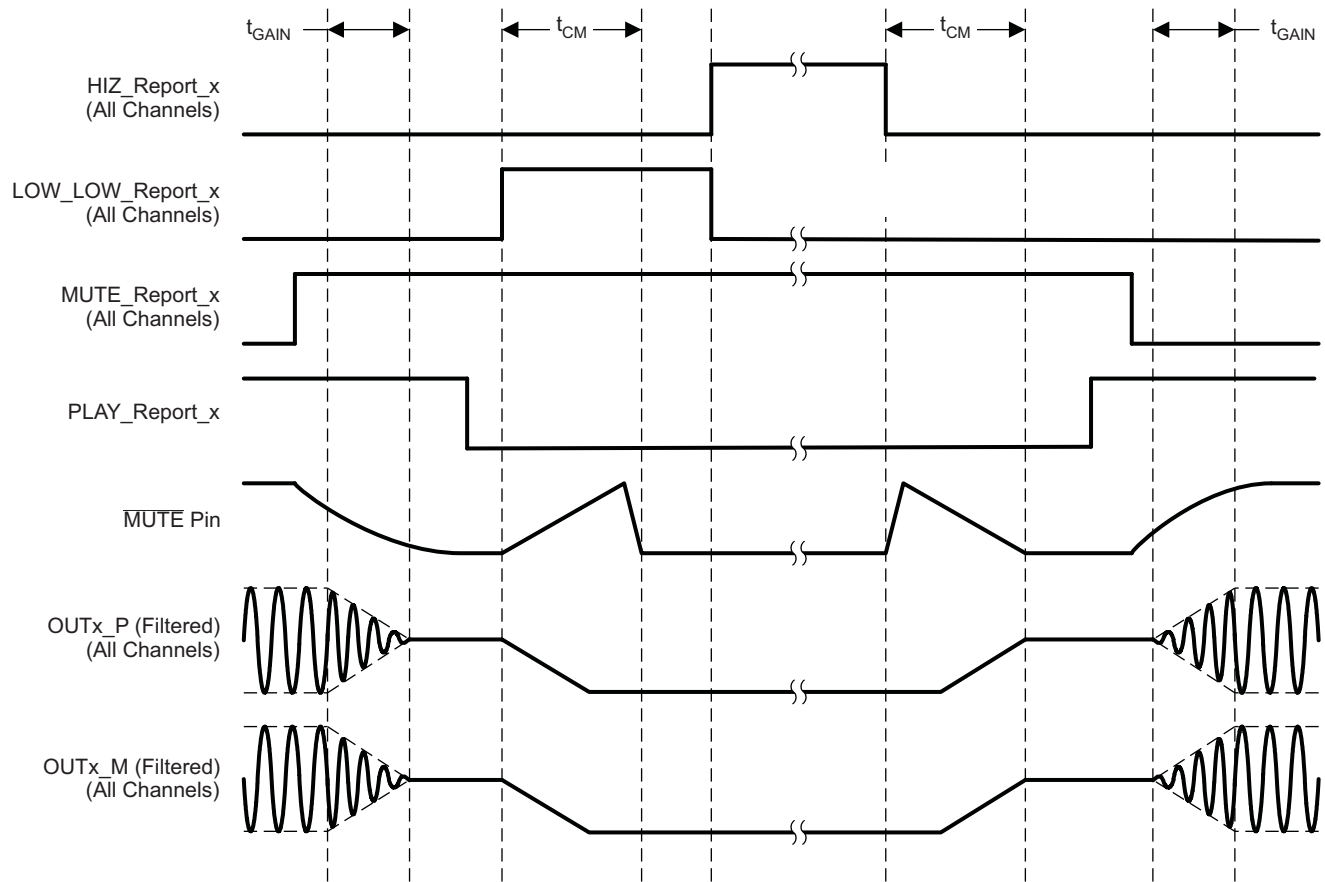

T0192-02

Figure 18. Click- and Pop-Free Shutdown and Restart Sequence Timing Diagram

Latched Fault Shutdown and Restart Sequence Control

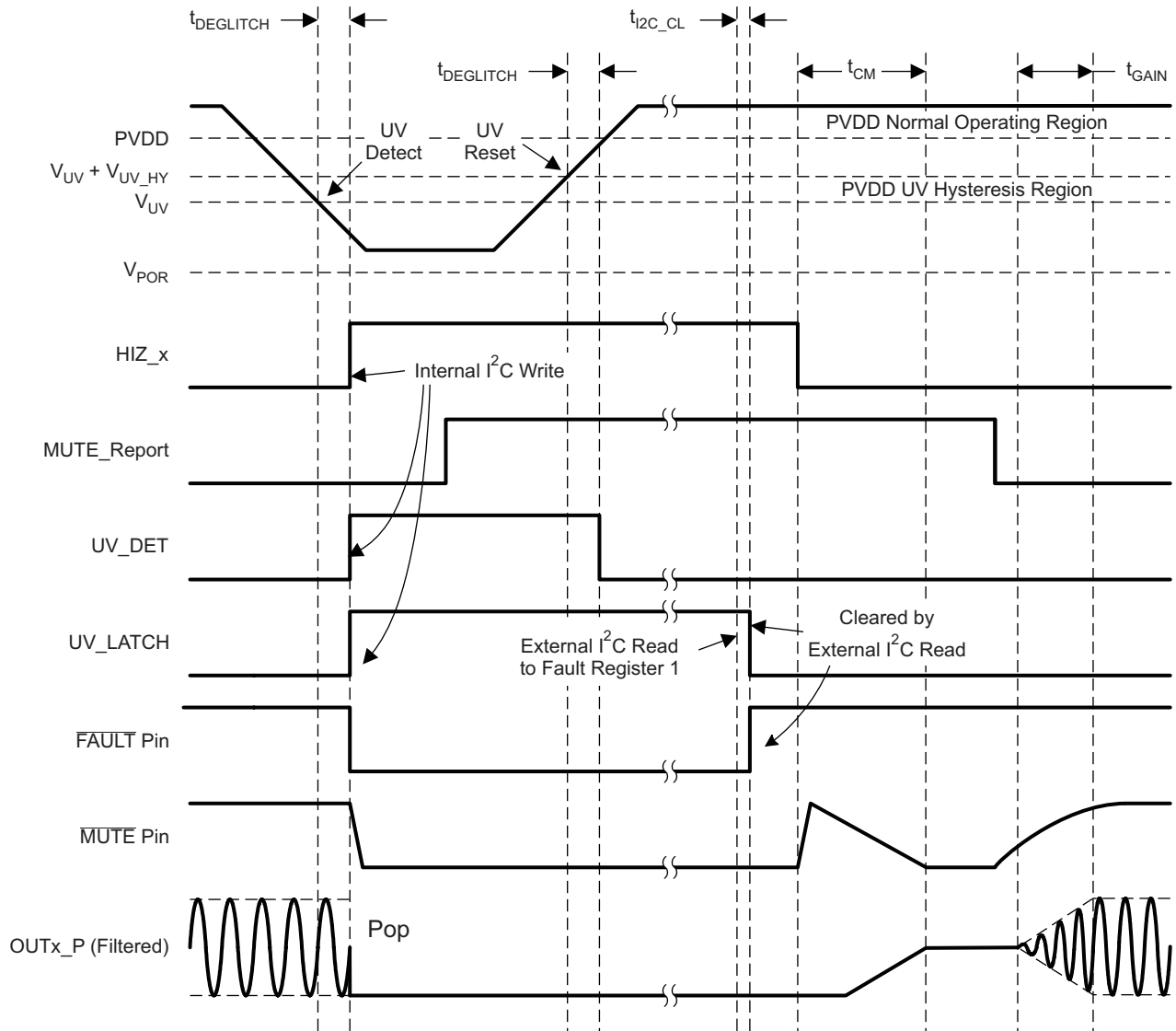

T0194-02

Figure 19. Latched Global Fault Shutdown and Restart Timing Diagram (UV Shutdown and Recovery)

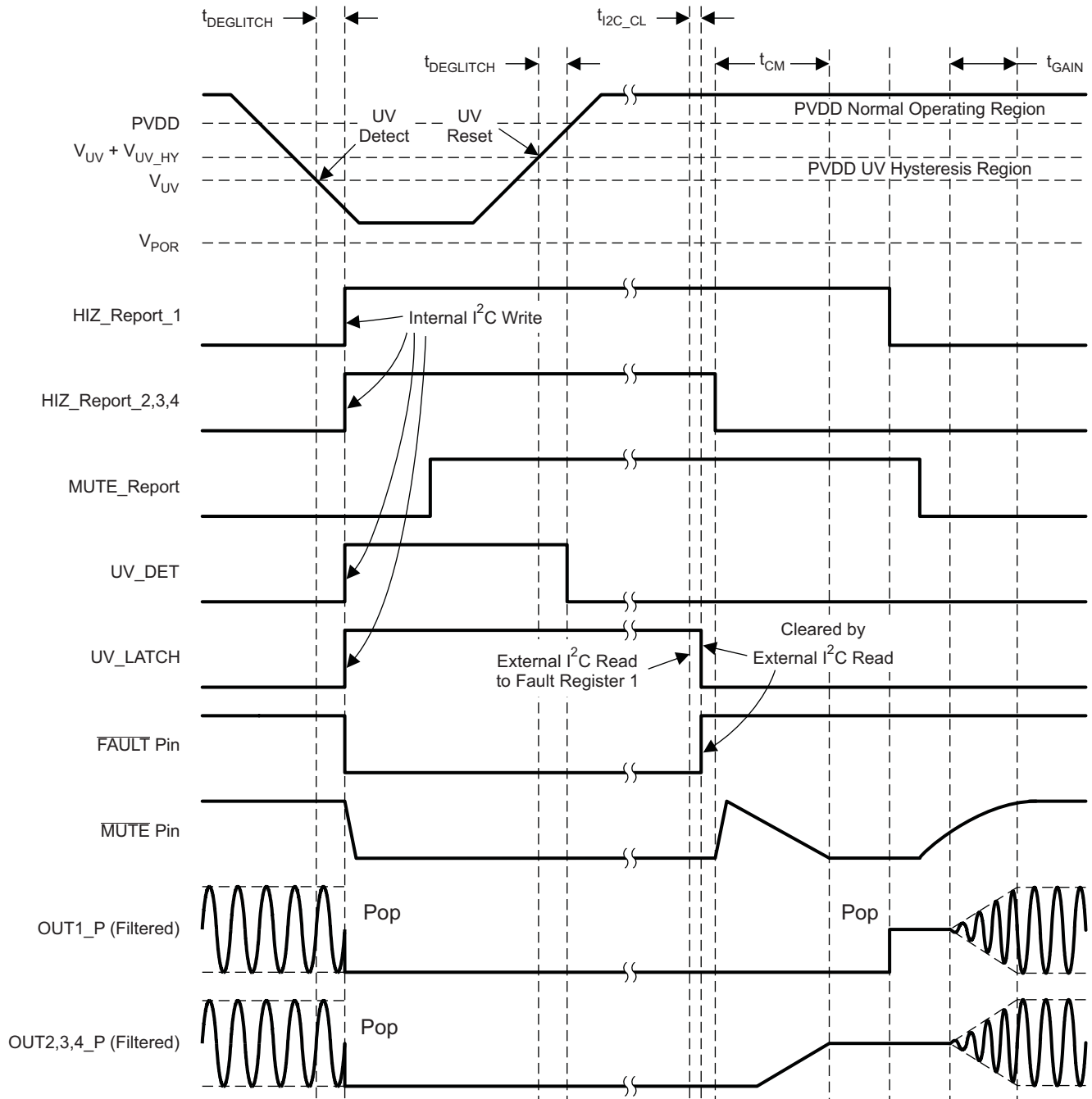

T0195-02

Figure 20. Latched Global Fault Shutdown and Individual Channel Restart Timing Diagram (UV Shutdown and Recovery)

APPLICATION INFORMATION

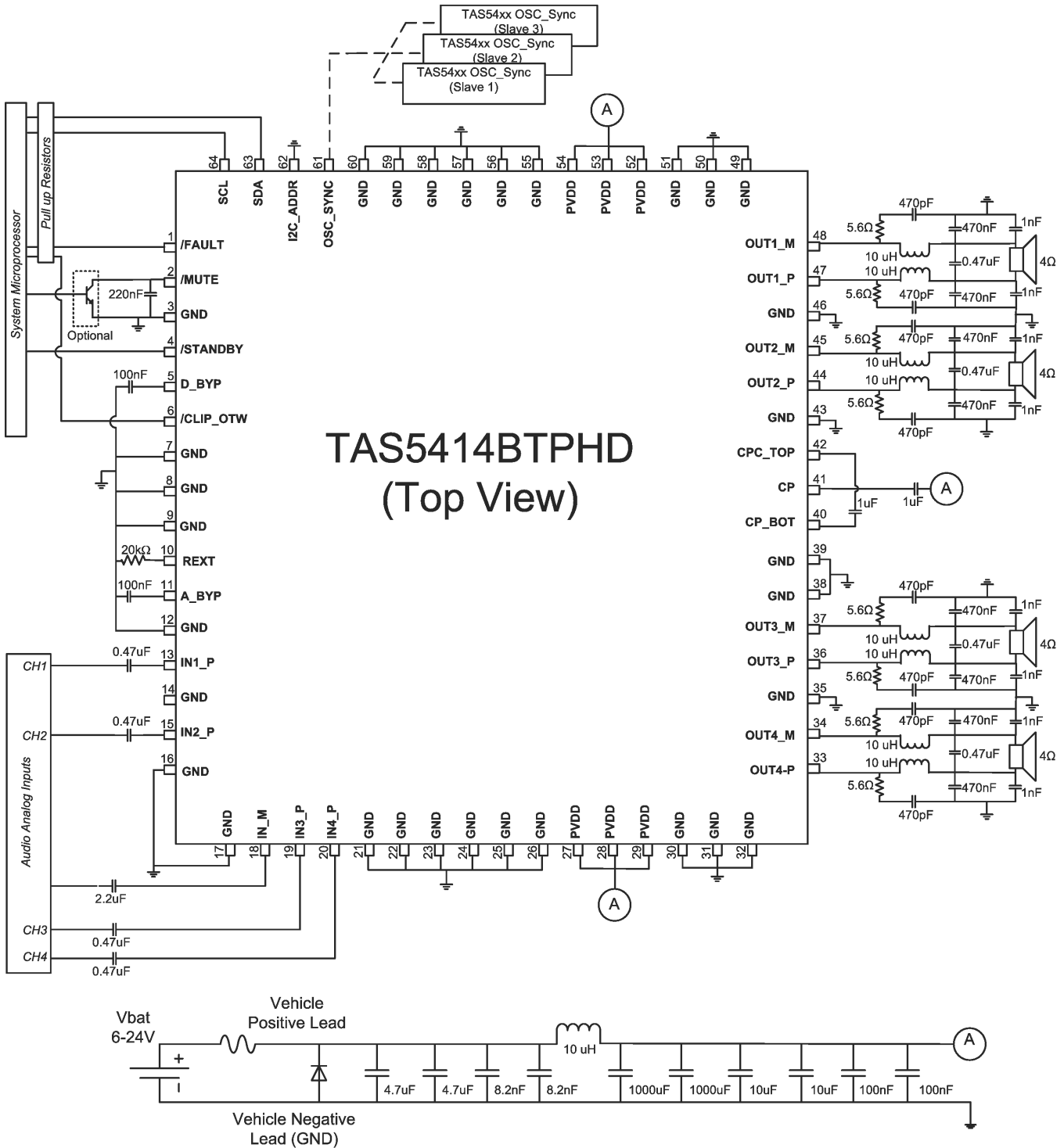

Figure 21. TAS5414B-Q1 Typical Application Schematic

Parallel Operation (PBTL)

The device can drive more current paralleling BTL channels on the load side of the LC output filter. For parallel operation, identical I²C settings are required for any two paralleled channels in order to have reliable system

performance and even power dissipation on multiple channels. For smooth power up, power down, and mute operation, the same control commands (such as mute, play, Hi-Z, etc.) should be sent to the paralleled channels at the same time. Load diagnostic is also supported for parallel connection. Paralleling on the device side of the LC output filter is not supported, and can result in device failure. When paralleling channels it is important to monitor channels for thermal foldback and lower the system gain for paralleled channels.

Input Filter Design

For the TAS5424B-Q1 device, the input filter for a single channel's P and M inputs should be identical. For the TAS5414B-Q1 the IN_M pin should have an impedance to GND that is equivalent to the parallel combination of the input impedances of all IN_P channels combined, including any source impedance from the previous stage in the system design. For example, if each of the 4 IN_P channels have a 1uF DC blocking capacitor, 1kΩ of series resistance due to an input RC filter, and 1kΩ of source resistance from the DAC supplying the audio signal, then the IN_M channel should have a 4uF capacitor in series with a 500Ω resistor to GND (4 x 1uF in parallel = 4uF; 4 x 2kΩ in parallel = 500Ω).

Demodulation Filter Design

The amplifier outputs are driven by high-current LDMOS transistors in an H-bridge configuration. These transistors are either fully off or on. The result is a square-wave output signal with a duty cycle that is proportional to the amplitude of the audio signal. It is recommended that a second-order LC filter be used to recover the audio signal. The main purpose of the demodulation filter is to attenuate the high-frequency components of the output signals that are out of the audio band. Design of the demodulation filter significantly affects the audio performance of the power amplifier. Therefore, to meet the system THD+N needs, the selection of the inductors used in the output filter should be carefully considered. The rule is that the inductance should stay above 10% of the inductance value within the range of peak current seen at maximum output power in the system design.

Line Driver Applications

In many automotive audio applications the end user would like to use the same head unit to drive either a speaker (with several Ohms of impedance) or an external amplifier (with several kOhms of impedance). The design is capable of supporting both applications; however, the output filter and system must be designed to handle the expected output load conditions.

Thermal Information

The thermally augmented package is designed to interface directly to heat sinks using a thermal interface compound (for example, Artic Silver, Ceramique thermal compound.) The heat sink then absorbs heat from the ICs and couples it to the local air. If louvers or fans are supplied, this process can reach equilibrium and heat can be continually removed from the ICs. Because of the device efficiency heat sinks can be smaller than those required for linear amplifiers of equivalent performance.

$R_{\theta JA}$ is a system thermal resistance from junction to ambient air. As such, it is a system parameter with the following components:

- $R_{\theta JC}$ (the thermal resistance from junction to case, or in this case the heat slug)
- Thermal grease thermal resistance
- Heat sink thermal resistance

The thermal grease thermal resistance can be calculated from the exposed heat slug area and the thermal grease manufacturer's area thermal resistance (expressed in °C-in²/W or °C-mm²/W). The area thermal resistance of the example thermal grease with a 0.001-inch (0.0254-mm) thick layer is about 0.007°C-in²/W (4.52°C-mm²/W). The approximate exposed heat slug size is as follows:

36/44-pin PSOP3	0.124 in ² (80 mm ²)
64-pin QFP	0.099 in ² (64 mm ²)

Dividing the example thermal grease area resistance by the area of the heat slug gives the actual resistance through the thermal grease for both parts:

36/44-pin PSOP3	0.06°C/W
64-pin QFP	0.07°C/W

The thermal resistance of thermal pads is generally considerably higher than a thin thermal grease layer. Thermal tape has an even higher thermal resistance and should not be used at all. Heat sink thermal resistance generally is predicted by the heat sink vendor, modeled using a continuous flow dynamics (CFD) model, or measured.

Thus, for a single monaural channel in the IC, the system $R_{\theta JA} = R_{\theta JC} + \text{thermal grease resistance} + \text{heat sink resistance}$.

The following table indicates modeled parameters for one device on a heat sink. The junction temperature is set at 115°C while delivering 20 Wrms per channel into 4-Ω loads with no clipping. It is assumed that the thermal grease is about 0.001 inches (0.0254 mm) thick.

Device	36-Pin PSOP3
Ambient temperature	25°C
Power to load	20 W × 4
Power dissipation	1.90 W × 4
ΔT inside package	7.6°C
ΔT through thermal grease	0.46°C
Required heatsink thermal resistance	10.78°C/W
Junction temperature	115°C
System $R_{\theta JA}$	11.85°C/W
$R_{\theta JA} \times \text{power dissipation}$	90°C

Electrical Connection of Heat Slug and Heat Sink

The heat sink connected to the heat slug of the device should be connected to GND or left floating. The heat slug should not be connected to any other electrical node.

PACKAGING INFORMATION

Orderable Device	Status (1)	Package Type	Package Drawing	Pins	Package Qty	Eco Plan (2)	Lead finish/ Ball material (6)	MSL Peak Temp (3)	Op Temp (°C)	Device Marking (4/5)	Samples
TAS5414BTPHDQ1	ACTIVE	HTQFP	PHD	64	90	RoHS & Green	NIPDAU	Level-3-260C-168 HR	-40 to 105	TAS5414BTQ1	Samples
TAS5414BTPHDRQ1	ACTIVE	HTQFP	PHD	64	1000	RoHS & Green	NIPDAU	Level-3-260C-168 HR	-40 to 105	TAS5414BTQ1	Samples

(1) The marketing status values are defined as follows:

ACTIVE: Product device recommended for new designs.

LIFEBUY: TI has announced that the device will be discontinued, and a lifetime-buy period is in effect.

NRND: Not recommended for new designs. Device is in production to support existing customers, but TI does not recommend using this part in a new design.

PREVIEW: Device has been announced but is not in production. Samples may or may not be available.

OBSOLETE: TI has discontinued the production of the device.

(2) **RoHS:** TI defines "RoHS" to mean semiconductor products that are compliant with the current EU RoHS requirements for all 10 RoHS substances, including the requirement that RoHS substance do not exceed 0.1% by weight in homogeneous materials. Where designed to be soldered at high temperatures, "RoHS" products are suitable for use in specified lead-free processes. TI may reference these types of products as "Pb-Free".

RoHS Exempt: TI defines "RoHS Exempt" to mean products that contain lead but are compliant with EU RoHS pursuant to a specific EU RoHS exemption.

Green: TI defines "Green" to mean the content of Chlorine (Cl) and Bromine (Br) based flame retardants meet JS709B low halogen requirements of <=1000ppm threshold. Antimony trioxide based flame retardants must also meet the <=1000ppm threshold requirement.

(3) MSL, Peak Temp. - The Moisture Sensitivity Level rating according to the JEDEC industry standard classifications, and peak solder temperature.

(4) There may be additional marking, which relates to the logo, the lot trace code information, or the environmental category on the device.

(5) Multiple Device Markings will be inside parentheses. Only one Device Marking contained in parentheses and separated by a "~" will appear on a device. If a line is indented then it is a continuation of the previous line and the two combined represent the entire Device Marking for that device.

(6) Lead finish/Ball material - Orderable Devices may have multiple material finish options. Finish options are separated by a vertical ruled line. Lead finish/Ball material values may wrap to two lines if the finish value exceeds the maximum column width.

Important Information and Disclaimer:The information provided on this page represents TI's knowledge and belief as of the date that it is provided. TI bases its knowledge and belief on information provided by third parties, and makes no representation or warranty as to the accuracy of such information. Efforts are underway to better integrate information from third parties. TI has taken and continues to take reasonable steps to provide representative and accurate information but may not have conducted destructive testing or chemical analysis on incoming materials and chemicals. TI and TI suppliers consider certain information to be proprietary, and thus CAS numbers and other limited information may not be available for release.

In no event shall TI's liability arising out of such information exceed the total purchase price of the TI part(s) at issue in this document sold by TI to Customer on an annual basis.

TAPE AND REEL INFORMATION

QUADRANT ASSIGNMENTS FOR PIN 1 ORIENTATION IN TAPE

*All dimensions are nominal

Device	Package Type	Package Drawing	Pins	SPQ	Reel Diameter (mm)	Reel Width W1 (mm)	A0 (mm)	B0 (mm)	K0 (mm)	P1 (mm)	W (mm)	Pin1 Quadrant
TAS5414BTPHDRQ1	HTQFP	PHD	64	1000	330.0	24.4	17.0	17.0	1.5	20.0	24.0	Q2

TAPE AND REEL BOX DIMENSIONS

*All dimensions are nominal

Device	Package Type	Package Drawing	Pins	SPQ	Length (mm)	Width (mm)	Height (mm)
TAS5414BTPHDRQ1	HTQFP	PHD	64	1000	350.0	350.0	43.0

TRAY

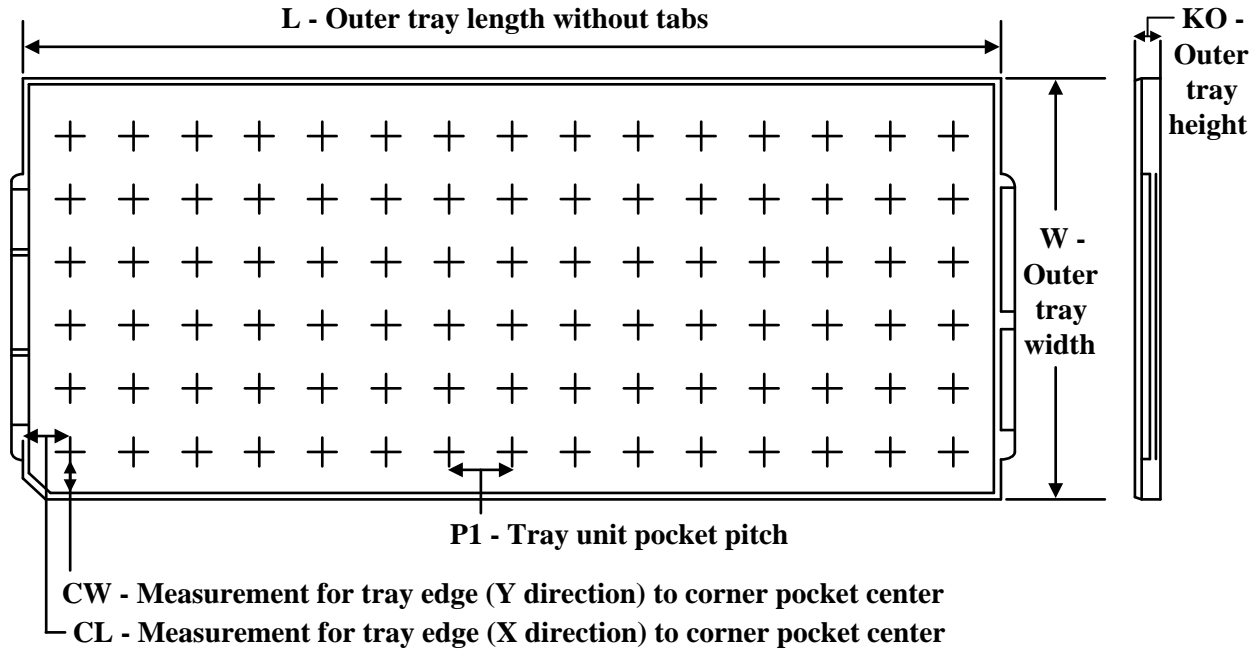

Chamfer on Tray corner indicates Pin 1 orientation of packed units.

*All dimensions are nominal

Device	Package Name	Package Type	Pins	SPQ	Unit array matrix	Max temperature (°C)	L (mm)	W (mm)	K0 (µm)	P1 (mm)	CL (mm)	CW (mm)
TAS5414BTPHDQ1	PHD	HTQFP	64	90	6 X 15	150	315	135.9	7620	20.3	15.4	15.45

GENERIC PACKAGE VIEW

PHD 64

HTQFP - 1.2 mm max height

14 x 14, 0.8 mm pitch

PLASTIC QUAD FLATPACK

This image is a representation of the package family, actual package may vary.
Refer to the product data sheet for package details.

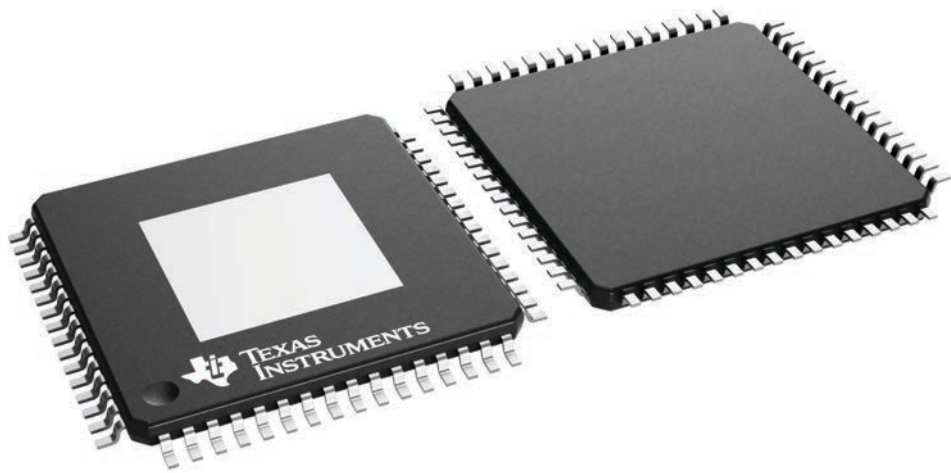

4224851/B

EXAMPLE STENCIL DESIGN

HTQFP - 1.2 mm max height

PHD0064B

PLASTIC QUAD FLATPACK

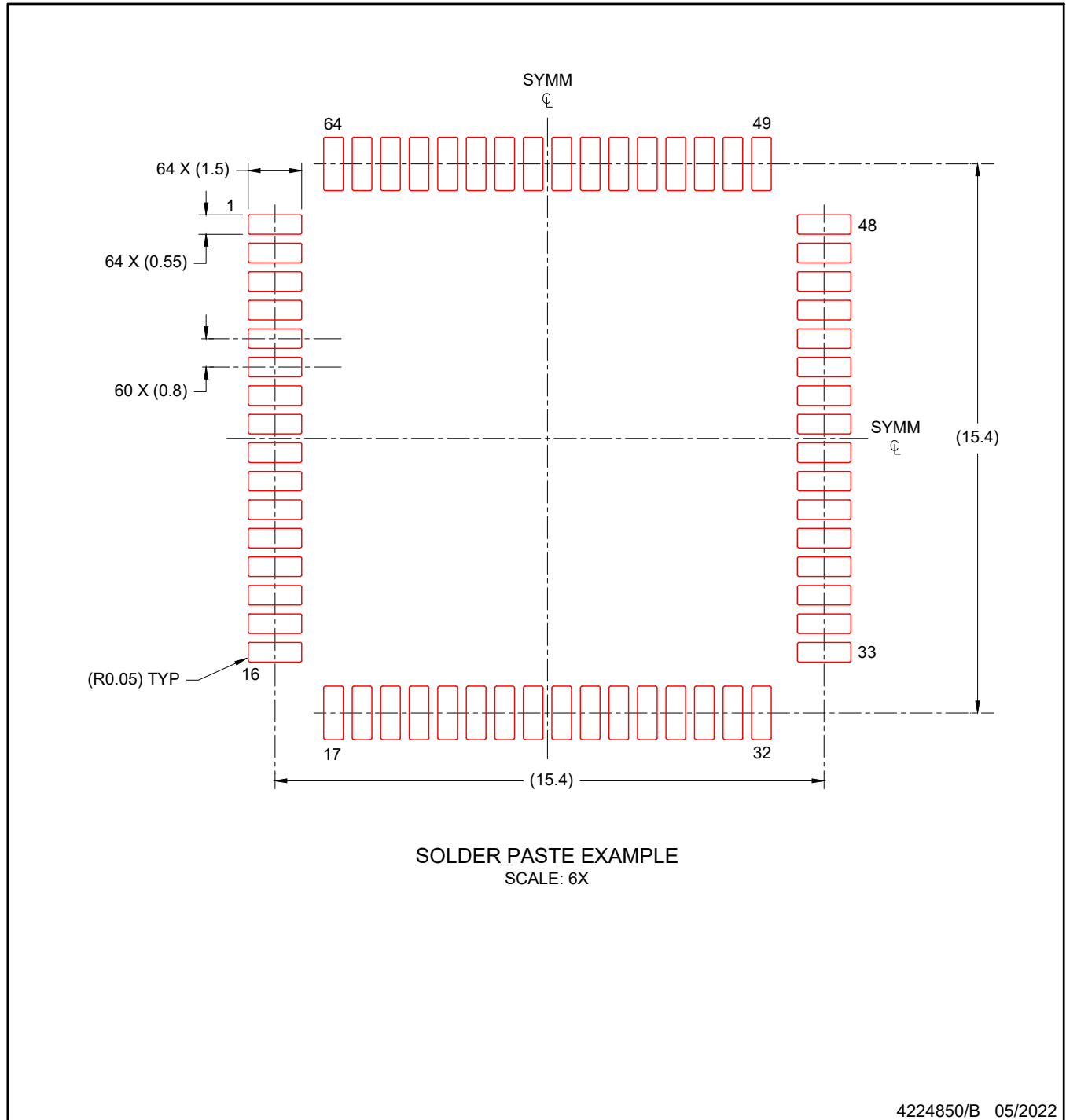

NOTES: (continued)

7. Laser cutting apertures with trapezoidal walls and rounded corners may offer better paste release. IPC-7525 may have alternate design recommendations.
8. Board assembly site may have different recommendations for stencil design.

IMPORTANT NOTICE AND DISCLAIMER

TI PROVIDES TECHNICAL AND RELIABILITY DATA (INCLUDING DATA SHEETS), DESIGN RESOURCES (INCLUDING REFERENCE DESIGNS), APPLICATION OR OTHER DESIGN ADVICE, WEB TOOLS, SAFETY INFORMATION, AND OTHER RESOURCES "AS IS" AND WITH ALL FAULTS, AND DISCLAIMS ALL WARRANTIES, EXPRESS AND IMPLIED, INCLUDING WITHOUT LIMITATION ANY IMPLIED WARRANTIES OF MERCHANTABILITY, FITNESS FOR A PARTICULAR PURPOSE OR NON-INFRINGEMENT OF THIRD PARTY INTELLECTUAL PROPERTY RIGHTS.

These resources are intended for skilled developers designing with TI products. You are solely responsible for (1) selecting the appropriate TI products for your application, (2) designing, validating and testing your application, and (3) ensuring your application meets applicable standards, and any other safety, security, regulatory or other requirements.

These resources are subject to change without notice. TI grants you permission to use these resources only for development of an application that uses the TI products described in the resource. Other reproduction and display of these resources is prohibited. No license is granted to any other TI intellectual property right or to any third party intellectual property right. TI disclaims responsibility for, and you will fully indemnify TI and its representatives against, any claims, damages, costs, losses, and liabilities arising out of your use of these resources.

TI's products are provided subject to [TI's Terms of Sale](#) or other applicable terms available either on [ti.com](https://www.ti.com) or provided in conjunction with such TI products. TI's provision of these resources does not expand or otherwise alter TI's applicable warranties or warranty disclaimers for TI products.

TI objects to and rejects any additional or different terms you may have proposed.

Mailing Address: Texas Instruments, Post Office Box 655303, Dallas, Texas 75265
Copyright © 2024, Texas Instruments Incorporated