

TCAN285x-Q1 Automotive CAN FD SIC and LIN System Basis Chip (SBC) with Wake Inputs and High-side Switches

1 Features

- AEC-Q100 qualified for automotive applications
- Meets the requirements for CAN flexible data (FD) including the signal improvement capability (SIC) per ISO 11898-2:2024
- Local interconnect network (LIN) physical layer specification ISO/DIS 17987-4:2024 compliant and conforms to SAEJ2602 recommended practice for LIN
- [Functional Safety Quality-Managed](#)
- Simplifies system power management with up to three regulators
 - Low drop out (LDO) regulator supporting up to 250mA for 3.3V or 5V MCUs (VCC1)
 - Short-to-battery protected 5V LDO regulator supporting up to 200mA externally (VCC2)
 - Control of an external PNP transistor supporting up to 350mA at 1.8V, 2.5V, 3.3V or 5V (VEXCC)
- Multiple methods to wake from sleep mode
 - CAN and LIN bus wake up pattern (WUP)
 - Optional, CAN selective wake up frame (WUF) capability (partial networking)
 - Local wake up (LWU) via WAKE pins
 - Cyclic sensing wake up support with HSS4
 - Digital wake up using the SW pin
- Four high-side switches for loads up to 150mA
- Protection and Diagnostic Features
 - Timeout, window and Q&A watchdog support
 - Undervoltage (UV), overvoltage (OV) and short-circuit supervision on regulator outputs
 - Fail-safe output (LIMP)
 - UV supervision of VSUP and VHSS; OV supervision of VHSS
 - Advanced CAN bus fault diagnostics
 - ±58V CAN bus fault tolerance
 - Integrated system level ESD protection
- Customer-accessible EEPROM to save device configuration
- QFN (32) package with improved automated optical inspection (AOI) capability

2 Applications

- [Body electronics and lighting](#)
- [Body Control Modules](#)
- [Infotainment and cluster](#)
- [Hybrid, electric and power train systems](#)
- [Industrial transportation](#)

3 Description

The TCAN285x-Q1 is a family of system basis chips (SBC) that provide a control area network flexible data rate capable (CAN FD) SICtransceiver that supports selective wake. The TCAN2857-Q1 includes a local interconnect network (LIN) transceiver. The CAN FD SICtransceiver supports data rates up to 8Mbps while the LIN transceiver supports fast mode data rates up to 200kbps. The VCC1 LDO provides 3.3V or 5V ±2% with up to 250mA of current and determines the digital IO logic levels. If more current is needed, an external PNP transistor can be used to support up to 350mA and voltages of 1.8V, 2.5V, 3.3V or 5V. VCC2 LDO provides 5V up to 200mA.

The TCAN285x-Q1 includes features such as LIMP, three local wake inputs and four high side switches. The high side switch can be on/off, 10-bit PWM or timer controlled. Controlling an external CAN FD, LIN transceiver, CAN SBC or LIN SBC is possible using the GFO pin. The WAKE pins can be configured for static sensing, cyclic sensing (with HSS4 pin) and pulse based for waking up. These devices provide EEPROM to store specific device configuration information; thus, avoiding extensive reprogramming after power fluctuations. WAKE1 and WAKE2 can enable an internal switch between pins to enable external V_{BAT} monitoring. WAKE3 can be configured as a direct drive control pin for any combinations of high-side switches when cyclic sensing wake is enabled.

Package Information

PART NUMBER	PACKAGE ⁽¹⁾	PACKAGE SIZE ⁽²⁾
TCAN2855-Q1	QFN (RHB, 32)	5mm x 5mm
TCAN2857-Q1		

- (1) For more information, see Mechanical, Packaging and Orderable Information.
- (2) The package size (length × width) is a nominal value and includes pins, where applicable.

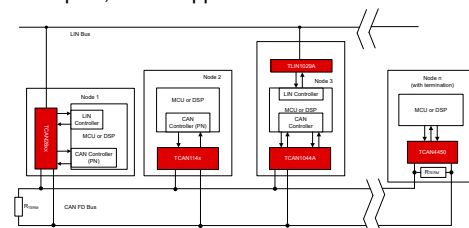

Simplified Schematic

Table of Contents

1 Features	1	6.3 Support Resources.....	6
2 Applications	1	6.4 Trademarks.....	6
3 Description	1	6.5 Electrostatic Discharge Caution.....	6
4 Device Comparison Table	2	6.6 Glossary.....	6
5 Pin Configuration and Functions	3	7 Revision History	6
6 Device and Documentation Support	5	8 Mechanical, Packaging, and Orderable Information	6
6.1 Documentation Support.....	5	8.1 Tape and Reel Information.....	7
6.2 Receiving Notification of Documentation Updates.....	6	8.2 Mechanical Data.....	9

4 Device Comparison Table

Device Number	CAN FD SIC Transceiver	LIN Transceiver	Selective Wake	3.3V LDO	5V LDO
TCAN28553RHBQ1	X		X	X	
TCAN28555RHBQ1	X		X		X
TCAN28573RHBQ1	X	X	X	X	
TCAN28575RHBQ1	X	X	X		X

ADVANCE INFORMATION

5 Pin Configuration and Functions

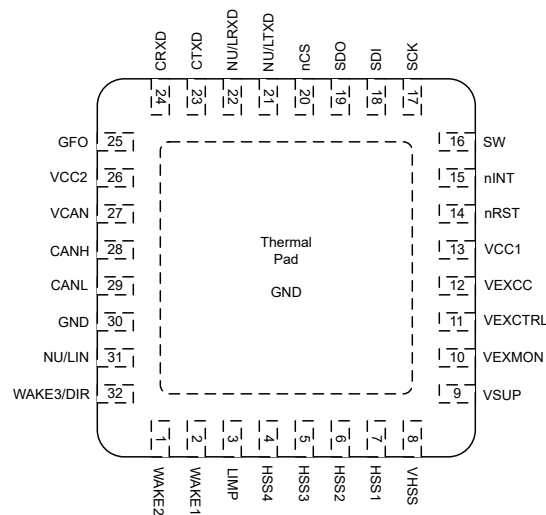

**Figure 5-1. RHB Package, 32 Pin (QFN)
Top View**

Table 5-1. Pin Functions RHB Package

NO. PIN	NO. PIN		TYPE	DESCRIPTION
	TCAN2855-Q1	TCAN2857-Q1		
1	WAKE2	WAKE2	high voltage	Local wake input terminal, high voltage capable
2	WAKE1	WAKE1	high voltage	Local wake input terminal, high voltage capable
3	LIMP	LIMP	high voltage	Limp home output (Active low; open-drain output)
4	HSS4	HSS4	high voltage	High side switch
5	HSS3	HSS3	high voltage	High side switch
6	HSS2	HSS2	high voltage	High side switch
7	HSS1	HSS1	high voltage	High side switch
8	VHSS	VHSS	power	High side switch power
9	VSUP	VSUP	high voltage power	High voltage supply from the battery
10	VEXMON	VEXMON	power	External PNP emitter connection, shunt connection. Connect to VSUP if external PNP LDO is not used. DO not leave floating.
11	VEXCTRL	VEXCTRL	power	External PNP base control
12	VEXCC	VEXCC	power	External PNP collector connection feedback
13	VCC1	VCC1	power	LDO supply output: 3.3V or 5V
14	nRST	nRST	digital	VCC output monitor pin (active low) and device reset input
15	nINT	nINT	digital	Interrupt output (active low)
16	SW	SW	digital	Programming mode input pin (SPI configurable active high or active low)
17	SCK	SCK	digital	SPI clock input
18	SDI	SDI	digital	SPI data input
19	SDO	SDO	digital	SPI data output
20	nCS	nCS	digital	Chip select input (active low)
21	NU	LTXD	digital	LIN transmit data input (low for dominant and high for recessive bus states). NU is not used and should not be connected to anything.
22	NU	LRXD	digital	LIN receive data output (low for dominant and high for recessive bus states), tri-state. NU is not used and should not be connected to anything.
23	CTXD	CTXD	digital	CAN transmit data input (low for dominant and high for recessive bus states).
24	CRXD	CRXD	digital	CAN receive data output (low for dominant and high for recessive bus states), tri-state.
25	GFO	GFO	digital	Function output pin (SPI configurable)
26	VCC2	VCC2	power	5V LDO output
27	VCAN	VCAN	power	CAN FD transceiver 5V power supply input
28	CANH	CANH	bus I/O	High level CAN bus I/O line

Table 5-1. Pin Functions RHB Package (continued)

	NO. PIN		TYPE	DESCRIPTION
	TCAN2855-Q1	TCAN2857-Q1		
29	CANL	CANL	bus I/O	Low level CAN bus I/O line
30	GND	GND	power	Ground connection: Must be soldered to ground
31	NU	LIN	high voltage I/O	LIN bus input/output pin: NU is not used and should not be connected to anything.
32	WAKE3/DIR	WAKE3/DIR	high voltage	Local wake input terminal, high voltage capable. Direct drive to control any HSSx when configured
PAD ⁽¹⁾	GND	GND	power	Ground connection: Must be soldered to ground

(1) The thermal pad, PAD, is a device ground pin must be soldered to GND

6 Device and Documentation Support

This device conforms to the following CAN standards. The core of what is needed is covered within this system spec, however reference should be made to these standards and any discrepancies pointed out and discussed. This document should provide all the basics of what is needed. However, for a full understanding of CAN including the protocol these additional sources are helpful as the scope of CAN protocol in detail is outside the scope of this physical layer (transceiver) specification.

6.1 Documentation Support

6.1.1 CAN Transceiver Physical Layer Standards:

- ISO 11898-2:2024: High speed medium access unit with low power mode (super sets -2 standard electrically in several specs and adds the original wake up capability via the bus in low power mode)
- ISO 8802-3: CSMA/CD – referenced for collision detection from ISO11898-2
- SAE J2284-2: High Speed CAN (HSC) for Vehicle Applications at 250 kbps
- SAE J2284-3: High Speed CAN (HSC) for Vehicle Applications at 500 kbps

6.1.2 LIN Transceiver Physical Layer Standards

- ISO/DIS 17987-1: Road vehicles -- Local Interconnect Network (LIN) -- Part 1: General information and use case definition
- ISO/DIS 17987-4: 2023 Road vehicles -- Local Interconnect Network (LIN) -- Part 4: Electrical Physical Layer (EPL) specification 12V
- SAEJ2602-1: LIN Network for Vehicle Applications
- LIN2.0, LIN2.1, LIN2.2 and LIN2.2A specification

6.1.3 EMC Requirements:

- SAEJ2962-2: US3 requirements for CAN Transceivers (-2, -5, GM will propose updates to address -6 + FD, but this is the best place for a working start)
- HW Requirements for CAN, LIN, FR V1.3: German OEM requirements for CAN and LIN
- ISO 10605: Road vehicles - Test methods for electrical disturbances from electrostatic discharge
- ISO 11452-4:2011: Road vehicles - Component test methods for electrical disturbances from narrowband radiated electromagnetic energy - Part 4: Harness excitation methods
- ISO 7637-1:2015: Road vehicles - Electrical disturbances from conduction and coupling - Part 1: Definitions and general considerations
- ISO 7637-3: Road vehicles - Electrical disturbances from conduction and coupling - Part 3: Electrical transient transmission by capacitive and inductive coupling via lines other than supply lines
- IEC 62132-4:2006: Integrated circuits - Measurement of electromagnetic immunity 150 kHz to 1 GHz - Part 4: Direct RF power injection method
- IEC 61000-4-2
- IEC 61967-4
- CISPR25

6.1.4 Conformance Test Requirements:

- HS_TRX_Test_Spec_V_1_0: GIFT / ICT CAN test requirements for High Speed Physical Layer
- ISO/DIS 17987-7: Road vehicles -- Local Interconnect Network (LIN) -- Part 7: Electrical Physical Layer (EPL) conformance test specification
- SAEJ2602-2: LIN Network for Vehicle Applications Conformance Test

6.1.5 Related Documentation

- “A Comprehensive Guide to Controller Area Network”, Wilfried Voss, Copperhill Media Corporation
- “CAN System Engineering: From Theory to Practical Applications”, 2nd Edition, 2013; Dr. Wolfhard Lawrenz, Springer.

6.2 Receiving Notification of Documentation Updates

To receive notification of documentation updates, navigate to the device product folder on [ti.com](https://www.ti.com). Click on *Notifications* to register and receive a weekly digest of any product information that has changed. For change details, review the revision history included in any revised document.

6.3 Support Resources

[TI E2E™ support forums](#) are an engineer's go-to source for fast, verified answers and design help — straight from the experts. Search existing answers or ask your own question to get the quick design help you need.

Linked content is provided "AS IS" by the respective contributors. They do not constitute TI specifications and do not necessarily reflect TI's views; see TI's [Terms of Use](#).

6.4 Trademarks

TI E2E™ is a trademark of Texas Instruments.

All trademarks are the property of their respective owners.

6.5 Electrostatic Discharge Caution



This integrated circuit can be damaged by ESD. Texas Instruments recommends that all integrated circuits be handled with appropriate precautions. Failure to observe proper handling and installation procedures can cause damage.

ESD damage can range from subtle performance degradation to complete device failure. Precision integrated circuits may be more susceptible to damage because very small parametric changes could cause the device not to meet its published specifications.

6.6 Glossary

[TI Glossary](#) This glossary lists and explains terms, acronyms, and definitions.

7 Revision History

NOTE: Page numbers for previous revisions may differ from page numbers in the current version.

DATE	REVISION	NOTES
November 2024	*	Initial Release

8 Mechanical, Packaging, and Orderable Information

The following pages include mechanical, packaging, and orderable information. This information is the most current data available for the designated devices. This data is subject to change without notice and revision of this document. For browser-based versions of this data sheet, refer to the left-hand navigation.

8.1 Tape and Reel Information

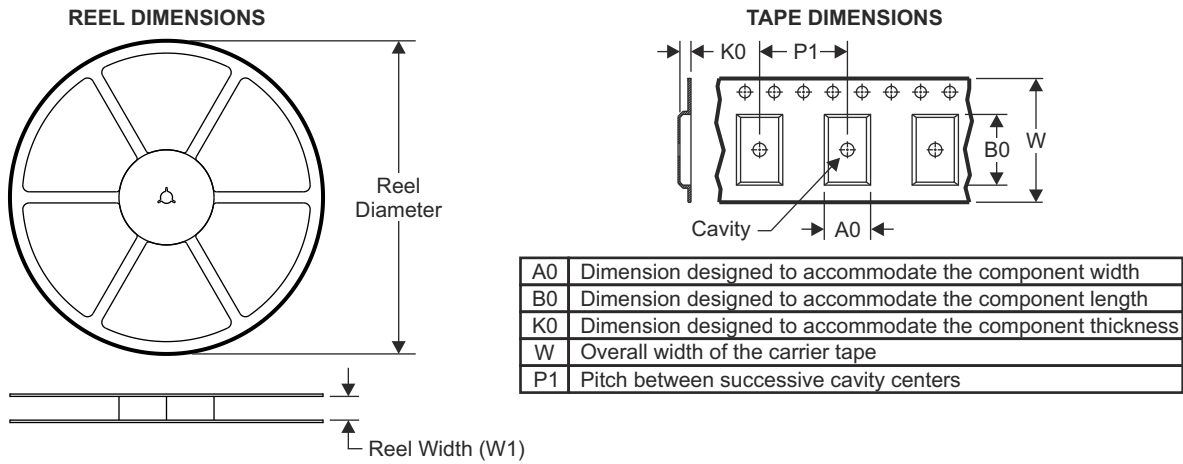

QUADRANT ASSIGNMENTS FOR PIN 1 ORIENTATION IN TAPE

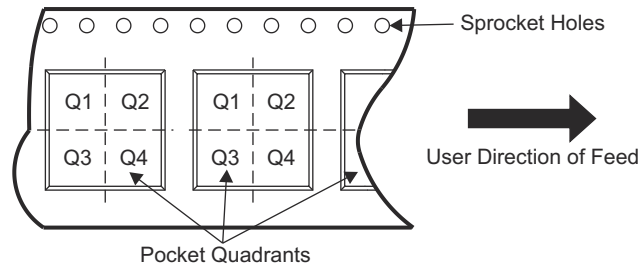

Device	Package Type	Package Drawing	Pins	SPQ	Reel Diameter (mm)	Reel Width W1 (mm)	A0 (mm)	B0 (mm)	K0 (mm)	P1 (mm)	W (mm)	Pin1 Quadrant
PTCAN28553RHBRQ1 TCAN28553RHBRQ1	VQFN	RHB	32	3000	330.0	12.4	5.3	5.3	1.1	8.0	12.0	Q2
PTCAN28555RHBRQ1 TCAN28555RHBRQ1	VQFN	RHB	32	3000	330.0	12.4	5.3	5.3	1.1	8.0	12.0	Q2
PTCAN28573RHBRQ1 TCAN28573RHBRQ1	VQFN	RHB	32	3000	330.0	12.4	5.3	5.3	1.1	8.0	12.0	Q2
PTCAN28575RHBRQ1 TCAN28575RHBRQ1	VQFN	RHB	32	3000	330.0	12.4	5.3	5.3	1.1	8.0	12.0	Q2

ADVANCE INFORMATION

TAPE AND REEL BOX DIMENSIONS

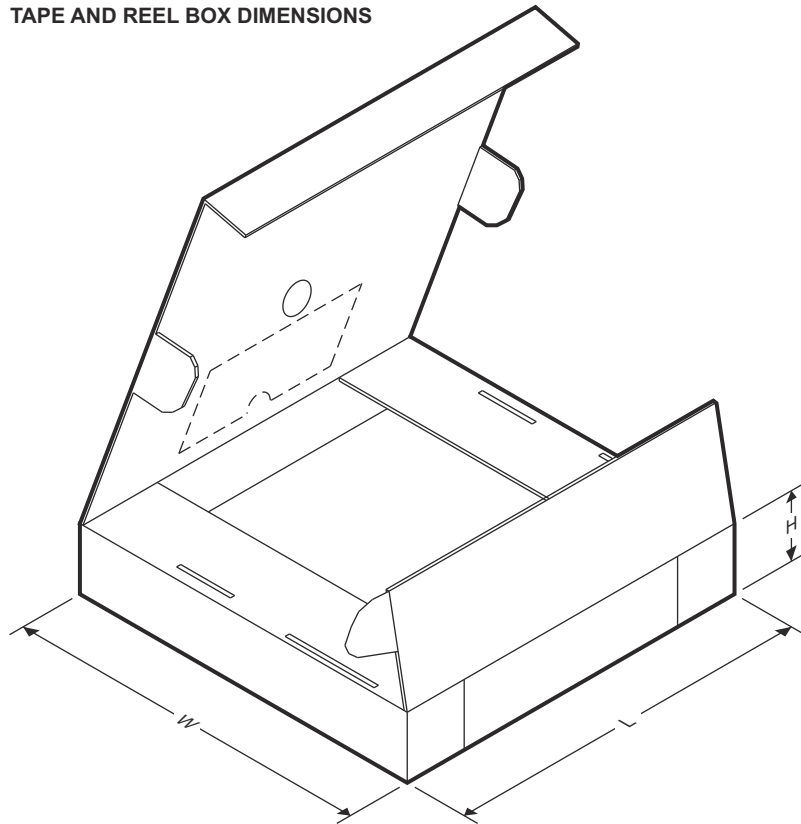

ADVANCE INFORMATION

Device	Package Type	Package Drawing	Pins	SPQ	Length (mm)	Width (mm)	Height (mm)
TCAN28553RHBRQ1	VQFN	RHB	32	3000	367.0	367.0	35.0
TCAN28555RHBRQ1	VQFN	RHB	32	3000	367.0	367.0	35.0
TCAN28573RHBRQ1	VQFN	RHB	32	3000	367.0	367.0	35.0
TCAN28575RHBRQ1	VQFN	RHB	32	3000	367.0	367.0	35.0

8.2 Mechanical Data

RHB0032U

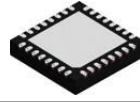

PACKAGE OUTLINE

VQFN - 1 mm max height

PLASTIC QUAD FLATPACK - NO LEAD

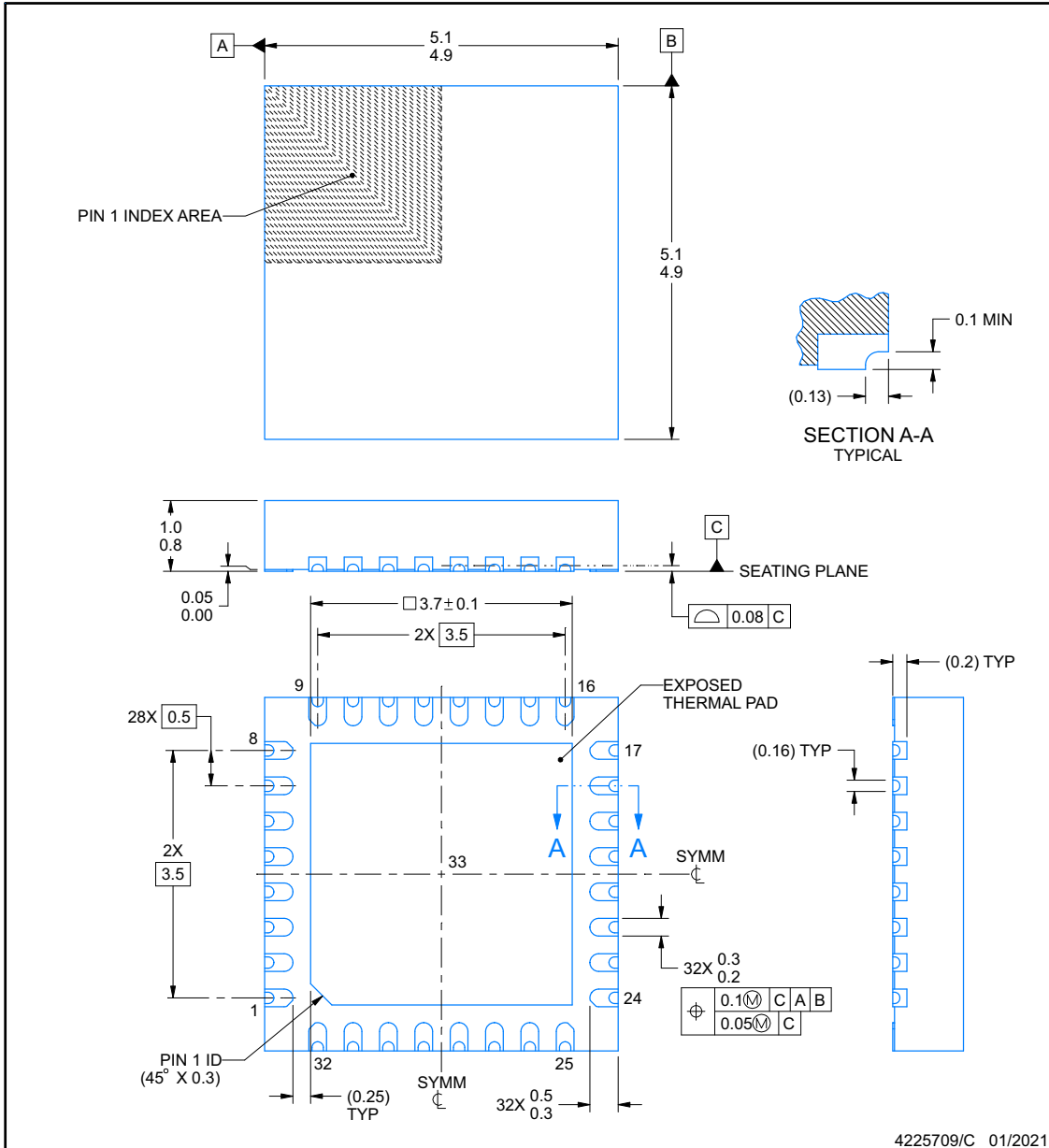

NOTES:

1. All linear dimensions are in millimeters. Any dimensions in parenthesis are for reference only. Dimensioning and tolerancing per ASME Y14.5M.
2. This drawing is subject to change without notice.
3. The package thermal pad must be soldered to the printed circuit board for thermal and mechanical performance.

ADVANCE INFORMATION

EXAMPLE BOARD LAYOUT

RHB0032U

VQFN - 1 mm max height

PLASTIC QUAD FLATPACK - NO LEAD

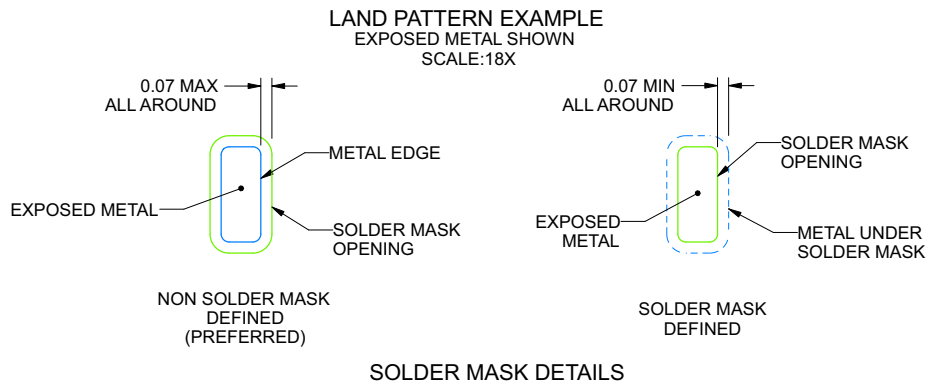
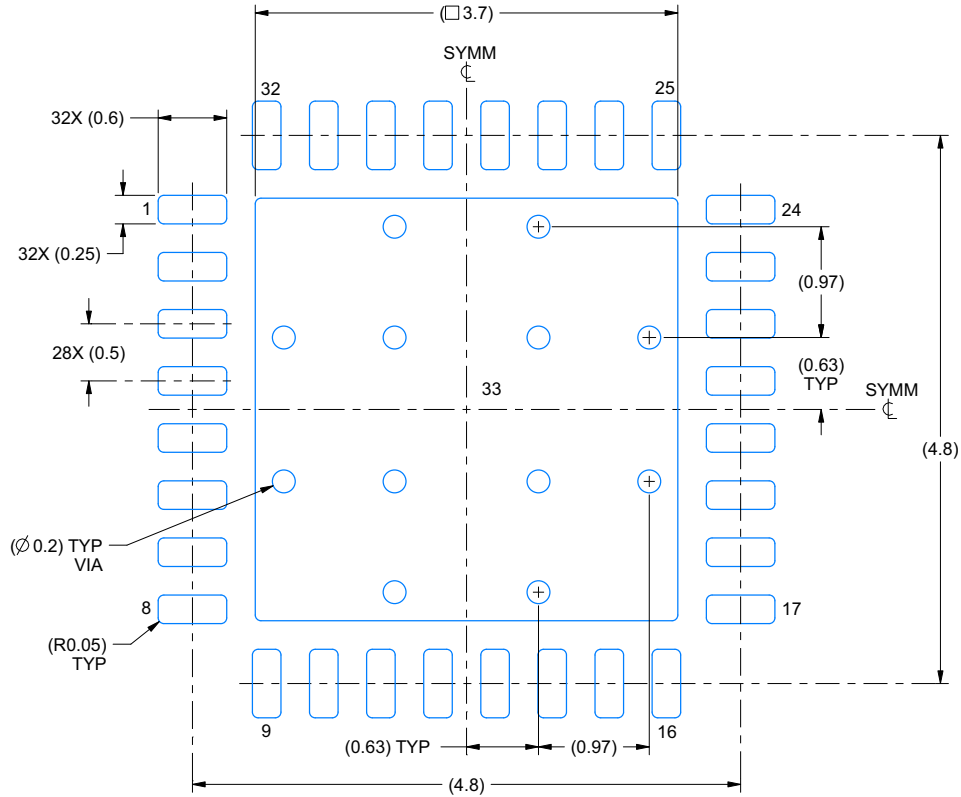

4225709/C 01/2021

NOTES: (continued)

- This package is designed to be soldered to a thermal pad on the board. For more information, see Texas Instruments literature number SLUA271 (www.ti.com/lit/sluea271).
- Vias are optional depending on application, refer to device data sheet. If any vias are implemented, refer to their locations shown on this view. It is recommended that vias under paste be filled, plugged or tented.

EXAMPLE STENCIL DESIGN

RHB0032U

VQFN - 1 mm max height

PLASTIC QUAD FLATPACK - NO LEAD

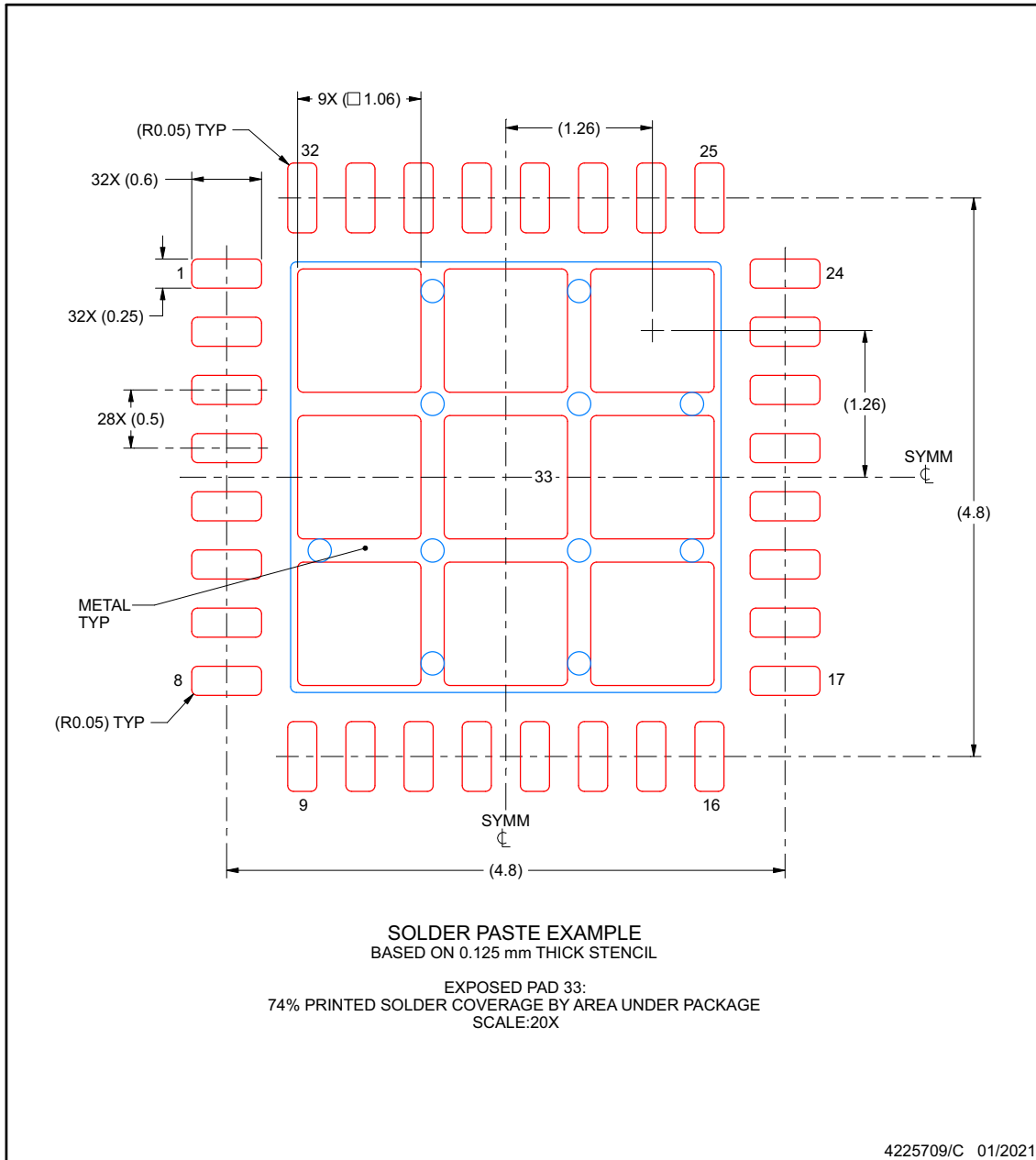

NOTES: (continued)

- 6. Laser cutting apertures with trapezoidal walls and rounded corners may offer better paste release. IPC-7525 may have alternate design recommendations.

ADVANCE INFORMATION

PACKAGING INFORMATION

Orderable Device	Status (1)	Package Type	Package Drawing	Pins	Package Qty	Eco Plan (2)	Lead finish/ Ball material (6)	MSL Peak Temp (3)	Op Temp (°C)	Device Marking (4/5)	Samples
PTCAN28575RHBRQ1	ACTIVE	VQFN	RHB	32	5000	TBD	Call TI	Call TI	-40 to 125		Samples

(1) The marketing status values are defined as follows:

ACTIVE: Product device recommended for new designs.

LIFEBUY: TI has announced that the device will be discontinued, and a lifetime-buy period is in effect.

NRND: Not recommended for new designs. Device is in production to support existing customers, but TI does not recommend using this part in a new design.

PREVIEW: Device has been announced but is not in production. Samples may or may not be available.

OBSELETE: TI has discontinued the production of the device.

(2) **RoHS:** TI defines "RoHS" to mean semiconductor products that are compliant with the current EU RoHS requirements for all 10 RoHS substances, including the requirement that RoHS substance do not exceed 0.1% by weight in homogeneous materials. Where designed to be soldered at high temperatures, "RoHS" products are suitable for use in specified lead-free processes. TI may reference these types of products as "Pb-Free".

RoHS Exempt: TI defines "RoHS Exempt" to mean products that contain lead but are compliant with EU RoHS pursuant to a specific EU RoHS exemption.

Green: TI defines "Green" to mean the content of Chlorine (Cl) and Bromine (Br) based flame retardants meet JS709B low halogen requirements of <=1000ppm threshold. Antimony trioxide based flame retardants must also meet the <=1000ppm threshold requirement.

(3) MSL, Peak Temp. - The Moisture Sensitivity Level rating according to the JEDEC industry standard classifications, and peak solder temperature.

(4) There may be additional marking, which relates to the logo, the lot trace code information, or the environmental category on the device.

(5) Multiple Device Markings will be inside parentheses. Only one Device Marking contained in parentheses and separated by a "-" will appear on a device. If a line is indented then it is a continuation of the previous line and the two combined represent the entire Device Marking for that device.

(6) Lead finish/Ball material - Orderable Devices may have multiple material finish options. Finish options are separated by a vertical ruled line. Lead finish/Ball material values may wrap to two lines if the finish value exceeds the maximum column width.

Important Information and Disclaimer:The information provided on this page represents TI's knowledge and belief as of the date that it is provided. TI bases its knowledge and belief on information provided by third parties, and makes no representation or warranty as to the accuracy of such information. Efforts are underway to better integrate information from third parties. TI has taken and continues to take reasonable steps to provide representative and accurate information but may not have conducted destructive testing or chemical analysis on incoming materials and chemicals. TI and TI suppliers consider certain information to be proprietary, and thus CAS numbers and other limited information may not be available for release.

In no event shall TI's liability arising out of such information exceed the total purchase price of the TI part(s) at issue in this document sold by TI to Customer on an annual basis.

GENERIC PACKAGE VIEW

RHB 32

VQFN - 1 mm max height

5 x 5, 0.5 mm pitch

PLASTIC QUAD FLATPACK - NO LEAD



Images above are just a representation of the package family, actual package may vary.
Refer to the product data sheet for package details.

4224745/A

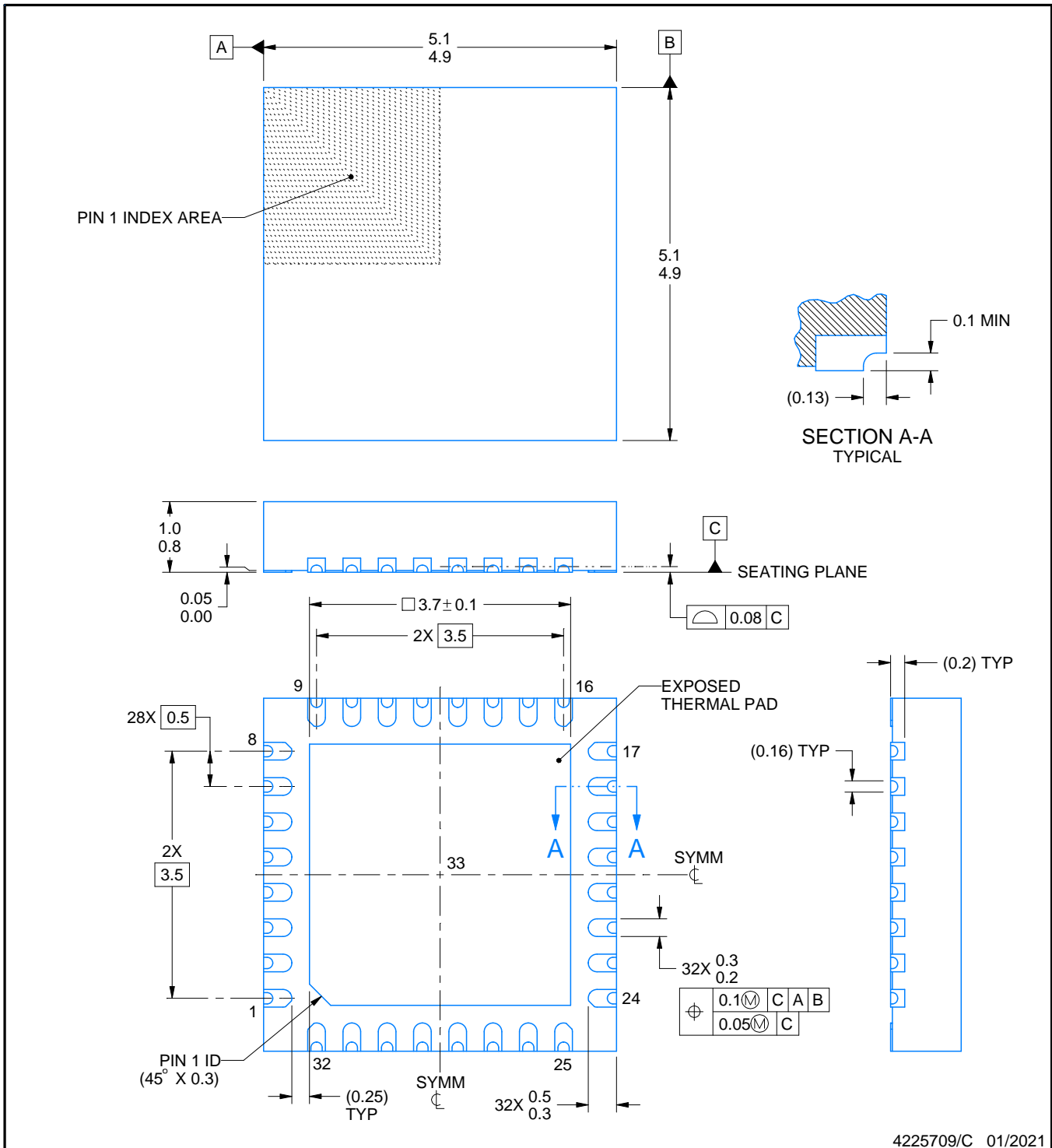
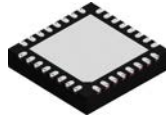

NOTES:

1. All linear dimensions are in millimeters. Any dimensions in parenthesis are for reference only. Dimensioning and tolerancing per ASME Y14.5M.
2. This drawing is subject to change without notice.
3. The package thermal pad must be soldered to the printed circuit board for thermal and mechanical performance.

EXAMPLE BOARD LAYOUT

RHB0032U

VQFN - 1 mm max height

PLASTIC QUAD FLATPACK - NO LEAD

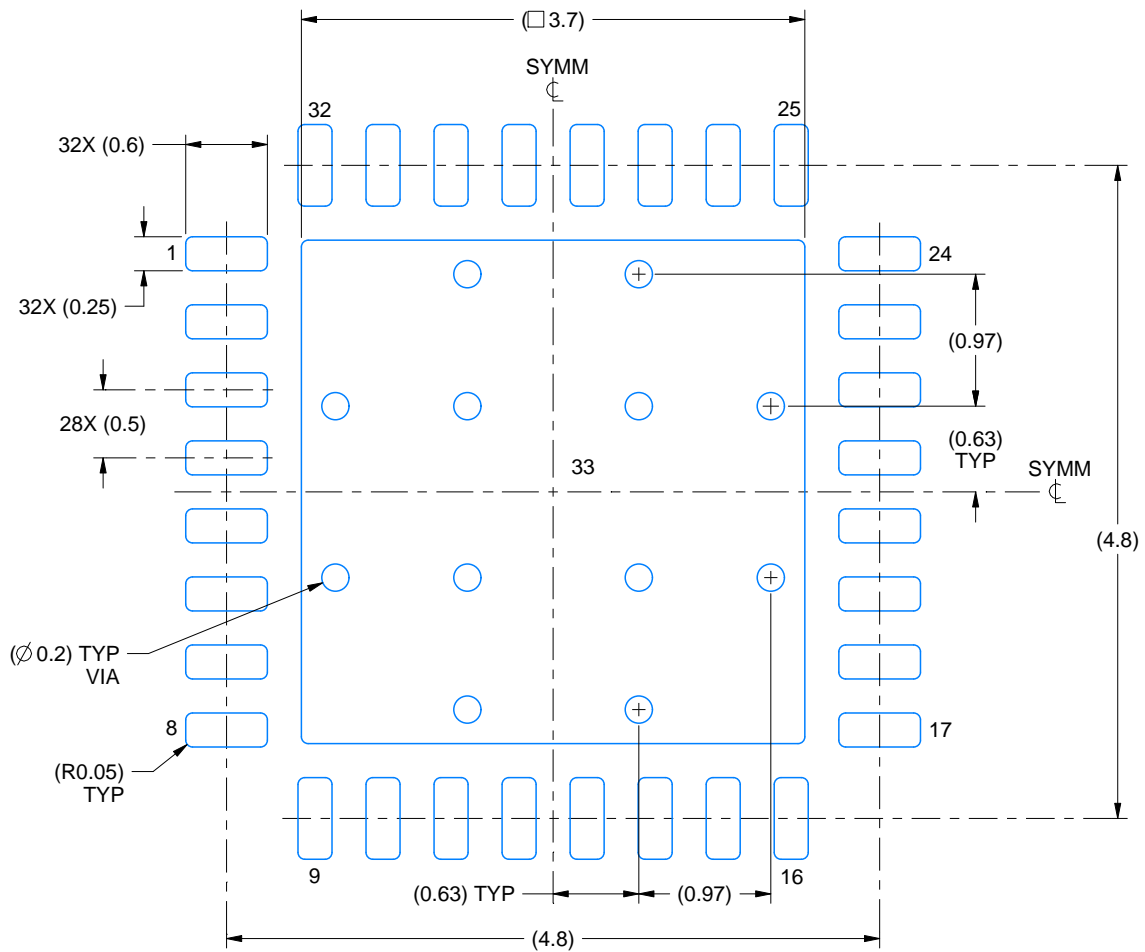

LAND PATTERN EXAMPLE
EXPOSED METAL SHOWN
SCALE:18X

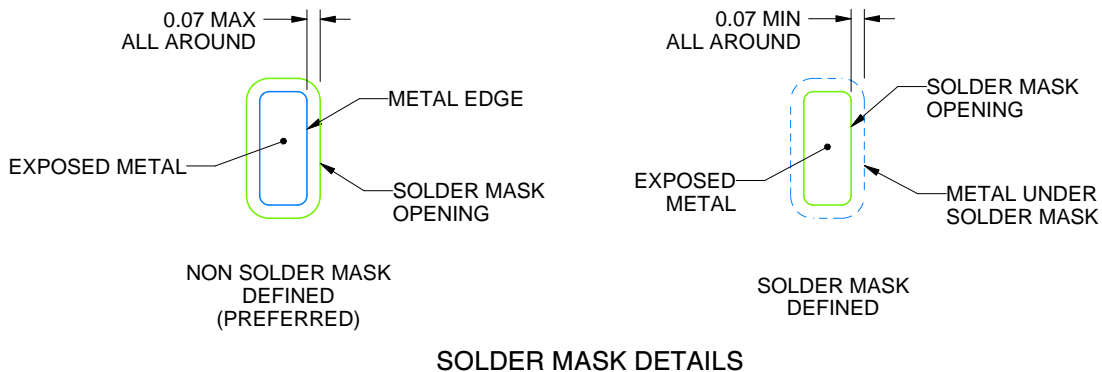

SOLDER MASK DETAILS

4225709/C 01/2021

NOTES: (continued)

- This package is designed to be soldered to a thermal pad on the board. For more information, see Texas Instruments literature number SLUA271 (www.ti.com/lit/slua271).
- Vias are optional depending on application, refer to device data sheet. If any vias are implemented, refer to their locations shown on this view. It is recommended that vias under paste be filled, plugged or tented.

EXAMPLE STENCIL DESIGN

RHB0032U

VQFN - 1 mm max height

PLASTIC QUAD FLATPACK - NO LEAD

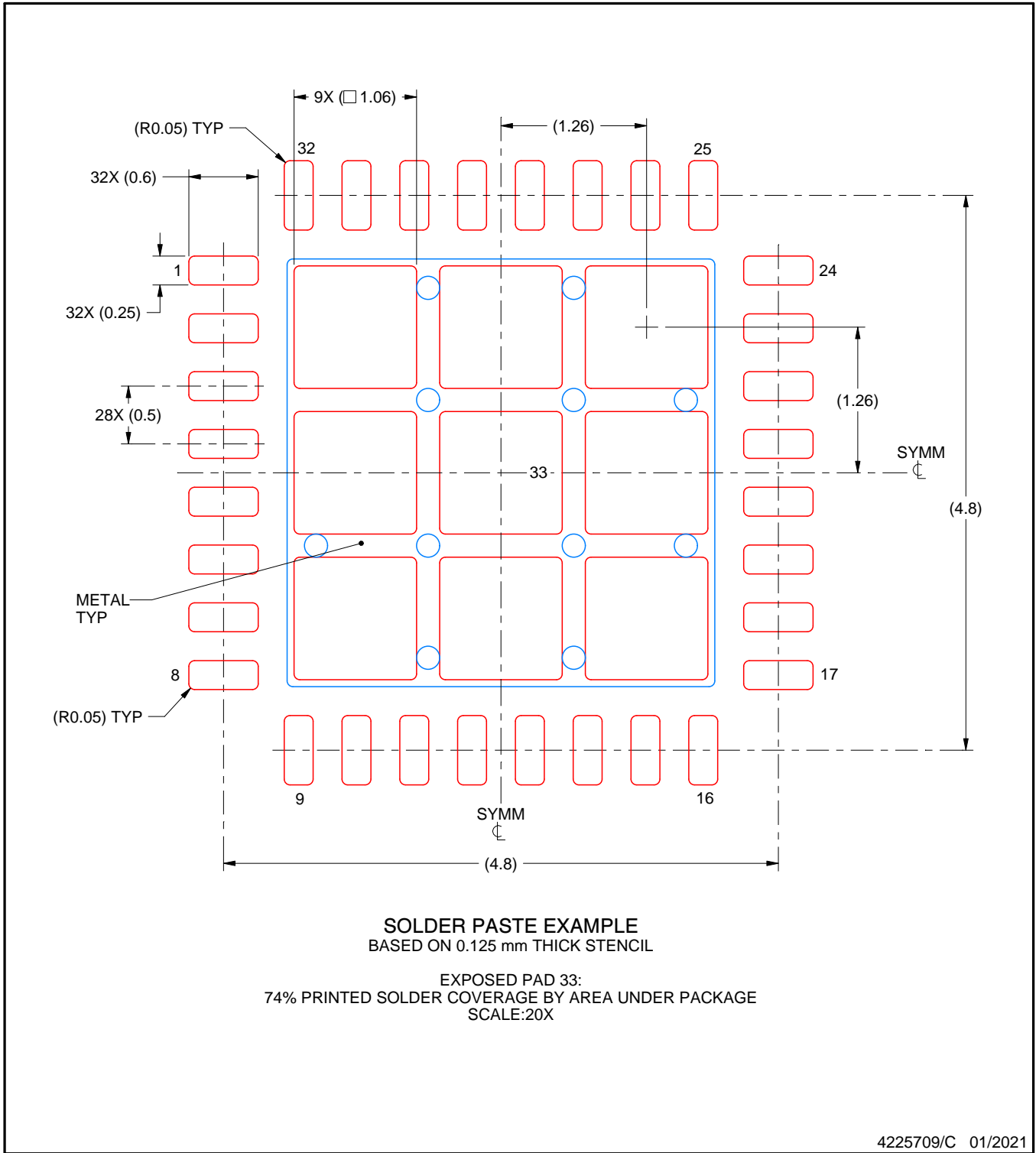

NOTES: (continued)

6. Laser cutting apertures with trapezoidal walls and rounded corners may offer better paste release. IPC-7525 may have alternate design recommendations.

IMPORTANT NOTICE AND DISCLAIMER

TI PROVIDES TECHNICAL AND RELIABILITY DATA (INCLUDING DATA SHEETS), DESIGN RESOURCES (INCLUDING REFERENCE DESIGNS), APPLICATION OR OTHER DESIGN ADVICE, WEB TOOLS, SAFETY INFORMATION, AND OTHER RESOURCES "AS IS" AND WITH ALL FAULTS, AND DISCLAIMS ALL WARRANTIES, EXPRESS AND IMPLIED, INCLUDING WITHOUT LIMITATION ANY IMPLIED WARRANTIES OF MERCHANTABILITY, FITNESS FOR A PARTICULAR PURPOSE OR NON-INFRINGEMENT OF THIRD PARTY INTELLECTUAL PROPERTY RIGHTS.

These resources are intended for skilled developers designing with TI products. You are solely responsible for (1) selecting the appropriate TI products for your application, (2) designing, validating and testing your application, and (3) ensuring your application meets applicable standards, and any other safety, security, regulatory or other requirements.

These resources are subject to change without notice. TI grants you permission to use these resources only for development of an application that uses the TI products described in the resource. Other reproduction and display of these resources is prohibited. No license is granted to any other TI intellectual property right or to any third party intellectual property right. TI disclaims responsibility for, and you will fully indemnify TI and its representatives against, any claims, damages, costs, losses, and liabilities arising out of your use of these resources.

TI's products are provided subject to [TI's Terms of Sale](#) or other applicable terms available either on [ti.com](https://www.ti.com) or provided in conjunction with such TI products. TI's provision of these resources does not expand or otherwise alter TI's applicable warranties or warranty disclaimers for TI products.

TI objects to and rejects any additional or different terms you may have proposed.

Mailing Address: Texas Instruments, Post Office Box 655303, Dallas, Texas 75265
Copyright © 2024, Texas Instruments Incorporated