

# TLV2432-Q1, TLV2432A-Q1, TLV2434-Q1, TLV2434A-Q1 Advanced LinCMOS™ RAIL-TO-RAIL OUTPUT WIDE-INPUT-VOLTAGE OPERATIONAL AMPLIFIERS

SGLS182B – SEPTEMBER 2003 – REVISED NOVEMBER 2010

- Qualified for Automotive Applications
- ESD Protection Exceeds 2000 V Per MIL-STD-883, Method 3015; Exceeds 200 V Using Machine Model (C = 200 pF, R = 0)
- Output Swing Includes Both Supply Rails
- Extended Common-Mode Input Voltage Range . . . 0 V to 4.5 V (Min) with 5-V Single Supply
- No Phase Inversion
- Low Noise . . . 18 nV/√Hz Typ at f = 1 kHz
- Low Input Offset Voltage  
950 μV Max at T<sub>A</sub> = 25°C (TLV243xA)
- Low Input Bias Current . . . 1 pA Typ
- Very Low Supply Current . . . 125 μA Per Channel Max
- 600-Ω Output Drive
- Macromodel Included

## description

The TLV243x and TLV243xA are low-voltage operational amplifier from Texas Instruments. The common-mode input voltage range for each device is extended over the typical CMOS amplifiers making them suitable for a wide range of applications. In addition, these devices do not phase invert when the common-mode input is driven to the supply rails. This satisfies most design requirements without paying a premium for rail-to-rail input performance. They also exhibit rail-to-rail output performance for increased dynamic range in single- or split-supply applications. This family is fully characterized at 3-V and 5-V supplies and is optimized for low-voltage operation. The TLV243x only requires 100 μA (typ) of supply current per channel, making it ideal for battery-powered applications. The TLV243x also has increased output drive over previous rail-to-rail operational amplifiers and can drive 600-Ω loads for telecom applications.

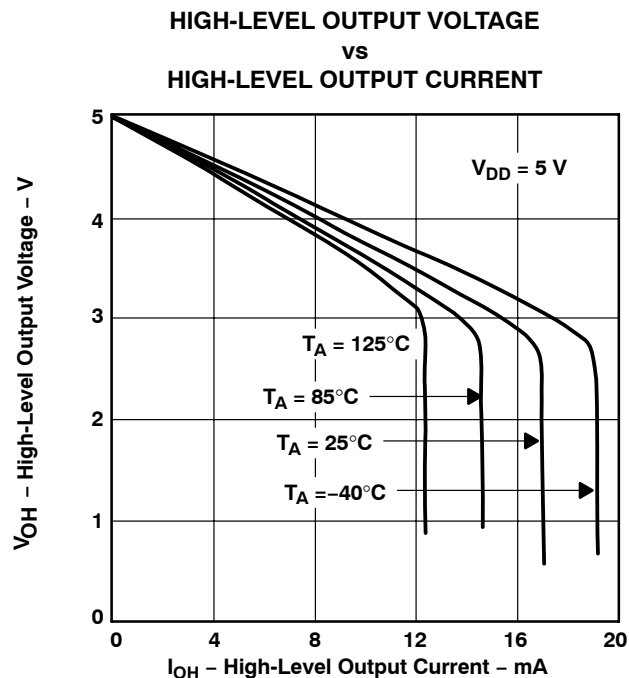

Figure 1

The other members in the TLV243x family are the high-power, TLV244x, and micro-power, TLV2422, versions.

The TLV243x, exhibiting high input impedance and low noise, is excellent for small-signal conditioning for high-impedance sources, such as piezoelectric transducers. Because of the micropower dissipation levels and low-voltage operation, these devices work well in hand-held monitoring and remote-sensing applications. In addition, the rail-to-rail output feature with single- or split-supplies makes this family a great choice when interfacing with analog-to-digital converters (ADCs). For precision applications, the TLV243xA is available and has a maximum input offset voltage of 950 μV.

If the design requires single operational amplifiers, see the TI TLV2211/21/31. This is a family of rail-to-rail output operational amplifiers in the SOT-23 package. Their small size and low power consumption, make them ideal for high density, battery-powered equipment.



Please be aware that an important notice concerning availability, standard warranty, and use in critical applications of Texas Instruments semiconductor products and disclaimers thereto appears at the end of this data sheet.

PRODUCTION DATA information is current as of publication date. Products conform to specifications per the terms of Texas Instruments standard warranty. Production processing does not necessarily include testing of all parameters.

 **TEXAS  
INSTRUMENTS**

POST OFFICE BOX 655303 • DALLAS, TEXAS 75265

Copyright © 2008 Texas Instruments Incorporated

# TLV2432-Q1, TLV2432A-Q1, TLV2434-Q1, TLV2434A-Q1

## Advanced LinCMOS™ RAIL-TO-RAIL OUTPUT

### WIDE-INPUT-VOLTAGE OPERATIONAL AMPLIFIERS

SGLS182B – SEPTEMBER 2003 – REVISED NOVEMBER 2010

#### ORDERING INFORMATION†

$T_A$	$V_{IOmax}$ AT 25°C	PACKAGE‡		ORDERABLE PART NUMBER	TOP-SIDE MARKING
-40°C to 125°C	950 $\mu$ V	SOIC (D)	Tape and reel	TLV2432AQDRQ1	2432AQ
		TSSOP (PW)	Tape and reel	TLV2432AQPWRQ1§	
	2.5 mV	SOIC (D)	Tape and reel	TLV2432QDRQ1	2432Q1
		TSSOP (PW)	Tape and reel	TLV2432QPWRQ1§	
-40°C to 125°C	950 $\mu$ V	SOIC (D)	Tape and reel	TLV2434AQDRQ1	2434AQ
		TSSOP (PW)	Tape and reel	TLV2434AQPWRQ1§	
	2.5 mV	SOIC (D)	Tape and reel	TLV2434QDRQ1§	
		TSSOP (PW)	Tape and reel	TLV2434QPWRQ1§	

† For the most current package and ordering information, see the Package Option Addendum at the end of this document, or see the TI web site at <http://www.ti.com>.

‡ Package drawings, thermal data, and symbolization are available at <http://www.ti.com/packaging>.

§ Product Preview.

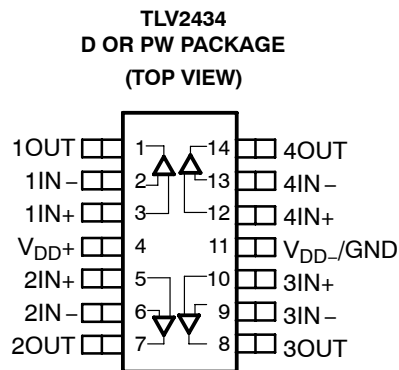
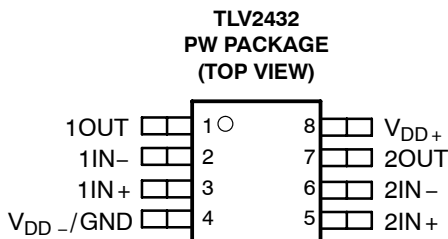
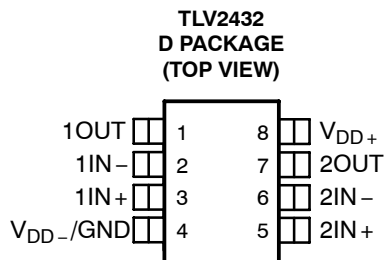

**TLV2432-Q1, TLV2432A-Q1, TLV2434-Q1, TLV2434A-Q1**  
**Advanced LincMOS™ RAIL-TO-RAIL OUTPUT**  
**WIDE-INPUT-VOLTAGE OPERATIONAL AMPLIFIERS**

SLS182B - SEPTEMBER 2003 - REVISED NOVEMBER 2010

equivalent schematic (each amplifier)

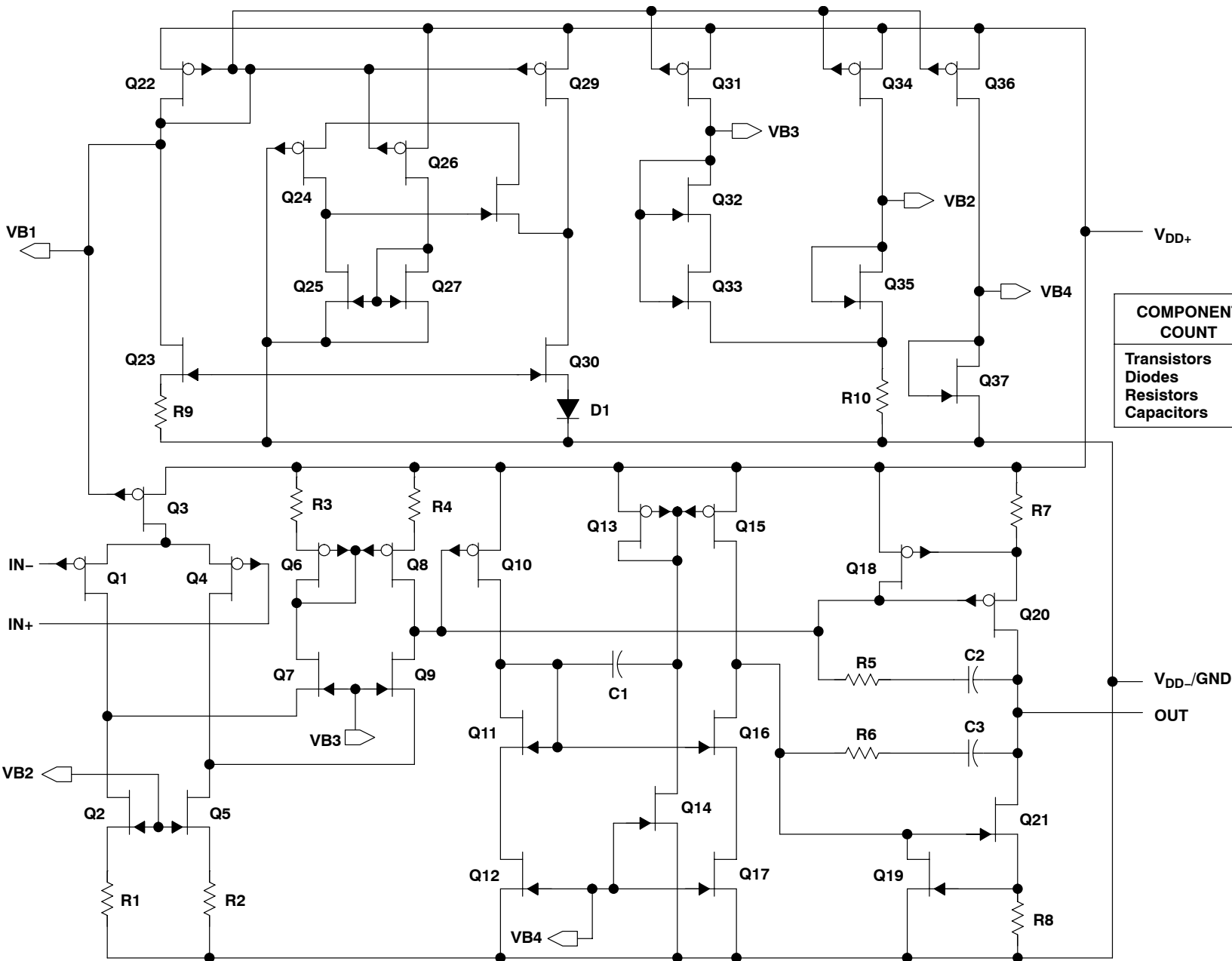

COMPONENT COUNT	
Transistors	69
Diodes	5
Resistors	26
Capacitors	6

**TLV2432-Q1, TLV2432A-Q1, TLV2434-Q1, TLV2434A-Q1**  
**Advanced LinCMOS™ RAIL-TO-RAIL OUTPUT**  
**WIDE-INPUT-VOLTAGE OPERATIONAL AMPLIFIERS**

SGLS182B – SEPTEMBER 2003 – REVISED NOVEMBER 2010

**absolute maximum ratings over operating free-air temperature range (unless otherwise noted)†**

Supply voltage, $V_{DD}$ (see Note 1)	12 V
Differential input voltage, $V_{ID}$ (see Note 2)	$\pm V_{DD}$
Input current, $I_I$ (each input)	$\pm 5$ mA
Output current, $I_O$	$\pm 50$ mA
Total current into $V_{DD+}$	$\pm 50$ mA
Total current out of $V_{DD-}$	$\pm 50$ mA
Duration of short-circuit current at (or below) 25°C (see Note 3)	unlimited
Continuous total dissipation	See Dissipation Rating Table
Operating free-air temperature range, $T_A$ : Q suffix	-40°C to 125°C
Storage temperature range, $T_{stg}$	-65°C to 150°C
Lead temperature 1,6 mm (1/16 inch) from case for 10 seconds	260°C

† Stresses beyond those listed under “absolute maximum ratings” may cause permanent damage to the device. These are stress ratings only, and functional operation of the device at these or any other conditions beyond those indicated under “recommended operating conditions” is not implied. Exposure to absolute-maximum-rated conditions for extended periods may affect device reliability.

- NOTES: 1. All voltage values, except differential voltages, are with respect to the midpoint between  $V_{DD+}$  and  $V_{DD-}$ .  
 2. Differential voltages are at  $IN+$  with respect to  $IN-$ . Excessive current flows if input is brought below  $V_{DD-} - 0.3$  V.  
 3. The output may be shorted to either supply. Temperature and/or supply voltages must be limited to ensure that the maximum dissipation rating is not exceeded.

**DISSIPATION RATING TABLE**

PACKAGE	$T_A \leq 25^\circ\text{C}$ POWER RATING	DERATING FACTOR ABOVE $T_A = 25^\circ\text{C}$	$T_A = 70^\circ\text{C}$ POWER RATING	$T_A = 85^\circ\text{C}$ POWER RATING	$T_A = 125^\circ\text{C}$ POWER RATING
D (8)	725 mW	5.8 mW/°C	464 mW	377 mW	145 mW
D (14)	1022 mW	7.6 mW/°C	900 mW	777 mW	450 mW
PW (8)	525 mW	4.2 mW/°C	336 mW	273 mW	105 mW
PW (14)	720 mW	5.6 mW/°C	634 mW	547 mW	317 mW

**recommended operating conditions**

	MIN	MAX	UNIT
Supply voltage, $V_{DD}$	2.7	10	V
Input voltage range, $V_I$	$V_{DD-}$	$V_{DD+} - 0.8$	V
Common-mode input voltage, $V_{IC}$	$V_{DD-}$	$V_{DD+} - 0.8$	V
Operating free-air temperature, $T_A$	-40	125	°C



**TLV2432-Q1, TLV2432A-Q1, TLV2434-Q1, TLV2434A-Q1**  
**Advanced LinCMOS™ RAIL-TO-RAIL OUTPUT**  
**WIDE-INPUT-VOLTAGE OPERATIONAL AMPLIFIERS**

SGLS182B – SEPTEMBER 2003 – REVISED NOVEMBER 2010

**electrical characteristics at specified free-air temperature,  $V_{DD} = 3\text{ V}$  (unless otherwise noted)**

PARAMETER	TEST CONDITIONS		$T_A^\dagger$	TLV243x-Q1			UNIT
				MIN	TYP	MAX	
$V_{IO}$ Input offset voltage	$V_{IC} = 0,$ $V_O = 0,$ $V_{DD} \pm = \pm 1.5\text{ V},$ $R_S = 50\ \Omega$	TLV243x	25°C	300	2000	$\mu\text{V}$	
			Full range	2500			
		TLV243xA	25°C	300	950		
			Full range	2000			
$\alpha_{V_{IO}}$ Temperature coefficient of input offset voltage	$V_{IC} = 0,$ $V_O = 0,$ $V_{DD} \pm = \pm 1.5\text{ V},$ $R_S = 50\ \Omega$		25°C to 70°C	2		$\mu\text{V}/^\circ\text{C}$	
Input offset voltage long-term drift (see Note 4)			25°C	0.003		$\mu\text{V}/\text{mo}$	
$I_{IO}$ Input offset current			25°C	0.5		$\text{pA}$	
			Full range	150			
$I_{IB}$ Input bias current			25°C	1		$\text{pA}$	
			Full range	300			
$V_{ICR}$ Common-mode input voltage range	$ V_{IO}  \leq 5\text{ mV},$	$R_S = 50\ \Omega$	25°C	0 to 2.5	-0.25 to 2.75	V	
			Full range	0 to 2.2			
$V_{OH}$ High-level output voltage	$I_{OH} = -100\ \mu\text{A}$		25°C	2.98		V	
			25°C	2.5			
			Full range	2.25			
$V_{OL}$ Low-level output voltage	$V_{IC} = 1.5\text{ V},$	$I_{OL} = 100\ \mu\text{A}$	25°C	0.02		V	
			25°C	0.83			
	$V_{IC} = 1.5\text{ V},$	$I_{OL} = 3\text{ mA}$	Full range	1			
$A_{VD}$ Large-signal differential voltage amplification	$V_{IC} = 2.5\text{ V},$ $V_O = 1\text{ V to }2\text{ V}$	$R_L = 2\text{ k}\Omega^\ddagger$	25°C	1.5	2.5	V/mV	
			Full range	0.5			
		$R_L = 1\text{ M}\Omega^\ddagger$	25°C	750			
$r_{i(d)}$ Differential input resistance			25°C	1000		$\text{G}\Omega$	
$r_{i(c)}$ Common-mode input resistance			25°C	1000		$\text{G}\Omega$	
$c_{i(c)}$ Common-mode input capacitance	$f = 10\text{ kHz}$		25°C	8		$\text{pF}$	
$z_o$ Closed-loop output impedance	$f = 100\text{ kHz},$	$A_V = 10$	25°C	130		$\Omega$	
CMRR Common-mode rejection ratio	$V_{IC} = V_{ICR\text{ MIN}},$	$V_O = 1.5\text{ V},$	25°C	70	83	dB	
			Full range	70			
$k_{SVR}$ Supply-voltage rejection ratio ( $\Delta V_{DD}/\Delta V_{IO}$ )	$V_{DD} = 2.7\text{ V to }8\text{ V},$	$V_{IC} = V_{DD}/2,$	25°C	80	95	dB	
			Full range	80			
$I_{DD}$ Supply current	$V_O = 1.5\text{ V},$	No load	25°C	195	250	$\mu\text{A}$	
			Full range	260			

$^\dagger$  Full range is  $-40^\circ\text{C}$  to  $125^\circ\text{C}$  for Q level part.

$^\ddagger$  Referenced to 2.5 V

NOTE 4: Typical values are based on the input offset voltage shift observed through 500 hours of operating life test at  $T_A = 150^\circ\text{C}$  extrapolated to  $T_A = 25^\circ\text{C}$  using the Arrhenius equation and assuming an activation energy of 0.96 eV.



**TLV2432-Q1, TLV2432A-Q1, TLV2434-Q1, TLV2434A-Q1**  
**Advanced LinCMOS™ RAIL-TO-RAIL OUTPUT**  
**WIDE-INPUT-VOLTAGE OPERATIONAL AMPLIFIERS**

SGLS182B – SEPTEMBER 2003 – REVISED NOVEMBER 2010

**operating characteristics at specified free-air temperature,  $V_{DD} = 3\text{ V}$**

PARAMETER	TEST CONDITIONS	$T_A^\dagger$	TLV243x-Q1, TLV243xA-Q1			UNIT
			MIN	TYP	MAX	
SR Slew rate at unity gain	$V_O = 1\text{ V to }2\text{ V},$ $C_L = 100\text{ pF}^\ddagger$	$R_L = 2\text{ k}\Omega^\ddagger,$	25°C	0.15	0.25	V/ $\mu$ s
			Full range	0.1		
$V_n$ Equivalent input noise voltage	$f = 10\text{ Hz}$		25°C	120		nV/ $\sqrt{\text{Hz}}$
	$f = 1\text{ kHz}$		25°C	22		
$V_{N(PP)}$ Peak-to-peak equivalent input noise voltage	$f = 0.1\text{ Hz to }1\text{ Hz}$		25°C	2.7		$\mu$ V
	$f = 0.1\text{ Hz to }10\text{ Hz}$		25°C	4		
$I_n$ Equivalent input noise current			25°C	0.6		fA/ $\sqrt{\text{Hz}}$
THD + N Total harmonic distortion plus noise	$V_O = 0.5\text{ V to }2.5\text{ V},$ $f = 1\text{ kHz},$ $R_L = 2\text{ k}\Omega^\ddagger$	$A_V = 1$	25°C	0.065%		
		$A_V = 10$		0.5%		
Gain-bandwidth product	$f = 10\text{ kHz},$ $C_L = 100\text{ pF}^\ddagger$	$R_L = 2\text{ k}\Omega^\ddagger,$	25°C	0.5		MHz
$B_{OM}$ Maximum output-swing bandwidth	$V_{O(PP)} = 1\text{ V},$ $R_L = 2\text{ k}\Omega^\ddagger,$	$A_V = 1,$ $C_L = 100\text{ pF}^\ddagger$	25°C	220		kHz
$t_s$ Settling time	$A_V = -1,$ Step = 0.5 V to 2.5 V, $R_L = 2\text{ k}\Omega^\ddagger,$ $C_L = 100\text{ pF}^\ddagger$	$T_o = 0.1\%$	25°C	6.4		$\mu$ s
		$T_o = 0.01\%$		14.1		
$\phi_m$ Phase margin at unity gain			25°C	62°		
Gain margin	$R_L = 2\text{ k}\Omega^\ddagger,$	$C_L = 100\text{ pF}^\ddagger$	25°C	11		dB

<sup>†</sup> Full range is  $-40^\circ\text{C}$  to  $125^\circ\text{C}$  for Q level part.

<sup>‡</sup> Referenced to 2.5 V



**TLV2432-Q1, TLV2432A-Q1, TLV2434-Q1, TLV2434A-Q1**  
**Advanced LinCMOS™ RAIL-TO-RAIL OUTPUT**  
**WIDE-INPUT-VOLTAGE OPERATIONAL AMPLIFIERS**

SGLS182B – SEPTEMBER 2003 – REVISED NOVEMBER 2010

**electrical characteristics at specified free-air temperature,  $V_{DD} = 5\text{ V}$  (unless otherwise noted)**

PARAMETER	TEST CONDITIONS		$T_A^\dagger$	TLV243x-Q1			UNIT
				MIN	TYP	MAX	
$V_{IO}$ Input offset voltage	$V_{IC} = 0,$ $V_O = 0,$ $V_{DD} \pm = \pm 2.5\text{ V},$ $R_S = 50\ \Omega$	TLV243x	25°C	300	2000	$\mu\text{V}$	
			Full range	2500			
		TLV243xA	25°C	300	950		
			Full range	2000			
$\alpha_{V_{IO}}$ Temperature coefficient of input offset voltage	$V_{IC} = 0,$ $V_O = 0,$ $V_{DD} \pm = \pm 2.5\text{ V},$ $R_S = 50\ \Omega$		25°C to 70°C	2		$\mu\text{V}/^\circ\text{C}$	
Input offset voltage long-term drift (see Note 4)			25°C	0.003		$\mu\text{V}/\text{mo}$	
$I_{IO}$ Input offset current			25°C	0.5		$\text{pA}$	
			Full range	150			
$I_{IB}$ Input bias current			25°C	1		$\text{pA}$	
			Full range	300			
$V_{ICR}$ Common-mode input voltage range	$ V_{IO}  \leq 5\text{ mV},$ $R_S = 50\ \Omega$		25°C	0 to 4.5	-0.25 to 4.75	V	
			Full range	0 to 4.2			
$V_{OH}$ High-level output voltage	$I_{OH} = -100\ \mu\text{A}$		25°C	4.97		V	
			Full range	25°C	4		4.35
				4			
$V_{OL}$ Low-level output voltage	$V_{IC} = 2.5\text{ V},$ $I_{OL} = 100\ \mu\text{A}$		25°C	0.01		V	
			25°C	0.8			
	Full range	1.25					
$A_{VD}$ Large-signal differential voltage amplification	$V_{IC} = 2.5\text{ V},$ $V_O = 1\text{ V to }4\text{ V}$	$R_L = 2\text{ k}\Omega^\ddagger$	25°C	2.5	3.8	V/mV	
		$R_L = 1\text{ M}\Omega^\ddagger$	Full range	0.5			
			25°C	950			
$r_{i(d)}$ Differential input resistance			25°C	1000		$\text{G}\Omega$	
$r_{i(c)}$ Common-mode input resistance			25°C	1000		$\text{G}\Omega$	
$c_{i(c)}$ Common-mode input capacitance	$f = 10\text{ kHz}$		25°C	8		$\text{pF}$	
$z_o$ Closed-loop output impedance	$f = 100\text{ kHz},$ $A_V = 10$		25°C	130		$\Omega$	
CMRR Common-mode rejection ratio	$V_{IC} = V_{ICR\text{ MIN}},$ $V_O = 2.5\text{ V},$ $R_S = 50\ \Omega$		25°C	70	90	dB	
			Full range	70			
$k_{SVR}$ Supply-voltage rejection ratio ( $\Delta V_{DD}/\Delta V_{IO}$ )	$V_{DD} = 4.4\text{ V to }8\text{ V},$ $V_{IC} = V_{DD}/2,$ No load		25°C	80	95	dB	
			Full range	80			
$I_{DD}$ Supply current	$V_O = 2.5\text{ V},$ No load		25°C	200	250	$\mu\text{A}$	
			Full range	270			

$^\dagger$  Full range is  $-40^\circ\text{C}$  to  $125^\circ\text{C}$  for Q level part.

$^\ddagger$  Referenced to 2.5 V

NOTE 4: Typical values are based on the input offset voltage shift observed through 500 hours of operating life test at  $T_A = 150^\circ\text{C}$  extrapolated to  $T_A = 25^\circ\text{C}$  using the Arrhenius equation and assuming an activation energy of 0.96 eV.



**TLV2432-Q1, TLV2432A-Q1, TLV2434-Q1, TLV2434A-Q1**  
**Advanced LinCMOS™ RAIL-TO-RAIL OUTPUT**  
**WIDE-INPUT-VOLTAGE OPERATIONAL AMPLIFIERS**

SGLS182B – SEPTEMBER 2003 – REVISED NOVEMBER 2010

**operating characteristics at specified free-air temperature,  $V_{DD} = 5\text{ V}$**

PARAMETER	TEST CONDITIONS	$T_A^\dagger$	TLV243x-Q1, TLV243xA-Q1			UNIT
			MIN	TYP	MAX	
SR Slew rate at unity gain	$V_O = 1.5\text{ V to }3.5\text{ V},$ $R_L = 2\text{ k}\Omega^\ddagger,$ $C_L = 100\text{ pF}^\ddagger$	25°C	0.15	0.25		V/ $\mu\text{s}$
		Full range	0.1			
$V_n$ Equivalent input noise voltage	$f = 10\text{ Hz}$	25°C	100		nV/ $\sqrt{\text{Hz}}$	
	$f = 1\text{ kHz}$	25°C	18			
$V_{N(PP)}$ Peak-to-peak equivalent input noise voltage	$f = 0.1\text{ Hz to }1\text{ Hz}$	25°C	1.9		$\mu\text{V}$	
	$f = 0.1\text{ Hz to }10\text{ Hz}$	25°C	2.8			
$I_n$ Equivalent input noise current		25°C	0.6		fA/ $\sqrt{\text{Hz}}$	
THD + N Total harmonic distortion plus noise	$V_O = 1.5\text{ V to }3.5\text{ V},$ $f = 1\text{ kHz},$ $R_L = 2\text{ k}\Omega^\ddagger$	$A_V = 1$	0.045%			
		$A_V = 10$	0.4%			
Gain-bandwidth product	$f = 10\text{ kHz},$ $C_L = 100\text{ pF}^\ddagger$	$R_L = 2\text{ k}\Omega^\ddagger,$ 25°C	0.55		MHz	
$B_{OM}$ Maximum output-swing bandwidth	$V_{O(PP)} = 2\text{ V},$ $R_L = 2\text{ k}\Omega^\ddagger,$	$A_V = 1,$ $C_L = 100\text{ pF}^\ddagger$ 25°C	100		kHz	
$t_s$ Settling time	$A_V = -1,$ Step = 1.5 V to 3.5 V, $R_L = 2\text{ k}\Omega^\ddagger,$ $C_L = 100\text{ pF}^\ddagger$	$T_o = 0.1\%$	6.4		$\mu\text{s}$	
		$T_o = 0.01\%$	13.1			
$\phi_m$ Phase margin at unity gain	$R_L = 2\text{ k}\Omega^\ddagger,$ $C_L = 100\text{ pF}^\ddagger$	25°C	66°			
Gain margin		25°C	11		dB	

$^\dagger$  Full range is  $-40^\circ\text{C}$  to  $125^\circ\text{C}$  for Q level part.

$^\ddagger$  Referenced to 2.5 V





**TLV2432-Q1, TLV2432A-Q1, TLV2434-Q1, TLV2434A-Q1**  
**Advanced LinCMOS™ RAIL-TO-RAIL OUTPUT**  
**WIDE-INPUT-VOLTAGE OPERATIONAL AMPLIFIERS**

SGLS182B – SEPTEMBER 2003 – REVISED NOVEMBER 2010

**TYPICAL CHARACTERISTICS**

**Table of Graphs**

			FIGURE
$V_{IO}$	Input offset voltage	Distribution vs Common-mode input voltage	2,3 4,5
$\alpha_{VIO}$	Temperature coefficient	Distribution	6,7
$I_{IB}/I_{IO}$	Input bias and input offset currents	vs Free-air temperature	8
$V_{OH}$	High-level output voltage	vs High-level output current	9,11
$V_{OL}$	Low-level output voltage	vs Low-level output current	10,12
$V_{O(PP)}$	Maximum peak-to-peak output voltage	vs Frequency	13
$I_{OS}$	Short-circuit output current	vs Supply voltage	14
		vs Free-air temperature	15
$V_{ID}$	Differential input voltage	vs Output voltage	16,17
	Differential gain	vs Load resistance	18
$A_{VD}$	Large-signal differential voltage amplification	vs Frequency	19,20
$A_{VD}$	Differential voltage amplification	vs Free-air temperature	21,22
$z_o$	Output impedance	vs Frequency	23,24
CMRR	Common-mode rejection ratio	vs Frequency	25
		vs Free-air temperature	26
$k_{SVR}$	Supply-voltage rejection ratio	vs Frequency	27,28
		vs Free-air temperature	29
$I_{DD}$	Supply current	vs Supply voltage	30
SR	Slew rate	vs Load capacitance	31
		vs Free-air temperature	32
$V_O$	Inverting large-signal pulse response		33,34
$V_O$	Voltage-follower large-signal pulse response		35,36
$V_O$	Inverting small-signal pulse response		37,38
$V_O$	Voltage-follower small-signal pulse response		39,40
$V_n$	Equivalent input noise voltage	vs Frequency	41, 42
		Noise voltage (referred to input)	Over a 10-second period
THD + N	Total harmonic distortion plus noise	vs Frequency	44,45
		Gain-bandwidth product	vs Free-air temperature vs Supply voltage
$\phi_m$	Phase margin	vs Frequency	19,20
		vs Load capacitance	48
	Gain margin	vs Load capacitance	49
$B_1$	Unity-gain bandwidth	vs Load capacitance	50

**TLV2432-Q1, TLV2432A-Q1, TLV2434-Q1, TLV2434A-Q1**  
**Advanced LinCMOS™ RAIL-TO-RAIL OUTPUT**  
**WIDE-INPUT-VOLTAGE OPERATIONAL AMPLIFIERS**

SGLS182B – SEPTEMBER 2003 – REVISED NOVEMBER 2010

**TYPICAL CHARACTERISTICS**

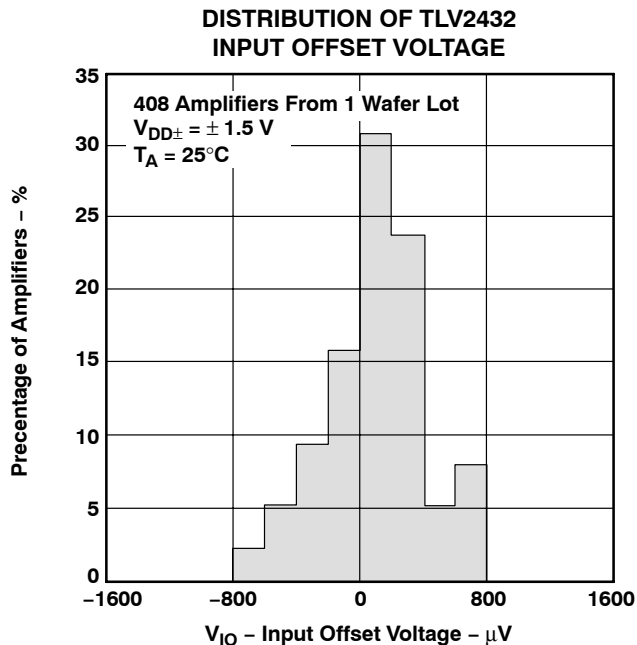

**Figure 2**

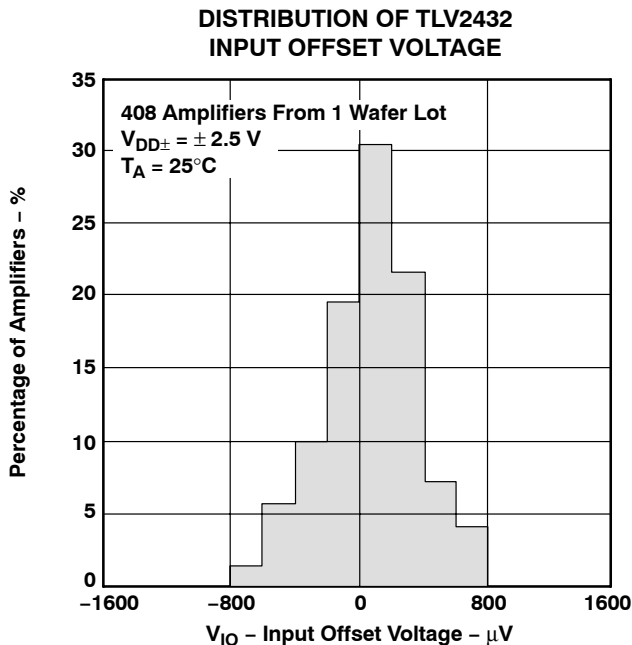

**Figure 3**

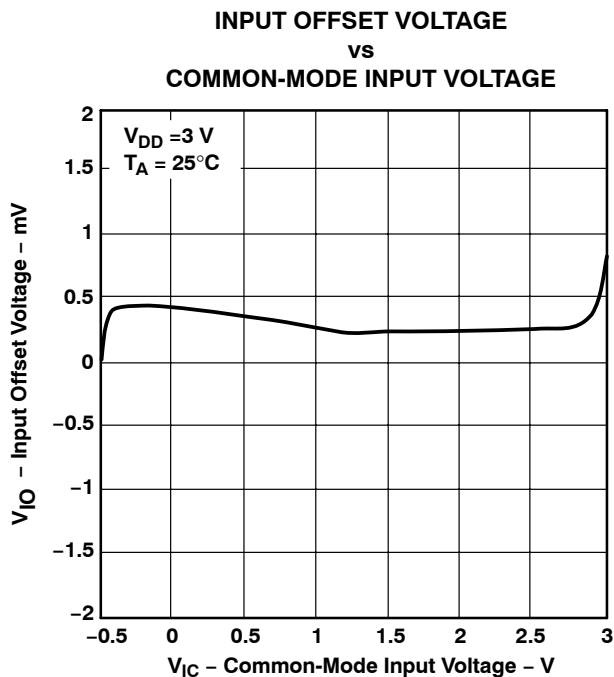

**Figure 4**

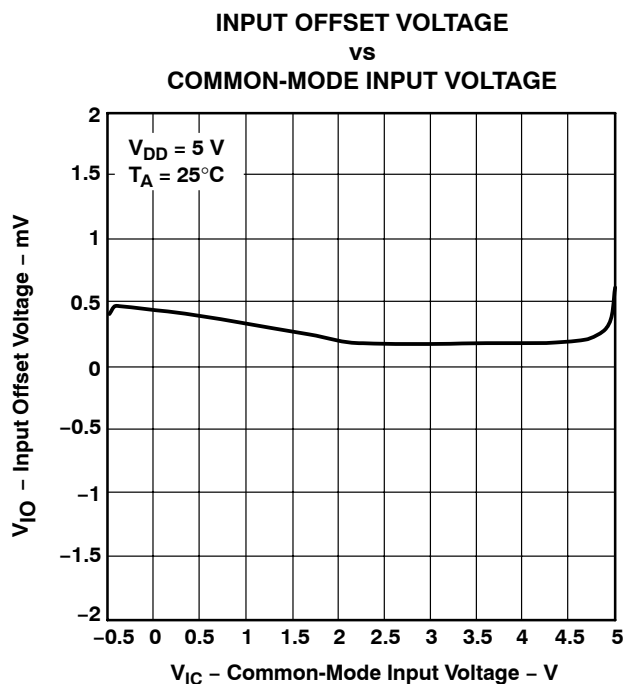

**Figure 5**



TLV2432-Q1, TLV2432A-Q1, TLV2434-Q1, TLV2434A-Q1  
 Advanced LinCMOS™ RAIL-TO-RAIL OUTPUT  
 WIDE-INPUT-VOLTAGE OPERATIONAL AMPLIFIERS

SGLS182B – SEPTEMBER 2003 – REVISED NOVEMBER 2010

TYPICAL CHARACTERISTICS

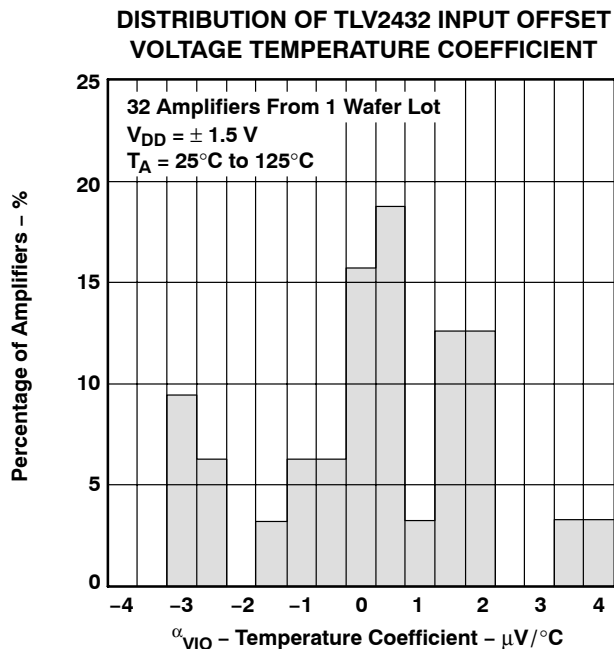

Figure 6

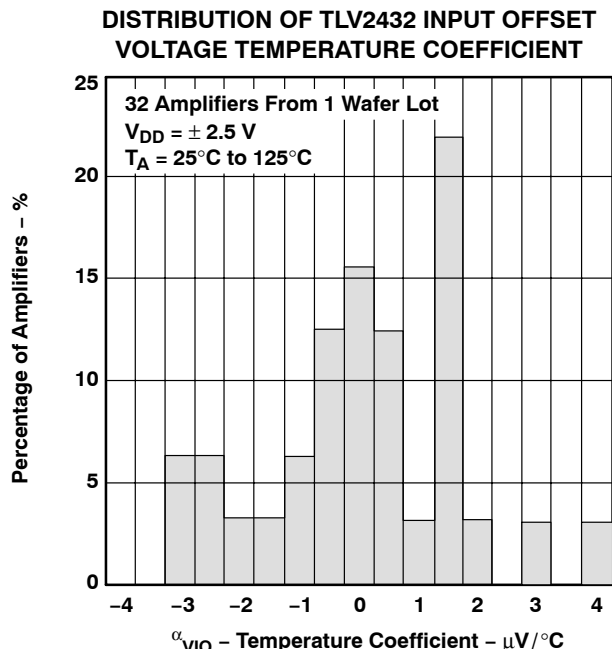

Figure 7

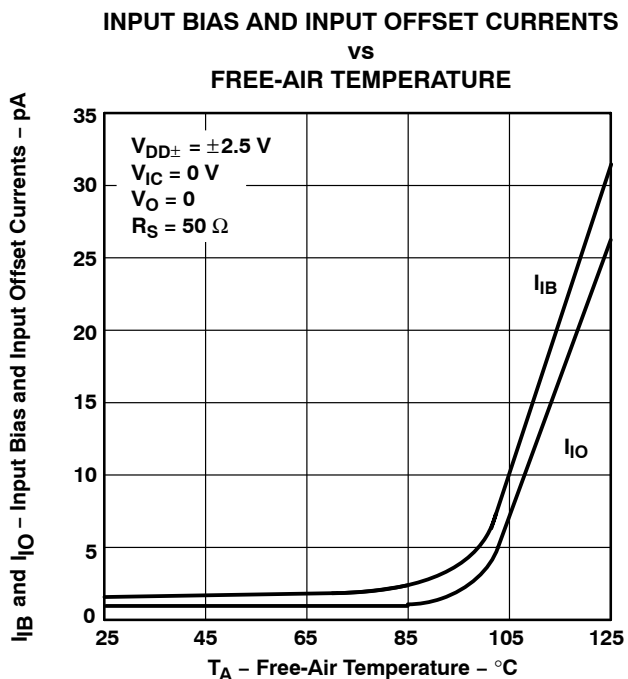

Figure 8

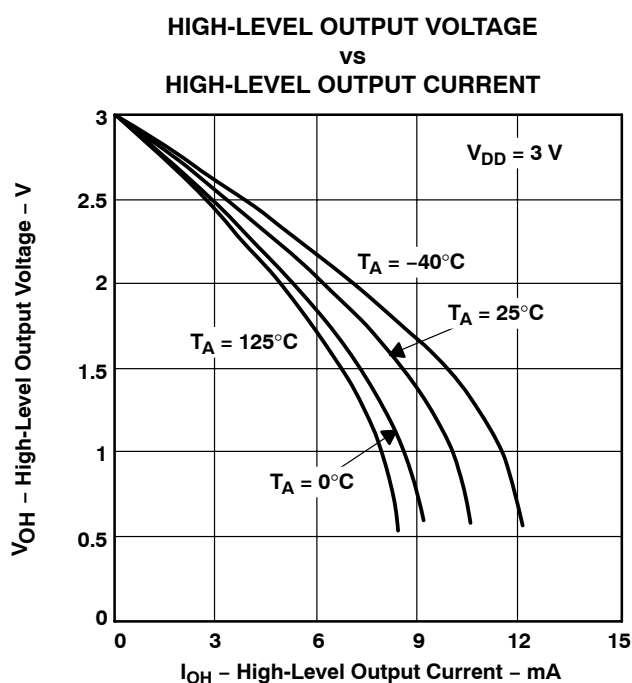
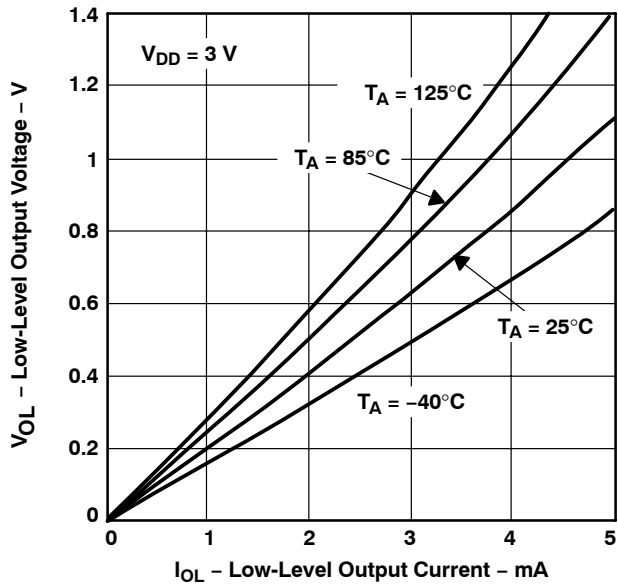

Figure 9

**TYPICAL CHARACTERISTICS**

**LOW-LEVEL OUTPUT VOLTAGE  
vs  
LOW-LEVEL OUTPUT CURRENT**



**Figure 10**

**HIGH-LEVEL OUTPUT VOLTAGE  
vs  
HIGH-LEVEL OUTPUT CURRENT**

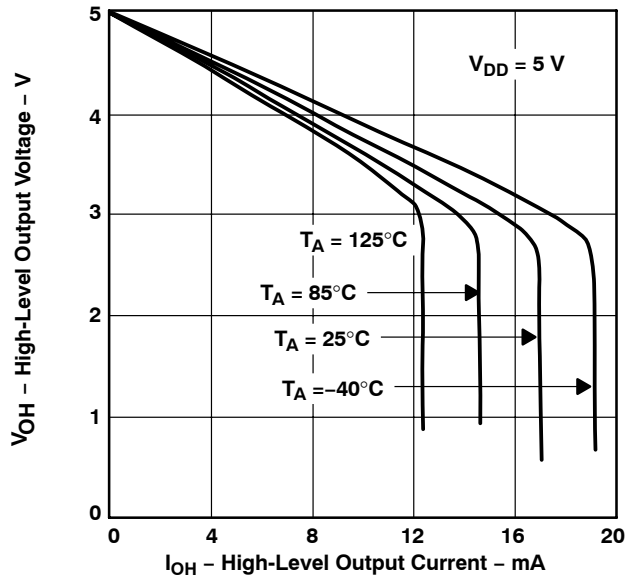

**Figure 11**

**LOW-LEVEL OUTPUT VOLTAGE  
vs  
LOW-LEVEL OUTPUT CURRENT**

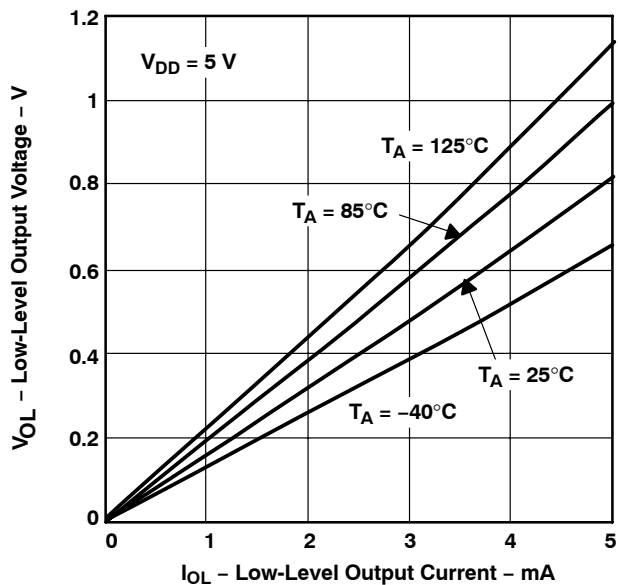

**Figure 12**

**MAXIMUM PEAK-TO-PEAK OUTPUT VOLTAGE  
vs  
FREQUENCY**

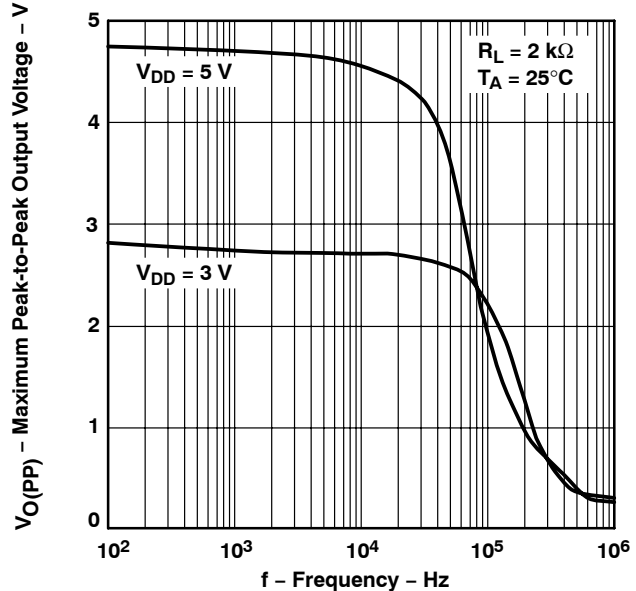

**Figure 13**

TLV2432-Q1, TLV2432A-Q1, TLV2434-Q1, TLV2434A-Q1  
 Advanced LinCMOS™ RAIL-TO-RAIL OUTPUT  
 WIDE-INPUT-VOLTAGE OPERATIONAL AMPLIFIERS

SGLS182B – SEPTEMBER 2003 – REVISED NOVEMBER 2010

TYPICAL CHARACTERISTICS

SHORT-CIRCUIT OUTPUT CURRENT  
 vs  
 SUPPLY VOLTAGE

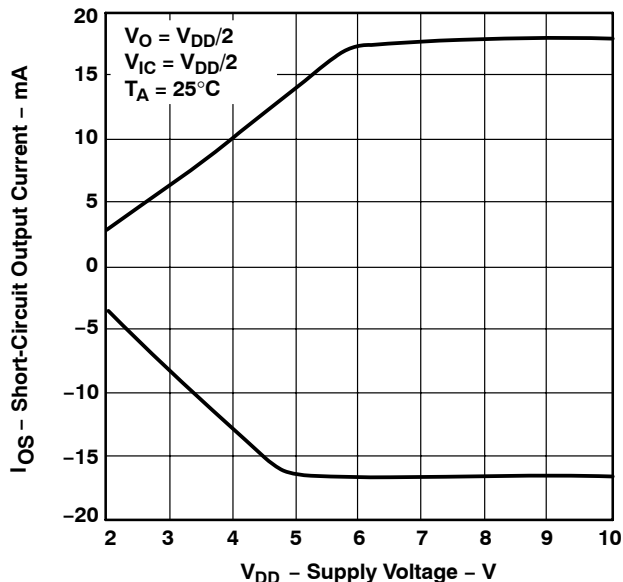

Figure 14

SHORT-CIRCUIT OUTPUT CURRENT  
 vs  
 FREE-AIR TEMPERATURE

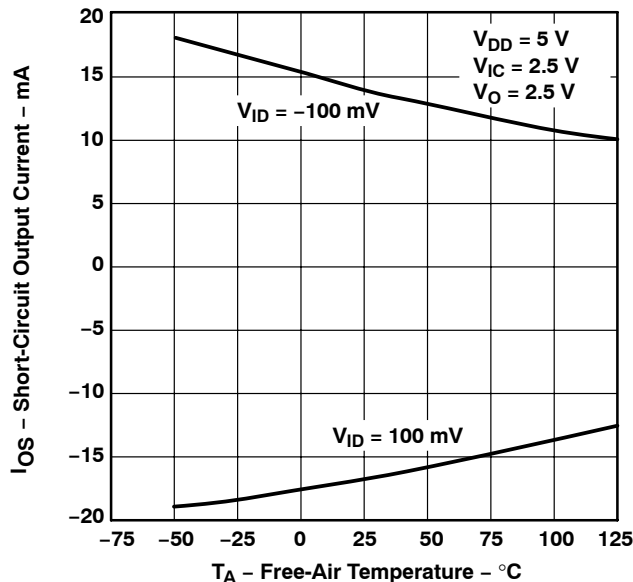

Figure 15

DIFFERENTIAL INPUT VOLTAGE  
 vs  
 OUTPUT VOLTAGE

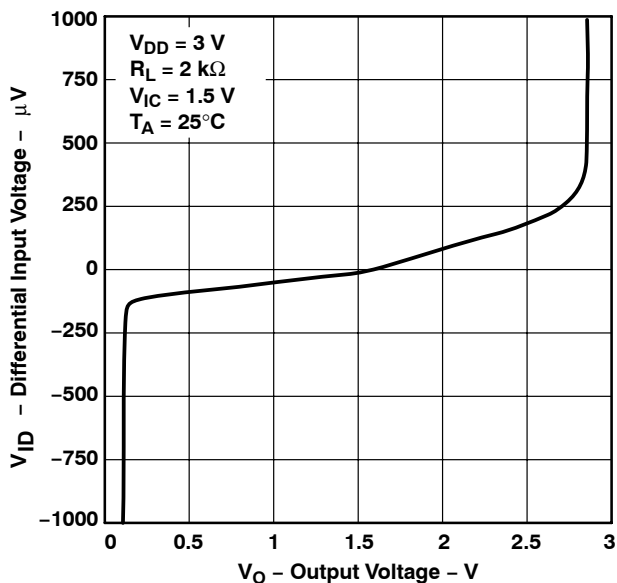

Figure 16

DIFFERENTIAL INPUT VOLTAGE  
 vs  
 OUTPUT VOLTAGE

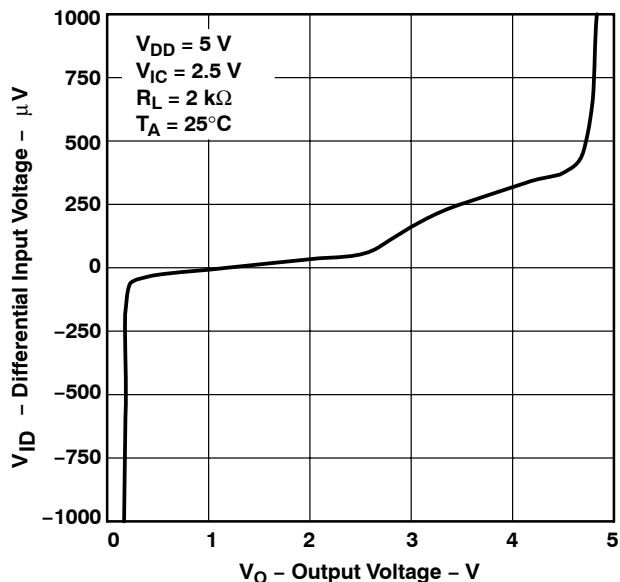
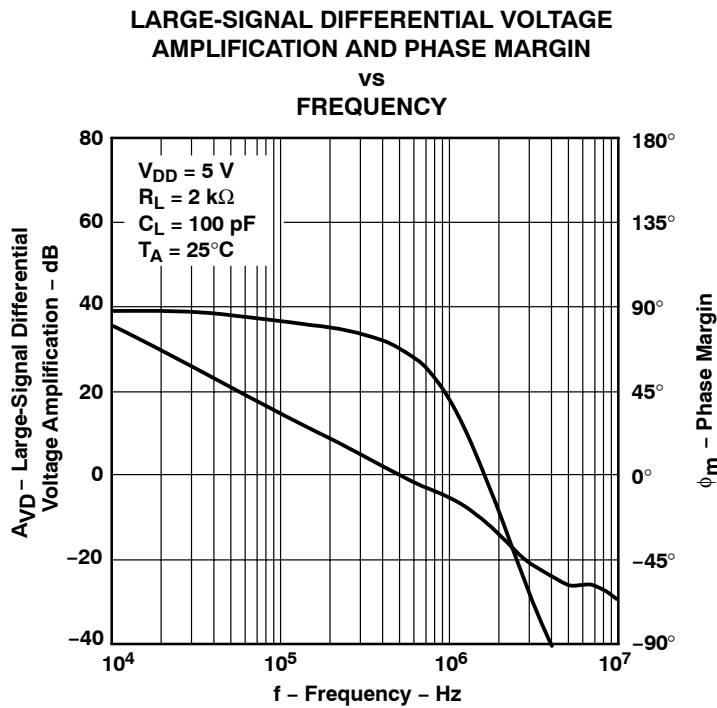
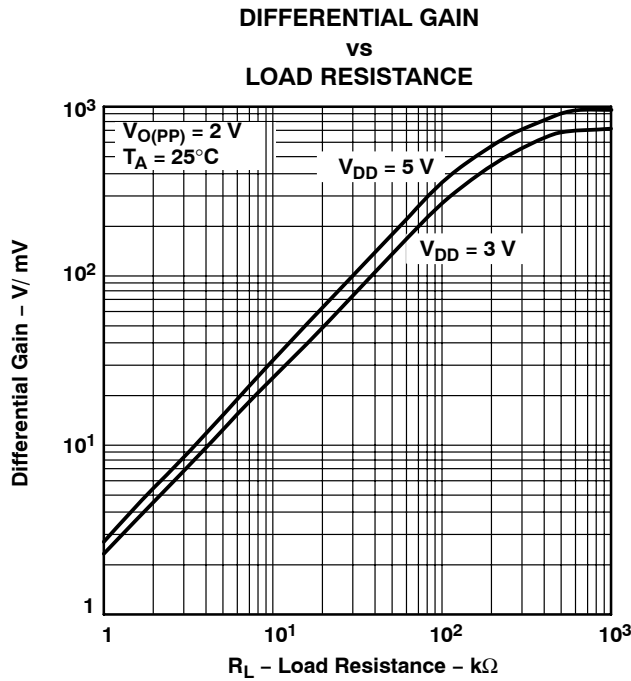

Figure 17



**TYPICAL CHARACTERISTICS**



TLV2432-Q1, TLV2432A-Q1, TLV2434-Q1, TLV2434A-Q1  
 Advanced LinCMOS™ RAIL-TO-RAIL OUTPUT  
 WIDE-INPUT-VOLTAGE OPERATIONAL AMPLIFIERS

SGLS182B – SEPTEMBER 2003 – REVISED NOVEMBER 2010

TYPICAL CHARACTERISTICS

LARGE-SIGNAL DIFFERENTIAL VOLTAGE  
 AMPLIFICATION AND PHASE MARGIN

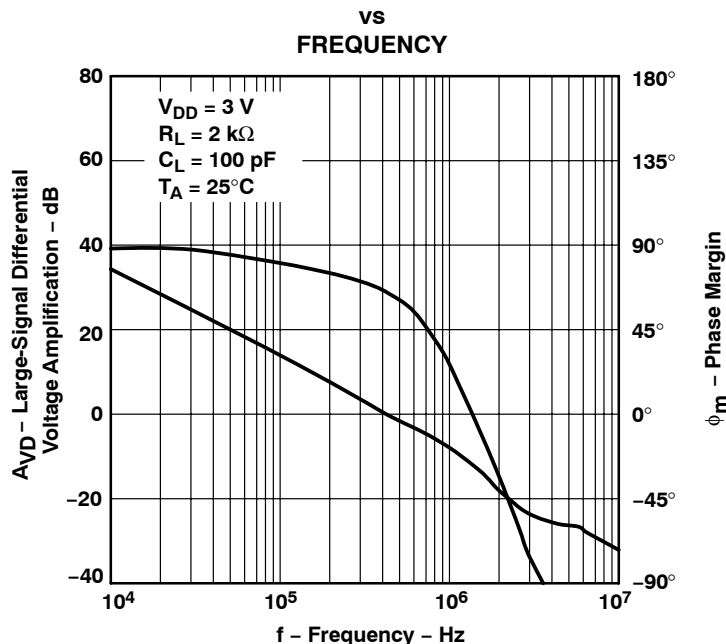

Figure 20

DIFFERENTIAL VOLTAGE AMPLIFICATION  
 vs  
 FREE-AIR TEMPERATURE

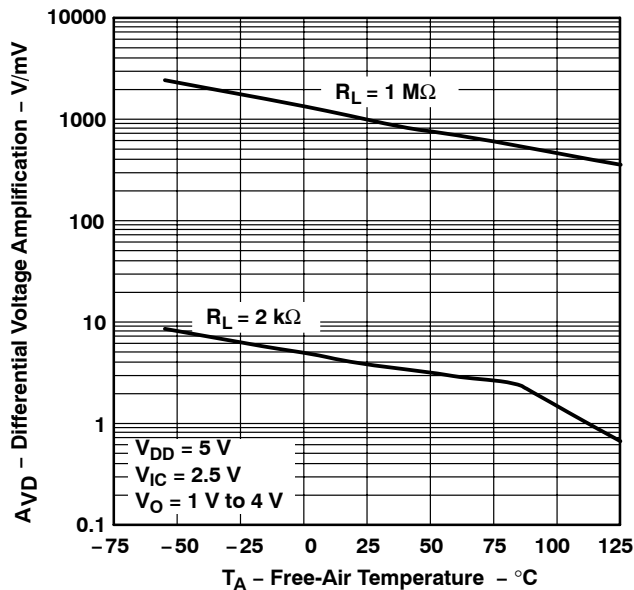

Figure 21

DIFFERENTIAL VOLTAGE AMPLIFICATION  
 vs  
 FREE-AIR TEMPERATURE

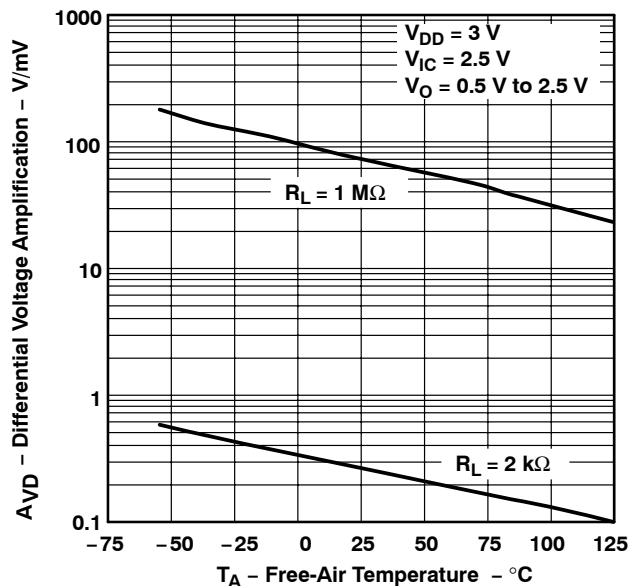
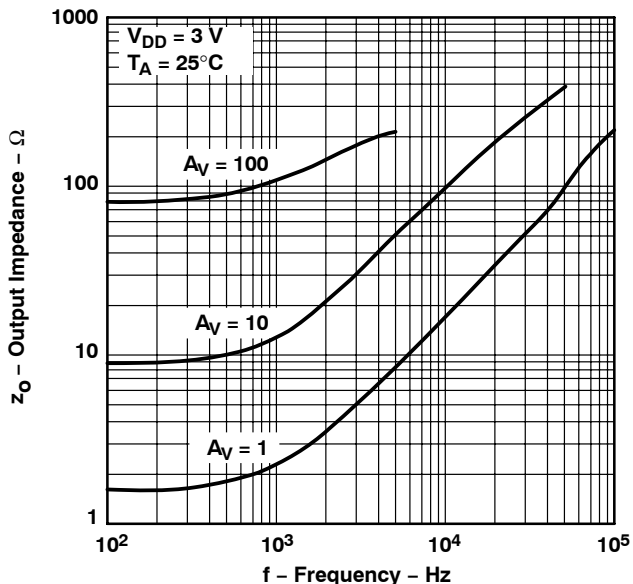

Figure 22

**TYPICAL CHARACTERISTICS**

**OUTPUT IMPEDANCE  
 vs  
 FREQUENCY**



**Figure 23**

**OUTPUT IMPEDANCE  
 vs  
 FREQUENCY**

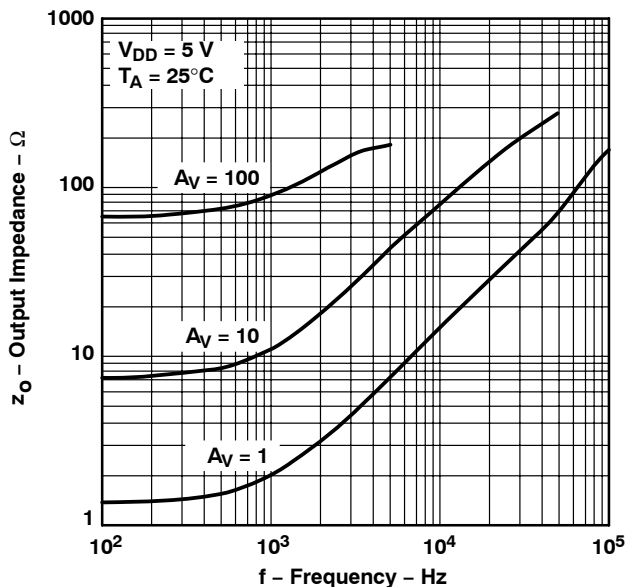

**Figure 24**

**COMMON-MODE REJECTION RATIO  
 vs  
 FREQUENCY**

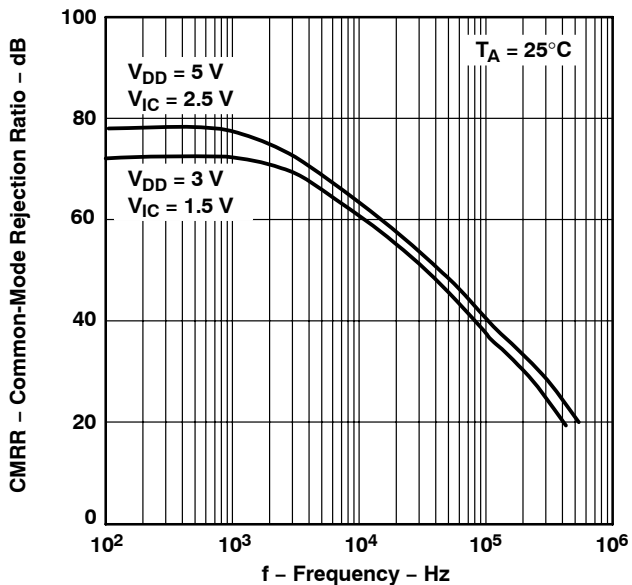

**Figure 25**

**COMMON-MODE REJECTION RATIO  
 vs  
 FREE-AIR TEMPERATURE**

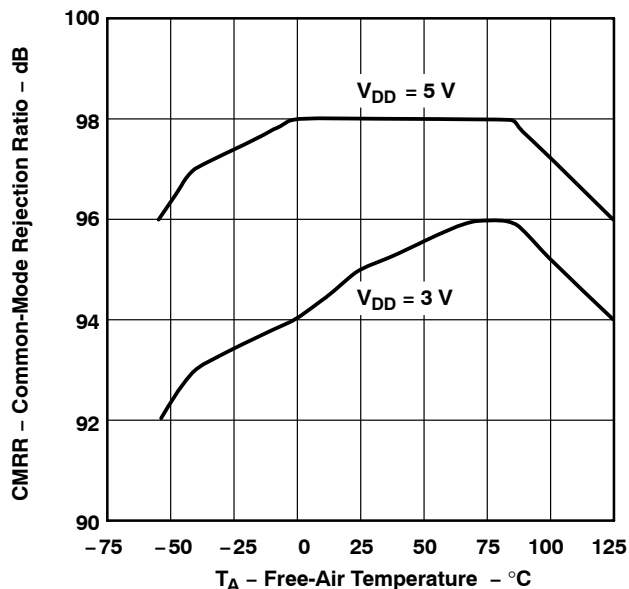

**Figure 26**



TLV2432-Q1, TLV2432A-Q1, TLV2434-Q1, TLV2434A-Q1  
 Advanced LinCMOS™ RAIL-TO-RAIL OUTPUT  
 WIDE-INPUT-VOLTAGE OPERATIONAL AMPLIFIERS

SGLS182B – SEPTEMBER 2003 – REVISED NOVEMBER 2010

TYPICAL CHARACTERISTICS

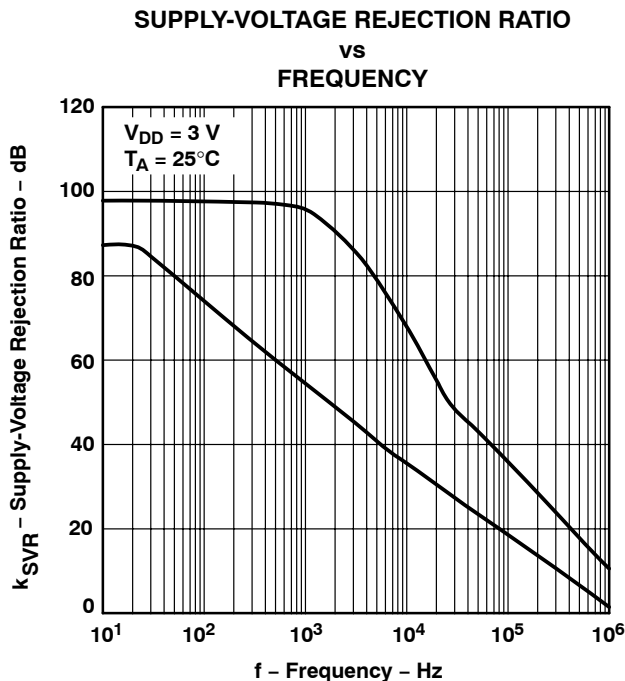

Figure 27

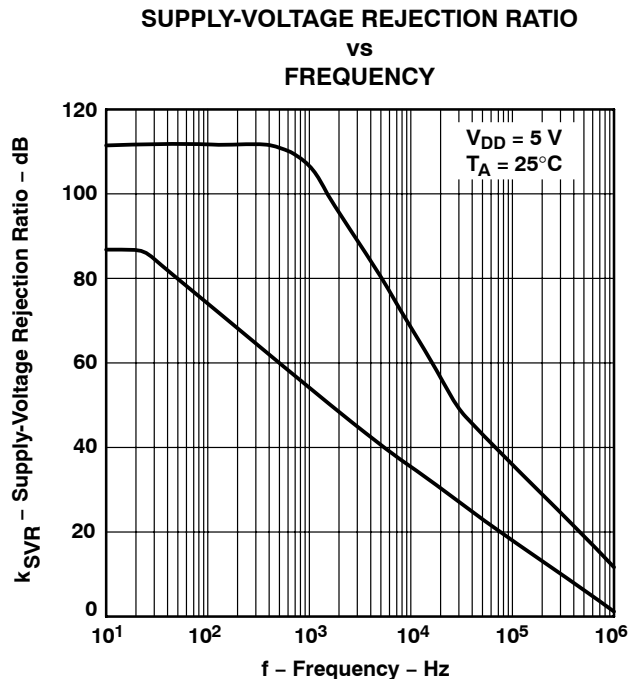

Figure 28

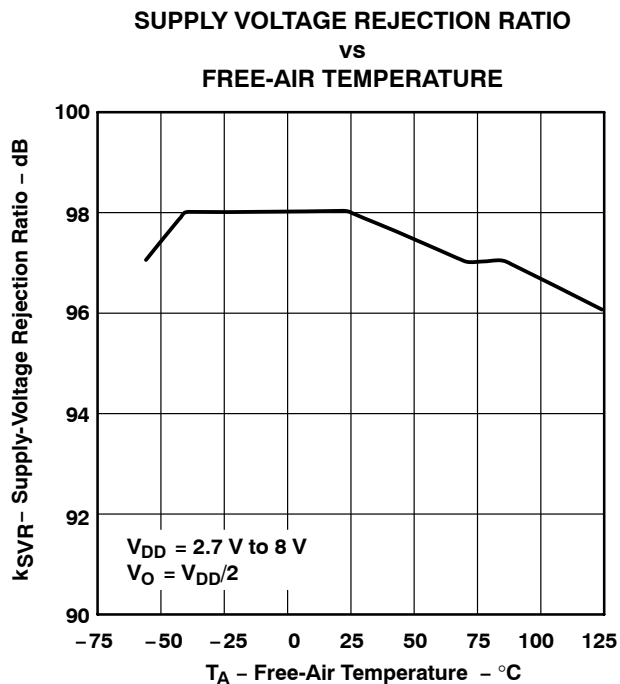

Figure 29

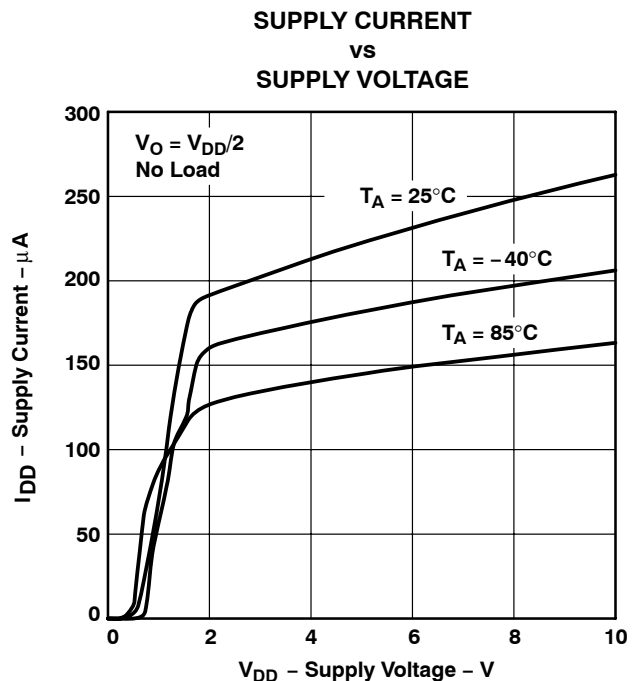
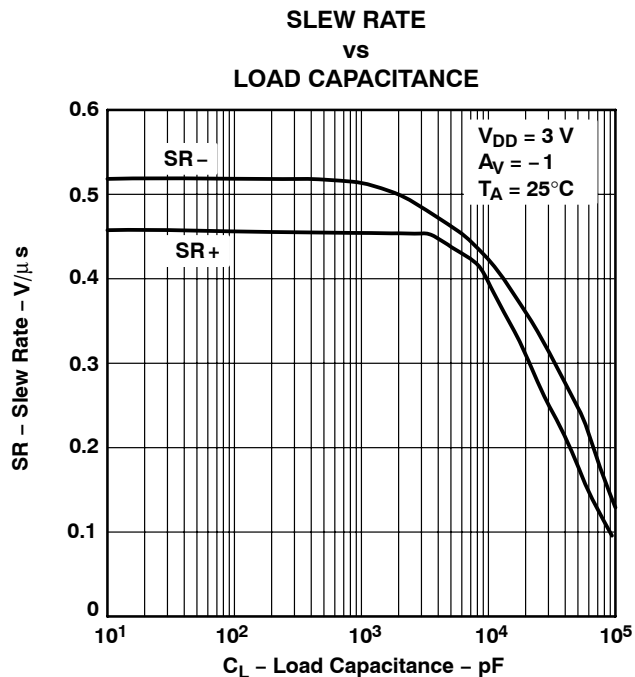

Figure 30

**TLV2432-Q1, TLV2432A-Q1, TLV2434-Q1, TLV2434A-Q1**  
**Advanced LinCMOS™ RAIL-TO-RAIL OUTPUT**  
**WIDE-INPUT-VOLTAGE OPERATIONAL AMPLIFIERS**

SGLS182B – SEPTEMBER 2003 – REVISED NOVEMBER 2010

**TYPICAL CHARACTERISTICS**



**Figure 31**

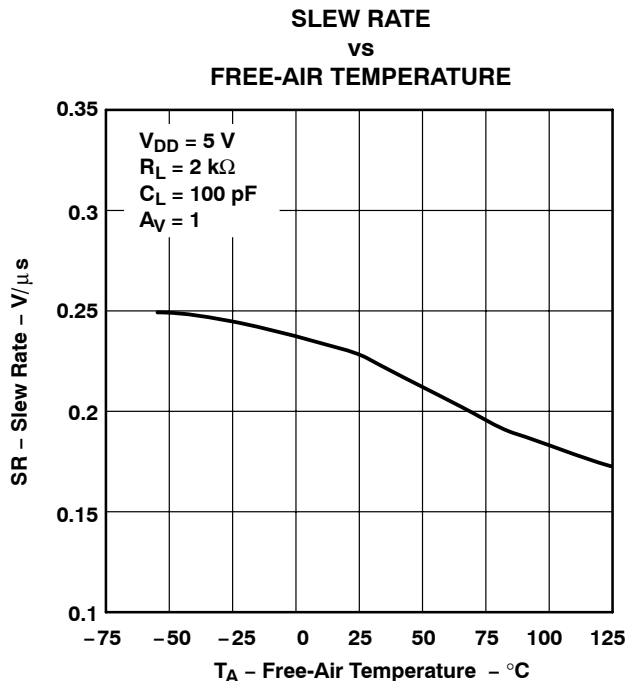

**Figure 32**

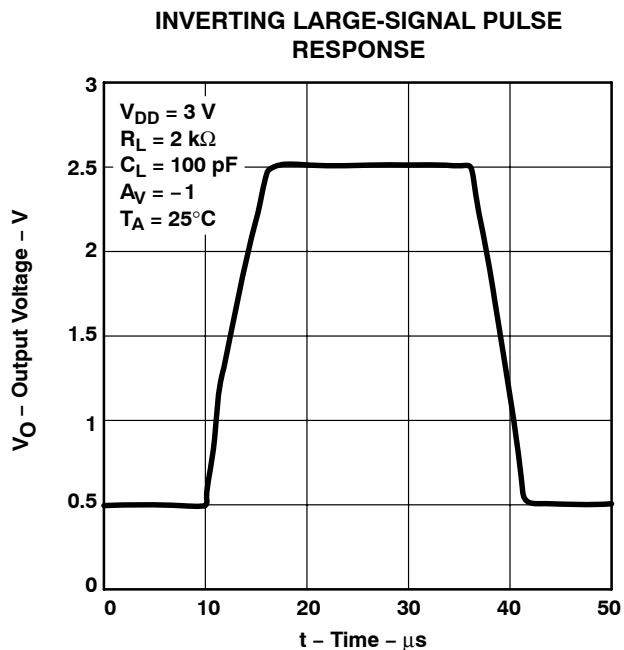

**Figure 33**

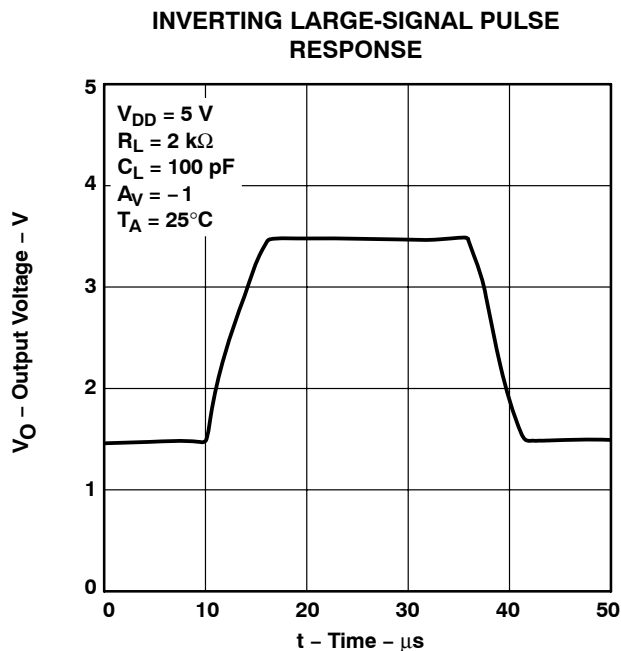

**Figure 34**



TYPICAL CHARACTERISTICS

VOLTAGE-FOLLOWER LARGE-SIGNAL PULSE RESPONSE

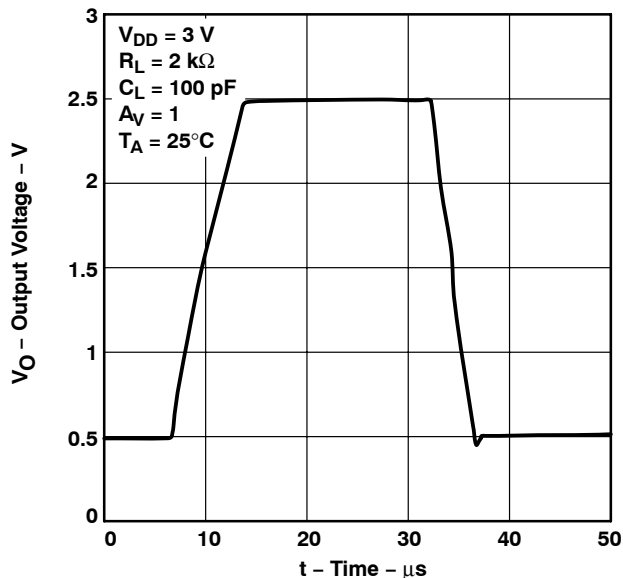

Figure 35

VOLTAGE-FOLLOWER LARGE-SIGNAL PULSE RESPONSE

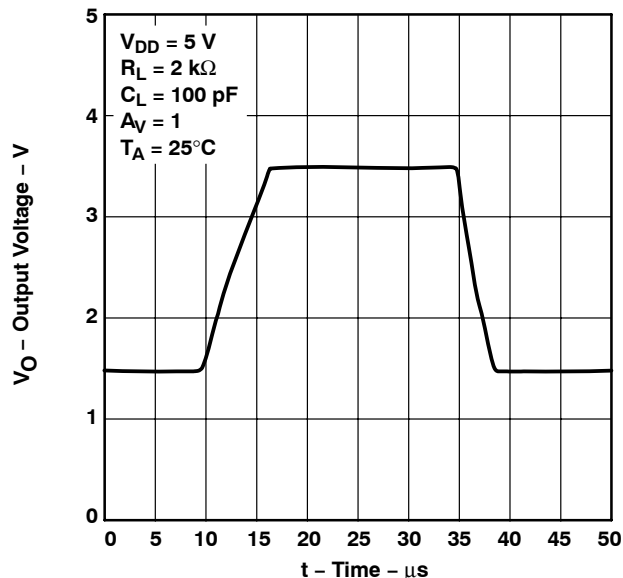

Figure 36

INVERTING SMALL-SIGNAL PULSE RESPONSE

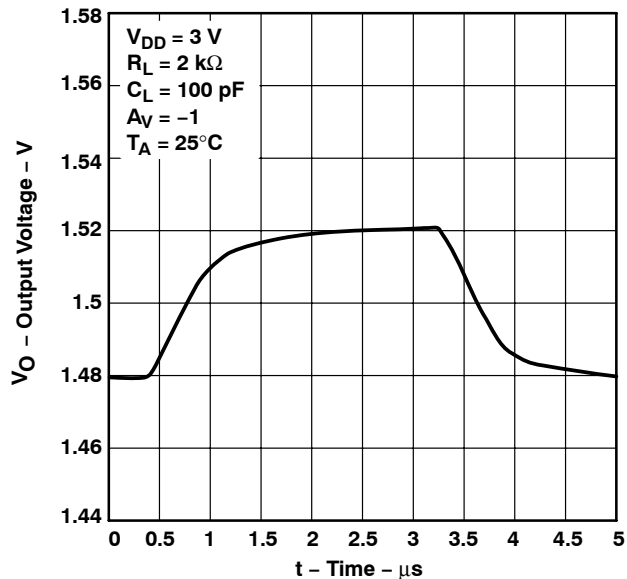

Figure 37

INVERTING SMALL-SIGNAL PULSE RESPONSE

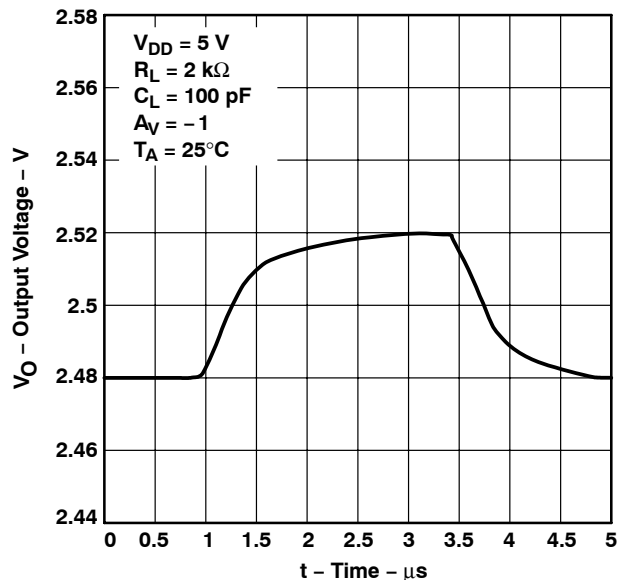

Figure 38

**TLV2432-Q1, TLV2432A-Q1, TLV2434-Q1, TLV2434A-Q1**  
**Advanced LinCMOS™ RAIL-TO-RAIL OUTPUT**  
**WIDE-INPUT-VOLTAGE OPERATIONAL AMPLIFIERS**

SGLS182B – SEPTEMBER 2003 – REVISED NOVEMBER 2010

**TYPICAL CHARACTERISTICS**

**VOLTAGE-FOLLOWER SMALL-SIGNAL PULSE RESPONSE**

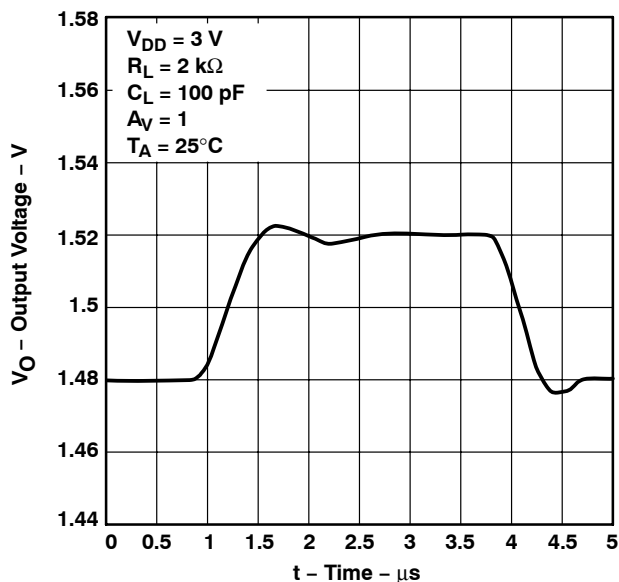

**Figure 39**

**VOLTAGE-FOLLOWER SMALL-SIGNAL PULSE RESPONSE**

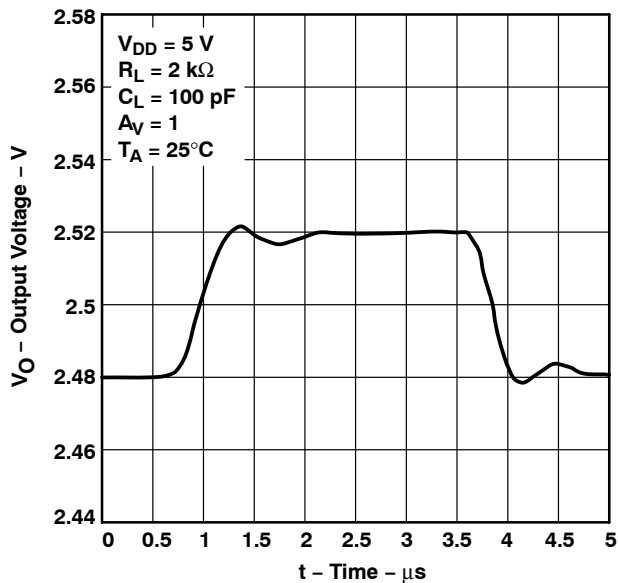

**Figure 40**

**EQUIVALENT INPUT NOISE VOLTAGE VS FREQUENCY**

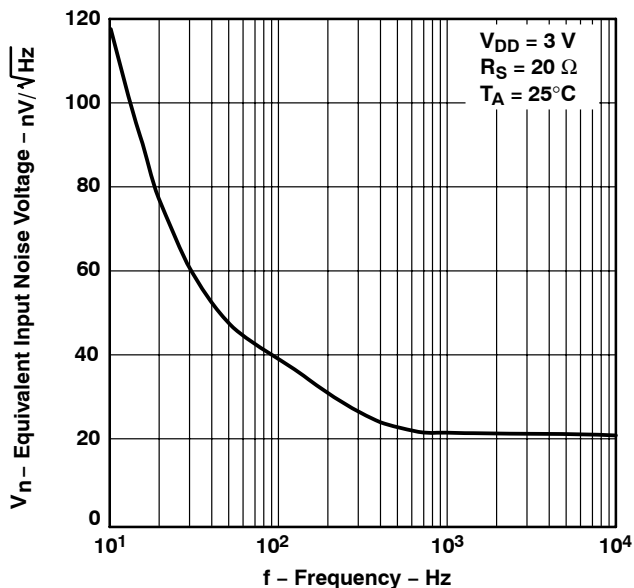

**Figure 41**

**EQUIVALENT INPUT NOISE VOLTAGE VS FREQUENCY**

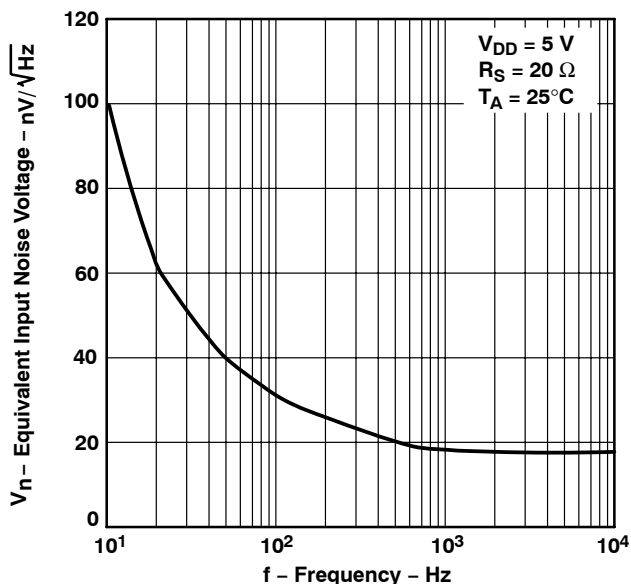

**Figure 42**



TLV2432-Q1, TLV2432A-Q1, TLV2434-Q1, TLV2434A-Q1  
 Advanced LinCMOS™ RAIL-TO-RAIL OUTPUT  
 WIDE-INPUT-VOLTAGE OPERATIONAL AMPLIFIERS

SGLS182B – SEPTEMBER 2003 – REVISED NOVEMBER 2010

TYPICAL CHARACTERISTICS

NOISE VOLTAGE OVER A 10-SECOND PERIOD

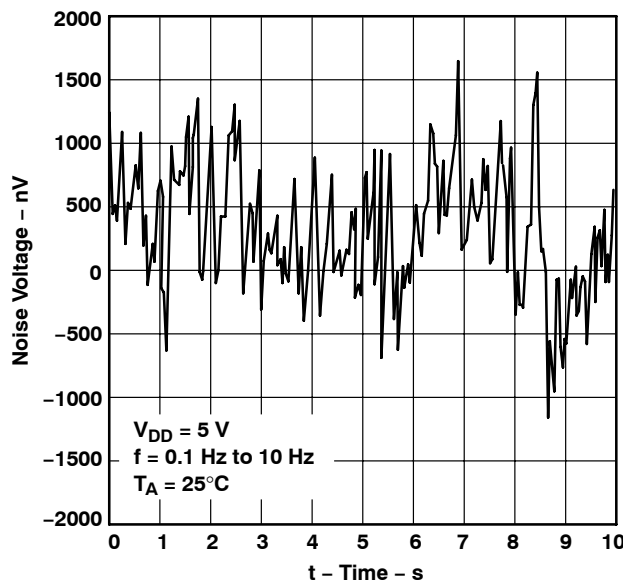

Figure 43

TOTAL HARMONIC DISTORTION PLUS NOISE  
 vs  
 FREQUENCY

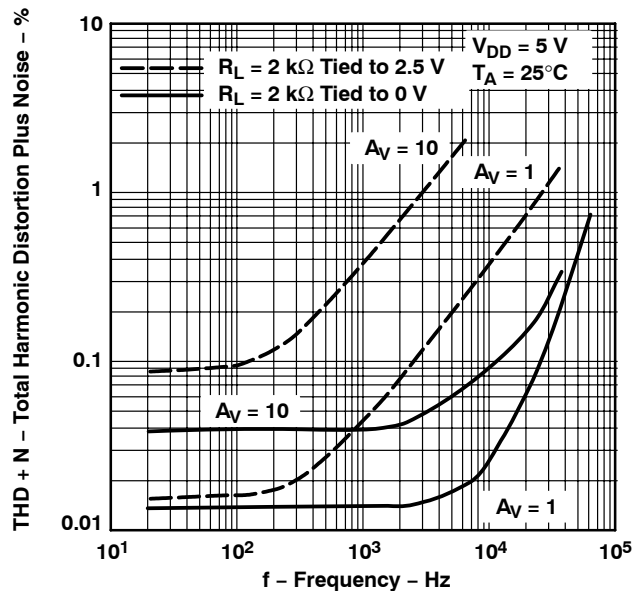

Figure 44

TOTAL HARMONIC DISTORTION PLUS NOISE  
 vs  
 FREQUENCY

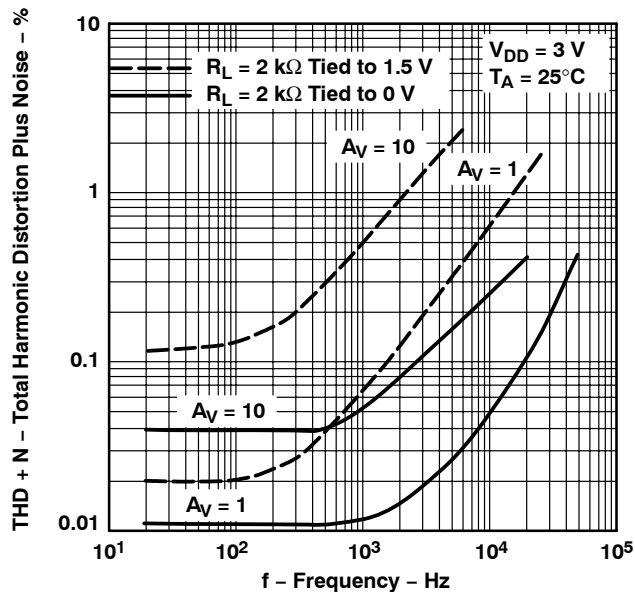
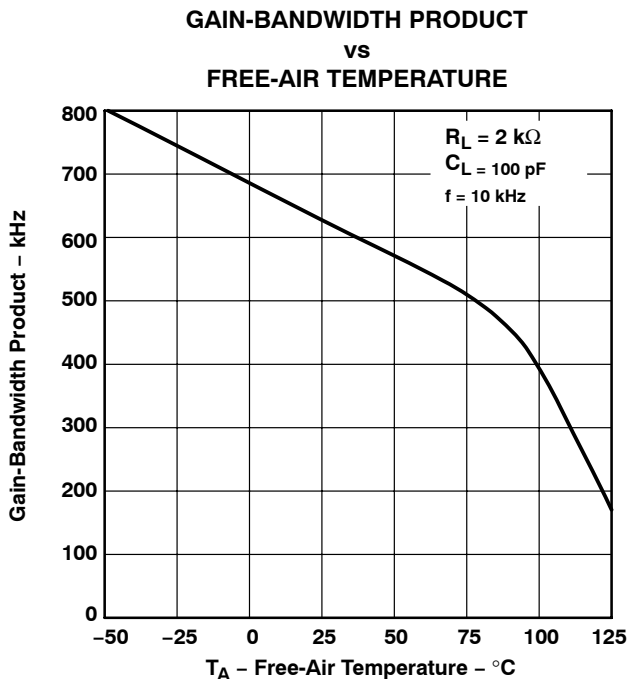
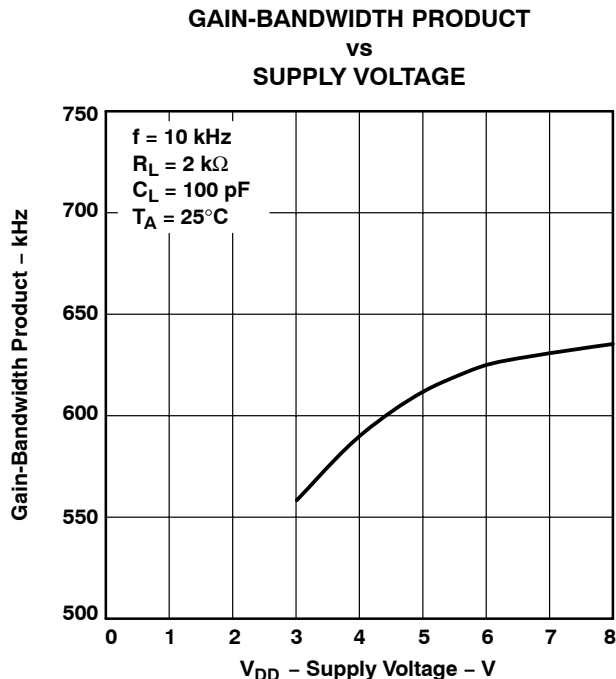

Figure 45

**TYPICAL CHARACTERISTICS**



**Figure 46**



**Figure 47**

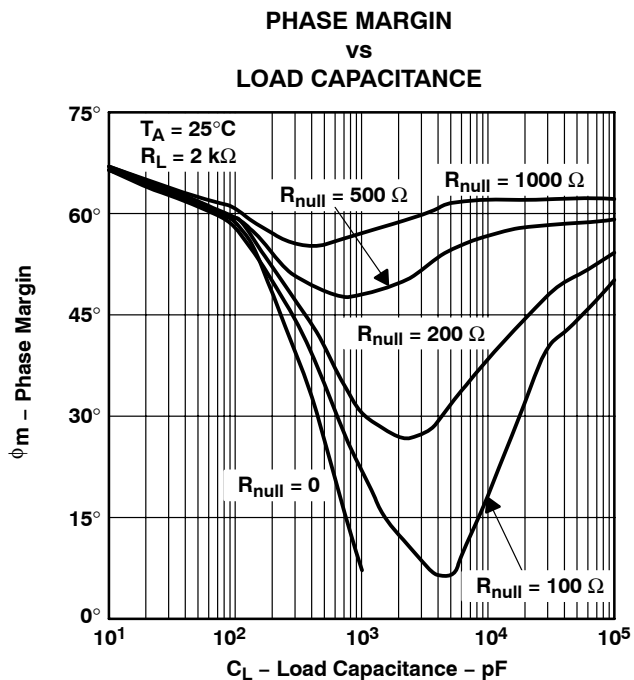

**Figure 48**

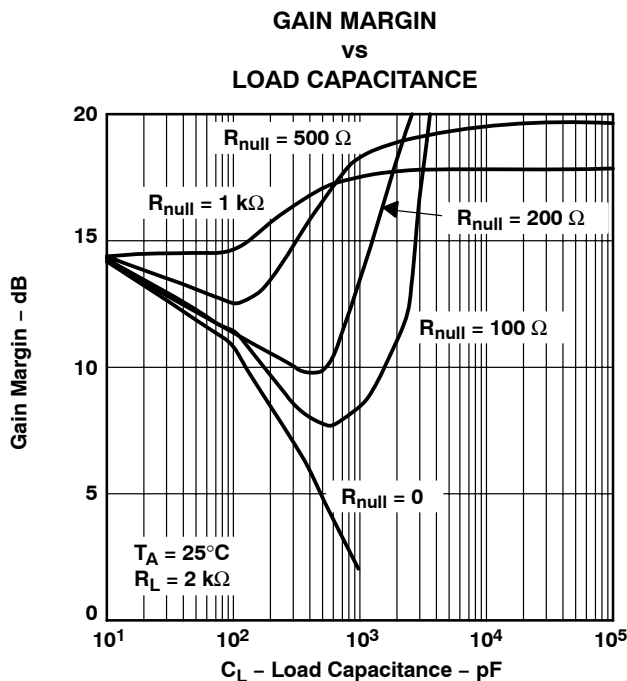

**Figure 49**

TLV2432-Q1, TLV2432A-Q1, TLV2434-Q1, TLV2434A-Q1  
Advanced LinCMOS™ RAIL-TO-RAIL OUTPUT  
WIDE-INPUT-VOLTAGE OPERATIONAL AMPLIFIERS

SGLS182B – SEPTEMBER 2003 – REVISED NOVEMBER 2010

TYPICAL CHARACTERISTICS

UNITY-GAIN BANDWIDTH  
vs  
LOAD CAPACITANCE

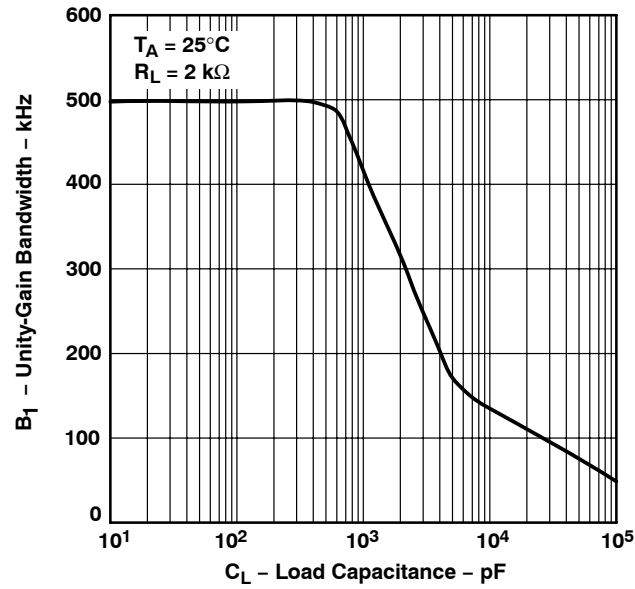

Figure 50

# TLV2432-Q1, TLV2432A-Q1, TLV2434-Q1, TLV2434A-Q1

## Advanced LinCMOS™ RAIL-TO-RAIL OUTPUT

### WIDE-INPUT-VOLTAGE OPERATIONAL AMPLIFIERS

SGLS182B – SEPTEMBER 2003 – REVISED NOVEMBER 2010

## APPLICATION INFORMATION

### macromodel information

Macromodel information provided was derived using Microsim *Parts*™, the model generation software used with Microsim *PSpice*™. The Boyle macromodel (see Note 5) and subcircuit in Figure 51 are generated using the TLV243x typical electrical and operating characteristics at  $T_A = 25^\circ\text{C}$ . Using this information, output simulations of the following key parameters can be generated to a tolerance of 20% (in most cases):

- Maximum positive output voltage swing
- Maximum negative output voltage swing
- Slew rate
- Quiescent power dissipation
- Input bias current
- Open-loop voltage amplification
- Unity-gain frequency
- Common-mode rejection ratio
- Phase margin
- DC output resistance
- AC output resistance
- Short-circuit output current limit

NOTE 4: G. R. Boyle, B. M. Cohn, D. O. Pederson, and J. E. Solomon, "Macromodeling of Integrated Circuit Operational Amplifiers", *IEEE Journal of Solid-State Circuits*, SC-9, 353 (1974).

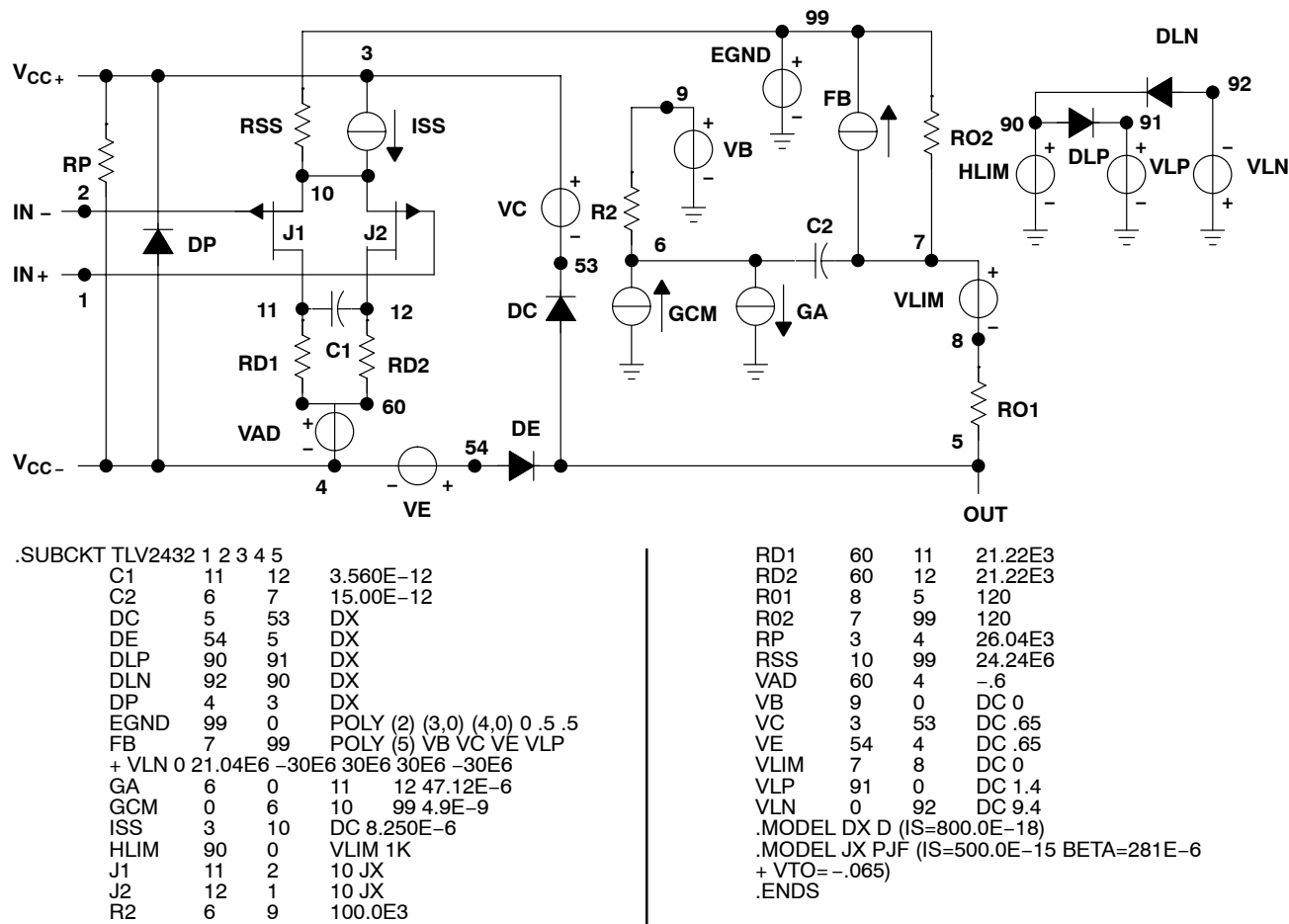

Figure 51. Boyle Macromodel and Subcircuit

*PSpice* and *Parts* are trademarks of MicroSim Corporation.



POST OFFICE BOX 655303 • DALLAS, TEXAS 75265



**PACKAGING INFORMATION**

Orderable Device	Status (1)	Package Type	Package Drawing	Pins	Package Qty	Eco Plan (2)	Lead finish/ Ball material (6)	MSL Peak Temp (3)	Op Temp (°C)	Device Marking (4/5)	Samples
TLV2432AQDRQ1	ACTIVE	SOIC	D	8	2500	RoHS & Green	NIPDAU	Level-1-260C-UNLIM	-40 to 125	2432AQ	<a href="#">Samples</a>
TLV2432QDRG4Q1	ACTIVE	SOIC	D	8	2500	RoHS & Green	NIPDAU	Level-1-260C-UNLIM	-40 to 125	2432Q1	<a href="#">Samples</a>
TLV2434AQDRQ1	ACTIVE	SOIC	D	14	2500	RoHS & Green	NIPDAU	Level-1-260C-UNLIM	-40 to 125	2434AQ	<a href="#">Samples</a>
TLV2434AQPWRQ1	ACTIVE	TSSOP	PW	14	2000	RoHS & Green	NIPDAU	Level-3-260C-168 HR	-40 to 125	2434AQ	<a href="#">Samples</a>

(1) The marketing status values are defined as follows:

**ACTIVE:** Product device recommended for new designs.

**LIFEBUY:** TI has announced that the device will be discontinued, and a lifetime-buy period is in effect.

**NRND:** Not recommended for new designs. Device is in production to support existing customers, but TI does not recommend using this part in a new design.

**PREVIEW:** Device has been announced but is not in production. Samples may or may not be available.

**OBSOLETE:** TI has discontinued the production of the device.

(2) **RoHS:** TI defines "RoHS" to mean semiconductor products that are compliant with the current EU RoHS requirements for all 10 RoHS substances, including the requirement that RoHS substance do not exceed 0.1% by weight in homogeneous materials. Where designed to be soldered at high temperatures, "RoHS" products are suitable for use in specified lead-free processes. TI may reference these types of products as "Pb-Free".

**RoHS Exempt:** TI defines "RoHS Exempt" to mean products that contain lead but are compliant with EU RoHS pursuant to a specific EU RoHS exemption.

**Green:** TI defines "Green" to mean the content of Chlorine (Cl) and Bromine (Br) based flame retardants meet JS709B low halogen requirements of <=1000ppm threshold. Antimony trioxide based flame retardants must also meet the <=1000ppm threshold requirement.

(3) MSL, Peak Temp. - The Moisture Sensitivity Level rating according to the JEDEC industry standard classifications, and peak solder temperature.

(4) There may be additional marking, which relates to the logo, the lot trace code information, or the environmental category on the device.

(5) Multiple Device Markings will be inside parentheses. Only one Device Marking contained in parentheses and separated by a "-" will appear on a device. If a line is indented then it is a continuation of the previous line and the two combined represent the entire Device Marking for that device.

(6) Lead finish/Ball material - Orderable Devices may have multiple material finish options. Finish options are separated by a vertical ruled line. Lead finish/Ball material values may wrap to two lines if the finish value exceeds the maximum column width.

**Important Information and Disclaimer:**The information provided on this page represents TI's knowledge and belief as of the date that it is provided. TI bases its knowledge and belief on information provided by third parties, and makes no representation or warranty as to the accuracy of such information. Efforts are underway to better integrate information from third parties. TI has taken and

continues to take reasonable steps to provide representative and accurate information but may not have conducted destructive testing or chemical analysis on incoming materials and chemicals. TI and TI suppliers consider certain information to be proprietary, and thus CAS numbers and other limited information may not be available for release.

In no event shall TI's liability arising out of such information exceed the total purchase price of the TI part(s) at issue in this document sold by TI to Customer on an annual basis.

**OTHER QUALIFIED VERSIONS OF TLV2432-Q1, TLV2432A-Q1, TLV2434A-Q1 :**

- Catalog : [TLV2432](#), [TLV2432A](#), [TLV2434A](#)

NOTE: Qualified Version Definitions:

- Catalog - TI's standard catalog product

**TAPE AND REEL INFORMATION**

**QUADRANT ASSIGNMENTS FOR PIN 1 ORIENTATION IN TAPE**

\*All dimensions are nominal

Device	Package Type	Package Drawing	Pins	SPQ	Reel Diameter (mm)	Reel Width W1 (mm)	A0 (mm)	B0 (mm)	K0 (mm)	P1 (mm)	W (mm)	Pin1 Quadrant
TLV2434AQPWRQ1	TSSOP	PW	14	2000	330.0	12.4	6.9	5.6	1.6	8.0	12.0	Q1

**TAPE AND REEL BOX DIMENSIONS**

\*All dimensions are nominal

Device	Package Type	Package Drawing	Pins	SPQ	Length (mm)	Width (mm)	Height (mm)
TLV2434AQPWRQ1	TSSOP	PW	14	2000	356.0	356.0	35.0

D (R-PDSO-G14)

PLASTIC SMALL OUTLINE



- NOTES:
- A. All linear dimensions are in inches (millimeters).
  - B. This drawing is subject to change without notice.
  - C. Body length does not include mold flash, protrusions, or gate burrs. Mold flash, protrusions, or gate burrs shall not exceed 0.006 (0,15) each side.
  - D. Body width does not include interlead flash. Interlead flash shall not exceed 0.017 (0,43) each side.
  - E. Reference JEDEC MS-012 variation AB.

D (R-PDSO-G14)

PLASTIC SMALL OUTLINE



- NOTES:
- A. All linear dimensions are in millimeters.
  - B. This drawing is subject to change without notice.
  - C. Publication IPC-7351 is recommended for alternate designs.
  - D. Laser cutting apertures with trapezoidal walls and also rounding corners will offer better paste release. Customers should contact their board assembly site for stencil design recommendations. Refer to IPC-7525 for other stencil recommendations.
  - E. Customers should contact their board fabrication site for solder mask tolerances between and around signal pads.

PW (R-PDSO-G14)

PLASTIC SMALL OUTLINE



4040064-3/G 02/11

- NOTES:
- A. All linear dimensions are in millimeters. Dimensioning and tolerancing per ASME Y14.5M-1994.
  - B. This drawing is subject to change without notice.
  - C. Body length does not include mold flash, protrusions, or gate burrs. Mold flash, protrusions, or gate burrs shall not exceed 0,15 each side.
  - D. Body width does not include interlead flash. Interlead flash shall not exceed 0,25 each side.
  - E. Falls within JEDEC MO-153

PW (R-PDSO-G14)

PLASTIC SMALL OUTLINE



4211284-2/G 08/15

- NOTES:
- A. All linear dimensions are in millimeters.
  - B. This drawing is subject to change without notice.
  - C. Publication IPC-7351 is recommended for alternate designs.
  - D. Laser cutting apertures with trapezoidal walls and also rounding corners will offer better paste release. Customers should contact their board assembly site for stencil design recommendations. Refer to IPC-7525 for other stencil recommendations.
  - E. Customers should contact their board fabrication site for solder mask tolerances between and around signal pads.





D0008A

# PACKAGE OUTLINE

SOIC - 1.75 mm max height

SMALL OUTLINE INTEGRATED CIRCUIT



4214825/C 02/2019

NOTES:

- Linear dimensions are in inches [millimeters]. Dimensions in parenthesis are for reference only. Controlling dimensions are in inches. Dimensioning and tolerancing per ASME Y14.5M.
- This drawing is subject to change without notice.
- This dimension does not include mold flash, protrusions, or gate burrs. Mold flash, protrusions, or gate burrs shall not exceed  $.006$  [0.15] per side.
- This dimension does not include interlead flash.
- Reference JEDEC registration MS-012, variation AA.

# EXAMPLE BOARD LAYOUT

D0008A

SOIC - 1.75 mm max height

SMALL OUTLINE INTEGRATED CIRCUIT



LAND PATTERN EXAMPLE  
 EXPOSED METAL SHOWN  
 SCALE:8X



SOLDER MASK DETAILS

4214825/C 02/2019

NOTES: (continued)

- 6. Publication IPC-7351 may have alternate designs.
- 7. Solder mask tolerances between and around signal pads can vary based on board fabrication site.

# EXAMPLE STENCIL DESIGN

D0008A

SOIC - 1.75 mm max height

SMALL OUTLINE INTEGRATED CIRCUIT



SOLDER PASTE EXAMPLE  
BASED ON .005 INCH [0.125 MM] THICK STENCIL  
SCALE:8X

4214825/C 02/2019

NOTES: (continued)

8. Laser cutting apertures with trapezoidal walls and rounded corners may offer better paste release. IPC-7525 may have alternate design recommendations.
9. Board assembly site may have different recommendations for stencil design.

## IMPORTANT NOTICE AND DISCLAIMER

TI PROVIDES TECHNICAL AND RELIABILITY DATA (INCLUDING DATA SHEETS), DESIGN RESOURCES (INCLUDING REFERENCE DESIGNS), APPLICATION OR OTHER DESIGN ADVICE, WEB TOOLS, SAFETY INFORMATION, AND OTHER RESOURCES "AS IS" AND WITH ALL FAULTS, AND DISCLAIMS ALL WARRANTIES, EXPRESS AND IMPLIED, INCLUDING WITHOUT LIMITATION ANY IMPLIED WARRANTIES OF MERCHANTABILITY, FITNESS FOR A PARTICULAR PURPOSE OR NON-INFRINGEMENT OF THIRD PARTY INTELLECTUAL PROPERTY RIGHTS.

These resources are intended for skilled developers designing with TI products. You are solely responsible for (1) selecting the appropriate TI products for your application, (2) designing, validating and testing your application, and (3) ensuring your application meets applicable standards, and any other safety, security, regulatory or other requirements.

These resources are subject to change without notice. TI grants you permission to use these resources only for development of an application that uses the TI products described in the resource. Other reproduction and display of these resources is prohibited. No license is granted to any other TI intellectual property right or to any third party intellectual property right. TI disclaims responsibility for, and you will fully indemnify TI and its representatives against, any claims, damages, costs, losses, and liabilities arising out of your use of these resources.

TI's products are provided subject to [TI's Terms of Sale](#) or other applicable terms available either on [ti.com](https://www.ti.com) or provided in conjunction with such TI products. TI's provision of these resources does not expand or otherwise alter TI's applicable warranties or warranty disclaimers for TI products.

TI objects to and rejects any additional or different terms you may have proposed.

Mailing Address: Texas Instruments, Post Office Box 655303, Dallas, Texas 75265  
Copyright © 2024, Texas Instruments Incorporated