

TLV271-Q1, TLV272-Q1, TLV274-Q1 FAMILY OF 550- μ A/Ch 3-MHz RAIL-TO-RAIL OUTPUT OPERATIONAL AMPLIFIERS

SGLS275A – OCTOBER 2004 – REVISED JUNE 2008

- Qualified for Automotive Applications
- Rail-To-Rail Output
- Wide Bandwidth . . . 3 MHz
- High Slew Rate . . . 2.4 V/ μ s
- Supply Voltage Range . . . 2.7 V to 16 V
- Supply Current . . . 550 μ A/Channel
- Input Noise Voltage . . . 39 nV/ $\sqrt{\text{Hz}}$
- Input Bias Current . . . 1 pA
- Specified Temperature Range
–40°C to 125°C . . . Automotive Grade
- Ultrasmall Packaging
– 5-Pin SOT-23 (TLV271)
- Ideal Upgrade for TLC27x Family

Operational Amplifier

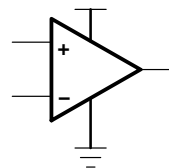

description

The TLV27x takes the minimum operating supply voltage down to 2.7 V over the extended automotive temperature range while adding the rail-to-rail output swing feature. This makes it an ideal alternative to the TLC27x family for applications where rail-to-rail output swings are essential. The TLV27x also provides 3-MHz bandwidth from only 550 μ A.

Like the TLC27x, the TLV27x is fully specified for 5-V and \pm 5-V supplies. The maximum recommended supply voltage is 16 V, which allows the devices to be operated from a variety of rechargeable cells (\pm 8 V supplies down to \pm 1.35 V).

The CMOS inputs enable use in high-impedance sensor interfaces, with the lower voltage operation making an attractive alternative for the TLC27x in battery-powered applications.

The 2.7-V operation makes it compatible with Li-Ion powered systems and the operating supply voltage range of many micropower microcontrollers available today including Texas Instruments MSP430.

SELECTION OF SIGNAL AMPLIFIER PRODUCTS†

DEVICE	V _{DD} (V)	V _{IO} (μ V)	I _q /Ch (μ A)	I _{IB} (pA)	GBW (MHz)	SR (V/ μ s)	SHUTDOWN	RAIL-TO-RAIL	SINGLES/DUALS/QUADS
TLV27x	2.7–16	500	550	1	3	2.4	—	O	S/D/Q
TLC27x	3–16	1100	675	1	1.7	3.6	—	—	S/D/Q
TLV237x	2.7–16	500	550	1	3	2.4	Yes	I/O	S/D/Q
TLC227x	4–16	300	1100	1	2.2	3.6	—	O	D/Q
TLV246x	2.7–6	150	550	1300	6.4	1.6	Yes	I/O	S/D/Q
TLV247x	2.7–6	250	600	2	2.8	1.5	Yes	I/O	S/D/Q
TLV244x	2.7–10	300	725	1	1.8	1.4	—	O	D/Q

† Typical values measured at 5 V, 25°C



Please be aware that an important notice concerning availability, standard warranty, and use in critical applications of Texas Instruments semiconductor products and disclaimers thereto appears at the end of this data sheet.

PRODUCTION DATA information is current as of publication date. Products conform to specifications per the terms of Texas Instruments standard warranty. Production processing does not necessarily include testing of all parameters.

**TEXAS
INSTRUMENTS**

POST OFFICE BOX 655303 • DALLAS, TEXAS 75265

Copyright © 2008 Texas Instruments Incorporated

TLV271-Q1, TLV272-Q1, TLV274-Q1 FAMILY OF 550- μ A/Ch 3-MHz RAIL-TO-RAIL OUTPUT OPERATIONAL AMPLIFIERS

SGLS275A – OCTOBER 2004 – REVISED JUNE 2008

FAMILY PACKAGE TABLE[†]

DEVICE	NUMBER OF CHANNELS	PACKAGE TYPES [‡]				UNIVERSAL EVM BOARD
		SOIC	SOT-23	TSSOP	MSOP [§]	
TLV271	1	8	5	—	—	See the EVM Selection Guide (SLOU060)
TLV272	2	8	—	—	8	
TLV274	4	14	—	14	—	

[†] For the most current package and ordering information, see the Package Option Addendum at the end of this document, or see the TI web site at <http://www.ti.com>.

[‡] Package drawings, thermal data, and symbolization are available at <http://www.ti.com/packaging>.

[§] Product Preview

TLV271 AVAILABLE OPTIONS

T _A	V _{IO} MAX AT 25°C	PACKAGED DEVICES		
		SMALL OUTLINE (D)	SOT-23	
			(DBV)	SYMBOL
-40°C to 125°C	5 mV	TLV271QDRQ1	TLV271QDBVRQ1	271Q

TLV272 AVAILABLE OPTIONS

T _A	V _{IO} MAX AT 25°C	PACKAGED DEVICES		
		SMALL OUTLINE (D)	MSOP	
			(DGK)	SYMBOL
-40°C to 125°C	5 mV	TLV272QDRQ1	TLV272QDGKRQ1 [†]	

[†] Product Preview

TLV274 AVAILABLE OPTIONS

T _A	V _{IO} MAX AT 25°C	PACKAGED DEVICES	
		SMALL OUTLINE (D)	TSSOP (PW)
-40°C to 125°C	5 mV	TLV274QDRQ1	TLV274QPWRQ1



TLV271-Q1, TLV272-Q1, TLV274-Q1 FAMILY OF 550- μ A/Ch 3-MHz RAIL-TO-RAIL OUTPUT OPERATIONAL AMPLIFIERS

SGLS275A – OCTOBER 2004 – REVISED JUNE 2008

TLV27x PACKAGE PINOUTS(1)

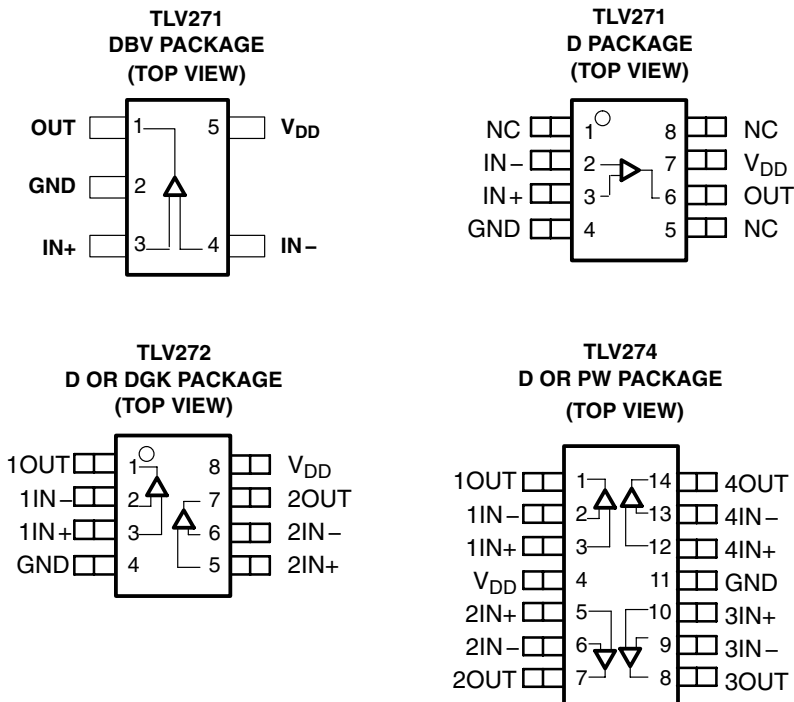

NC – No internal connection
(1) SOT-23 may or may not be indicated

TYPICAL PIN 1 INDICATORS

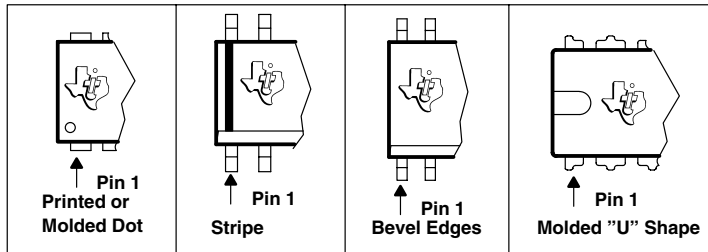

TLV271-Q1, TLV272-Q1, TLV274-Q1 FAMILY OF 550- μ A/Ch 3-MHz RAIL-TO-RAIL OUTPUT OPERATIONAL AMPLIFIERS

SGLS275A – OCTOBER 2004 – REVISED JUNE 2008

absolute maximum ratings over operating free-air temperature range (unless otherwise noted)[†]

Supply voltage, V_{DD} (see Note 1)	16.5 V
Differential input voltage, V_{ID}	$\pm V_{DD}$
Input voltage range, V_I (see Note 1)	-0.2 V to $V_{DD} + 0.2$ V
Input current range, I_I	± 10 mA
Output current range, I_O	± 100 mA
Continuous total power dissipation	See Dissipation Rating Table
Operating free-air temperature range, T_A	-40°C to 125°C
Maximum junction temperature, T_J	150°C
Storage temperature range, T_{stg}	-65°C to 150°C
Lead temperature 1,6 mm (1/16 inch) from case for 10 seconds	260°C

[†] Stresses beyond those listed under “absolute maximum ratings” may cause permanent damage to the device. These are stress ratings only, and functional operation of the device at these or any other conditions beyond those indicated under “recommended operating conditions” is not implied. Exposure to absolute-maximum-rated conditions for extended periods may affect device reliability.

NOTE 1: All voltage values, except differential voltages, are with respect to GND.

DISSIPATION RATING TABLE

PACKAGE	θ_{JC} (°C/W)	θ_{JA} (°C/W)	$T_A \leq 25^\circ\text{C}$ POWER RATING	$T_A = 25^\circ\text{C}$ POWER RATING
D (8)	38.3	176	710 mW	396 mW
D (14)	26.9	122.3	1022 mW	531 mW
DBV (5)	55	324.1	385 mW	201 mW
DGK (8)	54.23	259.96	481 mW	250 mW
PW (14)	29.3	173.6	720 mW	374 mW

recommended operating conditions

		MIN	MAX	UNIT
Supply voltage, V_{DD}	Single supply	2.7	16	V
	Split supply	± 1.35	± 8	
Common-mode input voltage range, V_{ICR}		0	$V_{DD} - 1.35$	V
Operating free-air temperature, T_A	Q-suffix	-40	125	°C



TLV271-Q1, TLV272-Q1, TLV274-Q1
FAMILY OF 550- μ A/Ch 3-MHz RAIL-TO-RAIL OUTPUT
OPERATIONAL AMPLIFIERS

SGLS275A – OCTOBER 2004 – REVISED JUNE 2008

electrical characteristics at specified free-air temperature, $V_{DD} = 2.7$ V, 5 V, and 15 V (unless otherwise noted)

dc performance

PARAMETER		TEST CONDITIONS		T_A †	MIN	TYP	MAX	UNIT
V_{IO}	Input offset voltage	$V_{IC} = V_{DD}/2,$ $R_L = 10$ k Ω ,	$V_O = V_{DD}/2,$ $R_S = 50$ Ω	25°C	0.5		5	mV
				Full range			7	
α_{VIO}	Offset voltage drift			25°C		2		μ V/°C
$CMRR$	Common-mode rejection ratio	$V_{IC} = 0$ to $V_{DD}-1.35$ V, $R_S = 50$ Ω	$V_{DD} = 2.7$ V	25°C	53		70	dB
				Full range	54			
		$V_{IC} = 0$ to $V_{DD}-1.35$ V, $R_S = 50$ Ω	$V_{DD} = 5$ V	25°C	58		80	
				Full range	57			
		$V_{IC} = 0$ to $V_{DD}-1.35$ V, $R_S = 50$ Ω	$V_{DD} = 15$ V	25°C	67		85	
				Full range	66			
A_{VD}	Large-signal differential voltage amplification	$V_{O(PP)} = V_{DD}/2,$ $R_L = 10$ k Ω	$V_{DD} = 2.7$ V	25°C	95		106	dB
				Full range	76			
			$V_{DD} = 5$ V	25°C	80		110	
				Full range	82			
			$V_{DD} = 15$ V	25°C	77		115	
				Full range	79			

† Full range is -40°C to 125°C . If not specified, full range is -40°C to 125°C .

input characteristics

PARAMETER		TEST CONDITIONS		T_A	MIN	TYP	MAX	UNIT
I_{IO}	Input offset current	$V_{DD} = 15$ V, $V_{IC} = V_{DD}/2,$	$V_O = V_{DD}/2, R_S = 50$ Ω	25°C		1	60	pA
				125°C			1000	
I_{IB}	Input bias current	$V_{DD} = 15$ V, $V_{IC} = V_{DD}/2,$	$V_O = V_{DD}/2, R_S = 50$ Ω	25°C		1	60	pA
				125°C			1000	
$r_{i(d)}$	Differential input resistance			25°C		1000		G Ω
C_{IC}	Common-mode input capacitance		$f = 21$ kHz	25°C		8		pF

TLV271-Q1, TLV272-Q1, TLV274-Q1
FAMILY OF 550- μ A/Ch 3-MHz RAIL-TO-RAIL OUTPUT
OPERATIONAL AMPLIFIERS

SGLS275A – OCTOBER 2004 – REVISED JUNE 2008

electrical characteristics at specified free-air temperature, $V_{DD} = 2.7\text{ V}$, 5 V , and 15 V (unless otherwise noted)

output characteristics

PARAMETER	TEST CONDITIONS	T_A^\dagger	MIN	TYP	MAX	UNIT
V_{OH} High-level output voltage	$V_{IC} = V_{DD}/2, I_{OH} = -1\text{ mA}$	$V_{DD} = 2.7\text{ V}$	25°C	2.55	2.58	V
			Full range	2.48		
		$V_{DD} = 5\text{ V}$	25°C	4.9	4.93	
			Full range	4.85		
		$V_{DD} = 15\text{ V}$	25°C	14.92	14.96	
			Full range	14.9		
	$V_{IC} = V_{DD}/2, I_{OH} = -5\text{ mA}$	$V_{DD} = 2.7\text{ V}$	25°C	1.88	2.1	
			Full range	1.42		
		$V_{DD} = 5\text{ V}$	25°C	4.58	4.68	
			Full range	4.44		
		$V_{DD} = 15\text{ V}$	25°C	14.7	14.8	
			Full range	14.6		
V_{OL} Low-level output voltage	$V_{IC} = V_{DD}/2, I_{OL} = 1\text{ mA}$	$V_{DD} = 2.7\text{ V}$	25°C	0.1	0.15	V
			Full range		0.22	
		$V_{DD} = 5\text{ V}$	25°C	0.05	0.1	
			Full range		0.15	
		$V_{DD} = 15\text{ V}$	25°C	0.05	0.08	
			Full range		0.1	
	$V_{IC} = V_{DD}/2, I_{OL} = 5\text{ mA}$	$V_{DD} = 2.7\text{ V}$	25°C	0.5	0.7	
			Full range		1.15	
		$V_{DD} = 5\text{ V}$	25°C	0.28	0.4	
			Full range		0.54	
		$V_{DD} = 15\text{ V}$	25°C	0.19	0.3	
			Full range		0.35	
I_O Output current	$V_O = 0.5\text{ V from rail}, V_{DD} = 2.7\text{ V}$	Positive rail	25°C	4	mA	
		Negative rail	25°C	5		
	$V_O = 0.5\text{ V from rail}, V_{DD} = 5\text{ V}$	Positive rail	25°C	7		
		Negative rail	25°C	8		
	$V_O = 0.5\text{ V from rail}, V_{DD} = 15\text{ V}$	Positive rail	25°C	13		
		Negative rail	25°C	12		

† Full range is -40°C to 125°C . If not specified, full range is -40°C to 125°C .

‡ Depending on package dissipation rating



TLV271-Q1, TLV272-Q1, TLV274-Q1
FAMILY OF 550- μ A/Ch 3-MHz RAIL-TO-RAIL OUTPUT
OPERATIONAL AMPLIFIERS

SGLS275A – OCTOBER 2004 – REVISED JUNE 2008

electrical characteristics at specified free-air temperature, $V_{DD} = 2.7$ V, 5 V, and 15 V (unless otherwise noted) (continued)

power supply

PARAMETER		TEST CONDITIONS	T_A †	MIN	TYP	MAX	UNIT
I_{DD}	Supply current (per channel)	$V_O = V_{DD}/2$	$V_{DD} = 2.7$ V	25°C	470	560	μ A
			$V_{DD} = 5$ V	25°C	550	660	
			$V_{DD} = 15$ V	25°C	750	900	
				Full range		1200	
PSRR	Supply voltage rejection ratio ($\Delta V_{DD}/\Delta V_{IO}$)	$V_{DD} = 2.7$ V to 15 V, No load	$V_{IC} = V_{DD}/2$	25°C	70	80	dB
				Full range	65		

† Full range is -40°C to 125°C . If not specified, full range is -40°C to 125°C .

dynamic performance

PARAMETER		TEST CONDITIONS	T_A †	MIN	TYP	MAX	UNIT
UGBW	Unity gain bandwidth	$R_L = 2$ k Ω , $C_L = 10$ pF	$V_{DD} = 2.7$ V	25°C	2.4		MHz
			$V_{DD} = 5$ V to 15 V	25°C	3		
SR	Slew rate at unity gain	$V_{O(PP)} = V_{DD}/2$, $C_L = 50$ pF, $R_L = 10$ k Ω ,	$V_{DD} = 2.7$ V	25°C	1.4	2.1	V/ μ s
				Full range	1		
			$V_{DD} = 5$ V	25°C	1.4	2.4	V/ μ s
				Full range	1.2		
			$V_{DD} = 15$ V	25°C	1.9	2.1	V/ μ s
				Full range	1.4		
ϕ_m	Phase margin	$R_L = 2$ k Ω	$C_L = 10$ pF	25°C	65		$^\circ$
	Gain margin	$R_L = 2$ k Ω	$C_L = 10$ pF	25°C	18		dB
t_s	Settling time	$V_{DD} = 2.7$ V, $V_{(STEP)PP} = 1$ V, $A_V = -1$, $C_L = 10$ pF, $R_L = 2$ k Ω	0.1%	25°C	2.9		μ s
		$V_{DD} = 5$ V, 15 V, $V_{(STEP)PP} = 1$ V, $A_V = -1$, $C_L = 47$ pF, $R_L = 2$ k Ω	0.1%		2		

† Full range is -40°C to 125°C . If not specified, full range is -40°C to 125°C .

noise/distortion performance

PARAMETER		TEST CONDITIONS	T_A	MIN	TYP	MAX	UNIT
THD + N	Total harmonic distortion plus noise	$V_{DD} = 2.7$ V, $V_{O(PP)} = V_{DD}/2$ V, $R_L = 2$ k Ω , $f = 10$ kHz	$A_V = 1$	25°C	0.02%		
			$A_V = 10$		0.05%		
			$A_V = 100$		0.18%		
		$V_{DD} = 5$ V, ± 5 V, $V_{O(PP)} = V_{DD}/2$ V, $R_L = 2$ k Ω , $f = 10$ K	$A_V = 1$	25°C	0.02%		
			$A_V = 10$		0.09%		
			$A_V = 100$		0.5%		
V_n	Equivalent input noise voltage	$f = 1$ kHz	25°C	39		nV/ $\sqrt{\text{Hz}}$	
		$f = 10$ kHz		35			
I_n	Equivalent input noise current	$f = 1$ kHz	25°C	0.6		fA/ $\sqrt{\text{Hz}}$	



TLV271-Q1, TLV272-Q1, TLV274-Q1
FAMILY OF 550- μ A/Ch 3-MHz RAIL-TO-RAIL OUTPUT
OPERATIONAL AMPLIFIERS

SGLS275A – OCTOBER 2004 – REVISED JUNE 2008

TYPICAL CHARACTERISTICS

Table of Graphs

			FIGURE
CMRR	Common-mode rejection ratio	vs Frequency	1
	Input bias and offset current	vs Free-air temperature	2
V_{OL}	Low-level output voltage	vs Low-level output current	3, 5, 7
V_{OH}	High-level output voltage	vs High-level output current	4, 6, 8
$V_{O(PP)}$	Peak-to-peak output voltage	vs Frequency	9
I_{DD}	Supply current	vs Supply voltage	10
PSRR	Power supply rejection ratio	vs Frequency	11
A_{VD}	Differential voltage gain & phase	vs Frequency	12
	Gain-bandwidth product	vs Free-air temperature	13
SR	Slew rate	vs Supply voltage	14
		vs Free-air temperature	15
ϕ_m	Phase margin	vs Capacitive load	16
V_n	Equivalent input noise voltage	vs Frequency	17
	Voltage-follower large-signal pulse response		18, 19
	Voltage-follower small-signal pulse response		20
	Inverting large-signal response		21, 22
	Inverting small-signal response		23
	Crosstalk	vs Frequency	24



TLV271-Q1, TLV272-Q1, TLV274-Q1 FAMILY OF 550- μ A/Ch 3-MHz RAIL-TO-RAIL OUTPUT OPERATIONAL AMPLIFIERS

SGLS275A – OCTOBER 2004 – REVISED JUNE 2008

TYPICAL CHARACTERISTICS

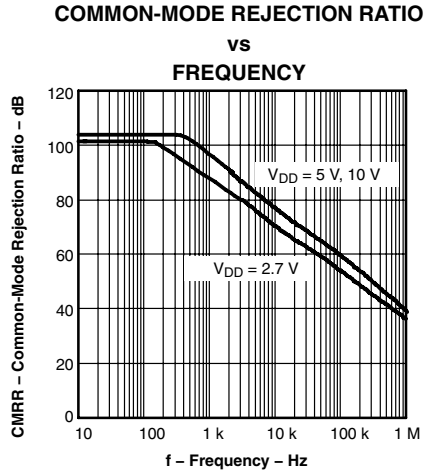

Figure 1

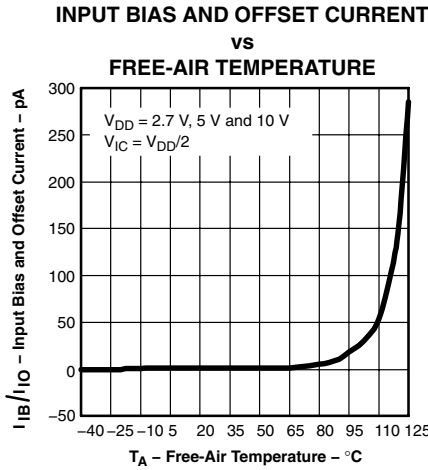

Figure 2

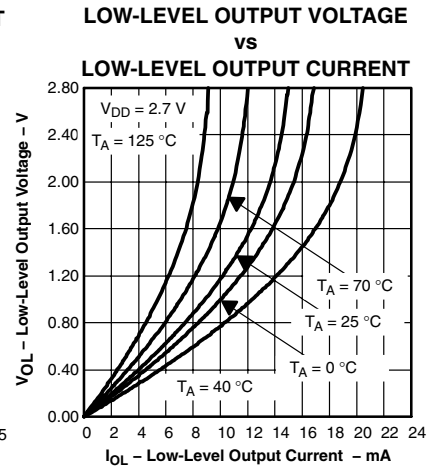

Figure 3

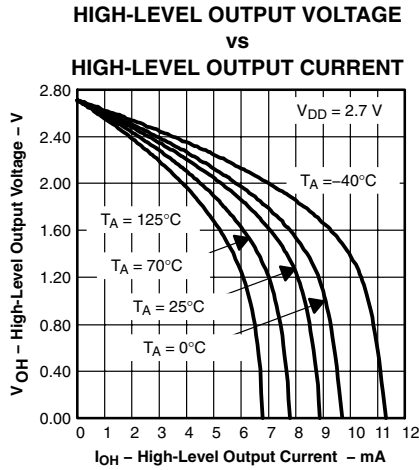

Figure 4

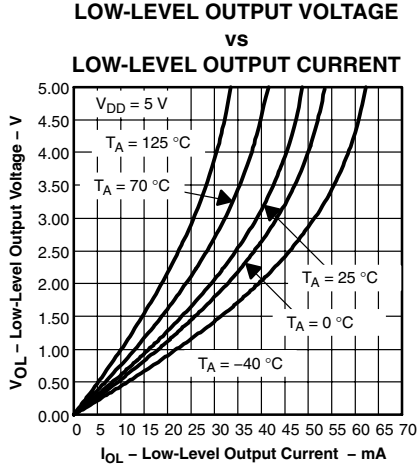

Figure 5

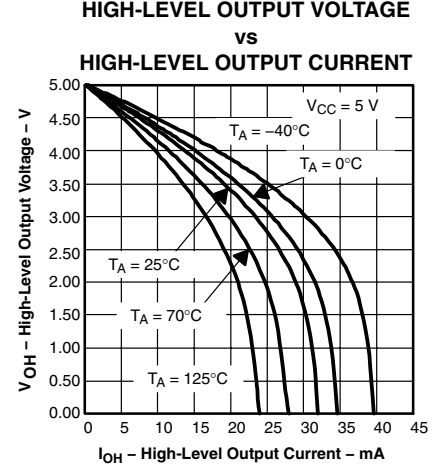

Figure 6

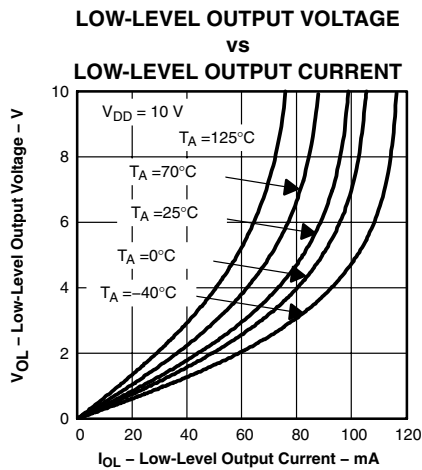

Figure 7

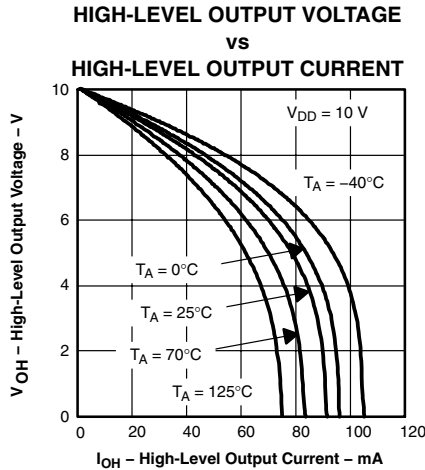

Figure 8

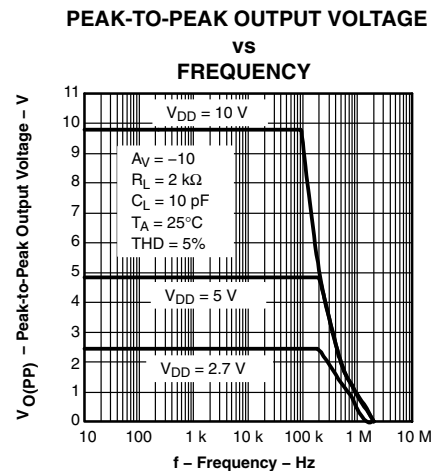

Figure 9

TLV271-Q1, TLV272-Q1, TLV274-Q1 FAMILY OF 550- μ A/Ch 3-MHz RAIL-TO-RAIL OUTPUT OPERATIONAL AMPLIFIERS

SGLS275A – OCTOBER 2004 – REVISED JUNE 2008

TYPICAL CHARACTERISTICS

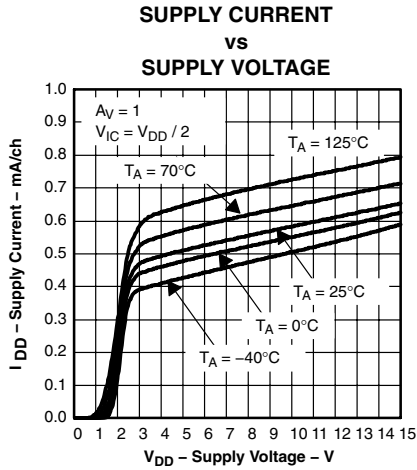

Figure 10

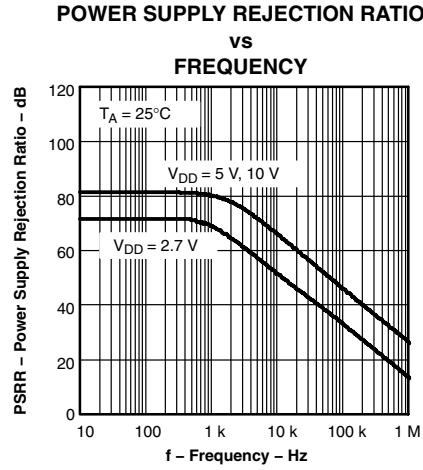

Figure 11

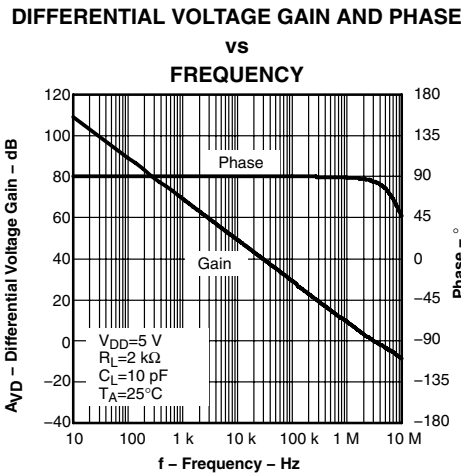

Figure 12

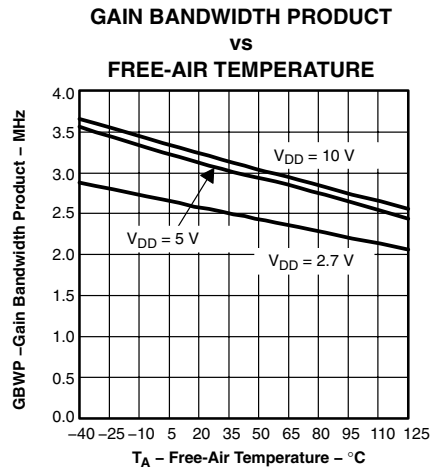

Figure 13

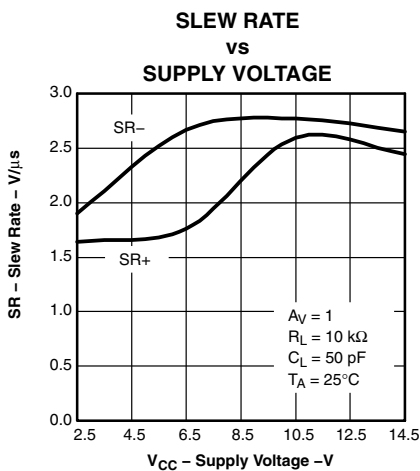

Figure 14

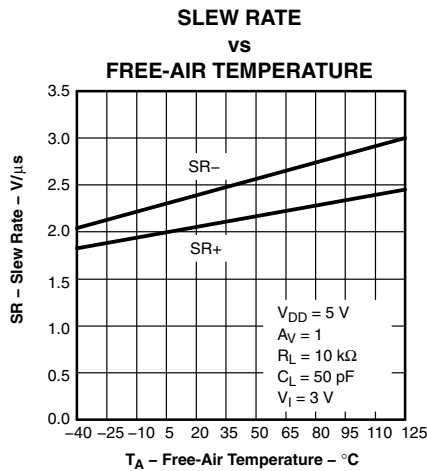

Figure 15

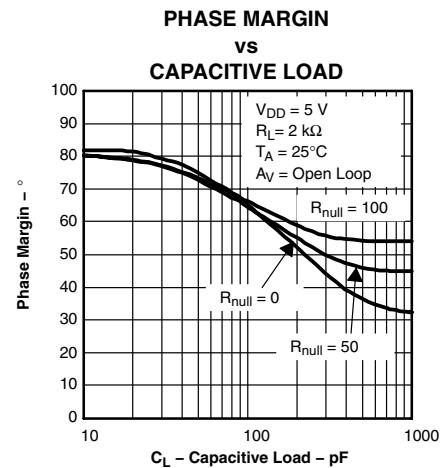

Figure 16



TYPICAL CHARACTERISTICS

EQUIVALENT INPUT NOISE VOLTAGE
 vs
 FREQUENCY

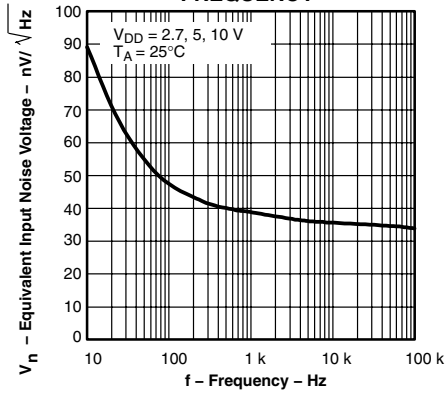

Figure 17

VOLTAGE-FOLLOWER LARGE-SIGNAL
 PULSE RESPONSE

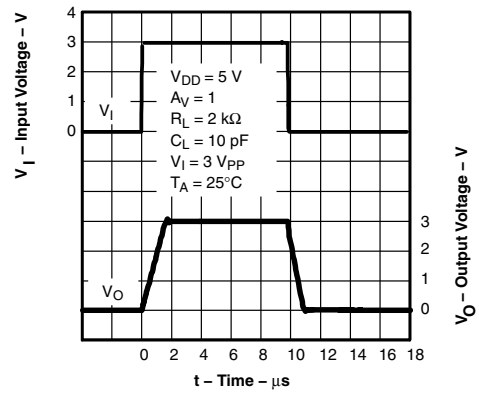

Figure 18

VOLTAGE-FOLLOWER LARGE-SIGNAL
 PULSE RESPONSE

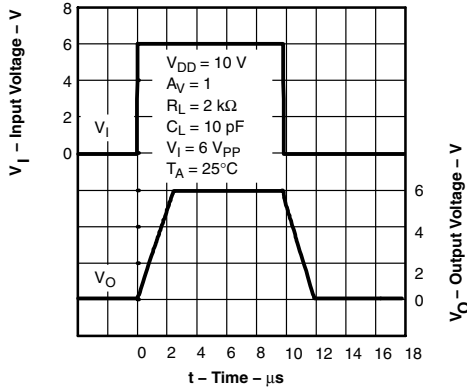

Figure 19

VOLTAGE-FOLLOWER SMALL-SIGNAL
 PULSE RESPONSE

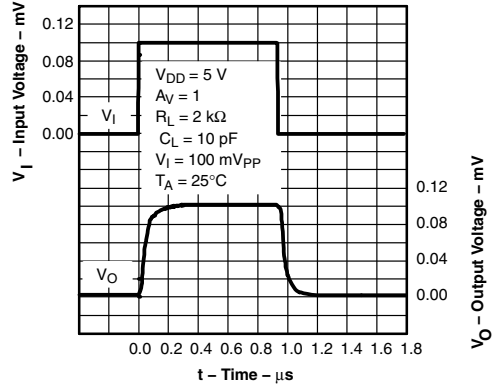

Figure 20

INVERTING LARGE-SIGNAL RESPONSE

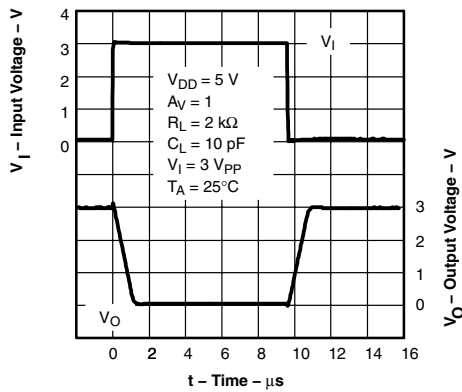

Figure 21

INVERTING LARGE-SIGNAL RESPONSE

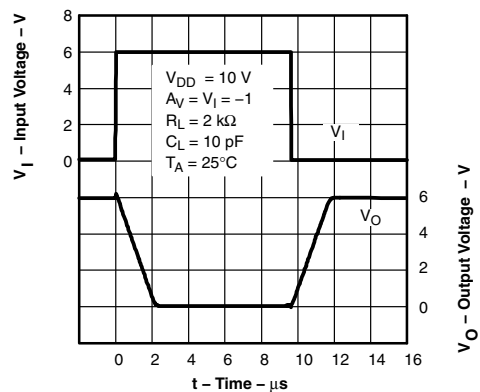

Figure 22

TLV271-Q1, TLV272-Q1, TLV274-Q1 FAMILY OF 550- μ A/Ch 3-MHz RAIL-TO-RAIL OUTPUT OPERATIONAL AMPLIFIERS

SGLS275A – OCTOBER 2004 – REVISED JUNE 2008

TYPICAL CHARACTERISTICS

INVERTING SMALL-SIGNAL RESPONSE

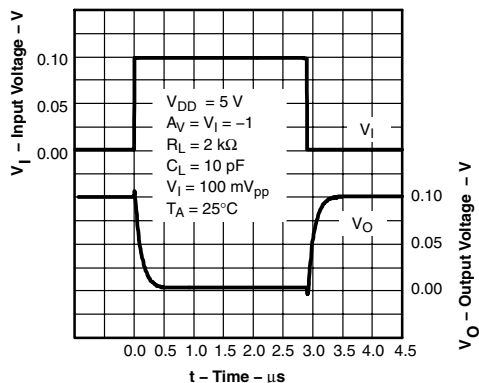

Figure 23

**CROSSTALK
vs
FREQUENCY**

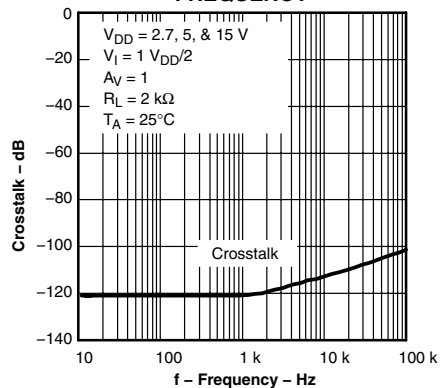

Figure 24

APPLICATION INFORMATION

driving a capacitive load

When the amplifier is configured in this manner, capacitive loading directly on the output decreases the device's phase margin leading to high frequency ringing or oscillations. Therefore, for capacitive loads of greater than 10 pF, it is recommended that a resistor be placed in series (R_{NULL}) with the output of the amplifier, as shown in Figure 25. A minimum value of 20 Ω should work well for most applications.

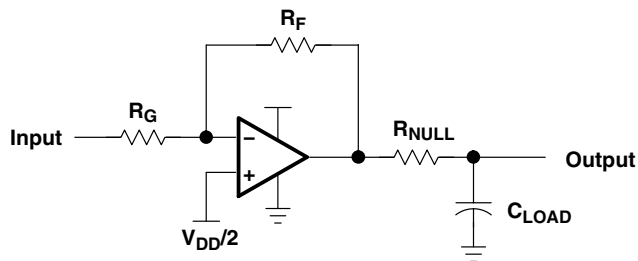

Figure 25. Driving a Capacitive Load

APPLICATION INFORMATION

offset voltage

The output offset voltage (V_{OO}) is the sum of the input offset voltage (V_{IO}) and both input bias currents (I_{IB}) times the corresponding gains. The following schematic and formula can be used to calculate the output offset voltage:

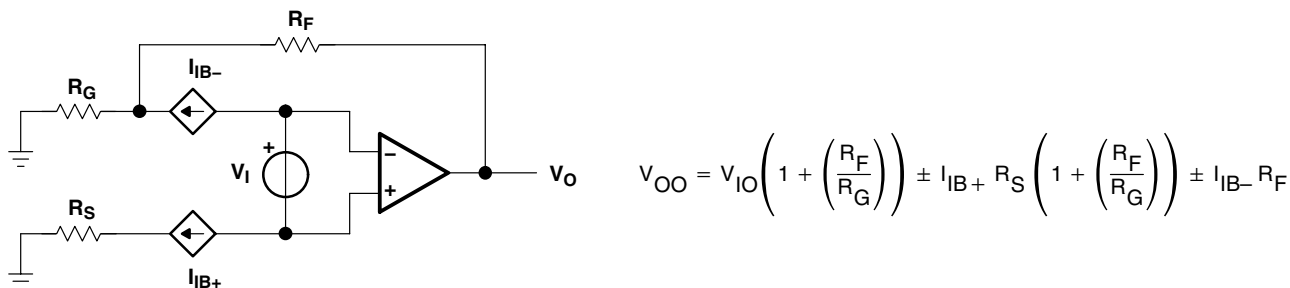

Figure 26. Output Offset Voltage Model

general configurations

When receiving low-level signals, limiting the bandwidth of the incoming signals into the system is often required. The simplest way to accomplish this is to place an RC filter at the noninverting terminal of the amplifier (see Figure 27).

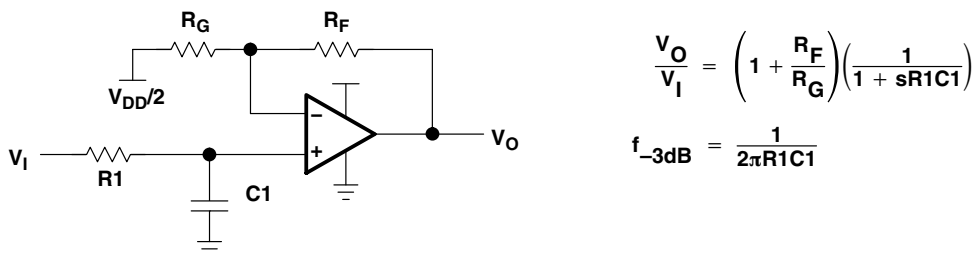

Figure 27. Single-Pole Low-Pass Filter

If even more attenuation is needed, a multiple pole filter is required. The Sallen-Key filter can be used for this task. For the best results, the amplifier should have a bandwidth that is 8 to 10 times the filter frequency bandwidth. Failure to do this can result in phase shift of the amplifier.

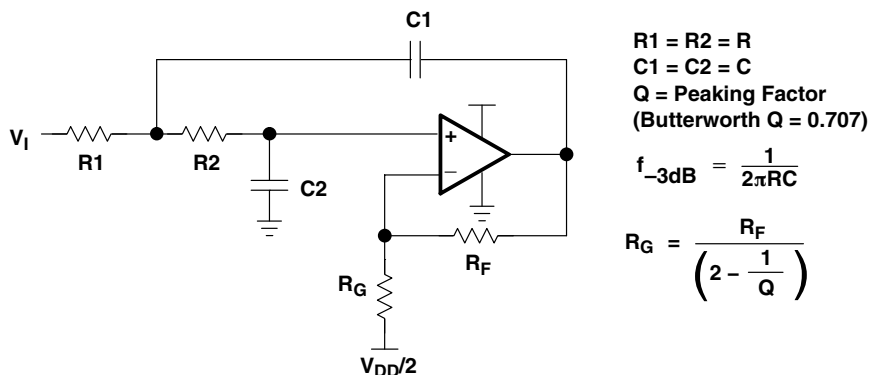

Figure 28. 2-Pole Low-Pass Sallen-Key Filter

TLV271-Q1, TLV272-Q1, TLV274-Q1 FAMILY OF 550- μ A/Ch 3-MHz RAIL-TO-RAIL OUTPUT OPERATIONAL AMPLIFIERS

SGLS275A – OCTOBER 2004 – REVISED JUNE 2008

APPLICATION INFORMATION

circuit layout considerations

To achieve the levels of high performance of the TLV27x, follow proper printed-circuit board design techniques. A general set of guidelines is given in the following.

- Ground planes—It is highly recommended that a ground plane be used on the board to provide all components with a low inductive ground connection. However, in the areas of the amplifier inputs and output, the ground plane can be removed to minimize the stray capacitance.
- Proper power supply decoupling—Use a 6.8- μ F tantalum capacitor in parallel with a 0.1- μ F ceramic capacitor on each supply terminal. It may be possible to share the tantalum among several amplifiers depending on the application, but a 0.1- μ F ceramic capacitor should always be used on the supply terminal of every amplifier. In addition, the 0.1- μ F capacitor should be placed as close as possible to the supply terminal. As this distance increases, the inductance in the connecting trace makes the capacitor less effective. The designer should strive for distances of less than 0.1 inches between the device power terminals and the ceramic capacitors.
- Sockets—Sockets can be used but are not recommended. The additional lead inductance in the socket pins will often lead to stability problems. Surface-mount packages soldered directly to the printed-circuit board is the best implementation.
- Short trace runs/compact part placements—Optimum high performance is achieved when stray series inductance has been minimized. To realize this, the circuit layout should be made as compact as possible, thereby minimizing the length of all trace runs. Particular attention should be paid to the inverting input of the amplifier. Its length should be kept as short as possible. This helps to minimize stray capacitance at the input of the amplifier.
- Surface-mount passive components—Using surface-mount passive components is recommended for high performance amplifier circuits for several reasons. First, because of the extremely low lead inductance of surface-mount components, the problem with stray series inductance is greatly reduced. Second, the small size of surface-mount components naturally leads to a more compact layout thereby minimizing both stray inductance and capacitance. If leaded components are used, it is recommended that the lead lengths be kept as short as possible.



POST OFFICE BOX 655303 • DALLAS, TEXAS 75265

APPLICATION INFORMATION

general power dissipation considerations

For a given θ_{JA} , the maximum power dissipation is shown in Figure 29 and is calculated by the following formula:

$$P_D = \left(\frac{T_{MAX} - T_A}{\theta_{JA}} \right)$$

Where:

- P_D = Maximum power dissipation of TLV27x IC (watts)
- T_{MAX} = Absolute maximum junction temperature (150°C)
- T_A = Free-ambient air temperature (°C)
- θ_{JA} = $\theta_{JC} + \theta_{CA}$
- θ_{JC} = Thermal coefficient from junction to case
- θ_{CA} = Thermal coefficient from case to ambient air (°C/W)

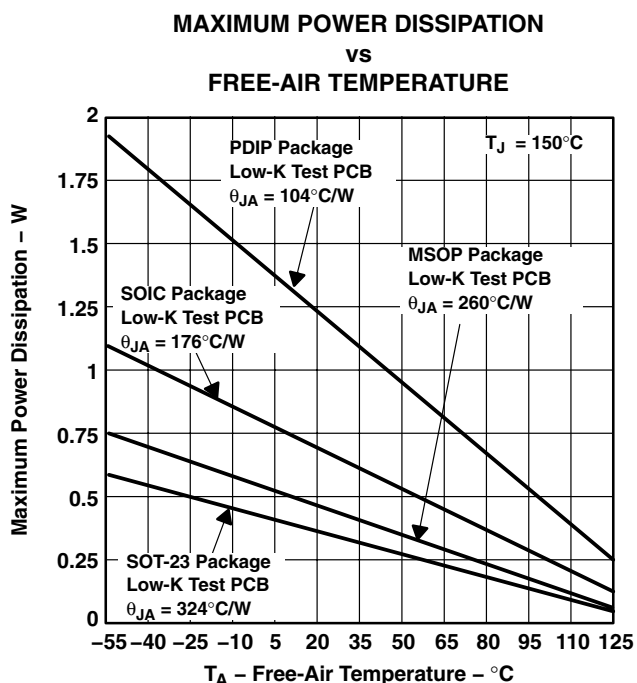

NOTE A: Results are with no air flow and using JEDEC Standard Low-K test PCB.

Figure 29. Maximum Power Dissipation vs Free-Air Temperature

TLV271-Q1, TLV272-Q1, TLV274-Q1 FAMILY OF 550- μ A/Ch 3-MHz RAIL-TO-RAIL OUTPUT OPERATIONAL AMPLIFIERS

SGLS275A – OCTOBER 2004 – REVISED JUNE 2008

APPLICATION INFORMATION

macromodel information

Macromodel information provided was derived using Microsim *Parts*™ Release 9.1, the model generation software used with Microsim *PSpice*™. The Boyle macromodel (see Note 2) and subcircuit in Figure 30 are generated using TLV27x typical electrical and operating characteristics at $T_A = 25^\circ\text{C}$. Using this information, output simulations of the following key parameters can be generated to a tolerance of 20% (in most cases):

- Maximum positive output voltage swing
- Maximum negative output voltage swing
- Slew rate
- Quiescent power dissipation
- Input bias current
- Open-loop voltage amplification
- Unity-gain frequency
- Common-mode rejection ratio
- Phase margin
- DC output resistance
- AC output resistance
- Short-circuit output current limit

NOTE 2: G. R. Boyle, B. M. Cohn, D. O. Pederson, and J. E. Solomon, "Macromodeling of Integrated Circuit Operational Amplifiers," *IEEE Journal of Solid-State Circuits*, SC-9, 353 (1974).

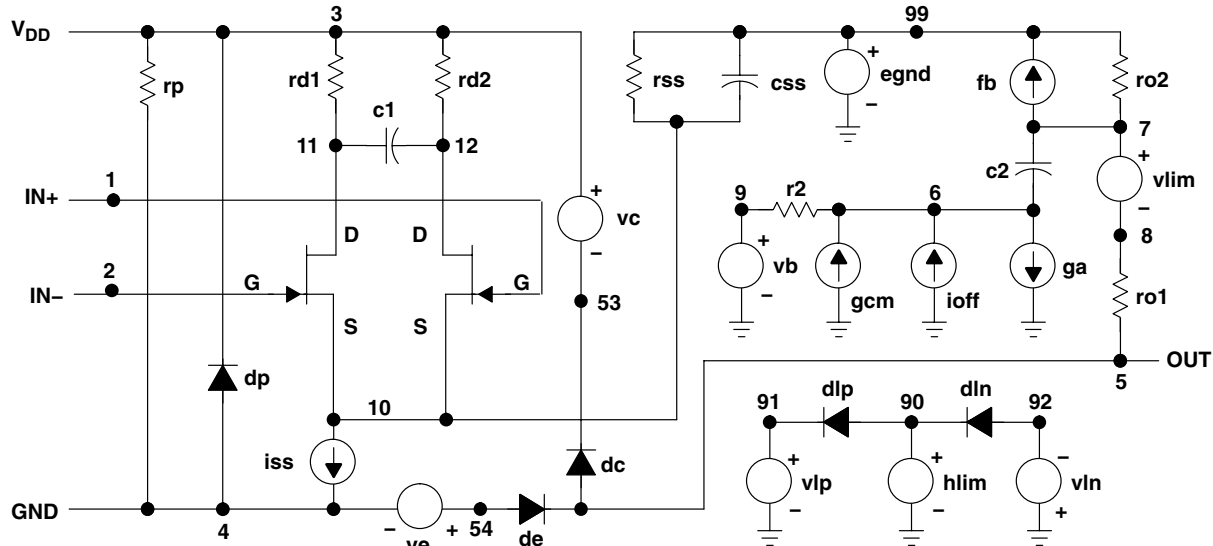

*DEVICE=amp_tlv27x_highVdd,OP AMP,NJF,INT
 * amp_tlv_27x_highVdd operational amplifier "macromodel"
 * subcircuit updated using Model Editor release 9.1 on 05/15/00
 * at 14:40 Model Editor is an OrCAD product.

* connections:

```

non-inverting input
inverting input
positive power supply
negative power supply
output
    
```

.subckt amp_tlv27x_highVdd 1 2 3 4 5

```

c1      11 12 457.48E-15
c2      6  7  5.0000E-12
css     10 99 1.1431E-12
dc      5  53 dy
de      54 5  dy
djp     90 91 dx
dln     92 90 dx
dp      4  3  dx
egnd    99 0  poly(2) (3,0) (4,0) 0 .5 .5
fb      7  99 poly(5) vb vc ve vlp vln 0
    
```

```

ga      6  0 11 12 16.272E-6
gcm     0  6 10 99 6.8698E-9
iss     10 4  dc 1.3371E-6
hlim    90 0  vlim 1K
j1      11 2 10 jx1
J2      12 1 10 jx2
r2      6  9 100.00E3
rd1     3 11 61.456E3
rd2     3 12 61.456E3
ro1     8  5 10
ro2     7 99 10
rp      3  4 150.51E3
rss     10 99 149.58E6
vb      9  0  dc 0
vc      3 53  dc .78905
ve      54 4  dc .78905
vlim    7  8  dc 0
vlp     91 0  dc 14.200
vln     0 92  dc 14.200
.model  dx D(Is=800.00E-18)
.model  dy D(Is=800.00E-18 Rs=1m Cjo=10p)
.model  njf NJF(Is=500.00E-15 Beta=198.03E-6 Vto=-1)
.model  jx1 NJF(Is=500.00E-15 Beta=198.03E-6 Vto=-1)
.model  jx2 NJF(Is=500.00E-15 Beta=198.03E-6 Vto=-1)
.ends
    
```

Figure 30. Boyle Macromodel and Subcircuit

PSpice and Parts are trademarks of MicroSim Corporation.



PACKAGING INFORMATION

Orderable Device	Status (1)	Package Type	Package Drawing	Pins	Package Qty	Eco Plan (2)	Lead finish/ Ball material (6)	MSL Peak Temp (3)	Op Temp (°C)	Device Marking (4/5)	Samples
TLV271QDBVRQ1	ACTIVE	SOT-23	DBV	5	3000	RoHS & Green	NIPDAU	Level-1-260C-UNLIM	-40 to 125	271Q	Samples
TLV271QDRG4Q1	ACTIVE	SOIC	D	8	2500	RoHS & Green	NIPDAU	Level-1-260C-UNLIM	-40 to 125	T271Q1	Samples
TLV271QDRQ1	ACTIVE	SOIC	D	8	2500	RoHS & Green	NIPDAU	Level-1-260C-UNLIM	-40 to 125	T271Q1	Samples
TLV272QDRG4Q1	ACTIVE	SOIC	D	8	2500	RoHS & Green	NIPDAU	Level-1-260C-UNLIM	-40 to 125	T272Q1	Samples
TLV272QDRQ1	ACTIVE	SOIC	D	8	2500	RoHS & Green	NIPDAU	Level-1-260C-UNLIM	-40 to 125	T272Q1	Samples
TLV274QDRQ1	ACTIVE	SOIC	D	14	2500	RoHS & Green	NIPDAU	Level-1-260C-UNLIM	-40 to 125	TLV274Q1	Samples
TLV274QPWRG4Q1	ACTIVE	TSSOP	PW	14	2000	RoHS & Green	NIPDAU	Level-1-260C-UNLIM	-40 to 125	TLV274Q	Samples

(1) The marketing status values are defined as follows:

ACTIVE: Product device recommended for new designs.

LIFEBUY: TI has announced that the device will be discontinued, and a lifetime-buy period is in effect.

NRND: Not recommended for new designs. Device is in production to support existing customers, but TI does not recommend using this part in a new design.

PREVIEW: Device has been announced but is not in production. Samples may or may not be available.

OBSOLETE: TI has discontinued the production of the device.

(2) **RoHS:** TI defines "RoHS" to mean semiconductor products that are compliant with the current EU RoHS requirements for all 10 RoHS substances, including the requirement that RoHS substance do not exceed 0.1% by weight in homogeneous materials. Where designed to be soldered at high temperatures, "RoHS" products are suitable for use in specified lead-free processes. TI may reference these types of products as "Pb-Free".

RoHS Exempt: TI defines "RoHS Exempt" to mean products that contain lead but are compliant with EU RoHS pursuant to a specific EU RoHS exemption.

Green: TI defines "Green" to mean the content of Chlorine (Cl) and Bromine (Br) based flame retardants meet JS709B low halogen requirements of <=1000ppm threshold. Antimony trioxide based flame retardants must also meet the <=1000ppm threshold requirement.

(3) MSL, Peak Temp. - The Moisture Sensitivity Level rating according to the JEDEC industry standard classifications, and peak solder temperature.

(4) There may be additional marking, which relates to the logo, the lot trace code information, or the environmental category on the device.

(5) Multiple Device Markings will be inside parentheses. Only one Device Marking contained in parentheses and separated by a "~" will appear on a device. If a line is indented then it is a continuation of the previous line and the two combined represent the entire Device Marking for that device.

⁽⁶⁾ Lead finish/Ball material - Orderable Devices may have multiple material finish options. Finish options are separated by a vertical ruled line. Lead finish/Ball material values may wrap to two lines if the finish value exceeds the maximum column width.

Important Information and Disclaimer:The information provided on this page represents TI's knowledge and belief as of the date that it is provided. TI bases its knowledge and belief on information provided by third parties, and makes no representation or warranty as to the accuracy of such information. Efforts are underway to better integrate information from third parties. TI has taken and continues to take reasonable steps to provide representative and accurate information but may not have conducted destructive testing or chemical analysis on incoming materials and chemicals. TI and TI suppliers consider certain information to be proprietary, and thus CAS numbers and other limited information may not be available for release.

In no event shall TI's liability arising out of such information exceed the total purchase price of the TI part(s) at issue in this document sold by TI to Customer on an annual basis.

OTHER QUALIFIED VERSIONS OF TLV271-Q1, TLV272-Q1, TLV274-Q1 :

- Catalog : [TLV271](#), [TLV272](#), [TLV274](#)

NOTE: Qualified Version Definitions:

- Catalog - TI's standard catalog product

TAPE AND REEL INFORMATION

QUADRANT ASSIGNMENTS FOR PIN 1 ORIENTATION IN TAPE

*All dimensions are nominal

Device	Package Type	Package Drawing	Pins	SPQ	Reel Diameter (mm)	Reel Width W1 (mm)	A0 (mm)	B0 (mm)	K0 (mm)	P1 (mm)	W (mm)	Pin1 Quadrant
TLV271QDBVRQ1	SOT-23	DBV	5	3000	180.0	9.0	3.15	3.2	1.4	4.0	8.0	Q3
TLV274QPWRG4Q1	TSSOP	PW	14	2000	330.0	12.4	6.9	5.6	1.6	8.0	12.0	Q1

TAPE AND REEL BOX DIMENSIONS

*All dimensions are nominal

Device	Package Type	Package Drawing	Pins	SPQ	Length (mm)	Width (mm)	Height (mm)
TLV271QDBVRQ1	SOT-23	DBV	5	3000	182.0	182.0	20.0
TLV274QPWRG4Q1	TSSOP	PW	14	2000	367.0	367.0	35.0

DBV0005A



PACKAGE OUTLINE

SOT-23 - 1.45 mm max height

SMALL OUTLINE TRANSISTOR

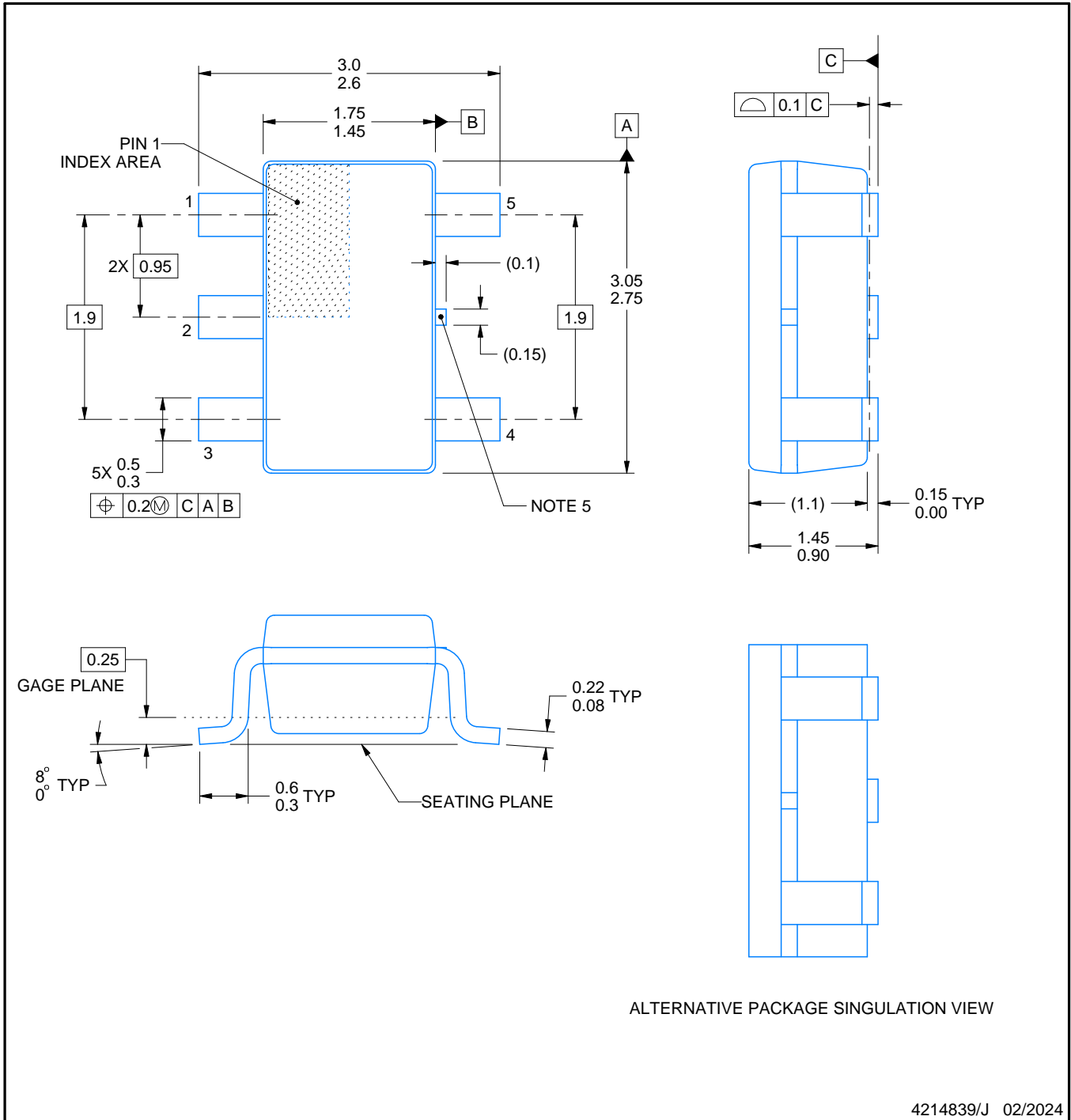

4214839/J 02/2024

NOTES:

1. All linear dimensions are in millimeters. Any dimensions in parenthesis are for reference only. Dimensioning and tolerancing per ASME Y14.5M.
2. This drawing is subject to change without notice.
3. Reference JEDEC MO-178.
4. Body dimensions do not include mold flash, protrusions, or gate burrs. Mold flash, protrusions, or gate burrs shall not exceed 0.25 mm per side.
5. Support pin may differ or may not be present.

EXAMPLE BOARD LAYOUT

DBV0005A

SOT-23 - 1.45 mm max height

SMALL OUTLINE TRANSISTOR



LAND PATTERN EXAMPLE
EXPOSED METAL SHOWN
SCALE:15X



SOLDER MASK DETAILS

4214839/J 02/2024

NOTES: (continued)

- 6. Publication IPC-7351 may have alternate designs.
- 7. Solder mask tolerances between and around signal pads can vary based on board fabrication site.

EXAMPLE STENCIL DESIGN

DBV0005A

SOT-23 - 1.45 mm max height

SMALL OUTLINE TRANSISTOR



SOLDER PASTE EXAMPLE
BASED ON 0.125 mm THICK STENCIL
SCALE:15X

4214839/J 02/2024

NOTES: (continued)

8. Laser cutting apertures with trapezoidal walls and rounded corners may offer better paste release. IPC-7525 may have alternate design recommendations.
9. Board assembly site may have different recommendations for stencil design.

D (R-PDSO-G14)

PLASTIC SMALL OUTLINE

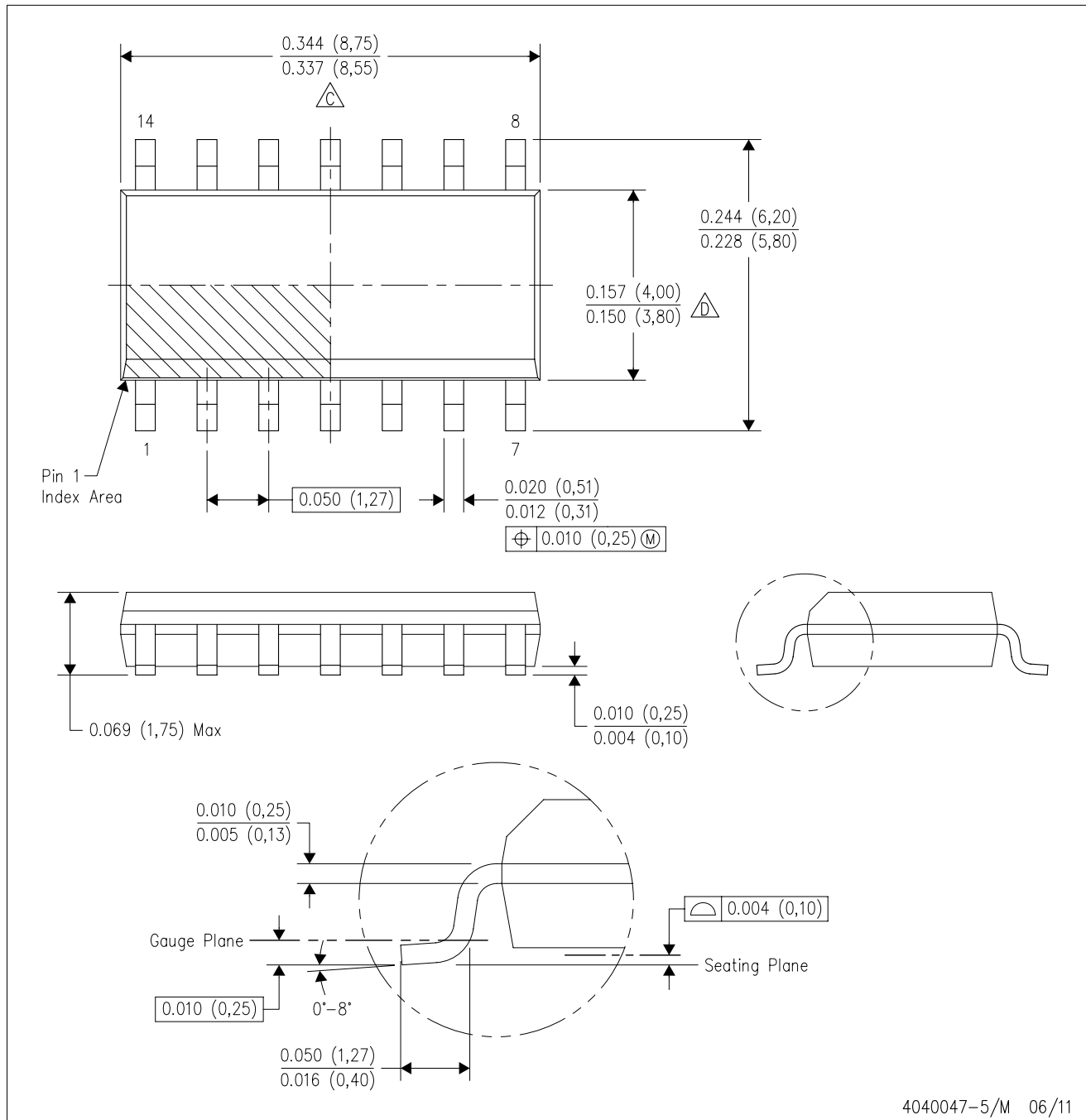

NOTES:

- A. All linear dimensions are in inches (millimeters).
- B. This drawing is subject to change without notice.
- C. Body length does not include mold flash, protrusions, or gate burrs. Mold flash, protrusions, or gate burrs shall not exceed 0.006 (0,15) each side.
- D. Body width does not include interlead flash. Interlead flash shall not exceed 0.017 (0,43) each side.
- E. Reference JEDEC MS-012 variation AB.

D (R-PDSO-G14)

PLASTIC SMALL OUTLINE



4211283-3/E 08/12

- NOTES:
- All linear dimensions are in millimeters.
 - This drawing is subject to change without notice.
 - Publication IPC-7351 is recommended for alternate designs.
 - Laser cutting apertures with trapezoidal walls and also rounding corners will offer better paste release. Customers should contact their board assembly site for stencil design recommendations. Refer to IPC-7525 for other stencil recommendations.
 - Customers should contact their board fabrication site for solder mask tolerances between and around signal pads.

PW (R-PDSO-G14)

PLASTIC SMALL OUTLINE



4040064-3/G 02/11

- NOTES:
- A. All linear dimensions are in millimeters. Dimensioning and tolerancing per ASME Y14.5M-1994.
 - B. This drawing is subject to change without notice.
 - C. Body length does not include mold flash, protrusions, or gate burrs. Mold flash, protrusions, or gate burrs shall not exceed 0,15 each side.
 - D. Body width does not include interlead flash. Interlead flash shall not exceed 0,25 each side.
 - E. Falls within JEDEC MO-153

PW (R-PDSO-G14)

PLASTIC SMALL OUTLINE



4211284-2/G 08/15

- NOTES:
- All linear dimensions are in millimeters.
 - This drawing is subject to change without notice.
 - Publication IPC-7351 is recommended for alternate designs.
 - Laser cutting apertures with trapezoidal walls and also rounding corners will offer better paste release. Customers should contact their board assembly site for stencil design recommendations. Refer to IPC-7525 for other stencil recommendations.
 - Customers should contact their board fabrication site for solder mask tolerances between and around signal pads.



D0008A

PACKAGE OUTLINE

SOIC - 1.75 mm max height

SMALL OUTLINE INTEGRATED CIRCUIT



4214825/C 02/2019

NOTES:

1. Linear dimensions are in inches [millimeters]. Dimensions in parenthesis are for reference only. Controlling dimensions are in inches. Dimensioning and tolerancing per ASME Y14.5M.
2. This drawing is subject to change without notice.
3. This dimension does not include mold flash, protrusions, or gate burrs. Mold flash, protrusions, or gate burrs shall not exceed $.006$ [0.15] per side.
4. This dimension does not include interlead flash.
5. Reference JEDEC registration MS-012, variation AA.

EXAMPLE BOARD LAYOUT

D0008A

SOIC - 1.75 mm max height

SMALL OUTLINE INTEGRATED CIRCUIT



LAND PATTERN EXAMPLE
 EXPOSED METAL SHOWN
 SCALE:8X



SOLDER MASK DETAILS

4214825/C 02/2019

NOTES: (continued)

- 6. Publication IPC-7351 may have alternate designs.
- 7. Solder mask tolerances between and around signal pads can vary based on board fabrication site.

EXAMPLE STENCIL DESIGN

D0008A

SOIC - 1.75 mm max height

SMALL OUTLINE INTEGRATED CIRCUIT



SOLDER PASTE EXAMPLE
BASED ON .005 INCH [0.125 MM] THICK STENCIL
SCALE:8X

4214825/C 02/2019

NOTES: (continued)

8. Laser cutting apertures with trapezoidal walls and rounded corners may offer better paste release. IPC-7525 may have alternate design recommendations.
9. Board assembly site may have different recommendations for stencil design.

IMPORTANT NOTICE AND DISCLAIMER

TI PROVIDES TECHNICAL AND RELIABILITY DATA (INCLUDING DATA SHEETS), DESIGN RESOURCES (INCLUDING REFERENCE DESIGNS), APPLICATION OR OTHER DESIGN ADVICE, WEB TOOLS, SAFETY INFORMATION, AND OTHER RESOURCES "AS IS" AND WITH ALL FAULTS, AND DISCLAIMS ALL WARRANTIES, EXPRESS AND IMPLIED, INCLUDING WITHOUT LIMITATION ANY IMPLIED WARRANTIES OF MERCHANTABILITY, FITNESS FOR A PARTICULAR PURPOSE OR NON-INFRINGEMENT OF THIRD PARTY INTELLECTUAL PROPERTY RIGHTS.

These resources are intended for skilled developers designing with TI products. You are solely responsible for (1) selecting the appropriate TI products for your application, (2) designing, validating and testing your application, and (3) ensuring your application meets applicable standards, and any other safety, security, regulatory or other requirements.

These resources are subject to change without notice. TI grants you permission to use these resources only for development of an application that uses the TI products described in the resource. Other reproduction and display of these resources is prohibited. No license is granted to any other TI intellectual property right or to any third party intellectual property right. TI disclaims responsibility for, and you will fully indemnify TI and its representatives against, any claims, damages, costs, losses, and liabilities arising out of your use of these resources.

TI's products are provided subject to [TI's Terms of Sale](#) or other applicable terms available either on [ti.com](https://www.ti.com) or provided in conjunction with such TI products. TI's provision of these resources does not expand or otherwise alter TI's applicable warranties or warranty disclaimers for TI products.

TI objects to and rejects any additional or different terms you may have proposed.

Mailing Address: Texas Instruments, Post Office Box 655303, Dallas, Texas 75265
Copyright © 2024, Texas Instruments Incorporated