

TLV3511 7ns High-Speed Comparator with Rail-to-Rail Input

1 Features

- Propagation delay: 6ns
- High toggle frequency: 180MHz
- Wide supply range: 2.7V to 5.5V
- Input offset voltage: +/- 1mV typ.
- Low supply current: 1.1mA per channel
- Input voltage range extends 300mV beyond either rail
- Internal hysteresis: 2.3mV
- Power-on-reset provides a known startup condition
- Push-pull output
- Temperature range: -40°C to +125°C

2 Applications

- [Motor Drive Diagnostics & Monitoring](#)
- [Servo Drive Control Module](#)
- [Servo drive position sensor](#)
- [Medical & Healthcare](#)
- [Field Transmitters & Sensors](#)

3 Description

The TLV351x is a family of 5V single and dual channel comparators with push-pull outputs. The family has an excellent speed-to-power combination with a propagation delay of 7ns and a full supply voltage range of 2.7V to 5.5V with a quiescent supply current of only 1mA per channel.

All devices include a Power-On Reset (POR) feature. This makes sure the output is in a known state (output

LOW) until the minimum supply voltage has been reached before the output responds to the inputs, thus preventing false outputs during system power-up and power-down.

Likewise, the TLV351x are conveniently available in standard leaded and leadless packages with features such as rail-to-rail inputs, low offset voltage, and large output drive current. These features along with fast response time make the comparators well-suited for current sensing, zero-cross detection, and a variety of other applications where precision and speed is critical.

All devices are specified for operation across the expanded temperature range of -40°C to 125°C.

Device Information

PART NUMBER	PACKAGE (1)	BODY SIZE (NOM) (2)
TLV3511	SC-70 (5)	1.25mm × 2.00mm
	SOT-23 (5) (Preview)	1.60mm × 2.90mm
	SOT (5) (Preview)	1.2mm × 1.5mm
TLV3512	VSSOP (8) (Preview)	3.00mm × 3.00mm
	WSON (8) (Preview)	2.00mm × 2.00mm

- (1) For all available packages, see the orderable addendum at the end of the data sheet.
- (2) The package size (length × width) is a nominal value and includes pins, where applicable.

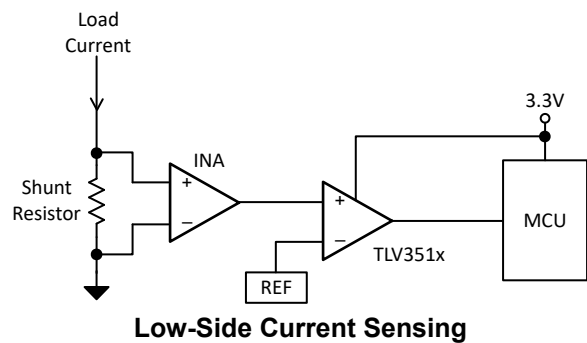
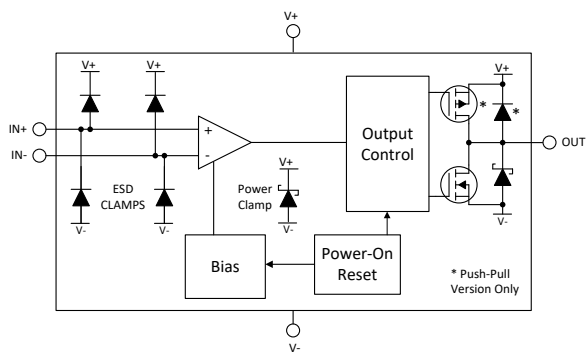
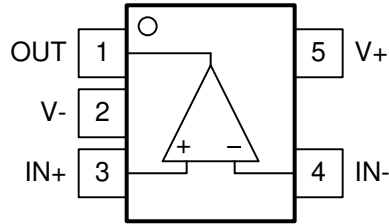

Table of Contents

1 Features	1	6.4 Device Functional Modes.....	12
2 Applications	1	7 Application and Implementation	14
3 Description	1	7.1 Application Information.....	14
4 Pin Configuration and Functions	3	7.2 Typical Applications.....	17
Pin Configurations: TLV3511 and TLV3512.....	3	7.3 Power Supply Recommendations.....	18
5 Specifications	5	7.4 Layout.....	18
5.1 Absolute Maximum Ratings.....	5	8 Device and Documentation Support	19
5.2 ESD Ratings.....	5	8.1 Documentation Support.....	19
5.3 Recommended Operating Conditions.....	5	8.2 Receiving Notification of Documentation Updates....	19
5.4 Thermal Information.....	5	8.3 Support Resources.....	19
5.5 Electrical Characteristics.....	6	8.4 Trademarks.....	19
5.6 Switching Characteristics.....	6	8.5 Electrostatic Discharge Caution.....	20
5.7 Typical Characteristics.....	7	8.6 Glossary.....	20
6 Detailed Description	12	9 Revision History	20
6.1 Overview.....	12	10 Mechanical, Packaging, and Orderable Information	20
6.2 Functional Block Diagrams.....	12		
6.3 Feature Description.....	12		

4 Pin Configuration and Functions

Pin Configurations: TLV3511 and TLV3512



**DCK, DBV, DRL Packages
SC70, SOT-23-5, SOT
Top View
(Standard "north west" pinout)**

Table 4-1. Pin Functions: TLV3511

PIN		I/O	DESCRIPTION
NAME	NO.		
OUT	1	O	Output
V-	2	-	Negative supply voltage
IN+	3	I	Non-inverting (+) input
IN-	4	I	Inverting (-) input
V+	5	-	Positive supply voltage

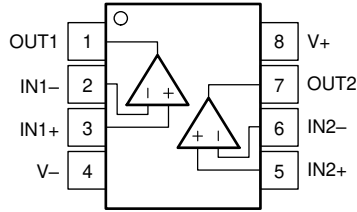

**Figure 4-1. DGK Package
8-Pin VSSOP
Top View**

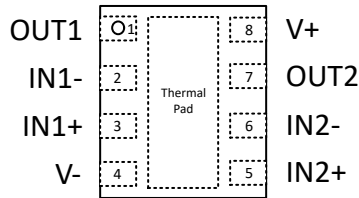

**Figure 4-2. DSG Package
8-Pin WSON
Top View**

Pin Functions: TLV3512

PIN		I/O	DESCRIPTION
NAME	NO.		
IN1+	1	I	Noninverting input, channel 1
IN1-	2	I	Inverting input, channel 1
IN2-	3	I	Inverting input, channel 2
IN2+	4	I	Noninverting input, channel 2
OUT1	7	O	Output, channel 1
OUT2	6	O	Output, channel 2
V-	5	-	Negative (lowest) supply or ground
V+	8	-	Positive (highest) supply

5 Specifications

5.1 Absolute Maximum Ratings

over operating free-air temperature range (unless otherwise noted)⁽¹⁾

	MIN	MAX	UNIT
Supply voltage $V_S = (V+) - (V-)$		6	V
Differential input voltage, VID	-6	6	V
Input pins (IN+, IN-) from (V-) ⁽²⁾	-0.5	(V+) + 0.5	V
Current into input pins (IN+, IN-)	-10	10	mA
Output (OUT) from (V-)	-0.5	(V+) + 0.5	V
Output short-circuit current	-100	100	mA
Output short-circuit duration		10	s
Junction temperature, T_J		150	°C
Storage temperature, T_{stg}	-65	150	°C

- (1) Stresses beyond those listed under *Absolute Maximum Ratings* may cause permanent damage to the device. These are stress ratings only, which do not imply functional operation of the device at these or any other conditions beyond those indicated under *Recommended Operating Conditions*. Exposure to absolute-maximum-rated conditions for extended periods may affect device reliability.
- (2) Input terminals are diode-clamped to (V-) and (V+). Input signals that can swing more than 0.5V beyond the supply rails must be current-limited to 10mA or less.

5.2 ESD Ratings

			VALUE	UNIT
$V_{(ESD)}$	Electrostatic discharge	Human-body model (HBM), per ANSI/ESDA/JEDEC JS-001 ⁽¹⁾	±2000	V
$V_{(ESD)}$	Electrostatic discharge	Charged-device model (CDM), per JEDEC specification JESD22-C101 ⁽²⁾	±1000	V

- (1) JEDEC document JEP155 states that 500V HBM allows safe manufacturing with a standard ESD control process.
- (2) JEDEC document JEP157 states that 250V CDM allows safe manufacturing with a standard ESD control process.

5.3 Recommended Operating Conditions

over operating free-air temperature range (unless otherwise noted)

	MIN	MAX	UNIT
Supply voltage $V_S = (V+) - (V-)$	2.7	5.5	V
Input voltage range	(V-) - 0.3	(V+) + 0.3	V
Ambient temperature, T_A	-40	125	°C

5.4 Thermal Information

THERMAL METRIC ⁽¹⁾		TLV3511		UNIT
		DBV (SOT-23)	DCK (SC70)	
		5 PINS	5 PINS	
$R_{\theta JA}$	Junction-to-ambient thermal resistance	198.1	220.1	°C/W
$R_{\theta JC(top)}$	Junction-to-case (top) thermal resistance	95.6	136.5	°C/W
$R_{\theta JB}$	Junction-to-board thermal resistance	64.7	65.9	°C/W
Ψ_{JT}	Junction-to-top characterization parameter	32.1	34.5	°C/W
Ψ_{JB}	Junction-to-board characterization parameter	64.3	65.4	°C/W
$R_{\theta JC(bot)}$	Junction-to-case (bottom) thermal resistance	n/a	n/a	°C/W

- (1) For more information about traditional and new thermal metrics, see the [Semiconductor and IC Package Thermal Metrics](#) application report.

5.5 Electrical Characteristics

$V_S = 2.7V$ to $5V$, $V_{CM} = V_S / 2$; at $T_A = 25^\circ C$ (unless otherwise noted).

Typical values are at $T_A = 25^\circ C$.

PARAMETER		TEST CONDITIONS	MIN	TYP	MAX	UNIT
DC Input Characteristics						
V_{IO}	Input Offset Voltage	$V_S = 5V$, $V_{CM} = V_S / 2$		± 1	± 5	mV
V_{IO}	Input Offset Voltage	$V_S = 5V$, $V_{CM} = V_S / 2$, $T_A = -40$ to $125^\circ C$			± 6	mV
V_{HYS}	Hysteresis	$V_S = 5V$, $V_{CM} = V_S / 2$		2.3		mV
V_{HYS}	Hysteresis	$V_S = 5V$, $V_{CM} = V_S / 2$, $T_A = -40$ to $125^\circ C$			3.5	mV
V_{CM}	Common-mode voltage range		(V-) - 0.2		(V+) + 0.2	V
I_B	Input bias current	$V_S = 5V$, $V_{CM} = V_S / 2$, $T_A = -40$ to $125^\circ C$			1.5	nA
I_{OS}	Input offset current	$V_S = 5V$, $V_{CM} = V_S / 2$			10	pA
C_{IN}	Input capacitance			4		pF
CMRR	Common-mode rejection ratio	$V_{CM} = V_{EE} - 0.2V$ to $V_{CC} + 0.2V$		80		dB
DC Output Characteristics						
V_{OH}	Voltage swing from (V+)	$V_S = 5V$, $I_{Source} = 4mA$		120	225	mV
V_{OH}	Voltage swing from (V+)	$V_S = 5V$, $I_{Source} = 4mA$, -40 to $125^\circ C$			250	mV
V_{OL}	Voltage swing from (V-)	$V_S = 5V$, $I_{Sink} = 4mA$		140	225	mV
V_{OL}	Voltage swing from (V-)	$V_S = 5V$, $I_{Sink} = 4mA$, -40 to $125^\circ C$			250	mV
I_{SC}	Short-circuit current	$V_S = 5V$, sourcing		75		mA
		$V_S = 5V$, sinking		85		
Power Supply						
I_Q	Supply current / Channel	$V_S = 2.7V$ and $5V$, no load, output low, $T_A = -40$ to $125^\circ C$		1.1	2	mA
V_{POR} (positive)	Power-On Reset Voltage			2.2		V
PSRR	Power Supply Rejection Ratio	$V_S = 2.7V$ to $5.5V$, $T_A = -40$ to $125^\circ C$		93		dB

5.6 Switching Characteristics

For $V_S = 2.7V$ to $V_S = 5V$, $V_{CM} = V_S / 2$; $C_L = 15pF$ at $T_A = 25^\circ C$ (Unless otherwise noted)

PARAMETER		TEST CONDITIONS	MIN	TYP	MAX	UNIT
t_{PHL}	Propagation delay time, high to low	Midpoint of input to midpoint of output, $V_{OD} = 10mV$		10		ns
t_{PHL}	Propagation delay time, high to low	Midpoint of input to midpoint of output, $V_{OD} = 50mV$		6	7	ns
t_{PLH}	Propagation delay time, low to high	Midpoint of input to midpoint of output, $V_{OD} = 10mV$		10		ns
t_{PLH}	Propagation delay time, low to high	Midpoint of input to midpoint of output, $V_{OD} = 50mV$		6	7	ns
t_{PD} Skew	Propagation delay skew	Measured as absolute value of the difference between t_{PDLH} and t_{PDHL}		300		ps
PWin	Minimum input pulse width	Voverdrive = Vunderdrive = $50mV$ PWout = 90% of PWin		3.5		ns
f_{TOGGLE}	Input toggle frequency	$V_{IN} = 200mV_{PP}$ Sine Wave, When output high reaches 90% of $V_{CC} - V_{EE}$ or output low reaches 10% of $V_{CC} - V_{EE}$		180		MHz
t_R	Rise time	Measured from 20% to 80%		1		ns
t_F	Fall time	Measured from 20% to 80%		1		ns
t_{ON}	Power-up time	During power on, (V+) must exceed 2.2V for $2.1\mu s$ before the output will reflect the input.		2.1		μs

5.7 Typical Characteristics

$T_A = 25^\circ\text{C}$, $V_S = 5\text{V}$, $C_L = 15\text{pF}$, $V_{CM} = V_S/2\text{V}$, $V_{\text{UNDERDRIVE}} = 50\text{mV}$, $V_{\text{OVERDRIVE}} = 50\text{mV}$ unless otherwise noted.

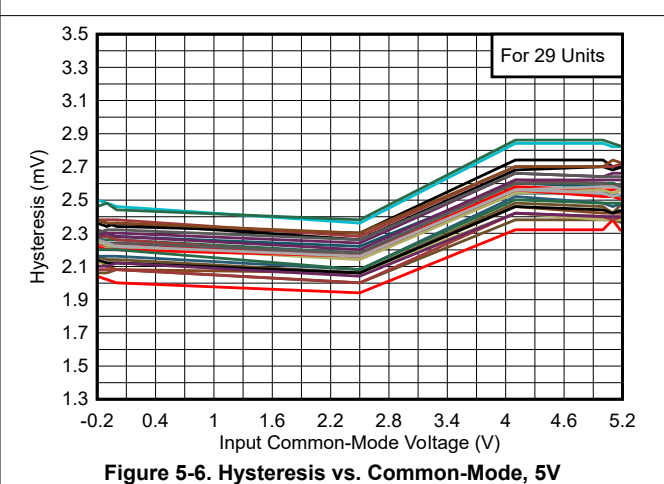
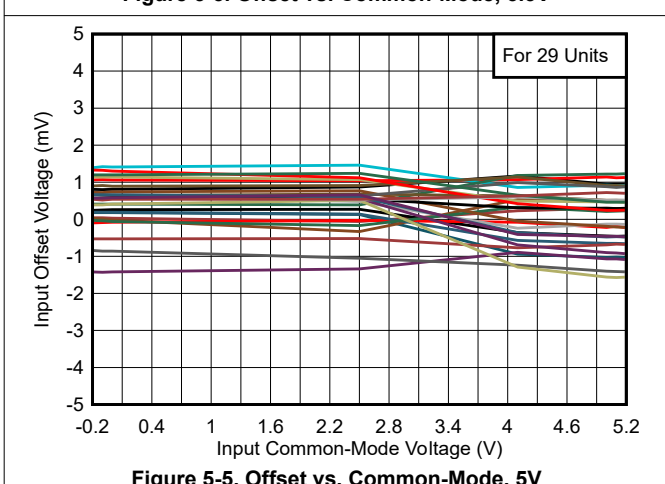
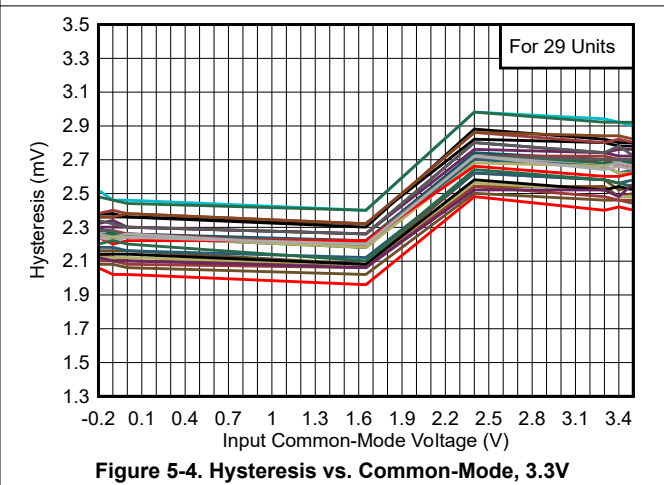
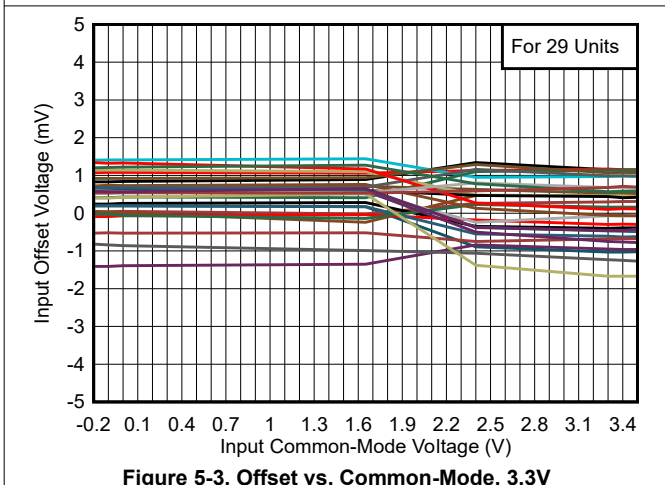
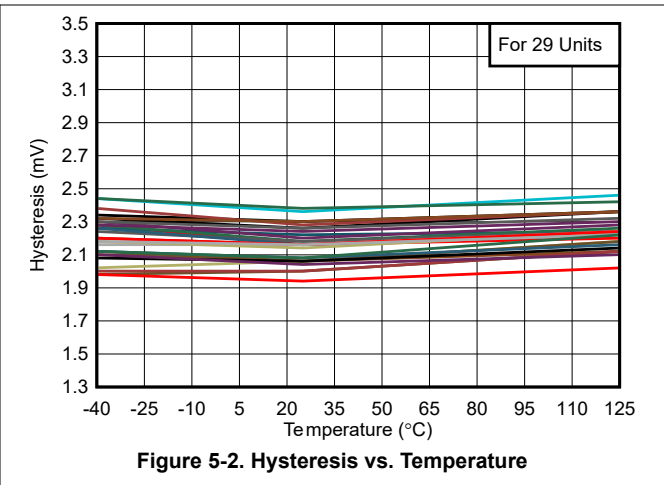
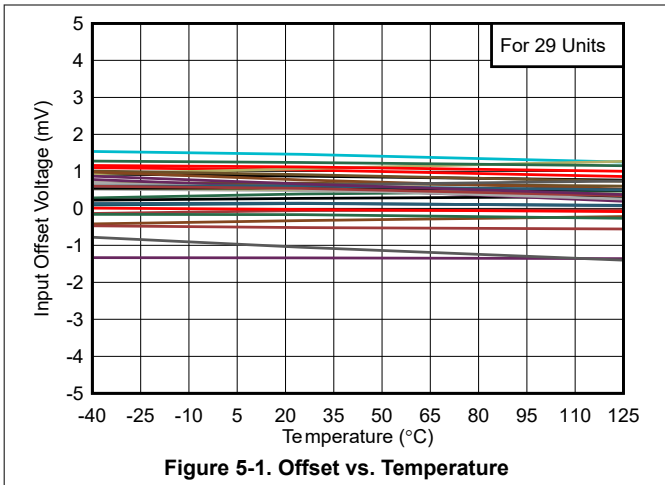

5.7 Typical Characteristics (continued)

$T_A = 25^\circ\text{C}$, $V_S = 5\text{V}$, $C_L = 15\text{pF}$, $V_{CM} = V_S/2\text{V}$, $V_{UNDERDRIVE} = 50\text{mV}$, $V_{OVERDRIVE} = 50\text{mV}$ unless otherwise noted.

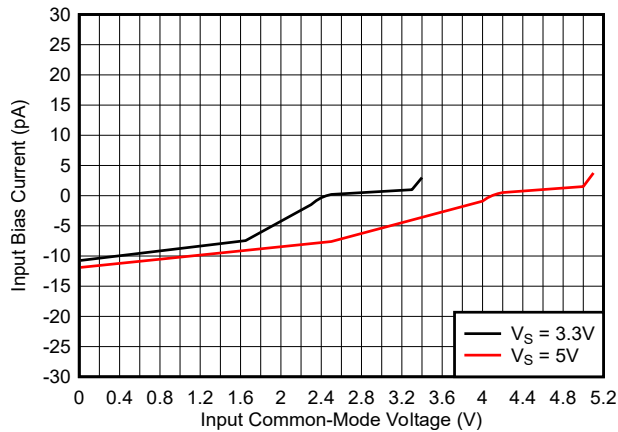

Figure 5-7. Bias Current vs. Common-Mode

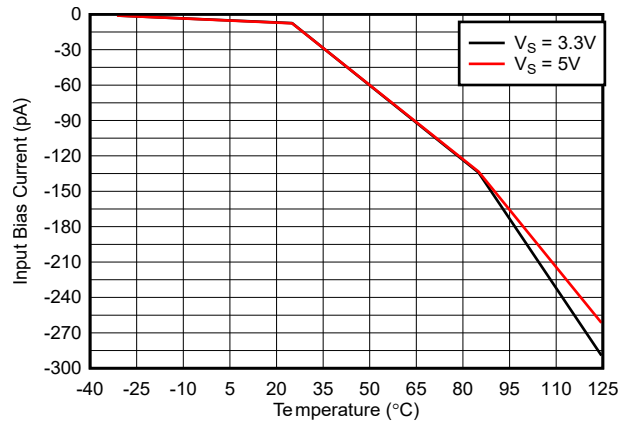

Figure 5-8. Bias Current vs. Temperature

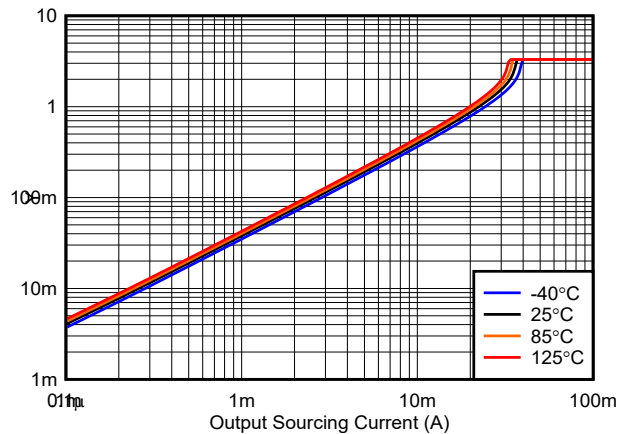

Figure 5-9. Output Voltage vs. Output Sourcing Current, 3.3V

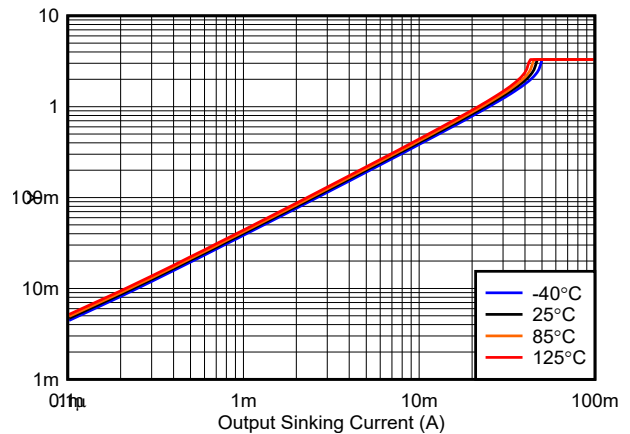

Figure 5-10. Output Voltage vs. Output Sinking Current, 3.3V

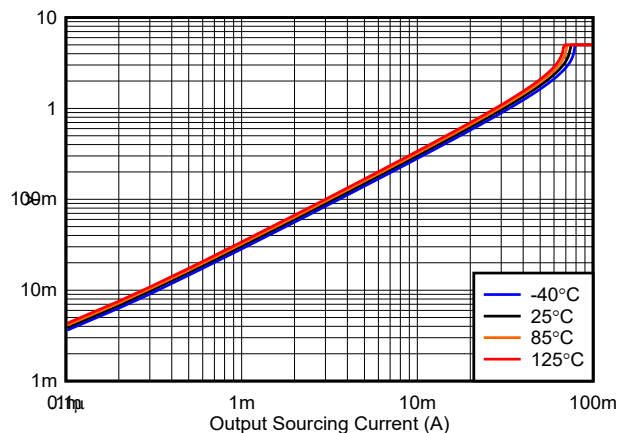

Figure 5-11. Output Voltage vs. Output Sourcing Current, 5V

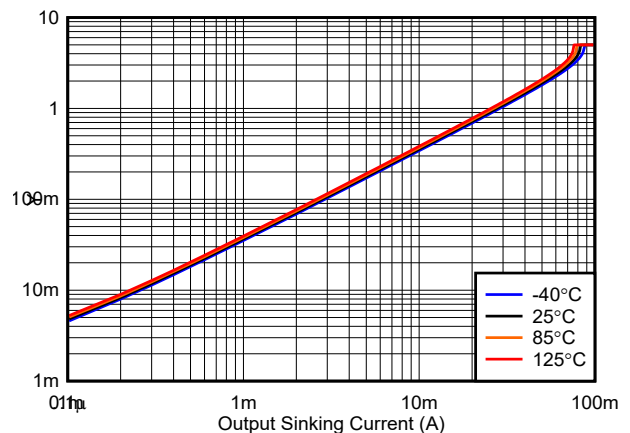

Figure 5-12. Output Voltage vs. Output Sinking Current, 5V

5.7 Typical Characteristics (continued)

$T_A = 25^\circ\text{C}$, $V_S = 5\text{V}$, $C_L = 15\text{pF}$, $V_{CM} = V_S/2\text{V}$, $V_{UNDERDRIVE} = 50\text{mV}$, $V_{OVERDRIVE} = 50\text{mV}$ unless otherwise noted.

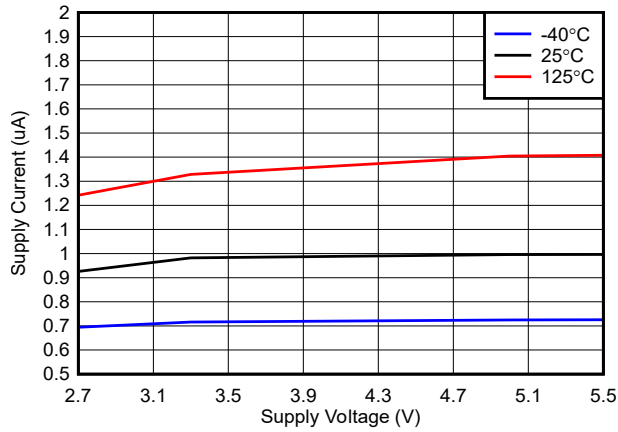

Figure 5-13. Supply Current vs. Supply Voltage (Output Low)

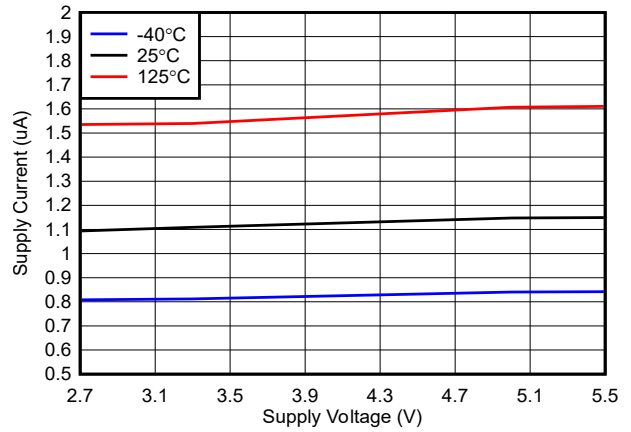

Figure 5-14. Supply Current vs. Supply Voltage (Output High)

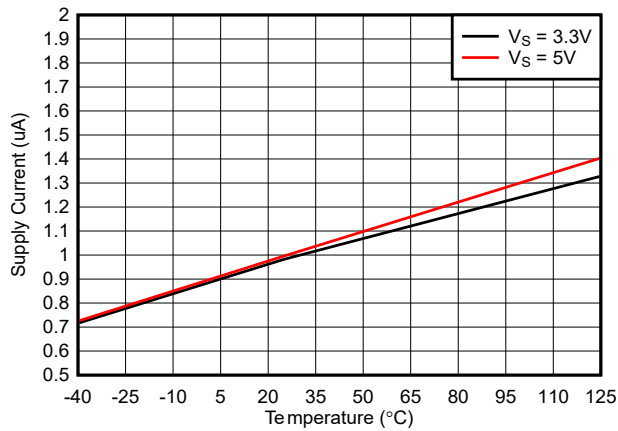

Figure 5-15. Supply Current vs. Temperature (Output Low)

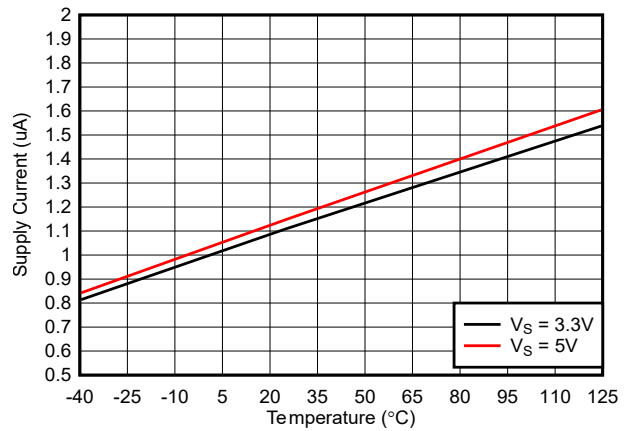

Figure 5-16. Supply Current vs. Temperature (Output High)

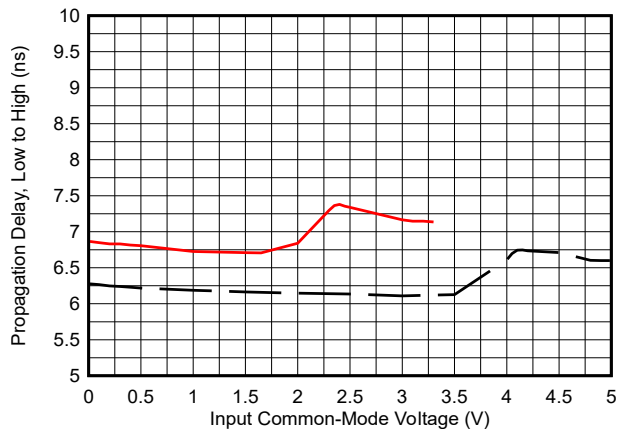

Figure 5-17. Propagation Delay (Low to High) vs. Common-Mode

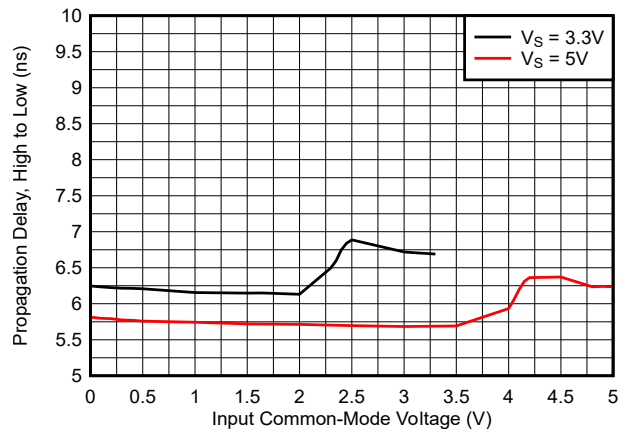

Figure 5-18. Propagation Delay (High to Low) vs. Common-Mode

5.7 Typical Characteristics (continued)

$T_A = 25^\circ\text{C}$, $V_S = 5\text{V}$, $C_L = 15\text{pF}$, $V_{CM} = V_S/2\text{V}$, $V_{UNDERDRIVE} = 50\text{mV}$, $V_{OVERDRIVE} = 50\text{mV}$ unless otherwise noted.

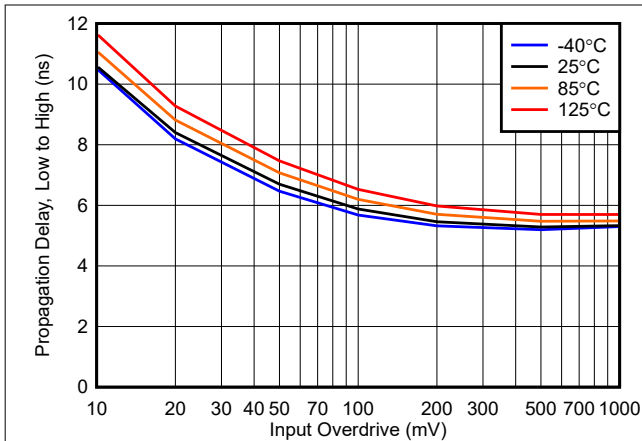

Figure 5-19. Propagation Delay (Low to High) vs. Overdrive (3.3V)

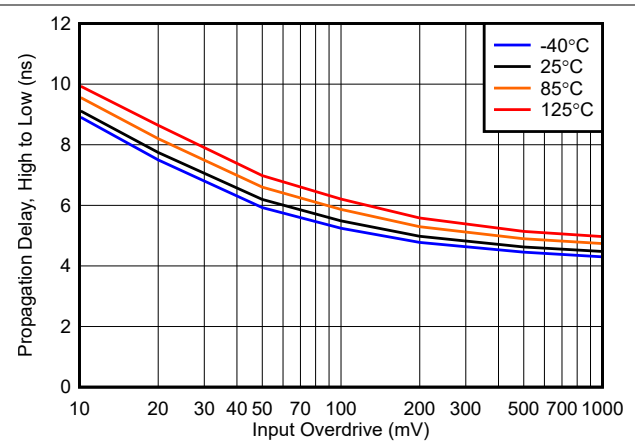

Figure 5-20. Propagation Delay (High to Low) vs. Overdrive (3.3V)

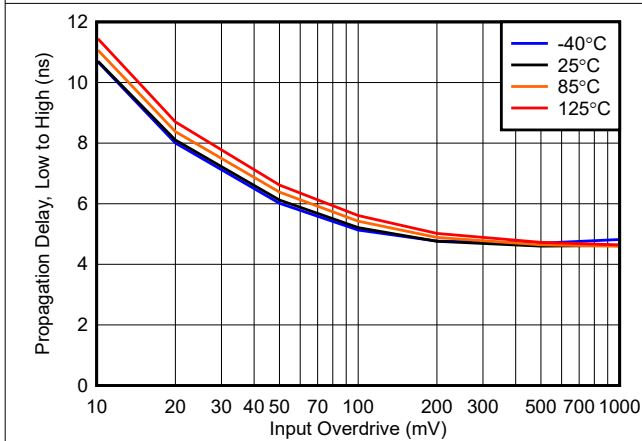

Figure 5-21. Propagation Delay (Low to High) vs. Overdrive (5V)

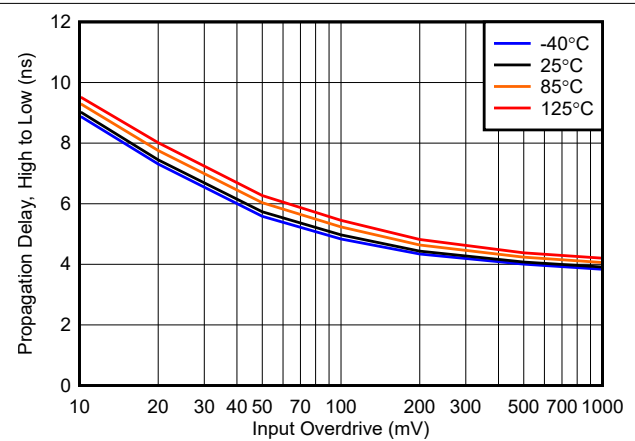

Figure 5-22. Propagation Delay (High to Low) vs. Overdrive (5V)

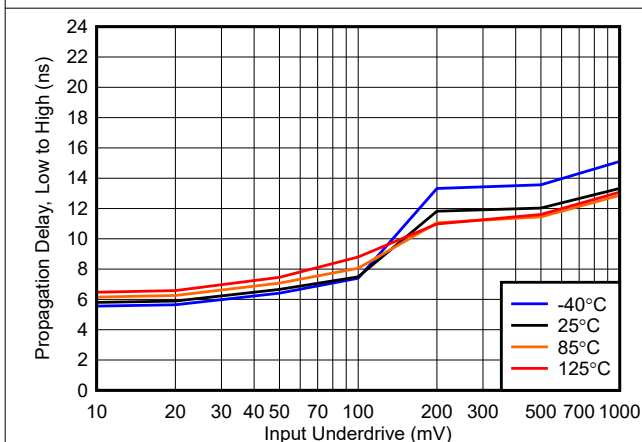

Figure 5-23. Propagation Delay (Low to High) vs. Underdrive (3.3V)

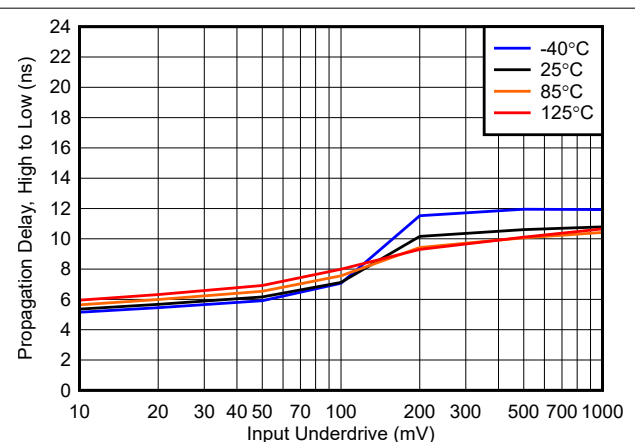

Figure 5-24. Propagation Delay (High to Low) vs. Underdrive (3.3V)

5.7 Typical Characteristics (continued)

$T_A = 25^\circ\text{C}$, $V_S = 5\text{V}$, $C_L = 15\text{pF}$, $V_{CM} = V_S/2\text{V}$, $V_{UNDERDRIVE} = 50\text{mV}$, $V_{OVERDRIVE} = 50\text{mV}$ unless otherwise noted.

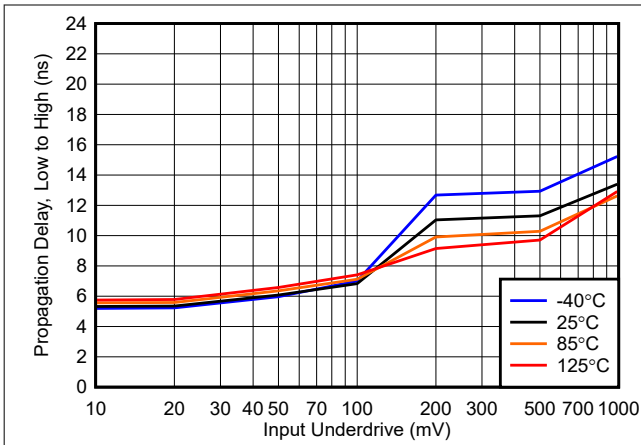

Figure 5-25. Propagation Delay (Low to High) vs. Underdrive (5V)

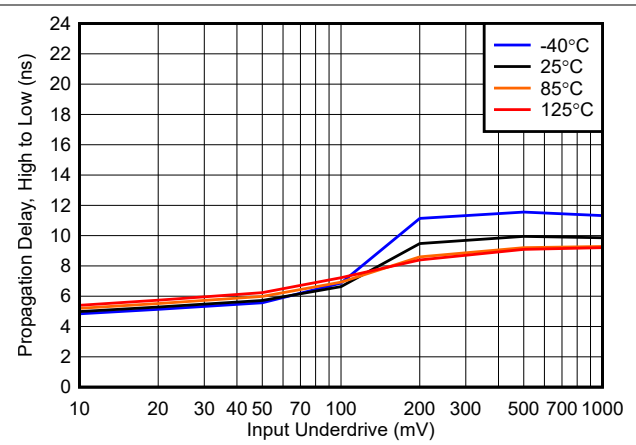

Figure 5-26. Propagation Delay (High to Low) vs. Underdrive (5V)

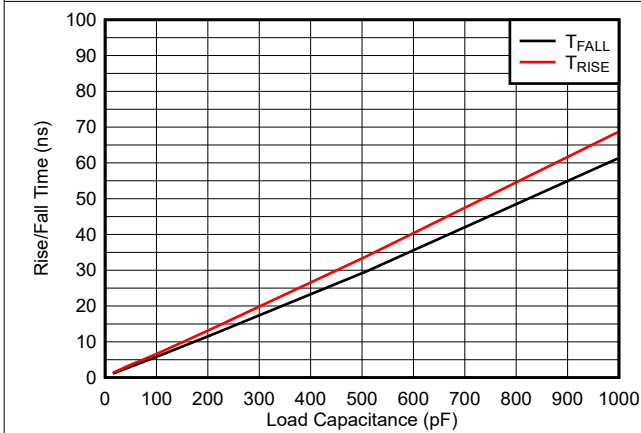

Figure 5-27. Rise and Fall Times vs. Capacitive Loads at 3.3V

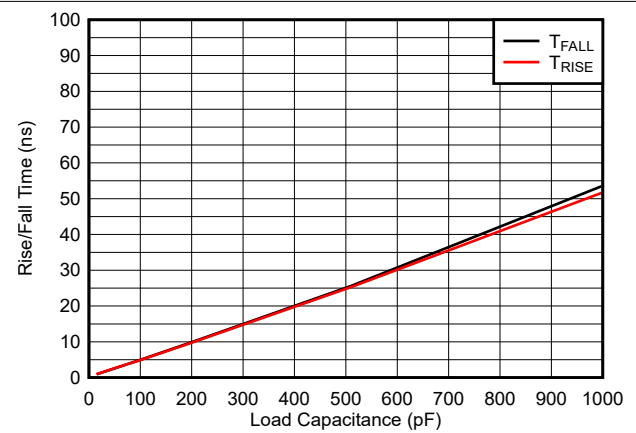

Figure 5-28. Rise and Fall Times vs. Capacitive Loads at 5V

6 Detailed Description

6.1 Overview

The TLV351x devices are high-speed comparators consuming 1mA per channel with 7ns of propagation delay. The TLV351x detects fast voltage and current transients while maintaining low power consumption with single-ended, push-pull outputs

6.2 Functional Block Diagrams

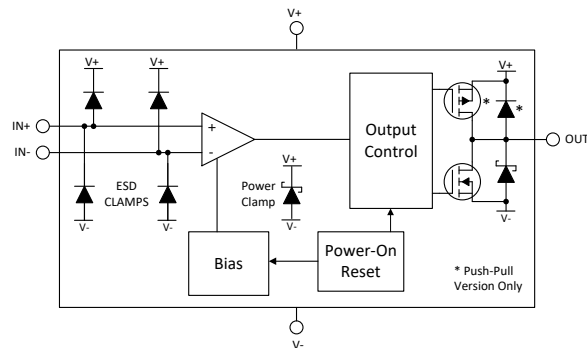

Figure 6-1. Block Diagram

6.3 Feature Description

The TLV351x comparators feature rail-to-rail inputs with integrated hysteresis, single-ended, push-pull outputs, and a Power-ON-Reset function.

6.4 Device Functional Modes

6.4.1 Inputs

The inputs incorporate internal ESD protection circuits to (V+) and (V-). Voltages on the inputs are limited to 0.3V beyond the rails.

When connecting to a low impedance source such as a power supply or buffered reference line, TI recommends adding a current-limiting resistor in series with the input to limit any transient currents if the clamps conduct. Limit the current to 10mA or less. One form of series resistance is any resistive input dividers or networks.

6.4.1.1 Unused Inputs

If a channel is not to be used, DO NOT tie the inputs together. Due to the high equivalent bandwidth and low offset voltage, tying the inputs directly together can cause high frequency oscillations as the device triggers on it's own internal wideband noise. Instead, the inputs can be tied to any available voltage that resides within the specified input voltage range and provides a minimum of 50mV differential voltage. For example, one input can be grounded and the other input connected to a reference voltage, or even (V+).

6.4.2 Internal Hysteresis

The device hysteresis transfer curve is shown below. This curve is a function of three components: V_{TH} , V_{OS} , and V_{HYST} :

- V_{TH} is the actual set voltage or threshold trip voltage.
- V_{OS} is the internal offset voltage between V_{IN+} and V_{IN-} . This voltage is added to V_{TH} to form the actual trip point at which the comparator must respond to change output states.
- V_{HYST} is the internal hysteresis (or trip window) that is designed to reduce comparator sensitivity to noise.

(typically 2mV for the TLV351x family)

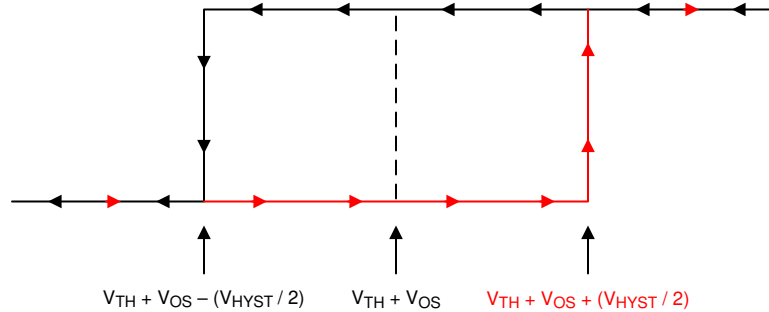

Figure 6-2. Hysteresis Transfer Curve

6.4.3 Outputs

The TLV351x features a push-pull output stage capable of both sinking and sourcing current. This allows driving loads such as LED's and MOSFET gates, as well as eliminating the need for a power-wasting external pull-up resistor. The push-pull output must never be connected to another output.

Directly shorting the output to the supply rails ((V+) when output "low" or (V-) when output "High") can result in thermal runaway and eventual device destruction. If output shorts are possible, a series current limiting resistor is recommended to limit the power dissipation.

Unused push-pull outputs must be left floating, and never tied to a supply, ground, or another output.

6.4.4 ESD Protection

The inputs and outputs incorporate internal ESD protection circuits to (V+) and (V-).

Voltages on the inputs are limited to 0.3V beyond the rails. If the inputs are to be connected to a low impedance source, such as a power supply or buffered reference line, TI recommends adding a current-limiting resistor in series with the input to limit any transient currents in case the clamps conduct. Limit the current to 10mA or less.

6.4.5 Power-On Reset (POR)

The TLV351x devices have an internal Power-on-Reset (POR) circuit for known start-up or power-down conditions. While the power supply (V+) is ramping up or ramping down, the POR circuitry is active for up to 2.1 μ s after the V_{POR} of 2.2V is crossed. When the supply voltage is equal to or greater than the minimum supply voltage, and after the delay period, the comparator output reflects the state of the differential input (V_{ID}).

For the TLV351x devices, the output is held low during the POR period (t_{on}) as shown below.

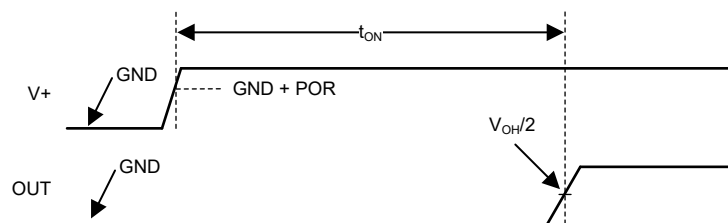

Figure 6-3. Power-On Reset Timing Diagram

7 Application and Implementation

Note

Information in the following applications sections is not part of the TI component specification, and TI does not warrant its accuracy or completeness. TI's customers are responsible for determining suitability of components for their purposes. Customers should validate and test their design implementation to confirm system functionality.

7.1 Application Information

7.1.1 Basic Comparator Definitions

7.1.1.1 Operation

The basic comparator compares the input voltage (V_{IN}) on one input to a reference voltage (V_{REF}) on the other input. In the example below, if V_{IN} is less than V_{REF} , the output voltage (V_O) is logic low (V_{OL}). If V_{IN} is greater than V_{REF} , the output voltage (V_O) is at logic high (V_{OH}). Likewise, the table below summarizes the output conditions. The output logic can be inverted by simply swapping the input pins.

Table 7-1. Output Conditions

Inputs Condition	Output
$IN+ > IN-$	HIGH (V_{OH})
$IN+ = IN-$	Indeterminate (chatters - see Hysteresis)
$IN+ < IN-$	LOW (V_{OL})

7.1.1.2 Propagation Delay

There is a delay between from when the input crosses the reference voltage and the output responds. This is called the Propagation Delay. Propagation delay can be different between high-to-low and low-to-high input transitions. This is shown as t_{pLH} and t_{pHL} in the figure below and is measured from the mid-point of the input to the midpoint of the output.

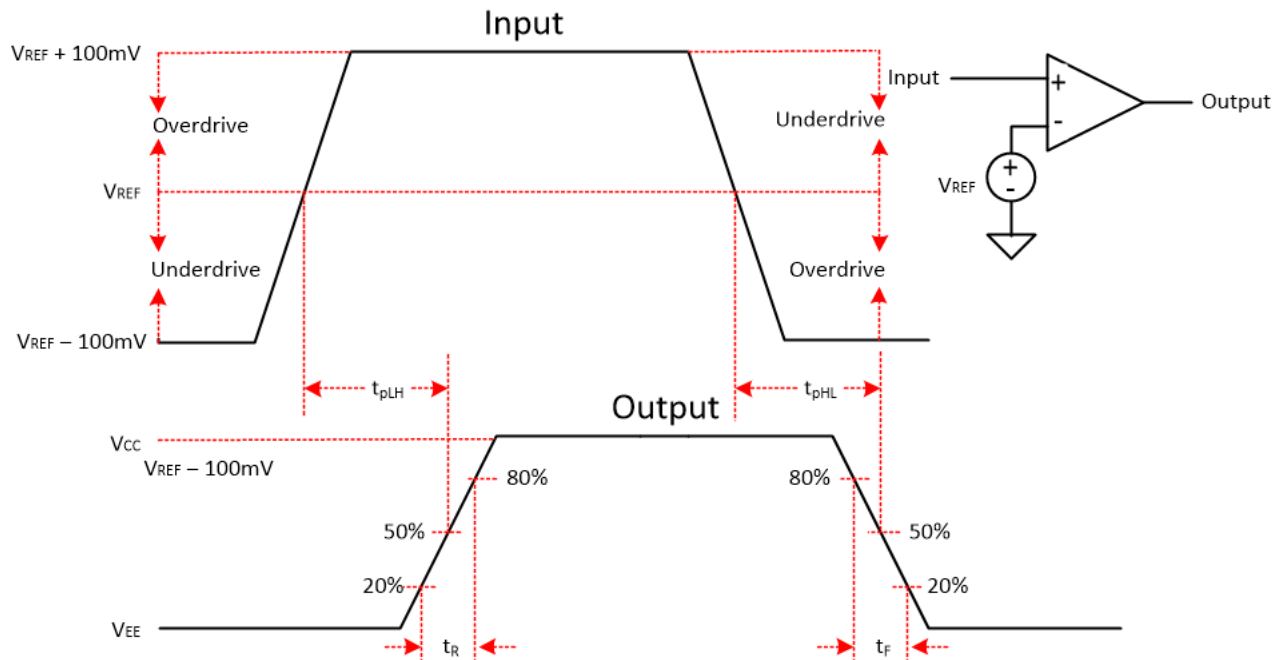

Figure 7-1. Comparator Timing Diagram

7.1.1.3 Overdrive Voltage

The overdrive voltage, V_{OD} , is the amount of input voltage beyond the reference voltage (and not the total input peak-to-peak voltage). The overdrive voltage is 100mV as shown in the above example. The overdrive voltage can influence the propagation delay (t_p). The smaller the overdrive voltage, the longer the propagation delay, particularly when $<100\text{mV}$. If the fastest speeds are desired, it is recommended to apply the highest amount of overdrive possible.

The risetime (t_r) and falltime (t_f) is the time from the 20% and 80% points of the output waveform.

7.1.2 Hysteresis

The basic comparator configuration frequently produces a noisy "chatter" output if the applied differential input voltage is near the comparator's offset voltage. This usually occurs when the input signal is moving very slowly across the switching threshold of the comparator. This problem can be prevented by adding external hysteresis to the comparator.

Since the TLV351x only have a minimal amount of internal hysteresis of 2mV, external hysteresis can be applied in the form of a positive feedback loop that adjusts the trip point of the comparator depending on the current output state.

The hysteresis transfer curve is shown below. This curve is a function of three components: V_{TH} , V_{OS} , and V_{HYST} :

- V_{TH} is the actual set voltage or threshold trip voltage.
- V_{OS} is the internal offset voltage between V_{IN+} and V_{IN-} . This voltage is added to V_{TH} to form the actual trip point at which the comparator must respond to change output states.
- V_{HYST} is the hysteresis (or trip window) that is designed to reduce comparator sensitivity to noise.

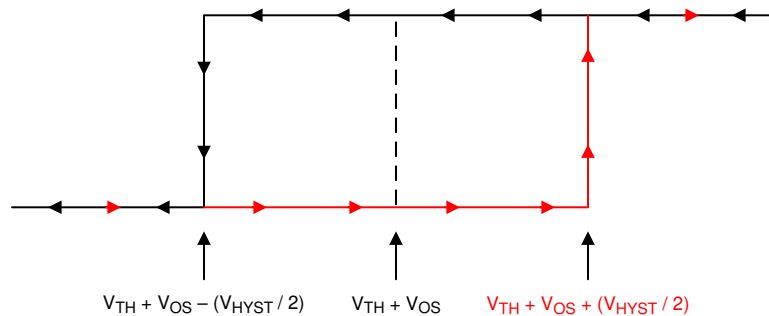

Figure 7-2. Hysteresis Transfer Curve

For more information, please see Application Note SBOA219 "[Comparator with and without hysteresis circuit](#)".

7.1.2.1 Inverting Comparator With Hysteresis

The inverting comparator with hysteresis requires a three-resistor network that is referenced to the comparator supply voltage (V_{CC}), as shown below.

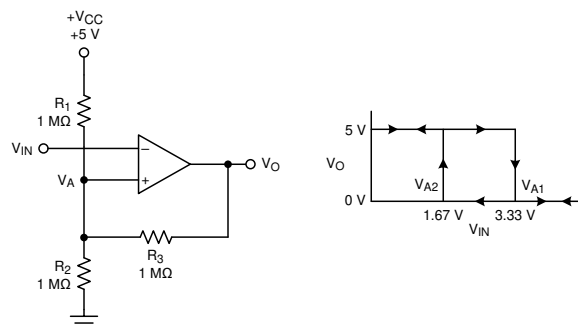

Figure 7-3. TLV351x in an Inverting Configuration With Hysteresis

The equivalent resistor networks when the output is high and low are shown below.

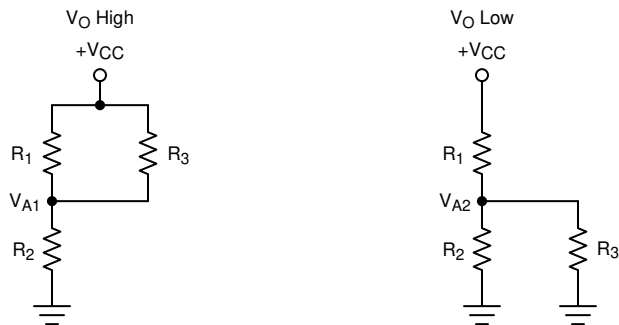

Figure 7-4. Inverting Configuration Resistor Equivalent Networks

When V_{IN} is less than V_A , the output voltage is high (for simplicity, assume V_O switches as high as V_{CC}). The three network resistors can be represented as $R1 \parallel R3$ in series with $R2$, as shown above on the left.

The equation below defines the high-to-low trip voltage (V_{A1}).

$$V_{A1} = V_{CC} \times \frac{R2}{(R1 \parallel R3) + R2} \quad (1)$$

When V_{IN} is greater than V_A , the output voltage is low. In this case, the three network resistors can be presented as $R2 \parallel R3$ in series with $R1$, as shown above on the right.

Use equation below to define the low to high trip voltage (V_{A2}).

$$V_{A2} = V_{CC} \times \frac{R2 \parallel R3}{R1 + (R2 \parallel R3)} \quad (2)$$

The equation below defines the total hysteresis provided by the network.

$$\Delta V_A = V_{A1} - V_{A2} \quad (3)$$

7.1.2.2 Non-Inverting Comparator With Hysteresis

A non-inverting comparator with hysteresis requires a two-resistor network and a voltage reference (V_{REF}) at the inverting input, as shown below.

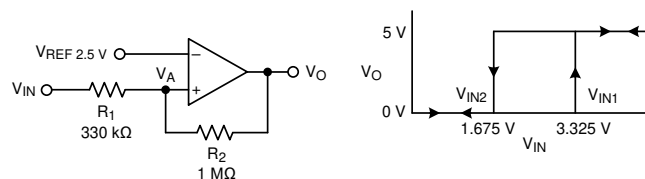

Figure 7-5. TLV351x in a Non-Inverting Configuration With Hysteresis

The equivalent resistor networks when the output is high and low are shown below.

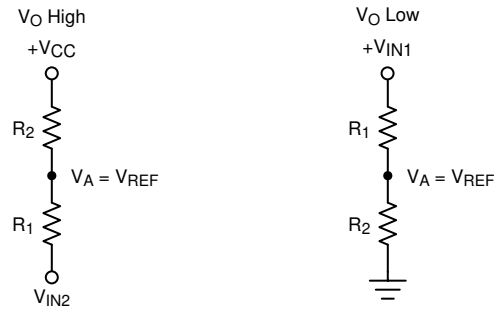

Figure 7-6. Non-Inverting Configuration Resistor Networks

When V_{IN} is less than V_{REF} , the output is low. For the output to switch from low to high, V_{IN} must rise above the V_{IN1} threshold. Use the equation below to calculate V_{IN1} .

$$V_{IN1} = R1 \times \frac{V_{REF}}{R2} + V_{REF} \quad (4)$$

When V_{IN} is greater than V_{REF} , the output is high. For the comparator to switch back to a low state, V_{IN} must drop below V_{IN2} . Use equation below to calculate V_{IN2} .

$$V_{IN2} = \frac{V_{REF} (R1 + R2) - V_{CC} \times R1}{R2} \quad (5)$$

The hysteresis of this circuit is the difference between V_{IN1} and V_{IN2} , as shown below.

$$\Delta V_{IN} = V_{CC} \times \frac{R1}{R2} \quad (6)$$

For more information, please see Application Notes SNOA997 "Inverting comparator with hysteresis circuit" and SBOA313 "Non-Inverting Comparator With Hysteresis Circuit".

7.2 Typical Applications

7.2.1 Low-Side Current Sensing

The figure below shows a simple low-side current sensing circuit using a high-speed comparator. Since this design does not utilize an amplifier, the response time is only limited by the propagation delay of the comparator. With faster response time, the design is well-suited for short-circuit detection when speed is more important than accuracy. When the voltage across the shunt resistor reaches the critical over-current threshold created by R1 and R2, the comparator output changes state.

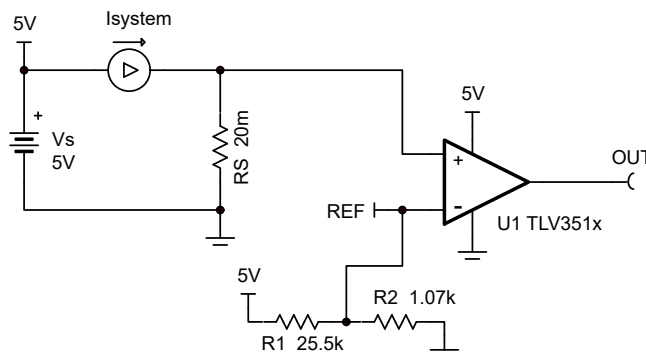

Figure 7-7. Current Sensing

7.2.1.1 Design Requirements

For this design, follow these design requirements:

- Alert (overcurrent) event occurs when system current (I_{system}) reaches 10A
- Alert signal (OUT) is active high
- Operate from a 5V power supply

7.2.1.2 Detailed Design Procedure

To minimize power dissipation and voltage drop across the shunt resistor (R_S), a value of 20m Ω is selected. Since the overcurrent level of 10A creates a 200mV drop across R_S , R_1 and R_2 are calculated to create the voltage divider value of 200mV from the regulated 5V supply voltage. If the system is expected to operate close to the 10A maximum, hysteresis can be added to the design as shown in [Non-Inverting Comparator With Hysteresis](#).

7.2.1.3 Application Curve

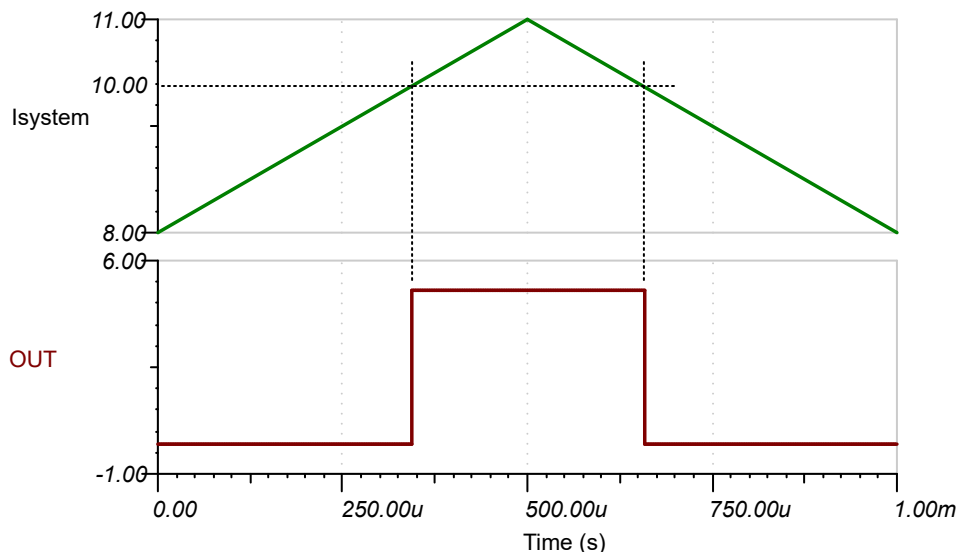

Figure 7-8. Current Sensing Results

7.3 Power Supply Recommendations

Due to the fast output edges, it is critical to have bypass capacitors on the supply pin to prevent supply ringing and false triggers and oscillations. Bypass the supply directly at *each* device with a low ESR 0.1 μ F ceramic bypass capacitor directly between the (V+) pin and ground pins. Narrow peak currents are drawn during the output transition time, particularly for the push-pull output device. These narrow pulses cause un-bypassed supply lines and poor grounds to ring, possibly causing variation that limits the input voltage range and creates an inaccurate comparison or even oscillations.

The device is capable of being powered from both "split" supplies ((V+) & (V-)), or "single" supplies ((V+) and GND), with GND applied to the (V-) pin. Input signals must stay within the recommended input range for either type. Note that with a "split" supply the output now swings "low" (V_{OL}) to (V-) potential and not GND.

7.4 Layout

7.4.1 Layout Guidelines

For accurate comparator applications it is important to maintain a stable power supply with minimized noise and glitches. Output rise and fall times are in the tens of nanoseconds, and need to be treated as high speed logic devices. Place the bypass capacitor as close to the supply pin as possible and connect to a solid ground plane, directly between the (V+) and GND pins.

Minimize coupling between outputs and inputs to prevent output oscillations. Do not run output and input traces in parallel unless there is a (V+) or GND trace between output to reduce coupling. When series resistance is added to inputs, place resistor close to the device. A low value (<100 ohms) resistor added in series with the output dampens any ringing or reflections on long, non-impedance controlled traces. For best edge shapes, use controlled impedance traces with back-terminations when routing long distances.

7.4.2 Layout Example

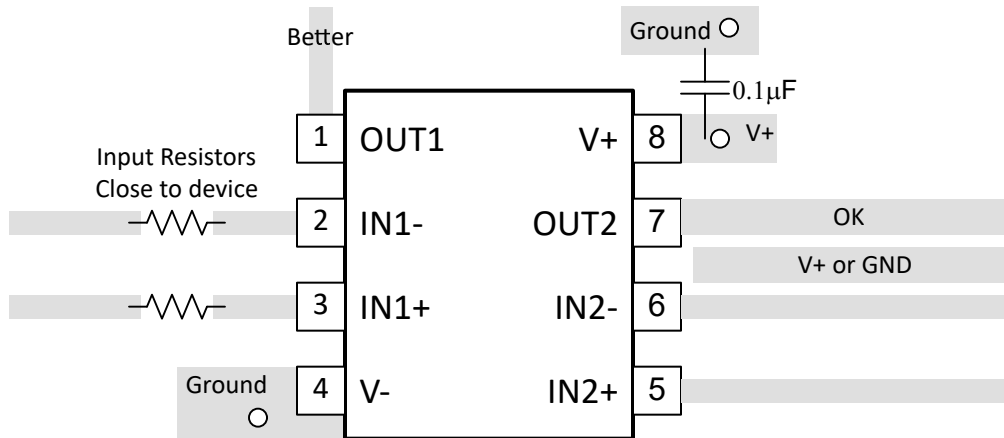

Figure 7-9. Dual Layout Example

8 Device and Documentation Support

8.1 Documentation Support

8.1.1 Related Documentation

[Analog Engineers Circuit Cookbook: Amplifiers \(See Comparators section\) - SLYY137](#)

[Precision Design, Comparator with Hysteresis Reference Design— TIDU020](#)

[Window comparator circuit - SBOA221](#)

[Reference Design, Window Comparator Reference Design— TIPD178](#)

[Comparator with and without hysteresis circuit - SBOA219](#)

[Inverting comparator with hysteresis circuit - SNOA997](#)

[Non-Inverting Comparator With Hysteresis Circuit - SBOA313](#)

[A Quad of Independently Func Comparators - SNOA654](#)

8.2 Receiving Notification of Documentation Updates

To receive notification of documentation updates, navigate to the device product folder on [ti.com](https://www.ti.com). Click on *Notifications* to register and receive a weekly digest of any product information that has changed. For change details, review the revision history included in any revised document.

8.3 Support Resources

[TI E2E™ support forums](#) are an engineer's go-to source for fast, verified answers and design help — straight from the experts. Search existing answers or ask your own question to get the quick design help you need.

Linked content is provided "AS IS" by the respective contributors. They do not constitute TI specifications and do not necessarily reflect TI's views; see TI's [Terms of Use](#).

8.4 Trademarks

TI E2E™ is a trademark of Texas Instruments.

All trademarks are the property of their respective owners.

8.5 Electrostatic Discharge Caution



This integrated circuit can be damaged by ESD. Texas Instruments recommends that all integrated circuits be handled with appropriate precautions. Failure to observe proper handling and installation procedures can cause damage.

ESD damage can range from subtle performance degradation to complete device failure. Precision integrated circuits may be more susceptible to damage because very small parametric changes could cause the device not to meet its published specifications.

8.6 Glossary

[TI Glossary](#) This glossary lists and explains terms, acronyms, and definitions.

9 Revision History

NOTE: Page numbers for previous revisions may differ from page numbers in the current version.

DATE	REVISION	NOTES
December 2024	*	Initial Release

10 Mechanical, Packaging, and Orderable Information

The following pages include mechanical, packaging, and orderable information. This information is the most current data available for the designated devices. This data is subject to change without notice and revision of this document. For browser-based versions of this data sheet, refer to the left-hand navigation.

PACKAGING INFORMATION

Orderable Device	Status (1)	Package Type	Package Drawing	Pins	Package Qty	Eco Plan (2)	Lead finish/ Ball material (6)	MSL Peak Temp (3)	Op Temp (°C)	Device Marking (4/5)	Samples
TLV3511DCKR	ACTIVE	SC70	DCK	5	3000	RoHS & Green	SN	Level-1-260C-UNLIM	-40 to 125	1TH	Samples

(1) The marketing status values are defined as follows:

ACTIVE: Product device recommended for new designs.

LIFEBUY: TI has announced that the device will be discontinued, and a lifetime-buy period is in effect.

NRND: Not recommended for new designs. Device is in production to support existing customers, but TI does not recommend using this part in a new design.

PREVIEW: Device has been announced but is not in production. Samples may or may not be available.

OBSELETE: TI has discontinued the production of the device.

(2) **RoHS:** TI defines "RoHS" to mean semiconductor products that are compliant with the current EU RoHS requirements for all 10 RoHS substances, including the requirement that RoHS substance do not exceed 0.1% by weight in homogeneous materials. Where designed to be soldered at high temperatures, "RoHS" products are suitable for use in specified lead-free processes. TI may reference these types of products as "Pb-Free".

RoHS Exempt: TI defines "RoHS Exempt" to mean products that contain lead but are compliant with EU RoHS pursuant to a specific EU RoHS exemption.

Green: TI defines "Green" to mean the content of Chlorine (Cl) and Bromine (Br) based flame retardants meet JS709B low halogen requirements of <=1000ppm threshold. Antimony trioxide based flame retardants must also meet the <=1000ppm threshold requirement.

(3) MSL, Peak Temp. - The Moisture Sensitivity Level rating according to the JEDEC industry standard classifications, and peak solder temperature.

(4) There may be additional marking, which relates to the logo, the lot trace code information, or the environmental category on the device.

(5) Multiple Device Markings will be inside parentheses. Only one Device Marking contained in parentheses and separated by a "-" will appear on a device. If a line is indented then it is a continuation of the previous line and the two combined represent the entire Device Marking for that device.

(6) Lead finish/Ball material - Orderable Devices may have multiple material finish options. Finish options are separated by a vertical ruled line. Lead finish/Ball material values may wrap to two lines if the finish value exceeds the maximum column width.

Important Information and Disclaimer:The information provided on this page represents TI's knowledge and belief as of the date that it is provided. TI bases its knowledge and belief on information provided by third parties, and makes no representation or warranty as to the accuracy of such information. Efforts are underway to better integrate information from third parties. TI has taken and continues to take reasonable steps to provide representative and accurate information but may not have conducted destructive testing or chemical analysis on incoming materials and chemicals. TI and TI suppliers consider certain information to be proprietary, and thus CAS numbers and other limited information may not be available for release.

In no event shall TI's liability arising out of such information exceed the total purchase price of the TI part(s) at issue in this document sold by TI to Customer on an annual basis.

OTHER QUALIFIED VERSIONS OF TLV3511 :

- Automotive : [TLV3511-Q1](#)

NOTE: Qualified Version Definitions:

- Automotive - Q100 devices qualified for high-reliability automotive applications targeting zero defects

EXAMPLE BOARD LAYOUT

DCK0005A

SOT - 1.1 max height

SMALL OUTLINE TRANSISTOR

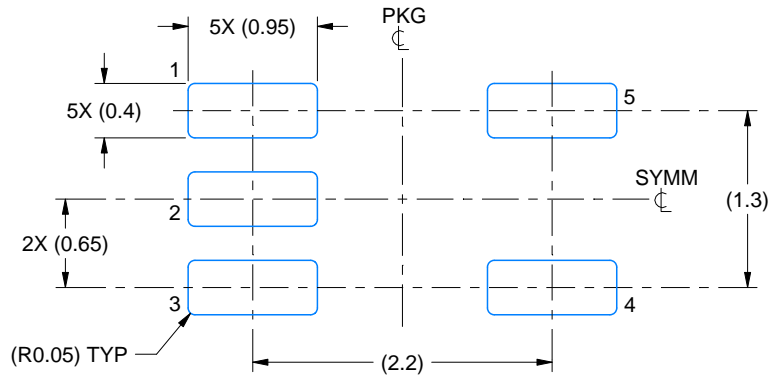

LAND PATTERN EXAMPLE
EXPOSED METAL SHOWN
SCALE:18X

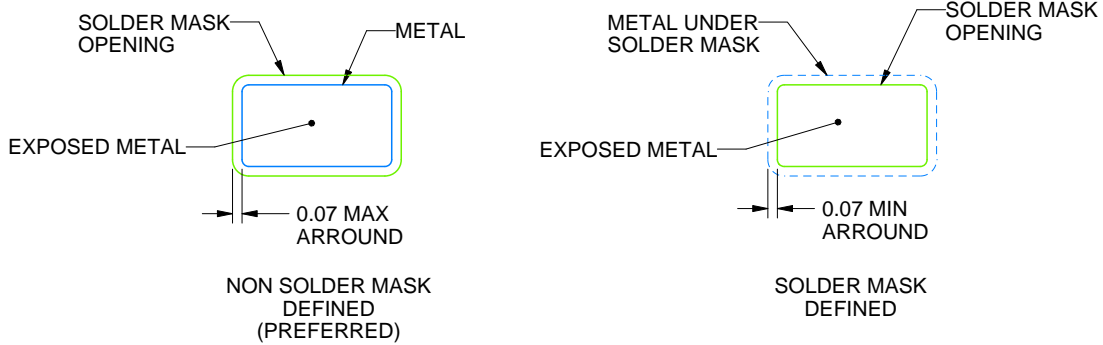

SOLDER MASK DETAILS

4214834/G 11/2024

NOTES: (continued)

- 7. Publication IPC-7351 may have alternate designs.
- 8. Solder mask tolerances between and around signal pads can vary based on board fabrication site.

EXAMPLE STENCIL DESIGN

DCK0005A

SOT - 1.1 max height

SMALL OUTLINE TRANSISTOR

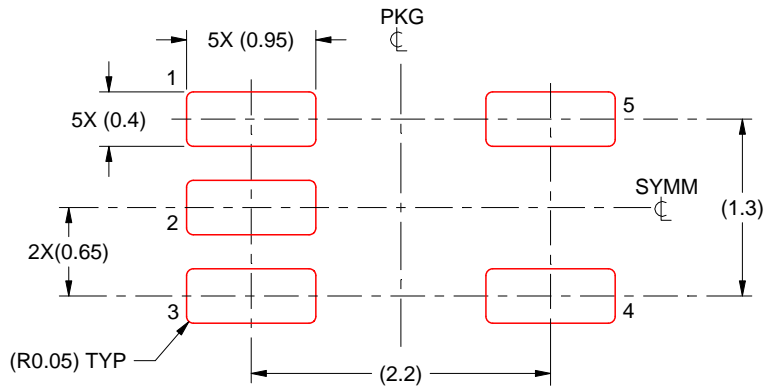

SOLDER PASTE EXAMPLE
BASED ON 0.125 THICK STENCIL
SCALE: 18X

4214834/G 11/2024

NOTES: (continued)

9. Laser cutting apertures with trapezoidal walls and rounded corners may offer better paste release. IPC-7525 may have alternate design recommendations.
10. Board assembly site may have different recommendations for stencil design.

IMPORTANT NOTICE AND DISCLAIMER

TI PROVIDES TECHNICAL AND RELIABILITY DATA (INCLUDING DATA SHEETS), DESIGN RESOURCES (INCLUDING REFERENCE DESIGNS), APPLICATION OR OTHER DESIGN ADVICE, WEB TOOLS, SAFETY INFORMATION, AND OTHER RESOURCES "AS IS" AND WITH ALL FAULTS, AND DISCLAIMS ALL WARRANTIES, EXPRESS AND IMPLIED, INCLUDING WITHOUT LIMITATION ANY IMPLIED WARRANTIES OF MERCHANTABILITY, FITNESS FOR A PARTICULAR PURPOSE OR NON-INFRINGEMENT OF THIRD PARTY INTELLECTUAL PROPERTY RIGHTS.

These resources are intended for skilled developers designing with TI products. You are solely responsible for (1) selecting the appropriate TI products for your application, (2) designing, validating and testing your application, and (3) ensuring your application meets applicable standards, and any other safety, security, regulatory or other requirements.

These resources are subject to change without notice. TI grants you permission to use these resources only for development of an application that uses the TI products described in the resource. Other reproduction and display of these resources is prohibited. No license is granted to any other TI intellectual property right or to any third party intellectual property right. TI disclaims responsibility for, and you will fully indemnify TI and its representatives against, any claims, damages, costs, losses, and liabilities arising out of your use of these resources.

TI's products are provided subject to [TI's Terms of Sale](#) or other applicable terms available either on [ti.com](https://www.ti.com) or provided in conjunction with such TI products. TI's provision of these resources does not expand or otherwise alter TI's applicable warranties or warranty disclaimers for TI products.

TI objects to and rejects any additional or different terms you may have proposed.

Mailing Address: Texas Instruments, Post Office Box 655303, Dallas, Texas 75265

Copyright © 2025, Texas Instruments Incorporated