

## TLV700xx-Q1 300-mA, Low- $I_Q$ , Low-Dropout Regulator

### 1 Features

- Qualified for Automotive Applications
- AEC-Q100 Qualified With the Following Results:
  - Device Temperature Grade 1:  $-40^{\circ}\text{C}$  to  $125^{\circ}\text{C}$  Ambient Operating Temperature Range
  - Device HBM ESD Classification Level H2
  - Device CDM ESD Classification Level C3B
- 2% Accuracy
- Low  $I_Q$ : 35  $\mu\text{A}$
- Fixed-Output Voltages: 1.2 V and 1.8 V
- High PSRR: 68 dB at 1 kHz
- Stable With Effective Capacitance of 0.1  $\mu\text{F}$ <sup>(1)</sup>
- Thermal Shutdown and Overcurrent Protection

<sup>(1)</sup> See the [Input and Output Capacitor Requirements](#).

### 2 Applications

- Automotive Head Units
- Camera Sensors and Modules
- Heads-Up Displays (HUD)
- Telematics Control Units

### 3 Description

The TLV70018-Q1 and TLV70012-Q1 low-dropout (LDO) linear regulators are low quiescent current devices with excellent line and load transient performance. A precision band-gap and error amplifier provides overall 2% accuracy. Low output noise, high power-supply rejection ratio (PSRR), and low-dropout voltage make this series of devices ideal for powering power-sensitive loads. All device versions have thermal shutdown and current limit for detecting fault conditions.

Furthermore, these devices are stable with an effective output capacitance of only 0.1  $\mu\text{F}$ . This feature enables the use of cost-effective capacitors that have higher bias voltages and temperature derating. The devices regulate to specified accuracy with no output load.

#### Device Information<sup>(1)</sup>

PART NUMBER	PACKAGE	BODY SIZE (NOM)
TLV70018-Q1	SOT (5)	2.90 mm x 1.60 mm
TLV70012-Q1		

<sup>(1)</sup> For all available packages, see the orderable addendum at the end of the data sheet.

#### Typical Application

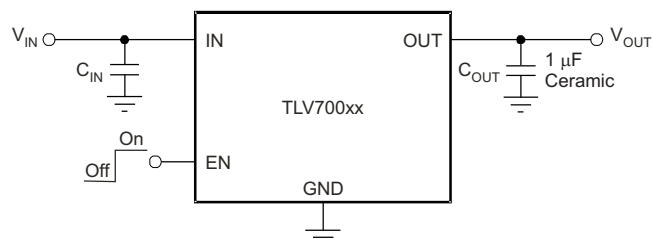

## Table of Contents

<b>1 Features</b> .....	<b>1</b>	8.1 Application Information.....	<b>13</b>
<b>2 Applications</b> .....	<b>1</b>	8.2 Typical Application .....	<b>13</b>
<b>3 Description</b> .....	<b>1</b>	<b>9 Power Supply Recommendations</b> .....	<b>14</b>
<b>4 Revision History</b> .....	<b>2</b>	<b>10 Layout</b> .....	<b>15</b>
<b>5 Pin Configuration and Functions</b> .....	<b>4</b>	10.1 Layout Guidelines .....	<b>15</b>
<b>6 Specifications</b> .....	<b>5</b>	10.2 Layout Example .....	<b>15</b>
6.1 Absolute Maximum Ratings .....	<b>5</b>	10.3 Thermal Considerations .....	<b>15</b>
6.2 ESD Ratings.....	<b>5</b>	10.4 Power Dissipation .....	<b>15</b>
6.3 Recommended Operating Conditions.....	<b>5</b>	<b>11 Device and Documentation Support</b> .....	<b>17</b>
6.4 Thermal Information .....	<b>5</b>	11.1 Device Support.....	<b>17</b>
6.5 Electrical Characteristics.....	<b>6</b>	11.2 Documentation Support .....	<b>17</b>
6.6 Typical Characteristics .....	<b>7</b>	11.3 Related Links .....	<b>17</b>
<b>7 Detailed Description</b> .....	<b>11</b>	11.4 Receiving Notification of Documentation Updates	<b>17</b>
7.1 Overview .....	<b>11</b>	11.5 Community Resources.....	<b>17</b>
7.2 Functional Block Diagrams .....	<b>11</b>	11.6 Trademarks .....	<b>17</b>
7.3 Feature Description.....	<b>11</b>	11.7 Electrostatic Discharge Caution.....	<b>17</b>
7.4 Device Functional Modes.....	<b>12</b>	11.8 Glossary .....	<b>17</b>
<b>8 Application and Implementation</b> .....	<b>13</b>	<b>12 Mechanical, Packaging, and Orderable Information</b> .....	<b>18</b>

## 4 Revision History

NOTE: Page numbers for previous revisions may differ from page numbers in the current version.

### Changes from Revision B (January 2016) to Revision C

Page

• Changed <i>Fixed-Output Voltage</i> Features bullet from <i>Fixed-Output Voltage Combinations Possible from 1.2 V to 4.8 V to Fixed-Output Voltages: 1.2 V and 1.8 V</i> .....	<b>1</b>
• Changed <i>Applications</i> section .....	<b>1</b>
• Changed first paragraph of <i>Description</i> section: changed <i>TLV700xx-Q1 series to TLV70018-Q1 and TLV70012-Q1</i> , deleted second sentence, changed <i>a wide selection of battery-operated handheld equipment to powering power-sensitive loads</i> , and changed <i>safety to detecting fault conditions</i> .....	<b>1</b>
• Deleted <i>Fixed-Voltage Version</i> from <i>Typical Application</i> title .....	<b>1</b>
• Changed <i>Input voltage</i> parameter: changed symbol from $V_I$ to $V_{IN}$ , moved EN and OUT rows to standalone parameters .....	<b>5</b>
• Changed maximum specification of <i>Output voltage</i> parameter from 5.5 V to 1.8 V .....	<b>5</b>
• Added $I_{OUT}$ symbol to <i>Current output</i> parameter .....	<b>5</b>
• Deleted TLV70018-Q1 column from <i>Thermal Information</i> table .....	<b>5</b>
• Added TLV70018-Q1 to TLV70012-Q1 column in <i>Thermal Information</i> table; all thermal values for TLV70018-Q1 changed to the TLV70012-Q1 thermal values.....	<b>5</b>
• Changed $V_{OUT(TYP)}$ to $V_{OUT(NOM)}$ in conditions statement of <i>Electrical Characteristics</i> table .....	<b>6</b>
• Changed symbols for <i>Line regulation</i> , <i>Load regulation</i> , and <i>Output noise voltage</i> parameters from $\Delta V_O/\Delta V_{IN}$ to $\Delta V_{OUT}/\Delta V_{IN}$ , $\Delta V_O/\Delta I_{OUT}$ to $\Delta V_{OUT}/\Delta I_{OUT}$ , and $V_N$ to $V_n$ (respectively) in <i>Electrical Characteristics</i> table.....	<b>6</b>
• Changed $V_{OUT(TYP)}$ to $V_{OUT(NOM)}$ in <i>Typical Characteristics</i> conditions statement .....	<b>7</b>
• Deleted <i>Dropout Voltage vs Input Voltage</i> and <i>Dropout Voltage vs Output Current</i> curves .....	<b>7</b>
• Changed <i>TLV700xx-Q1 to TLV70018-Q1 and TLV70012-Q1</i> in <i>Overview</i> section .....	<b>11</b>
• Added <i>TLV70012-Q1</i> to sub-sections of <i>Feature Description</i> and <i>Device Functional Modes</i> sections .....	<b>11</b>
• Changed 160°C to 165°C, 140°C to 145°C, and 35°C to 40°C in <i>Thermal Shutdown</i> section .....	<b>12</b>
• Changed <i>Application Information</i> section: changed first two sentences, deleted second paragraph .....	<b>13</b>
• Changed <i>Example Value</i> column values for 2nd and 3rd rows in Design Parameters table.....	<b>13</b>
• Added TLV70012-Q1 to <i>Input and Output Capacitor Requirements</i> section .....	<b>14</b>
• Deleted first and last paragraphs from <i>Thermal Considerations</i> section .....	<b>15</b>

**Revision History (continued)**

- Deleted second sentence from second paragraph of *Power Dissipation* section ..... 15
  - Added TLV70012-Q1 to *Power Dissipation* section ..... 15
- 

**Changes from Revision A (March 2012) to Revision B**
**Page**

- Added *ESD Ratings* table, *Recommended Operating Conditions* table, *Thermal Information* table, *Detailed Description* section, *Application and Implementation* section, *Application and Implementation* section, *Layout* section, *Device and Documentation Support* section, and *Mechanical, Packaging, and Orderable Information* section..... 1
  - Deleted the *Dissipation Ratings* table..... 5
-

## 5 Pin Configuration and Functions

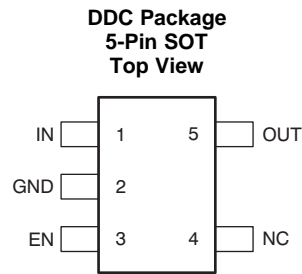

### Pin Functions

PIN		DESCRIPTION
NO.	NAME	
1	IN	Input pin. A small 1- $\mu$ F ceramic capacitor is recommended from this pin to ground to assure stability and good transient performance. <sup>(1)</sup>
2	GND	Ground pin
3	EN	Enable pin. Driving EN over 0.9 V turns on the regulator. Driving EN below 0.4 V puts the regulator into shutdown mode and reduces operating current to 1 $\mu$ A, nominal.
4	NC	No connection. This pin can be tied to ground to improve thermal dissipation.
5	OUT	Regulated output voltage pin. A small 1- $\mu$ F ceramic capacitor is needed from this pin to ground to assure stability. <sup>(1)</sup>

(1) See [Input and Output Capacitor Requirements](#) section for more details.

## 6 Specifications

### 6.1 Absolute Maximum Ratings

over operating free-air temperature range, unless otherwise noted. <sup>(1)</sup>

		MIN	MAX	UNIT
Voltage <sup>(2)</sup>	IN	-0.3	6.0	V
	EN	-0.3	6.0	V
	OUT	-0.3	6.0	V
Current (source)	OUT	Internally Limited		
Output short-circuit duration		Indefinite		
Operating virtual junction, T <sub>J</sub>		-55	150	°C
Storage temperature, T <sub>stg</sub>		-55	150	°C

- (1) Stresses beyond those listed under *Absolute Maximum Ratings* may cause permanent damage to the device. These are stress ratings only, which do not imply functional operation of the device at these or any other conditions beyond those indicated under *Recommended Operating Conditions*. Exposure to absolute-maximum-rated conditions for extended periods may affect device reliability.
- (2) All voltages are with respect to network ground terminal.

### 6.2 ESD Ratings

		VALUE	UNIT
V <sub>(ESD)</sub> Electrostatic discharge	Human-body model (HBM), per AEC Q100-002 <sup>(1)</sup>	2000	V
	Charged-device model (CDM), per AEC Q100-011	750	

- (1) AEC Q100-002 indicates that HBM stressing shall be in accordance with the ANSI/ESDA/JEDEC JS-001 specification.

### 6.3 Recommended Operating Conditions

over operating free-air temperature range, unless otherwise noted.

			MIN	MAX	UNIT
V <sub>IN</sub>	Input voltage	IN	2	5.5	V
V <sub>EN</sub>	Enable voltage	EN	0	5.5	V
V <sub>OUT</sub>	Output voltage	OUT	0	1.8	V
I <sub>OUT</sub>	Current output		0	300	mA
T <sub>J</sub>	Operating junction temperature		-40	150	°C

### 6.4 Thermal Information

THERMAL METRIC <sup>(1)</sup>		TLV70018-Q1, TLV70012-Q1	UNIT
		DDC (SOT)	
		5 PINS	
R <sub>θJA</sub>	Junction-to-ambient thermal resistance	262.8	°C/W
R <sub>θJC(top)</sub>	Junction-to-case (top) thermal resistance	68.2	°C/W
R <sub>θJB</sub>	Junction-to-board thermal resistance	81.6	°C/W
ψ <sub>JT</sub>	Junction-to-top characterization parameter	1.1	°C/W
ψ <sub>JB</sub>	Junction-to-board characterization parameter	80.9	°C/W
R <sub>θJC(bot)</sub>	Junction-to-case (bottom) thermal resistance	NA	°C/W

- (1) For more information about traditional and new thermal metrics, see the *Semiconductor and IC Package Thermal Metrics* application report.

## 6.5 Electrical Characteristics

At  $V_{IN} = V_{OUT(NOM)} + 0.5\text{ V}$  or  $2\text{ V}$  (whichever is greater);  $I_{OUT} = 10\text{ mA}$ ,  $V_{EN} = 0.9\text{ V}$ ,  $C_{OUT} = 1.0\text{ }\mu\text{F}$ , and  $T_A = -40^\circ\text{C}$  to  $125^\circ\text{C}$ , unless otherwise noted. Typical values are at  $T_A = 25^\circ\text{C}$ , unless otherwise noted.

PARAMETER		TEST CONDITIONS	MIN	TYP	MAX	UNIT
$V_{IN}$	Input voltage range		2		5.5	V
$V_{OUT}$	DC output accuracy	$-40^\circ\text{C} \leq T_A \leq 125^\circ\text{C}$	-2%	0.5%	2%	
$\Delta V_{OUT}/\Delta V_{IN}$	Line regulation	$V_{OUT(NOM)} + 0.5\text{ V} \leq V_{IN} \leq 5.5\text{ V}$ , $I_{OUT} = 10\text{ mA}$		1	5	mV
$\Delta V_{OUT}/\Delta I_{OUT}$	Load regulation	$0\text{ mA} \leq I_{OUT} \leq 300\text{ mA}$ , TLV70018-Q1		1	15	mV
		$0\text{ mA} \leq I_{OUT} \leq 300\text{ mA}$ , TLV70012-Q1		1	20	
$I_{CL}$	Output current limit	$V_{OUT} = 0.9 \times V_{OUT(NOM)}$	320	500	860	mA
$I_{GND}$	Ground pin current	$I_{OUT} = 0\text{ mA}$		35	55	$\mu\text{A}$
		$I_{OUT} = 300\text{ mA}$ , $V_{IN} = V_{OUT} + 0.5\text{ V}$		370		$\mu\text{A}$
$I_{SHDN}$	Ground pin current (shutdown)	$V_{EN} \leq 0.4\text{ V}$ , $V_{IN} = 2.0\text{ V}$		400		nA
		$V_{EN} \leq 0.4\text{ V}$ , $2.0\text{ V} \leq V_{IN} \leq 4.5\text{ V}$ , $T_A = -40^\circ\text{C}$ to $85^\circ\text{C}$		1	2	$\mu\text{A}$
		$V_{EN} \leq 0.4\text{ V}$ , $2.0\text{ V} \leq V_{IN} \leq 4.5\text{ V}$ , $T_A = 85^\circ\text{C}$ to $125^\circ\text{C}$		1	2.5	$\mu\text{A}$
PSRR	Power-supply rejection ratio	$V_{IN} = 2.3\text{ V}$ , $V_{OUT} = 1.8\text{ V}$ , $I_{OUT} = 10\text{ mA}$ , $f = 1\text{ kHz}$		68		dB
$V_n$	Output noise voltage	BW = 100 Hz to 100 kHz, $V_{IN} = 2.3\text{ V}$ , $V_{OUT} = 1.8\text{ V}$ , $I_{OUT} = 10\text{ mA}$		48		$\mu\text{V}_{RMS}$
$t_{STR}$	Startup time <sup>(1)</sup>	$C_{OUT} = 1.0\text{ }\mu\text{F}$ , $I_{OUT} = 300\text{ mA}$		100		$\mu\text{s}$
$V_{EN(HI)}$	Enable pin high (enabled)		0.9		$V_{IN}$	V
$V_{EN(LO)}$	Enable pin low (disabled)		0		0.4	V
$I_{EN}$	Enable pin current	$V_{IN} = V_{EN} = 5.5\text{ V}$		0.04		$\mu\text{A}$
UVLO	Undervoltage lockout	$V_{IN}$ rising		1.9		V
$T_{SD}$	Thermal shutdown temperature	Shutdown, temperature increasing		165		$^\circ\text{C}$
		Reset, temperature decreasing		145		$^\circ\text{C}$
$T_A$	Operating temperature		-40		125	$^\circ\text{C}$

(1) Startup time = time from EN assertion to  $0.98 \times V_{OUT(NOM)}$ .

### 6.6 Typical Characteristics

Over operating temperature range ( $T_J = -40^\circ\text{C}$  to  $125^\circ\text{C}$ ),  $V_{IN} = V_{OUT(NOM)} + 0.5\text{ V}$  or  $2\text{ V}$ , whichever is greater;  $I_{OUT} = 10\text{ mA}$ ,  $V_{EN} = V_{IN}$ ,  $C_{OUT} = 1.0\ \mu\text{F}$ , unless otherwise noted. Typical values are at  $T_J = 25^\circ\text{C}$ .

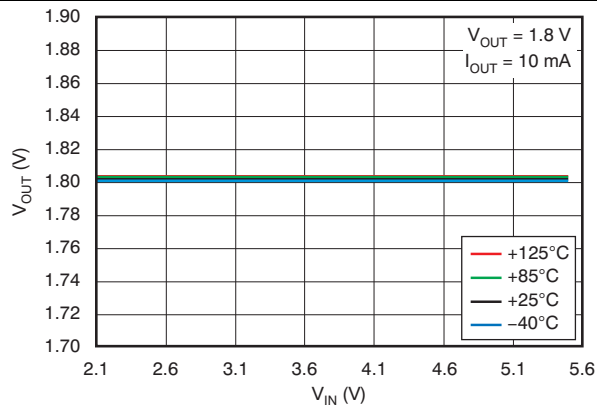

Figure 1. Line Regulation 10 mA

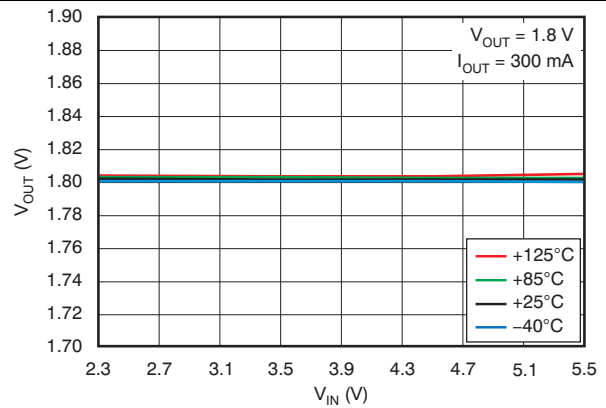

Figure 2. Line Regulation 300 mA

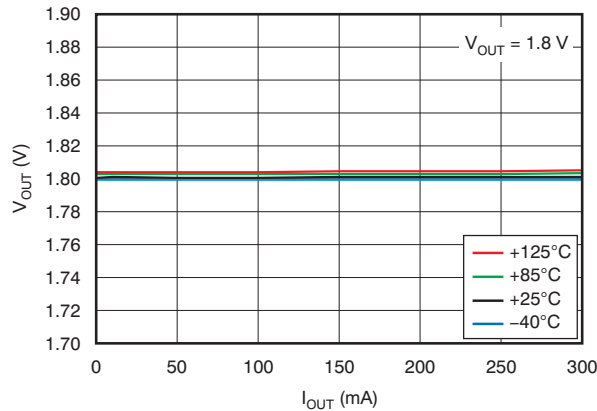

Figure 3. Load Regulation

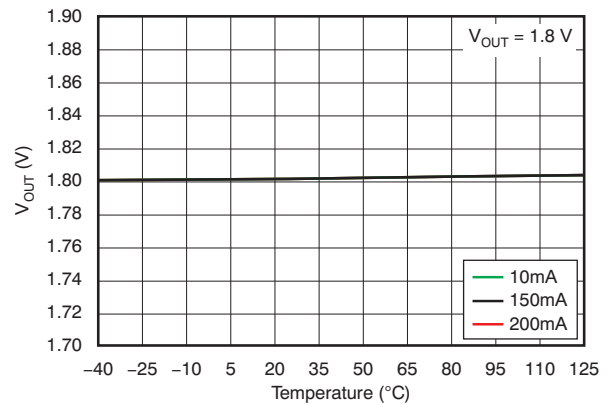

Figure 4. Output Voltage vs Temperature

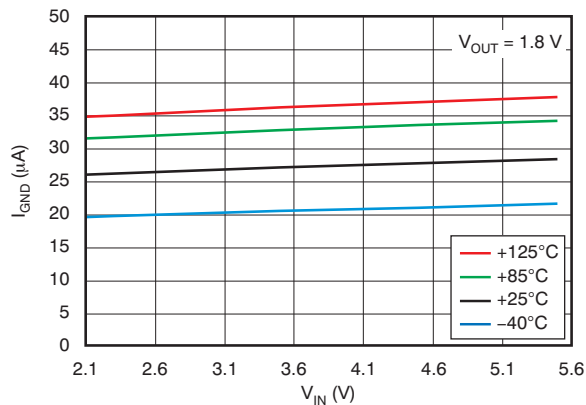

Figure 5. Ground Pin Current vs Input Voltage

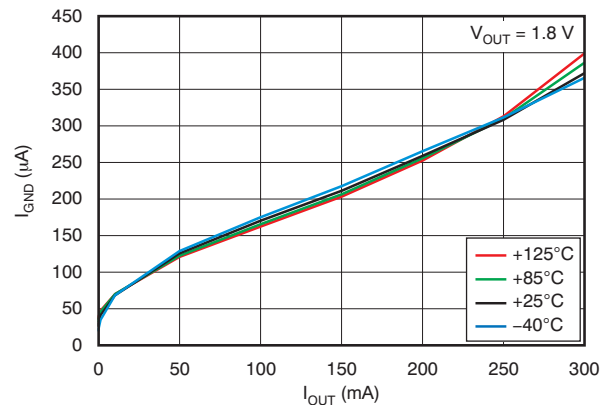
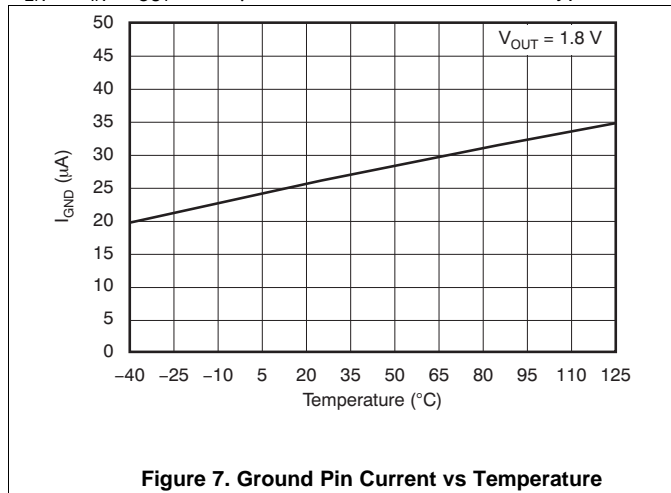

Figure 6. Ground Pin Current vs Load

**Typical Characteristics (continued)**

Over operating temperature range ( $T_J = -40^{\circ}\text{C}$  to  $125^{\circ}\text{C}$ ),  $V_{IN} = V_{OUT(NOM)} + 0.5\text{ V}$  or  $2\text{ V}$ , whichever is greater;  $I_{OUT} = 10\text{ mA}$ ,  $V_{EN} = V_{IN}$ ,  $C_{OUT} = 1.0\text{ }\mu\text{F}$ , unless otherwise noted. Typical values are at  $T_J = 25^{\circ}\text{C}$ .



**Figure 7. Ground Pin Current vs Temperature**

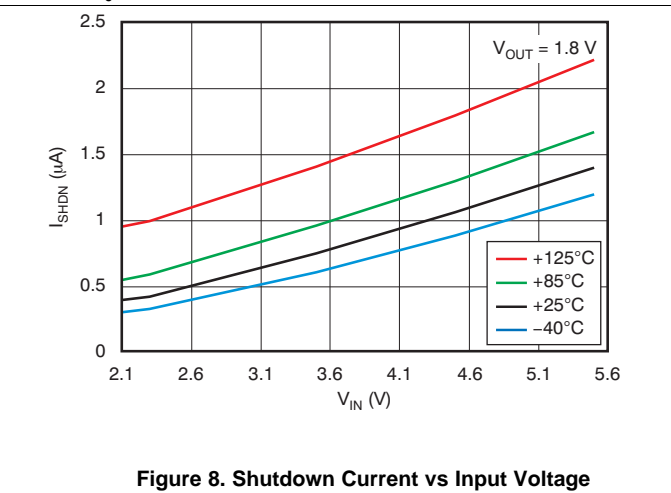

**Figure 8. Shutdown Current vs Input Voltage**

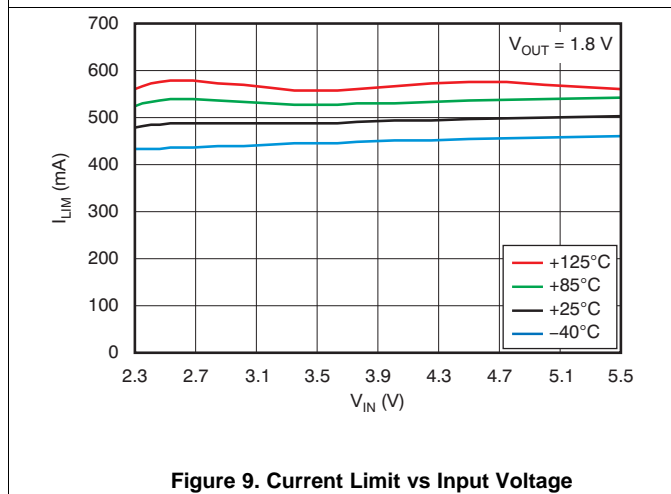

**Figure 9. Current Limit vs Input Voltage**

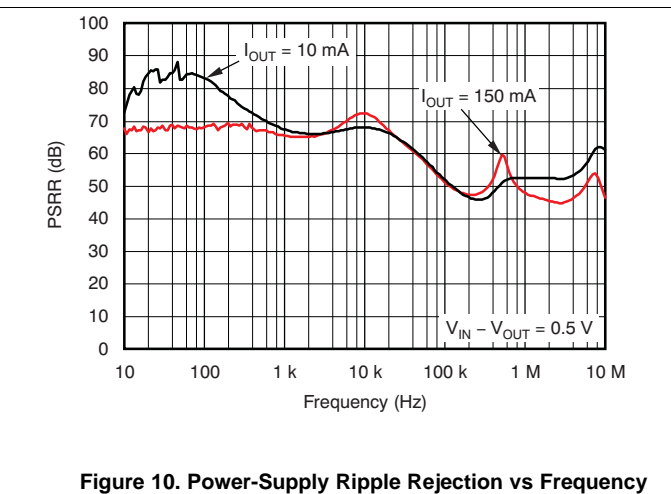

**Figure 10. Power-Supply Ripple Rejection vs Frequency**

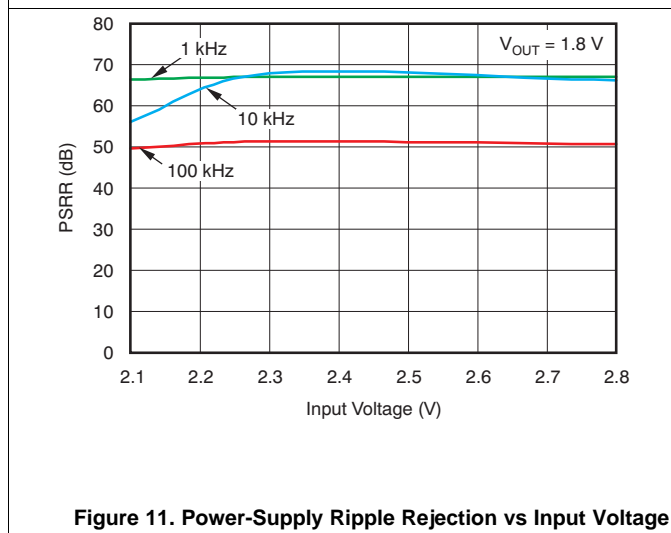

**Figure 11. Power-Supply Ripple Rejection vs Input Voltage**

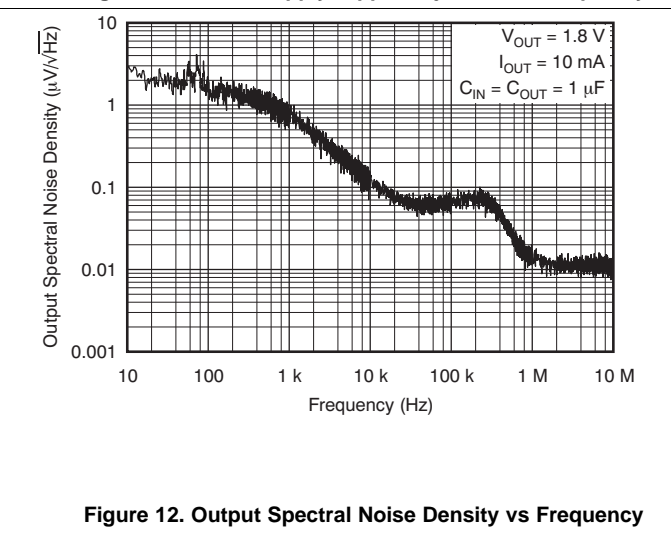

**Figure 12. Output Spectral Noise Density vs Frequency**



Typical Characteristics (continued)

Over operating temperature range ( $T_J = -40^{\circ}\text{C}$  to  $125^{\circ}\text{C}$ ),  $V_{IN} = V_{OUT(NOM)} + 0.5\text{ V}$  or  $2\text{ V}$ , whichever is greater;  $I_{OUT} = 10\text{ mA}$ ,  $V_{EN} = V_{IN}$ ,  $C_{OUT} = 1.0\ \mu\text{F}$ , unless otherwise noted. Typical values are at  $T_J = 25^{\circ}\text{C}$ .

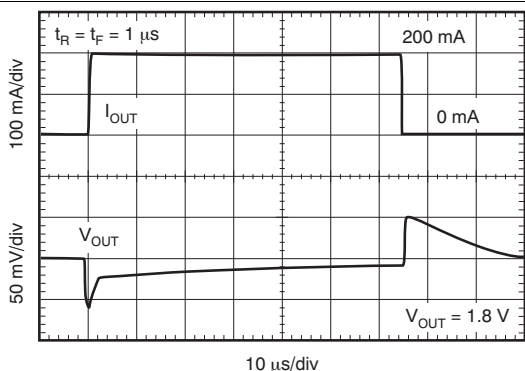

Figure 13. Load Transient Response

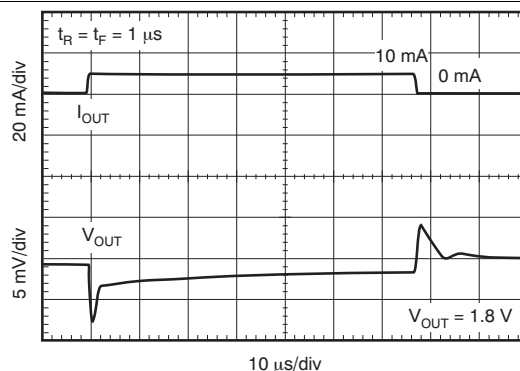

Figure 14. Load Transient Response

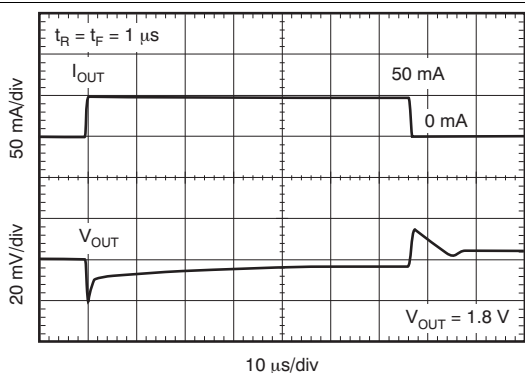

Figure 15. Load Transient Response

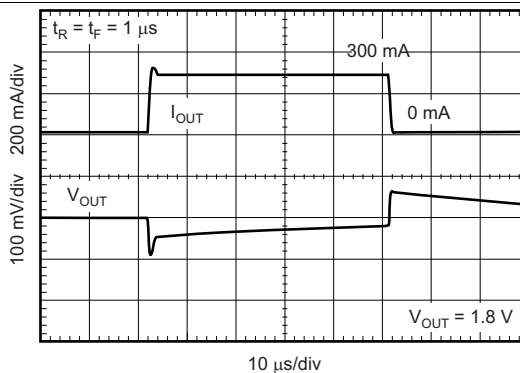

Figure 16. Load Transient Response

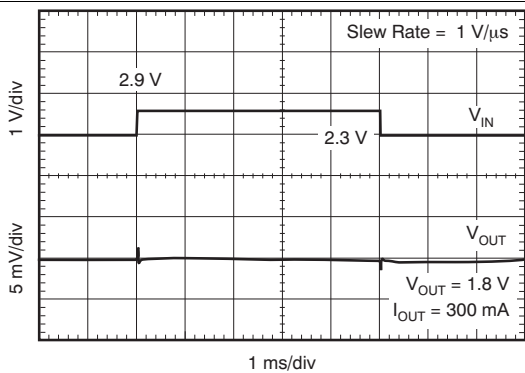

Figure 17. Line Transient Response

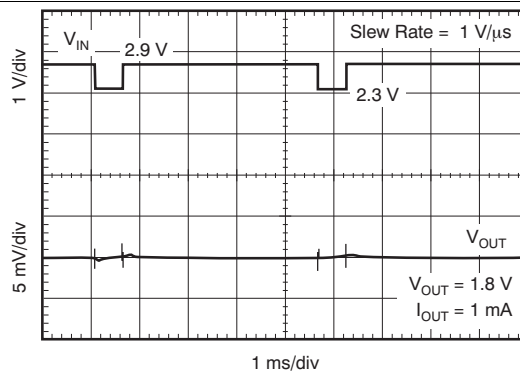
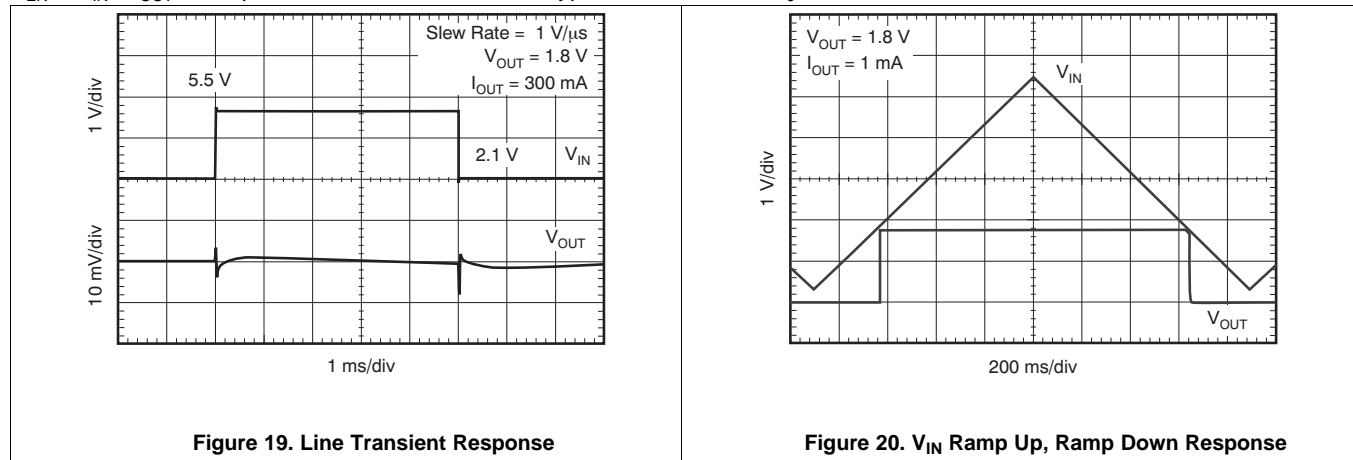

Figure 18. Line Transient Response

**Typical Characteristics (continued)**

Over operating temperature range ( $T_J = -40^\circ\text{C}$  to  $125^\circ\text{C}$ ),  $V_{IN} = V_{OUT(NOM)} + 0.5\text{ V}$  or  $2\text{ V}$ , whichever is greater;  $I_{OUT} = 10\text{ mA}$ ,  $V_{EN} = V_{IN}$ ,  $C_{OUT} = 1.0\ \mu\text{F}$ , unless otherwise noted. Typical values are at  $T_J = 25^\circ\text{C}$ .



## 7 Detailed Description

### 7.1 Overview

The TLV70018-Q1 and TLV70012-Q1 low-dropout (LDO) linear regulators are low-quiescent-current devices with excellent line and load transient performance. These LDOs are designed for power-sensitive applications. A precision bandgap and error amplifier provides overall 2% accuracy together with low output noise, very high power-supply rejection ratio (PSRR), and low dropout voltage.

### 7.2 Functional Block Diagrams

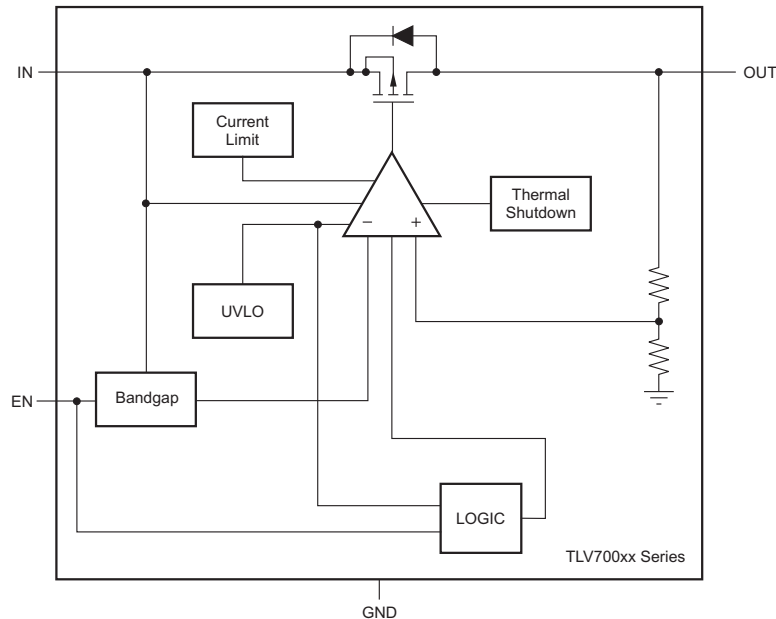

### 7.3 Feature Description

#### 7.3.1 Internal Current Limit

The TLV70018-Q1 and TLV70012-Q1 internal current limit helps to protect the regulator during fault conditions. During current limit, the output sources a fixed amount of current that is largely independent of the output voltage. In such a case, the output voltage is not regulated, and is  $V_{OUT} = I_{LIMIT} \times R_{LOAD}$ . The PMOS pass transistor dissipates  $(V_{IN} - V_{OUT}) \times I_{LIMIT}$  until thermal shutdown is triggered and the device turns off. As the device cools, it is turned on by the internal thermal shutdown circuit. If the fault condition continues, the device cycles between current limit and thermal shutdown. See the [Thermal Considerations](#) section for more details.

The PMOS pass element in the TLV70018-Q1 and TLV70012-Q1 has a built-in body diode that conducts current when the voltage at OUT exceeds the voltage at IN. This current is not limited, so if extended reverse voltage operation is anticipated, external limiting to 5% of the rated output current is recommended.

#### 7.3.2 Dropout Voltage

The TLV70018-Q1 and TLV70012-Q1 use a PMOS pass transistor to achieve low dropout. When  $(V_{IN} - V_{OUT})$  is less than the dropout voltage ( $V_{DO}$ ), the PMOS pass device is in the linear region of operation and the input-to-output resistance is the  $R_{DS(ON)}$  of the PMOS pass element.  $V_{DO}$  scales approximately with output current because the PMOS device behaves as a resistor in dropout.

As with any linear regulator, PSRR and transient response are degraded as  $(V_{IN} - V_{OUT})$  approaches dropout. [Figure 11](#) illustrates this effect.

## Feature Description (continued)

### 7.3.3 Undervoltage Lockout (UVLO)

The TLV70018-Q1 and TLV70012-Q1 use an undervoltage lockout circuit to keep the output shut off until internal circuitry is operating properly.

### 7.3.4 Thermal Shutdown

Thermal protection disables the output when the junction temperature rises to approximately 165°C, allowing the device to cool. When the junction temperature cools to approximately 145°C, the output circuitry is again enabled. Depending on power dissipation, thermal resistance, and ambient temperature, the thermal protection circuit may cycle on and off. This cycling limits the dissipation of the regulator, protecting it from damage as a result of overheating.

Any tendency to activate the thermal protection circuit indicates excessive power dissipation or an inadequate heatsink. For reliable operation, junction temperature should be limited to 125°C maximum. To estimate the margin of safety in a complete design (including heatsink), increase the ambient temperature until the thermal protection is triggered; use worst-case loads and signal conditions. For good reliability, thermal protection should trigger at least 40°C above the maximum expected ambient condition of the particular application. This configuration produces a worst-case junction temperature of 125°C at the highest expected ambient temperature and worst-case load.

The internal protection circuitry of the TLV70018-Q1 and TLV70012-Q1 has been designed to protect against overload conditions. It was not intended to replace proper heatsinking. Continuously running the TLV70018-Q1 or TLV70012-Q1 into thermal shutdown degrades device reliability.

## 7.4 Device Functional Modes

### 7.4.1 Shutdown

The enable pin (EN) is active high. The device is enabled when voltage at EN pin goes above 0.9 V. This relatively lower value of voltage required to turn the LDO on can be exploited to power the LDO with a GPIO of recent processors whose GPIO Logic 1 voltage level is lower than traditional microcontrollers. The device is turned off when the EN pin is held at less than 0.4 V. When shutdown capability is not required, EN can be connected to the IN pin.

### 7.4.2 Operation with $V_{IN}$ Less than 2 V

The TLV70018-Q1 and TLV70012-Q1 devices operate with input voltages above 2 V. The typical UVLO voltage is 1.9 V and the device operates at an input voltage above 2 V. When input voltage falls below UVLO voltage, the device will shutdown.

### 7.4.3 Operation with $V_{IN}$ Greater than 2 V

When  $V_{IN}$  is greater than 2 V, if input voltage is higher than desired output voltage plus dropout voltage, the output voltage is equal to the desired value. Otherwise, output voltage will be  $V_{IN}$  minus dropout voltage.

## 8 Application and Implementation

### NOTE

Information in the following applications sections is not part of the TI component specification, and TI does not warrant its accuracy or completeness. TI's customers are responsible for determining suitability of components for their purposes. Customers should validate and test their design implementation to confirm system functionality.

### 8.1 Application Information

The TLV70018-Q1 and TLV70012-Q1 consume low quiescent current and deliver excellent line and load transient performance. These characteristics, combined with low noise and very good PSRR with little ( $V_{IN} - V_{OUT}$ ) headroom, make this family of devices ideal for portable RF applications. This family of regulators offers current limit and thermal protection, and is specified from  $-40^{\circ}\text{C}$  to  $125^{\circ}\text{C}$ .

### 8.2 Typical Application

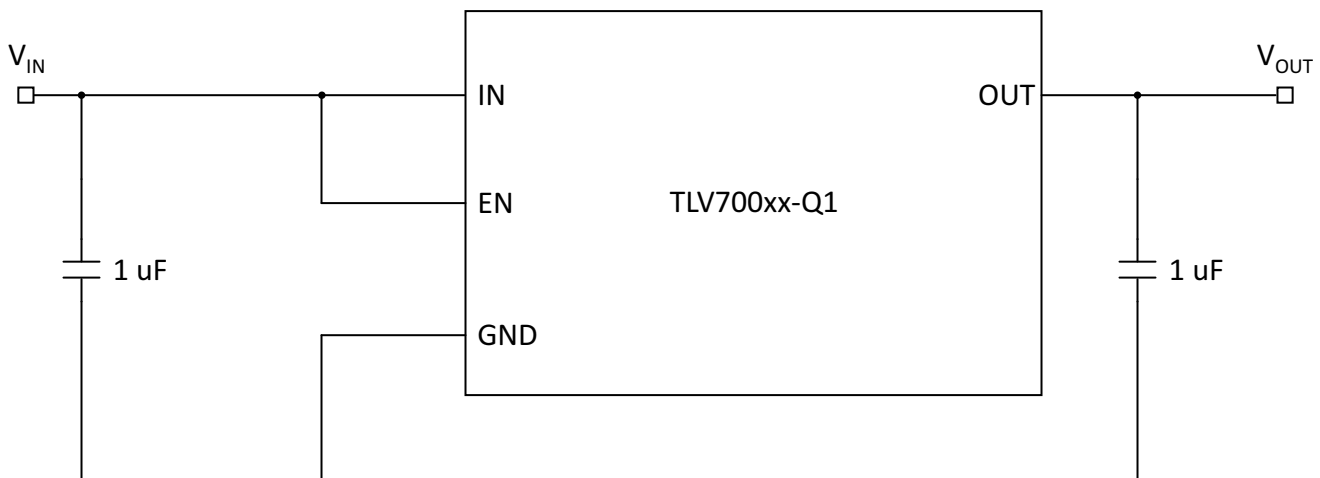

Figure 21. Simplified Schematic

#### 8.2.1 Design Requirements

For this design example use, the parameters listed in [Table 1](#) as the input parameters.

Table 1. Design Parameters

PARAMETER	EXAMPLE VALUE
Input voltage range	2 V to 5.5 V
Output voltage	1.2 V, 1.8 V
Output current rating	300 mA
Effective output capacitor range	>0.1 $\mu\text{F}$
Maximum output capacitor ESR range	<200 m $\Omega$

## 8.2.2 Detailed Design Procedure

### 8.2.2.1 Input and Output Capacitor Requirements

1.0- $\mu$ F X5R- and X7R-type ceramic capacitors are recommended because these capacitors have minimal variation in value and equivalent series resistance (ESR) over temperature.

However, the TLV70018-Q1 and TLV70012-Q1 are designed to be stable with an *effective capacitance* of 0.1  $\mu$ F or larger at the output. Thus, the device is stable with capacitors of other dielectric types as well, as long as the effective capacitance under operating bias voltage and temperature is greater than 0.1  $\mu$ F. This effective capacitance refers to the capacitance that the LDO sees under operating bias voltage and temperature conditions; that is, the capacitance after taking both bias voltage and temperature derating into consideration. In addition to allowing the use of lower-cost dielectrics, this capability of being stable with 0.1- $\mu$ F effective capacitance also enables the use of smaller-footprint capacitors that have higher derating in size- and space-constrained applications.

#### NOTE

Using a 0.1- $\mu$ F rated capacitor at the output of the LDO does not ensure stability because the effective capacitance under the specified operating conditions would be less than 0.1  $\mu$ F. Maximum ESR should be less than 200 m $\Omega$ .

Although an input capacitor is not required for stability, it is good analog design practice to connect a 0.1- $\mu$ F to 1.0- $\mu$ F, low ESR capacitor across the IN pin and GND pin of the regulator. This capacitor counteracts reactive input sources and improves transient response, noise rejection, and ripple rejection. A higher-value capacitor may be necessary if large, fast rise-time load transients are anticipated, or if the device is not located close to the power source. If source impedance is more than 2  $\Omega$ , a 0.1- $\mu$ F input capacitor may be necessary to ensure stability.

### 8.2.2.2 Transient Response

As with any regulator, increasing the size of the output capacitor reduces overshoot or undershoot magnitude but increases the duration of the transient response.

### 8.2.3 Application Curve

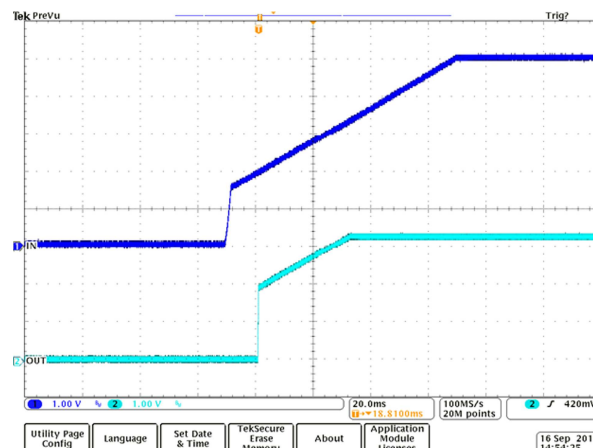

Figure 22. Power Up

## 9 Power Supply Recommendations

The device is designed to operate from an input-voltage supply range between 2 V and 5.5 V. This input supply must be well regulated. If the input supply is located more than a few inches from the device, TI recommends adding a capacitor with a value of 0.1  $\mu$ F and a ceramic bypass capacitor at the input.

## 10 Layout

### 10.1 Layout Guidelines

Input and output capacitors should be placed as close to the device pins as possible. To improve ac performance such as PSRR, output noise, and transient response, the board is recommended to be designed with separate ground planes for  $V_{IN}$  and  $V_{OUT}$ , with the ground plane connected only at the GND pin of the device. In addition, the ground connection for the output capacitor should be connected directly to the GND pin of the device. High ESR capacitors may degrade PSRR performance.

### 10.2 Layout Example

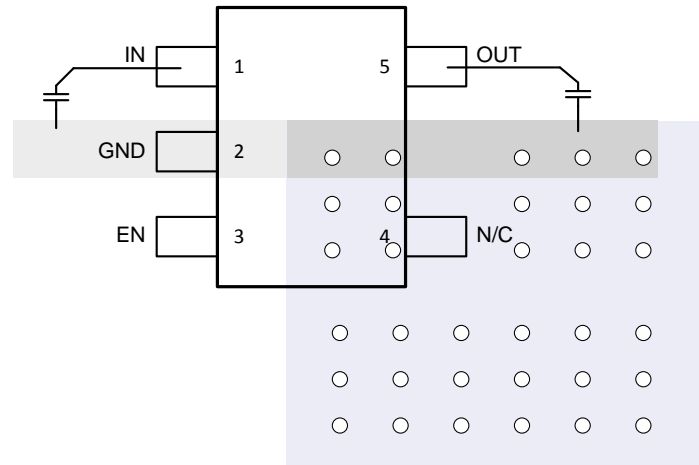

Figure 23. TLV700xx Layout Example

### 10.3 Thermal Considerations

Any tendency to activate the thermal protection circuit indicates excessive power dissipation or an inadequate heatsink. For reliable operation, junction temperature should be limited to 125°C maximum.

To estimate the margin of safety in a complete design (including heatsink), increase the ambient temperature until the thermal protection is triggered; use worst-case loads and signal conditions.

### 10.4 Power Dissipation

The ability to remove heat from the die is different for each package type, presenting different considerations in the printed circuit board (PCB) layout. The PCB area around the device that is free of other components moves the heat from the device to the ambient air.

Thermal performance data for TLV70018-Q1 and TLV70012-Q1 were gathered using the [TLV700 evaluation module \(EVM\)](#), a 2-layer board with two ounces of copper per side. Corresponding thermal performance data are given in [Thermal Information](#). Note that this board has provision for soldering not only the SOT23-5 package on the bottom layer, but also the SC-70 package on the top layer. Using heavier copper increases the effectiveness in removing heat from the device. The addition of plated through-holes to heat-dissipating layers also improves heatsink effectiveness.

## Power Dissipation (continued)

### 10.4.1 Thermal Calculations

Power dissipation depends on input voltage and load conditions. Power dissipation ( $P_D$ ) is equal to the product of the output current and the voltage drop across the output pass element, as shown in [Equation 1](#).

$$P_D = I_{OUT} \times (V_{IN} - V_{OUT}) + I_Q \times V_{IN}$$

where

- $P_D$  is continuous power dissipation
- $I_{OUT}$  is output current
- $V_{IN}$  is input voltage
- $V_{OUT}$  is output voltage

(1)

Since  $I_Q \ll I_{OUT}$ , the term  $I_Q \times V_{IN}$  is always ignored.

For a device under operation at a given ambient air temperature ( $T_A$ ), use [Equation 2](#) to calculate the junction temperature ( $T_J$ ).

$$T_J = T_A + (R_{\theta JA} \times P_D)$$

where

- $Z_{\theta JA}$  is the junction-to-ambient air temperature thermal impedance

(2)

Use [Equation 3](#) to calculate the rise in junction temperature due to power dissipation.

$$\Delta T = T_J - T_A = (R_{\theta JA} \times P_D)$$

(3)

For a given maximum junction temperature ( $T_{J(MAX)}$ ), use [Equation 4](#) to calculate the maximum ambient air temperature ( $T_{A(MAX)}$ ) at which the device can operate.

$$T_{Amax} = T_{Jmax} - (R_{\theta JA} \times P_D)$$

(4)



## 11 Device and Documentation Support

### 11.1 Device Support

#### 11.1.1 Package Mounting

Solder pad footprint recommendations for the TLV70018-Q1 are available from the Texas Instruments web site at [www.ti.com](http://www.ti.com).

### 11.2 Documentation Support

#### 11.2.1 Related Documentation

For related documentation, see the following:

[TLV700 evaluation module](#)

### 11.3 Related Links

The table below lists quick access links. Categories include technical documents, support and community resources, tools and software, and quick access to order now.

**Table 2. Related Links**

PARTS	PRODUCT FOLDER	ORDER NOW	TECHNICAL DOCUMENTS	TOOLS & SOFTWARE	SUPPORT & COMMUNITY
TLV70018-Q1	<a href="#">Click here</a>	<a href="#">Click here</a>	<a href="#">Click here</a>	<a href="#">Click here</a>	<a href="#">Click here</a>
TLV70012-Q1	<a href="#">Click here</a>	<a href="#">Click here</a>	<a href="#">Click here</a>	<a href="#">Click here</a>	<a href="#">Click here</a>

### 11.4 Receiving Notification of Documentation Updates

To receive notification of documentation updates, navigate to the device product folder on ti.com. In the upper right corner, click on *Alert me* to register and receive a weekly digest of any product information that has changed. For change details, review the revision history included in any revised document.

### 11.5 Community Resources

The following links connect to TI community resources. Linked contents are provided "AS IS" by the respective contributors. They do not constitute TI specifications and do not necessarily reflect TI's views; see TI's [Terms of Use](#).

**TI E2E™ Online Community** *TI's Engineer-to-Engineer (E2E) Community*. Created to foster collaboration among engineers. At [e2e.ti.com](http://e2e.ti.com), you can ask questions, share knowledge, explore ideas and help solve problems with fellow engineers.

**Design Support** *TI's Design Support* Quickly find helpful E2E forums along with design support tools and contact information for technical support.

### 11.6 Trademarks

E2E is a trademark of Texas Instruments.  
All other trademarks are the property of their respective owners.

### 11.7 Electrostatic Discharge Caution



This integrated circuit can be damaged by ESD. Texas Instruments recommends that all integrated circuits be handled with appropriate precautions. Failure to observe proper handling and installation procedures can cause damage.

ESD damage can range from subtle performance degradation to complete device failure. Precision integrated circuits may be more susceptible to damage because very small parametric changes could cause the device not to meet its published specifications.

### 11.8 Glossary



[SLYZ022](#) — *TI Glossary*.

This glossary lists and explains terms, acronyms, and definitions.

## 12 Mechanical, Packaging, and Orderable Information

The following pages include mechanical, packaging, and orderable information. This information is the most current data available for the designated devices. This data is subject to change without notice and revision of this document. For browser-based versions of this data sheet, refer to the left-hand navigation.

**PACKAGING INFORMATION**

Orderable Device	Status (1)	Package Type	Package Drawing	Pins	Package Qty	Eco Plan (2)	Lead finish/ Ball material (6)	MSL Peak Temp (3)	Op Temp (°C)	Device Marking (4/5)	Samples
TLV70012QDDCRQ1	ACTIVE	SOT-23-THIN	DDC	5	3000	RoHS & Green	NIPDAU	Level-2-260C-1 YEAR	-40 to 125	SDO	
TLV70018QDDCRQ1	ACTIVE	SOT-23-THIN	DDC	5	3000	RoHS & Green	NIPDAU	Level-2-260C-1 YEAR	-40 to 125	DAL	

(1) The marketing status values are defined as follows:

**ACTIVE:** Product device recommended for new designs.

**LIFEBUY:** TI has announced that the device will be discontinued, and a lifetime-buy period is in effect.

**NRND:** Not recommended for new designs. Device is in production to support existing customers, but TI does not recommend using this part in a new design.

**PREVIEW:** Device has been announced but is not in production. Samples may or may not be available.

**OBSELETE:** TI has discontinued the production of the device.

(2) **RoHS:** TI defines "RoHS" to mean semiconductor products that are compliant with the current EU RoHS requirements for all 10 RoHS substances, including the requirement that RoHS substance do not exceed 0.1% by weight in homogeneous materials. Where designed to be soldered at high temperatures, "RoHS" products are suitable for use in specified lead-free processes. TI may reference these types of products as "Pb-Free".

**RoHS Exempt:** TI defines "RoHS Exempt" to mean products that contain lead but are compliant with EU RoHS pursuant to a specific EU RoHS exemption.

**Green:** TI defines "Green" to mean the content of Chlorine (Cl) and Bromine (Br) based flame retardants meet JS709B low halogen requirements of <=1000ppm threshold. Antimony trioxide based flame retardants must also meet the <=1000ppm threshold requirement.

(3) MSL, Peak Temp. - The Moisture Sensitivity Level rating according to the JEDEC industry standard classifications, and peak solder temperature.

(4) There may be additional marking, which relates to the logo, the lot trace code information, or the environmental category on the device.

(5) Multiple Device Markings will be inside parentheses. Only one Device Marking contained in parentheses and separated by a "~" will appear on a device. If a line is indented then it is a continuation of the previous line and the two combined represent the entire Device Marking for that device.

(6) Lead finish/Ball material - Orderable Devices may have multiple material finish options. Finish options are separated by a vertical ruled line. Lead finish/Ball material values may wrap to two lines if the finish value exceeds the maximum column width.

**Important Information and Disclaimer:**The information provided on this page represents TI's knowledge and belief as of the date that it is provided. TI bases its knowledge and belief on information provided by third parties, and makes no representation or warranty as to the accuracy of such information. Efforts are underway to better integrate information from third parties. TI has taken and continues to take reasonable steps to provide representative and accurate information but may not have conducted destructive testing or chemical analysis on incoming materials and chemicals. TI and TI suppliers consider certain information to be proprietary, and thus CAS numbers and other limited information may not be available for release.

In no event shall TI's liability arising out of such information exceed the total purchase price of the TI part(s) at issue in this document sold by TI to Customer on an annual basis.



## TAPE AND REEL INFORMATION



### QUADRANT ASSIGNMENTS FOR PIN 1 ORIENTATION IN TAPE



\*All dimensions are nominal

Device	Package Type	Package Drawing	Pins	SPQ	Reel Diameter (mm)	Reel Width W1 (mm)	A0 (mm)	B0 (mm)	K0 (mm)	P1 (mm)	W (mm)	Pin1 Quadrant
TLV70012QDDCRQ1	SOT-23-THIN	DDC	5	3000	179.0	8.4	3.2	3.2	1.4	4.0	8.0	Q3
TLV70018QDDCRQ1	SOT-23-THIN	DDC	5	3000	180.0	8.4	3.2	3.2	1.4	4.0	8.0	Q3

**TAPE AND REEL BOX DIMENSIONS**

\*All dimensions are nominal

Device	Package Type	Package Drawing	Pins	SPQ	Length (mm)	Width (mm)	Height (mm)
TLV70012QDDCRQ1	SOT-23-THIN	DDC	5	3000	213.0	191.0	35.0
TLV70018QDDCRQ1	SOT-23-THIN	DDC	5	3000	213.0	191.0	35.0

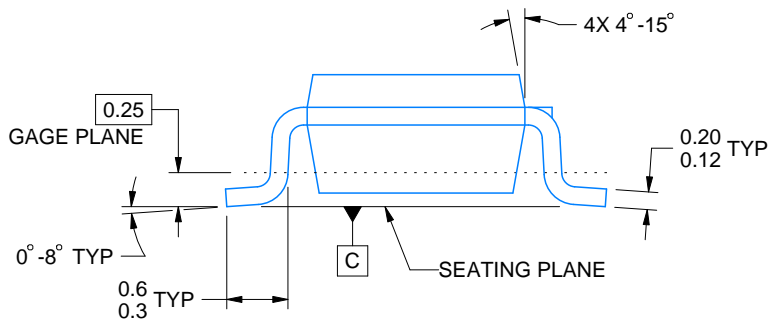
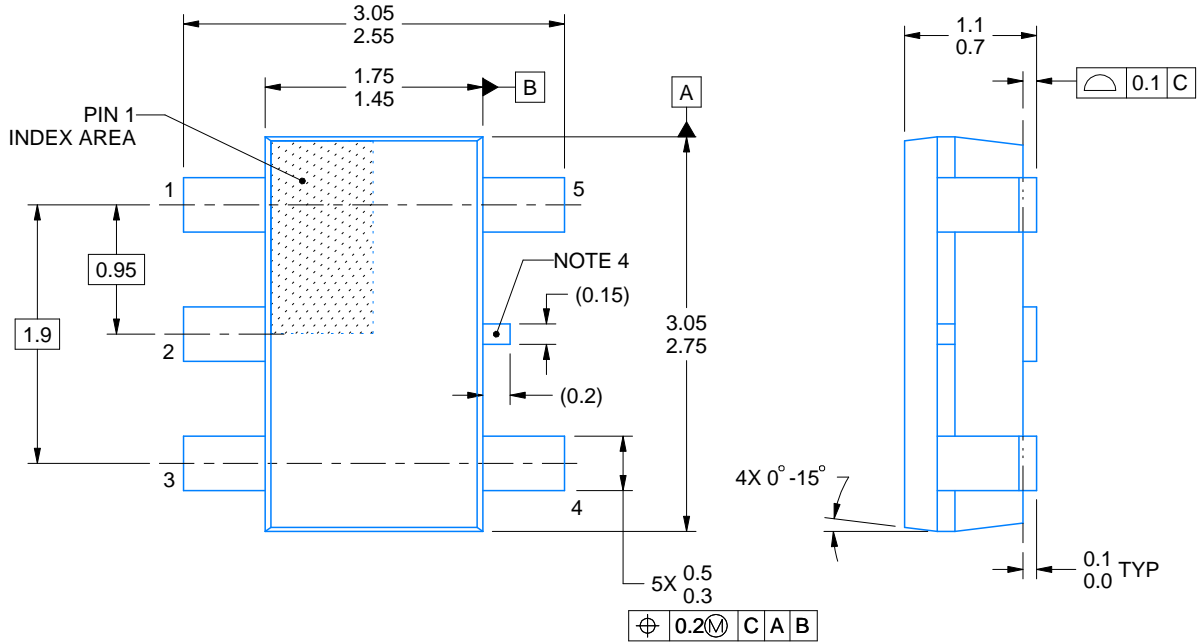

4220752/C 08/2024

NOTES:

1. All linear dimensions are in millimeters. Any dimensions in parenthesis are for reference only. Dimensioning and tolerancing per ASME Y14.5M.
2. This drawing is subject to change without notice.
3. Reference JEDEC MO-193.
4. Support pin may differ or may not be present.

# EXAMPLE BOARD LAYOUT

DDC0005A

SOT-23 - 1.1 max height

SMALL OUTLINE TRANSISTOR

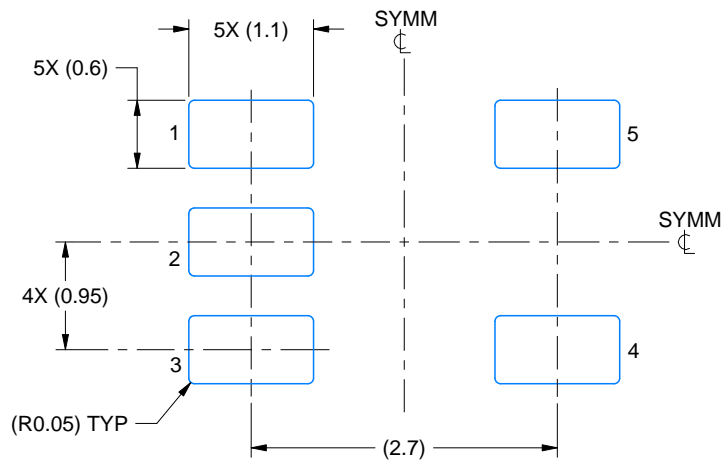

LAND PATTERN EXAMPLE  
EXPLODED METAL SHOWN  
SCALE:15X

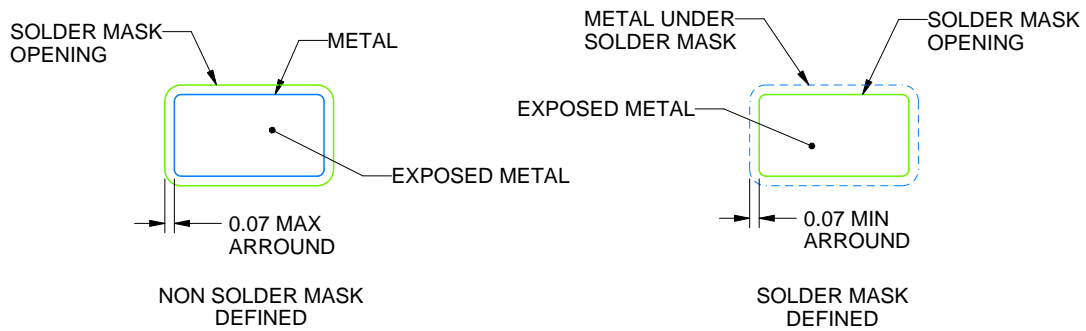

SOLDERMASK DETAILS

4220752/C 08/2024

NOTES: (continued)

- 4. Publication IPC-7351 may have alternate designs.
- 5. Solder mask tolerances between and around signal pads can vary based on board fabrication site.



# EXAMPLE STENCIL DESIGN

DDC0005A

SOT-23 - 1.1 max height

SMALL OUTLINE TRANSISTOR

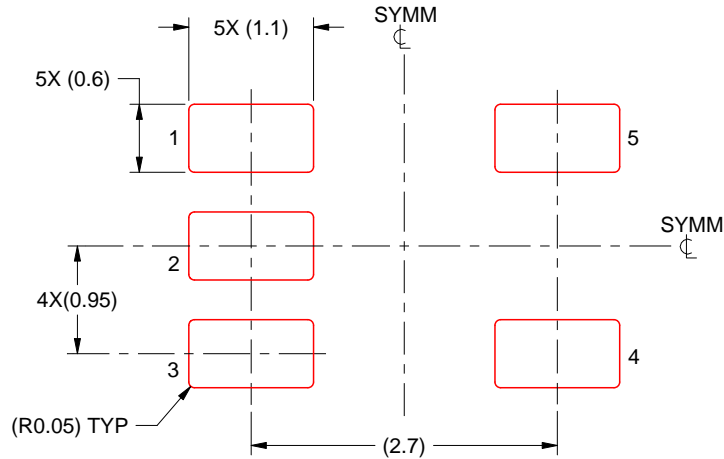

SOLDER PASTE EXAMPLE  
BASED ON 0.125 THICK STENCIL  
SCALE:15X

4220752/C 08/2024

NOTES: (continued)

6. Laser cutting apertures with trapezoidal walls and rounded corners may offer better paste release. IPC-7525 may have alternate design recommendations.
7. Board assembly site may have different recommendations for stencil design.

## IMPORTANT NOTICE AND DISCLAIMER

TI PROVIDES TECHNICAL AND RELIABILITY DATA (INCLUDING DATA SHEETS), DESIGN RESOURCES (INCLUDING REFERENCE DESIGNS), APPLICATION OR OTHER DESIGN ADVICE, WEB TOOLS, SAFETY INFORMATION, AND OTHER RESOURCES "AS IS" AND WITH ALL FAULTS, AND DISCLAIMS ALL WARRANTIES, EXPRESS AND IMPLIED, INCLUDING WITHOUT LIMITATION ANY IMPLIED WARRANTIES OF MERCHANTABILITY, FITNESS FOR A PARTICULAR PURPOSE OR NON-INFRINGEMENT OF THIRD PARTY INTELLECTUAL PROPERTY RIGHTS.

These resources are intended for skilled developers designing with TI products. You are solely responsible for (1) selecting the appropriate TI products for your application, (2) designing, validating and testing your application, and (3) ensuring your application meets applicable standards, and any other safety, security, regulatory or other requirements.

These resources are subject to change without notice. TI grants you permission to use these resources only for development of an application that uses the TI products described in the resource. Other reproduction and display of these resources is prohibited. No license is granted to any other TI intellectual property right or to any third party intellectual property right. TI disclaims responsibility for, and you will fully indemnify TI and its representatives against, any claims, damages, costs, losses, and liabilities arising out of your use of these resources.

TI's products are provided subject to [TI's Terms of Sale](#) or other applicable terms available either on [ti.com](https://www.ti.com) or provided in conjunction with such TI products. TI's provision of these resources does not expand or otherwise alter TI's applicable warranties or warranty disclaimers for TI products.

TI objects to and rejects any additional or different terms you may have proposed.

Mailing Address: Texas Instruments, Post Office Box 655303, Dallas, Texas 75265  
Copyright © 2024, Texas Instruments Incorporated