

TPS513885 5.5V to 24V, 12A, Synchronous Buck Converter

1 Features

- 5.5V to 24V input voltage range
- 5.15V output voltage
- Integrated 9.2mΩ and 4.5mΩ FETs
- Support 12A continuous output current
- 90uA low quiescent current
- ± 1.0% output voltage accuracy (25°C)
- D-CAP3™ control mode architecture control for fast transient response
- Support POSCAP and all MLCC output capacitor
- Selectable Eco-mode and Out-of-Audio™ mode with dynamic change
- ULQ™ extended battery life during system standby
- Built-in output discharge function
- Integrated power-good indicator
- 560kHz and 920kHz selectable switching frequency
- Fixed 0.9ms soft-start time
- Large duty cycle operation
- Cycle-by-cycle overcurrent and negative overcurrent protection
- Latched output OV and UV protections
- Non-latched UVLO and OT protections
- –20°C to 125°C operating junction temperature
- 13-pin 3.0mm × 4.0mm HotRod™ VQFN package
- Create a custom design using the TPS513885 with the [WEBENCH® Power Designer](#)

2 Applications

- [Notebook and PC computers](#)
- Ultrabook, [handheld tablet](#) computers
- [Industrial PC, single-board computers](#)
- [Non-military drone](#)
- Distributed power systems

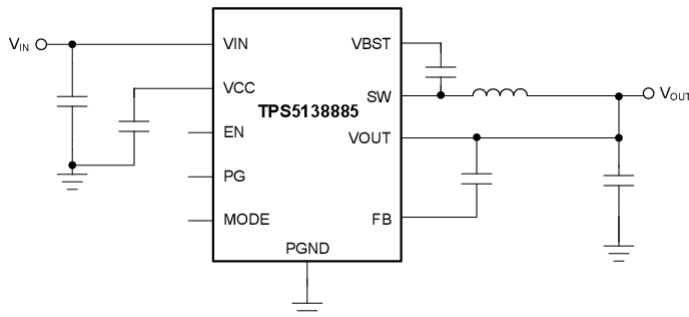

Simplified Schematic

3 Description

The device is a monolithic, 12A, synchronous buck converter with integrated MOSFETs that enable high efficiency and offer ease-of-use with minimum external component count for space-conscious power systems.

The TPS513885 employs D-CAP3 control mode that provides fast transient response and excellent line and load regulation with internal compensation. The ULQ extended battery life feature is extremely beneficial for long battery life in low power operation. The large duty operation greatly improves the load transient performance when input voltage is low.

The EN pin can be used to set Eco-mode or Out-of-Audio (OOA) mode for light-load operation. The Eco-mode maintains high efficiency during light load operation. The OOA mode keeps the switching frequency above audible frequency with minimum reduction in efficiency. The EN pin can be toggled dynamically, even when the converter is in operation.

The TPS513885 integrates a power-good indicator and provides an output discharge function. The TPS513885 provides complete protection including OVP, UVP, OCP, OTP, and UVLO. The device is available in a 13-pin, 3.0mm × 4.0mm HotRod package, and the junction temperature is specified from –20°C to 125°C.

Package Information

PART NUMBER	PACKAGE ⁽¹⁾	PACKAGE SIZE ⁽²⁾
TPS513885	VAB (VQFN-HR, 13)	4mm × 3mm

(1) For more information, see [Section 10](#).

(2) The package size (length × width) is a nominal value and includes pins, where applicable.

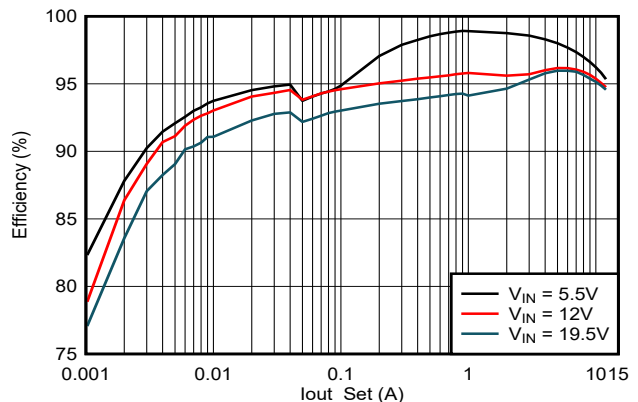

Efficiency vs Output Current, 560kHz, Eco-mode



Table of Contents

1 Features	1	7 Application and Implementation	16
2 Applications	1	7.1 Application Information.....	16
3 Description	1	7.2 Typical Application.....	16
4 Pin Configuration and Functions	3	7.3 Power Supply Recommendations.....	22
5 Specifications	4	7.4 Layout.....	22
5.1 Absolute Maximum Ratings.....	4	8 Device and Documentation Support	24
5.2 ESD Ratings.....	4	8.1 Device Support.....	24
5.3 Recommended Operating Conditions.....	4	8.2 Documentation Support.....	24
5.4 Thermal Information.....	5	8.3 Receiving Notification of Documentation Updates....	24
5.5 Electrical Characteristics.....	5	8.4 Support Resources.....	24
5.6 Typical Characteristics.....	7	8.5 Trademarks.....	24
6 Detailed Description	10	8.6 Electrostatic Discharge Caution.....	24
6.1 Overview.....	10	8.7 Glossary.....	24
6.2 Functional Block Diagram.....	11	9 Revision History	25
6.3 Feature Description.....	12	10 Mechanical, Packaging, and Orderable Information	26
6.4 Device Functional Modes.....	14		

4 Pin Configuration and Functions

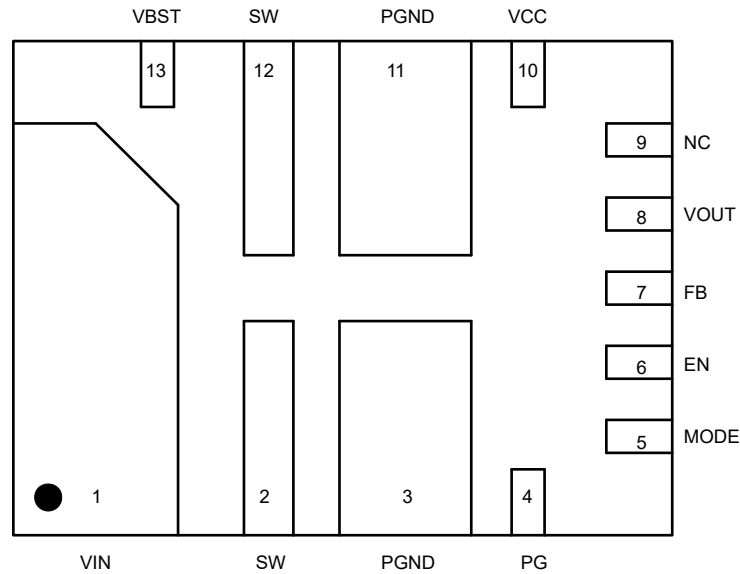

Figure 4-1. 13-Pin VQFN-HR, VAB Package (Top View)

Table 4-1. Pin Functions

PIN		TYPE ⁽¹⁾	DESCRIPTION
NAME	NO.		
VIN	1	P	Input voltage supply pin for the control circuitry. Connect the input decoupling capacitors between VIN and PGND.
SW	2,12	O	Switching node connection to the inductor and bootstrap capacitor for buck. This pin voltage swings from a diode voltage below the ground up to input voltage of buck.
PGND	3,11	G	Power GND terminal for the controller circuit and the internal circuitry.
PG	4	O	Power good indicator pin. This pin asserts low if the output voltage of buck is out of range due to thermal shutdown, dropout, over-voltage, EN shutdown or during slow start.
MODE	5	I	Mode selection pin. Pull MODE pin to voltage larger than 1V, connect the pin to EN or VCC for 560kHz operation. Pull MODE pin low to GND for 920kHz operation.
EN	6	I	Enable input of buck converter. The EN pin is also used to select light load operation mode. Pull EN above 2.2V for Eco-mode. Pull EN between 1V to 1.6V for OOA mode.
FB	7	I	Converter feedback input, can be used for feedforward compensation to improve load transient performance.
VOUT	8	I	Output pin. Connect to the output of the buck regulator. The pin also provides the bypass input for internal VCC LDO.
NC	9	—	Not connected.
VCC	10	O	Internal 5V LDO output. Power supply for internal analog circuits and driving. Decouple this pin to ground with a 2.2μF ceramic capacitor.
VBST	13	I	Boot-strap pin. Supply high side gate driver. Connect a 0.1μF ceramic capacitor between this pin and the SW pin.

(1) I = input, O = output, P = power, G = ground

5 Specifications

5.1 Absolute Maximum Ratings

over operating free-air temperature range (unless otherwise noted) ⁽¹⁾

		MIN	MAX	UNIT
Input voltage	VIN	-0.3	28	V
	VBST	-0.3	32	V
	VBST-SW	-0.3	6	V
	EN, MODE, FB	-0.3	6	V
	VOUT	-0.3	6.5	V
	PGND	-0.3	0.3	V
Output voltage	SW	-1	28	V
	SW (10ns transient)	-3	28	V
	PG, VCC	-0.3	6	V
T _J	Operating junction temperature	-20	150	°C
T _{stg}	Storage temperature	-55	150	°C

- (1) Operation outside the Absolute Maximum Ratings may cause permanent device damage. Absolute Maximum Ratings do not imply functional operation of the device at these or any other conditions beyond those listed under Recommended Operating Conditions. If used outside the Recommended Operating Conditions but within the Absolute Maximum Ratings, the device may not be fully functional, and this may affect device reliability, functionality, performance, and shorten the device lifetime.

5.2 ESD Ratings

			VALUE	UNIT
V _(ESD)	Electrostatic discharge	Human-body model (HBM), per ANSI/ESDA/JEDEC JS-001 ⁽¹⁾	±2000	V
		Charged-device model (CDM), per ANSI/ESDA/JEDEC JS-002 ⁽²⁾	±500	V

(1) JEDEC document JEP155 states that 500V HBM allows safe manufacturing with a standard ESD control process.

(2) JEDEC document JEP157 states that 250V CDM allows safe manufacturing with a standard ESD control process.

5.3 Recommended Operating Conditions

over operating free-air temperature range (unless otherwise noted)

		MIN	MAX	UNIT
Input voltage	VIN	4.5	24	V
	VBST	-0.3	29.5	V
	VBST-SW	-0.3	5.5	V
	EN, MODE, FB, VOUT	-0.3	5.5	V
	PGND	-0.3	0.3	V
Output voltage	SW	-1	24	V
	PG, VCC	-0.3	5.5	V
I _{OUT}	Output current		12	A
T _J	Operating junction temperature	-20	125	°C

5.4 Thermal Information

THERMAL METRIC ⁽¹⁾		TPS513885	UNIT
		VAB (VQFN)	
		13 PINS	
R _{θJA}	Junction-to-ambient thermal resistance	53.8	°C/W
R _{θJA_effective}	Junction-to-ambient thermal resistance (4-layer custom board) ⁽²⁾	26.8	°C/W
R _{θJC(top)}	Junction-to-case (top) thermal resistance	32.9	°C/W
R _{θJB}	Junction-to-board thermal resistance	11.5	°C/W
Ψ _{JT}	Junction-to-top characterization parameter	2.4	°C/W
Ψ _{JB}	Junction-to-board characterization parameter	11.5	°C/W

- (1) For more information about traditional and new thermal metrics, see the [Semiconductor and IC Package Thermal Metrics application note](#).
- (2) The effective R_{θJA} is simulated based on TPS513885EVM.

5.5 Electrical Characteristics

T_J = –20°C to 125°C, V_{IN} = 12V, unless otherwise noted.

PARAMETER		TEST CONDITION	MIN	TYP	MAX	UNIT
SUPPLY CURRENT						
V _{IN}	Input voltage range		5.5		24	V
I _{VIN}	Non-switching supply current	No load, V _{EN} = 5V, non-switching		90		μA
I _{VINSDN}	Shutdown supply current	No load, V _{EN} = 0V		3		μA
VCC OUTPUT						
V _{CC}	VCC output voltage	V _{IN} > 5.2V, I _{VCC} ≤ 1 mA, Bypass switch off	4.6	4.9	5.2	V
OUTPUT VOLTAGE						
V _{OUT} V	Output voltage	T _J = 25°C	5.1	5.15	5.2	V
		T _J = –20°C to 125°C	5.07	5.15	5.23	V
DUTY CYCLE and FREQUENCY CONTROL						
F _{SW}	Switching frequency	CCM operation, MODE > 1V		560		kHz
		CCM operation, MODE < 0.4V		920		kHz
t _{ON(MIN)}	SW minimum on time ⁽¹⁾			60		ns
t _{OFF(MIN)}	SW minimum off time ⁽¹⁾			130		ns
OOA Function						
T _{OOA}	Mode Operation Period		22	30	42	us
MOSFET and DRIVERS						
R _{DS(ON)H}	High side switch resistance	T _J = 25°C		9.2		mΩ
R _{DS(ON)L}	Low side switch resistance	T _J = 25°C		4.5		mΩ
OUTPUT DISCHARGE and SOFT START						
R _{DIS}	Discharge resistance	V _{EN} = 0V		50		Ω
t _{SS}	Soft-start time	Internal soft-start time		0.9		ms
POWER GOOD						
t _{PGDLY}	PG delay rising	PG from low to high		160		us
	PG delay falling	PG from high to low		30		us
V _{PGTH}	PG threshold	VFB falling (fault)		83		%
		VFB rising (good)		90		%
		VFB rising (fault)		120		%
		VFB falling (good)		115		%

5.5 Electrical Characteristics (continued)

$T_J = -20^{\circ}\text{C}$ to 125°C , $V_{IN} = 12\text{V}$, unless otherwise noted.

PARAMETER		TEST CONDITION	MIN	TYP	MAX	UNIT
V_{PG_L}	PG sink current capability	$I_{OL} = 4\text{mA}$			0.4	V
I_{PGLK}	PG leak current	$V_{PGOOD} = 5.5\text{V}$			1	μA
CURRENT LIMIT						
I_{OCL}	Overcurrent threshold (valley)	Valley current limit on LS FET, $T_J = 25^{\circ}\text{C}$	12.5	14	16	A
	Overcurrent threshold (peak)	Peak current limit on HS FET, $T_J = 25^{\circ}\text{C}$		22		A
I_{NOCL}	Negative over current threshold	Sinking current limit on LS FET, OOA operation		5.5		A
LOGIC THRESHOLD						
V_{ENH}	EN high-level input voltage	$T_J = 25^{\circ}\text{C}$	1			V
V_{ENL}	EN low-level input voltage	$T_J = 25^{\circ}\text{C}$			0.4	V
I_{EN}	Enable internal pull down current	$V_{EN} = 0.3\text{V}$		2		μA
$V_{EN(OOA)}$	OOA mode for EN pin		1		1.6	V
$V_{EN(ECO)}$	Eco-mode for EN pin		2.2		5.5	V
$V_{MODE(560k)}$	Mode threshold high-level	$T_J = 25^{\circ}\text{C}$	1			V
$V_{MODE(920k)}$	Mode threshold low-level	$T_J = 25^{\circ}\text{C}$			0.4	V
OUTPUT UNDERVOLTAGE AND OVERVOLTAGE PROTECTION						
V_{OVP}	OVP trip threshold			120		%
t_{OVPDLY}	OVP prop deglitch			256		us
V_{UVP}	UVP trip threshold			60		%
t_{UVPDLY}	UVP prop deglitch			200		us
UVLO						
V_{UVLO}	VIN UVLO threshold	Wake up		4.25	4.45	V
		Shutdown	3.4	3.6		V
		Hysteresis		0.65		V
OVERTEMPERATURE PROTECTION						
T_{OTP}	OTP trip threshold ⁽¹⁾	Shutdown temperature		160		$^{\circ}\text{C}$
T_{OTPHSY}	OTP hysteresis ⁽¹⁾	Hysteresis		20		$^{\circ}\text{C}$

(1) Specified by design. Not production tested.

5.6 Typical Characteristics

$T_J = -20^{\circ}\text{C}$ to 125°C , $V_{IN} = 12\text{V}$, unless otherwise noted.

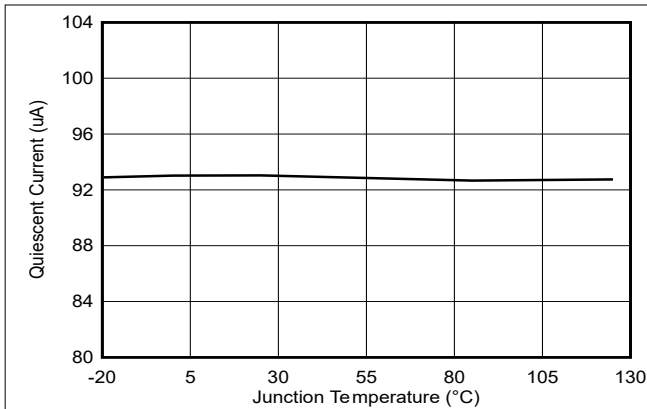

Figure 5-1. Supply Current vs Junction Temperature

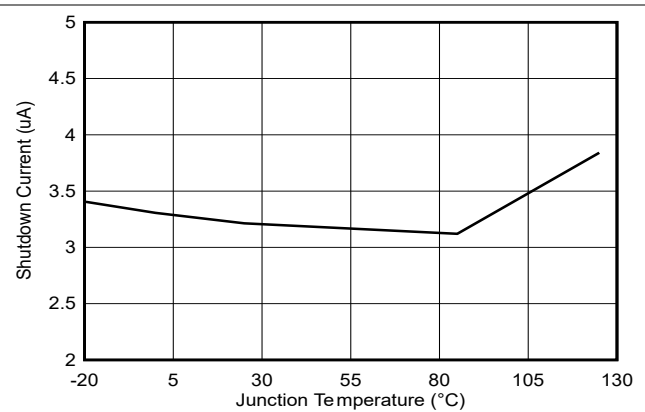

Figure 5-2. Shutdown Current vs Junction Temperature

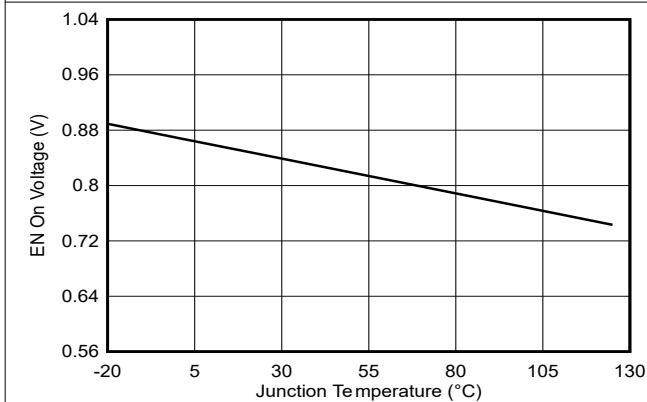

Figure 5-3. Enable On Voltage vs Junction Temperature

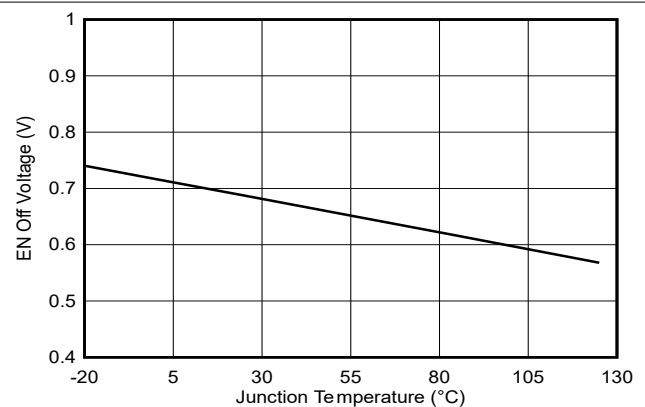

Figure 5-4. Enable Off Voltage vs Junction Temperature

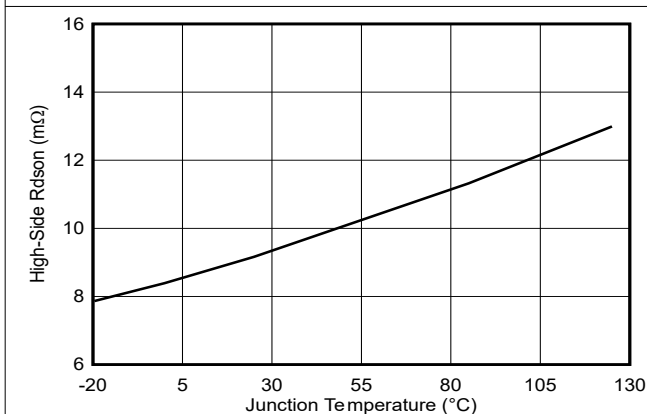

Figure 5-5. High-Side $R_{DS(on)}$ vs Junction Temperature

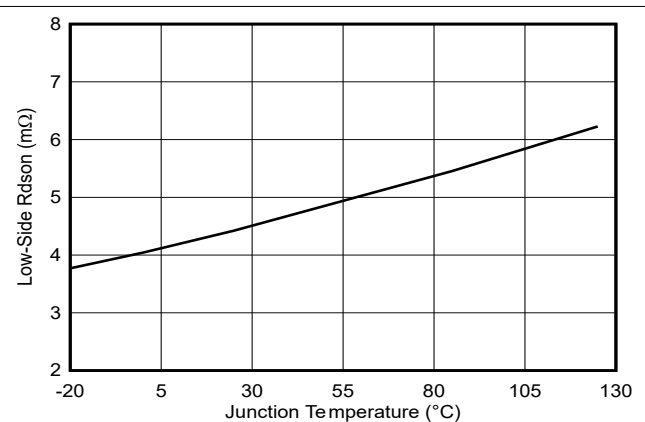

Figure 5-6. Low-Side $R_{DS(on)}$ vs Junction Temperature

5.6 Typical Characteristics (continued)

$T_J = -20^{\circ}\text{C}$ to 125°C , $V_{IN} = 12\text{V}$, unless otherwise noted.

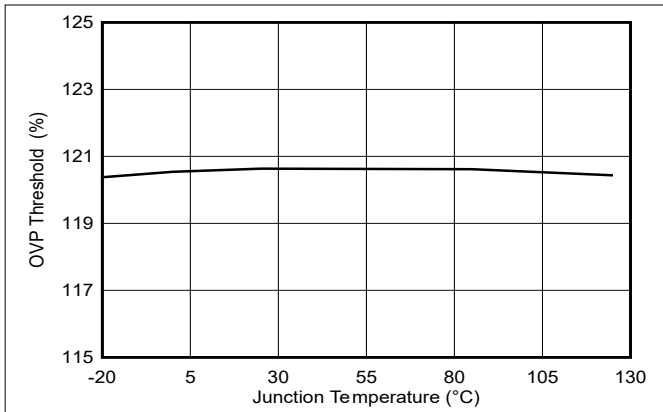

Figure 5-7. OVP Threshold vs Junction Temperature

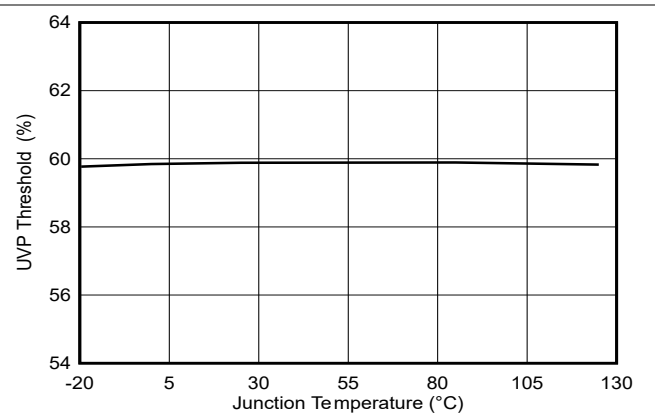

Figure 5-8. UVP Threshold vs Junction Temperature

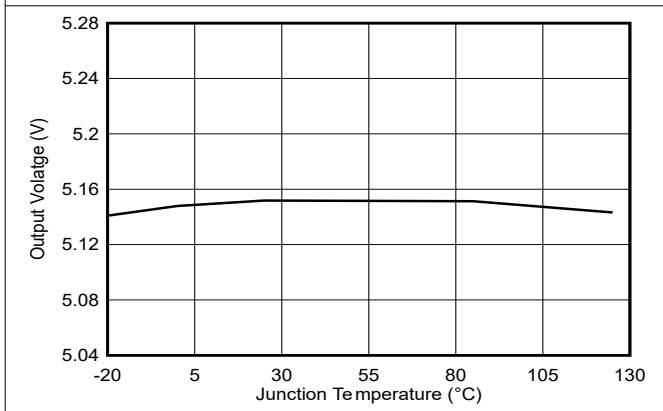

Figure 5-9. Output Voltage vs Junction Temperature

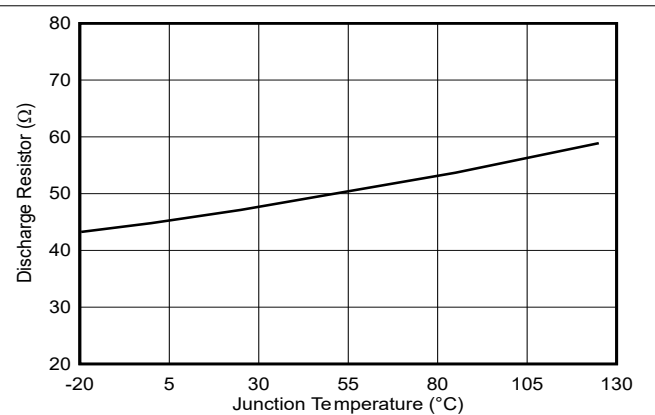

Figure 5-10. Discharge Resistor vs Junction Temperature

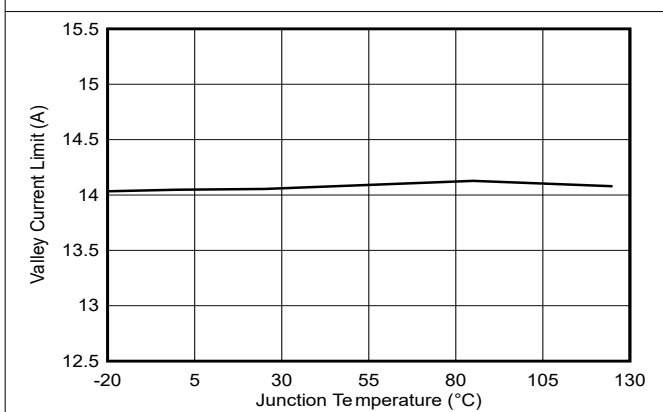

Figure 5-11. Valley Current Limit vs Junction Temperature

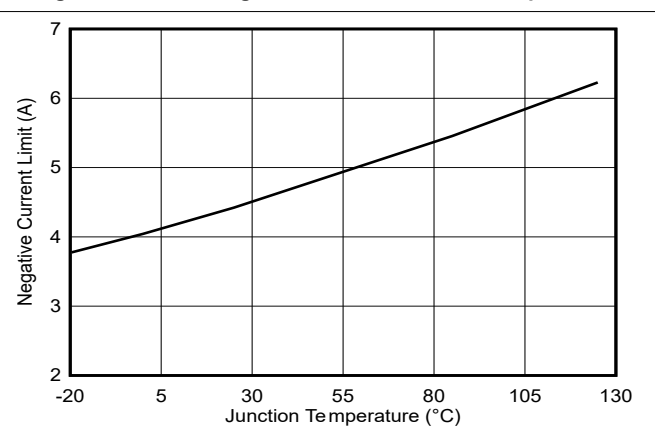

Figure 5-12. Negative Current Limit vs Junction Temperature

5.6 Typical Characteristics (continued)

$T_J = -20^{\circ}\text{C}$ to 125°C , $V_{IN} = 12\text{V}$, unless otherwise noted.

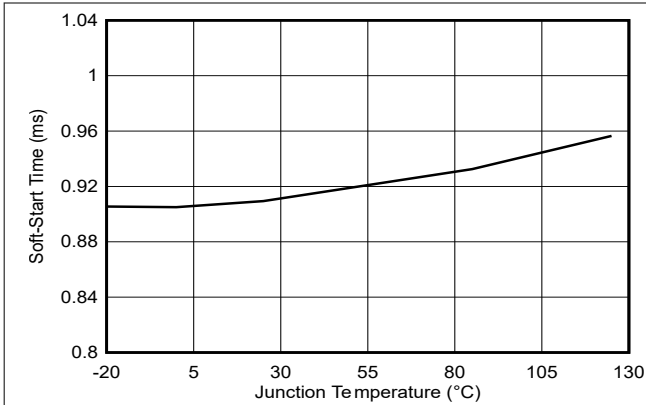

Figure 5-13. Soft-Start Time vs Junction Temperature

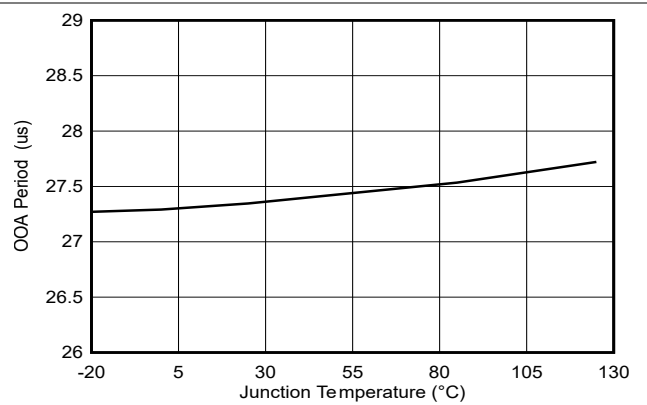

Figure 5-14. OOA Period vs Junction Temperature

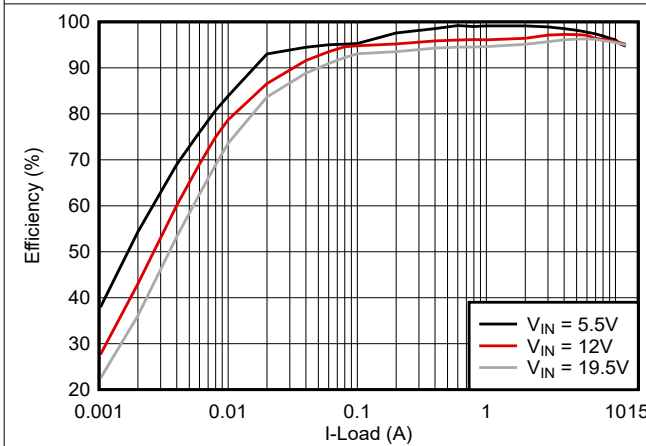

Figure 5-15. Efficiency vs Load Current, 560kHz, OOA Mode

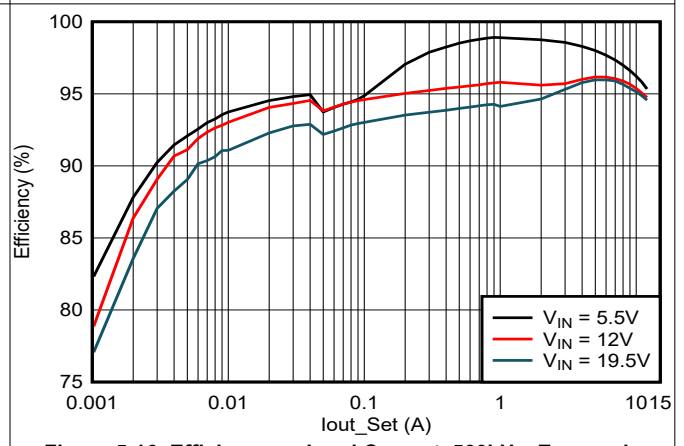

Figure 5-16. Efficiency vs Load Current, 560kHz, Eco-mode

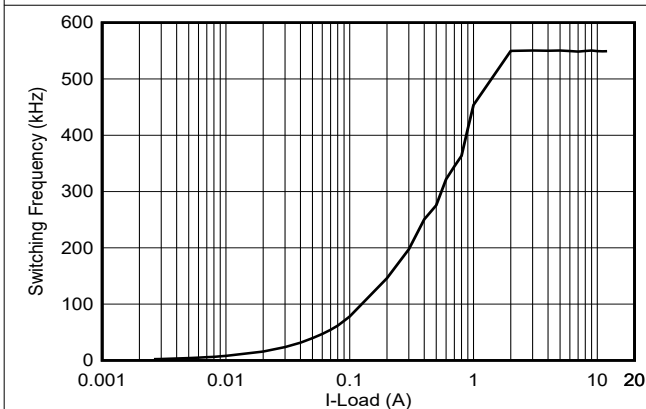

Figure 5-17. Switching Frequency vs Load Current, $F_{SW} = 560\text{kHz}$, ECO

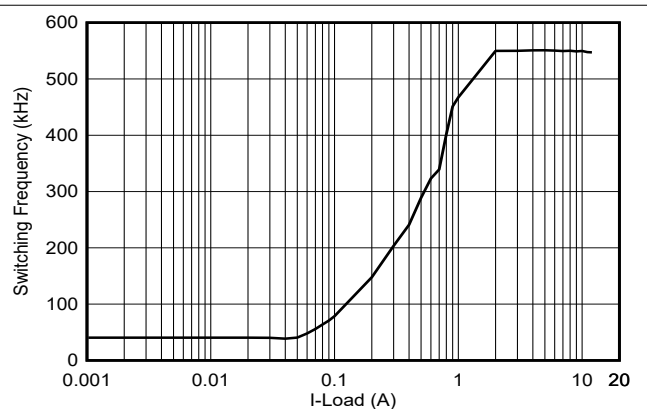

Figure 5-18. Switching Frequency vs Load Current, $F_{SW} = 560\text{kHz}$, OOA

6 Detailed Description

6.1 Overview

TPS513885 is 12A, integrated FET, synchronous step-down converters which can operate from 5.5V to 24V input voltage (VIN). TPS513885 is with fixed 5.15V output voltage. The device has 9.2mΩ and 4.5mΩ integrated MOSFETs that enable high efficiency up to 12A. The device employs D-CAP3 control mode that provides fast transient response with no external compensation components and an accurate feedback voltage. The control topology provides seamless transition between CCM operating mode at higher load condition and DCM, Eco-mode operation at lighter load condition. DCM, Eco-mode allows the TPS513885 to maintain high efficiency at light load. TPS513885 also has selectable Out-of-Audio (OOA) mode to maintain a minimum of 25kHz switching frequency that is above audible range (20Hz – 20kHz). D-CAP3 control mode allows the use of low equivalent series resistance (ESR) output capacitors such as POSCAP or SP-CAP, and ultra-low ESR ceramic capacitors.

TPS513885 has 5V internal VCC LDO that creates bias for all internal circuitry. The undervoltage lockout (UVLO) circuit monitors the VCC pin voltage to protect the internal circuitry from low input voltages. TPS513885 has an internal pulldown current source on the EN pin, require external pullup circuit to enable buck converter.

TPS513885 features light load operation mode dynamic change by adjusting EN voltage level, which allows the device to change state between OOA Mode and Eco-mode dynamically. TPS513885 supports selectable 560kHz or 920kHz switching frequency by setting MODE pin voltage before soft start. The internal soft-start time is fixed 0.9ms to simplify the design circuit and reduce the external components.

6.2 Functional Block Diagram

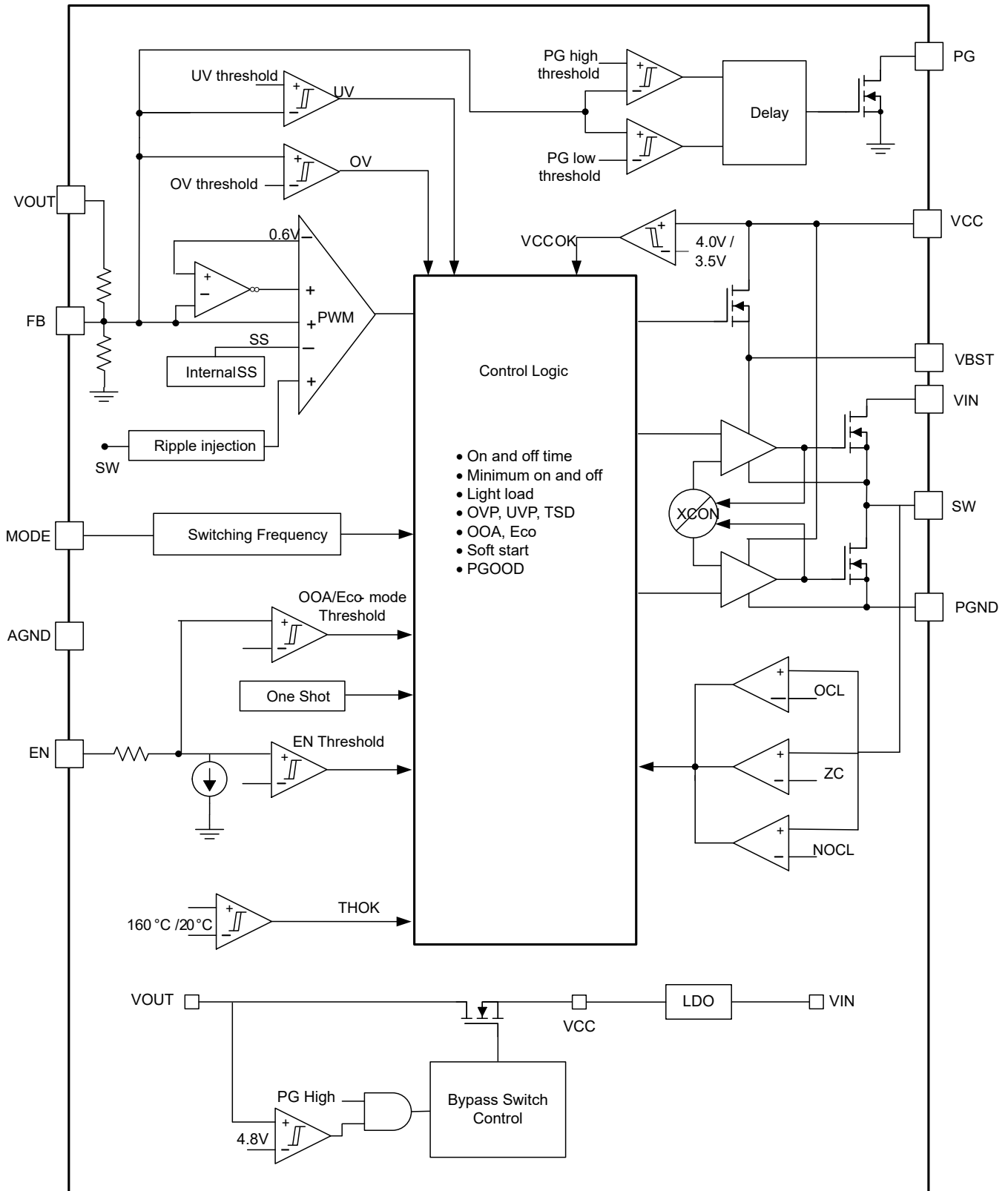

6.3 Feature Description

6.3.1 PWM Operation and D-CAP3™ Control Mode

The main control loop of the buck is an adaptive on-time pulse width modulation (PWM) controller that supports a proprietary D-CAP3 control mode. The D-CAP3 control mode combines adaptive on-time control with an internal compensation circuit for pseudo-fixed frequency and low external component count configuration with both low-ESR and ceramic output capacitors. The D-CAP3 control mode is stable even with virtually no ripple at the output. The TPS513885 also includes an error amplifier that makes the output voltage high accurate.

At the beginning of each cycle, the high-side MOSFET is turned on. This MOSFET is turned off after an internal one-shot timer expires. This one-shot duration is set proportional to the converter input voltage, V_{IN} , and is inversely proportional to the output voltage, V_{OUT} , to maintain a pseudo-fixed frequency over the input voltage range, hence called adaptive on-time control. The one-shot timer is reset and the high-side MOSFET is turned on again when the feedback voltage falls below the reference voltage. An internal ripple generation circuit is added to the reference voltage to emulate the output ripple. This action enables the use of very low-ESR output capacitors such as multi-layered ceramic caps (MLCC). No external current sense network or loop compensation is required for D-CAP3 control mode.

For any control topology that is compensated internally, there is a range of the output filter the control topology can support. The output filter used with the TPS513885 is a low-pass L-C circuit. This L-C filter has a double-pole frequency calculated in [Equation 1](#).

$$f_P = \frac{1}{2 \times \pi \times \sqrt{L_{OUT} \times C_{OUT}}} \quad (1)$$

At low frequencies, the overall loop gain is set by the external output set-point resistor divider network and the internal gain of the TPS513885. The low-frequency L-C double pole has a 180 degree lag in-phase. At the output filter frequency, the gain rolls off at a -40dB per decade rate and the phase drops rapidly. The internal ripple generation network introduces a mid-frequency zero that reduces the gain roll off from -40dB to -20dB per decade and increases the phase to 90 degree one decade above the zero frequency. The inductor and capacitor selected for the output filter must be such that the double pole is placed close enough to the mid-frequency zero so that the phase boost provided by this mid-frequency zero provides adequate phase margin for the stability requirement. The crossover frequency of the overall system must usually be targeted to be less than one-third of the switching frequency (F_{SW}).

6.3.2 VCC Switchover Function

VCC switchover function is designed to bypass internal 5V LDO with the power from VOUT and enhance light load efficiency. The VCC switchover is a seamless behavior of regulator and does not need any additional configuration.

The VCC pin switchover function is asserted when two conditions are present:

- PGOOD is not pulled low
- VOUT voltage is higher than 4.8V

In this switchover condition, one thing occurs: the VCC output is connected to VOUT by internal switchover MOSFET.

6.3.3 Soft Start

The TPS513885 has an internal 0.9ms soft start. When the EN pin becomes high, the internal soft-start function begins ramping up the reference voltage to the PWM comparator. If the output capacitor is prebiased at start-up, the device initiates switching and starts ramping up only after the internal reference voltage becomes greater than the feedback voltage VFB. This scheme makes sure that the converters ramp up smoothly into regulation point.

6.3.4 Large Duty Operation

The TPS513885 can support large duty operation by the internal T_{ON} extension function. When $V_{IN}/V_{OUT} < 1.18$ and the V_{FB} keeps lower than internal V_{REF} , the switching frequency is allowed to smoothly drop to make T_{ON} extended to implement the large duty operation and also improve the performance of the load transient performance. The TPS513885 can support up to 98% duty cycle operation.

6.3.5 Power Good

The Power-Good (PGOOD) pin is an open-drain output. TI recommends a pullup resistor of 100k Ω to pull the voltage up to VCC. After V_{FB} is between 90% and 115% of the target output voltage, the PGOOD is pulled high after a 200 μ s de-glitch time. The PGOOD pin is pulled low when:

- FB pin voltage is lower than 83% or greater than 120% of reference voltage
- In OVP, UVP, or thermal shutdown event
- During the soft-start period

6.3.6 Overcurrent Protection and Undervoltage Protection

The TPS513885 has overcurrent protection and undervoltage protection. The output overcurrent protection (OCP) is implemented using a cycle-by-cycle low-side MOSFET valley current detection and high-side MOSFET peak current detection. The switching current is monitored by measuring the MOSFET drain to source voltage. This voltage is proportional to the switch current. To improve accuracy, the voltage sensing is temperature compensated.

During the on-time of the high-side FET switch, the switch current increases at a linear rate determined by V_{in} , V_{out} , the on-time, and the output inductor value. During the on-time of the low-side FET switch, this current decreases linearly. The average value of the switch current is the load current I_{OUT} . If the monitored current is above the OCL level, the converter maintains low-side FET on and delays the creation of a new pulse, even the voltage feedback loop requires one, until the current level becomes OCL level or lower. In subsequent switching cycles, the on-time is set to a fixed value and the current is monitored in the same manner.

There are some important considerations for this type of overcurrent protection. When the load current is higher than the $I_{OCL(VALLEY)}$ added by one half of the peak-to-peak inductor ripple current, or higher than $I_{OCL(PEAK)}$ subtracted by one half of the peak-to-peak inductor ripple current, the OCP is triggered and the output current is being limited, the output voltage tends to drop because the load demand is higher than what the converter can support. When the output voltage falls below 60% of the target voltage, the UVP comparator detects the fall, and the device is shut off after a wait time of 200 μ s. This protection is a latched function. The fault latching can be reset by EN going low or VCC power cycling.

The TPS513885 also implements negative overcurrent protection, which can prevent inductor current runaway when IC works in OOA mode. When the inductor valley current hits the negative overcurrent threshold ($I_{NOCL} = -5.5A$ typical), the low-side FET turns off, then high-side FET turns on.

6.3.7 Overvoltage Protection

The TPS513885 has an overvoltage protection feature, which has the same implementation. When the output voltage becomes higher than 120% of the target voltage, the OVP comparator output goes high, and the output discharges and latches after a wait time of 256 μ s. This function is a latching operation, so this function needs to reset by EN going low or VIN power cycling.

6.3.8 UVLO Protection

The VIN undervoltage lockout (UVLO) protection monitors the VIN pin voltage to protect the internal circuitry from low input voltage. When the VIN voltage is lower than the UVLO threshold voltage, the device shuts off and outputs are discharged to prevent misoperation of the device. The converter begins operation again when the input voltage exceeds the threshold by a hysteresis of 650mV (typical). This protection is a non-latch protection.

6.3.9 Output Voltage Discharge

TPS513885 has a 50ohm discharge switch that discharges the output VOUT through the Vout pin during any event of fault like output overvoltage, output undervoltage, TSD, or if the VIN voltage is below the UVLO and when the EN pin voltage is below the turn-on threshold.

6.3.10 Thermal Shutdown

The TPS513885 monitors the internal die temperature. If the temperature exceeds the threshold value (typically 160°C), the device is shut off and the output is discharged. This protection is a non-latch protection. The device restarts operation when the temperature goes below the thermal shutdown threshold.

6.4 Device Functional Modes

6.4.1 Light Load Operation

The TPS513885 has the EN pin that can control two different states of operation at light load. Pull the EN above 2.2V for Eco-mode. Pull the EN between 1V to 1.6V for OOA mode. The EN pin can be toggled dynamically, even when the converter is in operation.

6.4.2 Advanced Eco-mode Control

The advanced Eco-mode control schemes to maintain high light load efficiency. As the output current decreases from heavy load conditions, the inductor current is also reduced and eventually comes to a point where the rippled valley touches zero level, which is the boundary between continuous conduction and discontinuous conduction modes. The rectifying MOSFET is turned off when the zero inductor current is detected. As the load current further decreases, the converter runs into discontinuous conduction mode. The on-time is kept almost the same as in continuous conduction mode so that discharging the output capacitor with smaller load current to the level of the reference voltage takes longer. This action makes the switching frequency lower, proportional to the load current, and keeps the light load efficiency high. Use [Equation 2](#) to calculate the light load current where the transition to Eco-mode operation happens ($I_{OUT(LL)}$).

$$I_{OUT(LL)} = \frac{1}{2 \times L_{OUT} \times F_{SW}} \times \frac{(V_{IN} - V_{OUT}) \times V_{OUT}}{V_{IN}} \quad (2)$$

After identifying the application requirements, design the output inductance (L_{OUT}) so that the inductor peak-to-peak ripple current is approximately between 20% and 40% of $I_{OUT(max)}$ (peak current in the application). Sizing the inductor properly so that the valley current does not hit the negative low-side current limit is important.

6.4.3 Out-of-Audio™ Mode

Out-of-Audio (OOA) mode is a unique control feature that keeps the switching frequency above audible frequency with minimum reduction in efficiency. This mode prevents audio noise generation from the output capacitors and inductor. During Out-of-Audio operation, the OOA control circuit monitors the states of both high-side and low-side MOSFETs and forces them to switch. When both high-side and low-side MOSFETs are off for more than 30μs during a light-load condition, the low-side FET discharges until output voltage drops to trigger the high-side FET on or inductor current hits negative OC limit.

If the EN pin is selected to operate in OOA mode, when the device works at light load, the minimum switching frequency is above 20kHz, which avoids the audible noise in the system. When the device works in OOA mode, TI recommends setting the valley value of inductor current above -3A by choosing the appropriate inductor.

6.4.4 Mode Selection

TPS513885 has a MODE pin that can be used to select 560kHz or 920kHz switching frequency. The device reads the voltage on the MODE pin during start-up and latches onto one of the MODE options listed below in [Table 6-1](#).

Table 6-1. MODE Pin Settings

VOLTAGE ON MODE	RECOMMENDED DESIGN	FREQUENCY (kHz)
> 1V	Pull high to VCC/EN	560
< 0.4V	Pull low to GND	920

Figure 6-1 shows the typical start-up sequence of the device after the enable signal crosses the EN turn-on threshold. After the voltage on VCC crosses the rising UVLO threshold, finishing the frequency selection takes about 104µs. The output voltage starts ramping after the mode selection.

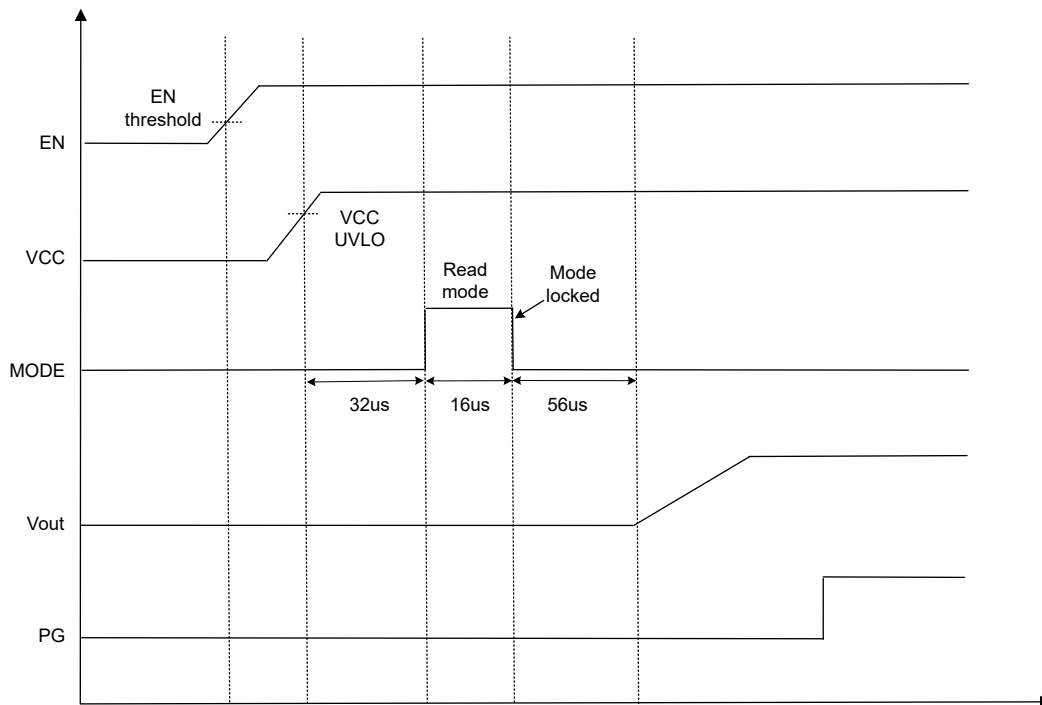

Figure 6-1. Power-Up Sequence

6.4.5 Standby Operation

The TPS513885 can be placed in standby mode by pulling the EN pin low. The device operates with a shutdown current of 3µA when in standby condition. EN pin is pulled low internally. When floating, the part is disabled by default.

7 Application and Implementation

Note

Information in the following applications sections is not part of the TI component specification, and TI does not warrant its accuracy or completeness. TI's customers are responsible for determining suitability of components for their purposes, as well as validating and testing their design implementation to confirm system functionality.

7.1 Application Information

The schematic in [Figure 7-1](#) shows a typical application for TPS513885 with 5.15V output. This design converts an input voltage range of 5.5V to 24V down to 5.15V with a maximum output current of 12A.

7.2 Typical Application

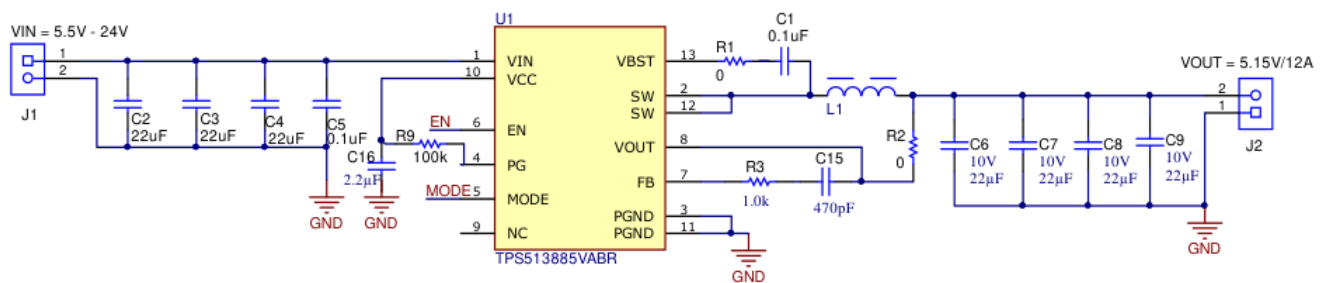

Figure 7-1. 5.15V, 12A Reference Design

7.2.1 Design Requirements

[Table 7-1](#) lists the design parameters for this example.

Table 7-1. Design Parameters

PARAMETER	CONDITIONS	MIN	TYP	MAX	UNIT
OUTPUT					
V_{OUT}	Output voltage		5.15		V
I_{OUT}	Output current		12		A
V_{IN}	Input voltage	5.5	19.5	24	V
$V_{OUT(ripple)}$	Output voltage ripple	0A – 12A loading		40	mV _{p-p}
F_{SW}	Switching frequency		560		kHz
	Light load operating mode		Eco-mode		
T_A	Ambient temperature		25		°C

7.2.2 Detailed Design Procedure

7.2.2.1 Custom Design With WEBENCH® Tools

[Click here](#) to create a custom design using the TPS513885 device with the WEBENCH® Power Designer.

1. Start by entering the input voltage (V_{IN}), output voltage (V_{OUT}), and output current (I_{OUT}) requirements.
2. Optimize the design for key parameters such as efficiency, footprint, and cost using the optimizer dial.
3. Compare the generated design with other possible solutions from Texas Instruments.

The WEBENCH Power Designer provides a customized schematic along with a list of materials with real-time pricing and component availability.

In most cases, these actions are available:

- Run electrical simulations to see important waveforms and circuit performance

- Run thermal simulations to understand board thermal performance
- Export customized schematic and layout into popular CAD formats
- Print PDF reports for the design, and share the design with colleagues

Get more information about WEBENCH tools at www.ti.com/WEBENCH.

7.2.2.2 External Component Selection

7.2.2.2.1 VOUT and FB Pin Configuration

As TPS513885 is with fixed 5.15V output voltage, there is no need to configure the feedback resistor and only connect the output terminal to VOUT pin directly. A feedforward compensation can be used to improve load transient performance.

7.2.2.2.2 MODE Selection

The switching frequency is set by the voltage configured on the MODE pin. See [Table 6-1](#) for possible MODE pin configurations. For this design example, the switching frequency is about 560KHz.

7.2.2.2.3 Inductor Selection

The inductor ripple current is filtered by the output capacitor. A higher inductor ripple current means the output capacitor must have a ripple current rating higher than the inductor ripple current. See [Table 7-2](#) for recommended inductor values.

Use [Equation 3](#) and [Equation 4](#) to calculate the RMS and peak currents through the inductor. Make sure that the inductor is rated to handle these currents.

$$I_{L(rms)} = \sqrt{I_{OUT}^2 + \frac{1}{12} \times \left[\frac{V_{OUT} \times (V_{IN(max)} - V_{OUT})}{V_{IN(max)} \times L_{OUT} \times F_{SW}} \right]^2} \quad (3)$$

$$I_{L(peak)} = I_{OUT} + \frac{I_{OUT(ripple)}}{2} \quad (4)$$

Under transient and short-circuit conditions, the inductor current can increase up to the current limit of the device, choosing an inductor with a saturation current higher than the peak current under current limit condition is safe.

7.2.2.2.4 Output Capacitor Selection

After selecting the inductor, the output capacitor must be optimized. In D-CAP3 control mode, the regulator reacts within one cycle to the change in the duty cycle, so good transient performance can be achieved without needing large amounts of output capacitance. The recommended output capacitance range is given in the following table. Ceramic capacitors have very low ESR, otherwise the maximum ESR of the capacitor must be less than $V_{OUT(ripple)}/I_{OUT(ripple)}$.

Table 7-2. Recommended Component Values

V _{OUT} (V)	F _{sw} (kHz)	L _{OUT} (μH)	C _{OUT(min)} (μF)	C _{OUT(max)} (μF)	R _{FF} (kΩ)	C _{FF} (pF)
5.15	560	1.5	88	198	1	470
5.15	920	1.5	44	88	1	100

7.2.2.2.5 Input Capacitor Selection

The TPS513885 requires input decoupling capacitors on power supply input pin VIN, and the bulk capacitors are needed depending on the application. Use [Equation 5](#) to calculate the minimum input capacitance required.

$$C_{IN(min)} = \frac{I_{OUT} \times V_{OUT}}{V_{IN(ripple)} \times V_{IN} \times F_{SW}} \quad (5)$$

TI recommends using a high-quality X5R or X7R input decoupling capacitors of nominal 44μF/35V on the input voltage pin VIN. The voltage rating on the input capacitor must be greater than the maximum input voltage. The

capacitor must also have a ripple current rating greater than the maximum input current ripple of the application. Use [Equation 6](#) to calculate the input ripple current:

$$I_{CIN(rms)} = I_{OUT} \times \sqrt{\frac{V_{OUT}}{V_{IN(min)}} \times \frac{(V_{IN(min)} - V_{OUT})}{V_{IN(min)}}} \quad (6)$$

7.2.3 Application Curves

Figure 7-2 through Figure 7-19 apply to the circuit of Figure 7-1. $V_{IN} = 12V$, $F_{SW} = 560kHz$, $T_A = 25^\circ C$, unless otherwise specified.

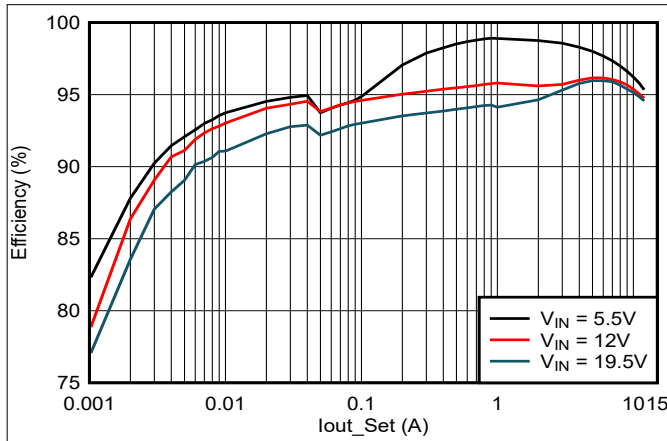

Figure 7-2. Efficiency Curve (ECO)

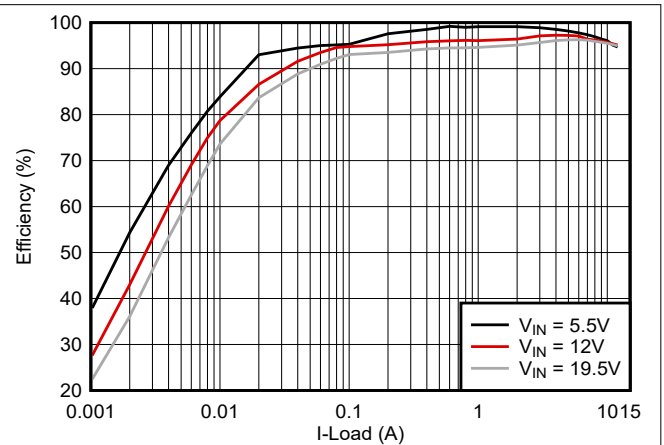

Figure 7-3. Efficiency Curve (OOA)

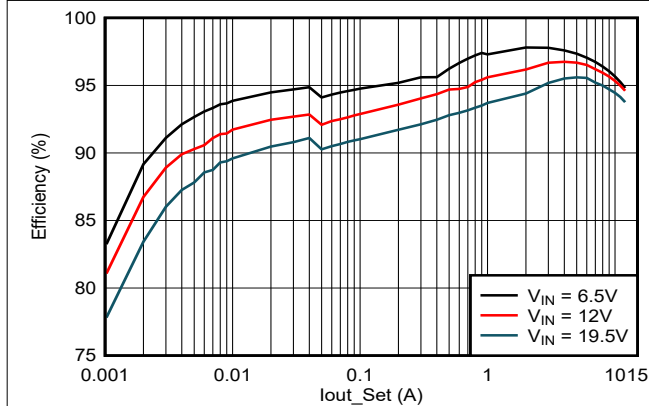

Figure 7-4. Efficiency Curve (ECO, $F_{SW} = 920kHz$)

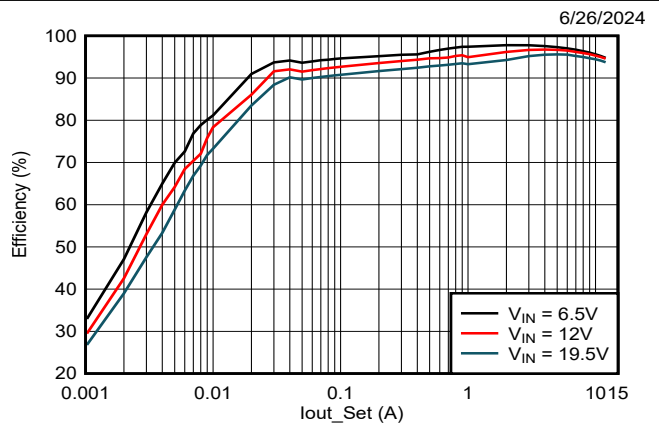

Figure 7-5. Efficiency Curve (OOA, $F_{SW} = 920kHz$)

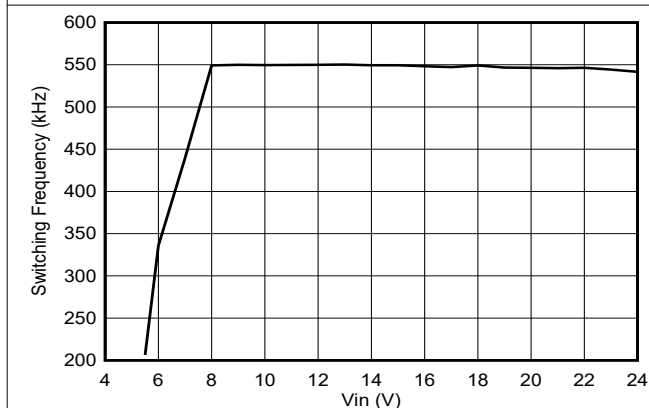

Figure 7-6. Switching Frequency vs Input Voltage, $I_{OUT} = 6A$

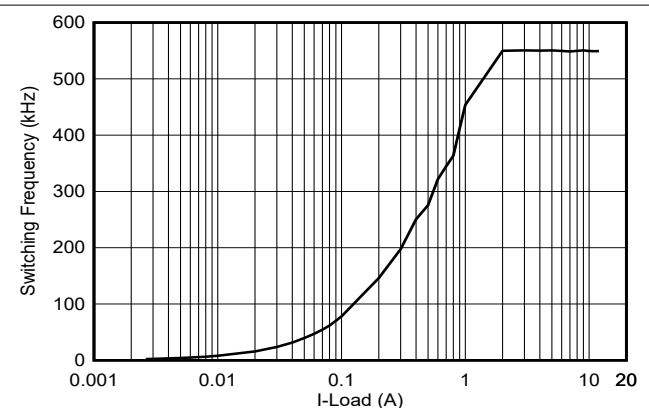

Figure 7-7. Switching Frequency vs Output Load (ECO)

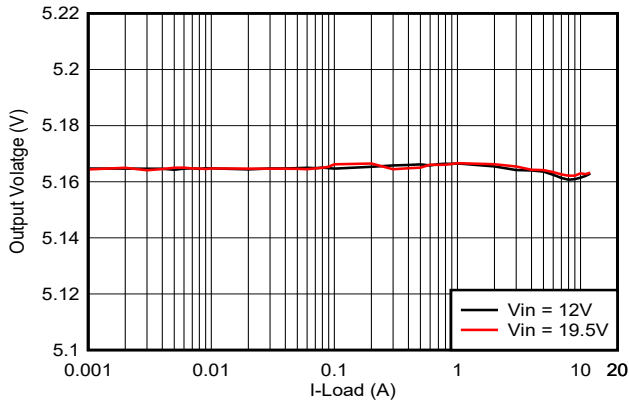

Figure 7-8. Load Regulation, $V_{in} = 12V / 19.5V$

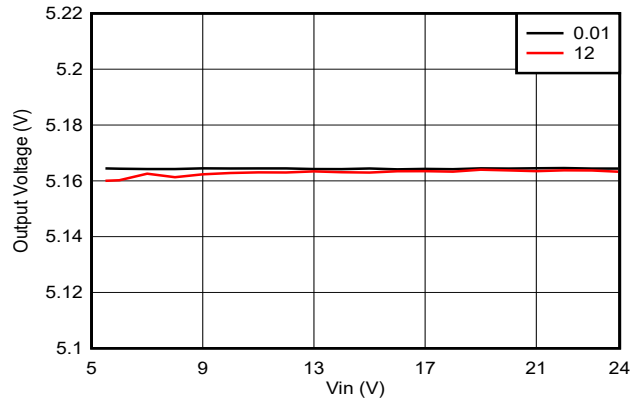

Figure 7-9. Line Regulation, $I_{OUT} = 0.01A / 12A$

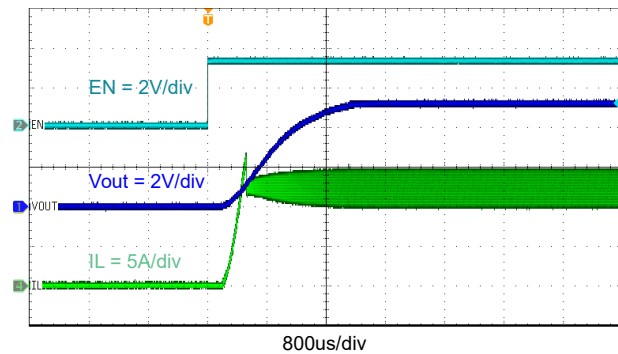

Figure 7-10. Start-Up Through EN, $I_{OUT} = 12A$

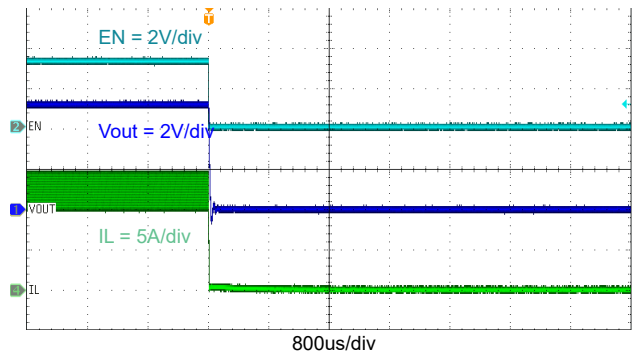

Figure 7-11. Shutdown Through EN, $I_{OUT} = 12A$

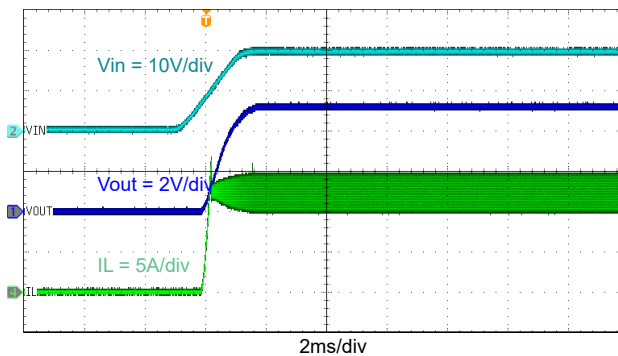

Figure 7-12. Start-Up Relative to VIN Rising, $I_{OUT} = 12A$

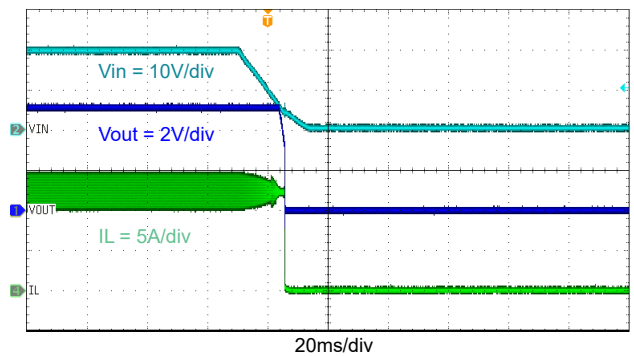

Figure 7-13. Shutdown Relative to VIN Falling, $I_{OUT} = 5A$

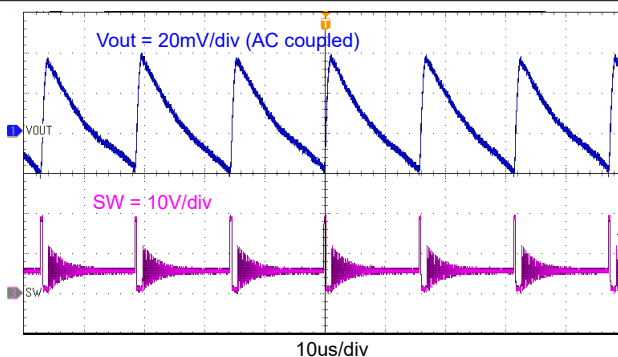

Figure 7-14. Output Voltage Ripple, $I_{OUT} = 0.1A$

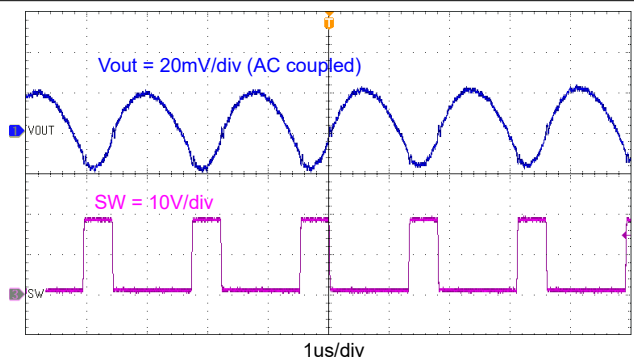

Figure 7-15. Output Voltage Ripple, $I_{OUT} = 6A$

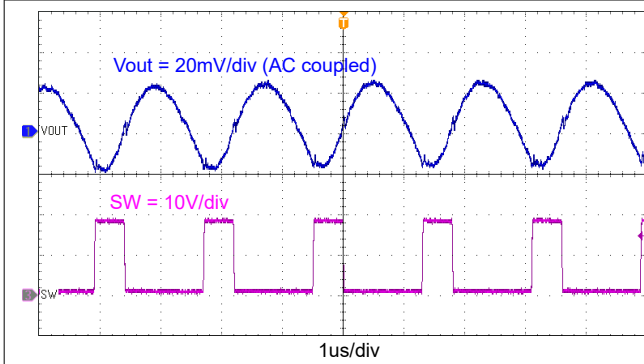

Figure 7-16. Output Voltage Ripple, $I_{OUT} = 12A$

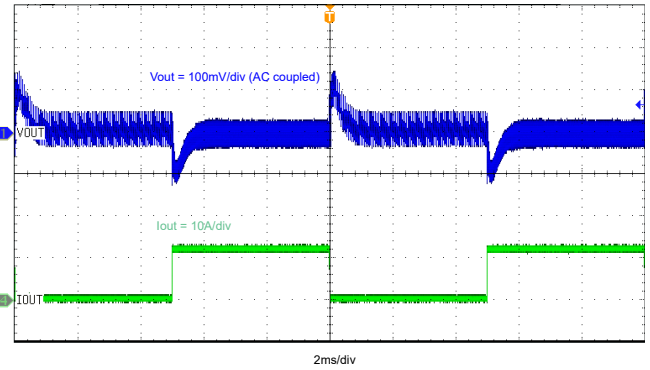

Figure 7-17. Transient Response, 0A to 12A, Slew Rate = 1.6A/ μ s

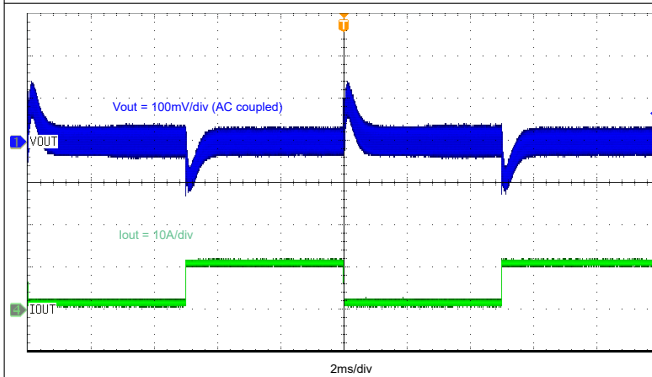

Figure 7-18. Transient Response, 1.2A to 10.8A, Slew Rate = 1.6A/ μ s

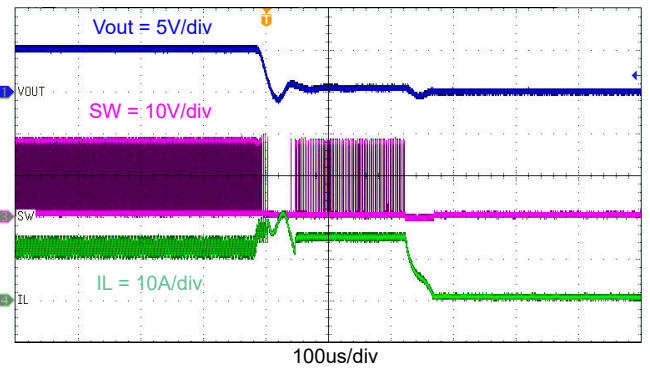

Figure 7-19. Normal Operation to Output Hard Short

7.3 Power Supply Recommendations

The TPS513885 is intended to be powered by a well-regulated DC voltage. The input voltage range is 5.5V to 24V. The TPS513885 is a buck converter. The input supply voltage must be greater than the desired output voltage for proper operation. Input supply current must be appropriate for the desired output current. If the input voltage supply is located far away from the TPS513885 circuit, TI recommends some additional input bulk capacitance. Typical values are 100 μ F to 470 μ F.

7.4 Layout

7.4.1 Layout Guidelines

- Make note that the PCB layout of any DC/DC converter is critical to the excellent performance of the design. Bad PCB layout can disrupt the operation of a good schematic design. Even if the converter regulates correctly, bad PCB layout can mean the difference between a robust design and one that cannot be mass produced. Furthermore, the EMI performance of the converter is dependent on the PCB layout to a great extent. In a buck converter, the most critical PCB feature is the loop formed by the input capacitors and power ground. This loop carries large transient currents that can cause large transient voltages when reacting with the trace inductance. These unwanted transient voltages disrupt the proper operation of the converter. Because of this fact, the traces in this loop must be wide and short, and the loop area as small as possible to reduce the parasitic inductance.
- Use a four-layer PCB for good thermal performance and with maximum ground plane. 3-inch \times 2.75-inch, top and bottom layer PCB with 2oz copper is used as example.
- Place the decoupling capacitors right across VIN and VCC as close as possible.
- Place output inductors and capacitors with IC at the same layer. The SW routing must be as short as possible to minimize EMI, and must be a wide plane to carry big current. Enough vias must be added to the PGND connection of output capacitors and also as close to the output pin as possible.
- Place BST resistor and capacitor with IC at the same layer, close to BST and SW plane. TI recommends > 10-mil width trace to reduce line parasitic inductance.
- Make feedback 10 mil and routed away from the switching node, BST node, or other high speed digital signal.
- Make VIN trace wide to reduce the trace impedance and provide enough current capability.
- Place multiple vias under the device near VIN and PGND and near input capacitors to reduce parasitic inductance and improve thermal performance.

7.4.2 Layout Example

Figure 7-20 shows the recommended top-side layout. Component reference designators are the same as the circuit shown in *TPS513885 Step-Down Converter Evaluation Module* EVM user's guide.

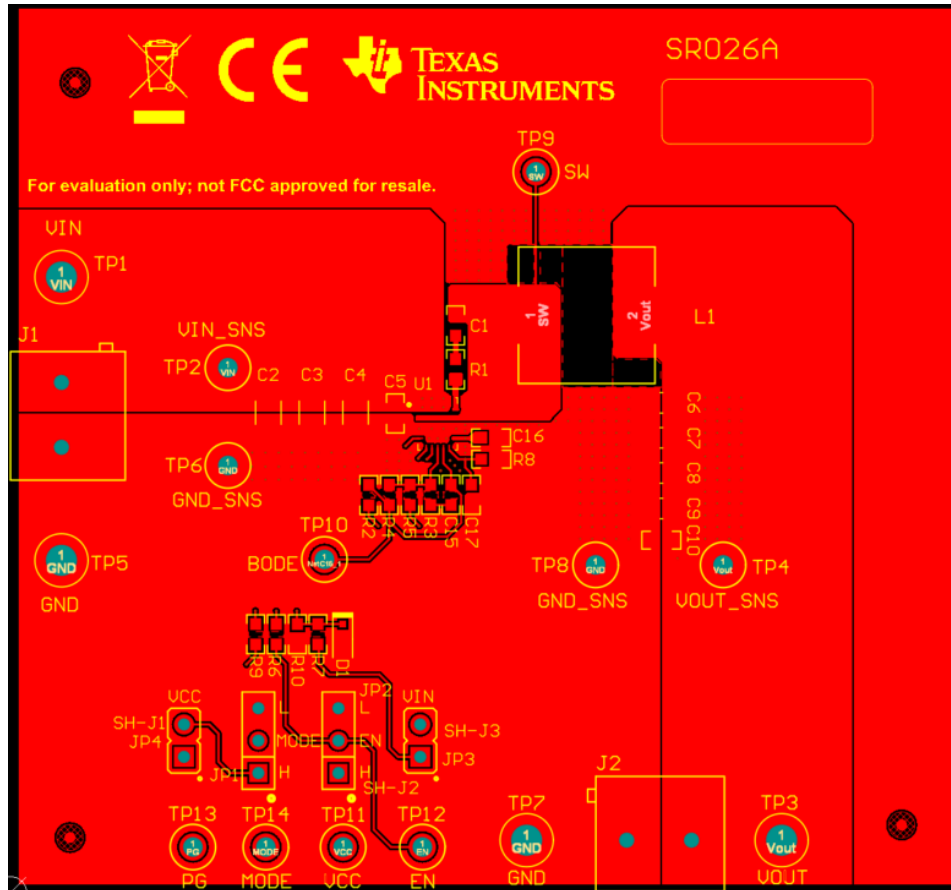

Figure 7-20. Top-Side Layout

8 Device and Documentation Support

8.1 Device Support

8.1.1 Development Support

8.1.1.1 Custom Design With WEBENCH® Tools

[Click here](#) to create a custom design using the TPS513885 device with the WEBENCH® Power Designer.

1. Start by entering the input voltage (V_{IN}), output voltage (V_{OUT}), and output current (I_{OUT}) requirements.
2. Optimize the design for key parameters such as efficiency, footprint, and cost using the optimizer dial.
3. Compare the generated design with other possible solutions from Texas Instruments.

The WEBENCH Power Designer provides a customized schematic along with a list of materials with real-time pricing and component availability.

In most cases, these actions are available:

- Run electrical simulations to see important waveforms and circuit performance
- Run thermal simulations to understand board thermal performance
- Export customized schematic and layout into popular CAD formats
- Print PDF reports for the design, and share the design with colleagues

Get more information about WEBENCH tools at www.ti.com/WEBENCH.

8.2 Documentation Support

8.2.1 Related Documentation

For related documentation, see the following:

Texas Instruments, [TPS513885 Step-Down Converter Evaluation Module](#) EVM user's guide

8.3 Receiving Notification of Documentation Updates

To receive notification of documentation updates, navigate to the device product folder on ti.com. Click on *Notifications* to register and receive a weekly digest of any product information that has changed. For change details, review the revision history included in any revised document.

8.4 Support Resources

[TI E2E™ support forums](#) are an engineer's go-to source for fast, verified answers and design help — straight from the experts. Search existing answers or ask your own question to get the quick design help you need.

Linked content is provided "AS IS" by the respective contributors. They do not constitute TI specifications and do not necessarily reflect TI's views; see TI's [Terms of Use](#).

8.5 Trademarks

D-CAP3™, Out-of-Audio™, ULQ™, HotRod™, and TI E2E™ are trademarks of Texas Instruments.

WEBENCH® is a registered trademark of Texas Instruments.

All trademarks are the property of their respective owners.

8.6 Electrostatic Discharge Caution



This integrated circuit can be damaged by ESD. Texas Instruments recommends that all integrated circuits be handled with appropriate precautions. Failure to observe proper handling and installation procedures can cause damage.

ESD damage can range from subtle performance degradation to complete device failure. Precision integrated circuits may be more susceptible to damage because very small parametric changes could cause the device not to meet its published specifications.

8.7 Glossary

[TI Glossary](#) This glossary lists and explains terms, acronyms, and definitions.

9 Revision History

NOTE: Page numbers for previous revisions may differ from page numbers in the current version.

Changes from Revision A (June 2024) to Revision B (December 2024)	Page
• Updated specifications in the <i>Electrical Characteristics</i> table.....	5
• Updated the <i>Functional Block Diagram</i>	11

Changes from Revision * (May 2024) to Revision A (June 2024)	Page
• Changed document status from Advance Information to Production Data.....	1

10 Mechanical, Packaging, and Orderable Information

The following pages include mechanical, packaging, and orderable information. This information is the most current data available for the designated devices. This data is subject to change without notice and revision of this document. For browser-based versions of this data sheet, refer to the left-hand navigation.

PACKAGING INFORMATION

Orderable Device	Status (1)	Package Type	Package Drawing	Pins	Package Qty	Eco Plan (2)	Lead finish/ Ball material (6)	MSL Peak Temp (3)	Op Temp (°C)	Device Marking (4/5)	Samples
TPS513885VABR	ACTIVE	VQFN-HR	VAB	13	4000	RoHS & Green	SN	Level-2-260C-1 YEAR	-20 to 125	513885	Samples

(1) The marketing status values are defined as follows:

ACTIVE: Product device recommended for new designs.

LIFEBUY: TI has announced that the device will be discontinued, and a lifetime-buy period is in effect.

NRND: Not recommended for new designs. Device is in production to support existing customers, but TI does not recommend using this part in a new design.

PREVIEW: Device has been announced but is not in production. Samples may or may not be available.

OBSELETE: TI has discontinued the production of the device.

(2) **RoHS:** TI defines "RoHS" to mean semiconductor products that are compliant with the current EU RoHS requirements for all 10 RoHS substances, including the requirement that RoHS substance do not exceed 0.1% by weight in homogeneous materials. Where designed to be soldered at high temperatures, "RoHS" products are suitable for use in specified lead-free processes. TI may reference these types of products as "Pb-Free".

RoHS Exempt: TI defines "RoHS Exempt" to mean products that contain lead but are compliant with EU RoHS pursuant to a specific EU RoHS exemption.

Green: TI defines "Green" to mean the content of Chlorine (Cl) and Bromine (Br) based flame retardants meet JS709B low halogen requirements of <=1000ppm threshold. Antimony trioxide based flame retardants must also meet the <=1000ppm threshold requirement.

(3) MSL, Peak Temp. - The Moisture Sensitivity Level rating according to the JEDEC industry standard classifications, and peak solder temperature.

(4) There may be additional marking, which relates to the logo, the lot trace code information, or the environmental category on the device.

(5) Multiple Device Markings will be inside parentheses. Only one Device Marking contained in parentheses and separated by a "~" will appear on a device. If a line is indented then it is a continuation of the previous line and the two combined represent the entire Device Marking for that device.

(6) Lead finish/Ball material - Orderable Devices may have multiple material finish options. Finish options are separated by a vertical ruled line. Lead finish/Ball material values may wrap to two lines if the finish value exceeds the maximum column width.

Important Information and Disclaimer:The information provided on this page represents TI's knowledge and belief as of the date that it is provided. TI bases its knowledge and belief on information provided by third parties, and makes no representation or warranty as to the accuracy of such information. Efforts are underway to better integrate information from third parties. TI has taken and continues to take reasonable steps to provide representative and accurate information but may not have conducted destructive testing or chemical analysis on incoming materials and chemicals. TI and TI suppliers consider certain information to be proprietary, and thus CAS numbers and other limited information may not be available for release.

In no event shall TI's liability arising out of such information exceed the total purchase price of the TI part(s) at issue in this document sold by TI to Customer on an annual basis.

TAPE AND REEL INFORMATION

QUADRANT ASSIGNMENTS FOR PIN 1 ORIENTATION IN TAPE

*All dimensions are nominal

Device	Package Type	Package Drawing	Pins	SPQ	Reel Diameter (mm)	Reel Width W1 (mm)	A0 (mm)	B0 (mm)	K0 (mm)	P1 (mm)	W (mm)	Pin1 Quadrant
TPS513885VABR	VQFN-HR	VAB	13	4000	330.0	12.4	3.3	4.3	1.1	8.0	12.0	Q1

TAPE AND REEL BOX DIMENSIONS

*All dimensions are nominal

Device	Package Type	Package Drawing	Pins	SPQ	Length (mm)	Width (mm)	Height (mm)
TPS513885VABR	VQFN-HR	VAB	13	4000	367.0	367.0	35.0

EXAMPLE BOARD LAYOUT

VAB0013A

VQFN-HR - 1 mm max height

PLASTIC QUAD FLATPACK - NO LEAD

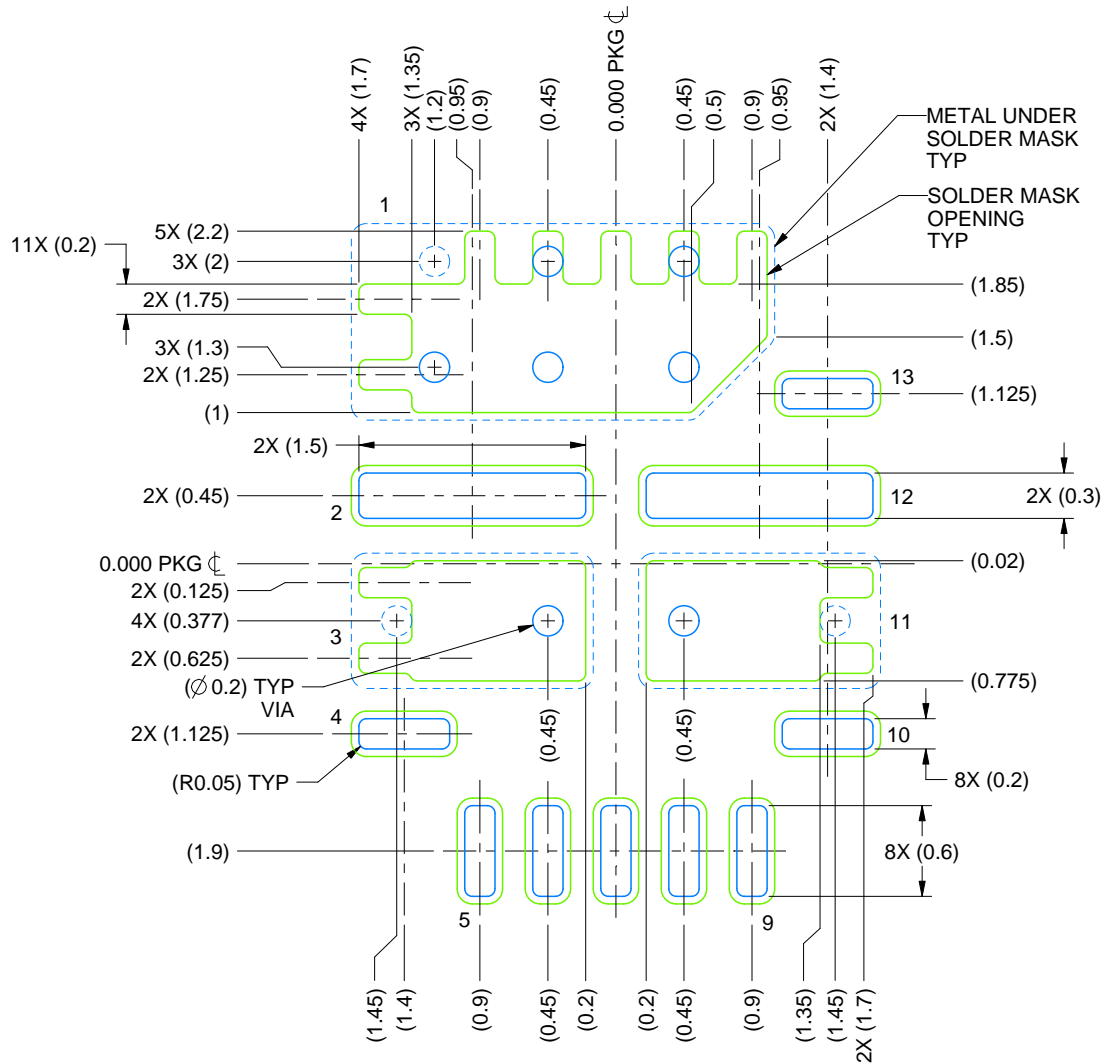

LAND PATTERN EXAMPLE
SCALE: 20X

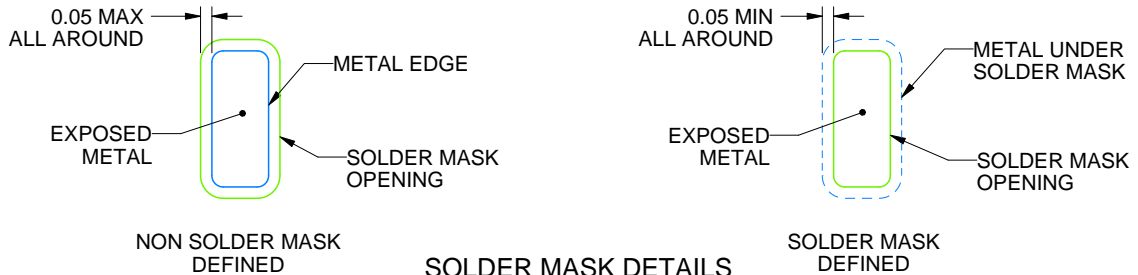

4229588/B 06/2023

NOTES: (continued)

- This package is designed to be soldered to a thermal pad on the board. For more information, see Texas Instruments literature number SLUA271 (www.ti.com/lit/slua271).
- Vias are optional depending on application, refer to device data sheet. If any vias are implemented, refer to their locations shown on this view. It is recommended that vias under paste be filled, plugged or tented.

EXAMPLE STENCIL DESIGN

VAB0013A

VQFN-HR - 1 mm max height

PLASTIC QUAD FLATPACK - NO LEAD

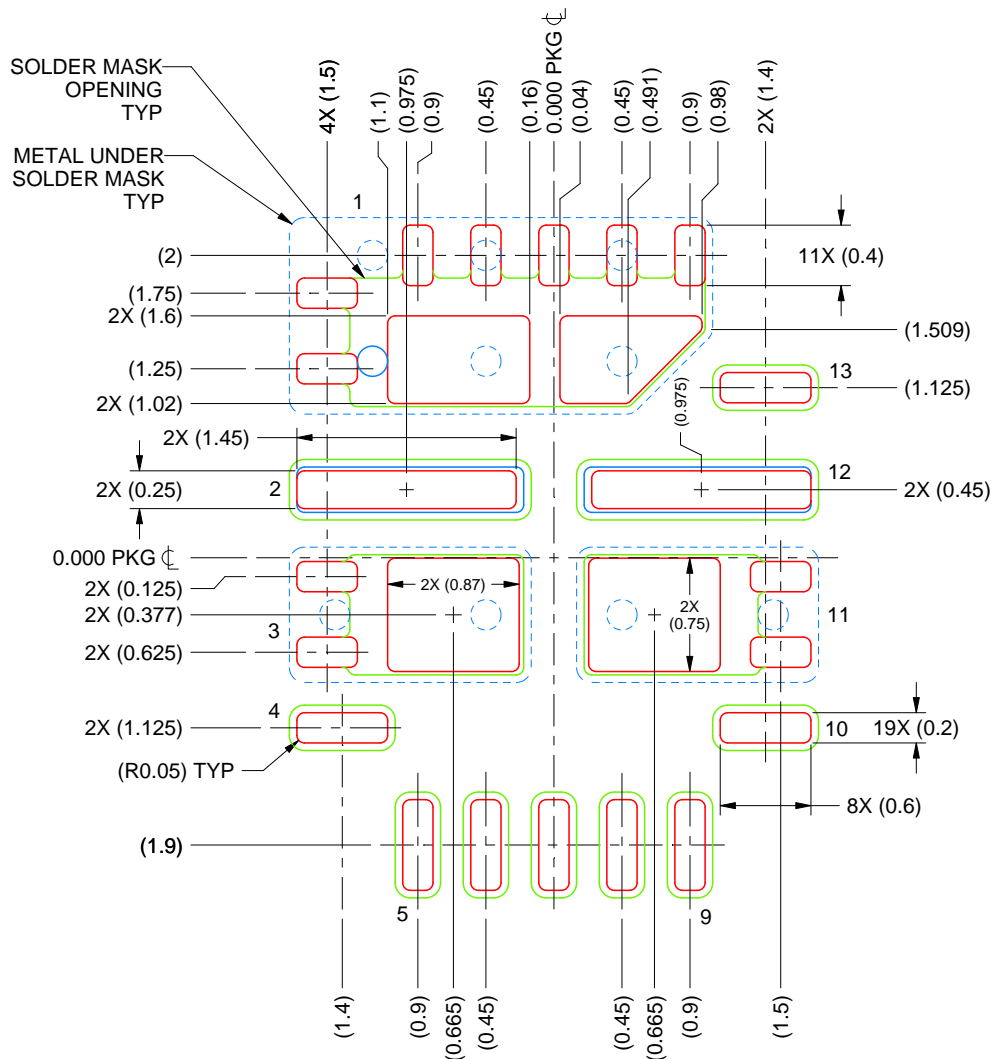

SOLDER PASTE EXAMPLE
 BASED ON 0.1 mm THICK STENCIL
 SCALE: 20X

SOLDER COVERAGE BY AREA UNDER PACKAGE
 PIN 1: 64%
 PIN 2 & 12: 80%
 PIN 3 & 11: 77%

4229588/B 06/2023

NOTES: (continued)

6. Laser cutting apertures with trapezoidal walls and rounded corners may offer better paste release. IPC-7525 may have alternate design recommendations.

IMPORTANT NOTICE AND DISCLAIMER

TI PROVIDES TECHNICAL AND RELIABILITY DATA (INCLUDING DATA SHEETS), DESIGN RESOURCES (INCLUDING REFERENCE DESIGNS), APPLICATION OR OTHER DESIGN ADVICE, WEB TOOLS, SAFETY INFORMATION, AND OTHER RESOURCES "AS IS" AND WITH ALL FAULTS, AND DISCLAIMS ALL WARRANTIES, EXPRESS AND IMPLIED, INCLUDING WITHOUT LIMITATION ANY IMPLIED WARRANTIES OF MERCHANTABILITY, FITNESS FOR A PARTICULAR PURPOSE OR NON-INFRINGEMENT OF THIRD PARTY INTELLECTUAL PROPERTY RIGHTS.

These resources are intended for skilled developers designing with TI products. You are solely responsible for (1) selecting the appropriate TI products for your application, (2) designing, validating and testing your application, and (3) ensuring your application meets applicable standards, and any other safety, security, regulatory or other requirements.

These resources are subject to change without notice. TI grants you permission to use these resources only for development of an application that uses the TI products described in the resource. Other reproduction and display of these resources is prohibited. No license is granted to any other TI intellectual property right or to any third party intellectual property right. TI disclaims responsibility for, and you will fully indemnify TI and its representatives against, any claims, damages, costs, losses, and liabilities arising out of your use of these resources.

TI's products are provided subject to [TI's Terms of Sale](#) or other applicable terms available either on [ti.com](https://www.ti.com) or provided in conjunction with such TI products. TI's provision of these resources does not expand or otherwise alter TI's applicable warranties or warranty disclaimers for TI products.

TI objects to and rejects any additional or different terms you may have proposed.

Mailing Address: Texas Instruments, Post Office Box 655303, Dallas, Texas 75265
Copyright © 2024, Texas Instruments Incorporated