

# TPS6282x 2.4V to 5.5V Input, 1, 2, 3, 4A Step-Down Converter With 1% Output Accuracy

## 1 Features

- Available as an integrated-inductor power module: [TPSM82821](#), [TPSM82822](#), and [TPSM82823](#)
- DCS-Control topology
- 1% feedback or output voltage accuracy (full temperature range)
- Up to 97% efficiency
- 26mΩ and 25mΩ internal power MOSFETs
- 2.4V to 5.5V input voltage range
- 4μA operating quiescent current
- 2.2MHz switching frequency
- 0.6V to 4V adjustable output voltage
- Power save mode for light load efficiency
- 100% duty cycle for lowest dropout
- Active output discharge
- Power-good output
- Thermal shutdown protection
- Hiccup short-circuit protection
- A forced-PWM version for CCM operation
- Create a custom design using the TPS6282x with the [WEBENCH® Power Designer](#)

## 2 Applications

- [Solid state drive](#)
- [Portable electronics](#)
- [Analog security](#) and [IP network](#) cameras
- [Industrial PC](#)
- [Multifunction printers](#)
- Generic point of load

## 3 Description

The TPS6282x is an easy-to-use, synchronous step-down DC/DC converters family with a very low quiescent current of only 4μA. Based on the DCS-Control topology, the device provides a fast transient response. The internal reference allows to regulate the output voltage down to 0.6V with a high feedback voltage accuracy of 1% over the junction temperature range of -40°C to 125°C. The family devices are pin-to-pin and BOM-to-BOM compatible. The entire design requires a small 470nH inductor, a single 4.7μF input capacitor, and two 10μF or single 22μF output capacitor.

The TPS6282x is available in two flavors. The first includes an automatically entered power save mode to maintain high efficiency down to very light loads for extending the system battery run-time. The second runs in forced-PWM maintaining a continuous conduction mode to make sure of the least ripple in the output voltage and a quasi-fixed switching frequency. The device features a Power-Good signal and an internal soft-start circuit. The device is able to operate in 100% mode. For fault protection, the device incorporates a HICCUP short-circuit protection as well as a thermal shutdown. The device is available in a 6-pin 1.5mm × 1.5mm QFN package, offering the highest power density design.

### Device Information

PART NUMBER	PACKAGE <sup>(1)</sup>	PACKAGE SIZE <sup>(2)</sup>
TPS6282xx	DMQ (VSON-HR, 6)	1.5mm × 1.5mm

(1) For more information, see [Section 11](#).

(2) The package size (length × width) is a nominal value and includes pins, where applicable.

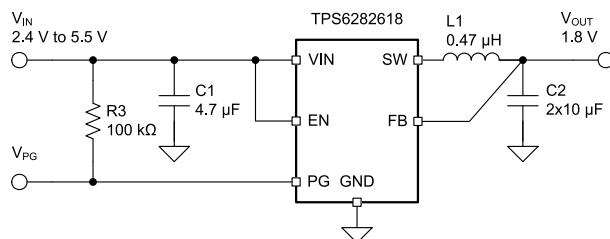

Typical Application Schematic

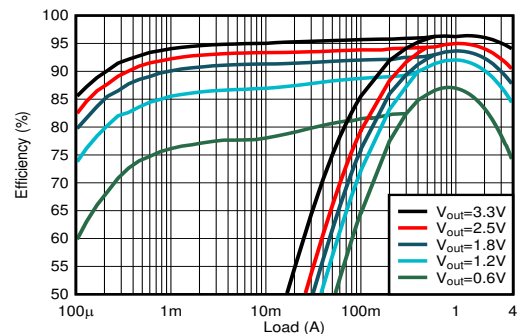

Efficiency at  $V_{IN} = 5V$



## Table of Contents

<b>1 Features</b> .....	1	7.4 Device Functional Modes.....	10
<b>2 Applications</b> .....	1	<b>8 Application and Implementation</b> .....	11
<b>3 Description</b> .....	1	8.1 Application Information.....	11
<b>4 Device Options</b> .....	3	8.2 Typical Application.....	11
<b>5 Pin Configuration and Functions</b> .....	3	8.3 Power Supply Recommendations.....	22
<b>6 Specifications</b> .....	4	8.4 Layout.....	22
6.1 Absolute Maximum Ratings.....	4	<b>9 Device and Documentation Support</b> .....	24
6.2 ESD Ratings.....	4	9.1 Device Support.....	24
6.3 Recommended Operating Conditions.....	4	9.2 Documentation Support.....	24
6.4 Thermal Information.....	4	9.3 Support Resources.....	24
6.5 Electrical Characteristics.....	5	9.4 Trademarks.....	24
6.6 Typical Characteristics.....	7	9.5 Electrostatic Discharge Caution.....	24
<b>7 Detailed Description</b> .....	8	9.6 Glossary.....	24
7.1 Overview.....	8	<b>10 Revision History</b> .....	25
7.2 Functional Block Diagram.....	8	<b>11 Mechanical, Packaging, and Orderable Information</b> .....	25
7.3 Feature Description.....	9		

## 4 Device Options

PART NUMBER	OUTPUT VOLTAGE	OPERATION MODE	OUTPUT CURRENT
TPS62824DMQ	Adjustable	PSM/PWM	1A
TPS62825DMQ	Adjustable		2A
TPS6282518DMQ	1.8V		
TPS6282533DMQ	3.3V		3A
TPS62826DMQ	Adjustable		
TPS6282618DMQ	1.8V		
TPS62827DMQ	Adjustable		4A
TPS62824ADMQ	Adjustable	Forced-PWM	1A
TPS62825ADMQ	Adjustable		2A
TPS62826ADMQ	Adjustable		3A
TPS62827ADMQ	Adjustable		4A

## 5 Pin Configuration and Functions

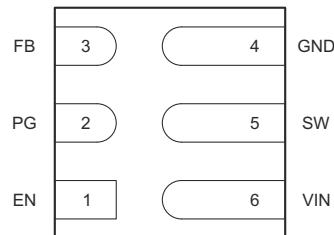

Figure 5-1. DMQ Package, 6-Pin VSON-HR (Bottom View)

Table 5-1. Pin Functions

PIN		TYPE <sup>(1)</sup>	DESCRIPTION
NAME	NO.		
EN	1	I	Device enable pin. To enable the device, this pin must be pulled high. Pulling this pin low disables the device. Do not leave floating.
PG	2	O	Power-good open-drain output pin. The pullup resistor can be connected to voltages up to 5.5V. If unused, leave the pin floating.
FB	3	I	Feedback pin. For the fixed output voltage versions, this pin must be connected to the output.
GND	4		Ground pin
SW	5	PWR	Switch pin of the power stage
VIN	6	PWR	Input voltage pin

(1) I = input, O = output, PWR = power

## 6 Specifications

### 6.1 Absolute Maximum Ratings

Over operating junction temperature range (unless otherwise noted) <sup>(1)</sup>

		MIN	MAX	UNIT
Voltage at Pins <sup>(2)</sup>	VIN, FB, EN, PG	-0.3	6	V
	SW (DC) <sup>(4)</sup>	-0.3	VIN + 0.3	
	SW (DC, in current limit)	-1.0	VIN + 0.3	
	SW (AC, less than 10ns) <sup>(3)</sup>	-2.5	10	
	SW (AC, PFM Mode, less than 100ns) <sup>(3)</sup>	-1.0	VIN + 1.0	
Temperature	Operating junction temperature, TJ	-40	150	°C
	Storage temperature, Tstg	-65	150	

- (1) Operation outside the *Absolute Maximum Ratings* may cause permanent device damage. *Absolute Maximum Ratings* do not imply functional operation of the device at these or any other conditions beyond those listed under *Recommended Operating Conditions*. If used outside the *Recommended Operating Conditions* but within the *Absolute Maximum Ratings*, the device may not be fully functional, and this may affect device reliability, functionality, performance, and shorten the device lifetime.
- (2) All voltage values are with respect to network ground terminal.
- (3) While switching.
- (4) After disabling the device, the SW voltage may exceed the MIN specification until the inductor and output capacitor are fully discharged.

### 6.2 ESD Ratings

			VALUE	UNIT
V(ESD)	Electrostatic discharge	Human-body model (HBM), per ANSI/ESDA/JEDEC JS-001 <sup>(1)</sup>	±2000	V
		Charged-device model (CDM), per JEDEC specification JESD22-C101 <sup>(2)</sup>	±500	V

- (1) JEDEC document JEP155 states that 500-V HBM allows safe manufacturing with a standard ESD control process.
- (2) JEDEC document JEP157 states that 250-V CDM allows safe manufacturing with a standard ESD control process.

### 6.3 Recommended Operating Conditions

Over operating junction temperature range (unless otherwise noted)

		MIN	NOM	MAX	UNIT
VIN	Input voltage range, TPS62824x, TPS62825x and TPS62826x	2.4		5.5	V
VIN	Input voltage range, TPS62827x	2.5		5.5	V
VOUT	Output voltage range	0.6		4.0	V
IOUT	Output current range, TPS62824x	0		1	A
IOUT	Output current range, TPS62825x	0		2	A
IOUT	Output current range, TPS62826x	0		3	A
IOUT	Output current range, TPS62827x	0		4	A
ISINK_PG	Sink current at PG pin			1	mA
VPG	Pull-up resistor voltage			5.5	V
TJ	Operating junction temperature	-40		125	°C

### 6.4 Thermal Information

THERMAL METRIC <sup>(1)</sup>		DEVICE		UNIT
		TPS6282x, JEDEC	TPS62826EVM-794	
		6 pins	6 pins	
RθJA	Junction-to-ambient thermal resistance	129.5	71.4	°C/W
RθJC(top)	Junction-to-case (top) thermal resistance	103.9	n/a <sup>(2)</sup>	°C/W
RθJB	Junction-to-board thermal resistance	33.1	n/a <sup>(2)</sup>	°C/W
ψJT	Junction-to-top characterization parameter	3.8	3.9	°C/W

## 6.4 Thermal Information (continued)

THERMAL METRIC <sup>(1)</sup>		DEVICE		UNIT
		TPS6282x, JEDEC	TPS62826EVM-794	
		6 pins	6 pins	
$\Psi_{JB}$	Junction-to-board characterization parameter	33.1	38.6	°C/W

- (1) For more information about traditional and new thermal metrics, see the [Semiconductor and IC Package Thermal Metrics](#) application report.
- (2) Not applicable to an EVM.

## 6.5 Electrical Characteristics

$T_J = -40\text{ °C}$  to  $125\text{ °C}$ , and  $V_{IN} = 2.4\text{ V}$  to  $5.5\text{ V}$ . Typical values are at  $T_J = 25\text{ °C}$  and  $V_{IN} = 5\text{ V}$ , unless otherwise noted.

PARAMETER		TEST CONDITIONS	MIN	TYP	MAX	UNIT
<b>SUPPLY</b>						
$I_Q$	Quiescent current	EN = High, no load, device not switching		4	10	μA
$I_Q$	Quiescent current	EN = High, no load, FPWM devices		8		mA
$I_{SD}$	Shutdown current	EN = Low, $T_J = -40\text{ °C}$ to $85\text{ °C}$		0.05	0.5	μA
$V_{UVLO}$	Under voltage lock out threshold	$V_{IN}$ falling	2.1	2.2	2.3	V
	Under voltage lock out hysteresis	$V_{IN}$ rising		160		mV
$T_{JSD}$	Thermal shutdown threshold	$T_J$ rising		150		°C
	Thermal shutdown hysteresis	$T_J$ falling		20		°C
<b>LOGIC INTERFACE EN</b>						
$V_{IH}$	High-level threshold voltage		1.0			V
$V_{IL}$	Low-level threshold voltage				0.4	V
$I_{EN,LKG}$	Input leakage current into EN pin	EN = High		0.01	0.1	μA
<b>SOFT START, POWER GOOD</b>						
$t_{SS}$	Soft start time	Time from EN high to 95% of $V_{OUT}$ nominal, TPS62827		1.75		ms
		Time from EN high to 95% of $V_{OUT}$ nominal, TPS62824x/5x/6x/7A		1.25		ms
$V_{PG}$	Power good lower threshold	$V_{PG}$ rising, $V_{FB}$ referenced to $V_{FB}$ nominal	94	96	98	%
		$V_{PG}$ falling, $V_{FB}$ referenced to $V_{FB}$ nominal	90	92	94	%
	Power good upper threshold	$V_{PG}$ rising, $V_{FB}$ referenced to $V_{FB}$ nominal	108	110	112	%
		$V_{PG}$ falling, $V_{FB}$ referenced to $V_{FB}$ nominal	103	105	107	%
$V_{PG,OL}$	Low-level output voltage	$I_{sink} = 1\text{ mA}$			0.4	V
$I_{PG,LKG}$	Input leakage current into PG pin	$V_{PG} = 5.0\text{ V}$		0.01	0.1	μA
$t_{PG,DLY}$	Power good deglitch delay	PG rising edge		100		μs
		PG falling edge		20		
<b>OUTPUT</b>						
$V_{OUT}$	Output voltage accuracy	TPS6282533, PWM mode	3.267	3.3	3.333	V
$V_{OUT}$	Output voltage accuracy	TPS6282x18, PWM mode	1.78	1.8	1.82	V
$V_{FB}$	Feedback regulation voltage	PWM mode	594	600	606	mV
$I_{FB,LKG}$	Feedback input leakage current for adjustable output voltage	$V_{FB} = 0.6\text{ V}$		0.01	0.05	μA
$R_{FB}$	Internal resistor divider connected to FB pin, for fixed output voltage	TPS6282518, TPS6282618, TPS6282533		7.5		MΩ
$I_{DIS}$	Output discharge current	$V_{SW} = 0.4\text{ V}$ ; EN = LOW	75	400		mA
	Load regulation	$I_{OUT} = 0.5\text{ A}$ to $3\text{ A}$ , $V_{OUT} = 1.8\text{ V}$		0.1		%/A
<b>POWER SWITCH</b>						
$R_{DS(on)}$	High-side FET on-resistance			26		mΩ
	Low-side FET on-resistance			25		mΩ

## 6.5 Electrical Characteristics (continued)

$T_J = -40\text{ }^\circ\text{C}$  to  $125\text{ }^\circ\text{C}$ , and  $V_{IN} = 2.4\text{ V}$  to  $5.5\text{ V}$ . Typical values are at  $T_J = 25\text{ }^\circ\text{C}$  and  $V_{IN} = 5\text{ V}$ , unless otherwise noted.

PARAMETER		TEST CONDITIONS	MIN	TYP	MAX	UNIT
$I_{LIM}$	High-side FET switch current limit, DC	TPS62824A	1.7	2.1	2.4	A
		TPS62825x	2.74	3.3	3.9	A
		TPS62826x	3.7	4.3	5.0	A
		TPS62827x	4.8	5.6	6.4	A
$I_{LIM}$	Low-side FET negative current limit, DC	TPS62824A/5A/6A/7A	-1.6		A	
$f_{SW}$	PWM switching frequency	$I_{OUT} = 1\text{ A}$ , $V_{OUT} = 1.8\text{ V}$	2.2		MHz	



### 6.6 Typical Characteristics

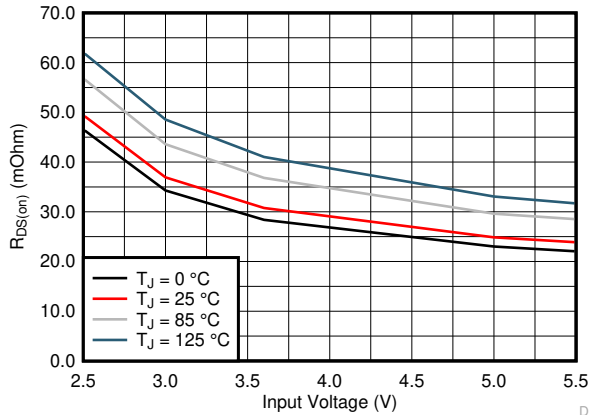

Figure 6-1. High-Side FET On-Resistance

D010

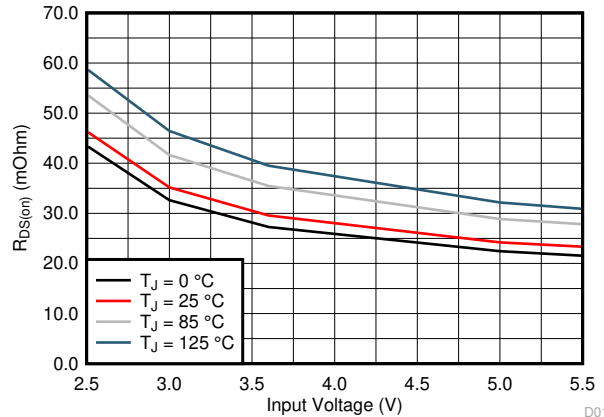

Figure 6-2. Low-Side FET On-Resistance

D011

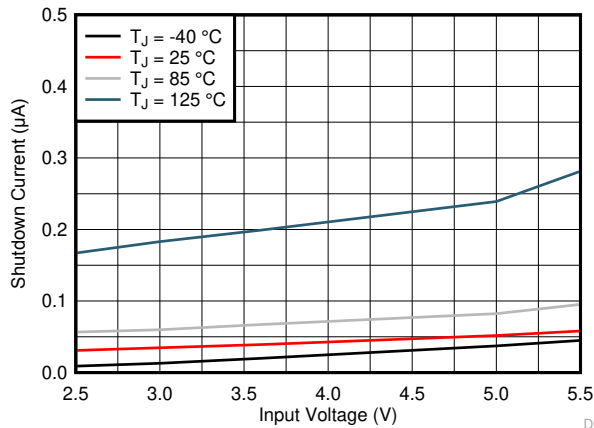

Figure 6-3. Shutdown Current

D000

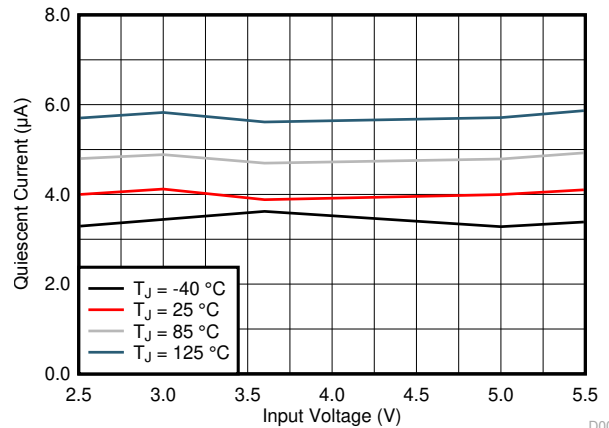

Figure 6-4. Quiescent Current

D001

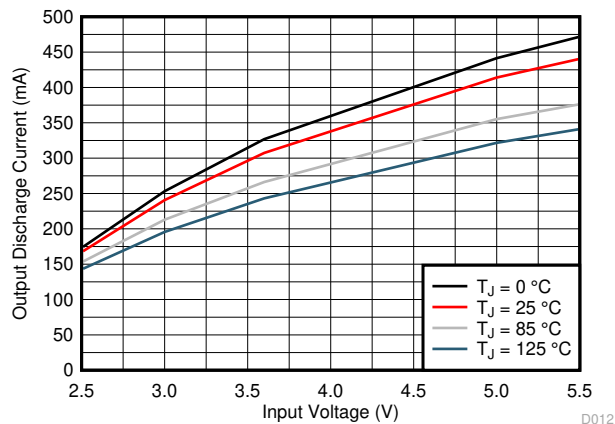

Figure 6-5. Output Discharge Current

D012

## 7 Detailed Description

### 7.1 Overview

The TPS6282x are synchronous step-down converters based on the DCS-Control topology with an adaptive constant on-time control and a stabilized switching frequency. The devices operate in PWM (pulse width modulation) mode for medium to heavy loads and in PSM (power save mode) at light load conditions, keeping the output voltage ripple small. The nominal switching frequency is about 2.2MHz with a small and controlled variation over the input voltage range. As the load current decreases, the converter enters PSM, reducing the switching frequency to keep efficiency high over the entire load current range. Because combining both PWM and PSM within a single building block, the transition between modes is seamless and without effect on the output voltage. In forced-PWM devices, the converter maintains a continuous conduction mode operation and keeps the output voltage ripple very low across the whole load range and at a nominal switching frequency of 2.2MHz. The devices offer both excellent dc voltage and fast load transient regulation, combined with a very low output voltage ripple.

### 7.2 Functional Block Diagram

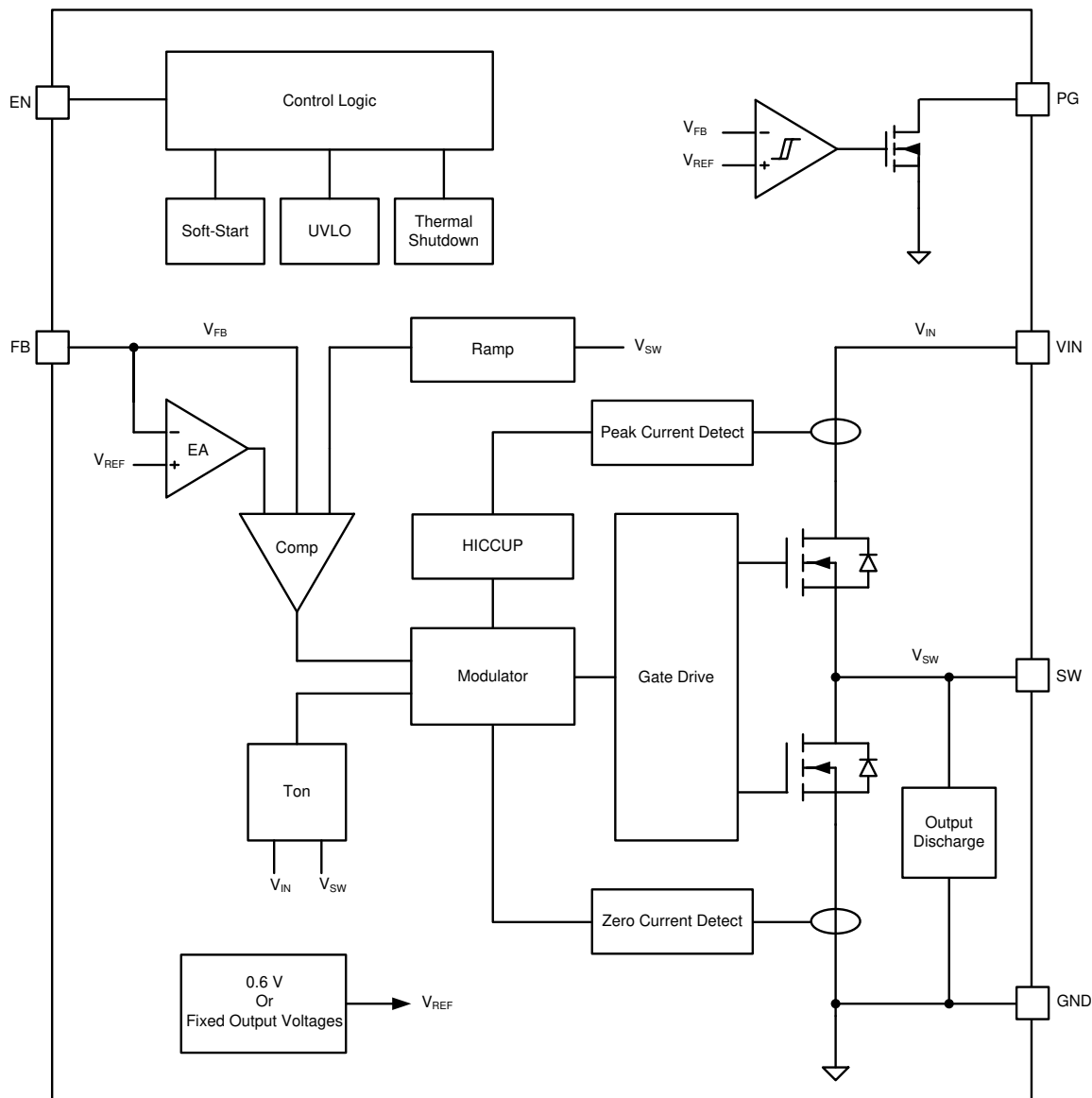



## 7.3 Feature Description

### 7.3.1 Pulse Width Modulation (PWM) Operation

At load currents larger than half the inductor ripple current, the device operates in pulse width modulation in continuous conduction mode (CCM). The PWM operation is based on an adaptive constant on-time control with stabilized switching frequency. To achieve a stable switching frequency in a steady state condition, the on-time is calculated as:

$$T_{ON} = \frac{V_{OUT}}{V_{IN}} \times 450ns \quad (1)$$

In forced-PWM devices, the device always operates in pulse width modulation in continuous conduction mode (CCM).

### 7.3.2 Power Save Mode (PSM) Operation

To maintain high efficiency at light loads, the device enters power save mode (PSM) at the boundary to discontinuous conduction mode (DCM). This event happens when the output current becomes smaller than half of the ripple current of the inductor. The device operates now with a fixed on-time and the switching frequency further decreases proportional to the load current. Use the following equation to calculate:

$$f_{PSM} = \frac{2 \times I_{OUT}}{T_{ON}^2 \times \frac{V_{IN}}{V_{OUT}} \left[ \frac{V_{IN} - V_{OUT}}{L} \right]} \quad (2)$$

In PSM, the output voltage rises slightly above the nominal target, which can be minimized using larger output capacitance. At duty cycles larger than 90%, the device can not enter PSM. The device maintains output regulation in PWM mode.

### 7.3.3 Minimum Duty Cycle and 100% Mode Operation

There is no limitation for small duty cycles, because even at very low duty cycles, the switching frequency is reduced as needed to always make sure of a proper regulation.

If the output voltage level comes close to the input voltage, the device enters 100% mode. While the high-side switch is constantly turned on, the low-side switch is switched off. The difference between VIN and VOUT is determined by the voltage drop across the high-side FET and the DC resistance of the inductor. The minimum VIN that is needed to maintain a specific VOUT value is estimated as:

$$V_{IN,min} = V_{OUT} + I_{OUT,MAX} \times (R_{DS(on)} + R_L) \quad (3)$$

where

- $V_{IN,MIN}$  = Minimum input voltage to maintain an output voltage
- $I_{OUT,MAX}$  = Maximum output current
- $R_{DS(on)}$  = High-side FET ON-resistance
- $R_L$  = Inductor ohmic resistance (DCR)

### 7.3.4 Soft Start

About 250µs after EN goes High, the internal soft-start circuitry controls the output voltage during start-up. This action avoids excessive inrush current and makes sure of a controlled output voltage ramp. This action also prevents unwanted voltage drops from high-impedance power sources or batteries. The TPS6282x can start into a prebiased output.

### 7.3.5 Switch Current Limit and HICCUP Short-Circuit Protection

The switch current limit prevents the device from drawing excessive current in case of externally-caused overcurrent or short-circuit condition. Due to an internal propagation delay (typically 60ns), the actual AC peak current can exceed the static current limit during that time.

If the current limit threshold is reached, the device delivers maximum output current. Detecting this condition for 32 switching cycles (about 13µs), the device turns off the high-side MOSFET for about 100µs which allows the inductor current to decrease through the low-side MOSFET body diode and then restarts again with a soft start cycle. As long as the overload condition is present, the device hiccups that way, limiting the output power.

In forced PWM devices, a negative current limit ( $I_{LIMN}$ ) is enabled to prevent excessive current flowing backwards to the input. When the inductor current reaches  $I_{LIMN}$ , the low-side MOSFET turns off and the high-side MOSFET turns on and kept on until  $T_{ON}$  time expires.

### 7.3.6 Undervoltage Lockout

The undervoltage lockout (UVLO) function prevents misoperation of the device if the input voltage drops below the UVLO threshold. The undervoltage lockout is set to about 2.2V with a hysteresis of typically 160mV.

### 7.3.7 Thermal Shutdown

The junction temperature ( $T_J$ ) of the device is monitored by an internal temperature sensor. If  $T_J$  exceeds 150°C (typ.), the device goes in thermal shutdown with a hysteresis of typically 20°C. After  $T_J$  has decreased enough, the device resumes normal operation.

## 7.4 Device Functional Modes

### 7.4.1 Enable, Disable, and Output Discharge

The device starts operation when Enable (EN) is set High. The input threshold levels are typically 0.9V for rising and 0.7V for falling signals. Do not leave EN floating. Shutdown is forced if EN is pulled Low with a shutdown current of typically 50nA. During shutdown, the internal power MOSFETs as well as the entire control circuitry are turned off and the output voltage is actively discharged through the SW pin by a current sink. Therefore  $V_{IN}$  must remain present for the discharge to function.

### 7.4.2 Power Good

The TPS6282x has a built-in power-good (PG) function. The PG pin goes high impedance when the output voltage has reached the nominal value. Otherwise, including when disabled, in UVLO or in thermal shutdown, PG is Low (see [Table 7-1](#)). The PG function is formed with a window comparator, which has an upper and lower voltage threshold. The PG pin is an open-drain output and is specified to sink up to 1mA. The power-good output requires a pullup resistor connecting to any voltage rail less than 5.5V.

The PG signal can be used for sequencing of multiple rails by connecting it to the EN pin of other converters. Leave the PG pin unconnected when not used. The PG rising edge has a 100µs blanking time and the PG falling edge has a deglitch delay of 20µs.

**Table 7-1. PG Pin Logic**

DEVICE CONDITIONS		LOGIC STATUS	
		HIGH Z	LOW
Enable	EN = High, $V_{FB} \geq 0.576V$	√	
	EN = High, $V_{FB} \leq 0.552V$		√
	EN = High, $V_{FB} \leq 0.63V$	√	
	EN = High, $V_{FB} \geq 0.66V$		√
Shutdown	EN = Low		√
Thermal Shutdown	$T_J > T_{JSD}$		√
UVLO	$0.7V < V_{IN} < V_{UVLO}$		√
Power Supply Removal	$V_{IN} < 0.7V$	√	



## 8 Application and Implementation

### Note

Information in the following applications sections is not part of the TI component specification, and TI does not warrant its accuracy or completeness. TI's customers are responsible for determining suitability of components for their purposes, as well as validating and testing their design implementation to confirm system functionality.

### 8.1 Application Information

The following section discusses the design of the external components to complete the power supply design for several input and output voltage options by using typical applications as a reference.

### 8.2 Typical Application

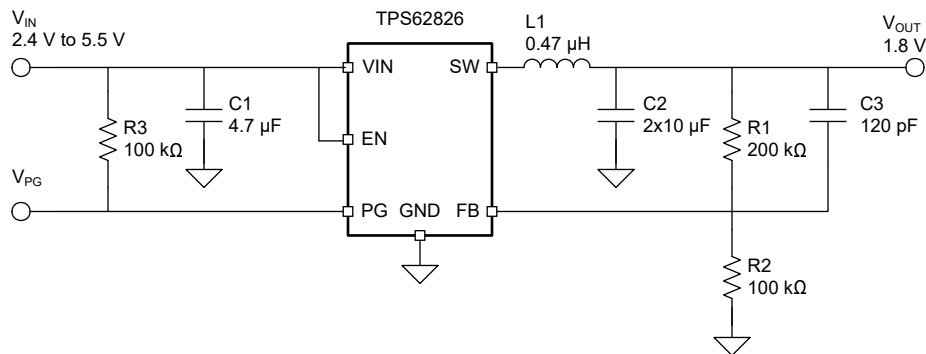

Figure 8-1. Typical Application of TPS62826x

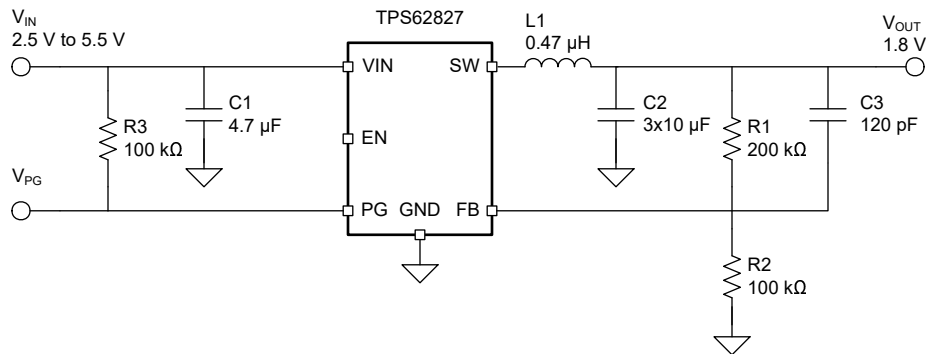

Figure 8-2. Typical Application of TPS62827

#### 8.2.1 Design Requirements

For this design example, use the parameters listed in [Table 8-1](#) as the input parameters.

Table 8-1. Design Parameters

DESIGN PARAMETER	EXAMPLE VALUE
Input voltage, TPS62826x	2.4V to 5.5V
Input voltage, TPS62827x	2.5V to 5.5V
Output voltage	1.8V
Output ripple voltage	< 20mV
Maximum output current, TPS62826x	3A
Maximum output current, TPS62827x	4A

Table 8-2 lists the components used for the example.

**Table 8-2. List of Components**

REFERENCE	DESCRIPTION	MANUFACTURER
C1	4.7μF, Ceramic capacitor, 6.3V, X7R, size 0603, JMK107BB7475MA	Taiyo Yuden
C2, TPS62824x/5x/6x/7A	2 × 10μF, Ceramic capacitor, 10V, X7R, size 0603, GRM188Z71A106MA73D	Murata
C2, TPS62827	3 × 10μF, Ceramic capacitor, 10V, X7R, size 0603, GRM188Z71A106MA73D	Murata
C3	120pF, Ceramic capacitor, 50V, size 0402	Std
L1	0.47μH, Power Inductor, XFL4015-471MEB	Coilcraft
R1	Depending on the output voltage, 1%, size 0402	Std
R2	100kΩ, Chip resistor, 1/16W, 1%, size 0402	Std
R3	100kΩ, Chip resistor, 1/16W, 1%, size 0402	Std

## 8.2.2 Detailed Design Procedure

### 8.2.2.1 Custom Design With WEBENCH® Tools

[Click here](#) to create a custom design using the TPS6282x device with the WEBENCH® Power Designer.

1. Start by entering the input voltage ( $V_{IN}$ ), output voltage ( $V_{OUT}$ ), and output current ( $I_{OUT}$ ) requirements.
2. Optimize the design for key parameters such as efficiency, footprint, and cost using the optimizer dial.
3. Compare the generated design with other possible solutions from Texas Instruments.

The WEBENCH Power Designer provides a customized schematic along with a list of materials with real-time pricing and component availability.

In most cases, these actions are available:

- Run electrical simulations to see important waveforms and circuit performance
- Run thermal simulations to understand board thermal performance
- Export customized schematic and layout into popular CAD formats
- Print PDF reports for the design, and share the design with colleagues

Get more information about WEBENCH tools at [www.ti.com/WEBENCH](http://www.ti.com/WEBENCH).

### 8.2.2.2 Setting The Output Voltage

The output voltage is set by an external resistor divider according to [Equation 4](#):

$$R1 = R2 \times \left( \frac{V_{OUT}}{V_{FB}} - 1 \right) = R2 \times \left( \frac{V_{OUT}}{0.6V} - 1 \right) \quad (4)$$

R2 must not be higher than 100kΩ to achieve high efficiency at light load while providing acceptable noise sensitivity. [Equation 5](#) shows how to compute the value of the feedforward capacitor for a given R2 value. For the recommended 100k value for R2, a 120pF feedforward capacitor is used.

$$C3 = \frac{12\mu}{R2} \quad (5)$$

For the fixed output voltage versions, connect the FB pin to the output. R1, R2, and C3 are not needed. The fixed output voltage devices have an internal feedforward capacitor.

### 8.2.2.3 Output Filter Design

The inductor and the output capacitor together provide a low-pass filter. To simplify this process, [Table 8-3](#) outlines possible inductor and capacitor value combinations for most applications. Checked cells represent combinations that are proven for stability by simulation and lab test. check further combinations for each individual application.

**Table 8-3. Matrix of Output Capacitor and Inductor Combinations, TPS62824x, TPS62825x, TPS62826x, and TPS62827A**

NOMINAL L [ $\mu$ H] <sup>(2)</sup>	NOMINAL C <sub>OUT</sub> [ $\mu$ F] <sup>(3)</sup>			
	10	2 × 10 or 22	47	100
0.33				
0.47	+	+(1)	+	
1.0				

- (1) This LC combination is the standard value and recommended for most applications.  
(2) Inductor tolerance and current derating is anticipated. The effective inductance can vary by 20% and –30%.  
(3) Capacitance tolerance and bias voltage derating is anticipated. The effective capacitance can vary by 20% and –35%.

**Table 8-4. Matrix of Output Capacitor and Inductor Combinations, TPS62827**

NOMINAL L [ $\mu$ H] <sup>(2)</sup>	NOMINAL C <sub>OUT</sub> [ $\mu$ F] <sup>(3)</sup>			
	22	3 × 10	47	100
0.33				
0.47		+(1)	+	+
1.0				

### 8.2.2.4 Inductor Selection

The main parameter for the inductor selection is the inductor value and then the saturation current of the inductor. To calculate the maximum inductor current under static load conditions, Equation 6 is given.

$$I_{L,MAX} = I_{OUT,MAX} + \frac{\Delta I_L}{2} \quad (6)$$

$$\Delta I_L = V_{OUT} \times \frac{1 - \frac{V_{OUT}}{V_{IN}}}{L \times f_{SW}}$$

where

- I<sub>OUT,MAX</sub> = Maximum output current
- $\Delta I_L$  = Inductor current ripple
- f<sub>SW</sub> = Switching frequency
- L = Inductor value

TI recommends to choose a saturation current for the inductor that is approximately 20% to 30% higher than I<sub>L,MAX</sub>. In addition, DC resistance and size must also be taken into account when selecting an appropriate inductor. Table 8-5 lists recommended inductors.

**Table 8-5. List of Recommended Inductors**

INDUCTANCE [ $\mu$ H]	CURRENT RATING [A]	DIMENSIONS [L × W × H mm]	MAX. DC RESISTANCE [m $\Omega$ ]	MFR PART NUMBER <sup>(1)</sup>
0.47	4.8	2.0 × 1.6 × 1.0	32	HTEN20161T-R47MDR, Cyntec
	4.6	2.0 × 1.2 × 1.0	25	HTEH20121T-R47MSR, Cyntec
	4.8	2.0 × 1.6 × 1.0	32	DFE201610E - R47M, MuRata
	4.8	2.0 × 1.6 × 1.0	32	DFE201210S - R47M, MuRata
	5.1	2.0 × 1.6 × 1.0	34	TFM201610ALM-R47MTAA, TDK
	5.2	2.0 × 1.6 × 1.0	25	TFM201610ALC-R47MTAA, TDK
	6.6	4.0 × 4.0 × 1.6	8.36	XFL4015-471ME, Coilcraft
	8.0	3.5 × 3.2 × 2.0	10.85	XEL3520-471ME, Coilcraft
	6.8	4.5 × 4 × 1.8	11.2	WE-LHMI-744373240047, Würth

- (1) See the [Third-party Products Disclaimer](#).

### 8.2.2.5 Capacitor Selection

The input capacitor is the low-impedance energy source for the converters which helps provide stable operation. TI recommends a low-ESR multilayer ceramic capacitor for best filtering and must be placed between VIN and GND as close as possible to those pins. For most applications, a minimum effective input capacitance of 3 $\mu$ F must be present, though a larger value reduces input current ripple.

The architecture of the device allows the use of tiny ceramic output capacitors with low equivalent series resistance (ESR). These capacitors provide low output voltage ripple and are recommended. To keep the low resistance up to high frequencies and to get narrow capacitance variation with temperature, TI recommends using X7R or X5R dielectrics. Considering the DC-bias derating the capacitance, the minimum effective output capacitance is 10 $\mu$ F for TPS62824x, TPS62825x, TPS62826x. and TPS62827A and 20 $\mu$ F for TPS62827.

A feed forward capacitor is required for the adjustable version, as described in [Setting the Output Voltage](#). This capacitor is not required for the fixed output voltage versions.



### 8.2.3 Application Curves

$V_{IN} = 5.0V$ ,  $V_{OUT} = 1.8V$ ,  $T_A = 25^\circ C$ , BOM = [Table 8-2](#), unless otherwise noted.

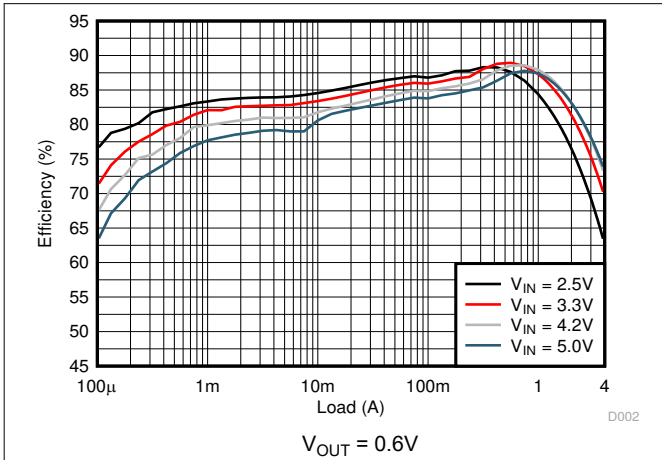

Figure 8-3. Efficiency

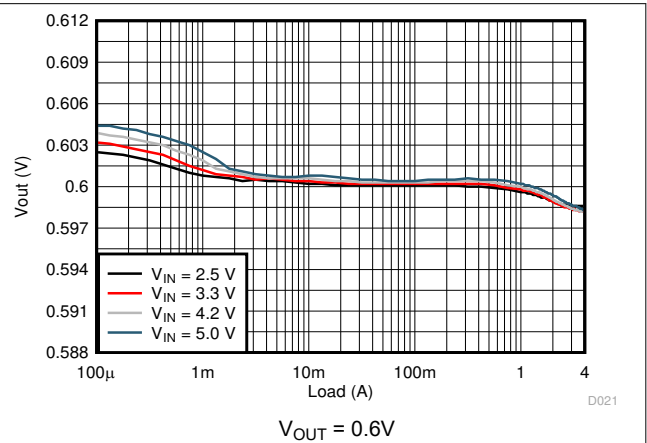

Figure 8-4. Load Regulation

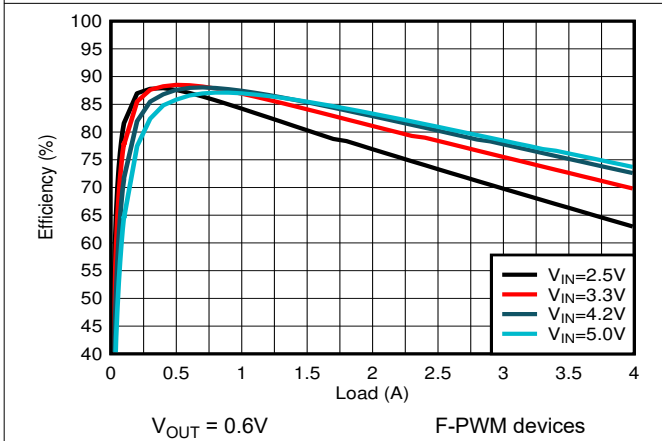

Figure 8-5. PWM Efficiency

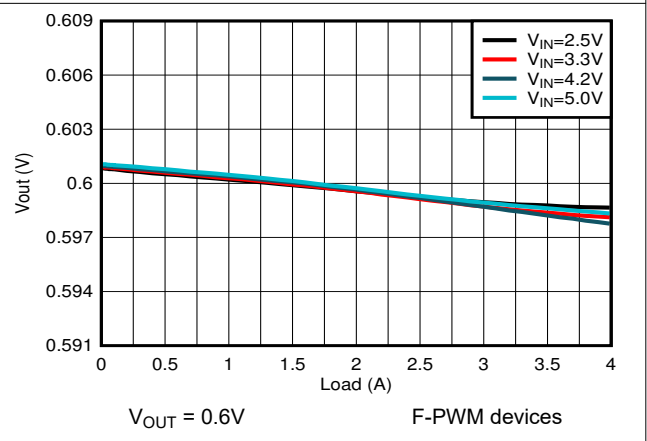

Figure 8-6. Load Regulation

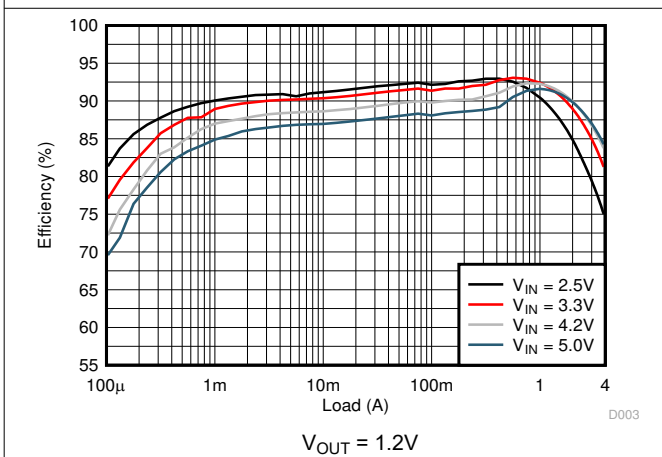

Figure 8-7. Efficiency

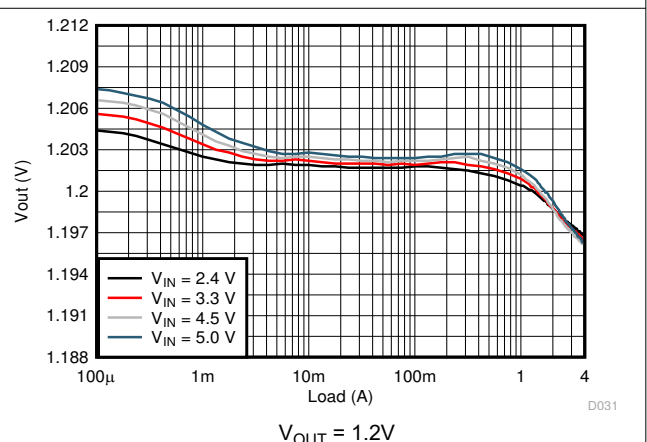
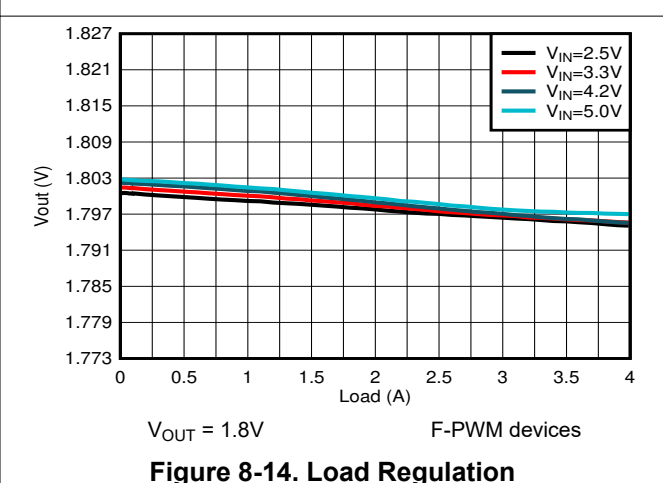
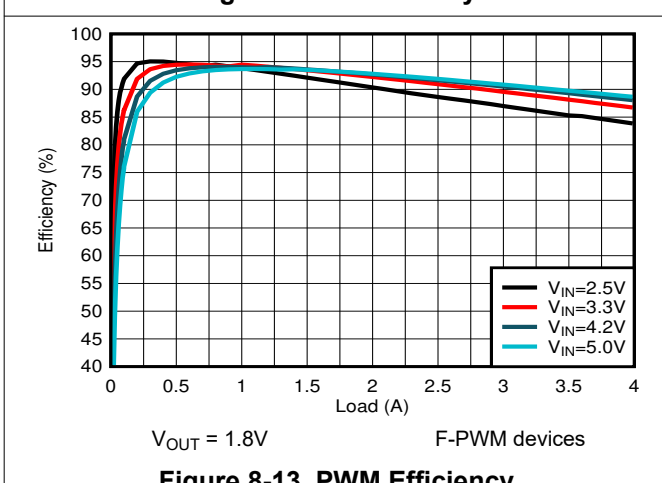
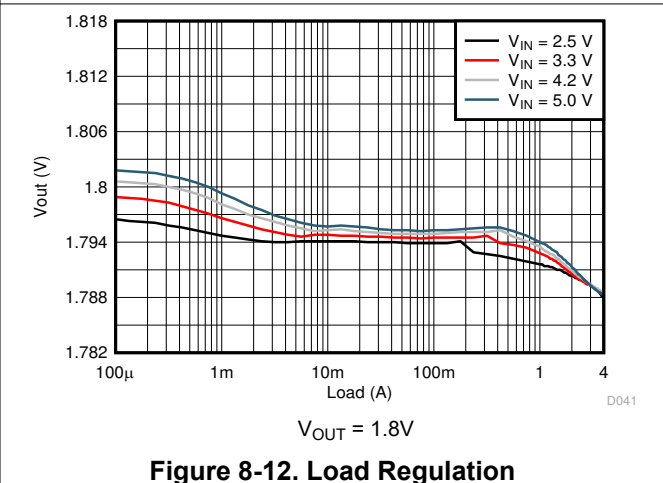
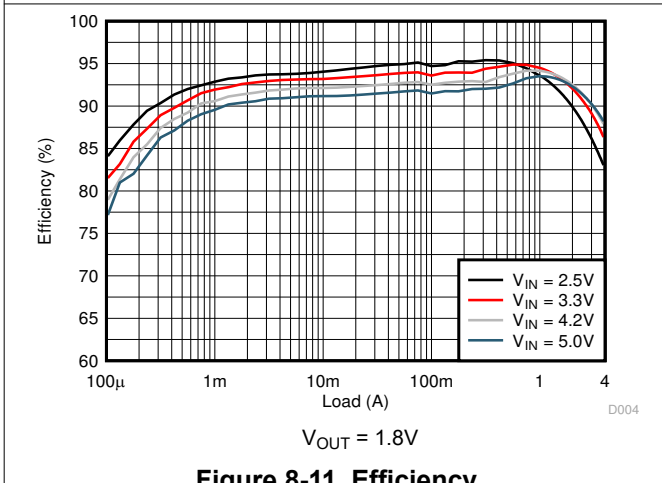
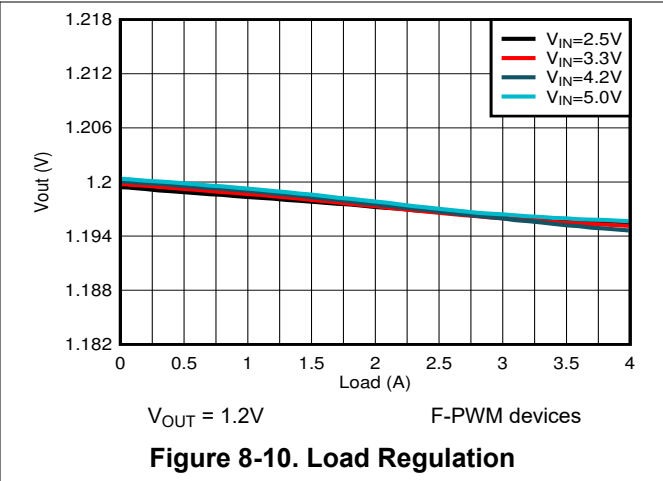
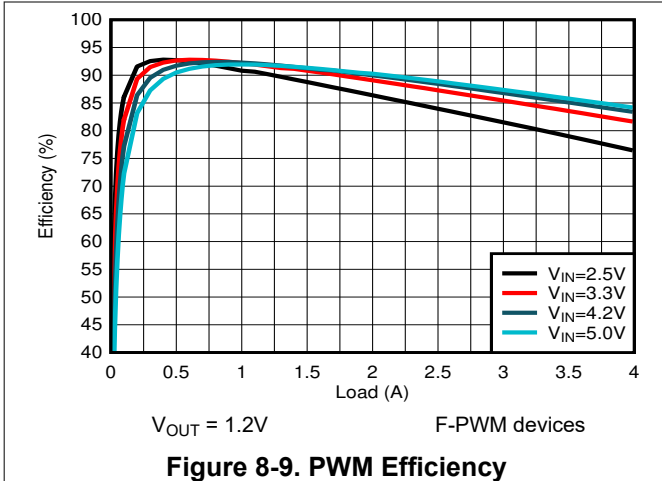

Figure 8-8. Load Regulation





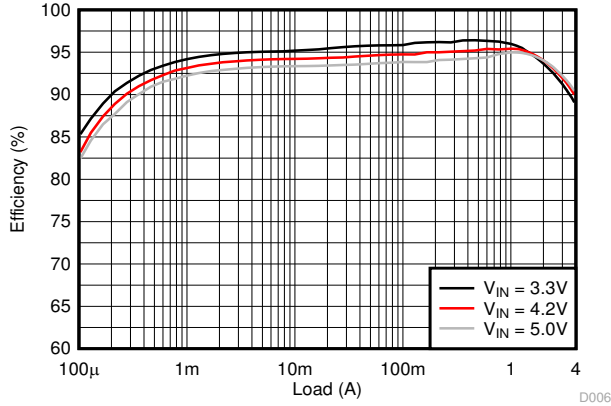

Figure 8-15. Efficiency

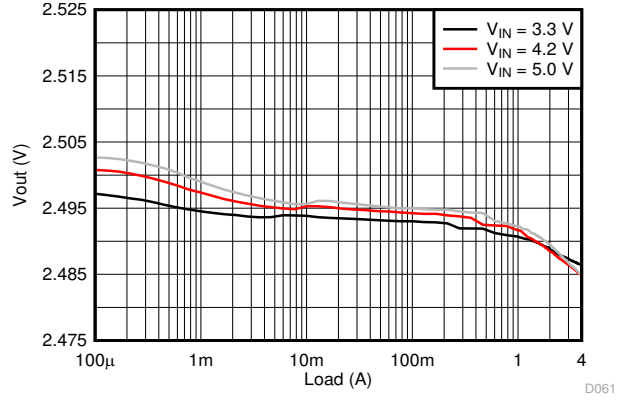
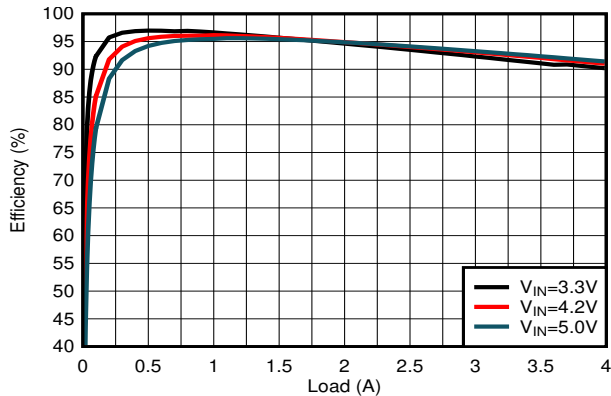
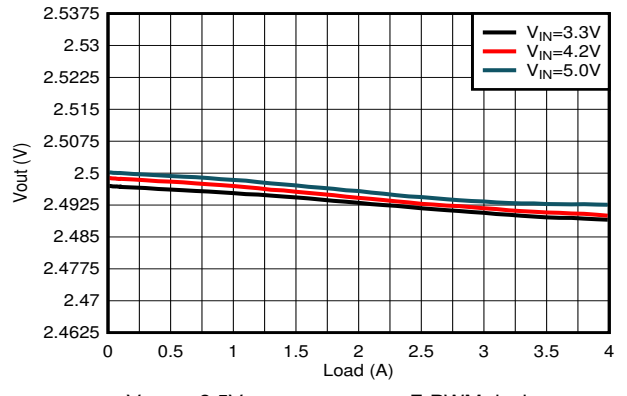

Figure 8-16. Load Regulation



V<sub>OUT</sub> = 2.5V F-PWM devices

Figure 8-17. PWM Efficiency



V<sub>OUT</sub> = 2.5V F-PWM devices

Figure 8-18. Load Regulation

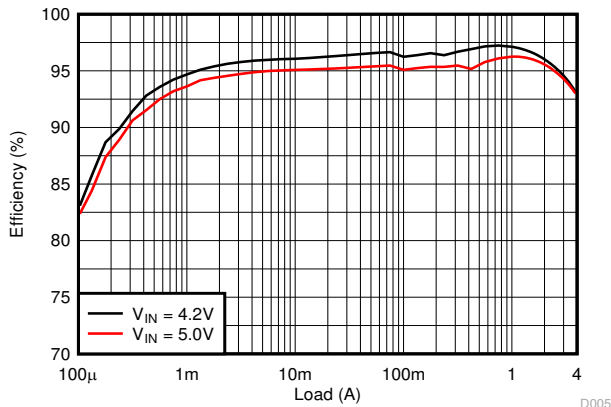

V<sub>OUT</sub> = 3.3V

Figure 8-19. Efficiency

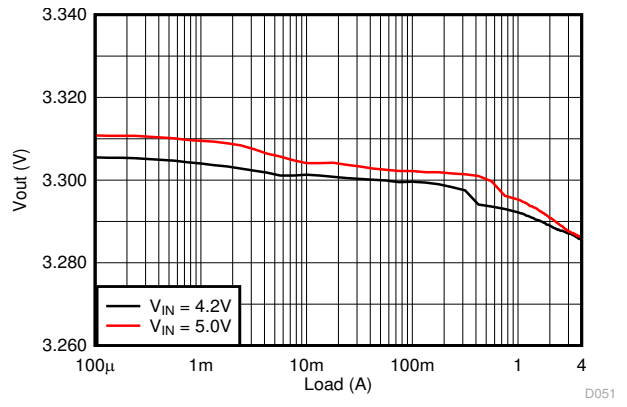

V<sub>OUT</sub> = 3.3V

Figure 8-20. Load Regulation

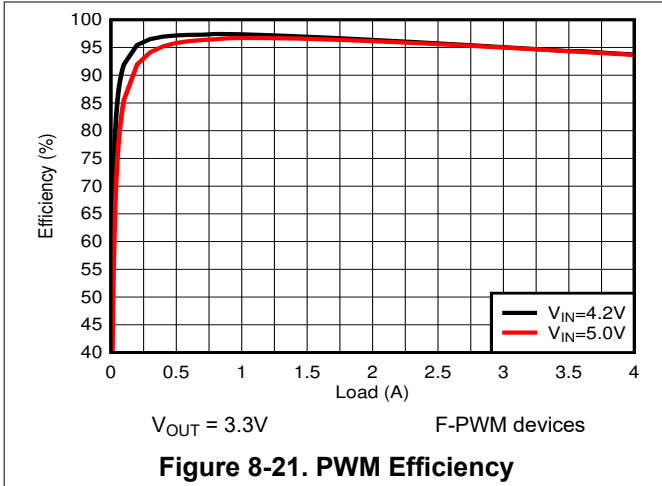

**Figure 8-21. PWM Efficiency**

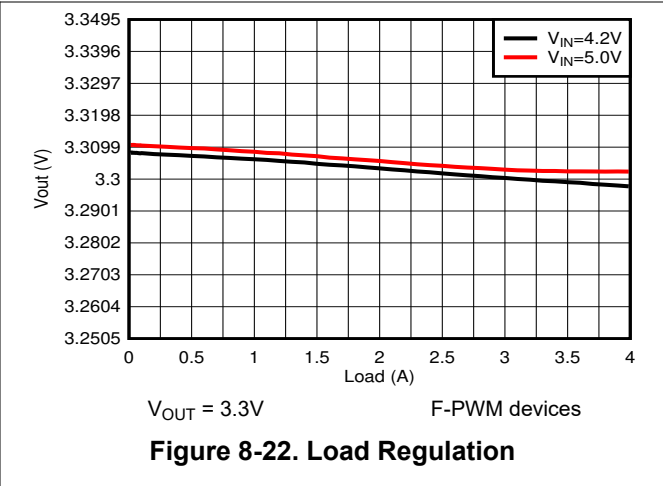

**Figure 8-22. Load Regulation**

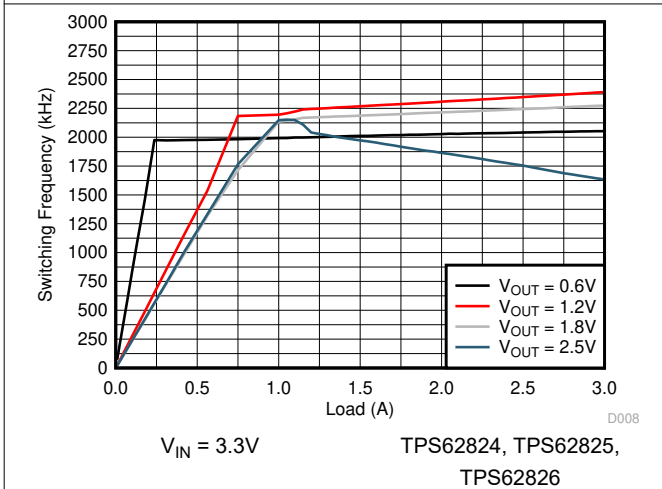

**Figure 8-23. Switching Frequency**

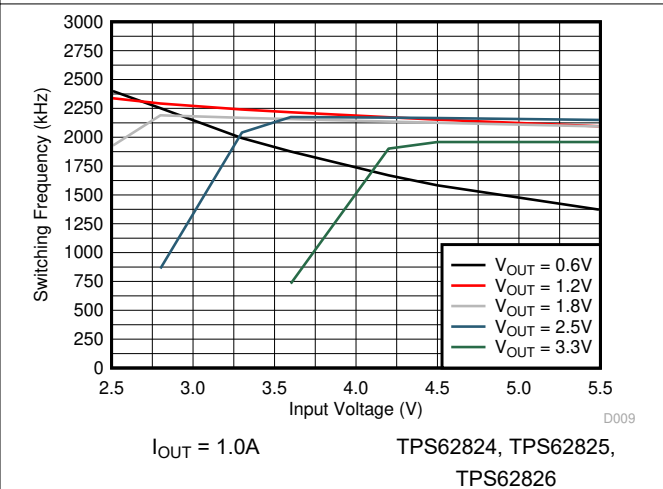

**Figure 8-24. Switching Frequency**

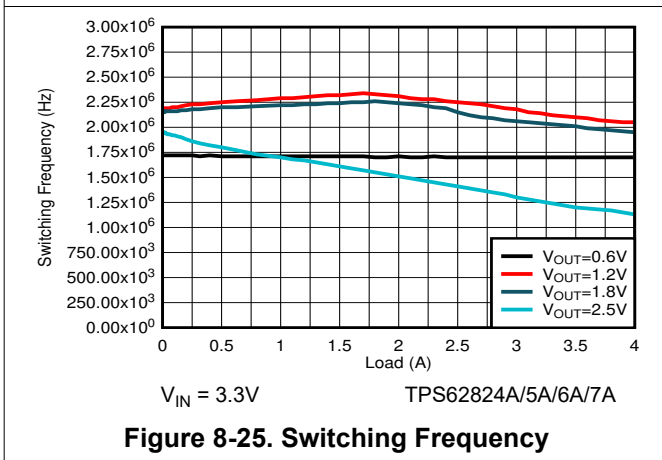

**Figure 8-25. Switching Frequency**

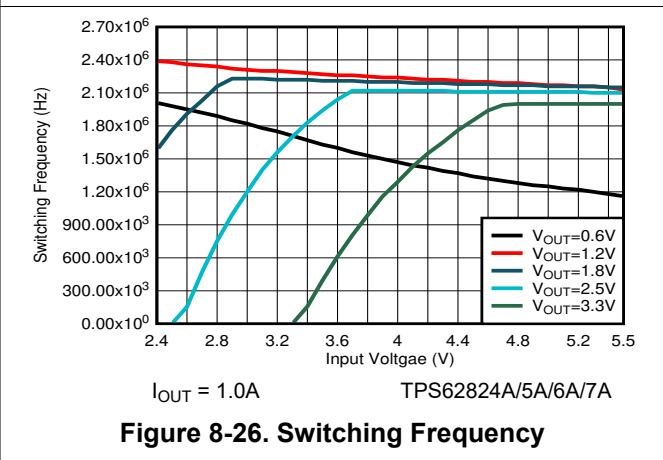

**Figure 8-26. Switching Frequency**

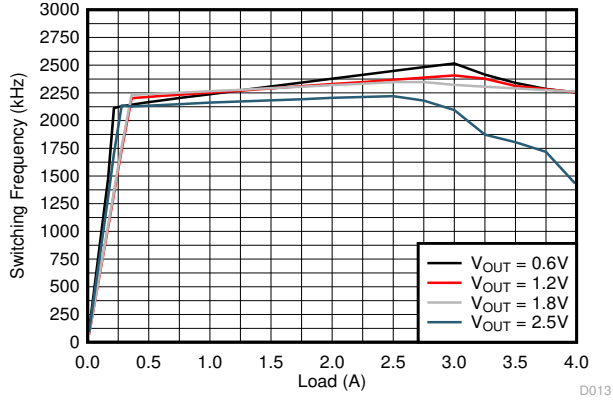

Figure 8-27. Switching Frequency

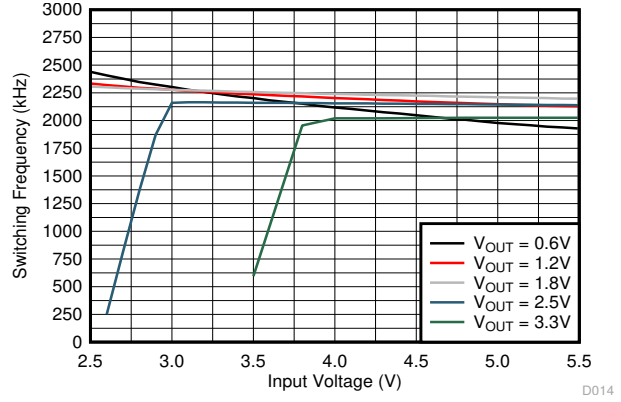

Figure 8-28. Switching Frequency

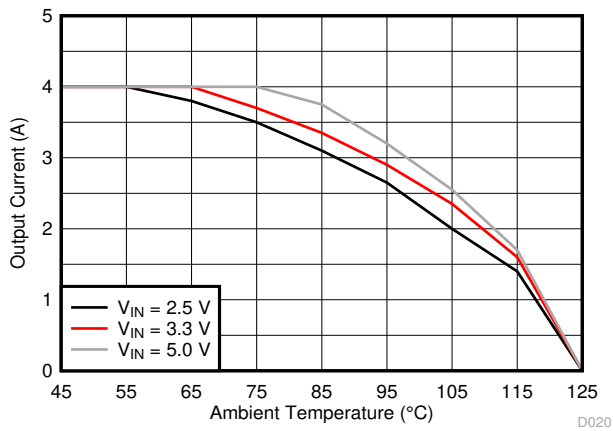

Figure 8-29. Thermal Derating

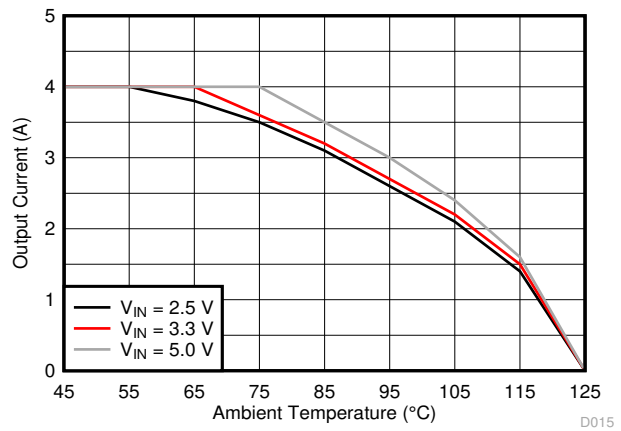

Figure 8-30. Thermal Derating

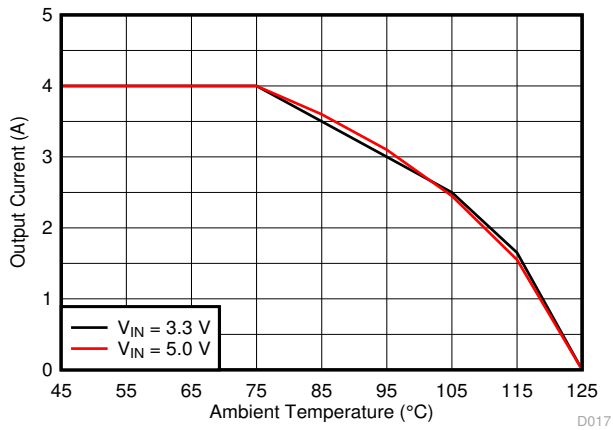

Figure 8-31. Thermal Derating

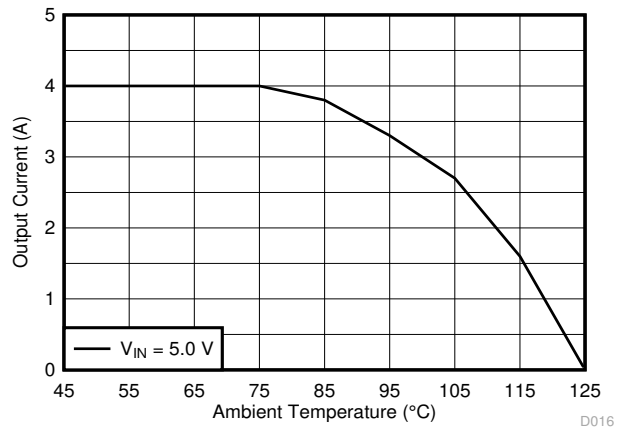
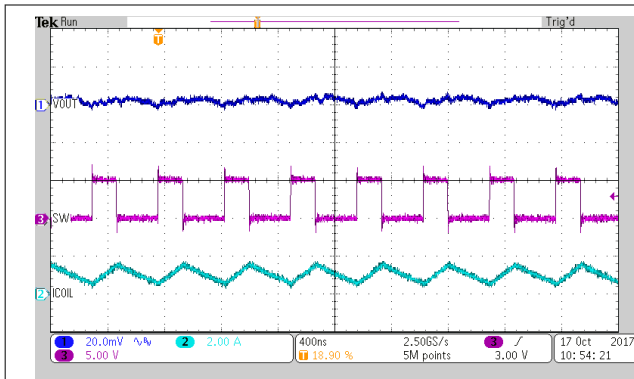
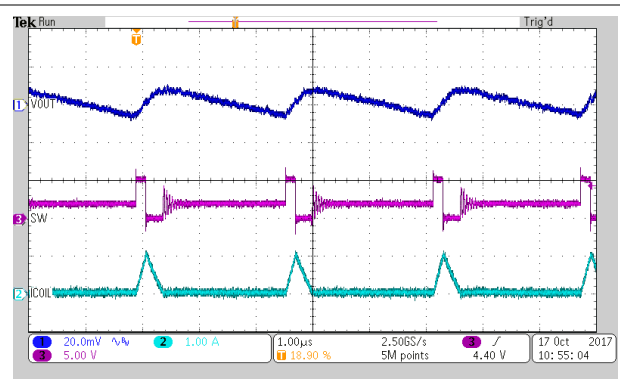

Figure 8-32. Thermal Derating



$I_{OUT} = 1.0A$  TPS62824/5/6/7  
**Figure 8-33. PWM Operation**



$I_{OUT} = 0.1A$  TPS62824/5/6/7  
**Figure 8-34. PSM Operation**

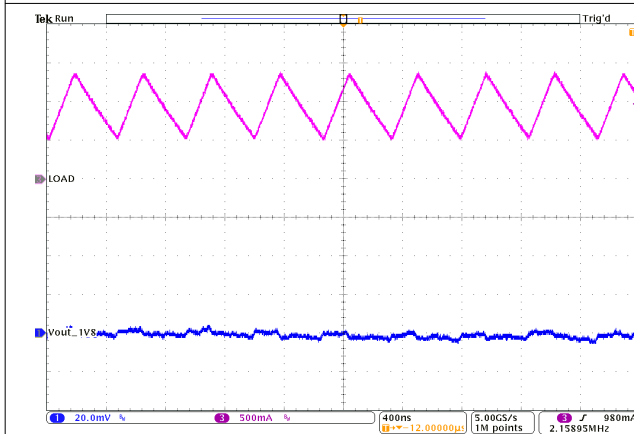

$I_{OUT} = 1.0A$  TPS62824A/5A/6A/7A  
**Figure 8-35. PWM Operation at F-PWM**

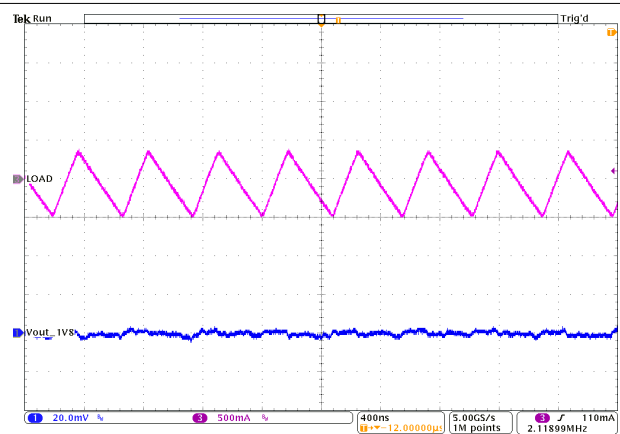

No load TPS62824A/5A/6A/7A  
**Figure 8-36. PWM Operation at F-PWM**

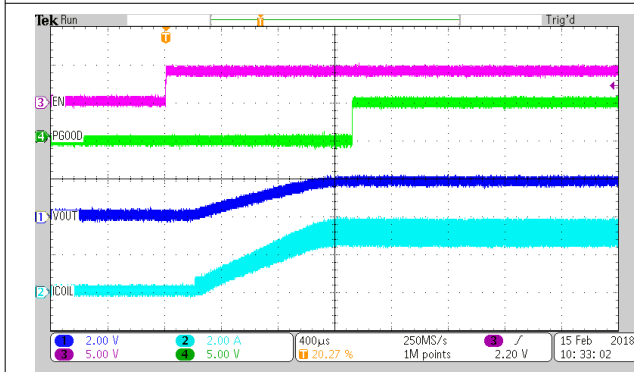

Load = 0.6Ω TPS62826  
**Figure 8-37. Start-Up With Load**

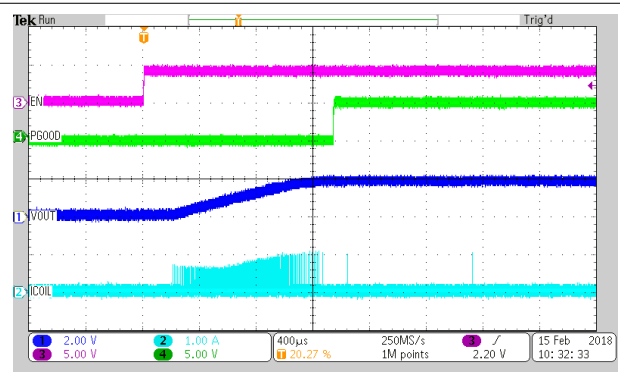

TPS62824/5/6  
**Figure 8-38. Start-Up With No Load**

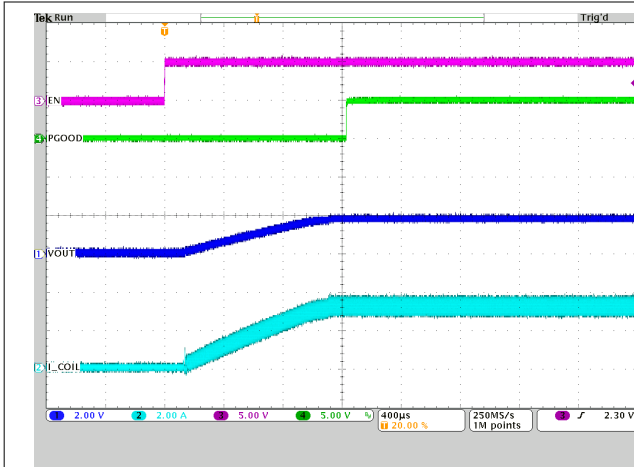

Load = 0.6Ω TPS62826A/7A

Figure 8-39. Start-Up With Load

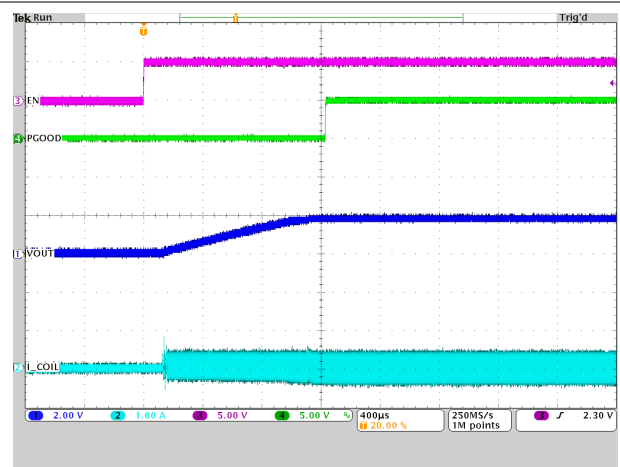

TPS62824A/5A/6A/7A

Figure 8-40. Start-Up With No Load

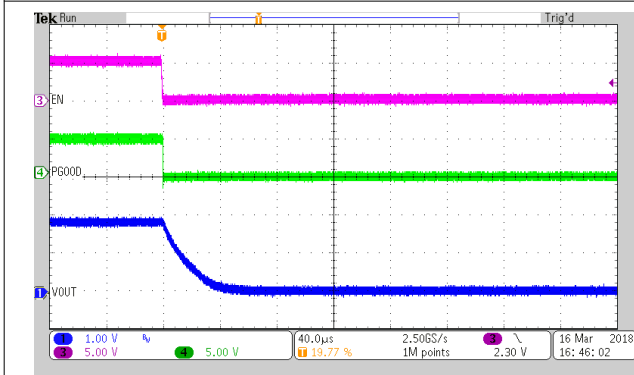

Load = 1.8Ω TPS6282x

Figure 8-41. Disable, Active Output Discharge

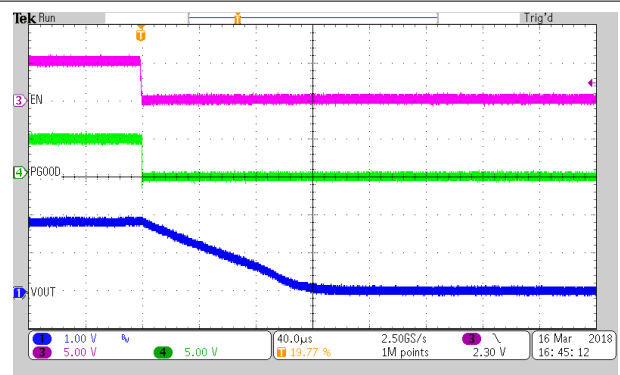

TPS6282x

Figure 8-42. Disable, Active Output Discharge at No Load

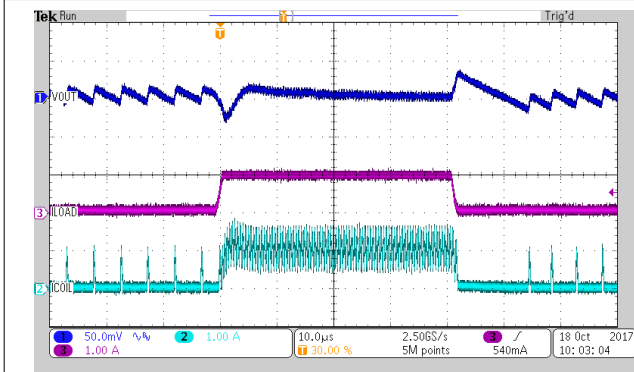

I<sub>OUT</sub> = 0.05A to 1A TPS62824/5/6/7

Figure 8-43. Load Transient

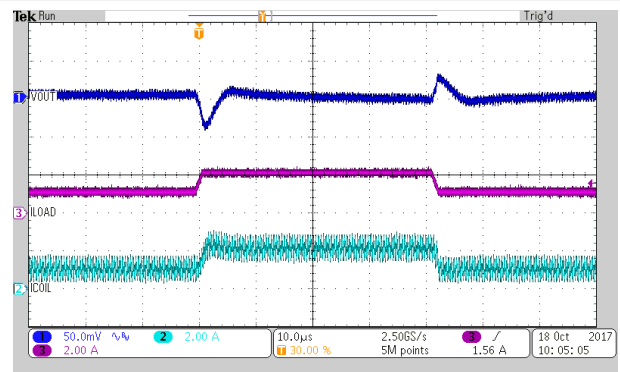

I<sub>OUT</sub> = 1A to 2A

TPS62825/6/7

Figure 8-44. Load Transient

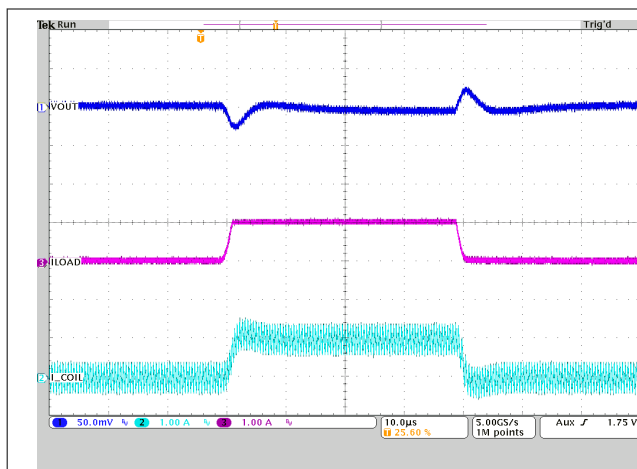
 $I_{OUT} = 0.05A \text{ to } 1A$       TPS62824A/5A/6A/7A

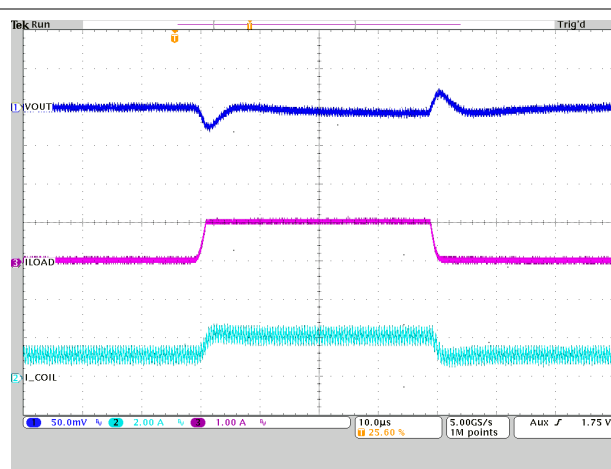
**Figure 8-45. Load Transient**

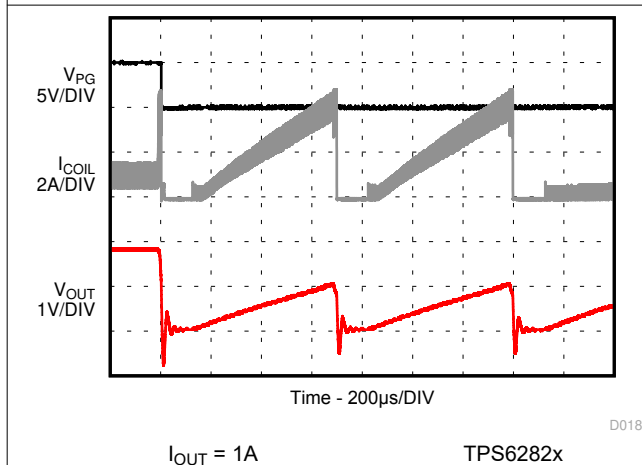
 $I_{OUT} = 1A \text{ to } 2A$       TPS62825A/6A/7A

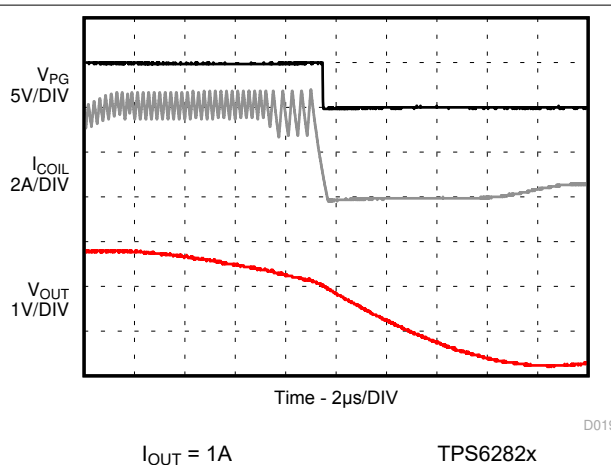
**Figure 8-46. Load Transient**

 $I_{OUT} = 1A$       TPS6282x

**Figure 8-47. HICCUP Short-Circuit Protection**

 $I_{OUT} = 1A$       TPS6282x

**Figure 8-48. HICCUP Short-Circuit Protection (Zoom In)**

## 8.3 Power Supply Recommendations

The device is designed to operate from an input voltage supply range from 2.4V to 5.5V. Make sure that the input power supply has a sufficient current rating for the application.

## 8.4 Layout

### 8.4.1 Layout Guidelines

The printed-circuit-board (PCB) layout is an important step to maintain the high performance of the device. See [Layout Example](#) for the recommended PCB layout.

- Place the input, output capacitors and the inductor as close as possible to the IC. This placement keeps the power traces short. Routing these power traces direct and wide results in low trace resistance and low parasitic inductance.
- Connect the low side of the input and output capacitors properly to the GND pin to avoid a ground potential shift.
- Note that the sense traces connected to FB is a signal trace. Take special care to avoid noise being induced. Keep these traces away from SW nodes. The connection of the output voltage trace for the FB resistors must be made at the output capacitor.
- Refer to [Layout Example](#) for an example of component placement, routing, and thermal design.

## 8.4.2 Layout Example

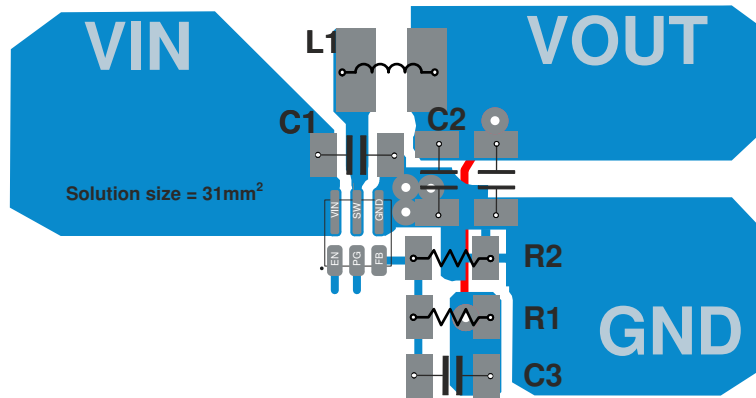

**Figure 8-49. PCB Layout Recommendation**

### 8.4.2.1 Thermal Considerations

Implementation of integrated circuits in low-profile and fine-pitch surface-mount packages typically requires special attention to power dissipation. Many system-dependent issues such as thermal coupling, airflow, added heat sinks and convection surfaces, and the presence of other heat-generating components affect the power dissipation limits of a given component.

Two basic approaches for enhancing thermal performance are:

- Improving the power dissipation capability of the PCB design
- Introducing airflow in the system

The Thermal Data section in [Thermal Information](#) provides the thermal metric of the device on the EVM after considering the PCB design of real applications. The big copper planes connecting to the pads of the IC on the PCB improve the thermal performance of the device. For more details on how to use the thermal parameters, see [Thermal Characteristics of Linear and Logic Packages Using JEDEC PCB Designs](#) application note and [Semiconductor and IC Package Thermal Metrics](#) application note.

## 9 Device and Documentation Support

### 9.1 Device Support

#### 9.1.1 Third-Party Products Disclaimer

TI'S PUBLICATION OF INFORMATION REGARDING THIRD-PARTY PRODUCTS OR SERVICES DOES NOT CONSTITUTE AN ENDORSEMENT REGARDING THE SUITABILITY OF SUCH PRODUCTS OR SERVICES OR A WARRANTY, REPRESENTATION OR ENDORSEMENT OF SUCH PRODUCTS OR SERVICES, EITHER ALONE OR IN COMBINATION WITH ANY TI PRODUCT OR SERVICE.

#### 9.1.2 Development Support

##### 9.1.2.1 Custom Design With WEBENCH® Tools

[Click here](#) to create a custom design using the TPS6282x device with the WEBENCH® Power Designer.

1. Start by entering the input voltage ( $V_{IN}$ ), output voltage ( $V_{OUT}$ ), and output current ( $I_{OUT}$ ) requirements.
2. Optimize the design for key parameters such as efficiency, footprint, and cost using the optimizer dial.
3. Compare the generated design with other possible solutions from Texas Instruments.

The WEBENCH Power Designer provides a customized schematic along with a list of materials with real-time pricing and component availability.

In most cases, these actions are available:

- Run electrical simulations to see important waveforms and circuit performance
- Run thermal simulations to understand board thermal performance
- Export customized schematic and layout into popular CAD formats
- Print PDF reports for the design, and share the design with colleagues

Get more information about WEBENCH tools at [www.ti.com/WEBENCH](http://www.ti.com/WEBENCH).

### 9.2 Documentation Support

#### 9.2.1 Related Documentation

For related documentation, see the following:

- Texas Instruments, [Thermal Characteristics of Linear and Logic Packages Using JEDEC PCB Designs](#) application note
- Texas Instruments, [Semiconductor and IC Package Thermal Metrics](#) application note

### 9.3 Support Resources

[TI E2E™ support forums](#) are an engineer's go-to source for fast, verified answers and design help — straight from the experts. Search existing answers or ask your own question to get the quick design help you need.

Linked content is provided "AS IS" by the respective contributors. They do not constitute TI specifications and do not necessarily reflect TI's views; see TI's [Terms of Use](#).

### 9.4 Trademarks

TI E2E™ is a trademark of Texas Instruments.

WEBENCH® is a registered trademark of Texas Instruments.

All trademarks are the property of their respective owners.

### 9.5 Electrostatic Discharge Caution



This integrated circuit can be damaged by ESD. Texas Instruments recommends that all integrated circuits be handled with appropriate precautions. Failure to observe proper handling and installation procedures can cause damage.

ESD damage can range from subtle performance degradation to complete device failure. Precision integrated circuits may be more susceptible to damage because very small parametric changes could cause the device not to meet its published specifications.

### 9.6 Glossary

[TI Glossary](#) This glossary lists and explains terms, acronyms, and definitions.





## 10 Revision History

<b>Changes from Revision H (August 2023) to Revision I (March 2024)</b>	<b>Page</b>
• Added foot note to include turnoff behavior.....	4
• Updated incorrect Power good upper threshold (swapped rising/falling).....	5
• Updated description of start-up figures to show correct device versions .....	15

---

<b>Changes from Revision G (March 2022) to Revision H (August 2023)</b>	<b>Page</b>
• Added TPSM82823 to the modules proposals.....	1
• Changed equation formatting.....	1
• Deleted four-way connections from images throughout the document.....	1
• Removed trademark from DCS-Control.....	1
• Updated the first page table.....	1
• Added an SW pin voltage specification at PFM mode in the <i>Absolute Maximum Ratings</i> table .....	4
• Added the <i>Absolute Maximum Ratings</i> standard table note .....	4

---

<b>Changes from Revision F (September 2021) to Revision G (March 2022)</b>	<b>Page</b>
• Removed "in 1.5-mm × 1.5-mm QFN package" from data sheet title.....	1

---

<b>Changes from Revision E (December 2020) to Revision F (September 2021)</b>	<b>Page</b>
• Changed the status of the TPS62824DMQ to Production Data.....	3
• Added the TPS6282533.....	3

---

## 11 Mechanical, Packaging, and Orderable Information

The following pages include mechanical, packaging, and orderable information. This information is the most current data available for the designated devices. This data is subject to change without notice and revision of this document. For browser-based versions of this data sheet, refer to the left-hand navigation.

**PACKAGING INFORMATION**

Orderable part number	Status (1)	Material type (2)	Package   Pins	Package qty   Carrier	RoHS (3)	Lead finish/ Ball material (4)	MSL rating/ Peak reflow (5)	Op temp (°C)	Part marking (6)
<a href="#">TPS62824ADMQR</a>	Active	Production	VSON-HR (DMQ)   6	3000   LARGE T&R	Yes	Call TI   Sn	Level-1-260C-UNLIM	-40 to 125	JM
TPS62824ADMQR.A	Active	Production	VSON-HR (DMQ)   6	3000   LARGE T&R	Yes	SN	Level-1-260C-UNLIM	-40 to 125	JM
<a href="#">TPS62824DMQR</a>	Active	Production	VSON-HR (DMQ)   6	3000   LARGE T&R	Yes	Call TI   Sn	Level-1-260C-UNLIM	-40 to 125	JL
TPS62824DMQR.A	Active	Production	VSON-HR (DMQ)   6	3000   LARGE T&R	Yes	SN	Level-1-260C-UNLIM	-40 to 125	JL
TPS62824DMQR.B	Active	Production	VSON-HR (DMQ)   6	3000   LARGE T&R	Yes	SN	Level-1-260C-UNLIM	-40 to 125	JL
<a href="#">TPS6282518DMQR</a>	Active	Production	VSON-HR (DMQ)   6	3000   LARGE T&R	Yes	Call TI   Sn	Level-1-260C-UNLIM	-40 to 125	CJ
TPS6282518DMQR.A	Active	Production	VSON-HR (DMQ)   6	3000   LARGE T&R	Yes	SN	Level-1-260C-UNLIM	-40 to 125	CJ
TPS6282518DMQR.B	Active	Production	VSON-HR (DMQ)   6	3000   LARGE T&R	Yes	SN	Level-1-260C-UNLIM	-40 to 125	CJ
<a href="#">TPS6282518DMQT</a>	Active	Production	VSON-HR (DMQ)   6	250   SMALL T&R	Yes	Call TI   Sn	Level-1-260C-UNLIM	-40 to 125	CJ
TPS6282518DMQT.A	Active	Production	VSON-HR (DMQ)   6	250   SMALL T&R	Yes	SN	Level-1-260C-UNLIM	-40 to 125	CJ
TPS6282518DMQT.B	Active	Production	VSON-HR (DMQ)   6	250   SMALL T&R	Yes	SN	Level-1-260C-UNLIM	-40 to 125	CJ
<a href="#">TPS6282533DMQR</a>	Active	Production	VSON-HR (DMQ)   6	3000   LARGE T&R	Yes	Call TI   Sn	Level-1-260C-UNLIM	-40 to 125	L1
TPS6282533DMQR.A	Active	Production	VSON-HR (DMQ)   6	3000   LARGE T&R	Yes	SN	Level-1-260C-UNLIM	-40 to 125	L1
TPS6282533DMQR.B	Active	Production	VSON-HR (DMQ)   6	3000   LARGE T&R	Yes	SN	Level-1-260C-UNLIM	-40 to 125	L1
<a href="#">TPS62825ADMQR</a>	Active	Production	VSON-HR (DMQ)   6	3000   LARGE T&R	Yes	Call TI   Sn	Level-1-260C-UNLIM	-40 to 125	JN
TPS62825ADMQR.A	Active	Production	VSON-HR (DMQ)   6	3000   LARGE T&R	Yes	SN	Level-1-260C-UNLIM	-40 to 125	JN
<a href="#">TPS62825DMQR</a>	Active	Production	VSON-HR (DMQ)   6	3000   LARGE T&R	Yes	Call TI   Sn	Level-1-260C-UNLIM	-40 to 125	CI
TPS62825DMQR.A	Active	Production	VSON-HR (DMQ)   6	3000   LARGE T&R	Yes	SN	Level-1-260C-UNLIM	-40 to 125	CI
TPS62825DMQR.B	Active	Production	VSON-HR (DMQ)   6	3000   LARGE T&R	Yes	SN	Level-1-260C-UNLIM	-40 to 125	CI
<a href="#">TPS62825DMQT</a>	Active	Production	VSON-HR (DMQ)   6	250   SMALL T&R	Yes	Call TI   Sn	Level-1-260C-UNLIM	-40 to 125	CI
TPS62825DMQT.A	Active	Production	VSON-HR (DMQ)   6	250   SMALL T&R	Yes	SN	Level-1-260C-UNLIM	-40 to 125	CI
TPS62825DMQT.B	Active	Production	VSON-HR (DMQ)   6	250   SMALL T&R	Yes	SN	Level-1-260C-UNLIM	-40 to 125	CI
<a href="#">TPS6282618DMQR</a>	Active	Production	VSON-HR (DMQ)   6	3000   LARGE T&R	Yes	Call TI   Sn	Level-1-260C-UNLIM	-40 to 125	CK
TPS6282618DMQR.A	Active	Production	VSON-HR (DMQ)   6	3000   LARGE T&R	Yes	SN	Level-1-260C-UNLIM	-40 to 125	CK
TPS6282618DMQR.B	Active	Production	VSON-HR (DMQ)   6	3000   LARGE T&R	Yes	SN	Level-1-260C-UNLIM	-40 to 125	CK
<a href="#">TPS6282618DMQT</a>	Active	Production	VSON-HR (DMQ)   6	250   SMALL T&R	Yes	Call TI   Sn	Level-1-260C-UNLIM	-40 to 125	CK
TPS6282618DMQT.A	Active	Production	VSON-HR (DMQ)   6	250   SMALL T&R	Yes	Call TI	Level-1-260C-UNLIM	-40 to 125	CK
TPS6282618DMQT.B	Active	Production	VSON-HR (DMQ)   6	250   SMALL T&R	Yes	Call TI	Level-1-260C-UNLIM	-40 to 125	CK
<a href="#">TPS62826ADMQR</a>	Active	Production	VSON-HR (DMQ)   6	3000   LARGE T&R	Yes	Call TI   Sn	Level-1-260C-UNLIM	-40 to 125	JO

Orderable part number	Status (1)	Material type (2)	Package   Pins	Package qty   Carrier	RoHS (3)	Lead finish/ Ball material (4)	MSL rating/ Peak reflow (5)	Op temp (°C)	Part marking (6)
TPS62826ADMQR.A	Active	Production	VSON-HR (DMQ)   6	3000   LARGE T&R	Yes	SN	Level-1-260C-UNLIM	-40 to 125	JO
<a href="#">TPS62826DMQR</a>	Active	Production	VSON-HR (DMQ)   6	3000   LARGE T&R	Yes	Call TI   Sn	Level-1-260C-UNLIM	-40 to 125	CL
TPS62826DMQR.A	Active	Production	VSON-HR (DMQ)   6	3000   LARGE T&R	Yes	SN	Level-1-260C-UNLIM	-40 to 125	CL
TPS62826DMQR.B	Active	Production	VSON-HR (DMQ)   6	3000   LARGE T&R	Yes	SN	Level-1-260C-UNLIM	-40 to 125	CL
<a href="#">TPS62826DMQT</a>	Active	Production	VSON-HR (DMQ)   6	250   SMALL T&R	Yes	Call TI   Sn	Level-1-260C-UNLIM	-40 to 125	CL
TPS62826DMQT.A	Active	Production	VSON-HR (DMQ)   6	250   SMALL T&R	Yes	SN	Level-1-260C-UNLIM	-40 to 125	CL
TPS62826DMQT.B	Active	Production	VSON-HR (DMQ)   6	250   SMALL T&R	Yes	SN	Level-1-260C-UNLIM	-40 to 125	CL
<a href="#">TPS62827ADMQR</a>	Active	Production	VSON-HR (DMQ)   6	3000   LARGE T&R	Yes	Call TI   Sn	Level-1-260C-UNLIM	-40 to 125	JP
TPS62827ADMQR.A	Active	Production	VSON-HR (DMQ)   6	3000   LARGE T&R	Yes	SN	Level-1-260C-UNLIM	-40 to 125	JP
<a href="#">TPS62827DMQR</a>	Active	Production	VSON-HR (DMQ)   6	3000   LARGE T&R	Yes	Call TI   Sn	Level-1-260C-UNLIM	-40 to 125	EH
TPS62827DMQR.A	Active	Production	VSON-HR (DMQ)   6	3000   LARGE T&R	Yes	SN	Level-1-260C-UNLIM	-40 to 125	EH
<a href="#">TPS62827DMQT</a>	Active	Production	VSON-HR (DMQ)   6	250   SMALL T&R	Yes	Call TI   Sn	Level-1-260C-UNLIM	-40 to 125	EH
TPS62827DMQT.A	Active	Production	VSON-HR (DMQ)   6	250   SMALL T&R	Yes	SN	Level-1-260C-UNLIM	-40 to 125	EH

<sup>(1)</sup> **Status:** For more details on status, see our [product life cycle](#).

<sup>(2)</sup> **Material type:** When designated, preproduction parts are prototypes/experimental devices, and are not yet approved or released for full production. Testing and final process, including without limitation quality assurance, reliability performance testing, and/or process qualification, may not yet be complete, and this item is subject to further changes or possible discontinuation. If available for ordering, purchases will be subject to an additional waiver at checkout, and are intended for early internal evaluation purposes only. These items are sold without warranties of any kind.

<sup>(3)</sup> **RoHS values:** Yes, No, RoHS Exempt. See the [TI RoHS Statement](#) for additional information and value definition.

<sup>(4)</sup> **Lead finish/Ball material:** Parts may have multiple material finish options. Finish options are separated by a vertical ruled line. Lead finish/Ball material values may wrap to two lines if the finish value exceeds the maximum column width.

<sup>(5)</sup> **MSL rating/Peak reflow:** The moisture sensitivity level ratings and peak solder (reflow) temperatures. In the event that a part has multiple moisture sensitivity ratings, only the lowest level per JEDEC standards is shown. Refer to the shipping label for the actual reflow temperature that will be used to mount the part to the printed circuit board.

<sup>(6)</sup> **Part marking:** There may be an additional marking, which relates to the logo, the lot trace code information, or the environmental category of the part.

Multiple part markings will be inside parentheses. Only one part marking contained in parentheses and separated by a "-" will appear on a part. If a line is indented then it is a continuation of the previous line and the two combined represent the entire part marking for that device.

**Important Information and Disclaimer:** The information provided on this page represents TI's knowledge and belief as of the date that it is provided. TI bases its knowledge and belief on information provided by third parties, and makes no representation or warranty as to the accuracy of such information. Efforts are underway to better integrate information from third parties. TI has taken and continues to take reasonable steps to provide representative and accurate information but may not have conducted destructive testing or chemical analysis on incoming materials and chemicals. TI and TI suppliers consider certain information to be proprietary, and thus CAS numbers and other limited information may not be available for release.

In no event shall TI's liability arising out of such information exceed the total purchase price of the TI part(s) at issue in this document sold by TI to Customer on an annual basis.

**TAPE AND REEL INFORMATION**

**QUADRANT ASSIGNMENTS FOR PIN 1 ORIENTATION IN TAPE**

\*All dimensions are nominal

Device	Package Type	Package Drawing	Pins	SPQ	Reel Diameter (mm)	Reel Width W1 (mm)	A0 (mm)	B0 (mm)	K0 (mm)	P1 (mm)	W (mm)	Pin1 Quadrant
TPS62824ADMQR	VSON-HR	DMQ	6	3000	180.0	8.4	1.7	1.7	1.14	4.0	8.0	Q2
TPS62824DMQR	VSON-HR	DMQ	6	3000	180.0	8.4	1.7	1.7	1.14	4.0	8.0	Q2
TPS6282518DMQR	VSON-HR	DMQ	6	3000	180.0	8.4	1.7	1.7	1.14	4.0	8.0	Q2
TPS6282518DMQT	VSON-HR	DMQ	6	250	180.0	8.4	1.7	1.7	1.14	4.0	8.0	Q2
TPS6282533DMQR	VSON-HR	DMQ	6	3000	180.0	8.4	1.7	1.7	1.14	4.0	8.0	Q2
TPS62825ADMQR	VSON-HR	DMQ	6	3000	180.0	8.4	1.7	1.7	1.14	4.0	8.0	Q2
TPS62825DMQR	VSON-HR	DMQ	6	3000	180.0	8.4	1.7	1.7	1.14	4.0	8.0	Q2
TPS6282618DMQR	VSON-HR	DMQ	6	3000	180.0	8.4	1.7	1.7	1.14	4.0	8.0	Q2
TPS6282618DMQR	VSON-HR	DMQ	6	3000	180.0	8.4	1.7	1.7	1.14	4.0	8.0	Q2

Device	Package Type	Package Drawing	Pins	SPQ	Reel Diameter (mm)	Reel Width W1 (mm)	A0 (mm)	B0 (mm)	K0 (mm)	P1 (mm)	W (mm)	Pin1 Quadrant
TPS6282618DMQT	VSON-HR	DMQ	6	250	180.0	8.4	1.7	1.7	1.14	4.0	8.0	Q2
TPS62826ADMQR	VSON-HR	DMQ	6	3000	180.0	8.4	1.7	1.7	1.14	4.0	8.0	Q2
TPS62827ADMQR	VSON-HR	DMQ	6	3000	180.0	8.4	1.7	1.7	1.14	4.0	8.0	Q2
TPS62827DMQT	VSON-HR	DMQ	6	250	180.0	8.4	1.7	1.7	1.14	4.0	8.0	Q2

**TAPE AND REEL BOX DIMENSIONS**

\*All dimensions are nominal

Device	Package Type	Package Drawing	Pins	SPQ	Length (mm)	Width (mm)	Height (mm)
TPS62824ADMQR	VSON-HR	DMQ	6	3000	210.0	185.0	35.0
TPS62824DMQR	VSON-HR	DMQ	6	3000	341.0	182.0	80.0
TPS6282518DMQR	VSON-HR	DMQ	6	3000	210.0	185.0	35.0
TPS6282518DMQT	VSON-HR	DMQ	6	250	210.0	185.0	35.0
TPS6282533DMQR	VSON-HR	DMQ	6	3000	182.0	182.0	20.0
TPS62825ADMQR	VSON-HR	DMQ	6	3000	210.0	185.0	35.0
TPS62825DMQR	VSON-HR	DMQ	6	3000	210.0	185.0	35.0
TPS6282618DMQR	VSON-HR	DMQ	6	3000	341.0	182.0	80.0
TPS6282618DMQR	VSON-HR	DMQ	6	3000	210.0	185.0	35.0
TPS6282618DMQT	VSON-HR	DMQ	6	250	341.0	182.0	80.0
TPS62826ADMQR	VSON-HR	DMQ	6	3000	210.0	185.0	35.0
TPS62827ADMQR	VSON-HR	DMQ	6	3000	210.0	185.0	35.0
TPS62827DMQT	VSON-HR	DMQ	6	250	341.0	182.0	80.0

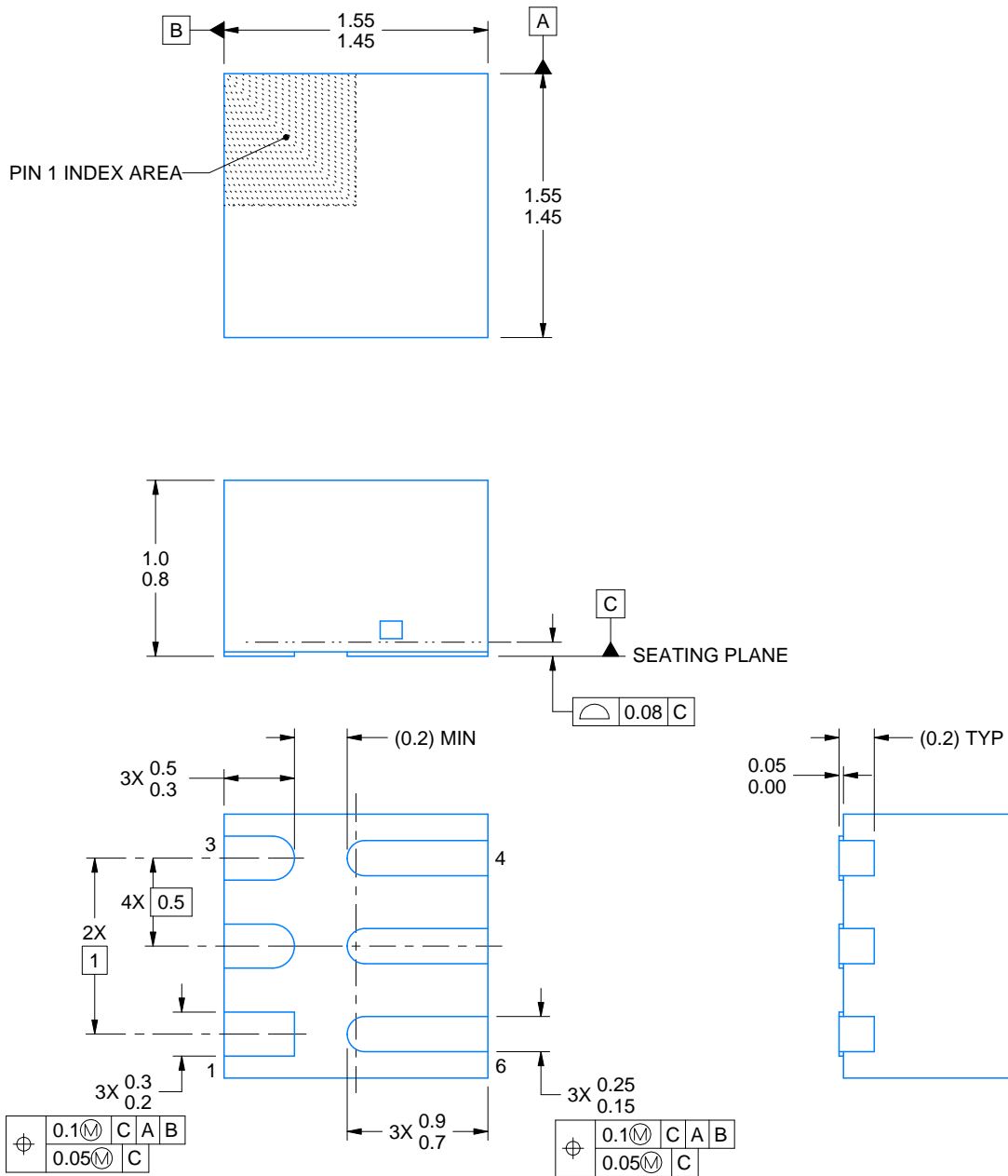
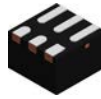

4222645/E 09/2023

NOTES:

1. All linear dimensions are in millimeters. Any dimensions in parenthesis are for reference only. Dimensioning and tolerancing per ASME Y14.5M.
2. This drawing is subject to change without notice.



# EXAMPLE BOARD LAYOUT

DMQ0006A

VSON - 1 mm max height

PLASTIC SMALL OUTLINE - NO LEAD

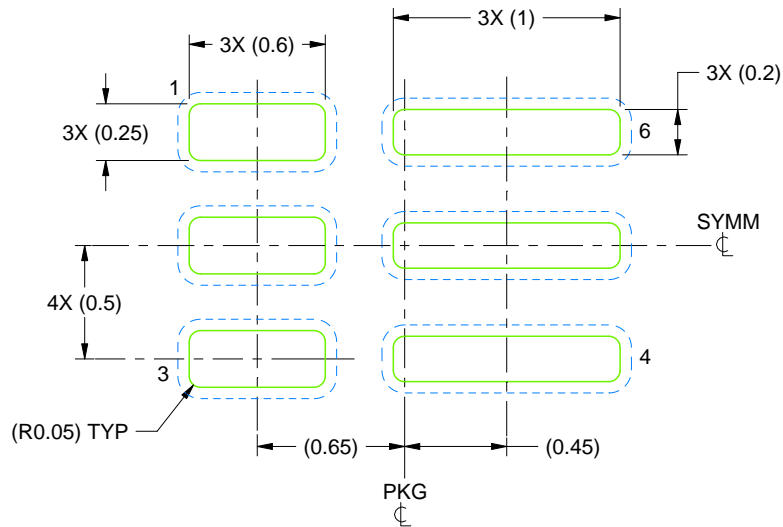

LAND PATTERN EXAMPLE  
SCALE:30X

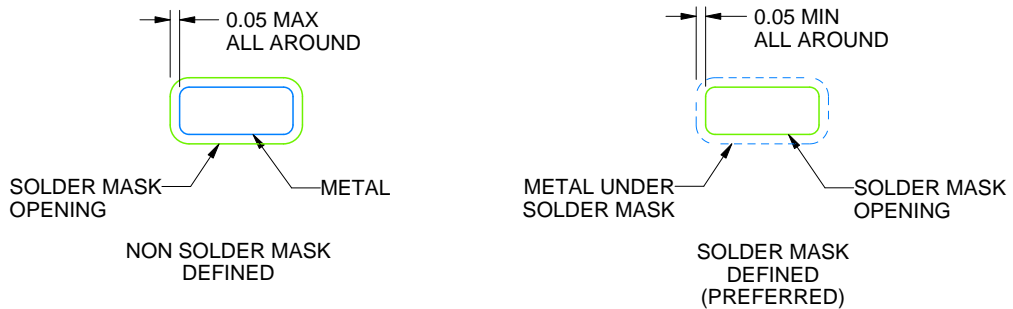

SOLDER MASK DETAILS

4222645/E 09/2023

NOTES: (continued)

3. For more information, see Texas Instruments literature number SLUA271 ([www.ti.com/lit/slua271](http://www.ti.com/lit/slua271)).

# EXAMPLE STENCIL DESIGN

DMQ0006A

VSON - 1 mm max height

PLASTIC SMALL OUTLINE - NO LEAD

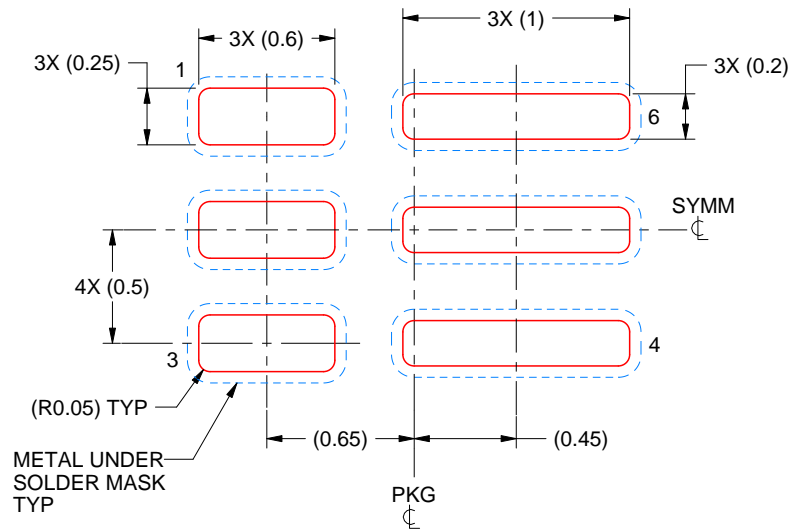

SOLDER PASTE EXAMPLE  
BASED ON 0.125 mm THICK STENCIL  
SCALE:30X

4222645/E 09/2023

NOTES: (continued)

4. Laser cutting apertures with trapezoidal walls and rounded corners may offer better paste release. IPC-7525 may have alternate design recommendations.

## IMPORTANT NOTICE AND DISCLAIMER

TI PROVIDES TECHNICAL AND RELIABILITY DATA (INCLUDING DATASHEETS), DESIGN RESOURCES (INCLUDING REFERENCE DESIGNS), APPLICATION OR OTHER DESIGN ADVICE, WEB TOOLS, SAFETY INFORMATION, AND OTHER RESOURCES "AS IS" AND WITH ALL FAULTS, AND DISCLAIMS ALL WARRANTIES, EXPRESS AND IMPLIED, INCLUDING WITHOUT LIMITATION ANY IMPLIED WARRANTIES OF MERCHANTABILITY, FITNESS FOR A PARTICULAR PURPOSE OR NON-INFRINGEMENT OF THIRD PARTY INTELLECTUAL PROPERTY RIGHTS.

These resources are intended for skilled developers designing with TI products. You are solely responsible for (1) selecting the appropriate TI products for your application, (2) designing, validating and testing your application, and (3) ensuring your application meets applicable standards, and any other safety, security, regulatory or other requirements.

These resources are subject to change without notice. TI grants you permission to use these resources only for development of an application that uses the TI products described in the resource. Other reproduction and display of these resources is prohibited. No license is granted to any other TI intellectual property right or to any third party intellectual property right. TI disclaims responsibility for, and you fully indemnify TI and its representatives against any claims, damages, costs, losses, and liabilities arising out of your use of these resources.

TI's products are provided subject to [TI's Terms of Sale](#), [TI's General Quality Guidelines](#), or other applicable terms available either on [ti.com](http://ti.com) or provided in conjunction with such TI products. TI's provision of these resources does not expand or otherwise alter TI's applicable warranties or warranty disclaimers for TI products. Unless TI explicitly designates a product as custom or customer-specified, TI products are standard, catalog, general purpose devices.

TI objects to and rejects any additional or different terms you may propose.

Copyright © 2026, Texas Instruments Incorporated

Last updated 10/2025