

TPS62A0x, TPS62A0xA, and TPS62A02Nx 1A, 2A, High-Efficiency, Synchronous Buck Converters in a SOT-563 and a SOT-23 Package

1 Features

- 2.5V to 5.5V input voltage range
- 0.6V to V_{IN} adjustable output voltage range
- 180mΩ/120mΩ low $R_{DS(ON)}$ switches (1A DRL)
- 100mΩ/67mΩ low $R_{DS(ON)}$ switches (1A DDC, 2A)
- < 23μA quiescent current
- 1% feedback accuracy (0°C to 125°C)
- 100% mode operation
- 2.4MHz switching frequency
- Power save mode or PWM option available
- Power-good output pin (optional)
- Short-circuit protection (HICCUP)
- Internal soft start-up
- Active output discharge
- Thermal shutdown protection
- Pin-to-pin compatible with the [TLV62585 \(DRL\)](#)
- Pin-to-pin compatible with the [TLV62569 \(DDC\)](#)

2 Applications

- [Set top box, TV applications](#)
- [IP network camera, Multi-function printer](#)
- [Wireless router, solid state drive](#)
- [Battery-powered applications](#)
- General purpose point-of-load supply

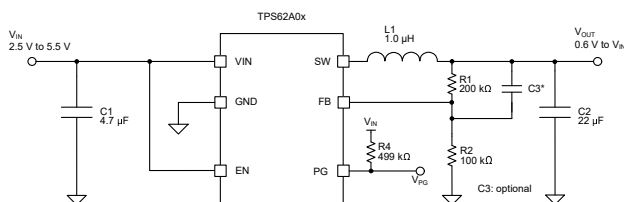

Typical Application

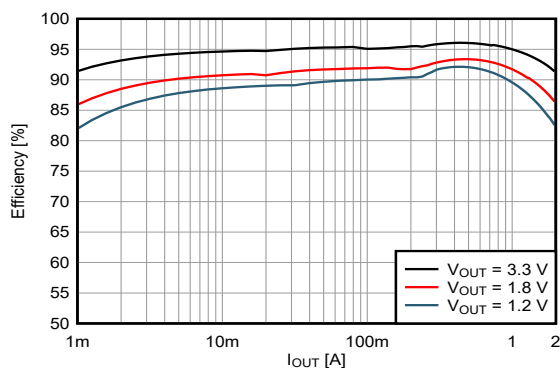

Efficiency vs Output Current at 5V_{IN} (TPS62A02x)

3 Description

The TPS62A0x family of devices are synchronous step-down buck DC/DC converters optimized for high efficiency and compact design size. The devices integrate switches capable of delivering an output current up to 2A. At medium to heavy loads, the devices operate in pulse width modulation (PWM) mode with 2.4MHz switching frequency. At light load, the devices automatically enter power save mode (PSM) to maintain high efficiency over the entire load current range. In shutdown, the current consumption is minimal as well. The TPS62A0xA variants of this device family operate in forced PWM across the whole load current range.

The TPS62A0x devices provide an adjustable output voltage through an external resistor divider. An internal soft-start circuit limits the inrush current during start-up. Other features like overcurrent protection, thermal shutdown protection, and power good (optional) are built-in. The devices are available in a SOT563 and SOT23-6 package.

Package Information

PART NUMBER	PACKAGE ⁽¹⁾	PACKAGE SIZE ⁽²⁾
TPS62A01x	DRL (SOT-563, 6)	1.60mm × 1.60mm
	DDC (SOT-23, 6)	2.90mm × 2.80mm
TPS62A02x	DRL (SOT-563, 6)	1.60mm × 1.60mm
	DDC (SOT-23, 6)	2.90mm × 2.80mm
TPS62A02Nx	DRL (SOT-563, 6)	1.60mm × 1.60mm

(1) For more information, see [Section 11](#).

(2) The package size (length × width) is a nominal value and includes pins, where applicable.

Device Information

PART NUMBER ⁽¹⁾	OPERATION MODE	OUTPUT CURRENT	PIN 6
TPS62A01	PSM, PWM	1A	PG
TPS62A01A	FPWM		
TPS62A02	PSM, PWM	2A	
TPS62A02A	FPWM		
TPS62A02N	PSM, PWM		
TPS62A02NA	FPWM		
			OUT

(1) See the [Device Comparison Table](#).



Table of Contents

1 Features	1	7.4 Device Functional Modes.....	9
2 Applications	1	8 Application and Implementation	11
3 Description	1	8.1 Application Information.....	11
4 Device Comparison Table	3	8.2 Typical Application.....	11
5 Pin Configuration and Functions	3	8.3 Power Supply Recommendations.....	17
6 Specifications	4	8.4 Layout.....	17
6.1 Absolute Maximum Ratings.....	4	9 Device and Documentation Support	19
6.2 ESD Ratings.....	4	9.1 Device Support.....	19
6.3 Recommended Operating Conditions.....	4	9.2 Receiving Notification of Documentation Updates....	19
6.4 Thermal Information.....	4	9.3 Support Resources.....	19
6.5 Electrical Characteristics.....	5	9.4 Trademarks.....	19
6.6 Typical Characteristics.....	7	9.5 Electrostatic Discharge Caution.....	19
7 Detailed Description	8	9.6 Glossary.....	19
7.1 Overview.....	8	10 Revision History	20
7.2 Functional Block Diagram.....	8	11 Mechanical, Packaging, and Orderable Information	20
7.3 Feature Description.....	8		

4 Device Comparison Table

Device Number	Output Current	Package	Operation Mode	Pin 6
TPS62A01DRLR	1A	SOT-563, 6	PSM, PWM	PG
TPS62A01ADRLR			FPWM	
TPS62A02DRLR	2A		PSM, PWM	OUT
TPS62A02ADRLR			FPWM	
TPS62A02NDRLR	1A	SOT-23, 6	PSM, PWM	PG
TPS62A02NADRLR			FPWM	
TPS62A01PDCCR	2A		PSM, PWM	PG
TPS62A01APDCCR			FPWM	
TPS62A02PDCCR	1A	PSM, PWM	PG	
TPS62A02APDCCR		FPWM		

5 Pin Configuration and Functions

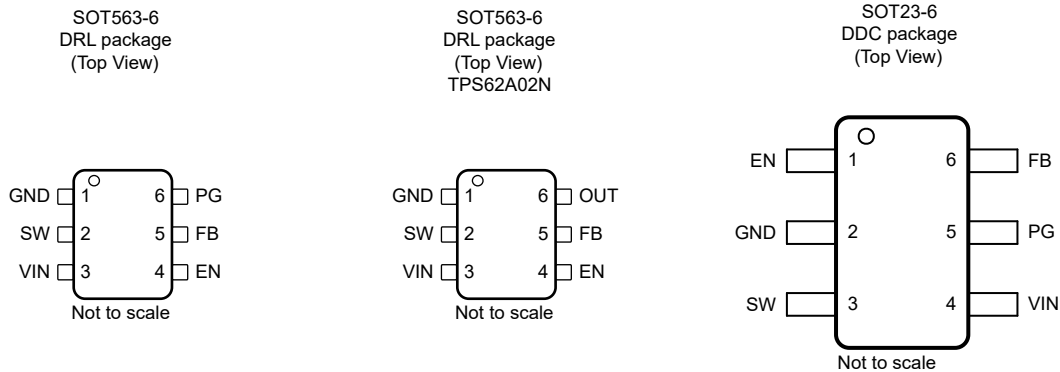

Figure 5-1. 6-Pin DRL SOT-563 Package (Top View), 6-Pin DDC SOT-23 Package (Top View)

Table 5-1. Pin Functions

Name	Pin Number		Type ⁽¹⁾	Description
	SOT563-6	SOT23-6		
EN	4	1	I	Device enable logic input. Logic high enables the device. Logic low disables the device and turns the device into shutdown. Do not leave the pin floating.
FB	5	6	I	Feedback pin for the internal control loop. Connect this pin to an external feedback divider.
GND	1	2	G	Ground pin.
PG	6	5	O	Power-good open-drain output pin. The pullup resistor cannot be connected to any voltage higher than 5.5V. If unused, leave the pin open or connect to GND.
OUT ⁽²⁾		/	I	Output voltage sense pin.
SW	2	3	O	Switch pin connected to the internal FET switches and inductor terminal. Connect the inductor of the output filter to this pin.
VIN	3	4	I	Input voltage pin. Connect the input capacitor as close as possible between V _{IN} and GND.

(1) I = Input, O = Output, G = Ground.

(2) Only for TPS62A0xN versions.

6 Specifications

6.1 Absolute Maximum Ratings

Over operating free-air temperature range (unless otherwise noted) ⁽¹⁾

		MIN	MAX	UNIT
Pin voltage ⁽²⁾	VIN, EN, PG	-0.3	6.5	V
	SW, DC	-0.3	V _{IN} + 0.3	V
	SW, transient < 10 ns	-3.0	10	V
	FB	-0.3	3	V
T _J	Operating junction temperature	-40	150	°C
T _{stg}	Storage temperature	-55	150	°C

- (1) Operation outside the Absolute Maximum Ratings may cause permanent device damage. Absolute Maximum Ratings do not imply functional operation of the device at these or any other conditions beyond those listed under Recommended Operating Conditions. If used outside the Recommended Operating Conditions but within the Absolute Maximum Ratings, the device may not be fully functional, and this may affect device reliability, functionality, performance, and shorten the device lifetime.
- (2) All voltage values are with respect to the network ground terminal.

6.2 ESD Ratings

			VALUE	UNIT
V _(ESD)	Electrostatic discharge	Human-body model (HBM), per ANSI/ESDA/JEDEC JS-001 ⁽¹⁾	±2000	V
		Charged-device model (CDM), per ANSI/ESDA/JEDEC JS-002 ⁽²⁾	±500	

- (1) JEDEC document JEP155 states that 500-V HBM allows safe manufacturing with a standard ESD control process.
- (2) JEDEC document JEP157 states that 250-V CDM allows safe manufacturing with a standard ESD control process.

6.3 Recommended Operating Conditions

Over operating junction temperature range (unless otherwise noted)

		MIN	NOM	MAX	UNIT
V _{IN}	Input supply voltage range	2.5		5.5	V
V _{OUT}	Output voltage range	0.6		V _{IN}	V
I _{OUT}	Output current range	0		1	A
I _{OUT}	Output current range ⁽¹⁾	0		2	A
L	Effective inductance		1.0		μH
C _{OUT}	Output capacitance		44		μF
C _{OUT}	Output capacitance		22		μF
C _{OUT}	Output capacitance		10		μF
I _{PG}	Power Good input current capability	0		1	mA
T _J	Operating junction temperature	-40		125	°C

- (1) Operating continuously at 2-A with input voltages < 3.3V or at ambient temperatures > 85 °C might result in thermal shutdown, per EVM measurements.

6.4 Thermal Information

THERMAL METRIC ⁽¹⁾		TPS62A0x	TPS62A0x	UNIT
		DRL	DDC	
		6 PINS	6 PINS	
R _{θJA}	Junction-to-ambient thermal resistance	157.3	132.1	°C/W
R _{θJC(top)}	Junction-to-case (top) thermal resistance	92.2	74.9	°C/W
R _{θJB}	Junction-to-board thermal resistance	45.6	45.5	°C/W
ψ _{JT}	Junction-to-top characterization parameter	4.0	25.5	°C/W

6.4 Thermal Information (continued)

THERMAL METRIC ⁽¹⁾		TPS62A0x	TPS62A0x	UNIT
		DRL	DDC	
		6 PINS	6 PINS	
Ψ_{JB}	Junction-to-board characterization parameter	45.0	45.1	°C/W

(1) For more information about traditional and new thermal metrics, see the [Semiconductor and IC Package Thermal Metrics](#) report.

6.5 Electrical Characteristics

$T_J = -40^{\circ}\text{C}$ to $+125^{\circ}\text{C}$, $V_{IN} = 2.5\text{ V}$ to 5.5 V . Typical values are at $T_J = 25^{\circ}\text{C}$ and $V_{IN} = 5\text{ V}$ (unless otherwise noted)

PARAMETER		TEST CONDITIONS	MIN	TYP	MAX	UNIT
SUPPLY						
$I_{Q(VIN)}$	VIN quiescent current	Non-switching; $V_{EN} = \text{High}$; $V_{FB} = 610\text{ mV}$; TPS62A01xDRL		20		μA
$I_{Q(VIN)}$	VIN quiescent current	Non-switching; $V_{EN} = \text{High}$; $V_{FB} = 610\text{ mV}$; TPS62A01xDDC; TPS62A02		23		μA
$I_{SD(VIN)}$	VIN shutdown supply current	$V_{EN} = \text{Low}$		0.01	2	μA
UVLO						
$V_{UVLO(R)}$	VIN UVLO rising threshold	V_{IN} rising	2.3	2.4	2.5	V
$V_{UVLO(F)}$	VIN UVLO falling threshold	V_{IN} falling	2.2	2.3	2.4	V
ENABLE						
$V_{EN(R)}$	EN voltage rising threshold	EN rising; enable switching	1.2			V
$V_{EN(F)}$	EN voltage falling threshold	EN falling, disable switching			0.4	V
$V_{EN(LKG)}$	EN input leakage current	$V_{EN} = 5\text{ V}$			100	nA
REFERENCE VOLTAGE						
V_{FB}	FB voltage	$T_J = 0^{\circ}\text{C}$ to 125°C , PWM mode	594	600	606	mV
V_{FB}	FB voltage	PWM mode	591	600	609	mV
$I_{FB(LKG)}$	FB input leakage current	$V_{FB} = 0.6\text{ V}$			100	nA
SWITCHING FREQUENCY						
$f_{SW(FCCM)}$	Switching frequency, FPWM operation	$V_{IN} = 5\text{ V}$; $V_{OUT} = 1.8\text{ V}$		2400		kHz
STARTUP						
	Internal fixed soft-start time	From EN = High to $V_{FB} = 0.56\text{ V}$			1	ms
POWER STAGE						
$R_{DS(ON)(HS)}$	High-side MOSFET on-resistance	TPS62A01xDRL; $V_{IN} = 5\text{ V}$		180		m Ω
$R_{DS(ON)(LS)}$	Low-side MOSFET on-resistance	TPS62A01xDRL; $V_{IN} = 5\text{ V}$		120		m Ω
$R_{DS(ON)(HS)}$	High-side MOSFET on-resistance	$V_{IN} = 5\text{ V}$; TPS62A01xDDC; TPS62A02		100		m Ω
$R_{DS(ON)(LS)}$	Low-side MOSFET on-resistance	$V_{IN} = 5\text{ V}$; TPS62A01xDDC; TPS62A02		67		m Ω
OVERCURRENT PROTECTION						
$I_{HS(OC)}$	High-side peak current limit	TPS62A01	1.3	1.8		A
$I_{LS(OC)}$	Low-side valley current limit	TPS62A01		1.8		A
$I_{HS(OC)}$	High-side peak current limit	TPS62A02	2.7	3.4		A
$I_{LS(OC)}$	Low-side valley current limit	TPS62A02xDRL		4.2		A
$I_{LS(OC)}$	Low-side valley current limit	TPS62A02xDDC		3.15		A
POWER GOOD						
V_{PGTH}	Power Good threshold	PG low, FB falling		93.5		%
V_{PGTH}	Power Good threshold	PG high, FB rising		96		%
	PG delay falling			35		μs
	PG delay rising			10		μs
$I_{PG(LKG)}$	PG pin Leakage current when open drain output is high	$V_{PG} = 5\text{ V}$			100	nA
	PG pin output low-level voltage	$I_{PG} = 1\text{ mA}$			400	mV
OUTPUT DISCHARGE						

6.5 Electrical Characteristics (continued)

$T_J = -40^{\circ}\text{C}$ to $+125^{\circ}\text{C}$, $V_{IN} = 2.5\text{ V}$ to 5.5 V . Typical values are at $T_J = 25^{\circ}\text{C}$ and $V_{IN} = 5\text{ V}$ (unless otherwise noted)

PARAMETER		TEST CONDITIONS	MIN	TYP	MAX	UNIT
	Output discharge current on SW pin	$V_{IN} = 3\text{ V}$, $V_{OUT} = 2.0\text{ V}$; TPS62A01xDRL		60		mA
	Output discharge current on SW pin	$V_{IN} = 3\text{ V}$, $V_{OUT} = 2.0\text{ V}$; TPS62A01xDDC; TPS62A02		76		mA
THERMAL SHUTDOWN						
$T_{J(SD)}$	Thermal shutdown threshold	Temperature rising		170		$^{\circ}\text{C}$
$T_{J(HYS)}$	Thermal shutdown hysteresis			20		$^{\circ}\text{C}$

6.6 Typical Characteristics

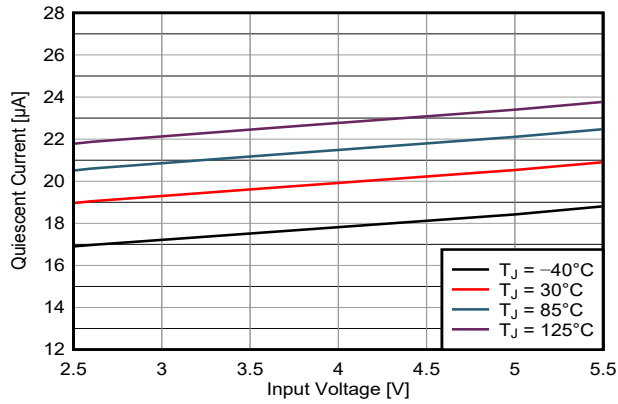

Figure 6-1. Quiescent Current vs Input Voltage (TPS62A01)

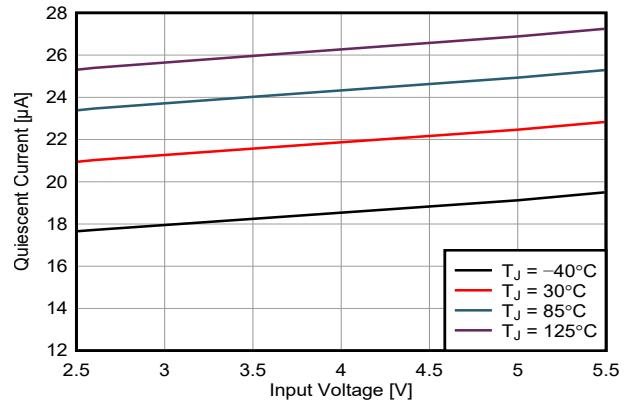

Figure 6-2. Quiescent Current vs Input Voltage (TPS62A02)

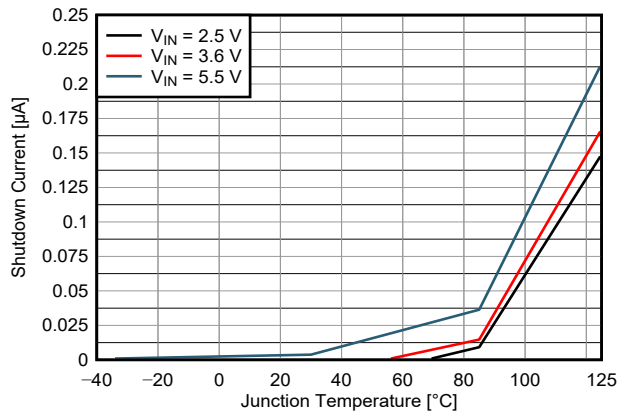

Figure 6-3. Shutdown Current vs Junction Temperature

7 Detailed Description

7.1 Overview

The TPS62A0x is a high-efficiency synchronous step-down converter. The device operates with an adaptive off time with a peak current control scheme. The device operates typically at 2.4MHz frequency pulse width modulation (PWM) at moderate to heavy load currents. Based on the V_{IN}/V_{OUT} ratio, a simple circuit sets the required off time for the low-side MOSFET, making the switching frequency relatively constant regardless of the variation of the input voltage, output voltage, and load current.

7.2 Functional Block Diagram

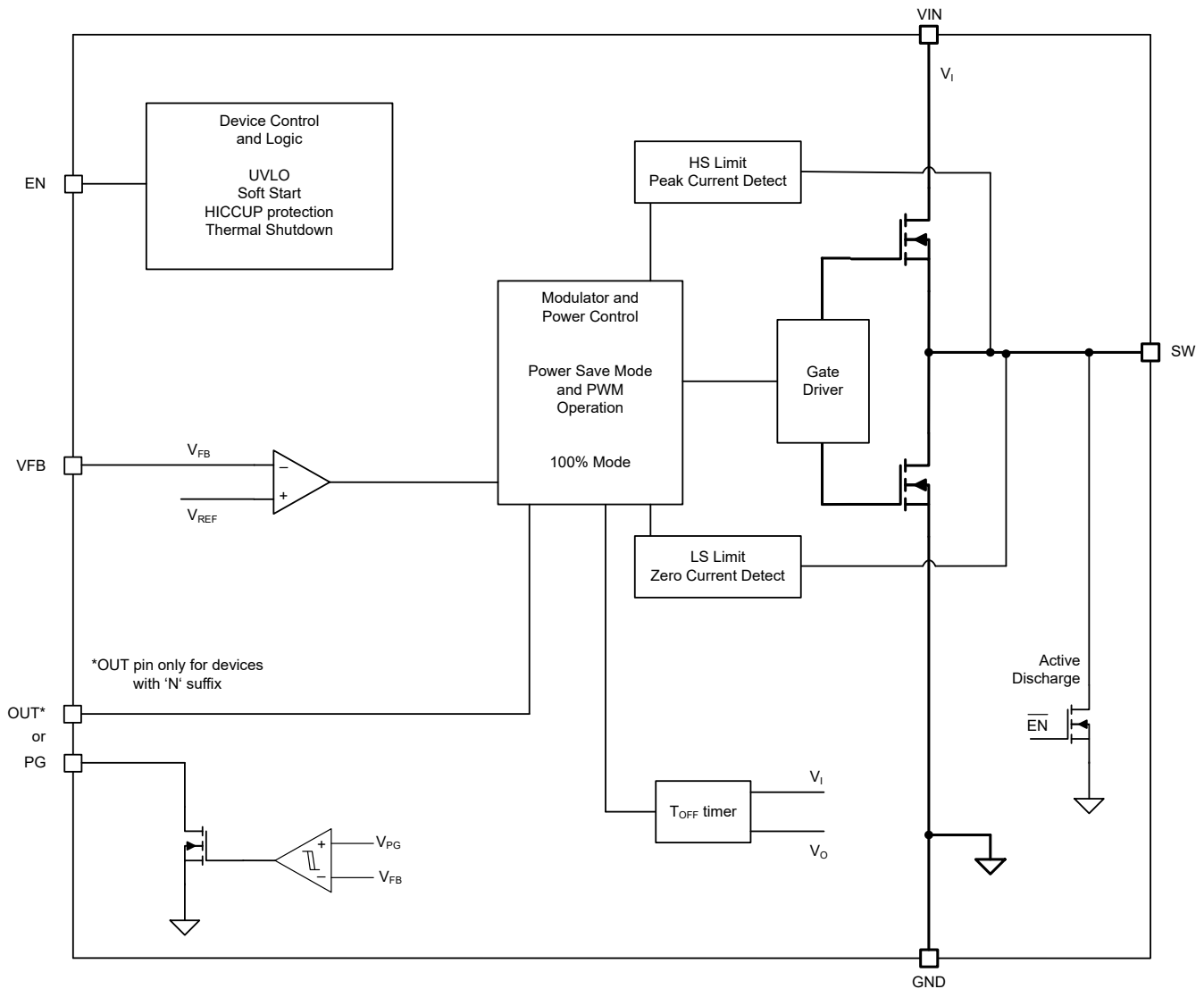

7.3 Feature Description

7.3.1 Power Save Mode

The device automatically enters power save mode to improve efficiency at light load when the inductor current becomes discontinuous. In power save mode, the converter reduces the switching frequency and minimizes current consumption. In power save mode, the output voltage rises slightly above the nominal output voltage. This effect is minimized by increasing the output capacitor or adding a feedforward capacitor.

7.3.2 100% Duty Cycle Low Dropout Operation

The device offers low input-to-output voltage difference by entering 100% duty cycle mode. In this mode, the high-side MOSFET switch is constantly turned on and the low-side MOSFET is switched off. The minimum input voltage to maintain output regulation, depending on the load current and output voltage, is calculated as:

$$V_{IN(MIN)} = V_{OUT} + I_{OUT} \times (R_{DS(ON)} + R_L) \quad (1)$$

where

- $R_{DS(ON)}$ = High-side FET on-resistance
- R_L = Inductor ohmic resistance (DCR)

7.3.3 Soft Start

After enabling the device, internal soft-start circuitry ramps up the output voltage, which reaches the nominal output voltage during start-up time, avoiding excessive inrush current and creating a smooth voltage rise slope. Internal soft-start circuitry also prevents excessive voltage drops of primary cells and rechargeable batteries with high internal impedance.

The TPS62A0x is able to start into a prebiased output capacitor. The converter starts with the applied bias voltage and ramps the output voltage to the nominal value.

7.3.4 Switch Current Limit and Short-Circuit Protection (HICCUP)

The switch current limit prevents the device from high inductor current and drawing excessive current from the battery or input rail. Due to internal propagation delay, the AC peak current can exceed the static current limit during that time. Excessive current can occur with a shorted or saturated inductor, an overload or shorted output circuit condition. If the inductor current reaches the threshold I_{LIM} , the high-side MOSFET is turned off and the low-side MOSFET is turned on to ramp down the inductor current with an adaptive off time.

When this switch current limit is triggered 32 times, the device stops switching to protect the output. The device then automatically starts a new start-up after a typical delay time of 100 μ s has passed. This is named HICCUP short-circuit protection. The device repeats this mode until the high load condition disappears. HICCUP protection is also enabled during the start-up.

7.3.5 Undervoltage Lockout

To avoid misoperation of the device at low input voltages, an undervoltage lockout (UVLO) is implemented, which shuts down the device at voltages lower than V_{UVLO} .

7.3.6 Thermal Shutdown

The device goes into thermal shutdown and stops switching when the junction temperature exceeds T_{JSD} . When the device temperature falls below the threshold by 20°C, the device returns to normal operation automatically.

7.4 Device Functional Modes

7.4.1 Enable and Disable

The device is enabled by setting the EN input to a logic High. Accordingly, a logic Low disables the device. If the device is enabled, the internal power stage starts switching and regulates the output voltage to the set point voltage. The EN input must be terminated and not be left floating.

7.4.2 Power Good

The TPS62A0x (except devices with 'N' suffix) has a built-in power-good (PG) feature to indicate whether the output voltage has reached the target and the device is ready. The PG signal can be used for start-up sequencing of multiple rails. The PG pin is an open-drain output that requires a pullup resistor to any voltage up to the recommended input voltage level. PG is low when the device is turned off due to EN, UVLO (undervoltage lockout), or thermal shutdown. V_{IN} must remain present for the PG pin to stay low. If not used, the power-good

can be tie to GND or left open. The PG indicator has a de-glitch to avoid the signal indicating glitches or transient responses from the loop.

Table 7-1. Power-Good indicator Functional Table

Logic Signals				PG Status
V_I	EN Pin	Thermal Shutdown	V_O	
$V_I > UVLO$	HIGH	NO	V_O on target	High Impedance
			$V_O < target$	LOW
		YES	LOW	
	YES	x	LOW	
	LOW	x	x	LOW
$V_I < 1.8V$	x	x	x	Undefined

8 Application and Implementation

Note

Information in the following applications sections is not part of the TI component specification, and TI does not warrant its accuracy or completeness. TI's customers are responsible for determining suitability of components for their purposes, as well as validating and testing their design implementation to confirm system functionality.

8.1 Application Information

The following section discusses the design of the external components to complete the power supply design for several input and output voltage options by using typical applications as a reference.

8.2 Typical Application

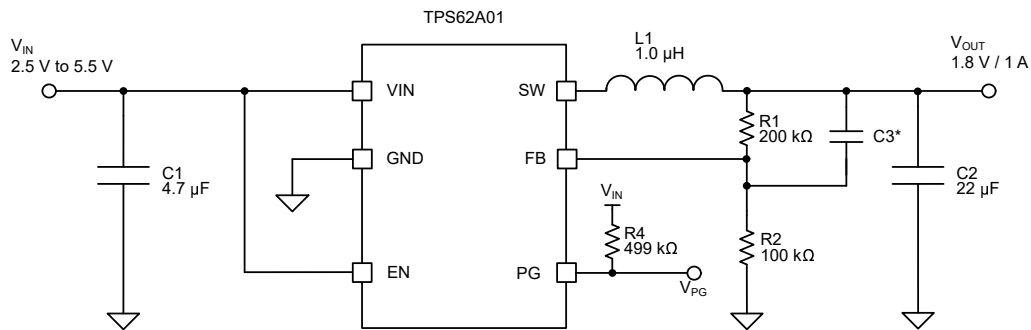

Figure 8-1. TPS62A01 Typical Application Circuit

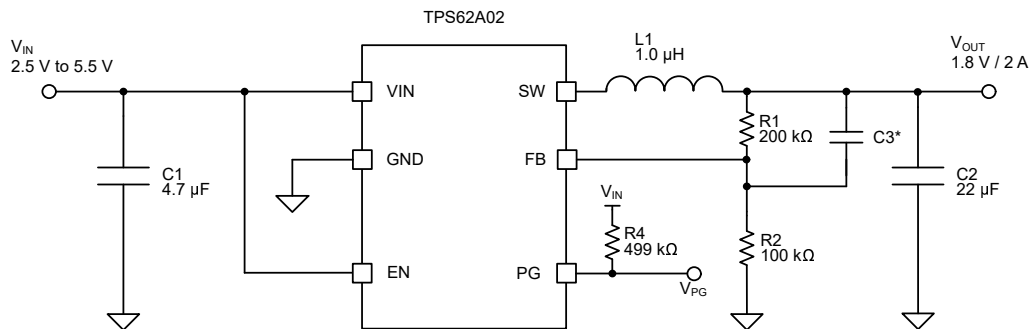

Figure 8-2. TPS62A02 Typical Application Circuit

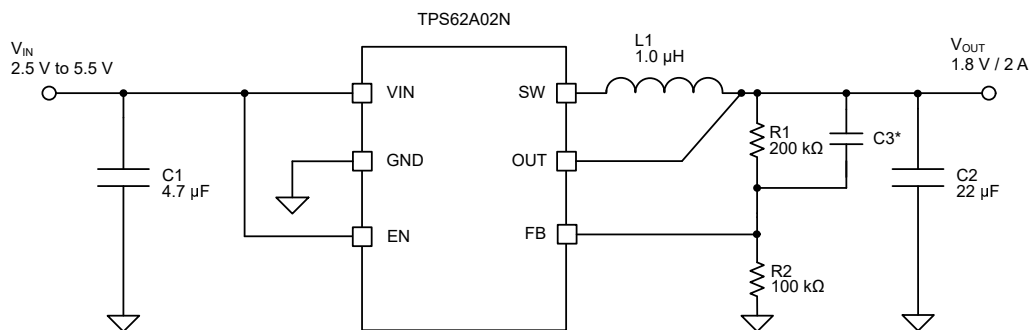

Figure 8-3. TPS62A02N Typical Application Circuit

*C3 is optional

8.2.1 Design Requirements

For this design example, use the parameters listed in [Table 8-1](#) as the input parameters

Table 8-1. Design Parameters

Design Parameter	Example Value
Input voltage	2.5V to 5.5V
Output voltage	1.8V
Maximum output current	1.0A, 2.0A

[Table 8-2](#) lists the components used for the example.

Table 8-2. List of Components

Reference	Description	Manufacturer ⁽¹⁾
C1	4.7µF, Ceramic Capacitor, 10V, X7R, size 0805, GRM21BR71A475KA73L	Murata
C2	22µF, Ceramic Capacitor, 10V, X7R, size 0805, GRM21BZ71A226KE15L	Murata
L1	1µH, Power Inductor, DFE252012F-1R0M (1A) / XGL3520-102MEC (2A)	Murata / Coilcraft
R1, R2	Chip resistor, 1%, size 0603	Std.
C3	Optional, 120pF if needed	Std.

(1) See the *Third-Party Products Disclaimer*.

8.2.2 Detailed Design Procedure

8.2.2.1 Setting the Output Voltage

The output voltage is set by an external resistor divider according to [Equation 2](#).

$$R1 = R2 \times \left(\frac{V_{OUT}}{V_{FB}} - 1 \right) = R2 \times \left(\frac{V_{OUT}}{0.6V} - 1 \right) \quad (2)$$

R2 must not be higher than 100kΩ to provide acceptable noise sensitivity.

8.2.2.2 Output Filter Design

The inductor and output capacitor together provide a low-pass filter. To simplify this process, [Table 8-3](#) outlines possible inductor and capacitor value combinations. Checked cells represent combinations that are proven for stability by simulation and lab test. Check further combinations for each individual application.

Table 8-3. Matrix of Output Capacitor and Inductor Combinations for TPS62A01 and TPS62A02

V _{OUT} [V]	L [µH] ⁽¹⁾	C _{OUT} [µF] ⁽²⁾		
		10	22	2 × 22
0.6 ≤ V _{OUT} < 1.2	1		+	++ ⁽³⁾
1.2 ≤ V _{OUT} < 1.8			++ ⁽³⁾	+
1.8 ≤ V _{OUT}		+ ⁽⁴⁾	++ ⁽³⁾	+

- (1) Inductor tolerance and current de-rating is anticipated. The effective inductance can vary by +20% and –30%.
- (2) Capacitance tolerance and bias voltage de-rating is anticipated. The effective capacitance can vary by +20% and –50%.
- (3) This LC combination is the standard value and recommended for most applications.
- (4) The minimum C_{OUT} of 10µF does not support an additional feedforward capacitor.

A 0.47µH inductor can also be used with the same recommended output capacitors for the TPS62A02x. In case a lower output ripple is desired, higher output capacitance can help reduce the ripple.

8.2.2.3 Input and Output Capacitor Selection

The architecture of the TPS62A0x allows use of tiny ceramic-type output capacitors with low equivalent series resistance (ESR). These capacitors provide low output voltage ripple and are thus recommended. To keep

resistance up to high frequencies and to achieve narrow capacitance variation with temperature, TI recommends to use X7R or X5R dielectric.

The input capacitor is the low impedance energy source for the converter that helps provide stable operation. TI recommends a low-ESR multilayer ceramic capacitor for best filtering. For most applications, a 4.7 μ F input capacitor is sufficient; a larger value reduces input voltage ripple.

The TPS62A0x is designed to operate with an output capacitor of 10 μ F to 47 μ F, depending on the selected output voltage, as outlined in [Table 8-3](#).

A feedforward capacitor reduces the output ripple in PSM and improves the load transient response. A 120pF capacitor is good for the 1.8V output typical application.

8.2.3 Application Curves

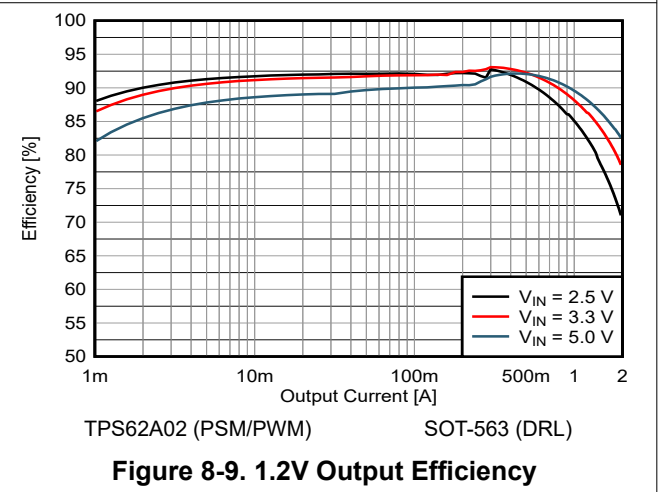
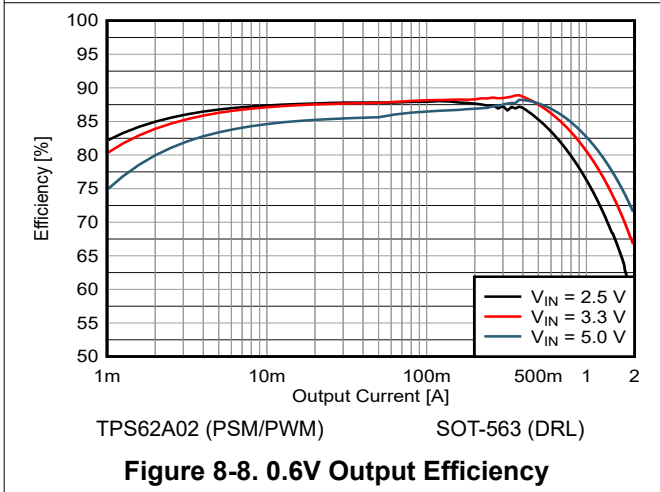
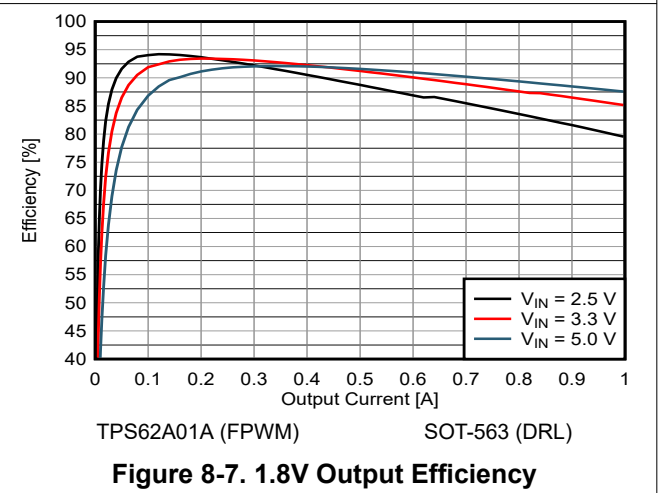
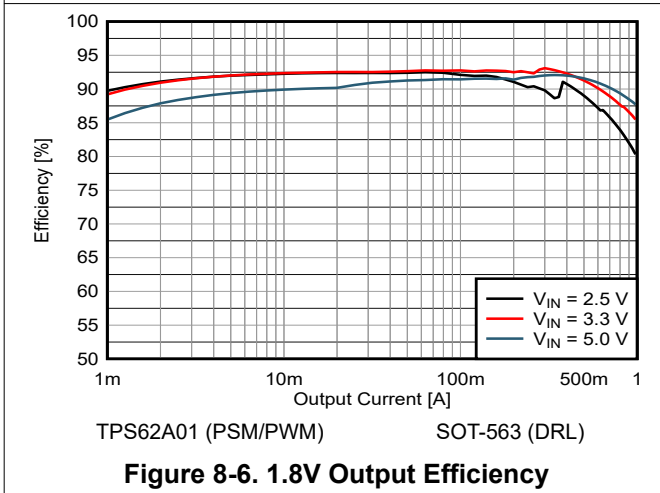
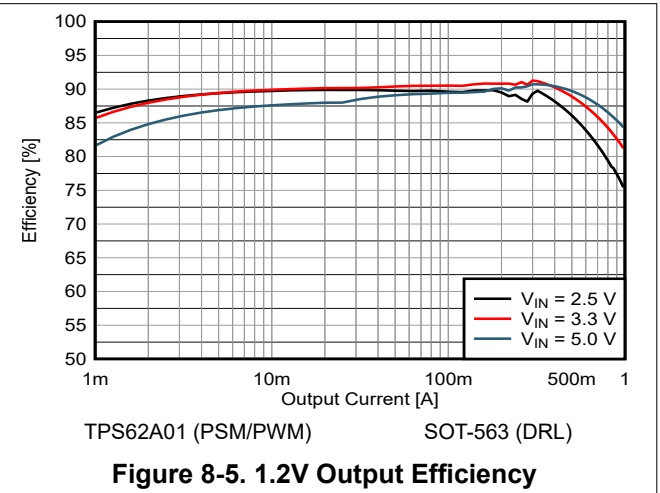
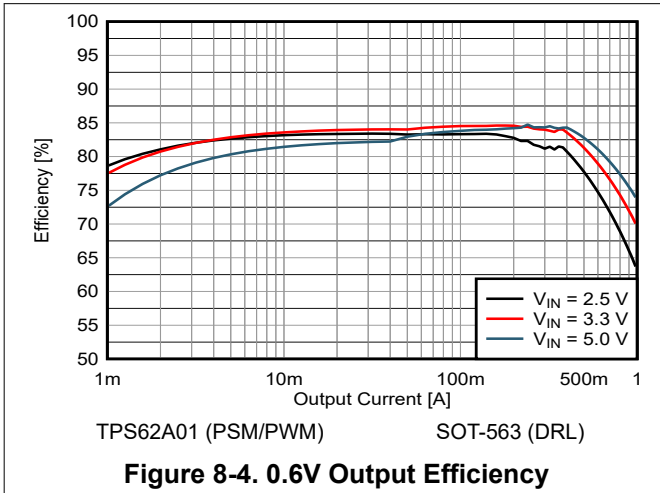

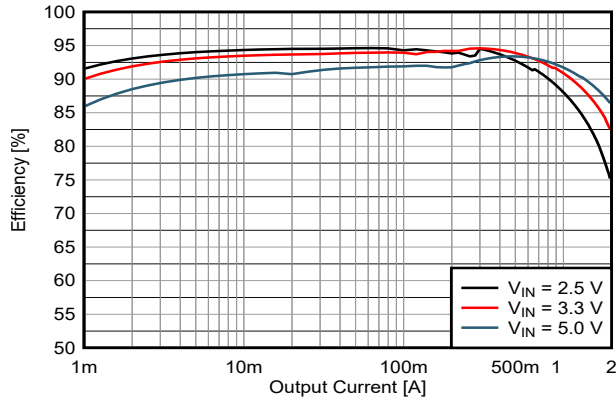

TPS62A02 (PSM/PWM) SOT-563 (DRL)

Figure 8-10. 1.8V Output Efficiency

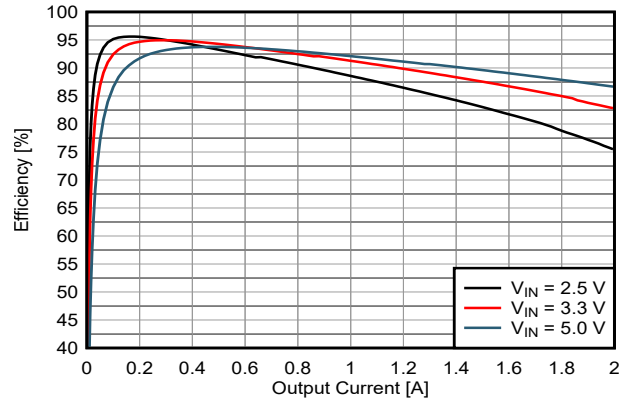

TPS62A02A (FPWM) SOT-563 (DRL)

Figure 8-11. 1.8V Output Efficiency

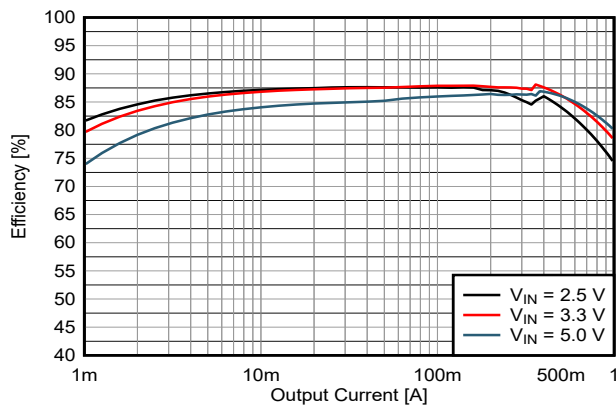

TPS62A01 (PSM/PWM) SOT-23 (DDC)

Figure 8-12. 0.6V Output Efficiency

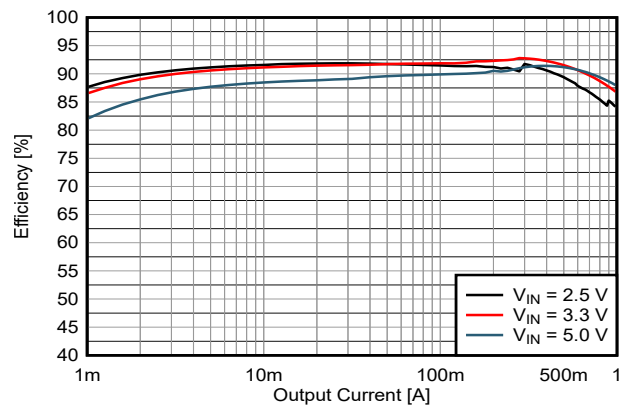

TPS62A01 (PSM/PWM) SOT-23 (DDC)

Figure 8-13. 1.2V Output Efficiency

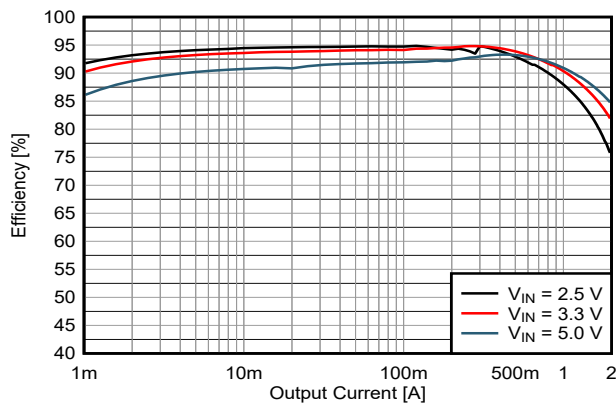

TPS62A01 (PSM/PWM) SOT-23 (DDC)

Figure 8-14. 1.8V Output Efficiency

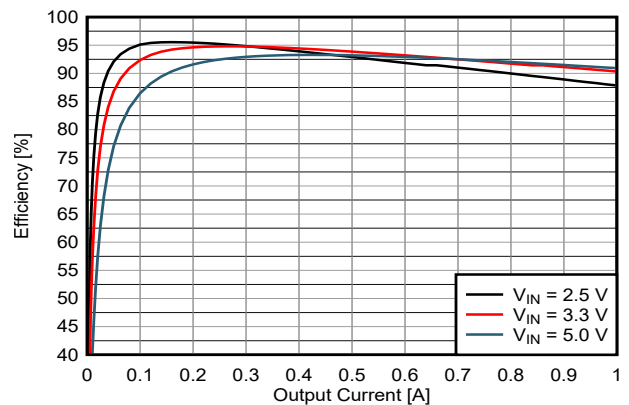

TPS62A01A (FPWM) SOT-23 (DDC)

Figure 8-15. 1.8V Output Efficiency

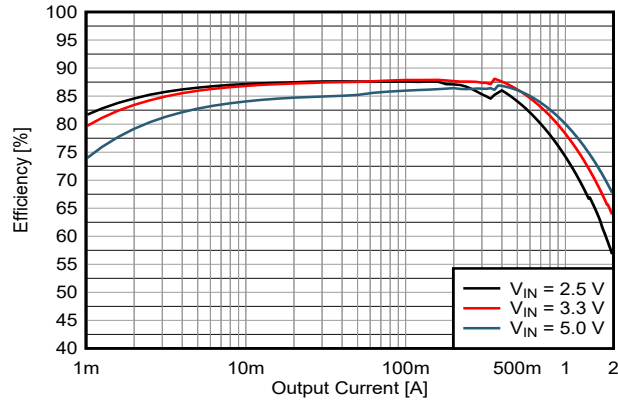

Figure 8-16. 0.6V Output Efficiency

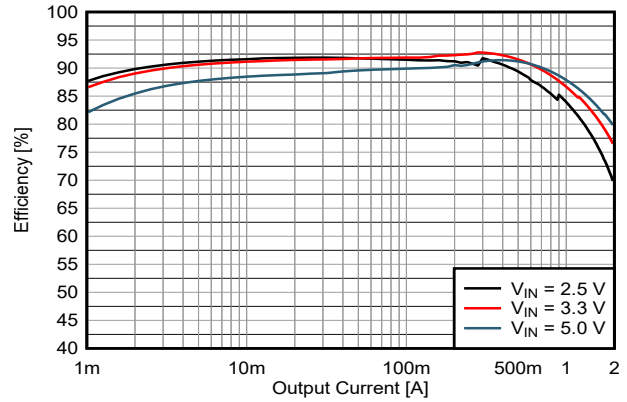

Figure 8-17. 1.2V Output Efficiency

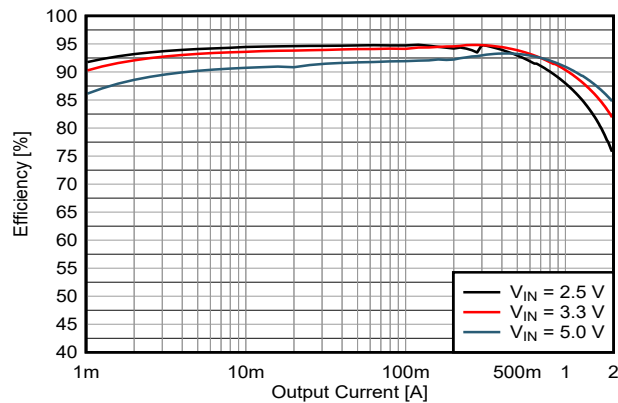

Figure 8-18. 1.8V Output Efficiency

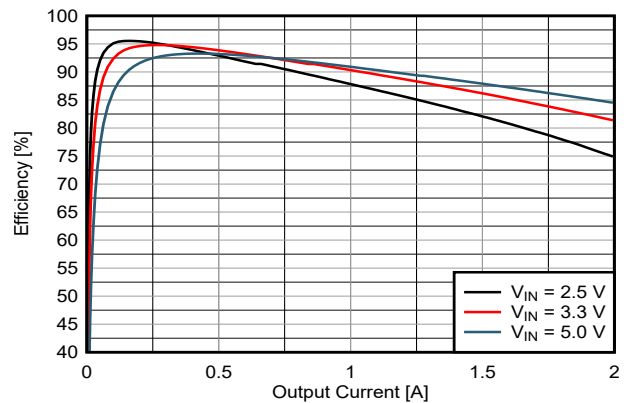

Figure 8-19. 1.8V Output Efficiency

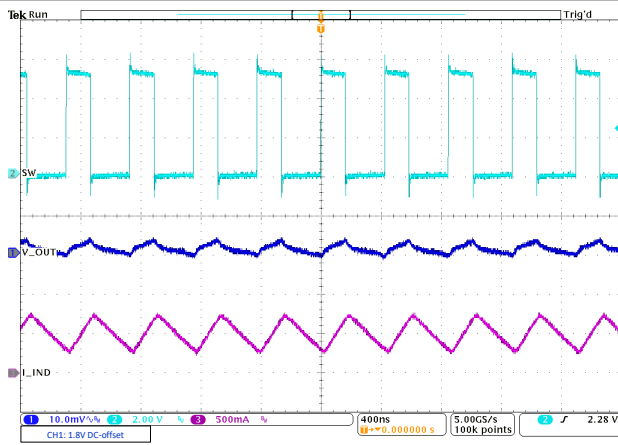

Figure 8-20. PWM Operation

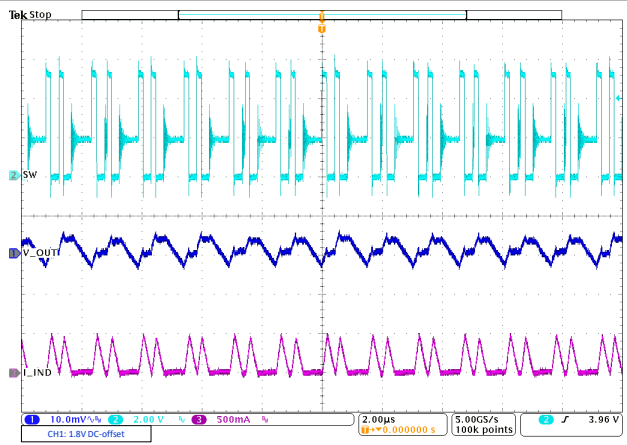
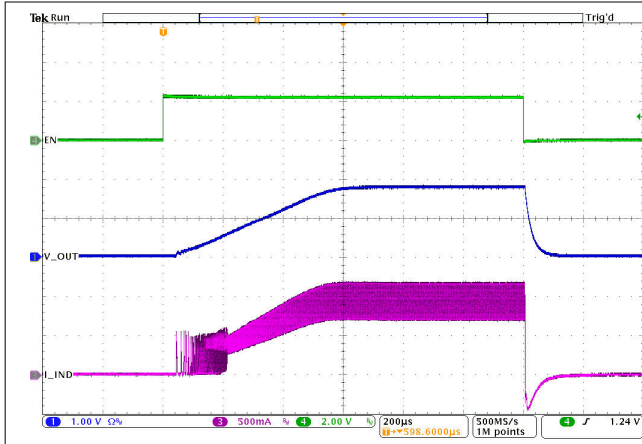
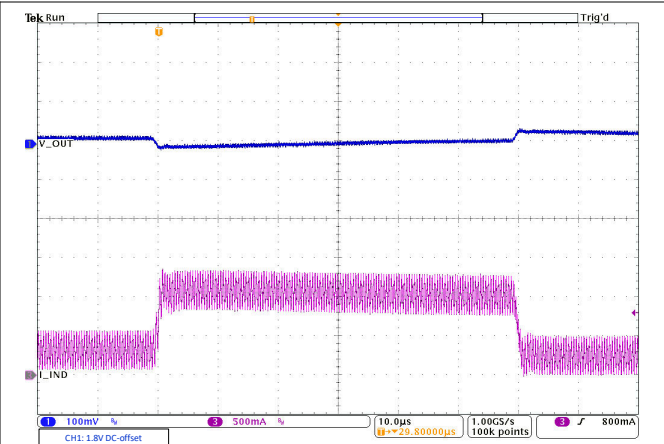

Figure 8-21. Power Save Mode Operation



$I_{OUT} = 1\text{ A}$
Figure 8-22. Start-Up with Load



Load step: 0.3 A to 1 A
Figure 8-23. Load Transient

8.3 Power Supply Recommendations

The device is designed to operate from an input voltage supply range from 2.5V to 5.5V. Make sure that the input power supply has a sufficient current rating for the application.

8.4 Layout

8.4.1 Layout Guidelines

The printed-circuit-board (PCB) layout is an important step to maintain the high performance of the TPS62A01x and TPS62A02x devices.

- Place the input and output capacitors and the inductor as close as possible to the IC. This action keeps the power traces short. Routing these power traces direct and wide results in low trace resistance and low parasitic inductance.
- Connect the low side of the input and output capacitors properly to the GND pin to avoid a ground potential shift.
- The sense traces connected to FB is a signal trace. Take special care to avoid noise being induced. Keep these traces away from SW nodes.
- Use a common ground. GND layers can be used for shielding.

See [Figure 8-24](#) and [Figure 8-25](#) for the recommended PCB layout.

8.4.2 Layout Example

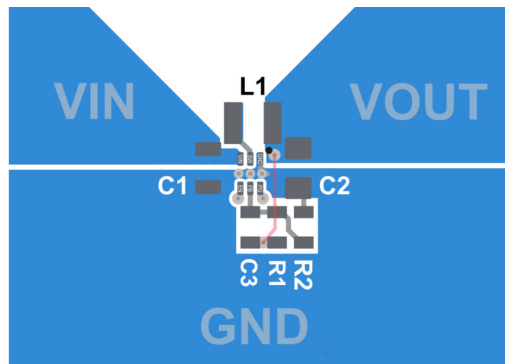

Figure 8-24. TPS62A0x (SOT563) PCB Layout Recommendation

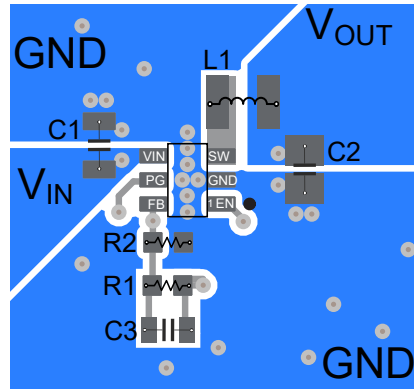

Figure 8-25. TPS62A0x (SOT23-6) PCB Layout Recommendation

9 Device and Documentation Support

9.1 Device Support

9.1.1 Third-Party Products Disclaimer

TI'S PUBLICATION OF INFORMATION REGARDING THIRD-PARTY PRODUCTS OR SERVICES DOES NOT CONSTITUTE AN ENDORSEMENT REGARDING THE SUITABILITY OF SUCH PRODUCTS OR SERVICES OR A WARRANTY, REPRESENTATION OR ENDORSEMENT OF SUCH PRODUCTS OR SERVICES, EITHER ALONE OR IN COMBINATION WITH ANY TI PRODUCT OR SERVICE.

9.2 Receiving Notification of Documentation Updates

To receive notification of documentation updates, navigate to the device product folder on [ti.com](https://www.ti.com). Click on *Notifications* to register and receive a weekly digest of any product information that has changed. For change details, review the revision history included in any revised document.

9.3 Support Resources

[TI E2E™ support forums](#) are an engineer's go-to source for fast, verified answers and design help — straight from the experts. Search existing answers or ask your own question to get the quick design help you need.

Linked content is provided "AS IS" by the respective contributors. They do not constitute TI specifications and do not necessarily reflect TI's views; see TI's [Terms of Use](#).

9.4 Trademarks

TI E2E™ is a trademark of Texas Instruments.

All trademarks are the property of their respective owners.

9.5 Electrostatic Discharge Caution



This integrated circuit can be damaged by ESD. Texas Instruments recommends that all integrated circuits be handled with appropriate precautions. Failure to observe proper handling and installation procedures can cause damage.

ESD damage can range from subtle performance degradation to complete device failure. Precision integrated circuits may be more susceptible to damage because very small parametric changes could cause the device not to meet its published specifications.

9.6 Glossary

[TI Glossary](#)

This glossary lists and explains terms, acronyms, and definitions.

10 Revision History

NOTE: Page numbers for previous revisions may differ from page numbers in the current version.

Changes from Revision D (April 2024) to Revision E (June 2024)	Page
<ul style="list-style-type: none"> • Changed device status of TPS62A02Nx versions and devices in DDC package from preview to production throughout the data sheet..... 	3

Changes from Revision C (December 2023) to Revision D (April 2024)	Page
<ul style="list-style-type: none"> • Added devices with 'N' suffix throughout the data sheet..... • Changed absolute maximum voltage of VIN, EN and PG from 6V to 6.5V..... • Updated block diagram to include devices with 'N' suffix (OUT instead of PG)..... 	1 4 8

Changes from Revision B (July 2022) to Revision C (December 2023)	Page
<ul style="list-style-type: none"> • Added DDC package option throughout the data sheet..... • Changed ESD Ratings CDM row from showing testing was per JESD22-C101 to show that testing was per JS-002..... • Changed block diagram PG circuit by swapping V_{PG} and V_{FB} 	3 4 8

11 Mechanical, Packaging, and Orderable Information

The following pages include mechanical, packaging, and orderable information. This information is the most current data available for the designated devices. This data is subject to change without notice and revision of this document. For browser-based versions of this data sheet, refer to the left-hand navigation.

PACKAGING INFORMATION

Orderable Device	Status (1)	Package Type	Package Drawing	Pins	Package Qty	Eco Plan (2)	Lead finish/ Ball material (6)	MSL Peak Temp (3)	Op Temp (°C)	Device Marking (4/5)	Samples
TPS62A01ADRLR	ACTIVE	SOT-5X3	DRL	6	4000	RoHS & Green	Call TI SN	Level-1-260C-UNLIM	-40 to 125	1J8	Samples
TPS62A01DRLR	ACTIVE	SOT-5X3	DRL	6	4000	RoHS & Green	Call TI SN	Level-1-260C-UNLIM	-40 to 125	1J7	Samples
TPS62A02ADRLR	ACTIVE	SOT-5X3	DRL	6	4000	RoHS & Green	Call TI SN	Level-1-260C-UNLIM	-40 to 125	1JM	Samples
TPS62A02APDDCR	ACTIVE	SOT-23-THIN	DDC	6	3000	RoHS & Green	Call TI SN	Level-1-260C-UNLIM	-40 to 125	A02AP	Samples
TPS62A02DRLR	ACTIVE	SOT-5X3	DRL	6	4000	RoHS & Green	Call TI SN	Level-1-260C-UNLIM	-40 to 125	1JL	Samples
TPS62A02PDDCR	ACTIVE	SOT-23-THIN	DDC	6	3000	RoHS & Green	Call TI SN	Level-1-260C-UNLIM	-40 to 125	A02P	Samples

(1) The marketing status values are defined as follows:

ACTIVE: Product device recommended for new designs.

LIFEBUY: TI has announced that the device will be discontinued, and a lifetime-buy period is in effect.

NRND: Not recommended for new designs. Device is in production to support existing customers, but TI does not recommend using this part in a new design.

PREVIEW: Device has been announced but is not in production. Samples may or may not be available.

OBSOLETE: TI has discontinued the production of the device.

(2) **RoHS:** TI defines "RoHS" to mean semiconductor products that are compliant with the current EU RoHS requirements for all 10 RoHS substances, including the requirement that RoHS substance do not exceed 0.1% by weight in homogeneous materials. Where designed to be soldered at high temperatures, "RoHS" products are suitable for use in specified lead-free processes. TI may reference these types of products as "Pb-Free".

RoHS Exempt: TI defines "RoHS Exempt" to mean products that contain lead but are compliant with EU RoHS pursuant to a specific EU RoHS exemption.

Green: TI defines "Green" to mean the content of Chlorine (Cl) and Bromine (Br) based flame retardants meet JS709B low halogen requirements of <=1000ppm threshold. Antimony trioxide based flame retardants must also meet the <=1000ppm threshold requirement.

(3) MSL, Peak Temp. - The Moisture Sensitivity Level rating according to the JEDEC industry standard classifications, and peak solder temperature.

(4) There may be additional marking, which relates to the logo, the lot trace code information, or the environmental category on the device.

(5) Multiple Device Markings will be inside parentheses. Only one Device Marking contained in parentheses and separated by a "~" will appear on a device. If a line is indented then it is a continuation of the previous line and the two combined represent the entire Device Marking for that device.

(6) Lead finish/Ball material - Orderable Devices may have multiple material finish options. Finish options are separated by a vertical ruled line. Lead finish/Ball material values may wrap to two lines if the finish value exceeds the maximum column width.

Important Information and Disclaimer: The information provided on this page represents TI's knowledge and belief as of the date that it is provided. TI bases its knowledge and belief on information provided by third parties, and makes no representation or warranty as to the accuracy of such information. Efforts are underway to better integrate information from third parties. TI has taken and continues to take reasonable steps to provide representative and accurate information but may not have conducted destructive testing or chemical analysis on incoming materials and chemicals. TI and TI suppliers consider certain information to be proprietary, and thus CAS numbers and other limited information may not be available for release.

In no event shall TI's liability arising out of such information exceed the total purchase price of the TI part(s) at issue in this document sold by TI to Customer on an annual basis.

OTHER QUALIFIED VERSIONS OF TPS62A01, TPS62A01A :

- Automotive : [TPS62A01-Q1](#), [TPS62A01A-Q1](#)

NOTE: Qualified Version Definitions:

- Automotive - Q100 devices qualified for high-reliability automotive applications targeting zero defects

TAPE AND REEL INFORMATION

QUADRANT ASSIGNMENTS FOR PIN 1 ORIENTATION IN TAPE

*All dimensions are nominal

Device	Package Type	Package Drawing	Pins	SPQ	Reel Diameter (mm)	Reel Width W1 (mm)	A0 (mm)	B0 (mm)	K0 (mm)	P1 (mm)	W (mm)	Pin1 Quadrant
TPS62A01ADRLR	SOT-5X3	DRL	6	4000	180.0	8.4	2.0	1.8	0.75	4.0	8.0	Q3
TPS62A01DRLR	SOT-5X3	DRL	6	4000	180.0	8.4	2.0	1.8	0.75	4.0	8.0	Q3
TPS62A02ADRLR	SOT-5X3	DRL	6	4000	180.0	8.4	2.0	1.8	0.75	4.0	8.0	Q3
TPS62A02APDDCR	SOT-23-THIN	DDC	6	3000	180.0	8.4	3.2	3.2	1.4	4.0	8.0	Q3
TPS62A02DRLR	SOT-5X3	DRL	6	4000	180.0	8.4	2.0	1.8	0.75	4.0	8.0	Q3
TPS62A02PDDCR	SOT-23-THIN	DDC	6	3000	180.0	8.4	3.2	3.2	1.4	4.0	8.0	Q3

TAPE AND REEL BOX DIMENSIONS

*All dimensions are nominal

Device	Package Type	Package Drawing	Pins	SPQ	Length (mm)	Width (mm)	Height (mm)
TPS62A01ADRLR	SOT-5X3	DRL	6	4000	210.0	185.0	35.0
TPS62A01DRLR	SOT-5X3	DRL	6	4000	210.0	185.0	35.0
TPS62A02ADRLR	SOT-5X3	DRL	6	4000	210.0	185.0	35.0
TPS62A02APDDCR	SOT-23-THIN	DDC	6	3000	210.0	185.0	35.0
TPS62A02DRLR	SOT-5X3	DRL	6	4000	210.0	185.0	35.0
TPS62A02PDDCR	SOT-23-THIN	DDC	6	3000	210.0	185.0	35.0

DRL0006A

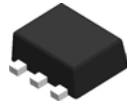

PACKAGE OUTLINE

SOT - 0.6 mm max height

PLASTIC SMALL OUTLINE

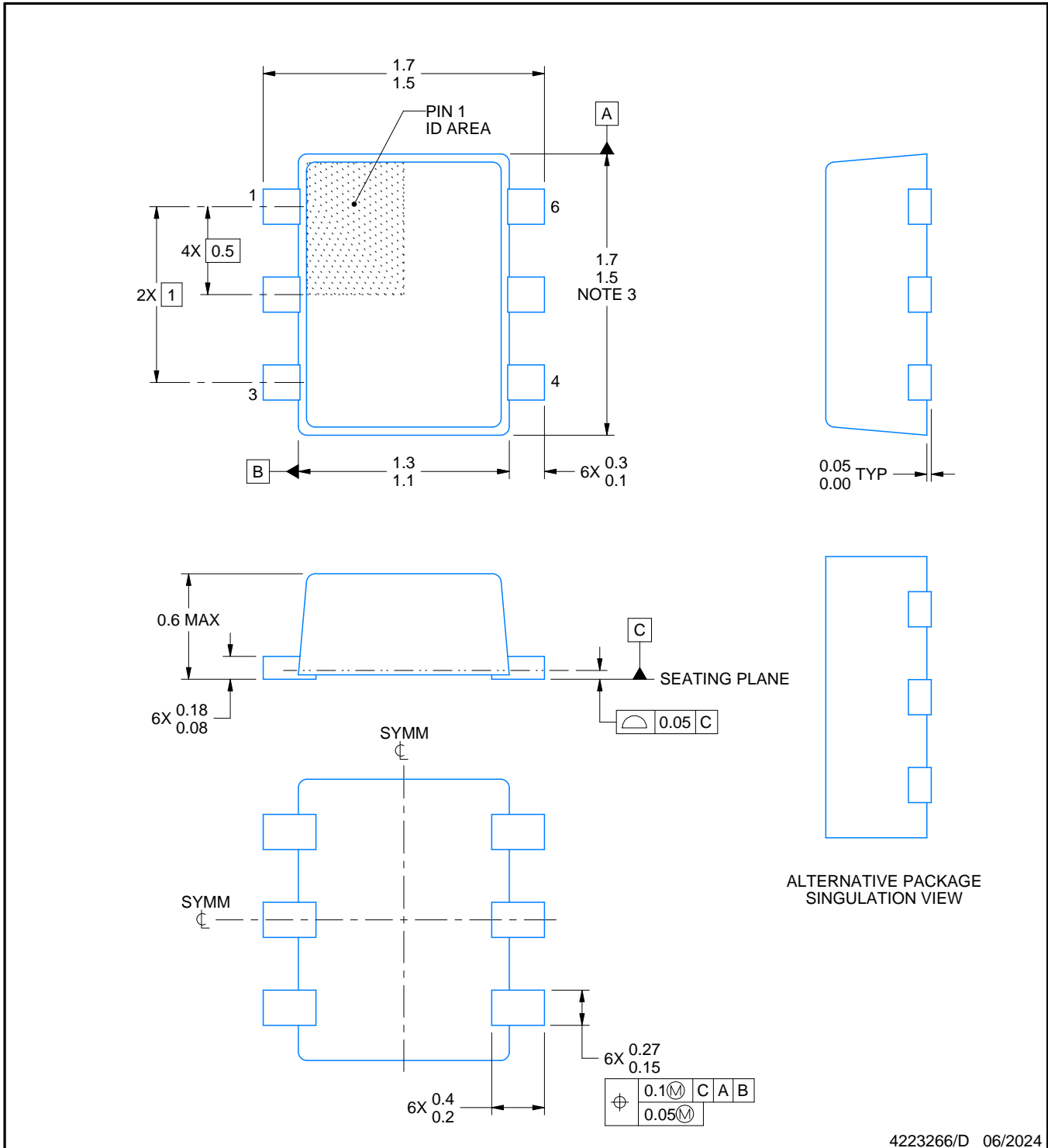

4223266/D 06/2024

NOTES:

1. All linear dimensions are in millimeters. Any dimensions in parenthesis are for reference only. Dimensioning and tolerancing per ASME Y14.5M.
2. This drawing is subject to change without notice.
3. This dimension does not include mold flash, protrusions, or gate burrs. Mold flash, protrusions, or gate burrs shall not exceed 0.15 mm per side.
4. Reference JEDEC registration MO-293 Variation UAAD

EXAMPLE BOARD LAYOUT

DRL0006A

SOT - 0.6 mm max height

PLASTIC SMALL OUTLINE

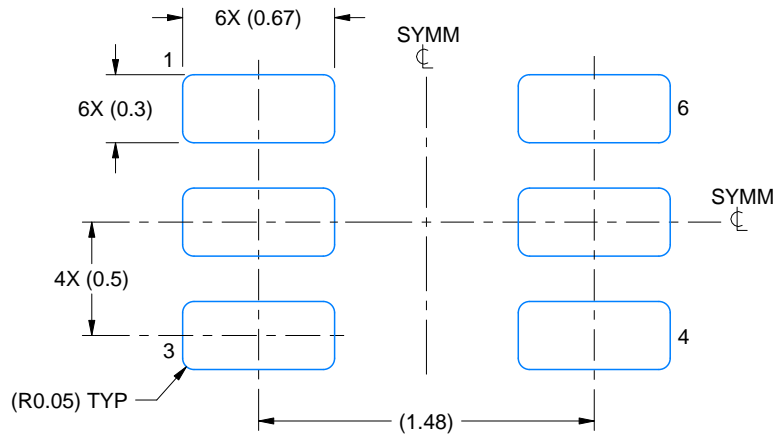

LAND PATTERN EXAMPLE
SCALE:30X

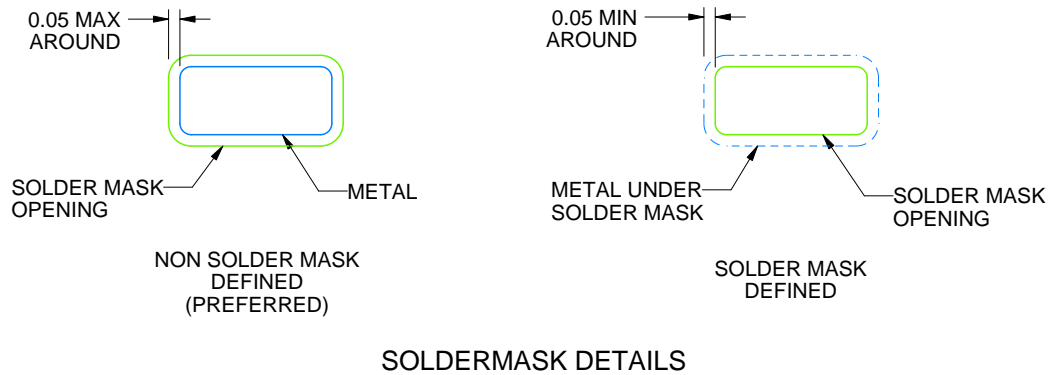

SOLDERMASK DETAILS

4223266/D 06/2024

NOTES: (continued)

5. Publication IPC-7351 may have alternate designs.
6. Solder mask tolerances between and around signal pads can vary based on board fabrication site.
7. Land pattern design aligns to IPC-610, Bottom Termination Component (BTC) solder joint inspection criteria.

EXAMPLE STENCIL DESIGN

DRL0006A

SOT - 0.6 mm max height

PLASTIC SMALL OUTLINE

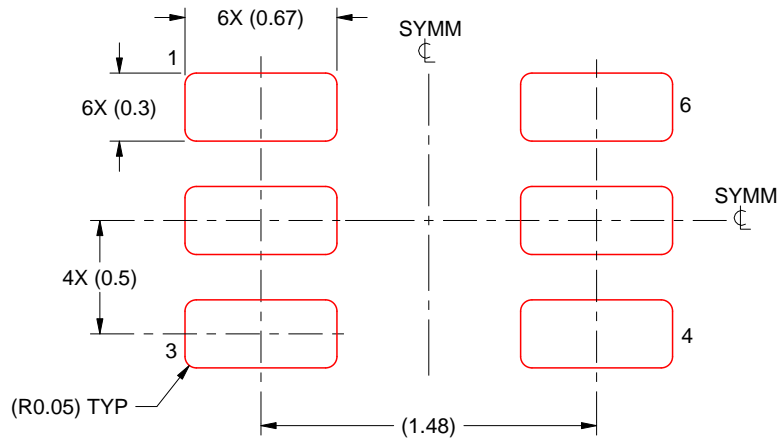

SOLDER PASTE EXAMPLE
BASED ON 0.1 mm THICK STENCIL
SCALE:30X

4223266/D 06/2024

NOTES: (continued)

8. Laser cutting apertures with trapezoidal walls and rounded corners may offer better paste release. IPC-7525 may have alternate design recommendations.
9. Board assembly site may have different recommendations for stencil design.

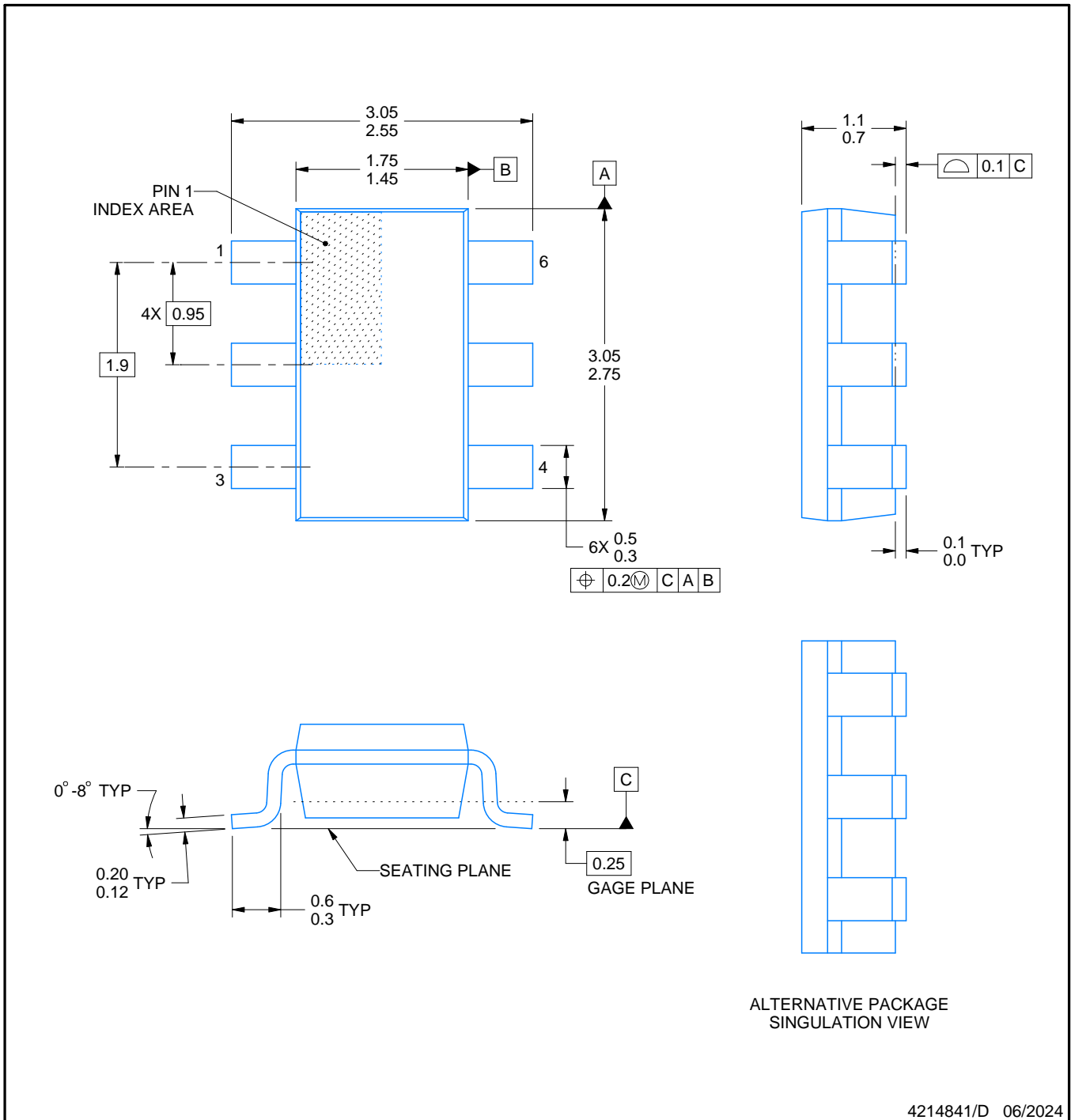

4214841/D 06/2024

NOTES:

1. All linear dimensions are in millimeters. Any dimensions in parenthesis are for reference only. Dimensioning and tolerancing per ASME Y14.5M.
2. This drawing is subject to change without notice.
3. Reference JEDEC MO-193.

EXAMPLE BOARD LAYOUT

DDC0006A

SOT-23 - 1.1 max height

SMALL OUTLINE TRANSISTOR

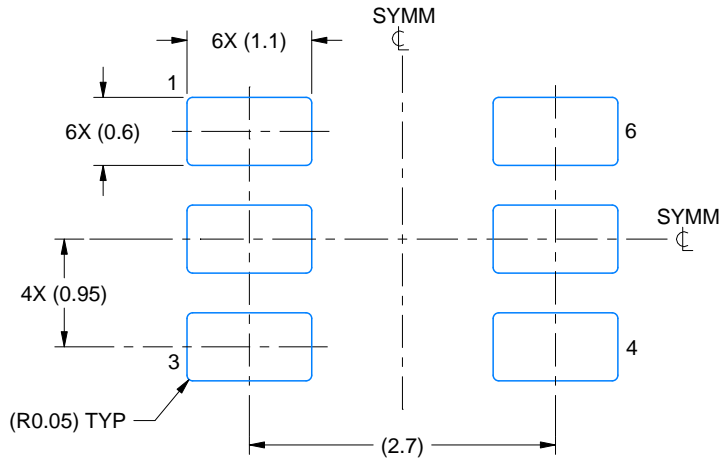

LAND PATTERN EXAMPLE
EXPLODED METAL SHOWN
SCALE:15X

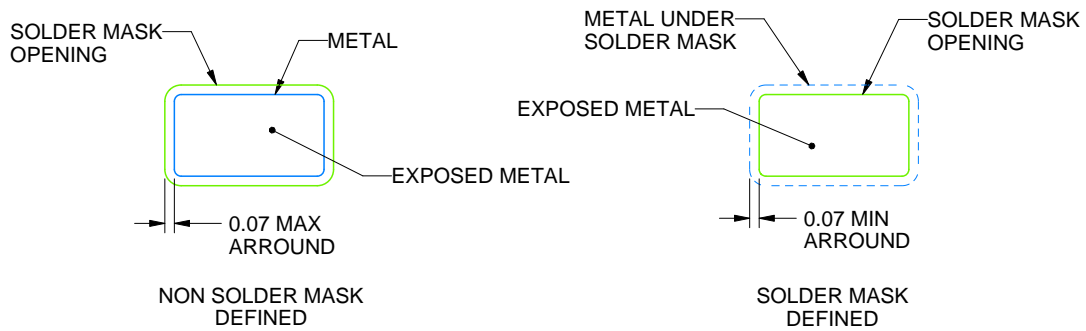

SOLDEMASK DETAILS

4214841/D 06/2024

NOTES: (continued)

- 4. Publication IPC-7351 may have alternate designs.
- 5. Solder mask tolerances between and around signal pads can vary based on board fabrication site.

EXAMPLE STENCIL DESIGN

DDC0006A

SOT-23 - 1.1 max height

SMALL OUTLINE TRANSISTOR

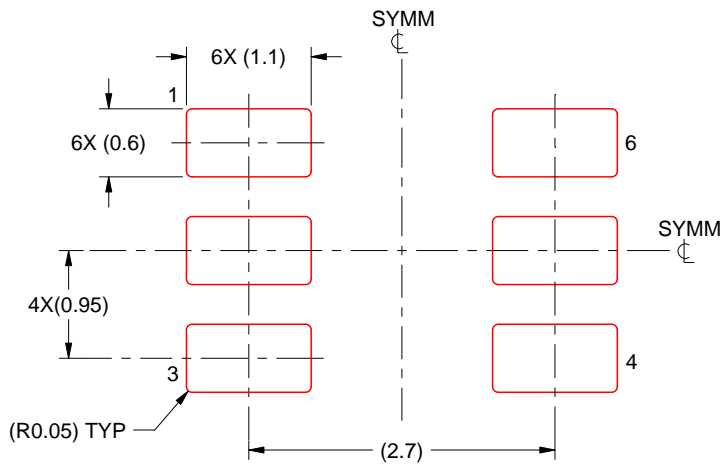

SOLDER PASTE EXAMPLE
BASED ON 0.125 THICK STENCIL
SCALE:15X

4214841/D 06/2024

NOTES: (continued)

6. Laser cutting apertures with trapezoidal walls and rounded corners may offer better paste release. IPC-7525 may have alternate design recommendations.
7. Board assembly site may have different recommendations for stencil design.

IMPORTANT NOTICE AND DISCLAIMER

TI PROVIDES TECHNICAL AND RELIABILITY DATA (INCLUDING DATA SHEETS), DESIGN RESOURCES (INCLUDING REFERENCE DESIGNS), APPLICATION OR OTHER DESIGN ADVICE, WEB TOOLS, SAFETY INFORMATION, AND OTHER RESOURCES "AS IS" AND WITH ALL FAULTS, AND DISCLAIMS ALL WARRANTIES, EXPRESS AND IMPLIED, INCLUDING WITHOUT LIMITATION ANY IMPLIED WARRANTIES OF MERCHANTABILITY, FITNESS FOR A PARTICULAR PURPOSE OR NON-INFRINGEMENT OF THIRD PARTY INTELLECTUAL PROPERTY RIGHTS.

These resources are intended for skilled developers designing with TI products. You are solely responsible for (1) selecting the appropriate TI products for your application, (2) designing, validating and testing your application, and (3) ensuring your application meets applicable standards, and any other safety, security, regulatory or other requirements.

These resources are subject to change without notice. TI grants you permission to use these resources only for development of an application that uses the TI products described in the resource. Other reproduction and display of these resources is prohibited. No license is granted to any other TI intellectual property right or to any third party intellectual property right. TI disclaims responsibility for, and you will fully indemnify TI and its representatives against, any claims, damages, costs, losses, and liabilities arising out of your use of these resources.

TI's products are provided subject to [TI's Terms of Sale](#) or other applicable terms available either on [ti.com](https://www.ti.com) or provided in conjunction with such TI products. TI's provision of these resources does not expand or otherwise alter TI's applicable warranties or warranty disclaimers for TI products.

TI objects to and rejects any additional or different terms you may have proposed.

Mailing Address: Texas Instruments, Post Office Box 655303, Dallas, Texas 75265
Copyright © 2024, Texas Instruments Incorporated