

TPS71025 LOW-DROPOUT VOLTAGE REGULATOR

SLVS162A – MAY 1997 – REVISED MAY 1998

- 2.5-V Fixed-Output Regulator
- Very Low-Dropout (LDO) Voltage . . . 57 mV Typical at $I_O = 100$ mA
- Very Low Quiescent Current, Independent of Load . . . 292 μ A Typ
- Extremely Low Sleep-State Current, 0.5 μ A Max
- 2% Tolerance Over Specified Conditions
- Output Current Range . . . 0 mA to 500 mA
- Available in Space Saving 8-Pin SOIC and 20-Pin TSSOP Packages
- 0°C to 125°C Operating Junction Temperature Range

description

The TPS71025 low-dropout regulator offers an order of magnitude reduction in both dropout voltage and quiescent current over conventional LDO performance. The improvement results from replacing the typical pnp pass transistor with a PMOS device.

Because the PMOS device behaves as a low-value resistor, the dropout voltage is very low (maximum of 95 mV at an output current of 100 mA) and is directly proportional to the output current (see Figure 1). Additionally, since the PMOS pass element is a voltage-driven device, the quiescent current is very low and remains independent of output loading (typically 292 μ A over the full range of output current, 0 mA to 500 mA). These two key specifications yield a significant improvement in operating life for battery-powered systems. The TPS71025 also features a sleep mode; applying a TTL high signal to \overline{EN} (enable) shuts down the regulator, reducing the quiescent current to 0.5 μ A maximum at $T_J = 25^\circ\text{C}$.

D OR P PACKAGE
(TOP VIEW)

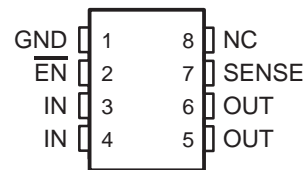

PW PACKAGE
(TOP VIEW)

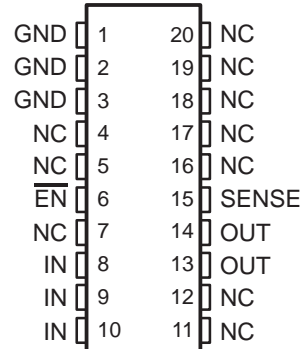

NC – No internal connection

AVAILABLE OPTIONS

| T_J | OUTPUT VOLTAGE (V) | | | PACKAGED DEVICES | | | CHIP FORM (Y) |
|--------------|--------------------|-----|------|-------------------|-----------------|--------------|---------------|
| | MIN | TYP | MAX | SMALL OUTLINE (D) | PLASTIC DIP (P) | TSSOP (PW) | |
| 0°C to 125°C | 2.45 | 2.5 | 2.55 | TPS71025D | TPS71025P | TPS71025PWLE | TPS71025Y |

The D package is available taped and reeled. Add R suffix to device type (e.g., TPS71025DR). The PW package is only available left-end taped and reeled and is indicated by the LE suffix on the device type.



Please be aware that an important notice concerning availability, standard warranty, and use in critical applications of Texas Instruments semiconductor products and disclaimers thereto appears at the end of this data sheet.

PRODUCTION DATA information is current as of publication date. Products conform to specifications per the terms of Texas Instruments standard warranty. Production processing does not necessarily include testing of all parameters.

 **TEXAS
INSTRUMENTS**

POST OFFICE BOX 655303 • DALLAS, TEXAS 75265

Copyright © 1997, Texas Instruments Incorporated

TPS71025 LOW-DROPOUT VOLTAGE REGULATOR

SLVS162A – MAY 1997 – REVISED MAY 1998

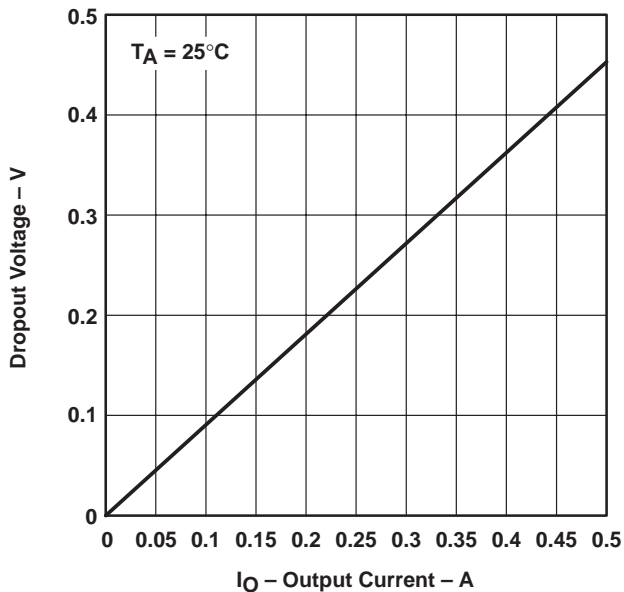
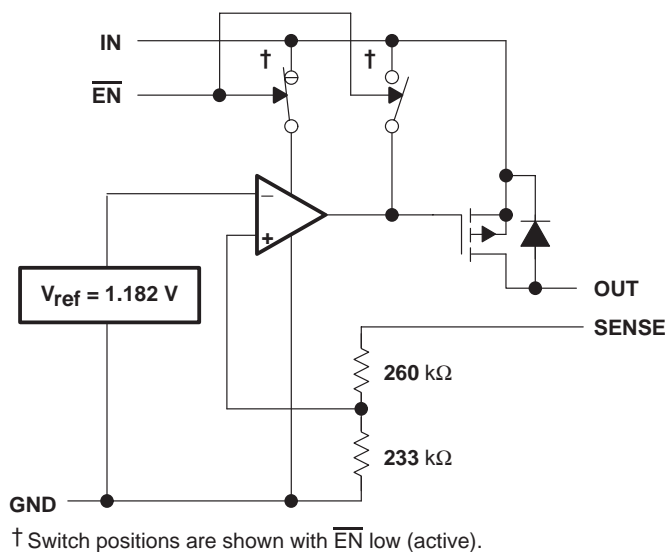

Figure 1. Dropout Voltage Versus Output Current

functional block diagram



Terminal Functions

| NAME | TERMINAL NO. | | DESCRIPTION |
|------------------------|--------------|--------|--|
| | NO. | | |
| | D or P | PW | |
| $\overline{\text{EN}}$ | 2 | 6 | Enable input. Logic low enables output |
| GND | 1 | 1–3 | Ground |
| IN | 3, 4 | 8–10 | Input supply voltage |
| OUT | 5, 6 | 13, 14 | Output voltage |
| SENSE | 7 | 15 | Output voltage sense input |

TPS71025Y chip information

These chips, when properly assembled, display characteristics similar to those of the TPS71025. Thermal compression or ultrasonic bonding may be used on the doped aluminum bonding pads. The chips may be mounted with conductive epoxy or a gold-silicon preform.

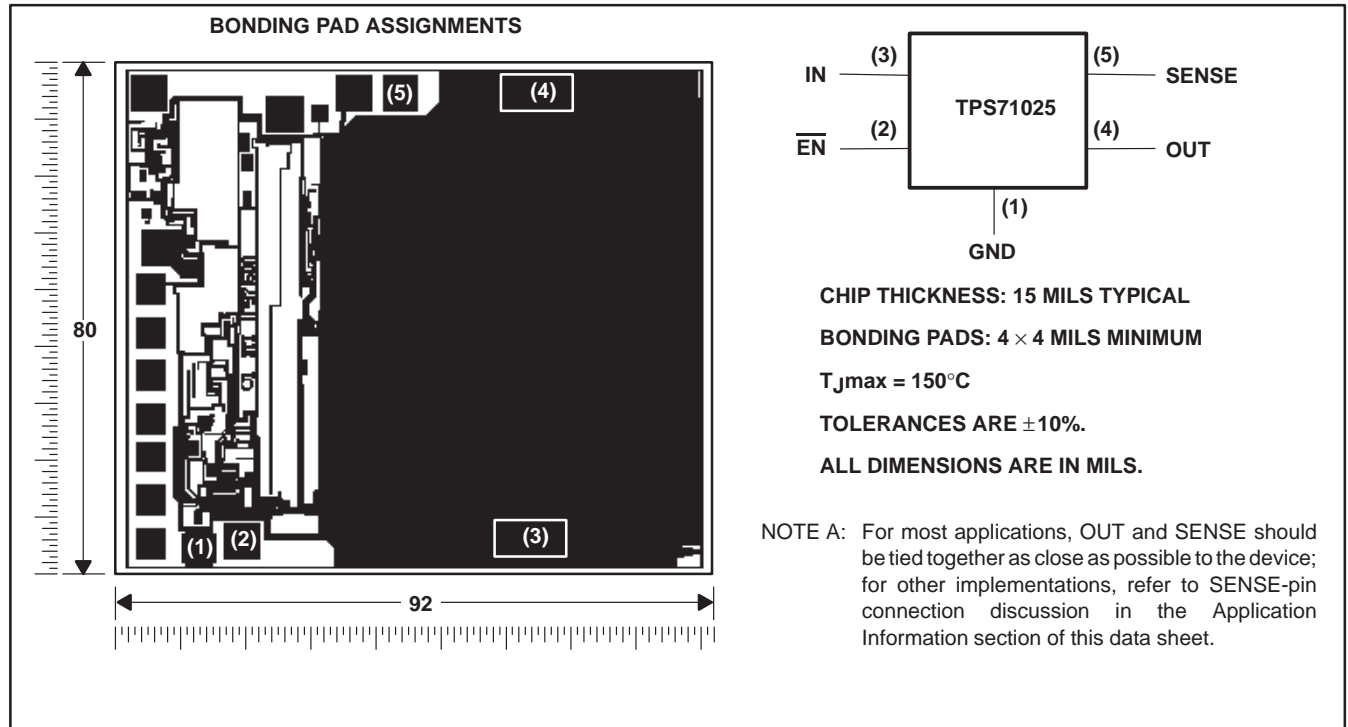

TPS71025

LOW-DROPOUT VOLTAGE REGULATOR

SLVS162A – MAY 1997 – REVISED MAY 1998

absolute maximum ratings over operating free-air temperature range (unless otherwise noted)†

| | |
|--|---------------------------------------|
| Input voltage range, V_I , \overline{EN} (see Note 1) | –0.3 V to 11 V |
| Continuous output current, I_O | 2 A |
| Continuous total power dissipation | See Dissipation Rating Tables 1 and 2 |
| Operating virtual junction temperature range, T_J | –0°C to 150°C |
| Storage temperature range, T_{stg} | –65°C to 150°C |
| Lead temperature 1,6 mm (1/16 inch) from case for 10 seconds | 260°C |

† Stresses beyond those listed under “absolute maximum ratings” may cause permanent damage to the device. These are stress ratings only, and functional operation of the device at these or any other conditions beyond those indicated under “recommended operating conditions” is not implied. Exposure to absolute-maximum-rated conditions for extended periods may affect device reliability.

NOTE 1: All voltage values are with respect to GND

DISSIPATION RATING TABLE 1 – FREE-AIR TEMPERATURE‡

| PACKAGE | $T_A \leq 25^\circ\text{C}$ POWER RATING | DERATING FACTOR ABOVE $T_A = 25^\circ\text{C}$ | $T_A = 70^\circ\text{C}$ POWER RATING | $T_A = 125^\circ\text{C}$ POWER RATING |
|---------|---|---|--|---|
| D | 725 mW | 5.8 mW/°C | 464 mW | 145 mW |
| P | 1175 mW | 9.4 mW/°C | 752 mW | 235 mW |
| PW | 700 mW | 5.6 mW/°C | 448 mW | 140 mW |

DISSIPATION RATING TABLE 2 – CASE TEMPERATURE‡

| PACKAGE | $T_C \leq 25^\circ\text{C}$ POWER RATING | DERATING FACTOR ABOVE $T_C = 25^\circ\text{C}$ | $T_C = 70^\circ\text{C}$ POWER RATING | $T_C = 125^\circ\text{C}$ POWER RATING |
|---------|---|---|--|---|
| D | 2188 mW | 17.5 mW/°C | 1400 mW | 438 mW |
| P | 2738 mW | 21.9 mW/°C | 1752 mW | 548 mW |
| PW | 4025 mW | 32.2 mW/°C | 2576 mW | 805 mW |

‡ Dissipation rating tables and figures are provided for maintenance of junction temperature at or below absolute maximum temperature of 150°C. For guidelines on maintaining junction temperature within recommended operating range, see the Thermal Information section.

recommended operating conditions

| | MIN | MAX | UNIT |
|--|------|-----|------|
| Input voltage, V_I | 2.97 | 10 | V |
| High-level input voltage at \overline{EN} , V_{IH} | 2 | | V |
| Low-level input voltage at \overline{EN} , V_{IL} | 0 | 0.5 | V |
| Output current range, I_O | 0 | 500 | mA |
| Operating virtual junction temperature range, T_J | 0 | 125 | °C |



TPS71025 LOW-DROPOUT VOLTAGE REGULATOR

SLVS162A – MAY 1997 – REVISED MAY 1998

electrical characteristics over recommended operating junction temperature range, $V_{I(IN)} = 3.5\text{ V}$, $I_O = 10\text{ mA}$, $\overline{EN} = 0\text{ V}$, $C_O = 4.7\text{ }\mu\text{F/CSR}^\dagger = 1\text{ }\Omega$, SENSE shorted to OUT (unless otherwise noted)

| PARAMETER | TEST CONDITIONS‡ | T _J | MIN | TYP | MAX | UNIT |
|--|--|--------------------------------|-------|--------------------------------|----------------------------|------|
| Output voltage | $3.5\text{ V} \leq V_I \leq 10\text{ V}$ | 25°C | 2.5 | | V | |
| | | 0°C to 125°C | 2.45 | 2.55 | | |
| Dropout voltage | $I_O = 10\text{ mA}$, $V_I = 2.45\text{ V}$ | 25°C | 5.7 | 7.5 | mV | |
| | | 0°C to 125°C | 10 | | | |
| | $I_O = 100\text{ mA}$, $V_I = 2.45\text{ V}$ | 25°C | 57 | 95 | | |
| | | 0°C to 125°C | 105 | | | |
| | $I_O = 500\text{ mA}$, $V_I = 2.45\text{ V}$ | 25°C | 330 | 450 | | |
| | | 0°C to 125°C | 500 | | | |
| Pass-element series resistance | | 25°C | 0.66 | 0.9 | Ω | |
| | | 0°C to 125°C | 1 | | | |
| Input regulation | $V_I = 3.5\text{ V to }10\text{ V}$, $50\text{ }\mu\text{A} \leq I_O \leq 500\text{ mA}$ | 25°C | 7 | 23 | mV | |
| | | 0°C to 125°C | 12.7 | 29 | | |
| Output regulation | $I_O = 5\text{ mA to }500\text{ mA}$, $3.5\text{ V} \leq V_I \leq 10\text{ V}$ | 25°C | 18 | 38 | mV | |
| | | 0°C to 125°C | 75 | | | |
| | $I_O = 50\text{ }\mu\text{A to }500\text{ mA}$, $3.5\text{ V} \leq V_I \leq 10\text{ V}$ | 25°C | 24 | 60 | mV | |
| | | 0°C to 125°C | 120 | | | |
| Ripple rejection | $f = 120\text{ Hz}$, $I_O = 50\text{ }\mu\text{A}$ | 25°C | 43 | 53 | dB | |
| | | 0°C to 125°C | 40 | | | |
| | $f = 120\text{ Hz}$, $I_O = 500\text{ mA}$ | 25°C | 39 | 51 | | |
| | | 0°C to 125°C | 36 | | | |
| Output noise-spectral density | $f = 120\text{ Hz}$ | 25°C | 2 | $\mu\text{V}/\sqrt{\text{Hz}}$ | | |
| Output noise voltage | $10\text{ Hz} \leq f \leq 100\text{ kHz}$, $\text{CSR} = 1\text{ }\Omega$ | $C_O = 4.7\text{ }\mu\text{F}$ | 25°C | 274 | μV_{rms} | |
| | | $C_O = 10\text{ }\mu\text{F}$ | 25°C | 228 | | |
| | | $C_O = 100\text{ }\mu\text{F}$ | 25°C | 159 | | |
| Quiescent current (active mode) | $\overline{EN} \leq 0.5\text{ V}$, $0\text{ mA} \leq I_O \leq 500\text{ mA}$ | 25°C | 292 | 390 | μA | |
| | | 0°C to 125°C | 540 | | | |
| Supply current (standby mode) | $\overline{EN} = V_I$, $2.7\text{ V} \leq V_I \leq 10\text{ V}$ | 25°C | 18 | 475 | nA | |
| | | 0°C to 125°C | 1900 | | | |
| Output current limit | $V_O = 0$, $V_I = 10\text{ V}$ | 25°C | 1.07 | 2 | A | |
| | | 0°C to 125°C | 2 | | | |
| Pass-element leakage current in standby mode | $\overline{EN} = V_I$, $2.7\text{ V} \leq V_I \leq 10\text{ V}$ | 25°C | 0.223 | 0.5 | μA | |
| | | 0°C to 125°C | 1 | | | |
| Output voltage temperature coefficient | | 0°C to 125°C | 61 | 75 | ppm/°C | |
| Thermal shutdown junction temperature | | | 165 | | °C | |
| Logic high input voltage (standby mode), \overline{EN} | $2.5\text{ V} \leq V_I \leq 6\text{ V}$ | 25°C | 2 | | V | |
| | $6\text{ V} \leq V_I \leq 10\text{ V}$ | 0°C to 125°C | 2.7 | | | |
| Logic low input voltage (active mode), \overline{EN} | $2.7\text{ V} \leq V_I \leq 10\text{ V}$ | 25°C | | 0.5 | V | |
| | | 0°C to 125°C | | 0.5 | | |
| Hysteresis voltage, \overline{EN} | | 0°C to 125°C | 50 | | mV | |
| Input current, \overline{EN} | $0\text{ V} \leq V_I \leq 10\text{ V}$ | 25°C | -0.5 | 0.5 | μA | |
| | | 0°C to 125°C | -0.5 | 0.5 | | |
| Input voltage, minimum for active pass element | | 25°C | 2 | 2.5 | V | |
| | | 0°C to 125°C | 2.5 | | | |

† CSR (compensation series resistance) refers to the total series resistance, including the equivalent series resistance (ESR) of the capacitor, any series resistance added externally, and PWB trace resistance to C_O .

‡ Pulse-testing techniques are used to maintain virtual junction temperature as close as possible to ambient temperature; thermal effects must be taken into account separately.



TPS71025

LOW-DROPOUT VOLTAGE REGULATOR

SLVS162A – MAY 1997 – REVISED MAY 1998

electrical characteristics at $T_J = 25^\circ\text{C}$, $V_{I(IN)} = 3.5\text{ V}$, $I_O = 10\text{ mA}$, $\overline{EN} = 0\text{ V}$, $C_O = 4.7\ \mu\text{F}/\text{CSR}^\dagger = 1\ \Omega$, SENSE shorted to OUT (unless otherwise noted)

| PARAMETER | TEST CONDITIONS‡ | TPS71025Y | | | UNIT |
|--|---|--------------------------|-------|-----|--------------------------------|
| | | MIN | TYP | MAX | |
| Output voltage | $3.5\text{ V} \leq V_I \leq 10\text{ V}$ | | 2.5 | | V |
| Dropout voltage | $I_O = 10\text{ mA}$, $V_I = 2.45\text{ V}$ | | 5.7 | | mV |
| | $I_O = 100\text{ mA}$, $V_I = 2.45\text{ V}$ | | 57 | | |
| | $I_O = 500\text{ mA}$, $V_I = 2.45\text{ V}$ | | 330 | | |
| Pass-element series resistance | | | 0.66 | | Ω |
| Input regulation | $V_I = 3.5\text{ V to } 10\text{ V}$ | | 7 | | mV |
| Output regulation | $I_O = 5\text{ mA to } 500\text{ mA}$ | | 18 | | mV |
| | $I_O = 50\ \mu\text{A to } 500\text{ mA}$ | | 24 | | mV |
| Ripple rejection | $f = 120\text{ Hz}$, $I_O = 50\ \mu\text{A}$ | | 53 | | dB |
| | $f = 120\text{ Hz}$, $I_O = 500\text{ mA}$ | | 51 | | |
| Output noise-spectral density | $f = 120\text{ Hz}$ | | 2 | | $\mu\text{V}/\sqrt{\text{Hz}}$ |
| Output noise voltage | $10\text{ Hz} \leq f \leq 100\text{ kHz}$, $\text{CSR} = 1\ \Omega$ | $C_O = 4.7\ \mu\text{F}$ | 274 | | μV_{rms} |
| | | $C_O = 10\ \mu\text{F}$ | 228 | | |
| | | $C_O = 100\ \mu\text{F}$ | 159 | | |
| Quiescent current (active mode) | $\overline{EN} = 0\text{ V}$, $0\text{ mA} \leq I_O \leq 500\text{ mA}$ | | 292 | | μA |
| Supply current (standby mode) | $\overline{EN} = V_I$, $2.7\text{ V} \leq V_I \leq 10\text{ V}$ | | 18 | | nA |
| Output current limit | $V_O = 0$, $V_I = 10\text{ V}$ | | 1.07 | | A |
| Pass-element leakage current in standby mode | $\overline{EN} = V_I$, $2.7\text{ V} \leq V_I \leq 10\text{ V}$ | | 0.223 | | μA |
| Output voltage temperature coefficient | | | 61 | | ppm/ $^\circ\text{C}$ |
| Thermal shutdown junction temperature | | | 165 | | $^\circ\text{C}$ |
| Logic high input voltage (standby mode), \overline{EN} | $2.5\text{ V} \leq V_I \leq 6\text{ V}$ | | 2 | | V |
| | $6\text{ V} \leq V_I \leq 10\text{ V}$ | | 2.7 | | |
| Logic low input voltage (active mode), \overline{EN} | $2.7\text{ V} \leq V_I \leq 10\text{ V}$ | | | 0.5 | V |
| Hysteresis voltage, \overline{EN} | | | 50 | | mV |
| Input current, \overline{EN} | $0\text{ V} \leq V_I \leq 10\text{ V}$ | | 0 | | μA |
| Input voltage, minimum for active pass element | | | 2 | | V |

† CSR (compensation series resistance) refers to the total series resistance, including the equivalent series resistance (ESR) of the capacitor, any series resistance added externally, and PWB trace resistance to C_O .

‡ Pulse-testing techniques are used to maintain virtual junction temperature as close as possible to ambient temperature; thermal effects must be taken into account separately.



TYPICAL CHARACTERISTICS

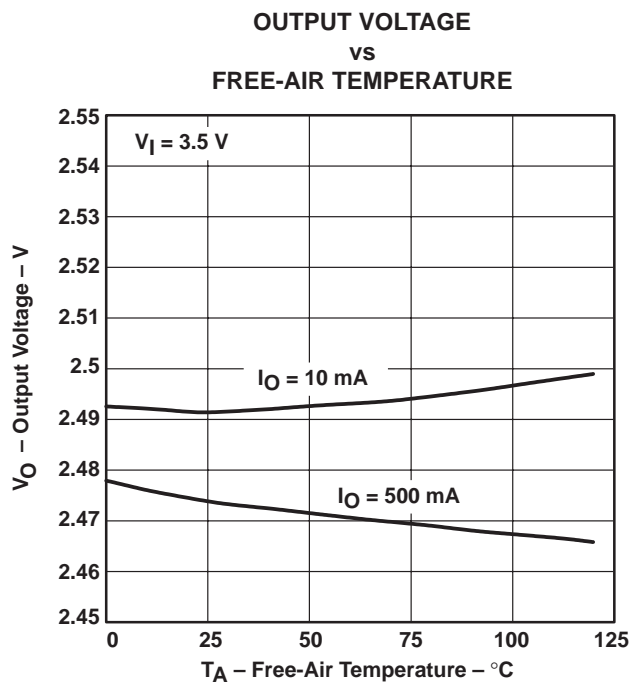

Figure 2

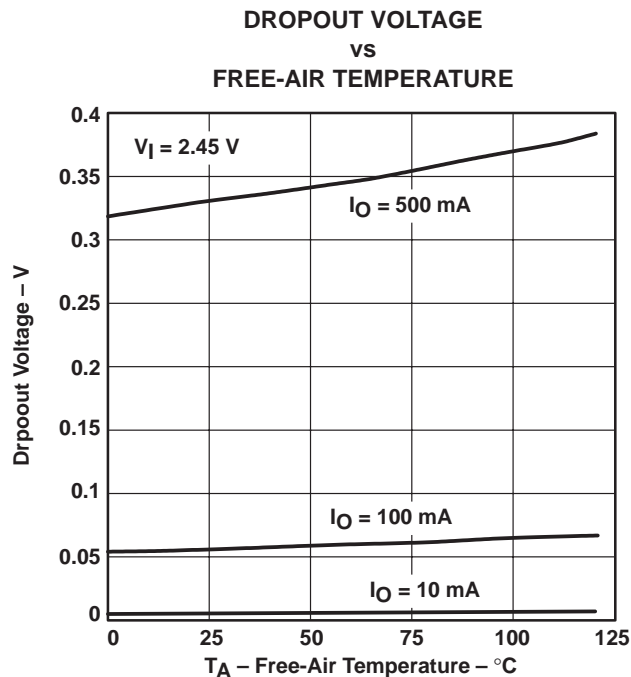

Figure 3

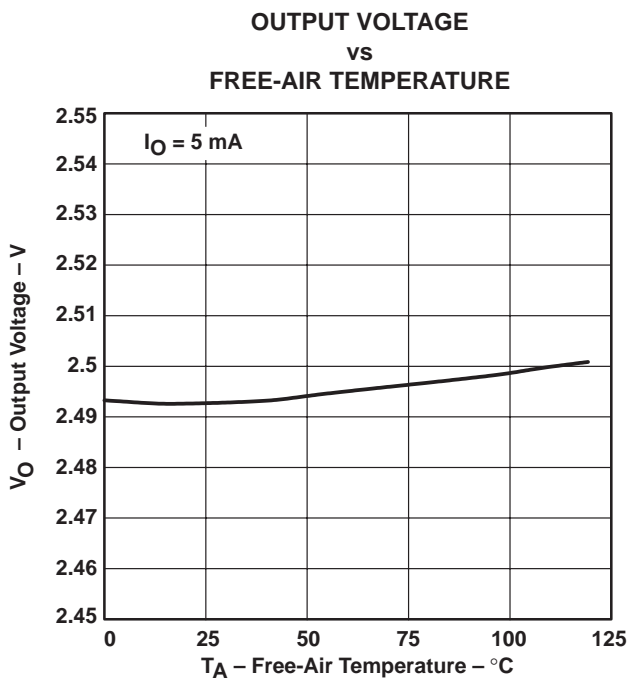

Figure 4

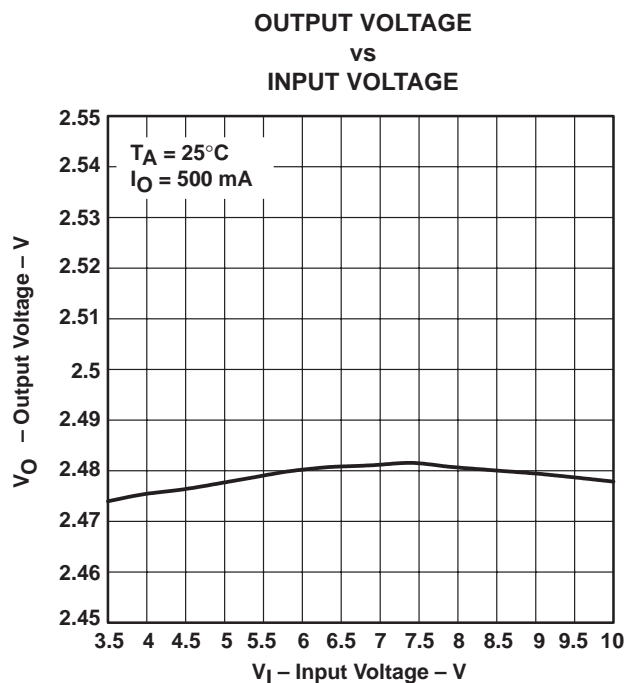

Figure 5

TPS71025 LOW-DROPOUT VOLTAGE REGULATOR

SLVS162A – MAY 1997 – REVISED MAY 1998

TYPICAL CHARACTERISTICS

OUTPUT VOLTAGE
vs
OUTPUT CURRENT

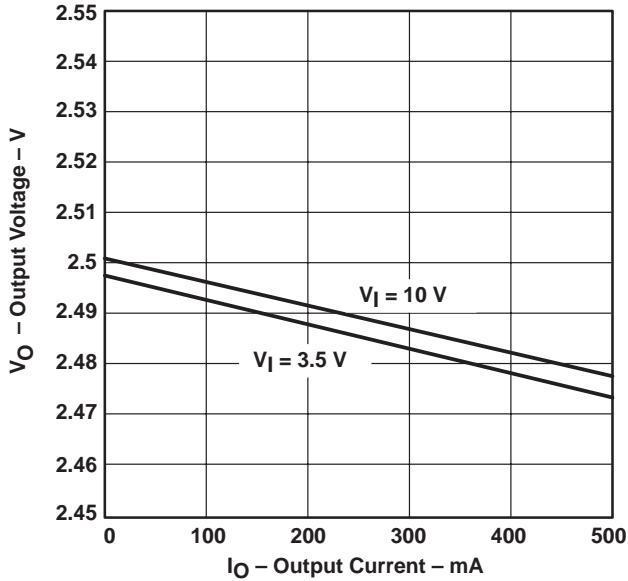

Figure 6

TYPICAL REGIONS OF STABILITY
COMPENSATION SERIES RESISTANCE
vs
OUTPUT CURRENT

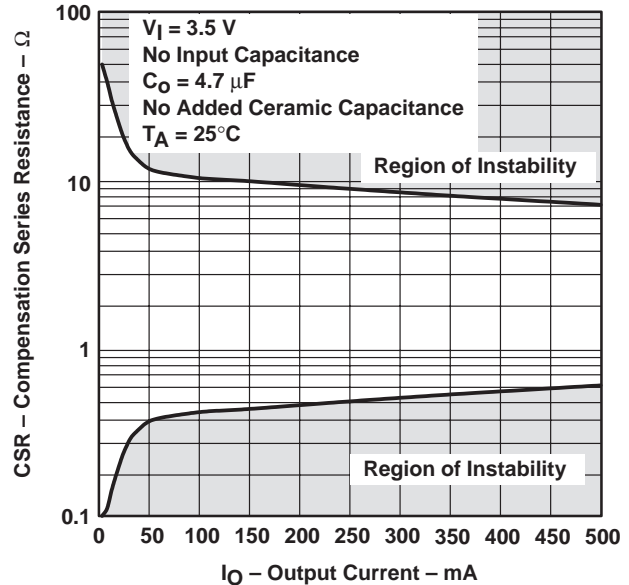

Figure 7

TYPICAL REGIONS OF STABILITY
COMPENSATION SERIES RESISTANCE
vs
OUTPUT CURRENT

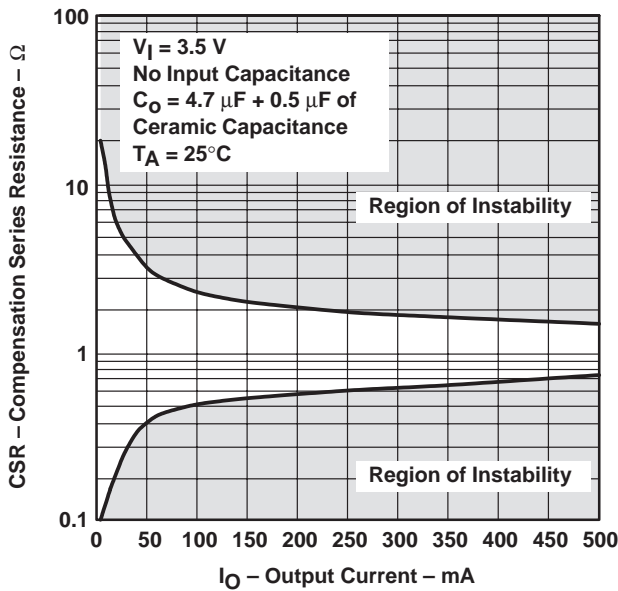

Figure 8

TYPICAL REGIONS OF STABILITY
COMPENSATION SERIES RESISTANCE
vs
ADDED CERAMIC CAPACITANCE

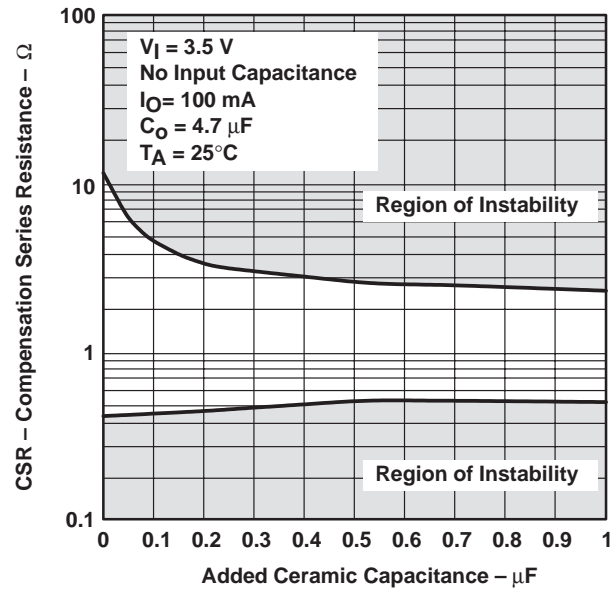

Figure 9

TYPICAL CHARACTERISTICS

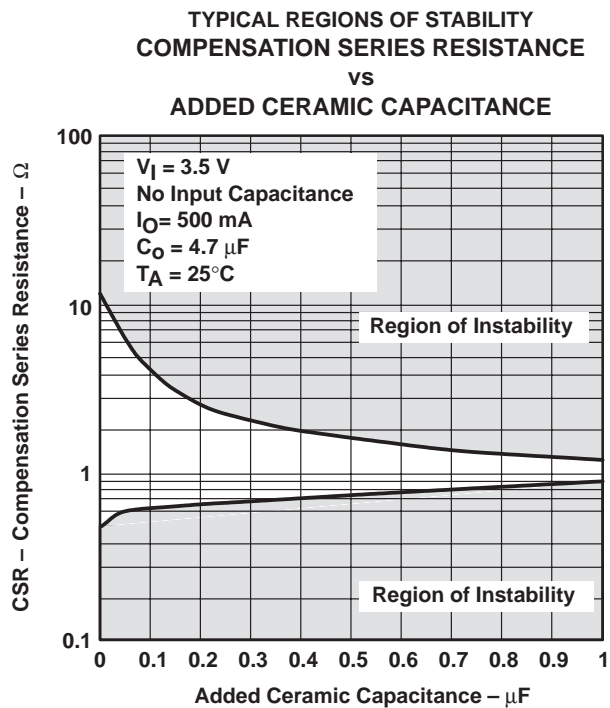

Figure 10

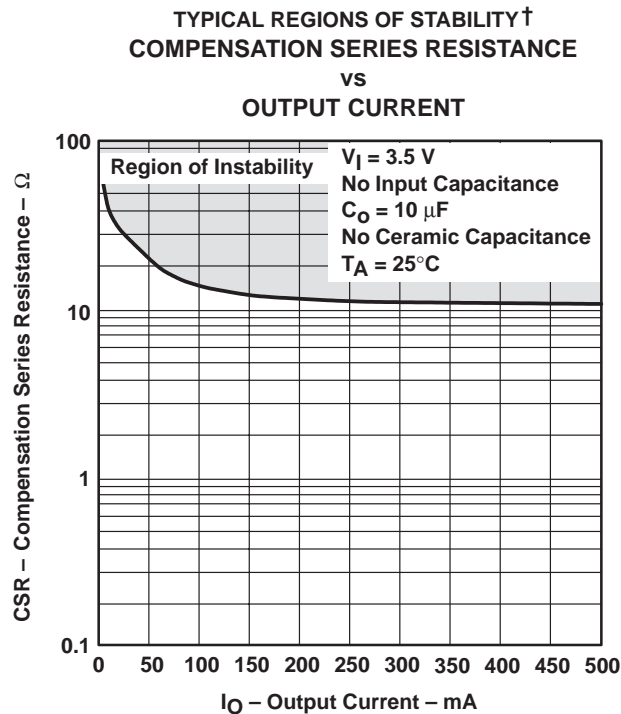

Figure 11

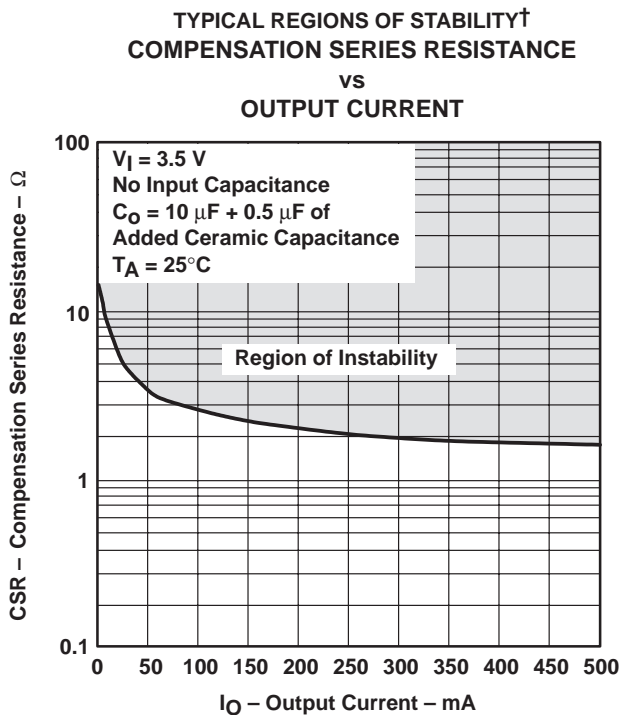

Figure 12

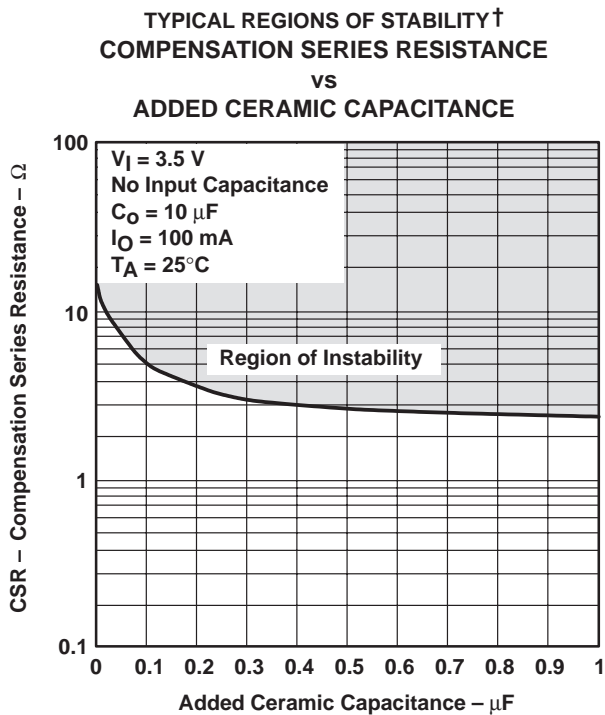

Figure 13

† CSR values below 0.1 Ω are not recommended.

TPS71025 LOW-DROPOUT VOLTAGE REGULATOR

SLVS162A – MAY 1997 – REVISED MAY 1998

TYPICAL CHARACTERISTICS

TYPICAL REGIONS OF STABILITY†
COMPENSATION SERIES RESISTANCE
vs
ADDED CERAMIC CAPACITANCE

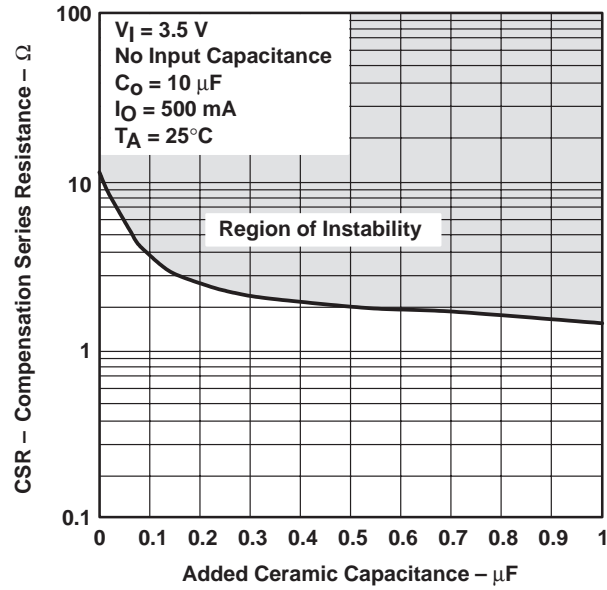

† CSR values below $0.1\ \Omega$ are not recommended.

Figure 14

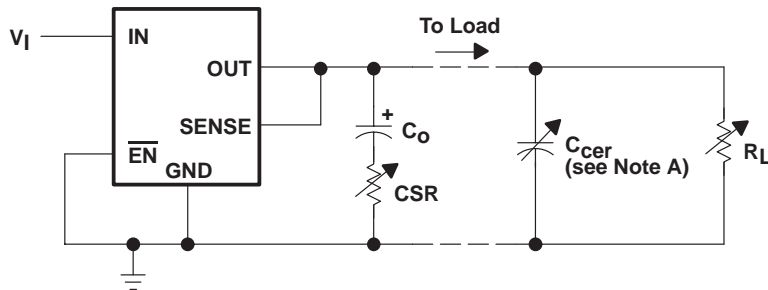

NOTE A: Ceramic capacitor

Figure 15. Test Circuit for Typical Regions of Stability (Figures 7 through 14)

THERMAL INFORMATION

In response to system-miniaturization trends, integrated circuits are being offered in low-profile and fine-pitch surface-mount packages. Implementation of many of today's high-performance devices in these packages requires special attention to power dissipation. Many system-dependent issues such as thermal coupling, airflow, added heat sinks and convection surfaces, and the presence of other heat-generating components affect the power-dissipation limits of a given component.

Three basic approaches for enhancing thermal performance are illustrated in this discussion:

- Improving the power-dissipation capability of the PWB design
- Improving the thermal coupling of the component to the PWB
- Introducing airflow in the system

Figure 16 is an example of a thermally enhanced PWB layout for the 20-lead TSSOP package. This layout involves adding copper on the PWB to conduct heat away from the device. The $R_{\theta JA}$ for this component/board system is illustrated in Figure 17. The family of curves illustrates the effect of increasing the size of the copper-heat-sink surface area. The PWB is a standard FR4 board ($L \times W \times H = 3.2 \text{ inch} \times 3.2 \text{ inch} \times 0.062 \text{ inch}$); the board traces and heat sink area are 1-oz (per square foot) copper.

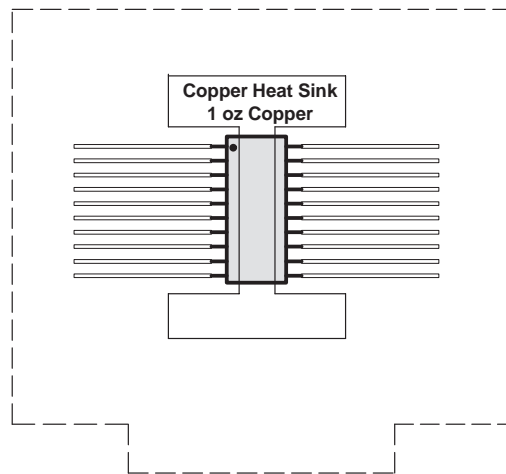

Figure 16. Thermally Enhanced PWB Layout (Not to Scale) for the 20-Pin TSSOP

Figure 18 shows the thermal resistance for the same system with the addition of a thermally conductive compound between the body of the TSSOP package and the PWB copper routed directly beneath the device. The thermal conductivity for the compound used in this analysis is $0.815 \text{ W/m} \times ^\circ\text{C}$.

TPS71025 LOW-DROPOUT VOLTAGE REGULATOR

SLVS162A – MAY 1997 – REVISED MAY 1998

THERMAL INFORMATION

THERMAL RESISTANCE, JUNCTION-TO-AMBIENT
vs
AIR FLOW

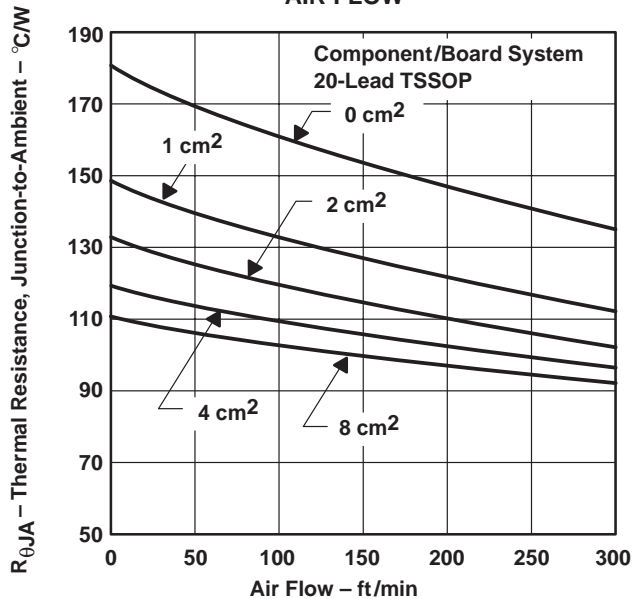

Figure 17

THERMAL RESISTANCE, JUNCTION-TO-AMBIENT
vs
AIR FLOW

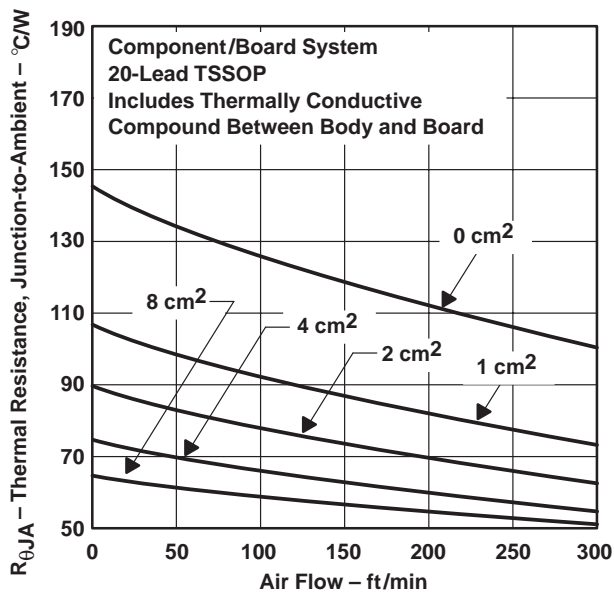

Figure 18

Using these figures to determine the system $R_{\theta JA}$ allows the maximum power-dissipation $P_{D(max)}$ limit to be calculated with the equation:

$$P_{D(max)} = \frac{T_{J(max)} - T_A}{R_{\theta JA(system)}}$$

Where

$T_{J(max)}$ is the maximum allowable junction temperature (i.e., 150°C absolute maximum or 125°C maximum recommended operating temperature for specified operation).

This limit should then be applied to the internal power dissipated by the TPS71025 regulator. The equation for calculating total internal power dissipation of the device is:

$$P_{D(total)} = (V_I - V_O) \times I_O + (V_I \times I_Q)$$

Because the quiescent current is very low, the second term is negligible, further simplifying the equation to:

$$P_{D(total)} = (V_I - V_O) \times I_O$$

THERMAL INFORMATION

For a 20-lead TSSOP/FR4 board system with thermally conductive compound between the board and the device body, where $T_A = 55^\circ\text{C}$, airflow = 100 ft/min, and copper heat sink area = 1 cm^2 , the maximum power-dissipation limit can be calculated. As indicated in Figure 18, the system $R_{\theta\text{JA}}$ is 94°C/W ; therefore, the maximum power-dissipation limit is:

$$P_{D(\text{max})} = \frac{T_{J(\text{max})} - T_A}{R_{\theta\text{JA}(\text{system})}} = \frac{125^\circ\text{C} - 55^\circ\text{C}}{94^\circ\text{C/W}} = 745\text{ mW}$$

If the system implements a TPS71025 regulator where $V_I = 3.3\text{ V}$ and $I_O = 385\text{ mA}$, the internal power dissipation is:

$$P_{D(\text{total})} = (V_I - V_O) \times I_O = (3.3 - 2.5) \times 0.385 = 308\text{ mW}$$

Comparing $P_{D(\text{total})}$ with $P_{D(\text{max})}$ reveals that the power dissipation in this example does not exceed the maximum limit. When it does, one of two corrective actions can be taken. The power-dissipation limit can be raised by increasing the airflow or the heat-sink area. Alternatively, the internal power dissipation of the regulator can be lowered by reducing the input voltage or the load current. In either case, the above calculations should be repeated with the new system parameters.

TPS71025 LOW-DROPOUT VOLTAGE REGULATOR

SLVS162A – MAY 1997 – REVISED MAY 1998

APPLICATION INFORMATION

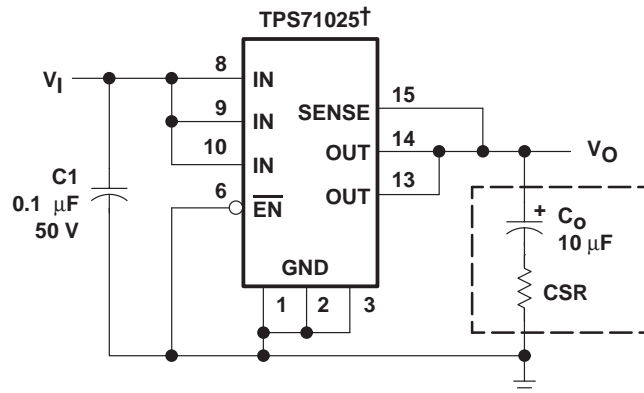

† Capacitor selection is nontrivial. See external capacitor requirements section.

Figure 19. Typical Application Circuit

The TPS71025 low-dropout (LDO) regulator overcomes many of the shortcomings of earlier-generation LDOs, while adding features such as a power-saving shutdown mode.

device operation

The TPS71025, unlike many other LDOs, features very low quiescent current that remains virtually constant even with varying loads. Conventional LDO regulators use a pnp-pass element, the base current of which is directly proportional to the load current through the regulator ($I_B = I_C/\beta$). Examination of the data sheets reveals that those devices are typically specified under near no-load conditions; actual operating currents are much higher as evidenced by typical quiescent current versus load current curves. The TPS71025 uses a PMOS transistor to pass current; because the gate of the PMOS element is voltage driven, operating currents are low and stable over the full load range. The TPS71025 specifications reflect actual performance under load.

Another pitfall associated with the pnp-pass element is its tendency to saturate when the device goes into dropout. The resulting drop in β forces an increase in I_B to maintain the load. During power up, this translates to large start-up currents. Systems with limited supply current may fail to start up. In battery-powered systems, it means rapid battery discharge when the voltage decays below the minimum required for regulation. The TPS71025 quiescent current remains low even when the regulator drops out, eliminating both problems.

The TPS71025 also features a shutdown mode that places the output in the high-impedance state (essentially equal to the feedback-divider resistance) and reduces quiescent current to under 2 μA . If the shutdown feature is not used, $\overline{\text{EN}}$ should be tied to ground. Response to an enable transition is quick; regulated output voltage is reestablished in typically 120 μs .

minimum load requirements

The TPS71025 family is stable even at zero load; no minimum load is required for operation.

SENSE-pin connection

The SENSE pin must be connected to the regulator output for proper functioning of the regulator. Normally, this connection should be as short as possible; however, the connection can be made near a critical circuit (remote sense) to improve performance at that point. Internally, SENSE connects to a high-impedance wide-bandwidth amplifier through a resistor-divider network, and noise pickup feeds through to the regulator output. Routing the SENSE connection to minimize/avoid noise pickup is essential. Adding an RC network between SENSE and OUT to filter noise is not recommended because it can cause the regulator to oscillate.



POST OFFICE BOX 655303 • DALLAS, TEXAS 75265

APPLICATION INFORMATION

external capacitor requirements

An input capacitor is not required; however, a ceramic bypass capacitor (0.047 pF to 0.1 μ F) improves load transient response and noise rejection if the TPS71025 is located more than a few inches from the power supply. A higher-capacitance electrolytic capacitor may be necessary if large (hundreds of milliamps) load transients with fast rise times are anticipated.

As with most LDO regulators, the TPS71025 requires an output capacitor for stability. A low-ESR 10- μ F solid-tantalum capacitor connected from the regulator output to ground is sufficient to ensure stability over the full load range (see Figure 11). Adding high-frequency ceramic or film capacitors (such as power-supply bypass capacitors for digital or analog ICs) can cause the regulator to become unstable unless the ESR of the tantalum capacitor is less than 1.2 Ω over temperature. Capacitors with published ESR specifications such as the AVX TPSD106K035R0300 and the Sprague 593D106X0035D2W work well because the maximum ESR at 25°C is 300 m Ω (typically, the ESR in solid-tantalum capacitors increases by a factor of 2 or less when the temperature drops from 25°C to –40°C). Where component height and/or mounting area is a problem, physically smaller, 10- μ F devices can be screened for ESR. Figure 7 through Figure 14 show the stable regions of operation using different values of output capacitance with various values of ceramic load capacitance.

In applications with little or no high-frequency bypass capacitance (< 0.2 μ F), the output capacitance can be reduced to 4.7 μ F, provided ESR is maintained between 0.7 and 2.5 Ω . Because minimum capacitor ESR is seldom if ever specified, it may be necessary to add a 0.5- Ω to 1- Ω resistor in series with the capacitor and limit ESR to 1.5 Ω maximum. As shown in the ESR graphs (Figure 7 through Figure 14), minimum ESR is not a problem when using 10- μ F or larger output capacitors.

Below is a partial listing of surface-mount capacitors usable with the TPS71025. This information (along with the ESR graphs, Figure 7 through Figure 14) is included to assist in selection of suitable capacitance for the application. When necessary to achieve low height requirements along with high output current and/or high ceramic load capacitance, several higher ESR capacitors can be used in parallel to meet the guidelines above.

TPS71025 LOW-DROPOUT VOLTAGE REGULATOR

SLVS162A – MAY 1997 – REVISED MAY 1998

APPLICATION INFORMATION

external capacitor requirements (continued)

All load and temperature conditions with up to 1 μF of added ceramic load capacitance:

| PART NO. | MFR. | VALUE | MAX ESR† | SIZE (H \times L \times W)† |
|------------------|---------|-------------------------|----------|---------------------------------|
| T421C226M010AS | Kemet | 22 μF , 10 V | 0.5 | 2.8 \times 6 \times 3.2 |
| 593D156X0025D2W | Sprague | 15 μF , 25 V | 0.3 | 2.8 \times 7.3 \times 4.3 |
| 593D106X0035D2W | Sprague | 10 μF , 35 V | 0.3 | 2.8 \times 7.3 \times 4.3 |
| TPSD106M035R0300 | AVX | 10 μF , 35 V | 0.3 | 2.8 \times 7.3 \times 4.3 |

Load < 200 mA, ceramic load capacitance < 0.2 μF , full temperature range:

| PART NO. | MFR. | VALUE | MAX ESR† | SIZE (H \times L \times W)† |
|-----------------|---------|-------------------------|----------|---------------------------------|
| 592D156X0020R2T | Sprague | 15 μF , 20 V | 1.1 | 1.2 \times 7.2 \times 6 |
| 595D156X0025C2T | Sprague | 15 μF , 25 V | 1 | 2.5 \times 7.1 \times 3.2 |
| 595D106X0025C2T | Sprague | 10 μF , 25 V | 1.2 | 2.5 \times 7.1 \times 3.2 |
| 293D226X0016D2W | Sprague | 22 μF , 16 V | 1.1 | 2.8 \times 7.3 \times 4.3 |

Load < 100 mA, ceramic load capacitance < 0.2 μF , full temperature range:

| PART NO. | MFR. | VALUE | MAX ESR† | SIZE (H \times L \times W)† |
|-----------------|---------|--------------------------|----------|---------------------------------|
| 195D106X06R3V2T | Sprague | 10 μF , 6.3 V | 1.5 | 1.3 \times 3.5 \times 2.7 |
| 195D106X0016X2T | Sprague | 10 μF , 16 V | 1.5 | 1.3 \times 7 \times 2.7 |
| 595D156X0016B2T | Sprague | 15 μF , 16 V | 1.8 | 1.6 \times 3.8 \times 2.6 |
| 695D226X0015F2T | Sprague | 22 μF , 15 V | 1.4 | 1.8 \times 6.5 \times 3.4 |
| 695D156X0020F2T | Sprague | 15 μF , 20 V | 1.5 | 1.8 \times 6.5 \times 3.4 |
| 695D106X0035G2T | Sprague | 10 μF , 35 V | 1.3 | 2.5 \times 7.6 \times 2.5 |

† Size is in mm. ESR is maximum resistance at 100 kHz and $T_A = 25^\circ\text{C}$. Listings are sorted by height.



POST OFFICE BOX 655303 • DALLAS, TEXAS 75265

TPS71025 LOW-DROPOUT VOLTAGE REGULATOR

SLVS162A – MAY 1997 – REVISED MAY 1998

MECHANICAL DATA

D (R-PDSO-G**)

PLASTIC SMALL-OUTLINE PACKAGE

14 PIN SHOWN

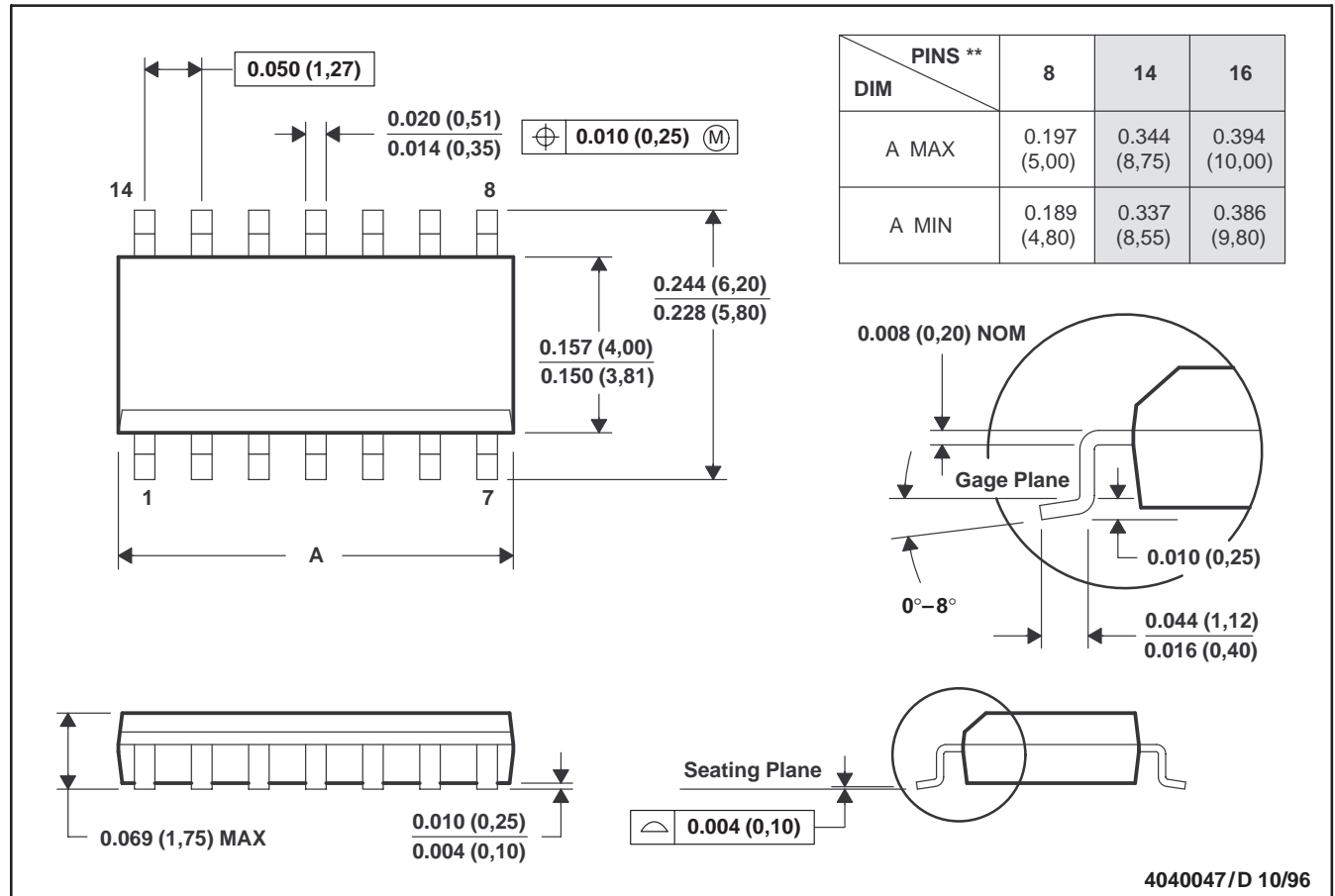

- NOTES: A. All linear dimensions are in inches (millimeters).
 B. This drawing is subject to change without notice.
 C. Body dimensions do not include mold flash or protrusion, not to exceed 0.006 (0,15).
 D. Falls within JEDEC MS-012

TPS71025 LOW-DROPOUT VOLTAGE REGULATOR

SLVS162A – MAY 1997 – REVISED MAY 1998

MECHANICAL DATA

P (R-PDIP-T8)

PLASTIC DUAL-IN-LINE PACKAGE

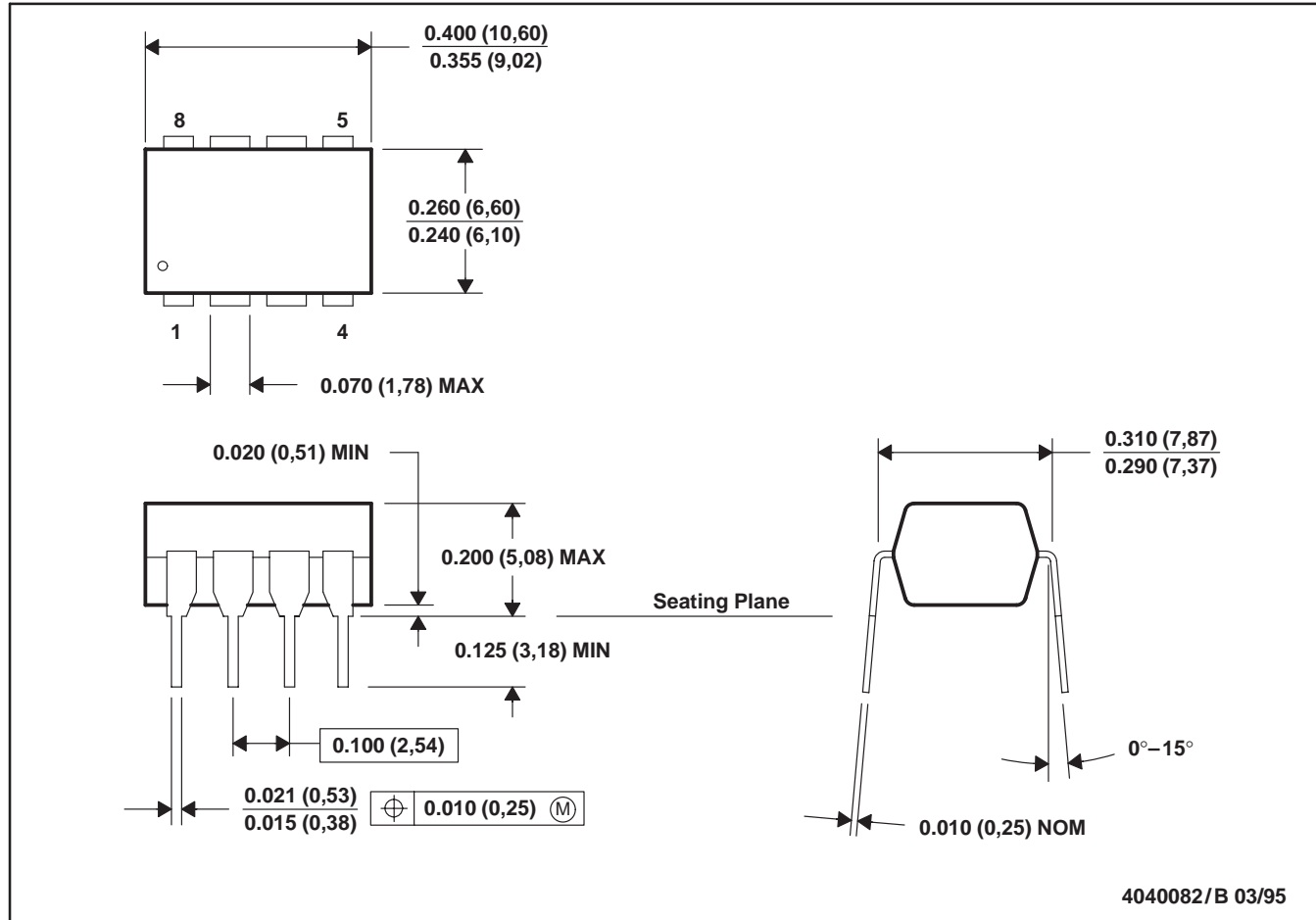

- NOTES: A. All linear dimensions are in inches (millimeters).
 B. This drawing is subject to change without notice.
 C. Falls within JEDEC MS-001

MECHANICAL DATA

PW (R-PDSO-G**)

PLASTIC SMALL-OUTLINE PACKAGE

14 PIN SHOWN

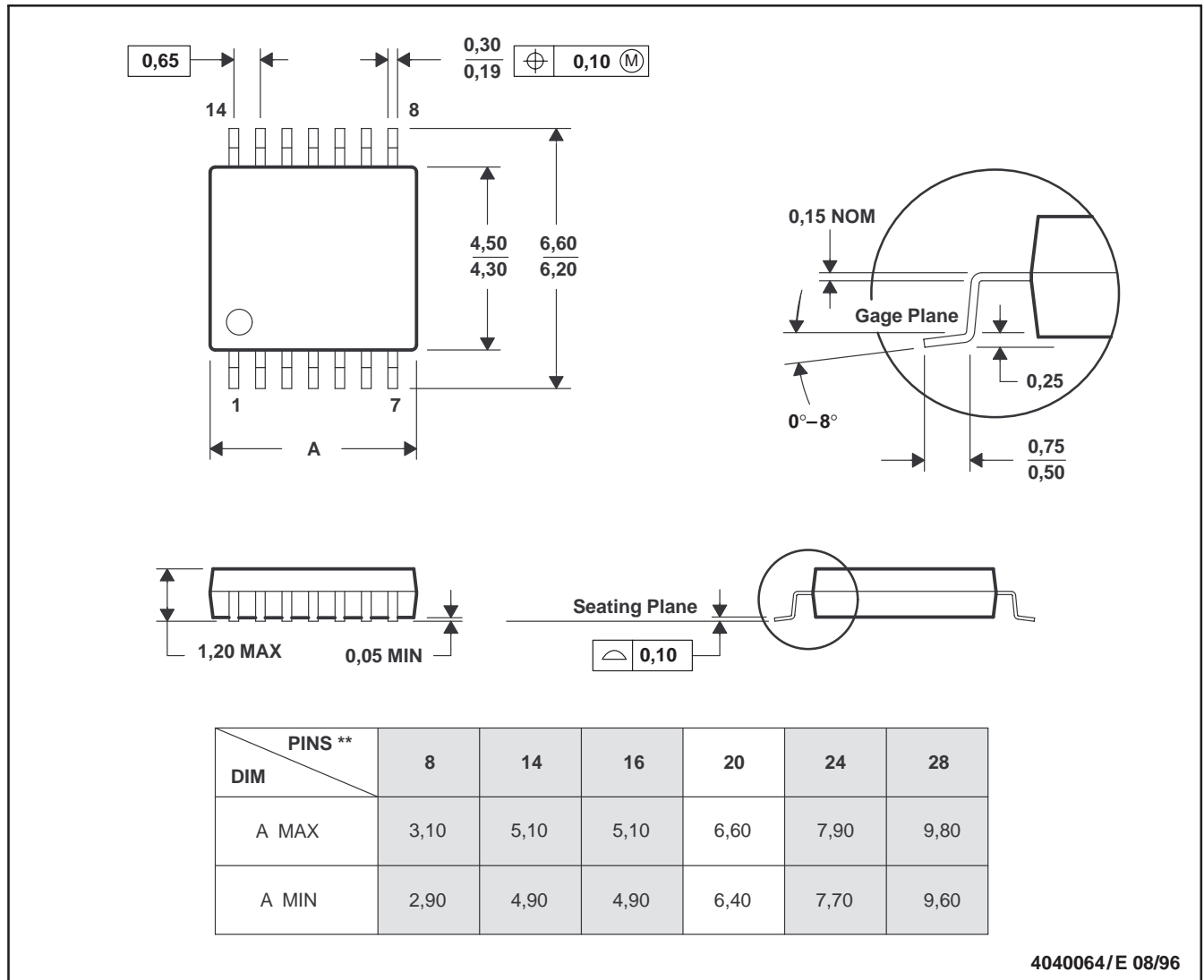

- NOTES: A. All linear dimensions are in millimeters.
 B. This drawing is subject to change without notice.
 C. Body dimensions do not include mold flash or protrusion not to exceed 0,15.
 D. Falls within JEDEC MO-153

PACKAGING INFORMATION

| Orderable Device | Status (1) | Package Type | Package Drawing | Pins | Package Qty | Eco Plan (2) | Lead finish/ Ball material (6) | MSL Peak Temp (3) | Op Temp (°C) | Device Marking (4/5) | Samples |
|------------------|---------------|--------------|-----------------|------|-------------|-----------------|--------------------------------------|----------------------|--------------|-------------------------|-------------------------|
| TPS71025D | ACTIVE | SOIC | D | 8 | 75 | RoHS & Green | NIPDAU | Level-1-260C-UNLIM | 0 to 125 | 71025 | Samples |
| TPS71025DR | ACTIVE | SOIC | D | 8 | 2500 | RoHS & Green | NIPDAU | Level-1-260C-UNLIM | 0 to 125 | 71025 | Samples |
| TPS71025P | ACTIVE | PDIP | P | 8 | 50 | RoHS & Green | NIPDAU | N / A for Pkg Type | 0 to 125 | TPS71025P | Samples |

(1) The marketing status values are defined as follows:

ACTIVE: Product device recommended for new designs.

LIFEBUY: TI has announced that the device will be discontinued, and a lifetime-buy period is in effect.

NRND: Not recommended for new designs. Device is in production to support existing customers, but TI does not recommend using this part in a new design.

PREVIEW: Device has been announced but is not in production. Samples may or may not be available.

OBSOLETE: TI has discontinued the production of the device.

(2) **RoHS:** TI defines "RoHS" to mean semiconductor products that are compliant with the current EU RoHS requirements for all 10 RoHS substances, including the requirement that RoHS substance do not exceed 0.1% by weight in homogeneous materials. Where designed to be soldered at high temperatures, "RoHS" products are suitable for use in specified lead-free processes. TI may reference these types of products as "Pb-Free".

RoHS Exempt: TI defines "RoHS Exempt" to mean products that contain lead but are compliant with EU RoHS pursuant to a specific EU RoHS exemption.

Green: TI defines "Green" to mean the content of Chlorine (Cl) and Bromine (Br) based flame retardants meet JS709B low halogen requirements of <=1000ppm threshold. Antimony trioxide based flame retardants must also meet the <=1000ppm threshold requirement.

(3) MSL, Peak Temp. - The Moisture Sensitivity Level rating according to the JEDEC industry standard classifications, and peak solder temperature.

(4) There may be additional marking, which relates to the logo, the lot trace code information, or the environmental category on the device.

(5) Multiple Device Markings will be inside parentheses. Only one Device Marking contained in parentheses and separated by a "~" will appear on a device. If a line is indented then it is a continuation of the previous line and the two combined represent the entire Device Marking for that device.

(6) Lead finish/Ball material - Orderable Devices may have multiple material finish options. Finish options are separated by a vertical ruled line. Lead finish/Ball material values may wrap to two lines if the finish value exceeds the maximum column width.

Important Information and Disclaimer:The information provided on this page represents TI's knowledge and belief as of the date that it is provided. TI bases its knowledge and belief on information provided by third parties, and makes no representation or warranty as to the accuracy of such information. Efforts are underway to better integrate information from third parties. TI has taken and continues to take reasonable steps to provide representative and accurate information but may not have conducted destructive testing or chemical analysis on incoming materials and chemicals. TI and TI suppliers consider certain information to be proprietary, and thus CAS numbers and other limited information may not be available for release.

In no event shall TI's liability arising out of such information exceed the total purchase price of the TI part(s) at issue in this document sold by TI to Customer on an annual basis.

TAPE AND REEL INFORMATION

QUADRANT ASSIGNMENTS FOR PIN 1 ORIENTATION IN TAPE



*All dimensions are nominal

| Device | Package Type | Package Drawing | Pins | SPQ | Reel Diameter (mm) | Reel Width W1 (mm) | A0 (mm) | B0 (mm) | K0 (mm) | P1 (mm) | W (mm) | Pin1 Quadrant |
|------------|--------------|-----------------|------|------|--------------------|--------------------|---------|---------|---------|---------|--------|---------------|
| TPS71025DR | SOIC | D | 8 | 2500 | 330.0 | 12.4 | 6.4 | 5.2 | 2.1 | 8.0 | 12.0 | Q1 |

TAPE AND REEL BOX DIMENSIONS

*All dimensions are nominal

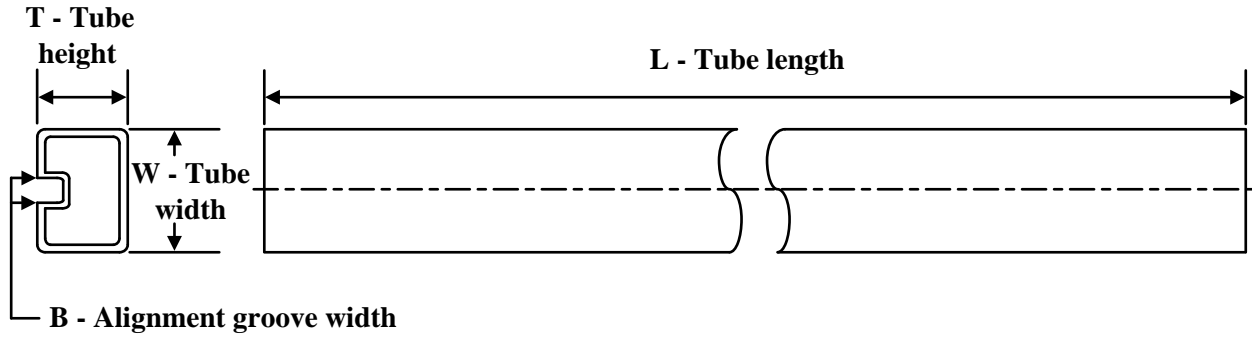
| Device | Package Type | Package Drawing | Pins | SPQ | Length (mm) | Width (mm) | Height (mm) |
|------------|--------------|-----------------|------|------|-------------|------------|-------------|
| TPS71025DR | SOIC | D | 8 | 2500 | 350.0 | 350.0 | 43.0 |

TUBE

*All dimensions are nominal

| Device | Package Name | Package Type | Pins | SPQ | L (mm) | W (mm) | T (μm) | B (mm) |
|-----------|--------------|--------------|------|-----|--------|--------|--------|--------|
| TPS71025D | D | SOIC | 8 | 75 | 505.46 | 6.76 | 3810 | 4 |
| TPS71025P | P | PDIP | 8 | 50 | 506 | 13.97 | 11230 | 4.32 |

IMPORTANT NOTICE AND DISCLAIMER

TI PROVIDES TECHNICAL AND RELIABILITY DATA (INCLUDING DATA SHEETS), DESIGN RESOURCES (INCLUDING REFERENCE DESIGNS), APPLICATION OR OTHER DESIGN ADVICE, WEB TOOLS, SAFETY INFORMATION, AND OTHER RESOURCES "AS IS" AND WITH ALL FAULTS, AND DISCLAIMS ALL WARRANTIES, EXPRESS AND IMPLIED, INCLUDING WITHOUT LIMITATION ANY IMPLIED WARRANTIES OF MERCHANTABILITY, FITNESS FOR A PARTICULAR PURPOSE OR NON-INFRINGEMENT OF THIRD PARTY INTELLECTUAL PROPERTY RIGHTS.

These resources are intended for skilled developers designing with TI products. You are solely responsible for (1) selecting the appropriate TI products for your application, (2) designing, validating and testing your application, and (3) ensuring your application meets applicable standards, and any other safety, security, regulatory or other requirements.

These resources are subject to change without notice. TI grants you permission to use these resources only for development of an application that uses the TI products described in the resource. Other reproduction and display of these resources is prohibited. No license is granted to any other TI intellectual property right or to any third party intellectual property right. TI disclaims responsibility for, and you will fully indemnify TI and its representatives against, any claims, damages, costs, losses, and liabilities arising out of your use of these resources.

TI's products are provided subject to [TI's Terms of Sale](#) or other applicable terms available either on [ti.com](https://www.ti.com) or provided in conjunction with such TI products. TI's provision of these resources does not expand or otherwise alter TI's applicable warranties or warranty disclaimers for TI products.

TI objects to and rejects any additional or different terms you may have proposed.

Mailing Address: Texas Instruments, Post Office Box 655303, Dallas, Texas 75265
Copyright © 2023, Texas Instruments Incorporated